

149

Letting June 14, 2024

Notice to Bidders, Specifications and Proposal



**Contract No. 87825
DEKALB County
Section 19-00088-02-RS
Route FAS 95 (Glidden Road)
Project LC6S-734 ()
District 3 Construction Funds**

Plans Included
Herein

Prepared by

Checked by

F

(Printed by authority of the State of Illinois)



- 1. TIME AND PLACE OF OPENING BIDS.** Electronic bids are to be submitted to the electronic bidding system (iCX-Integrated Contractors Exchange). All bids must be submitted to the iCX system prior to 12:00 p.m. June 14, 2024 at which time the bids will be publicly opened from the iCX SecureVault.
- 2. DESCRIPTION OF WORK.** The proposed improvement is identified and advertised for bids in the Invitation for Bids as:

**Contract No. 87825
DEKALB County
Section 19-00088-02-RS
Project LC6S-734 ()
Route FAS 95 (Glidden Road)
District 3 Construction Funds**

HMA resurfacing with 3-foot HMA shoulders on Glidden Road from IL 72 to IL 64.

- 3. INSTRUCTIONS TO BIDDERS.** (a) This Notice, the invitation for bids, proposal and letter of award shall, together with all other documents in accordance with Article 101.09 of the Standard Specifications for Road and Bridge Construction, become part of the contract. Bidders are cautioned to read and examine carefully all documents, to make all required inspections, and to inquire or seek explanation of the same prior to submission of a bid.

(b) State law, and, if the work is to be paid wholly or in part with Federal-aid funds, Federal law requires the bidder to make various certifications as a part of the proposal and contract. By execution and submission of the proposal, the bidder makes the certification contained therein. A false or fraudulent certification shall, in addition to all other remedies provided by law, be a breach of contract and may result in termination of the contract.
- 4. AWARD CRITERIA AND REJECTION OF BIDS.** This contract will be awarded to the lowest responsive and responsible bidder considering conformity with the terms and conditions established by the Department in the rules, Invitation for Bids and contract documents. The issuance of plans and proposal forms for bidding based upon a prequalification rating shall not be the sole determinant of responsibility. The Department reserves the right to determine responsibility at the time of award, to reject any or all proposals, to re-advertise the proposed improvement, and to waive technicalities.

By Order of the
Illinois Department of Transportation

Omer Osman,
Secretary

INDEX
FOR
SUPPLEMENTAL SPECIFICATIONS
AND RECURRING SPECIAL PROVISIONS

Adopted January 1, 2024

This index contains a listing of SUPPLEMENTAL SPECIFICATIONS, frequently used RECURRING SPECIAL PROVISIONS, and LOCAL ROADS AND STREETS RECURRING SPECIAL PROVISIONS.

ERRATA Standard Specifications for Road and Bridge Construction (Adopted 1-1-22) (Revised 1-1-24)

SUPPLEMENTAL SPECIFICATIONS

| <u>Std. Spec. Sec.</u> | <u>Page No.</u> |
|---|-----------------|
| 202 Earth and Rock Excavation | 1 |
| 204 Borrow and Furnished Excavation | 2 |
| 207 Porous Granular Embankment | 3 |
| 211 Topsoil and Compost | 4 |
| 407 Hot-Mix Asphalt Pavement (Full-Depth) | 5 |
| 420 Portland Cement Concrete Pavement | 6 |
| 502 Excavation for Structures | 7 |
| 509 Metal Railings | 8 |
| 540 Box Culverts | 9 |
| 542 Pipe Culverts | 29 |
| 586 Granular Backfill for Structures | 34 |
| 630 Steel Plate Beam Guardrail | 35 |
| 644 High Tension Cable Median Barrier | 36 |
| 665 Woven Wire Fence | 37 |
| 782 Reflectors | 38 |
| 801 Electrical Requirements | 40 |
| 821 Roadway Luminaires | 43 |
| 1003 Fine Aggregates | 44 |
| 1004 Coarse Aggregates | 45 |
| 1010 Finely Divided Minerals | 46 |
| 1020 Portland Cement Concrete | 47 |
| 1030 Hot-Mix Asphalt | 48 |
| 1061 Waterproofing Membrane System | 49 |
| 1067 Luminaire | 50 |
| 1097 Reflectors | 57 |

RECURRING SPECIAL PROVISIONS

The following RECURRING SPECIAL PROVISIONS indicated by an "X" are applicable to this contract and are included by reference:

| <u>CHECK SHEET #</u> | | <u>PAGE NO.</u> |
|----------------------|--|-----------------|
| 1 | <input checked="" type="checkbox"/> Additional State Requirements for Federal-Aid Construction Contracts | 59 |
| 2 | <input checked="" type="checkbox"/> Subletting of Contracts (Federal-Aid Contracts) | 62 |
| 3 | <input checked="" type="checkbox"/> EEO | 63 |
| 4 | <input type="checkbox"/> Specific EEO Responsibilities Non Federal-Aid Contracts | 73 |
| 5 | <input type="checkbox"/> Required Provisions - State Contracts | 78 |
| 6 | <input type="checkbox"/> Asbestos Bearing Pad Removal | 84 |
| 7 | <input type="checkbox"/> Asbestos Waterproofing Membrane and Asbestos HMA Surface Removal | 85 |
| 8 | <input type="checkbox"/> Temporary Stream Crossings and In-Stream Work Pads | 86 |
| 9 | <input type="checkbox"/> Construction Layout Stakes | 87 |
| 10 | <input type="checkbox"/> Use of Geotextile Fabric for Railroad Crossing | 90 |
| 11 | <input type="checkbox"/> Subsealing of Concrete Pavements | 92 |
| 12 | <input type="checkbox"/> Hot-Mix Asphalt Surface Correction | 96 |
| 13 | <input type="checkbox"/> Pavement and Shoulder Resurfacing | 98 |
| 14 | <input type="checkbox"/> Patching with Hot-Mix Asphalt Overlay Removal | 99 |
| 15 | <input type="checkbox"/> Polymer Concrete | 101 |
| 16 | Reserved | 103 |
| 17 | <input type="checkbox"/> Bicycle Racks | 104 |
| 18 | <input type="checkbox"/> Temporary Portable Bridge Traffic Signals | 106 |
| 19 | <input type="checkbox"/> Nighttime Inspection of Roadway Lighting | 108 |
| 20 | <input type="checkbox"/> English Substitution of Metric Bolts | 109 |
| 21 | <input type="checkbox"/> Calcium Chloride Accelerator for Portland Cement Concrete | 110 |
| 22 | <input type="checkbox"/> Quality Control of Concrete Mixtures at the Plant | 111 |
| 23 | <input type="checkbox"/> Quality Control/Quality Assurance of Concrete Mixtures | 119 |
| 24 | Reserved | 135 |
| 25 | Reserved | 136 |
| 26 | <input type="checkbox"/> Temporary Raised Pavement Markers | 137 |
| 27 | <input type="checkbox"/> Restoring Bridge Approach Pavements Using High-Density Foam | 138 |
| 28 | <input type="checkbox"/> Portland Cement Concrete Inlay or Overlay | 141 |
| 29 | <input type="checkbox"/> Portland Cement Concrete Partial Depth Hot-Mix Asphalt Patching | 145 |
| 30 | <input type="checkbox"/> Longitudinal Joint and Crack Patching | 148 |
| 31 | <input type="checkbox"/> Concrete Mix Design – Department Provided | 150 |
| 32 | <input type="checkbox"/> Station Numbers in Pavements or Overlays | 151 |

LOCAL ROADS AND STREETS RECURRING SPECIAL PROVISIONS

Table of Contents

| <u>CHECK SHEET #</u> | | <u>PAGE NO.</u> |
|----------------------|---|-----------------|
| LRS 1 | Reserved | 153 |
| LRS 2 | <input type="checkbox"/> Furnished Excavation | 154 |
| LRS 3 | <input checked="" type="checkbox"/> Work Zone Traffic Control Surveillance | 155 |
| LRS 4 | <input checked="" type="checkbox"/> Flaggers in Work Zones | 156 |
| LRS 5 | <input type="checkbox"/> Contract Claims | 157 |
| LRS 6 | <input type="checkbox"/> Bidding Requirements and Conditions for Contract Proposals | 158 |
| LRS 7 | <input type="checkbox"/> Bidding Requirements and Conditions for Material Proposals | 164 |
| LRS 8 | Reserved | 170 |
| LRS 9 | <input type="checkbox"/> Bituminous Surface Treatments | 171 |
| LRS 10 | Reserved | 175 |
| LRS 11 | <input type="checkbox"/> Employment Practices | 176 |
| LRS 12 | <input type="checkbox"/> Wages of Employees on Public Works | 178 |
| LRS 13 | <input type="checkbox"/> Selection of Labor | 180 |
| LRS 14 | <input type="checkbox"/> Paving Brick and Concrete Paver Pavements and Sidewalks | 181 |
| LRS 15 | <input type="checkbox"/> Partial Payments | 184 |
| LRS 16 | <input type="checkbox"/> Protests on Local Lettings | 185 |
| LRS 17 | <input type="checkbox"/> Substance Abuse Prevention Program | 186 |
| LRS 18 | <input type="checkbox"/> Multigrade Cold Mix Asphalt | 187 |
| LRS 19 | <input type="checkbox"/> Reflective Crack Control Treatment | 188 |

| | | | |
|----------------|----------------|--------------------------|-----------|
| Route No. | Section | Total Sheets | Sheet No. |
| FAS 95 | 19-00088-02-RS | | |
| Contract 87825 | DeKalb County | Fed. Aid Proj. LC6S(734) | |



Special Provisions

INDEX OF SPECIAL PROVISIONS

| Title | Page Number |
|--|-------------|
| LOCATION OF PROJECT | 1 |
| DESCRIPTION OF WORK..... | 1 |
| HOT-MIX ASPHALT SURFACE REMOVAL - BUTT JOINT | 1 |
| HOT-MIX ASPHALT SHOULDERS, SPECIAL | 1 |
| HOT-MIX ASPHALT BINDER COURSE, IL 19.0, N50 | 2 |
| HOT-MIX ASPHALT SURFACE COURSE, IL 9.5, MIX "C", N50 | 2 |
| AGGREGATE SHOULDER, TYPE B..... | 2 |
| TRAFFIC CONTROL AND PROTECTION, (SPECIAL)..... | 2 |
| PROSECUTION OF WORK..... | 3 |
| WORKING DAYS..... | 3 |
| LR 107-4 | 4 |
| LR 702..... | 5 |
| LR 1030-2..... | 6-7 |
| IDOT TRAINING PROGRAM GRADUATE ON-THE-JOB TRAINING | 8-9 |

BDE SPECIAL PROVISIONS

The following special provisions indicated by an "X" are applicable to this contract. An * indicates a new or revised special provision for the letting.

| <u>File Name</u> | <u>Pg.</u> | <u>Special Provision Title</u> | <u>Effective</u> | <u>Revised</u> |
|------------------|------------|--|------------------|----------------|
| 80099 | | <input type="checkbox"/> Accessible Pedestrian Signals (APS) | April 1, 2003 | Jan. 1, 2022 |
| 80274 | | <input type="checkbox"/> Aggregate Subgrade Improvement | April 1, 2012 | April 1, 2022 |
| 80192 | | <input type="checkbox"/> Automated Flagger Assistance Device | Jan. 1, 2008 | April 1, 2023 |
| 80173 | 10 | <input checked="" type="checkbox"/> Bituminous Materials Cost Adjustments | Nov. 2, 2006 | Aug. 1, 2017 |
| 80426 | | <input type="checkbox"/> Bituminous Surface Treatment with Fog Seal | Jan. 1, 2020 | Jan. 1, 2022 |
| 80241 | | <input type="checkbox"/> Bridge Demolition Debris | July 1, 2009 | |
| 50531 | | <input type="checkbox"/> Building Removal | Sept. 1, 1990 | Aug. 1, 2022 |
| 50261 | | <input type="checkbox"/> Building Removal with Asbestos Abatement | Sept. 1, 1990 | Aug. 1, 2022 |
| 80449 | 12 | <input checked="" type="checkbox"/> Cement, Type II | Aug. 1, 2023 | |
| 80384 | 13 | <input checked="" type="checkbox"/> Compensable Delay Costs | June 2, 2017 | April 1, 2019 |
| 80198 | | <input type="checkbox"/> Completion Date (via calendar days) | April 1, 2008 | |
| 80199 | | <input type="checkbox"/> Completion Date (via calendar days) Plus Working Days | April 1, 2008 | |
| 80453 | | <input type="checkbox"/> Concrete Sealer | Nov. 1, 2023 | |
| 80261 | | <input type="checkbox"/> Construction Air Quality – Diesel Retrofit | June 1, 2010 | Nov. 1, 2014 |
| 80434 | | <input type="checkbox"/> Corrugated Plastic Pipe (Culvert and Storm Sewer) | Jan. 1, 2021 | |
| 80029 | 17 | <input checked="" type="checkbox"/> Disadvantaged Business Enterprise Participation | Sept. 1, 2000 | Mar. 2, 2019 |
| 80229 | | <input type="checkbox"/> Fuel Cost Adjustment | April 1, 2009 | Aug. 1, 2017 |
| 80452 | | <input type="checkbox"/> Full Lane Sealant Waterproofing System | Nov. 1, 2023 | |
| 80447 | | <input type="checkbox"/> Grading and Shaping Ditches | Jan 1, 2023 | |
| 80433 | | <input type="checkbox"/> Green Preformed Thermoplastic Pavement Markings | Jan. 1, 2021 | Jan. 1, 2022 |
| 80443 | | <input type="checkbox"/> High Tension Cable Median Barrier Removal | April 1, 2022 | |
| 80456 | 27 | <input checked="" type="checkbox"/> Hot-Mix Asphalt | Jan. 1, 2024 | |
| 80446 | 28 | <input checked="" type="checkbox"/> Hot-Mix Asphalt – Longitudinal Joint Sealant | Nov. 1, 2022 | Aug. 1, 2023 |
| * 80438 | | <input type="checkbox"/> Illinois Works Apprenticeship Initiative – State Funded Contracts | June 2, 2021 | April 2, 2024 |
| 80045 | 30 | <input checked="" type="checkbox"/> Material Transfer Device | June 15, 1999 | Jan. 1, 2022 |
| 80450 | | <input type="checkbox"/> Mechanically Stabilized Earth Retaining Walls | Aug. 1, 2023 | |
| 80441 | 32 | <input checked="" type="checkbox"/> Performance Graded Asphalt Binder | Jan 1, 2023 | |
| 80451 | | <input type="checkbox"/> Portland Cement Concrete | Aug. 1, 2023 | |
| * 80459 | | <input type="checkbox"/> Preformed Plastic Pavement Marking | June 2, 2024 | |
| 34261 | | <input type="checkbox"/> Railroad Protective Liability Insurance | Dec. 1, 1986 | Jan. 1, 2022 |
| * 80455 | 37 | <input checked="" type="checkbox"/> Removal and Disposal of Regulated Substances | Jan. 1, 2024 | April 1, 2024 |
| 80445 | | <input type="checkbox"/> Seeding | Nov. 1, 2022 | |
| * 80457 | 39 | <input checked="" type="checkbox"/> Short Term and Temporary Pavement Markings | April 1, 2024 | April 2, 2024 |
| 80448 | 43 | <input checked="" type="checkbox"/> Source of Supply and Quality Requirements | Jan. 2, 2023 | |
| 80340 | | <input type="checkbox"/> Speed Display Trailer | April 2, 2014 | Jan. 1, 2022 |
| 80127 | | <input type="checkbox"/> Steel Cost Adjustment | April 2, 2014 | Jan. 1, 2022 |
| 80397 | 44 | <input checked="" type="checkbox"/> Subcontractor and DBE Payment Reporting | April 2, 2018 | |
| 80391 | 45 | <input checked="" type="checkbox"/> Subcontractor Mobilization Payments | Nov. 2, 2017 | April 1, 2019 |
| 80437 | 46 | <input checked="" type="checkbox"/> Submission of Payroll Records | April 1, 2021 | Nov. 2, 2023 |
| 80435 | | <input type="checkbox"/> Surface Testing of Pavements – IRI | Jan. 1, 2021 | Jan. 1, 2023 |
| 80410 | | <input type="checkbox"/> Traffic Spotters | Jan. 1, 2019 | |
| 20338 | 48 | <input checked="" type="checkbox"/> Training Special Provisions | Oct. 15, 1975 | Sept. 2, 2021 |
| 80429 | | <input type="checkbox"/> Ultra-Thin Bonded Wearing Course | April 1, 2020 | Jan. 1, 2022 |
| 80439 | 51 | <input checked="" type="checkbox"/> Vehicle and Equipment Warning Lights | Nov. 1, 2021 | Nov. 1, 2022 |
| 80302 | 52 | <input checked="" type="checkbox"/> Weekly DBE Trucking Reports | June 2, 2012 | Nov. 1, 2021 |
| 80454 | | <input type="checkbox"/> Wood Sign Support | Nov. 1, 2023 | |
| 80427 | 53 | <input checked="" type="checkbox"/> Work Zone Traffic Control Devices | Mar. 2, 2020 | |
| 80071 | 55 | <input checked="" type="checkbox"/> Working Days | Jan. 1, 2002 | |

| Route No. | Section | Total Sheets | Sheet No. |
|----------------|----------------|--------------------------|-----------|
| FAS 95 | 19-00088-02-RS | 7 | 1 |
| Contract 87825 | DeKalb County | Fed. Aid Proj. LC6S(734) | |

The following Special Provisions supplement the "Standard Specifications for Road and Bridge Construction", Adopted January 1, 2022, the latest edition of the "Manual on Uniform Traffic Control Devices for Streets and Highways", and the "Manual of Test Procedures of Materials" in effect on the date of invitation of bids and the Supplemental Specifications and Recurring Special Provisions indicated on the Check Sheet included here in which apply to and govern the construction of Sect. 19-00088-02-RS, and in case of conflict with any part, or parts, of said Specifications, the said Special Provisions shall take precedence and shall govern.

LOCATION OF PROJECT

This project is located on Glidden Road from Illinois Route 64 to Illinois Route 72, all in Mayfield and Kingston Townships in DeKalb County.

DESCRIPTION OF WORK

The work of this section shall consist of placing 3 ft paved safety shoulders, a 2 ½" lift of Hot Mix Binder Course, IL-19.0, N50, a 1 ½" lift of Asphalt Surface Course, IL-9.5, Mix "C", N50 and other incidental work on 6.5 miles of Glidden Road.

HOT-MIX ASPHALT SURFACE REMOVAL - BUTT JOINT

This work shall be done in accordance with **Section 406.08** of the Standard Specifications. The work shall consist of milling the existing pavement at various locations throughout the project.

The Butt Joints at SN 019-3049 and SN 019+3052 shall all be 1 ½" deep tapered to 0" over 50 feet.

The Butt Joints at Illinois Route 64, Illinois Route 72, and on all side roads shall be 1 ½" deep tapered to 0" over 25 feet. The Butt Joints on paved driveways shall be 1 ½" deep tapered to 0" over 4 feet.

Any and all Temporary Ramps required by the Engineer as per Article 406.08 will be considered incidental to this pay item. Method of Measurement - Only that portion of the pavement that has been milled to a minimum depth of ¼" will be measured for payment. This work, including all milling, hauling and disposal of the millings shall be paid for at the contract unit price per square yard for Hot-Mix Asphalt Surface Removal - Butt Joint.

HOT-MIX ASPHALT SHOULDERS, SPECIAL

This work shall consist of the placement of the bottom lift of a 3 ft wide hot-mix asphalt shoulder throughout the project. The bottom and first lift shall have a compacted thickness of 2.5" and shall be placed and compacted in a trench prepared by others. The trench excavation for the paved shoulder will be completed by others immediately ahead of the contractor's operations. The second and third lifts shall be placed and compacted at the same thickness and process as the mainline pavement.

The Contractor shall notify the Engineer a minimum of seven (7) calendar days prior to commencement of Hot-Mix Asphalt Shoulders, Special work to allow others time to schedule the trench excavation and preparation.

Local Quality Assurance / Quality Management QC/QA for HMA will be performed per LR1030-2.

The cost of preparing the trench for shoulder paving will not be included in the contract. Prime Coat on the base prior to placing the first lift of the asphalt shoulder will not be required and shall not be paid for by this contract. The placement of the bottom lift of asphalt shoulder (lower 2.5") shall be paid at the contract unit price per Ton for HOT-MIX ASPHALT SHOULDERS, SPECIAL. The placement of the second lift of asphalt shoulder shall be paid at the contract unit price per Ton for HOT-MIX ASPHALT BINDER COURSE, IL 19.0, N50. The placement of the top lift of asphalt shoulder shall be paid at the contract unit price per Ton for HOT-MIX ASPHALT SURFACE COURSE, IL 9.5, MIX "C", N50.

| Route No. | Section | Total Sheets | Sheet No. |
|----------------|----------------|--------------------------|-----------|
| FAS 95 | 19-00088-02-RS | 7 | 2 |
| Contract 87825 | DeKalb County | Fed. Aid Proj. LC6S(734) | |

HOT-MIX ASPHALT BINDER COURSE, IL 19.0, N50

This work shall consist of placing one 2 ½” lift of Hot-Mix Asphalt Binder Course on the existing bituminous surface.

The paved safety shoulder shall pass through entrances. Extra width may be required to provide a ramp for access and shall be considered incidental to this pay item.

Local Quality Assurance / Quality Management QC/QA for HMA will be performed per LR1030-2.

The Tack Coat shall be placed on any section of roadway no more than five days in advance of the placement of HMA.

Quantities are estimate prepared for the establishment of pay item prices and are the responsibility of the contractor to confirm prior to bidding. Quantities may be increased, decreased, or omitted to satisfactorily complete the project.

HOT-MIX ASPHALT SURFACE COURSE, IL 9.5, MIX “C”, N50

This work shall consist of placing one 1 ½” lift of Hot-Mix Asphalt Surface Course on the Hot-Mix Asphalt Binder Course.

The paved safety shoulder shall pass through entrances. Extra width may be required to provide a ramp for access and shall be considered incidental to this pay item.

Local Quality Assurance / Quality Management QC/QA for HMA will be performed per LR1030-2.

The Tack Coat shall be placed on any section of roadway no more than five days in advance of the placement of HMA.

Quantities are estimate prepared for the establishment of pay item prices and are the responsibility of the contractor to confirm prior to bidding. Quantities may be increased, decreased, or omitted to satisfactorily complete the project.

AGGREGATE SHOULDER, TYPE B

This work shall be done in accordance with **Section 481** of the Standard Specifications with the following exceptions:

The Aggregate Shoulders shall be placed along the edge of the hot mix asphalt shoulder and on field entrances to the right of way line. It shall be compacted per **Article 481.06** or to the satisfaction of the Engineer.

The Aggregate Shoulders shall be placed after the Hot-Mix Asphalt Surface Course, Mixture “C”, N50 is complete.

This work shall be paid for at the contract unit price per Ton for AGGREGATE SHOULDER, TYPE B.

TRAFFIC CONTROL AND PROTECTION, (SPECIAL)

Traffic Control shall be in accordance with the applicable sections of the Standard Specifications for Road and Bridge Construction, the applicable guidelines contained in the manual on Uniform Traffic Control Devices for Streets and Highways, these Special Provisions, and any special details and Highway Standards contained herein and in the plans.

Standards 701201, 701301, 701306, 701311, 701901, 780001.

The entire section shall remain open to a minimum of one lane traffic during construction. Work shall be performed between sunrise and sunset only. After hours of operation each day, the contractor shall open both lanes to overnight traffic.

All signs shall conform to the following:

- Bump, Low Shoulder, and Road Construction Ahead signs shall be 48” x 48” black on fluorescent orange.
- Supplemental black on fluorescent orange 21” x 15”, left/right arrow shall be installed below the W20-1103 sign.
- Signs in place longer than 14 days shall be post mounted.
- Completed BSPE 725, Traffic Control Authorization, form will be required to be submitted prior to work operations.

| Route No. | Section | Total Sheets | Sheet No. |
|----------------|----------------|--------------------------|-----------|
| FAS 95 | 19-00088-02-RS | 7 | 3 |
| Contract 87825 | DeKalb County | Fed. Aid Proj. LC6S(734) | |

The presence of temporary traffic control drawings or standards in the project plans, whether a pay item or not, does not relieve the contractor of his obligation to the public, in accordance with **Article 107.14** of the Standard Specifications for Road and Bridge Construction. The contractor shall provide, to the satisfaction of the Engineer, all protection deemed necessary beyond that shown in the plans or Special Provisions.

“ROAD CONSTRUCTION AHEAD” signs shall be installed per the applicable standards and shall be installed prior to the coring for the safety shoulder.

“BUMP” signs shall be installed as directed by the Engineer.

“LOW SHOULDER” signs shall be installed at 2-mile intervals or as directed by the Engineer prior to the coring for the safety shoulder.

Flaggers shall comply with all requirements contained in the Department’s “Flagger Handbook” with the following exception: The ANSI Class 2 vest will not be supplied by the Department.

The cost of any and all traffic control required by these special provisions and the standards included in this proposal shall be paid for per Lump Sum for TRAFFIC CONTROL & PROTECTION, (SPECIAL).

PROSECUTION OF WORK

The Contractor shall notify the Engineer a minimum of two (2) working days (i.e. notice given on Thursday A.M. for work to begin the following Monday) prior to commencement of any work which would be considered as a pay item in the contract, except for the seven (7) calendar day requirement prior to the Hot-Mix Asphalt Shoulders, Special work as described above. No payment will be made to the Contractor for any pay item work performed without the aforementioned notice being given unless otherwise approved by the Engineer. Work shall be performed between sunrise and sunset only.

WORKING DAYS

All contract work including punch list items shall be completed within 30 Working Days. Failure to complete the work by the completion date will result in liquidated damages being assessed in accordance with **Article 108.09** of the Standard Specifications.

State of Illinois
Department of Transportation
Bureau of Local Roads and Streets

SPECIAL PROVISION
FOR
INSURANCE

Effective: February 1, 2007
Revised: August 1, 2007

All references to Sections or Articles in this specification shall be construed to mean specific Section or Article of the Standard Specifications for Road and Bridge Construction, adopted by the Department of Transportation.

The Contractor shall name the following entities as additional insured under the Contractor's general liability insurance policy in accordance with Article 107.27:

DeKalb County

The entities listed above and their officers, employees, and agents shall be indemnified and held harmless in accordance with Article 107.26.

State of Illinois
Department of Transportation
Bureau of Local Roads and Streets
SPECIAL PROVISION
FOR
CONSTRUCTION AND MAINTENANCE SIGNS

Effective: January 1, 2004
Revised: June 1, 2007

All references to Sections or Articles in this specification shall be construed to mean a specific Section or Article of the Standard Specifications for Road and Bridge Construction, adopted by the Department of Transportation.

701.14. Signs. Add the following paragraph to Article 701.14:

All warning signs shall have minimum dimensions of 1200 mm x 1200 mm (48" x 48") and have a black legend on a fluorescent orange reflectorized background, meeting, as a minimum, Type AP reflectivity requirements of Table 1091-2 in Article 1091.02.

State of Illinois
 DEPARTMENT OF TRANSPORTATION
 Bureau of Local Roads & Streets
 SPECIAL PROVISION
 FOR
 LOCAL QUALITY ASSURANCE/ QUALITY MANAGEMENT QC/QA
 Effective: January 1, 2022

Replace the first five paragraphs of Article 1030.06 of the Standard Specifications with the following:

“1030.06 Quality Management Program. The Quality Management Program (QMP) will be Quality Control / Quality Assurance (QC/QA) according to the following.”

Delete Article 1030.06(d)(1) of the Standard Specifications.

Revise Article 1030.09(g)(3) of the Standard Specifications to read:

“(3) If core testing is the density verification method, the Contractor shall provide personnel and equipment to collect density verification cores for the Engineer. Core locations will be determined by the Engineer following the document “Hot-Mix Asphalt QC/QA Procedure for Determining Random Density Locations” at density verification intervals defined in Article 1030.09(b). After the Engineer identifies a density verification location and prior to opening to traffic, the Contractor shall cut a 4 in. (100 mm) diameter core. With the approval of the Engineer, the cores may be cut at a later time.”

Revise Article 1030.09(h)(2) of the Standard Specifications to read:

“(2) After final rolling and prior to paving subsequent lifts, the Engineer will identify the random density verification test locations. Cores or nuclear density gauge testing will be used for density verification. The method used for density verification will be as selected below.

| Density Verification Method | |
|-------------------------------------|---|
| <input checked="" type="checkbox"/> | Cores |
| <input type="checkbox"/> | Nuclear Density Gauge (Correlated when paving ≥ 3,000 tons per mixture) |

Density verification test locations will be determined according to the document “Hot-Mix Asphalt QC/QA Procedure for Determining Random Density Locations”. The density testing interval for paving wider than or equal to 3 ft (1 m) will be 0.5 miles (800 m) for lift thicknesses of 3 in. (75 mm) or less and 0.2 miles (320 m) for lift thicknesses greater than 3 in. (75 mm). The density testing interval for paving less than 3 ft (1 m) wide will be 1 mile (1,600 m). If a day’s paving will be less than the prescribed density testing interval, the length of the day’s paving will be the interval for that day. The density testing interval for mixtures used for patching will be 50 patches with a minimum of one test per mixture per project.

If core testing is the density verification method, the Engineer will witness the Contractor coring, and secure and take possession of all density samples at the

density verification locations. The Engineer will test the cores collected by the Contractor for density according to Illinois Modified AASHTO T 166 or AASHTO T 275.

If nuclear density gauge testing is the density verification method, the Engineer will conduct nuclear density gauge tests. The Engineer will follow the density testing procedure detailed in the document "Illinois Modified ASTM D 2950, Standard Test Method for Density of Bituminous Concrete In-Place by Nuclear Method".

A density verification test will be the result of a single core or the average of the nuclear density tests at one location. The results of each density test must be within acceptable limits. The Engineer will promptly notify the Contractor of observed deficiencies."

Revise the seventh paragraph and all subsequent paragraphs in Section D. of the document "Hot-Mix Asphalt QC/QA Initial Daily Plant and Random Samples" to read:

"Mixtures shall be sampled from the truck at the plant by the Contractor following the same procedure used to collect QC mixture samples (Section A). This process will be witnessed by the Engineer who will take custody of the verification sample. Each sample bag with a verification mixture sample will be secured by the Engineer using a locking ID tag. Sample boxes containing the verification mixture sample will be sealed/taped by the Engineer using a security ID label."

IDOT TRAINING PROGRAM GRADUATE ON-THE-JOB TRAINING SPECIAL PROVISION

Effective: August 1, 2012 Revised: February 2, 2017

In addition to the Contractor's equal employment opportunity (EEO) affirmative action efforts undertaken as required by this Contract, the Contractor is encouraged to participate in the incentive program described below to provide additional on-the-job training to certified graduates of the IDOT pre-apprenticeship training program, as outlined in this Special Provision.

IDOT funds, and various Illinois community colleges operate, pre-apprenticeship training programs throughout the State to provide training and skill-improvement opportunities to promote the increased employment of minority groups, disadvantaged persons and women in all aspects of the highway construction industry. The intent of this IDOT Pre-Apprenticeship Training Program Graduate (TPG) special provision (Special Provision) is to place these certified program graduates on the project site for this Contract in order to provide the graduates with meaningful on-the-job training. Pursuant to this Special Provision, the Contractor must make every reasonable effort to recruit and employ certified TPG trainees to the extent such individuals are available within a practicable distance of the project site.

Specifically, participation of the Contractor or its subcontractor in the Program entitles the participant to reimbursement for graduates' hourly wages at \$15.00 per hour per utilized TPG trainee, subject to the terms of this Special Provision. Reimbursement payment will be made even though the Contractor or subcontractor may also receive additional training program funds from other non-IDOT sources for other non-TPG trainees on the Contract, provided such other source does not specifically prohibit the Contractor or subcontractor from receiving reimbursement from another entity through another program, such as IDOT through the TPG program. With regard to any IDOT funded construction training program other than TPG, however, additional reimbursement for other IDOT programs will not be made beyond the TPG Program described in this Special Provision when the TPG Program is utilized.

No payment will be made to the Contractor if the Contractor or subcontractor fails to provide the required on-site training to TPG trainees, as solely determined by IDOT. A TPG trainee must begin training on the project as soon as the start of work that utilizes the relevant trade skill and the TPG trainee must remain on the project site through completion of the Contract, so long as training opportunities continue to exist in the relevant work classification. Should a TPG trainee's employment end in advance of the completion of the Contract, the Contractor must promptly notify the IDOT District EEO Officer for the Contract that the TPG's involvement in the Contract has ended. The Contractor must supply a written report for the reason the TPG trainee involvement terminated, the hours completed by the TPG trainee on the Contract, and the number of hours for which the incentive payment provided under this Special Provision will be, or has been claimed for the separated TPG trainee.

Finally, the Contractor must maintain all records it creates as a result of participation in the Program on the Contract, and furnish periodic written reports to the IDOT District EEO Officer that document its contractual performance under and compliance with this Special Provision. Finally, through participation in the Program and reimbursement of wages, the Contractor is not relieved of, and IDOT has not waived, the requirements of any federal or state labor or employment law applicable to TPG workers, including compliance with the Illinois Prevailing Wage Act.

METHOD OF MEASUREMENT: The unit of measurement is in hours.

BASIS OF PAYMENT: This work will be paid for at the contract unit price of \$15.00 per hour for each utilized certified TPG Program trainee (TRAINEES TRAINING PROGRAM GRADUATE). The estimated total number of hours, unit price, and total price must be included in the schedule of prices for the Contract submitted by Contractor prior to beginning work. The initial number of TPG trainees for which the incentive is available for this contract is 2.

The Department has contracted with several educational institutions to provide screening, tutoring and pre-training to individuals interested in working as a TPG trainee in various areas of common construction trade work. Only individuals who have successfully completed a Pre-Apprenticeship Training Program at these IDOT approved institutions are eligible to be TPG trainees. To obtain a list of institutions that can connect the Contractor with eligible TPG trainees, the Contractor may contact: HCCTP TPG Program Coordinator, Office of Business and Workforce Diversity (IDOT OBWD), Room 319, Illinois Department of Transportation, 2300 S. Dirksen Parkway, Springfield, Illinois 62764. Prior to commencing construction with the utilization of a TPG trainee, the Contractor must submit documentation to the IDOT District EEO Officer for the Contract that provides the names and contact information of the TPG trainee(s) to be trained in each selected work classification, proof that that the TPG trainee(s) has successfully completed a Pre-Apprenticeship Training Program, proof that the TPG is in an Apprenticeship Training Program approved by the U.S. Department of Labor Bureau of Apprenticeship Training, and the start date for training in each of the applicable work classifications.

To receive payment, the Contractor must provide training opportunities aimed at developing a full journeyworker in the type of trade or job classification involved. During the course of performance of the Contract, the Contractor may seek approval from the IDOT District EEO Officer to employ additional eligible TPG trainees. In the event the Contractor subcontracts a portion of the contracted work, it must determine how many, if any, of the TPGs will be trained by the subcontractor. Though a subcontractor may conduct training, the Contractor retains the responsibility for meeting all requirements imposed by this Special Provision. The Contractor must also include this Special Provision in any subcontract where payment for contracted work performed by a TPG trainee will be passed on to a subcontractor.

Training through the Program is intended to move TPGs toward journeyman status, which is the primary objective of this Special Provision. Accordingly, the Contractor must make every effort to enroll TPG trainees by recruitment through the Program participant educational institutions to the extent eligible TPGs are available within a reasonable geographic area of the project. The Contractor is responsible for demonstrating, through documentation, the recruitment efforts it has undertaken prior to the determination by IDOT whether the Contractor is in compliance with this Special Provision, and therefore, entitled to the Training Program Graduate reimbursement of \$15.00 per hour.

Notwithstanding the on-the-job training requirement of this TPG Special Provision, some minimal off-site training is permissible as long as the offsite training is an integral part of the work of the contract, and does not compromise or conflict with the required on-site training that is central to the purpose of the Program. No individual may be employed as a TPG trainee in any work classification in which he/she has previously successfully completed a training program leading to journeyman status in any trade, or in which he/she has worked at a journeyman level or higher.

BITUMINOUS MATERIALS COST ADJUSTMENTS (BDE)

Effective: November 2, 2006

Revised: August 1, 2017

Description. Bituminous material cost adjustments will be made to provide additional compensation to the Contractor, or credit to the Department, for fluctuations in the cost of bituminous materials when optioned by the Contractor. The bidder shall indicate with their bid whether or not this special provision will be part of the contract.

The adjustments shall apply to permanent and temporary hot-mix asphalt (HMA) mixtures, bituminous surface treatments (cover and seal coats), and preventative maintenance type surface treatments that are part of the original proposed construction, or added as extra work and paid for by agreed unit prices. The adjustments shall not apply to bituminous prime coats, tack coats, crack filling/sealing, joint filling/sealing, or extra work paid for at a lump sum price or by force account.

Method of Adjustment. Bituminous materials cost adjustments will be computed as follows.

$$CA = (BPI_P - BPI_L) \times (\%AC_V / 100) \times Q$$

- Where: CA = Cost Adjustment, \$.
- BPI_P = Bituminous Price Index, as published by the Department for the month the work is performed, \$/ton (\$/metric ton).
- BPI_L = Bituminous Price Index, as published by the Department for the month prior to the letting for work paid for at the contract price; or for the month the agreed unit price letter is submitted by the Contractor for extra work paid for by agreed unit price, \$/ton (\$/metric ton).
- %AC_V = Percent of virgin Asphalt Cement in the Quantity being adjusted. For HMA mixtures, the % AC_V will be determined from the adjusted job mix formula. For bituminous materials applied, a performance graded or cutback asphalt will be considered to be 100% AC_V and undiluted emulsified asphalt will be considered to be 65% AC_V.
- Q = Authorized construction Quantity, tons (metric tons) (see below).

For HMA mixtures measured in square yards: $Q, \text{ tons} = A \times D \times (G_{mb} \times 46.8) / 2000$. For HMA mixtures measured in square meters: $Q, \text{ metric tons} = A \times D \times (G_{mb} \times 1) / 1000$. When computing adjustments for full-depth HMA pavement, separate calculations will be made for the binder and surface courses to account for their different G_{mb} and % AC_V.

For bituminous materials measured in gallons: $Q, \text{ tons} = V \times 8.33 \text{ lb/gal} \times SG / 2000$
For bituminous materials measured in liters: $Q, \text{ metric tons} = V \times 1.0 \text{ kg/L} \times SG / 1000$

- Where: A = Area of the HMA mixture, sq yd (sq m).
D = Depth of the HMA mixture, in. (mm).
G_{mb} = Average bulk specific gravity of the mixture, from the approved mix design.

V = Volume of the bituminous material, gal (L).
SG = Specific Gravity of bituminous material as shown on the bill of lading.

Basis of Payment. Bituminous materials cost adjustments may be positive or negative but will only be made when there is a difference between the BPI_L and BPI_P in excess of five percent, as calculated by:

$$\text{Percent Difference} = \{(BPI_L - BPI_P) \div BPI_L\} \times 100$$

Bituminous materials cost adjustments will be calculated for each calendar month in which applicable bituminous material is placed; and will be paid or deducted when all other contract requirements for the work placed during the month are satisfied. The adjustments shall not apply during contract time subject to liquidated damages for completion of the entire contract.

80173

CEMENT, TYPE IL (BDE)

Effective: August 1, 2023

Add the following to Article 302.02 of the Standard Specifications:

“(k) Type IL Portland-Limestone Cement1001”

Revise Note 2 of Article 352.02 of the Standard Specifications to read:

“Note 2. Either Type I or Type IA portland cement or Type IL portland-limestone cement shall be used.”

Revise Note 1 of Article 404.02 of the Standard Specifications to read:

“Note 1. The cement shall be Type I portland cement or Type IL portland-limestone cement.”

Revise Article 1019.02(a) of the Standard Specifications to read:

“(a) Cement, Type I or IL1001”

80449

COMPENSABLE DELAY COSTS (BDE)

Effective: June 2, 2017

Revised: April 1, 2019

Revise Article 107.40(b) of the Standard Specifications to read:

“(b) Compensation. Compensation will not be allowed for delays, inconveniences, or damages sustained by the Contractor from conflicts with facilities not meeting the above definition; or if a conflict with a utility in an unanticipated location does not cause a shutdown of the work or a documentable reduction in the rate of progress exceeding the limits set herein. The provisions of Article 104.03 notwithstanding, compensation for delays caused by a utility in an unanticipated location will be paid according to the provisions of this Article governing minor and major delays or reduced rate of production which are defined as follows.

- (1) Minor Delay. A minor delay occurs when the work in conflict with the utility in an unanticipated location is completely stopped for more than two hours, but not to exceed two weeks.
- (2) Major Delay. A major delay occurs when the work in conflict with the utility in an unanticipated location is completely stopped for more than two weeks.
- (3) Reduced Rate of Production Delay. A reduced rate of production delay occurs when the rate of production on the work in conflict with the utility in an unanticipated location decreases by more than 25 percent and lasts longer than seven calendar days.”

Revise Article 107.40(c) of the Standard Specifications to read:

“(c) Payment. Payment for Minor, Major, and Reduced Rate of Production Delays will be made as follows.

- (1) Minor Delay. Labor idled which cannot be used on other work will be paid for according to Article 109.04(b)(1) and (2) for the time between start of the delay and the minimum remaining hours in the work shift required by the prevailing practice in the area.

Equipment idled which cannot be used on other work, and which is authorized to standby on the project site by the Engineer, will be paid for according to Article 109.04(b)(4).

- (2) Major Delay. Labor will be the same as for a minor delay.

Equipment will be the same as for a minor delay, except Contractor-owned equipment will be limited to two weeks plus the cost of move-out to either the

Contractor's yard or another job and the cost to re-mobilize, whichever is less. Rental equipment may be paid for longer than two weeks provided the Contractor presents adequate support to the Department (including lease agreement) to show retaining equipment on the job is the most economical course to follow and in the public interest.

- (3) Reduced Rate of Production Delay. The Contractor will be compensated for the reduced productivity for labor and equipment time in excess of the 25 percent threshold for that portion of the delay in excess of seven calendar days. Determination of compensation will be in accordance with Article 104.02, except labor and material additives will not be permitted.

Payment for escalated material costs, escalated labor costs, extended project overhead, and extended traffic control will be determined according to Article 109.13.”

Revise Article 108.04(b) of the Standard Specifications to read:

“(b) No working day will be charged under the following conditions.

- (1) When adverse weather prevents work on the controlling item.
- (2) When job conditions due to recent weather prevent work on the controlling item.
- (3) When conduct or lack of conduct by the Department or its consultants, representatives, officers, agents, or employees; delay by the Department in making the site available; or delay in furnishing any items required to be furnished to the Contractor by the Department prevents work on the controlling item.
- (4) When delays caused by utility or railroad adjustments prevent work on the controlling item.
- (5) When strikes, lock-outs, extraordinary delays in transportation, or inability to procure critical materials prevent work on the controlling item, as long as these delays are not due to any fault of the Contractor.
- (6) When any condition over which the Contractor has no control prevents work on the controlling item.”

Revise Article 109.09(f) of the Standard Specifications to read:

“(f) Basis of Payment. After resolution of a claim in favor of the Contractor, any adjustment in time required for the work will be made according to Section 108. Any adjustment in the costs to be paid will be made for direct labor, direct materials, direct equipment, direct jobsite overhead, direct offsite overhead, and other direct costs allowed by the resolution. Adjustments in costs will not be made for interest charges, loss of anticipated profit, undocumented loss of efficiency, home office overhead and unabsorbed overhead

other than as allowed by Article 109.13, lost opportunity, preparation of claim expenses and other consequential indirect costs regardless of method of calculation.

The above Basis of Payment is an essential element of the contract and the claim cost recovery of the Contractor shall be so limited.”

Add the following to Section 109 of the Standard Specifications.

“109.13 Payment for Contract Delay. Compensation for escalated material costs, escalated labor costs, extended project overhead, and extended traffic control will be allowed when such costs result from a delay meeting the criteria in the following table.

| Contract Type | Cause of Delay | Length of Delay |
|-----------------|--|---|
| Working Days | Article 108.04(b)(3) or Article 108.04(b)(4) | No working days have been charged for two consecutive weeks. |
| Completion Date | Article 108.08(b)(1) or Article 108.08(b)(7) | The Contractor has been granted a minimum two week extension of contract time, according to Article 108.08. |

Payment for each of the various costs will be according to the following.

- (a) Escalated Material and/or Labor Costs. When the delay causes work, which would have otherwise been completed, to be done after material and/or labor costs have increased, such increases will be paid. Payment for escalated material costs will be limited to the increased costs substantiated by documentation furnished by the Contractor. Payment for escalated labor costs will be limited to those items in Article 109.04(b)(1) and (2), except the 35 percent and 10 percent additives will not be permitted.
- (b) Extended Project Overhead. For the duration of the delay, payment for extended project overhead will be paid as follows.
 - (1) Direct Jobsite and Offsite Overhead. Payment for documented direct jobsite overhead and documented direct offsite overhead, including onsite supervisory and administrative personnel, will be allowed according to the following table.

| Original Contract Amount | Supervisory and Administrative Personnel |
|--|--|
| Up to \$5,000,000 | One Project Superintendent |
| Over \$ 5,000,000 - up to \$25,000,000 | One Project Manager, One Project Superintendent or Engineer, and One Clerk |
| Over \$25,000,000 - up to \$50,000,000 | One Project Manager, One Project Superintendent, One Engineer, and |

| | |
|-------------------|--|
| | One Clerk |
| Over \$50,000,000 | One Project Manager, Two Project Superintendents, One Engineer, and One Clerk |

(2) Home Office and Unabsorbed Overhead. Payment for home office and unabsorbed overhead will be calculated as 8 percent of the total delay cost.

(c) Extended Traffic Control. Traffic control required for an extended period of time due to the delay will be paid for according to Article 109.04.

When an extended traffic control adjustment is paid under this provision, an adjusted unit price as provided for in Article 701.20(a) for increase or decrease in the value of work by more than ten percent will not be paid.

Upon payment for a contract delay under this provision, the Contractor shall assign subrogation rights to the Department for the Department's efforts of recovery from any other party for monies paid by the Department as a result of any claim under this provision. The Contractor shall fully cooperate with the Department in its efforts to recover from another party any money paid to the Contractor for delay damages under this provision."

80384

DISADVANTAGED BUSINESS ENTERPRISE PARTICIPATION (BDE)

Effective: September 1, 2000

Revised: March 2, 2019

FEDERAL OBLIGATION. The Department of Transportation, as a recipient of federal financial assistance, is required to take all necessary and reasonable steps to ensure nondiscrimination in the award and administration of contracts. Consequently, the federal regulatory provisions of 49 CFR Part 26 apply to this contract concerning the utilization of disadvantaged business enterprises. For the purposes of this Special Provision, a disadvantaged business enterprise (DBE) means a business certified by the Department in accordance with the requirements of 49 CFR Part 26 and listed in the Illinois Unified Certification Program (IL UCP) DBE Directory.

STATE OBLIGATION. This Special Provision will also be used by the Department to satisfy the requirements of the Business Enterprise for Minorities, Females, and Persons with Disabilities Act, 30 ILCS 575. When this Special Provision is used to satisfy state law requirements on 100 percent state-funded contracts, the federal government has no involvement in such contracts (not a federal-aid contract) and no responsibility to oversee the implementation of this Special Provision by the Department on those contracts. DBE participation on 100 percent state-funded contracts will not be credited toward fulfilling the Department's annual overall DBE goal required by the US Department of Transportation to comply with the federal DBE program requirements.

CONTRACTOR ASSURANCE. The Contractor makes the following assurance and agrees to include the assurance in each subcontract the Contractor signs with a subcontractor.

The Contractor, subrecipient, or subcontractor shall not discriminate on the basis of race, color, national origin, or sex in the performance of this contract. The Contractor shall carry out applicable requirements of 49 CFR Part 26 in the award and administration of contracts funded in whole or in part with federal or state funds. Failure by the Contractor to carry out these requirements is a material breach of this contract, which may result in the termination of this contract or such other remedy as the recipient deems appropriate, which may include, but is not limited to:

- (a) Withholding progress payments;
- (b) Assessing sanctions;
- (c) Liquidated damages; and/or
- (d) Disqualifying the Contractor from future bidding as non-responsible.

OVERALL GOAL SET FOR THE DEPARTMENT. As a requirement of compliance with 49 CFR Part 26, the Department has set an overall goal for DBE participation in its federally assisted contracts. That goal applies to all federal-aid funds the Department will expend in its federally assisted contracts for the subject reporting fiscal year. The Department is required to make a

good faith effort to achieve the overall goal. The dollar amount paid to all approved DBE companies performing work called for in this contract is eligible to be credited toward fulfillment of the Department's overall goal.

CONTRACT GOAL TO BE ACHIEVED BY THE CONTRACTOR. This contract includes a specific DBE utilization goal established by the Department. The goal has been included because the Department has determined the work of this contract has subcontracting opportunities that may be suitable for performance by DBE companies. The determination is based on an assessment of the type of work, the location of the work, and the availability of DBE companies to do a part of the work. The assessment indicates, in the absence of unlawful discrimination and in an arena of fair and open competition, DBE companies can be expected to perform 5% of the work. This percentage is set as the DBE participation goal for this contract. Consequently, in addition to the other award criteria established for this contract, the Department will only award this contract to a bidder who makes a good faith effort to meet this goal of DBE participation in the performance of the work. A bidder makes a good faith effort for award consideration if either of the following is done in accordance with the procedures set for in this Special Provision:

- (a) The bidder documents enough DBE participation has been obtained to meet the goal or,
- (b) The bidder documents a good faith effort has been made to meet the goal, even though the effort did not succeed in obtaining enough DBE participation to meet the goal.

DBE LOCATOR REFERENCES. Bidders shall consult the IL UCP DBE Directory as a reference source for DBE-certified companies. In addition, the Department maintains a letting and item specific DBE locator information system whereby DBE companies can register their interest in providing quotes on particular bid items advertised for letting. Information concerning DBE companies willing to quote work for particular contracts may be obtained by contacting the Department's Bureau of Small Business Enterprises at telephone number (217) 785-4611, or by visiting the Department's website at:

<http://www.idot.illinois.gov/doing-business/certifications/disadvantaged-business-enterprise-certification/il-ucp-directory/index>.

BIDDING PROCEDURES. Compliance with this Special Provision is a material bidding requirement and failure of the bidder to comply will render the bid not responsive.

The bidder shall submit a DBE Utilization Plan (form SBE 2026), and a DBE Participation Statement (form SBE 2025) for each DBE company proposed for the performance of work to achieve the contract goal, with the bid. If the Utilization Plan indicates the contract goal will not be met, documentation of good faith efforts shall also be submitted. The documentation of good faith efforts must include copies of each DBE and non-DBE subcontractor quote submitted to the bidder when a non-DBE subcontractor is selected over a DBE for work on the contract. The required forms and documentation must be submitted as a single .pdf file using the "Integrated Contractor Exchange (iCX)" application within the Department's "EBids System".

The Department will not accept a Utilization Plan if it does not meet the bidding procedures set forth herein and the bid will be declared not responsive. In the event the bid is declared not responsive, the Department may elect to cause the forfeiture of the penal sum of the bidder's proposal guaranty and may deny authorization to bid the project if re-advertised for bids.

GOOD FAITH EFFORT PROCEDURES. The contract will not be awarded until the Utilization Plan is approved. All information submitted by the bidder must be complete, accurate and adequately document enough DBE participation has been obtained or document the good faith efforts of the bidder, in the event enough DBE participation has not been obtained, before the Department will commit to the performance of the contract by the bidder. The Utilization Plan will be approved by the Department if the Utilization Plan documents sufficient commercially useful DBE work to meet the contract goal or the bidder submits sufficient documentation of a good faith effort to meet the contract goal pursuant to 49 CFR Part 26, Appendix A. This means the bidder must show that all necessary and reasonable steps were taken to achieve the contract goal. Necessary and reasonable steps are those which, by their scope, intensity and appropriateness to the objective, could reasonably be expected to obtain sufficient DBE participation, even if they were not successful. The Department will consider the quality, quantity, and intensity of the kinds of efforts the bidder has made. Mere *pro forma* efforts, in other words efforts done as a matter of form, are not good faith efforts; rather, the bidder is expected to have taken genuine efforts that would be reasonably expected of a bidder actively and aggressively trying to obtain DBE participation sufficient to meet the contract goal.

- (a) The following is a list of types of action that the Department will consider as part of the evaluation of the bidder's good faith efforts to obtain participation. These listed factors are not intended to be a mandatory checklist and are not intended to be exhaustive. Other factors or efforts brought to the attention of the Department may be relevant in appropriate cases and will be considered by the Department.
 - (1) Soliciting through all reasonable and available means (e.g. attendance at pre-bid meetings, advertising and/or written notices) the interest of all certified DBE companies that have the capability to perform the work of the contract. The bidder must solicit this interest within sufficient time to allow the DBE companies to respond to the solicitation. The bidder must determine with certainty if the DBE companies are interested by taking appropriate steps to follow up initial solicitations.
 - (2) Selecting portions of the work to be performed by DBE companies in order to increase the likelihood that the DBE goals will be achieved. This includes, where appropriate, breaking out contract work items into economically feasible units to facilitate DBE participation, even when the Contractor might otherwise prefer to perform these work items with its own forces.
 - (3) Providing interested DBE companies with adequate information about the plans, specifications, and requirements of the contract in a timely manner to assist them in responding to a solicitation.

- (4) a. Negotiating in good faith with interested DBE companies. It is the bidder's responsibility to make a portion of the work available to DBE subcontractors and suppliers and to select those portions of the work or material needs consistent with the available DBE subcontractors and suppliers, so as to facilitate DBE participation. Evidence of such negotiation includes the names, addresses, and telephone numbers of DBE companies that were considered; a description of the information provided regarding the plans and specifications for the work selected for subcontracting; and evidence as to why additional agreements could not be reached for DBE companies to perform the work.
 - b. A bidder using good business judgment would consider a number of factors in negotiating with subcontractors, including DBE subcontractors, and would take a firm's price and capabilities as well as contract goals into consideration. However, the fact that there may be some additional costs involved in finding and using DBE companies is not in itself sufficient reason for a bidder's failure to meet the contract DBE goal, as long as such costs are reasonable. Also the ability or desire of a bidder to perform the work of a contract with its own organization does not relieve the bidder of the responsibility to make good faith efforts. Bidders are not, however, required to accept higher quotes from DBE companies if the price difference is excessive or unreasonable. In accordance with the above Bidding Procedures, the documentation of good faith efforts must include copies of each DBE and non-DBE subcontractor quote submitted to the bidder when a non-DBE subcontractor was selected over a DBE for work on the contract.
- (5) Not rejecting DBE companies as being unqualified without sound reasons based on a thorough investigation of their capabilities. The bidder's standing within its industry, membership in specific groups, organizations, or associations and political or social affiliations (for example union vs. non-union employee status) are not legitimate causes for the rejection or non-solicitation of bids in the bidder's efforts to meet the project goal.
 - (6) Making efforts to assist interested DBE companies in obtaining bonding, lines of credit, or insurance as required by the recipient or Contractor.
 - (7) Making efforts to assist interested DBE companies in obtaining necessary equipment, supplies, materials, or related assistance or services.
 - (8) Effectively using the services of available minority/women community organizations; minority/women contractors' groups; local, state, and federal minority/women business assistance offices; and other organizations as allowed on a case-by-case basis to provide assistance in the recruitment and placement of DBE companies.
- (b) If the Department determines the bidder has made a good faith effort to secure the work commitment of DBE companies to meet the contract goal, the Department will award the contract provided it is otherwise eligible for award. If the Department determines the

bidder has failed to meet the requirements of this Special Provision or that a good faith effort has not been made, the Department will notify the responsible company official designated in the Utilization Plan that the bid is not responsive. The notification will also include a statement of reasons for the adverse determination. If the Utilization Plan is not approved because it is deficient as a technical matter, unless waived by the Department, the bidder will be notified and will be allowed no more than a five calendar day period to cure the deficiency.

- (c) The bidder may request administrative reconsideration of an adverse determination by emailing the Department at "DOT.DBE.UP@illinois.gov" within the five calendar days after the receipt of the notification of the determination. The determination shall become final if a request is not made on or before the fifth calendar day. A request may provide additional written documentation or argument concerning the issues raised in the determination statement of reasons, provided the documentation and arguments address efforts made prior to submitting the bid. The request will be reviewed by the Department's Reconsideration Officer. The Reconsideration Officer will extend an opportunity to the bidder to meet in person to consider all issues of documentation and whether the bidder made a good faith effort to meet the goal. After the review by the Reconsideration Officer, the bidder will be sent a written decision within ten working days after receipt of the request for reconsideration, explaining the basis for finding that the bidder did or did not meet the goal or make adequate good faith efforts to do so. A final decision by the Reconsideration Officer that a good faith effort was made shall approve the Utilization Plan submitted by the bidder and shall clear the contract for award. A final decision that a good faith effort was not made shall render the bid not responsive.

CALCULATING DBE PARTICIPATION. The Utilization Plan values represent work anticipated to be performed and paid for upon satisfactory completion. The Department is only able to count toward the achievement of the overall goal and the contract goal the value of payments made for the work actually performed by DBE companies. In addition, a DBE must perform a commercially useful function on the contract to be counted. A commercially useful function is generally performed when the DBE is responsible for the work and is carrying out its responsibilities by actually performing, managing, and supervising the work involved. The Department and Contractor are governed by the provisions of 49 CFR Part 26.55(c) on questions of commercially useful functions as it affects the work. Specific counting guidelines are provided in 49 CFR Part 26.55, the provisions of which govern over the summary contained herein.

- (a) DBE as the Contractor: 100 percent goal credit for that portion of the work performed by the DBE's own forces, including the cost of materials and supplies. Work that a DBE subcontracts to a non-DBE does not count toward the DBE goals.
- (b) DBE as a joint venture Contractor: 100 percent goal credit for that portion of the total dollar value of the contract equal to the distinct, clearly defined portion of the work performed by the DBE's own forces.

- (c) DBE as a subcontractor: 100 percent goal credit for the work of the subcontract performed by the DBE's own forces, including the cost of materials and supplies, excluding the purchase of materials and supplies or the lease of equipment by the DBE subcontractor from the Contractor or its affiliates. Work that a DBE subcontractor in turn subcontracts to a non-DBE does not count toward the DBE goal.
- (d) DBE as a trucker: 100 percent goal credit for trucking participation provided the DBE is responsible for the management and supervision of the entire trucking operation for which it is responsible. At least one truck owned, operated, licensed, and insured by the DBE must be used on the contract. Credit will be given for the following:
 - (1) The DBE may lease trucks from another DBE firm, including an owner-operator who is certified as a DBE. The DBE who leases trucks from another DBE receives credit for the total value of the transportation services the lessee DBE provides on the contract.
 - (2) The DBE may also lease trucks from a non-DBE firm, including from an owner-operator. The DBE who leases trucks from a non-DBE is entitled to credit only for the fee or commission it receives as a result of the lease arrangement.
- (e) DBE as a material supplier:
 - (1) 60 percent goal credit for the cost of the materials or supplies purchased from a DBE regular dealer.
 - (2) 100 percent goal credit for the cost of materials or supplies obtained from a DBE manufacturer.
 - (3) 100 percent credit for the value of reasonable fees and commissions for the procurement of materials and supplies if not a DBE regular dealer or DBE manufacturer.

CONTRACT COMPLIANCE. Compliance with this Special Provision is an essential part of the contract. The Department is prohibited by federal regulations from crediting the participation of a DBE included in the Utilization Plan toward either the contract goal or the Department's overall goal until the amount to be applied toward the goals has been paid to the DBE. The following administrative procedures and remedies govern the compliance by the Contractor with the contractual obligations established by the Utilization Plan. After approval of the Utilization Plan and award of the contract, the Utilization Plan and individual DBE Participation Statements become part of the contract. If the Contractor did not succeed in obtaining enough DBE participation to achieve the advertised contract goal, and the Utilization Plan was approved and contract awarded based upon a determination of good faith, the total dollar value of DBE work calculated in the approved Utilization Plan as a percentage of the awarded contract value shall become the amended contract goal. All work indicated for performance by an approved DBE shall be performed, managed, and supervised by the DBE executing the DBE Participation Commitment Statement.

- (a) NO AMENDMENT. No amendment to the Utilization Plan may be made without prior written approval from the Department's Bureau of Small Business Enterprises. All requests for amendment to the Utilization Plan shall be emailed to the Department at DOT.DBE.UP@illinois.gov.
- (b) CHANGES TO WORK. Any deviation from the DBE condition-of-award or contract plans, specifications, or special provisions must be approved, in writing, by the Department as provided elsewhere in the Contract. The Contractor shall notify affected DBEs in writing of any changes in the scope of work which result in a reduction in the dollar amount condition-of-award to the contract. Where the revision includes work committed to a new DBE subcontractor, not previously involved in the project, then a Request for Approval of Subcontractor, Department form BC 260A or AER 260A, must be signed and submitted. If the commitment of work is in the form of additional tasks assigned to an existing subcontract, a new Request for Approval of Subcontractor will not be required. However, the Contractor must document efforts to assure the existing DBE subcontractor is capable of performing the additional work and has agreed in writing to the change.
- (c) SUBCONTRACT. The Contractor must provide copies of DBE subcontracts to the Department upon request. Subcontractors shall ensure that all lower tier subcontracts or agreements with DBEs to supply labor or materials be performed in accordance with this Special Provision.
- (d) ALTERNATIVE WORK METHODS. In addition to the above requirements for reductions in the condition of award, additional requirements apply to the two cases of Contractor-initiated work substitution proposals. Where the contract allows alternate work methods which serve to delete or create underruns in condition of award DBE work, and the Contractor selects that alternate method or, where the Contractor proposes a substitute work method or material that serves to diminish or delete work committed to a DBE and replace it with other work, then the Contractor must demonstrate one of the following:
 - (1) The replacement work will be performed by the same DBE (as long as the DBE is certified in the respective item of work) in a modification of the condition of award; or
 - (2) The DBE is aware its work will be deleted or will experience underruns and has agreed in writing to the change. If this occurs, the Contractor shall substitute other work of equivalent value to a certified DBE or provide documentation of good faith efforts to do so; or
 - (3) The DBE is not capable of performing the replacement work or has declined to perform the work at a reasonable competitive price. If this occurs, the Contractor shall substitute other work of equivalent value to a certified DBE or provide documentation of good faith efforts to do so.

- (e) TERMINATION AND REPLACEMENT PROCEDURES. The Contractor shall not terminate or replace a DBE listed on the approved Utilization Plan, or perform with other forces work designated for a listed DBE except as provided in this Special Provision. The Contractor shall utilize the specific DBEs listed to perform the work and supply the materials for which each is listed unless the Contractor obtains the Department's written consent as provided in subsection (a) of this part. Unless Department consent is provided for termination of a DBE subcontractor, the Contractor shall not be entitled to any payment for work or material unless it is performed or supplied by the DBE in the Utilization Plan.

As stated above, the Contractor shall not terminate or replace a DBE subcontractor listed in the approved Utilization Plan without prior written consent. This includes, but is not limited to, instances in which the Contractor seeks to perform work originally designated for a DBE subcontractor with its own forces or those of an affiliate, a non-DBE firm, or with another DBE firm. Written consent will be granted only if the Bureau of Small Business Enterprises agrees, for reasons stated in its concurrence document, that the Contractor has good cause to terminate or replace the DBE firm. Before transmitting to the Bureau of Small Business Enterprises any request to terminate and/or substitute a DBE subcontractor, the Contractor shall give notice in writing to the DBE subcontractor, with a copy to the Bureau, of its intent to request to terminate and/or substitute, and the reason for the request. The Contractor shall give the DBE five days to respond to the Contractor's notice. The DBE so notified shall advise the Bureau and the Contractor of the reasons, if any, why it objects to the proposed termination of its subcontract and why the Bureau should not approve the Contractor's action. If required in a particular case as a matter of public necessity, the Bureau may provide a response period shorter than five days.

For purposes of this paragraph, good cause includes the following circumstances:

- (1) The listed DBE subcontractor fails or refuses to execute a written contract;
- (2) The listed DBE subcontractor fails or refuses to perform the work of its subcontract in a way consistent with normal industry standards. Provided, however, that good cause does not exist if the failure or refusal of the DBE subcontractor to perform its work on the subcontract results from the bad faith or discriminatory action of the Contractor;
- (3) The listed DBE subcontractor fails or refuses to meet the Contractor's reasonable, nondiscriminatory bond requirements;
- (4) The listed DBE subcontractor becomes bankrupt, insolvent, or exhibits credit unworthiness;
- (5) The listed DBE subcontractor is ineligible to work on public works projects because of suspension and debarment proceedings pursuant 2 CFR Parts 180, 215 and 1200 or applicable state law.

- (6) The Contractor has determined the listed DBE subcontractor is not a responsible contractor;
- (7) The listed DBE subcontractor voluntarily withdraws from the projects and provides written notice to the Contractor of its withdrawal;
- (8) The listed DBE is ineligible to receive DBE credit for the type of work required;
- (9) A DBE owner dies or becomes disabled with the result that the listed DBE subcontractor is unable to complete its work on the contract;
- (10) Other documented good cause that compels the termination of the DBE subcontractor. Provided, that good cause does not exist if the Contractor seeks to terminate a DBE it relied upon to obtain the contract so that the Contractor can self-perform the work for which the DBE contractor was engaged or so that the Contractor can substitute another DBE or non-DBE contractor after contract award.

When a DBE is terminated or fails to complete its work on the Contract for any reason, the Contractor shall make a good faith effort to find another DBE to substitute for the original DBE to perform at least the same amount of work under the contract as the terminated DBE to the extent needed to meet the established Contract goal. The good faith efforts shall be documented by the Contractor. If the Department requests documentation under this provision, the Contractor shall submit the documentation within seven days, which may be extended for an additional seven days if necessary at the request of the Contractor. The Department will provide a written determination to the Contractor stating whether or not good faith efforts have been demonstrated.

- (f) FINAL PAYMENT. After the performance of the final item of work or delivery of material by a DBE and final payment therefore to the DBE by the Contractor, but not later than 30 calendar days after payment has been made by the Department to the Contractor for such work or material, the Contractor shall submit a DBE Payment Agreement on Department form SBE 2115 to the Resident Engineer. If full and final payment has not been made to the DBE, the DBE Payment Agreement shall indicate whether a disagreement as to the payment required exists between the Contractor and the DBE or if the Contractor believes the work has not been satisfactorily completed. If the Contractor does not have the full amount of work indicated in the Utilization Plan performed by the DBE companies indicated in the Utilization Plan and after good faith efforts are reviewed, the Department may deduct from contract payments to the Contractor the amount of the goal not achieved as liquidated and ascertained damages. The Contractor may request an administrative reconsideration of any amount deducted as damages pursuant to subsection (h) of this part.
- (g) ENFORCEMENT. The Department reserves the right to withhold payment to the Contractor to enforce the provisions of this Special Provision. Final payment shall not be

made on the contract until such time as the Contractor submits sufficient documentation demonstrating achievement of the goal in accordance with this Special Provision or after liquidated damages have been determined and collected.

- (h) RECONSIDERATION. Notwithstanding any other provision of the contract, including but not limited to Article 109.09 of the Standard Specifications, the Contractor may request administrative reconsideration of a decision to deduct the amount of the goal not achieved as liquidated damages. A request to reconsider shall be delivered to the Contract Compliance Section and shall be handled and considered in the same manner as set forth in paragraph (c) of "Good Faith Effort Procedures" of this Special Provision, except a final decision that a good faith effort was not made during contract performance to achieve the goal agreed to in the Utilization Plan shall be the final administrative decision of the Department. The result of the reconsideration process is not administratively appealable to the U.S. Department of Transportation.

80029

HOT-MIX ASPHALT (BDE)

Effective: January 1, 2024

Revise the second paragraph of Articles 1030.07(a)(11) and 1030.08(a)(9) of the Standard Specifications to read:

“When establishing the target density, the HMA maximum theoretical specific gravity (G_{mm}) will be based on the running average of four available Department test results for that project. If less than four G_{mm} test results are available, an average of all available Department test results for that project will be used. The initial G_{mm} will be the last available Department test result from a QMP project. If there is no available Department test result from a QMP project, the Department mix design verification test result will be used as the initial G_{mm} .”

In the Supplemental Specifications, replace the revision for the end of the third paragraph of Article 1030.09(h)(2) with the following:

“When establishing the target density, the HMA maximum theoretical specific gravity (G_{mm}) will be the Department mix design verification test result.”

Revise the tenth paragraph of Article 1030.10 of the Standard Specifications to read:

“Production is not required to stop after a test strip has been constructed.”

80456

HOT-MIX ASPHALT – LONGITUDINAL JOINT SEALANT (BDE)

Effective: November 1, 2022

Revised: August 1, 2023

Add the following after the second sentence in the eighth paragraph of Article 406.06(h)(2) of the Standard Specifications:

“If rain is forecasted and traffic is to be on the LJS or if pickup/tracking of the LJS material is likely, the LJS shall be covered immediately following its application with FA 20 fine aggregate mechanically spread uniformly at a rate of 1.5 ± 0.5 lb/sq yd (0.75 ± 0.25 kg/sq m). Fine aggregate landing outside of the LJS shall be removed prior to application of tack coat.”

Add the following after the first sentence in the ninth paragraph of Article 406.06(h)(2) of the Standard Specifications:

“LJS half-width shall be applied at a width of 9 ± 1 in. (225 ± 25 mm) in the immediate lane to be placed with the outside edge flush with the joint of the next HMA lift. The vertical face of any longitudinal joint remaining in place shall also be coated.”

Add the following after the eleventh paragraph of Article 406.06(h)(2) of the Standard Specifications:

| “LJS Half-Width Application Rate, lb/ft (kg/m) ^{1/} | | | |
|--|---|--------------------------------------|---------------------------------------|
| Lift Thickness, in. (mm) | Coarse Graded Mixture (IL-19.0, IL-19.0L, IL-9.5, IL-9.5L, IL-4.75) | Fine Graded Mixture (IL-9.5FG) | SMA Mixture (SMA-9.5, SMA-12.5) |
| $\frac{3}{4}$ (19) | 0.44 (0.66) | | |
| 1 (25) | 0.58 (0.86) | | |
| 1 $\frac{1}{4}$ (32) | 0.66 (0.98) | 0.44 (0.66) | |
| 1 $\frac{1}{2}$ (38) | 0.74 (1.10) | 0.48 (0.71) | 0.63 (0.94) |
| 1 $\frac{3}{4}$ (44) | 0.82 (1.22) | 0.52 (0.77) | 0.69 (1.03) |
| 2 (50) | 0.90 (1.34) | 0.56 (0.83) | 0.76 (1.13) |
| $\geq 2 \frac{1}{4}$ (60) | 0.98 (1.46) | | |

1/ The application rate includes a surface demand for liquid. The thickness of the LJS may taper from the center of the application to a lesser thickness on the edge of the application, provided the correct width and application rate are maintained.”

Revise the second paragraph of Article 406.13(b) of the Standard Specifications to read:

“Aggregate for covering tack, LJS, or FLS will not be measured for payment.”

Add the following to the end of the second paragraph of Article 406.14 of the Standard Specifications:

“Longitudinal joint sealant (LJS) half-width will be paid for at the contract unit price per foot (meter) for LONGITUDINAL JOINT SEALANT, HALF-WIDTH.”

80446

MATERIAL TRANSFER DEVICE (BDE)

Effective: June 15, 1999
Revised: January 1, 2022

Add the following to Article 406.03 of the Standard Specifications:

“(n) Material Transfer Device 1102.02”

Add the following to the end of Article 406.06(f) of the Standard Specifications:

“When required, a material transfer device (MTD) shall be used to transfer the HMA from the haul trucks to the spreading and finishing machine. The particular HMA mixtures for which an MTD is required will be specified in the plans. When not required, an MTD may still be used at the Contractor’s option, subject to the requirements and restrictions herein. Use of MTDs shall be according to the following.

| MTD Category | Usage |
|--------------|--|
| Category I | Any resurfacing application Full-Depth HMA where the in-place binder thickness is ≥ 10 in. (250 mm) |
| Category II | Full-Depth HMA where the in-place binder thickness is < 10 in. (250 mm) |

Category I MTD’s will only be allowed to travel over structures under the following conditions:

- (1) Approval will be given by the Engineer.
- (2) The MTD shall be emptied of HMA material prior to crossing the structure and shall travel at crawl speed across the structure.
- (3) The tires of the MTD shall travel on or in close proximity and parallel to the beam and/or girder lines of the structure.”

Add the following to the end of Article 406.13(b) of the Standard Specifications:

“The required use of an MTD will be measured for payment in tons (metric tons) of the HMA mixtures placed with the MTD. The use of an MTD at the Contractor’s option will not be measured for payment.”

Add the following between the second and third paragraphs of Article 406.14 of the Standard Specifications:

“The required use of an MTD will be paid for at the contract unit price per ton (metric ton) for MATERIAL TRANSFER DEVICE. The HMA mixtures placed with the MTD will be paid for separately according to their respective specifications.”

Revise Article 1102.02 of the Standard Specifications to read:

“1102.02 Material Transfer Device (MTD). The MTD shall be according to the following.

- (a) Requirements. The MTD shall have a minimum surge capacity of 15 tons (13.5 metric tons), shall be self-propelled and capable of moving independent of the paver, and shall be equipped with the following.
 - (1) Front-Dump Hopper and Conveyor. The conveyor shall provide a positive restraint along the sides of the conveyor to prevent material spillage. MTDs having paver style hoppers shall have a horizontal bar restraint placed across the foldable wings which prevents the wings from being folded.
 - (2) Paver Hopper Insert. The paver hopper insert shall have a minimum capacity of 14 tons (12.7 metric tons).
 - (3) Mixer/Agitator Mechanism. This re-mixing mechanism shall consist of a segmented, anti-segregation, re-mixing auger.
- (b) Qualification and Designation. The MTD shall be on the Department’s qualified product list with one of the following designations.
 - (1) Category I. The MTD has a documented maximum HMA carrying capacity contact pressure greater than 25 psi and has a central surge hopper of sufficient capacity to mix upstream HMA with downstream HMA.
 - (2) Category II. The MTD has a documented maximum HMA carrying capacity contact pressure less than or equal to 25 psi.”

80045

PERFORMANCE GRADED ASPHALT BINDER (BDE)

Effective: January 1, 2023

Revise Article 1032.05 of the Standard Specifications to read:

“1032.05 Performance Graded Asphalt Binder. These materials will be accepted according to the Bureau of Materials Policy Memorandum, “Performance Graded Asphalt Binder Qualification Procedure.” The Department will maintain a qualified producer list. These materials shall be free from water and shall not foam when heated to any temperature below the actual flash point. Air blown asphalt, recycle engine oil bottoms (ReOB), and polyphosphoric acid (PPA) modification shall not be used.

When requested, producers shall provide the Engineer with viscosity/temperature relationships for the performance graded asphalt binders delivered and incorporated in the work.

- (a) Performance Graded (PG) Asphalt Binder. The asphalt binder shall meet the requirements of AASHTO M 320, Table 1 “Standard Specification for Performance Graded Asphalt Binder” for the grade shown on the plans and the following.

| Test | Parameter |
|--|------------|
| Small Strain Parameter (AASHTO PP 113) BBR, ΔT_c , 40 hrs PAV (40 hrs continuous or 2 PAV at 20 hrs) | -5 °C min. |

- (b) Modified Performance Graded (PG) Asphalt Binder. The asphalt binder shall meet the requirements of AASHTO M 320, Table 1 “Standard Specification for Performance Graded Asphalt Binder” for the grade shown on the plans.

Asphalt binder modification shall be performed at the source, as defined in the Bureau of Materials Policy Memorandum, “Performance Graded Asphalt Binder Qualification Procedure.”

Modified asphalt binder shall be safe to handle at asphalt binder production and storage temperatures or HMA construction temperatures. Safety Data Sheets (SDS) shall be provided for all asphalt modifiers.

- (1) Polymer Modification (SB/SBS or SBR). Elastomers shall be added to the base asphalt binder to achieve the specified performance grade and shall be either a styrene-butadiene diblock, triblock copolymer without oil extension, or a styrene-butadiene rubber. The polymer modified asphalt binder shall be smooth, homogeneous, and be according to the requirements shown in Table 1 or 2 for the grade shown on the plans.

| Table 1 - Requirements for Styrene-Butadiene Copolymer (SB/SBS) Modified Asphalt Binders | | |
|---|---|---|
| Test | Asphalt Grade SB/SBS PG 64-28 SB/SBS PG 70-22 | Asphalt Grade SB/SBS PG 64-34 SB/SBS PG 70-28 SB/SBS PG 76-22 SB/SBS PG 76-28 |
| Separation of Polymer ITP, "Separation of Polymer from Asphalt Binder" Difference in °F (°C) of the softening point between top and bottom portions | 4 (2) max. | 4 (2) max. |
| TESTS ON RESIDUE FROM ROLLING THIN FILM OVEN TEST (AASHTO T 240) | | |
| Elastic Recovery ASTM D 6084, Procedure A, 77 °F (25 °C), 100 mm elongation, % | 60 min. | 70 min. |

| Table 2 - Requirements for Styrene-Butadiene Rubber (SBR) Modified Asphalt Binders | | |
|---|---|---|
| Test | Asphalt Grade SBR PG 64-28 SBR PG 70-22 | Asphalt Grade SB/SBS PG 64-34 SB/SBS PG 70-28 SBR PG 76-22 SBR PG 76-28 |
| Separation of Polymer ITP, "Separation of Polymer from Asphalt Binder" Difference in °F (°C) of the softening point between top and bottom portions | 4 (2) max. | 4 (2) max. |
| Toughness ASTM D 5801, 77 °F (25 °C), 20 in./min. (500 mm/min.), in.-lbs (N-m) | 110 (12.5) min. | 110 (12.5) min. |
| Tenacity ASTM D 5801, 77 °F (25 °C), 20 in./min. (500 mm/min.), in.-lbs (N-m) | 75 (8.5) min. | 75 (8.5) min. |
| TESTS ON RESIDUE FROM ROLLING THIN FILM OVEN TEST (AASHTO T 240) | | |
| Elastic Recovery ASTM D 6084, Procedure A, 77 °F (25 °C), 100 mm elongation, % | 40 min. | 50 min. |

- (2) Ground Tire Rubber (GTR) Modification. GTR modification is the addition of recycled ground tire rubber to liquid asphalt binder to achieve the specified performance grade. GTR shall be produced from processing automobile and/or truck tires by the ambient

grinding method or micronizing through a cryogenic process. GTR shall not exceed 1/16 in. (2 mm) in any dimension and shall not contain free metal particles, moisture that would cause foaming of the asphalt, or other foreign materials. A mineral powder (such as talc) meeting the requirements of AASHTO M 17 may be added, up to a maximum of four percent by weight of GTR to reduce sticking and caking of the GTR particles. When tested in accordance with Illinois Modified AASHTO T 27 “Standard Method of Test for Sieve Analysis of Fine and Coarse Aggregates” or AASHTO PP 74 “Standard Practice for Determination of Size and Shape of Glass Beads Used in Traffic Markings by Means of Computerized Optical Method”, a 50 g sample of the GTR shall conform to the following gradation requirements.

| Sieve Size | Percent Passing |
|------------------|-----------------|
| No. 16 (1.18 mm) | 100 |
| No. 30 (600 µm) | 95 ± 5 |
| No. 50 (300 µm) | > 20 |

GTR modified asphalt binder shall be tested for rotational viscosity according to AASHTO T 316 using spindle S27. GTR modified asphalt binder shall be tested for original dynamic shear and RTFO dynamic shear according to AASHTO T 315 using a gap of 2 mm.

The GTR modified asphalt binder shall meet the requirements of Table 3.

| Table 3 - Requirements for Ground Tire Rubber (GTR) Modified Asphalt Binders | | |
|--|---|---|
| Test | Asphalt Grade GTR PG 64-28 GTR PG 70-22 | Asphalt Grade GTR PG 76-22 GTR PG 76-28 GTR PG 70-28 |
| TESTS ON RESIDUE FROM ROLLING THIN FILM OVEN TEST (AASHTO T 240) | | |
| Elastic Recovery ASTM D 6084, Procedure A, 77 °F (25 °C), 100 mm elongation, % | 60 min. | 70 min. |

- (3) Softener Modification (SM). Softener modification is the addition of organic compounds, such as engineered flux, bio-oil blends, modified vegetable oils, glycol amines, and fatty acid derivatives, to the base asphalt binder to achieve the specified performance grade. Softeners shall be dissolved, dispersed, or reacted in the asphalt binder to enhance its performance and shall remain compatible with the asphalt binder with no separation. Softeners shall not be added to modified PG asphalt binder as defined in Articles 1032.05(b)(1) or 1032.05(b)(2).

An Attenuated Total Reflectance-Fourier Transform Infrared spectrum (ATR-FTIR) shall be collected for both the softening compound as well as the softener modified

asphalt binder at the dose intended for qualification. The ATR-FTIR spectra shall be collected on unaged softener modified binder, 20-hour Pressurized Aging Vessel (PAV) aged softener modified binder, and 40-hour PAV aged softener modified binder. The ATR-FTIR shall be collected in accordance with Illinois Test Procedure 601. The electronic files spectral files (in one of the following extensions or equivalent: *.SPA, *.SPG, *.IRD, *.IFG, *.CSV, *.SP, *.IRS, *.GAML, *. [0-9], *.IGM, *.ABS, *.DRT, *.SBM, *.RAS) shall be submitted to the Central Bureau of Materials.

Softener modified asphalt binders shall meet the requirements in Table 4.

| Test | Asphalt Grade | |
|--|---------------|-------------|
| | SM PG 46-28 | SM PG 46-34 |
| | SM PG 52-28 | SM PG 52-34 |
| | SM PG 58-22 | SM PG 58-28 |
| | SM PG 64-22 | |
| Small Strain Parameter (AASHTO PP 113) BBR, ΔT_c , 40 hrs PAV (40 hrs continuous or 2 PAV at 20 hrs) | -5°C min. | |
| Large Strain Parameter (Illinois Modified AASHTO T 391) DSR/LAS Fatigue Property, $\Delta G^* _{peak}$, 40 hrs PAV (40 hrs continuous or 2 PAV at 20 hrs) | ≥ 54 % | |

The following grades may be specified as tack coats.

| Asphalt Grade | Use |
|------------------------------|-----------|
| PG 58-22, PG 58-28, PG 64-22 | Tack Coat |

Revise Article 1031.06(c)(1) and 1031.06(c)(2) of the Standard Specifications to read:

“(1) RAP/RAS. When RAP is used alone or RAP is used in conjunction with RAS, the percentage of virgin ABR shall not exceed the amounts listed in the following table.

| Ndesign | Binder | Surface | Polymer Modified Binder or Surface ^{3/} |
|---------|--------|---------|--|
| 30 | 30 | 30 | 10 |
| 50 | 25 | 15 | 10 |
| 70 | 15 | 10 | 10 |
| 90 | 10 | 10 | 10 |

1/ For Low ESAL HMA shoulder and stabilized subbase, the RAP/RAS ABR shall not exceed 50 percent of the mixture.

- 2/ When RAP/RAS ABR exceeds 20 percent, the high and low virgin asphalt binder grades shall each be reduced by one grade (i.e. 25 percent ABR would require a virgin asphalt binder grade of PG 64-22 to be reduced to a PG 58-28).
 - 3/ The maximum ABR percentages for ground tire rubber (GTR) modified mixes shall be equivalent to the percentages specified for SBS/SBR polymer modified mixes.
- (2) FRAP/RAS. When FRAP is used alone or FRAP is used in conjunction with RAS, the percentage of virgin asphalt binder replacement shall not exceed the amounts listed in the following table.

| HMA Mixtures - FRAP/RAS Maximum ABR % ^{1/2/} | | | |
|---|--------|---------|--|
| Ndesign | Binder | Surface | Polymer Modified Binder or Surface ^{3/} |
| 30 | 55 | 45 | 15 |
| 50 | 45 | 40 | 15 |
| 70 | 45 | 35 | 15 |
| 90 | 45 | 35 | 15 |
| SMA | -- | -- | 25 |
| IL-4.75 | -- | -- | 35 |

- 1/ For Low ESAL HMA shoulder and stabilized subbase, the FRAP/RAS ABR shall not exceed 50 percent of the mixture.
- 2/ When FRAP/RAS ABR exceeds 20 percent for all mixes, the high and low virgin asphalt binder grades shall each be reduced by one grade (i.e. 25 percent ABR would require a virgin asphalt binder grade of PG 64-22 to be reduced to a PG 58-28).
- 3/ The maximum ABR percentages for GTR modified mixes shall be equivalent to the percentages specified for SBS/SBR polymer modified mixes.”

Add the following to the end of Note 2 of Article 1030.03 of the Standard Specifications.

“A dedicated storage tank for the ground tire rubber (GTR) modified asphalt binder shall be provided. This tank shall be capable of providing continuous mechanical mixing throughout and/or recirculation of the asphalt binder to provide a uniform mixture. The tank shall be heated and capable of maintaining the temperature of the asphalt binder at 300 °F to 350 °F (149 °C to 177 °C). The asphalt binder metering systems of dryer drum plants shall be calibrated with the actual GTR modified asphalt binder material with an accuracy of ±0.40 percent.”

REMOVAL AND DISPOSAL OF REGULATED SUBSTANCES (BDE)

Effective: January 1, 2024

Revised: April 1, 2024

Revise the first paragraph of Article 669.04 of the Standard Specifications to read:

“669.04 Regulated Substances Monitoring. Regulated substances monitoring includes environmental observation and field screening during regulated substances management activities. The excavated soil and groundwater within the work areas shall be managed as either uncontaminated soil, hazardous waste, special waste, or non-special waste.

As part of the regulated substances monitoring, the monitoring personnel shall perform and document the applicable duties listed on form BDE 2732 “Regulated Substances Monitoring Daily Record (RSM DR)”.

Revise the first two sentences of the nineteenth paragraph of Article 669.05 of the Standard Specifications to read:

“The Contractor shall coordinate waste disposal approvals with the disposal facility and provide the specific analytical testing requirements of that facility. The Contractor shall make all arrangements for collection, transportation, and analysis of landfill acceptance testing.”

Revise the last paragraph of Article 669.05 of the Standard Specifications to read:

“The Contractor shall select a permitted landfill facility or CCDD/USFO facility meeting the requirements of 35 Ill. Admin. Code Parts 810-814 or Part 1100, respectively. The Department will review and approve or reject the facility proposed by the Contractor based upon information provided in BDE 2730. The Contractor shall verify whether the selected facility is compliant with those applicable standards as mandated by their permit and whether the facility is presently, has previously been, or has never been, on the United States Environmental Protection Agency (U.S. EPA) National Priorities List or the Resource Conservation and Recovery Act (RCRA) List of Violating Facilities. The use of a Contractor selected facility shall in no manner delay the construction schedule or alter the Contractor's responsibilities as set forth.”

Revise the first paragraph of Article 669.07 of the Standard Specifications to read:

“669.07 Temporary Staging. Soil classified according to Articles 669.05(a)(2), (b)(1), or (c) may be temporarily staged at the Contractor's option. All other soil classified according to Articles 669.05(a)(1), (a)(3), (a)(4), (a)(5), (a)(6), or (b)(2) shall be managed and disposed of without temporary staging to the greatest extent practicable. If circumstances beyond the Contractor's control require temporary staging of these latter materials, the Contractor shall request approval from the Engineer in writing.

Topsoil for re-use as final cover which has been field screened and found not to exhibit PID readings over daily background readings as documented on the BDE 2732, visual staining or

odors, and is classified according to Articles 669.05(a)(2), (a)(3), (a)(4), (b)(1), or (c) may be temporarily staged at the Contractor's option."

Add the following paragraph after the sixth paragraph of Article 669.11 of the Standard Specifications.

"The sampling and testing of effluent water derived from dewatering discharges for priority pollutants volatile organic compounds (VOCs), priority pollutants semi-volatile organic compounds (SVOCs), or priority pollutants metals, will be paid for at the contract unit price per each for VOCS GROUNDWATER ANALYSIS using EPA Method 8260B, SVOCs GROUNDWATER ANALYSIS using EPA Method 8270C, or RCRA METALS GROUNDWATER ANALYSIS using EPA Methods 6010B and 7471A. This price shall include transporting the sample from the job site to the laboratory."

Revise the first sentence of the eight paragraph of Article 669.11 of the Standard Specifications to read:

"Payment for temporary staging of soil classified according to Articles 669.05(a)(1), (a)(3), (a)(4), (a)(5), (a)(6), or (b)(2) to be managed and disposed of, if required and approved by the Engineer, will be paid according to Article 109.04."

80455

SHORT TERM AND TEMPORARY PAVEMENT MARKINGS (BDE)

Effective: April 1, 2024

Revised: April 2, 2024

Revise Article 701.02(d) of the Standard Specifications to read:

“(d) Pavement Marking Tapes (Note 3) 1095.06”

Add the following Note to the end of Article 701.02 of the Standard Specifications:

“Note 3. White or yellow pavement marking tape that is to remain in place longer than 14 days shall be Type IV tape.”

Revise Article 703.02(c) of the Standard Specifications to read:

“(c) Pavement Marking Tapes (Note 1) 1095.06”

Add the following Note to the end of Article 703.02 of the Standard Specifications:

“Note 1. White or yellow pavement marking tape that is to remain in place longer than 14 days shall be Type IV tape.”

Revise Article 1095.06 of the Standard Specifications to read:

“1095.06 Pavement Marking Tapes. Type I white or yellow marking tape shall consist of glass spheres embedded into a binder on a foil backing that is precoated with a pressure sensitive adhesive. The spheres shall be of uniform gradation and distributed evenly over the surface of the tape.

Type IV tape shall consist of white or yellow tape with wet reflective media incorporated to provide immediate and continuing retroreflection in wet and dry conditions. The wet retroreflective media shall be bonded to a durable polyurethane surface. The patterned surface shall have approximately 40 ± 10 percent of the surface area raised and presenting a near vertical face to traffic from any direction. The channels between the raised areas shall be substantially free of exposed reflective elements or particles.

Blackout tape shall consist of a matte black, non-reflective, patterned surface that is precoated with a pressure sensitive adhesive.

- (a) Color. The white and yellow markings shall meet the following requirements for daylight reflectance and color, when tested, using a color spectrophotometer with 45 degrees circumferential/zero degree geometry, illuminant D65, and two degree observer angle. The color instrument shall measure the visible spectrum from 380 to 720 nm with a wavelength measurement interval and spectral bandpass of 10 nm.

| Color | Daylight Reflectance %Y |
|----------|-------------------------|
| White | 65 min. |
| Yellow * | 36 - 59 |

*Shall match Aerospace Material Specification Standard 595 33538 (Orange Yellow) and the chromaticity limits as follows.

| | | | | |
|---|-------|-------|-------|-------|
| x | 0.490 | 0.475 | 0.485 | 0.530 |
| y | 0.470 | 0.438 | 0.425 | 0.456 |

- (b) Retroreflectivity. The white and yellow markings shall be retroreflective. Reflective values measured in accordance with the photometric testing procedure of ASTM D 4061 shall not be less than those listed in the table below. The coefficient of retroreflected luminance, R_L , shall be expressed as average millicandelas/footcandle/sq ft (millicandelas/lux/sq m), measured on a 3.0 x 0.5 ft (900 mm x 150 mm) panel at 86 degree entrance angle.

| Coefficient of Retroreflected Luminance, R_L , Dry | | | | | |
|--|-------|--------|-------------------|-------|--------|
| Type I | | | Type IV | | |
| Observation Angle | White | Yellow | Observation Angle | White | Yellow |
| 0.2° | 2700 | 2400 | 0.2° | 1300 | 1200 |
| 0.5° | 2250 | 2000 | 0.5° | 1100 | 1000 |

Wet retroreflectance shall be measured for Type IV under wet conditions according to ASTM E 2177 and meet the following.

| Wet Retroreflectance, Initial R_L | |
|-------------------------------------|------------------|
| Color | R_L 1.05/88.76 |
| White | 300 |
| Yellow | 200 |

- (c) Skid Resistance. The surface of Type IV and blackout markings shall provide a minimum skid resistance of 45 BPN when tested according to ASTM E 303.
- (d) Application. The pavement marking tape shall have a precoated pressure sensitive adhesive and shall require no activation procedures. Test pieces of the tape shall be applied according to the manufacturer's instructions and tested according to ASTM D 1000, Method A, except that a stiff, short bristle roller brush and heavy hand pressure will be substituted for the weighted rubber roller in applying the test pieces to the metal test panel. Material tested as directed above shall show a minimum adhesion value of 750 g/in. (30 g/mm) width at the temperatures specified in ASTM D 1000. The adhesive shall be resistant to oils, acids, solvents, and water, and shall not leave objectionable stains or residue after removal. The material shall be flexible and conformable to the texture of the pavement.

(e) Durability. Type IV and blackout tape shall be capable of performing for the duration of a normal construction season and shall then be capable of being removed intact or in large sections at pavement temperatures above 40 °F (4 °C) either manually or with a roll-up device without the use of sandblasting, solvents, or grinding. The Contractor shall provide a manufacturer's certification that the material meets the requirements for being removed after the following minimum traffic exposure based on transverse test decks with rolling traffic.

- (1) Time in place - 400 days
- (2) ADT per lane - 9,000 (28 percent trucks)
- (3) Axle hits - 10,000,000 minimum

Samples of the material applied to standard specimen plates will be measured for thickness and tested for durability in accordance with ASTM D 4060, using a CS-17 wheel and 1000-gram load, and shall meet the following criteria showing no significant change in color after being tested for the number of cycles indicated.

| Test | Type I | Type IV | Blackout |
|--------------------------------------|-----------|--|--|
| Minimum Initial Thickness, mils (mm) | 20 (0.51) | 65 (1.65) ^{1/} 20 (0.51) ^{2/} | 65 (1.65) ^{1/} 20 (0.51) ^{2/} |
| Durability (cycles) | 5,000 | 1,500 | 1,500 |

1/ Measured at the thickest point of the patterned surface.

2/ Measured at the thinnest point of the patterned surface.

The pavement marking tape, when applied according to the manufacturer's recommended procedures, shall be weather resistant and shall show no appreciable fading, lifting, or shrinkage during the useful life of the marking. The tape, as applied, shall be of good appearance, free of cracks, and edges shall be true, straight, and unbroken.

(f) Sampling and Inspection.

(1) Sample. Prior to approval and use of Type IV pavement marking tape, the manufacturer shall submit a notarized certification from an independent laboratory, together with the results of all tests, stating that the material meets the requirements as set forth herein. The independent laboratory test report shall state the lot tested, the manufacturer's name, and the date of manufacture.

After initial approval by the Department, samples and certification by the manufacturer shall be submitted for each subsequent batch of Type IV tape used. The manufacturer shall submit a certification stating that the material meets the requirements as set forth herein and is essentially identical to the material sent for qualification. The certification shall state the lot tested, the manufacturer's name, and the date of manufacture.

(2) Inspection. The Contractor shall provide a manufacturer's certification to the Engineer stating the material meets all requirements of this specification. All material samples for acceptance tests shall be taken or witnessed by a representative of the Bureau of Materials and shall be submitted to the Engineer of Materials, 126 East Ash Street, Springfield, Illinois 62704-4766 at least 30 days in advance of the pavement marking operations."

80457

SOURCE OF SUPPLY AND QUALITY REQUIREMENTS (BDE)

Effective: January 2, 2023

Add the following to Article 106.01 of the Standard Specifications:

“The final manufacturing process for construction materials and the immediately preceding manufacturing stage for construction materials shall occur within the United States. Construction materials shall include an article, material, or supply that is or consists primarily of the following.

- (a) Non-ferrous metals;
- (b) Plastic and polymer-based products (including polyvinylchloride, composite building materials, and polymers used in fiber optic cables);
- (c) Glass (including optic glass);
- (d) Lumber;
- (e) Drywall.

Items consisting of two or more of the listed construction materials that have been combined through a manufacturing process, and items including at least one of the listed materials combined with a material that is not listed through a manufacturing process shall be exempt.”

80448

SUBCONTRACTOR AND DBE PAYMENT REPORTING (BDE)

Effective: April 2, 2018

Add the following to Section 109 of the Standard Specifications.

“109.14 Subcontractor and Disadvantaged Business Enterprise Payment Reporting.
The Contractor shall report all payments made to the following parties:

- (a) first tier subcontractors;
- (b) lower tier subcontractors affecting disadvantaged business enterprise (DBE) goal credit;
- (c) material suppliers or trucking firms that are part of the Contractor’s submitted DBE utilization plan.

The report shall be made through the Department’s on-line subcontractor payment reporting system within 21 days of making the payment.”

80397

SUBCONTRACTOR MOBILIZATION PAYMENTS (BDE)

Effective: November 2, 2017

Revised: April 1, 2019

Replace the second paragraph of Article 109.12 of the Standard Specifications with the following:

“This mobilization payment shall be made at least seven days prior to the subcontractor starting work. The amount paid shall be at the following percentage of the amount of the subcontract reported on form BC 260A submitted for the approval of the subcontractor’s work.

| Value of Subcontract Reported on Form BC 260A | Mobilization Percentage |
|---|-------------------------|
| Less than \$10,000 | 25% |
| \$10,000 to less than \$20,000 | 20% |
| \$20,000 to less than \$40,000 | 18% |
| \$40,000 to less than \$60,000 | 16% |
| \$60,000 to less than \$80,000 | 14% |
| \$80,000 to less than \$100,000 | 12% |
| \$100,000 to less than \$250,000 | 10% |
| \$250,000 to less than \$500,000 | 9% |
| \$500,000 to \$750,000 | 8% |
| Over \$750,000 | 7%” |

80391

SUBMISSION OF PAYROLL RECORDS (BDE)

Effective: April 1, 2021

Revised: November 2, 2023

FEDERAL AID CONTRACTS. Revise the following section of Check Sheet #1 of the Recurring Special Provisions to read:

“STATEMENTS AND PAYROLLS

The payroll records shall include the worker’s name, social security number, last known address, telephone number, email address, classification(s) of work actually performed, hourly rates of wages paid (including rates of contributions or costs anticipated for bona fide fringe benefits or cash equivalents thereof), daily and weekly number of hours actually worked in total, deductions made, and actual wages paid.

The Contractor and each subcontractor shall submit certified payroll records to the Department each week from the start to the completion of their respective work, except that full social security numbers, last known addresses, telephone numbers, and email addresses shall not be included on weekly submittals. Instead, the payrolls need only include an identification number for each employee (e.g., the last four digits of the employee’s social security number). The submittals shall be made using LCPTracker Pro software. The software is web-based and can be accessed at <https://lcptracker.com/>. When there has been no activity during a work week, a payroll record shall still be submitted with the appropriate option (“No Work”, “Suspended”, or “Complete”) selected.”

STATE CONTRACTS. Revise Item 3 of Section IV of Check Sheet #5 of the Recurring Special Provisions to read:

- “3. Submission of Payroll Records. The Contractor and each subcontractor shall, no later than the 15th day of each calendar month, file a certified payroll for the immediately preceding month to the Illinois Department of Labor (IDOL) through the Illinois Prevailing Wage Portal in compliance with the State Prevailing Wage Act (820 ILCS 130). The portal can be found on the IDOL website at <https://www2.illinois.gov/idol/Laws-Rules/CONMED/Pages/Prevailing-Wage-Portal.aspx>. Payrolls shall be submitted in the format prescribed by the IDOL.

In addition to filing certified payroll(s) with the IDOL, the Contractor and each subcontractor shall certify and submit payroll records to the Department each week from the start to the completion of their respective work, except that full social security numbers shall not be included on weekly submittals. Instead, the payrolls shall include an identification number for each employee (e.g., the last four digits of the employee’s social security number). In addition, starting and ending times of work each day may be omitted from the payroll records submitted. The submittals shall be made using LCPTracker Pro software. The software is web-based and can be accessed at <https://lcptracker.com/>.

When there has been no activity during a work week, a payroll record shall still be submitted with the appropriate option (“No Work”, “Suspended”, or “Complete”) selected.”

80437

TRAINING SPECIAL PROVISIONS (BDE)

Effective: October 15, 1975
Revised: September 2, 2021

This Training Special Provision supersedes Section 7b of the Special Provision entitled "Specific Equal Employment Opportunity Responsibilities," and is in implementation of 23 U.S.C. 140(a).

As part of the Contractor's equal employment opportunity affirmative action program, training shall be provided as follows:

The Contractor shall provide on-the-job training aimed at developing full journeyman in the type of trade or job classification involved. The number of trainees to be trained under this contract will be 2. In the event the Contractor subcontracts a portion of the contract work, it shall determine how many, if any, of the trainees are to be trained by the subcontractor, provided however, that the Contractor shall retain the primary responsibility for meeting the training requirements imposed by this special provision. The Contractor shall also ensure that this Training Special Provision is made applicable to such subcontract. Where feasible, 25 percent of apprentices or trainees in each occupation shall be in their first year of apprenticeship or training.

The number of trainees shall be distributed among the work classifications on the basis of the Contractor's needs and the availability of journeymen in the various classifications within the reasonable area of recruitment. Prior to commencing construction, the Contractor shall submit to the Illinois Department of Transportation for approval the number of trainees to be trained in each selected classification and training program to be used. Furthermore, the Contractor shall specify the starting time for training in each of the classifications. The Contractor will be credited for each trainee it employs on the contract work who is currently enrolled or becomes enrolled in an approved program and will be reimbursed for such trainees as provided hereinafter.

Training and upgrading of minorities and women toward journeyman status is a primary objective of this Training Special Provision. Accordingly, the Contractor shall make every effort to enroll minority trainees and women (e.g. by conducting systematic and direct recruitment through public and private sources likely to yield minority and women trainees) to the extent such persons are available within a reasonable area of recruitment. The Contractor will be responsible for demonstrating the steps it has taken in pursuance thereof, prior to a determination as to whether the Contractor is in compliance with this Training Special Provision. This training commitment is not intended, and shall not be used, to discriminate against any applicant for training, whether a member of a minority group or not.

No employee shall be employed as a trainee in any classification in which he or she has successfully completed a training course leading to journeyman status or in which he or she has been employed as a journeyman. The Contractor should satisfy this requirement by including appropriate questions in the employee application or by other suitable means. Regardless of the method used, the Contractor's records should document the findings in each case.

The minimum length and type of training for each classification will be as established in the training program selected by the Contractor and approved by the Illinois Department of Transportation and the Federal Highway Administration. The Illinois Department of Transportation and the Federal Highway Administration shall approve a program, if it is reasonably calculated to meet the equal employment opportunity obligations of the Contractor and to qualify the average trainee for journeyman status in the classification concerned by the end of the training period. Furthermore, apprenticeship programs registered with the U.S. Department of Labor, Bureau of Apprenticeship and Training, or with a State apprenticeship agency recognized by the Bureau and training programs approved by not necessarily sponsored by the U.S. Department of Labor Employment Training Administration shall also be considered acceptable provided it is being administered in a manner consistent with the equal employment obligations of Federal-aid highway construction contracts. Approval or acceptance of a training program shall be obtained from the State prior to commencing work on the classification covered by the program. It is the intention of these provisions that training is to be provided in the construction crafts rather than clerk-typists or secretarial-type positions. Training is permissible in lower level management positions such as office engineers, estimators, timekeepers, etc., where the training is oriented toward construction applications. Training in the laborer classification may be permitted provided that significant and meaningful training is provided and approved by the Illinois Department of Transportation and the Federal Highway Administration. Some offsite training is permissible as long as the training is an integral part of an approved training program and does not comprise a significant part of the overall training.

Except as otherwise noted below, the Contractor will be reimbursed 80 cents per hour of training given an employee on this contract in accordance with an approved training program. As approved by the Engineer, reimbursement will be made for training of persons in excess of the number specified herein. This reimbursement will be made even though the Contractor receives additional training program funds from other sources, provided such other source does not specifically prohibit the Contractor from receiving other reimbursement. Reimbursement for offsite training indicated above may only be made to the Contractor where he does one or more of the following and the trainees are concurrently employed on a Federal-aid project; contributes to the cost of the training, provides the instruction to the trainee or pays the trainee's wages during the offsite training period.

No payment shall be made to the Contractor if either the failure to provide the required training, or the failure to hire the trainee as a journeyman, is caused by the Contractor and evidences a lack of good faith on the part of the Contractor in meeting the requirement of this Training Special Provision. It is normally expected that a trainee will begin his training on the project as soon as feasible after start of work utilizing the skill involved and remain on the project as long as training opportunities exist in his work classification or until he has completed his training program.

It is not required that all trainees be on board for the entire length of the contract. A Contractor will have fulfilled his responsibilities under this Training Special Provision if he has provided acceptable training to the number of trainees specified. The number trained shall be determined on the basis of the total number enrolled on the contract for a significant period.

Trainees will be paid at least 60 percent of the appropriate minimum journeyman's rate specified in the contract for the first half of the training period, 75 percent for the third quarter of the training period, and 90 percent for the last quarter of the training period, unless apprentices or trainees in an approved existing program are enrolled as trainees on this project. In that case, the appropriate rates approved by the Departments of Labor or Transportation in connection with the existing program shall apply to all trainees being trained for the same classification who are covered by this Training Special Provision.

The Contractor shall furnish the trainee a copy of the program he will follow in providing the training. The Contractor shall provide each trainee with a certification showing the type and length of training satisfactorily complete.

The Contractor shall provide for the maintenance of records and furnish periodic reports documenting its performance under this Training Special Provision.

For contracts with an awarded contract value of \$500,000 or more, the Contractor is required to comply with the Illinois Works Apprenticeship Initiative (30 ILCS 559/20-20 to 20-25) and all applicable administrative rules to the extent permitted by Section 20-20(g). For federally funded projects, the number of trainees to be trained under this contract, as stated in the Training Special Provisions, will be the established goal for the Illinois Works Apprenticeship Initiative 30 ILCS 559/20-20(g). The Contractor shall make a good faith effort to meet this goal. For federally funded projects, the Illinois Works Apprenticeship Initiative will be implemented using the FHWA approved OJT procedures. The Contractor must comply with the recordkeeping and reporting obligations of the Illinois Works Apprenticeship Initiative for the life of the project, including the certification as to whether the trainee/apprentice labor hour goals were met.

Method of Measurement. The unit of measurement is in hours.

Basis of Payment. This work will be paid for at the contract unit price of 80 cents per hour for TRAINEES. The estimated total number of hours, unit price, and total price have been included in the schedule of prices.

20338

VEHICLE AND EQUIPMENT WARNING LIGHTS (BDE)

Effective: November 1, 2021

Revised: November 1, 2022

Add the following paragraph after the first paragraph of Article 701.08 of the Standard Specifications:

“The Contractor shall equip all vehicles and equipment with high-intensity oscillating, rotating, or flashing, amber or amber-and-white, warning lights which are visible from all directions. In accordance with 625 ILCS 5/12-215, the lights may only be in operation while the vehicle or equipment is engaged in construction operations.”

80439

WEEKLY DBE TRUCKING REPORTS (BDE)

Effective: June 2, 2012

Revised: November 1, 2021

The Contractor shall submit a weekly report of Disadvantaged Business Enterprise (DBE) trucks hired by the Contractor or subcontractors (i.e. not owned by the Contractor or subcontractors) that are used for DBE goal credit.

The report shall be submitted to the Engineer on Department form "SBE 723" within ten business days following the reporting period. The reporting period shall be Sunday through Saturday for each week reportable trucking activities occur.

Any costs associated with providing weekly DBE trucking reports shall be considered as included in the contract unit prices bid for the various items of work involved and no additional compensation will be allowed.

80302

WORK ZONE TRAFFIC CONTROL DEVICES (BDE)

Effective: March 2, 2020

Add the following to Article 701.03 of the Standard Specifications:

“(q) Temporary Sign Supports 1106.02”

Revise the third paragraph of Article 701.14 of the Standard Specifications to read:

“For temporary sign supports, the Contractor shall provide a FHWA eligibility letter for each device used on the contract. The letter shall provide information for the set-up and use of the device as well as a detailed drawing of the device. The signs shall be supported within 20 degrees of vertical. Weights used to stabilize signs shall be attached to the sign support per the manufacturer’s specifications.”

Revise the first paragraph of Article 701.15 of the Standard Specifications to read:

“**701.15 Traffic Control Devices.** For devices that must meet crashworthiness standards, the Contractor shall provide a manufacturer’s self-certification or a FHWA eligibility letter for each Category 1 device and a FHWA eligibility letter for each Category 2 and Category 3 device used on the contract. The self-certification or letter shall provide information for the set-up and use of the device as well as a detailed drawing of the device.”

Revise the first six paragraphs of Article 1106.02 of the Standard Specifications to read:

“**1106.02 Devices.** Work zone traffic control devices and combinations of devices shall meet crashworthiness standards for their respective categories. The categories are as follows.

Category 1 includes small, lightweight, channelizing and delineating devices that have been in common use for many years and are known to be crashworthy by crash testing of similar devices or years of demonstrable safe performance. These include cones, tubular markers, plastic drums, and delineators, with no attachments (e.g. lights). Category 1 devices manufactured after December 31, 2019 shall be MASH-16 compliant. Category 1 devices manufactured on or before December 31, 2019, and compliant with NCHRP 350 or MASH 2009, may be used on contracts let before December 31, 2024.

Category 2 includes devices that are not expected to produce significant vehicular velocity change but may otherwise be hazardous. These include vertical panels with lights, barricades, temporary sign supports, and Category 1 devices with attachments (e.g. drums with lights). Category 2 devices manufactured after December 31, 2019 shall be MASH-16 compliant. Category 2 devices manufactured on or before December 31, 2019, and compliant with NCHRP 350 or MASH 2009, may be used on contracts let before December 31, 2024.

Category 3 includes devices that are expected to cause significant velocity changes or other potentially harmful reactions to impacting vehicles. These include crash cushions (impact

attenuators), truck mounted attenuators, and other devices not meeting the definitions of Category 1 or 2. Category 3 devices manufactured after December 31, 2019 shall be MASH-16 compliant. Category 3 devices manufactured on or before December 31, 2019, and compliant with NCHRP 350 or MASH 2009, may be used on contracts let before December 31, 2029. Category 3 devices shall be crash tested for Test Level 3 or the test level specified.

Category 4 includes portable or trailer-mounted devices such as arrow boards, changeable message signs, temporary traffic signals, and area lighting supports. It is preferable for Category 4 devices manufactured after December 31, 2019 to be MASH-16 compliant; however, there are currently no crash tested devices in this category, so it remains exempt from the NCHRP 350 or MASH compliance requirement.

For each type of device, when no more than one MASH-16 compliant is available, an NCHRP 350 or MASH-2009 compliant device may be used, even if manufactured after December 31, 2019.”

Revise Articles 1106.02(g), 1106.02(k), and 1106.02(l) to read:

“(g) Truck Mounted/Trailer Mounted Attenuators. The attenuator shall be approved for use at Test Level 3. Test Level 2 may be used for normal posted speeds less than or equal to 45 mph.

(k) Temporary Water Filled Barrier. The water filled barrier shall be a lightweight plastic shell designed to accept water ballast and be on the Department’s qualified product list.

Shop drawings shall be furnished by the manufacturer and shall indicate the deflection of the barrier as determined by acceptance testing; the configuration of the barrier in that test; and the vehicle weight, velocity, and angle of impact of the deflection test. The Engineer shall be provided one copy of the shop drawings.

(l) Movable Traffic Barrier. The movable traffic barrier shall be on the Department’s qualified product list.

Shop drawings shall be furnished by the manufacturer and shall indicate the deflection of the barrier as determined by acceptance testing; the configuration of the barrier in that test; and the vehicle weight, velocity, and angle of impact of the deflection test. The Engineer shall be provided one copy of the shop drawings. The barrier shall be capable of being moved on and off the roadway on a daily basis.”

80427

WORKING DAYS (BDE)

Effective: January 1, 2002

The Contractor shall complete the work within **30** working days.

80071

STATE OF ILLINOIS
DEPARTMENT OF TRANSPORTATION
PLANS FOR PROPOSED
FEDERAL AID HIGHWAY
SURFACE TRANSPORTATION PROGRAM
FAS 95 / CH 5 / GLIDDEN ROAD
ILLINOIS 64 TO ILLINOIS 72
SECTION 19-00088-02-RS
PROJECT LC6S(734)
DEKALB COUNTY
C-93-012-24

| ROUTE NO. | SECTION | TOTAL SHEETS | SHEET NO. |
|----------------|----------------|--------------------------|-----------|
| FAS 95 | 19-00088-02-RS | 9 | 1 |
| Contract 87825 | DEKALB COUNTY | FED. AID PROJ. LC6S(734) | |

INDEX OF SHEETS

- 1 Cover Sheet
- 2 Location Map
- 3 Summary of Quantities
- 4 HMA Mixtures Table
- 5 Schedule of Quantities
- 6-7 Typical Section
- 8 Butt Joint Details
- 9 Typical Entrance Details

HIGHWAY STANDARDS

- 701201-05 701901-09
- 701301-04 780001-05
- 701306-04 BLR 24-2
- 701311-03

FAS 95 (Glidden Rd)
GROSS LENGTH = 34,453 ft (6.525 mi)
NET LENGTH = 33,658 ft (6.375 mi)
OMIT: SN 019-3049, SN 019-3052, AND
STA 230+02 TO 237+17 (SOUTH LEG OF BASE LINE RD)

ROAD, FUNCTIONAL CLASS, CURRENT ADT, DESIGN ADT, DESIGN SPEED
GLIDDEN ROAD, MAJOR COLLECTOR, 3550 (2021), 4325 (2031), 45 MPH



LOCATION OF SECTION INDICATED THUS:



PRINTED BY THE AUTHORITY
OF THE STATE OF ILLINOIS

PASSED

APRIL 12, 2024

DISTRICT 3 ENGINEER OF LOCAL ROADS & STREETS

RELEASING FOR
BID BASED ON
LIMITED REVIEW

Trisha Thompson 4/12/2024
REGION 2 ENGINEER

P.E.

Walter K. [Signature]
COUNTY ENGINEER

DATE:

04/09/2024

License #

Expires 11-30-2025



Glidden Road Resurfacing
 Illinois Route 64 to Illinois Route 72
 Location Map

| ROUTE NO. | SECTION | TOTAL SHEETS | SHEET NO. |
|-------------------|------------------|-----------------------------|-----------|
| FAS 95 | 19-00088-02-RS | 9 | 2 |
| CONTRACT 87825 | DEKALB COUNTY | FED. AID PROJ. LC6S(734) | |

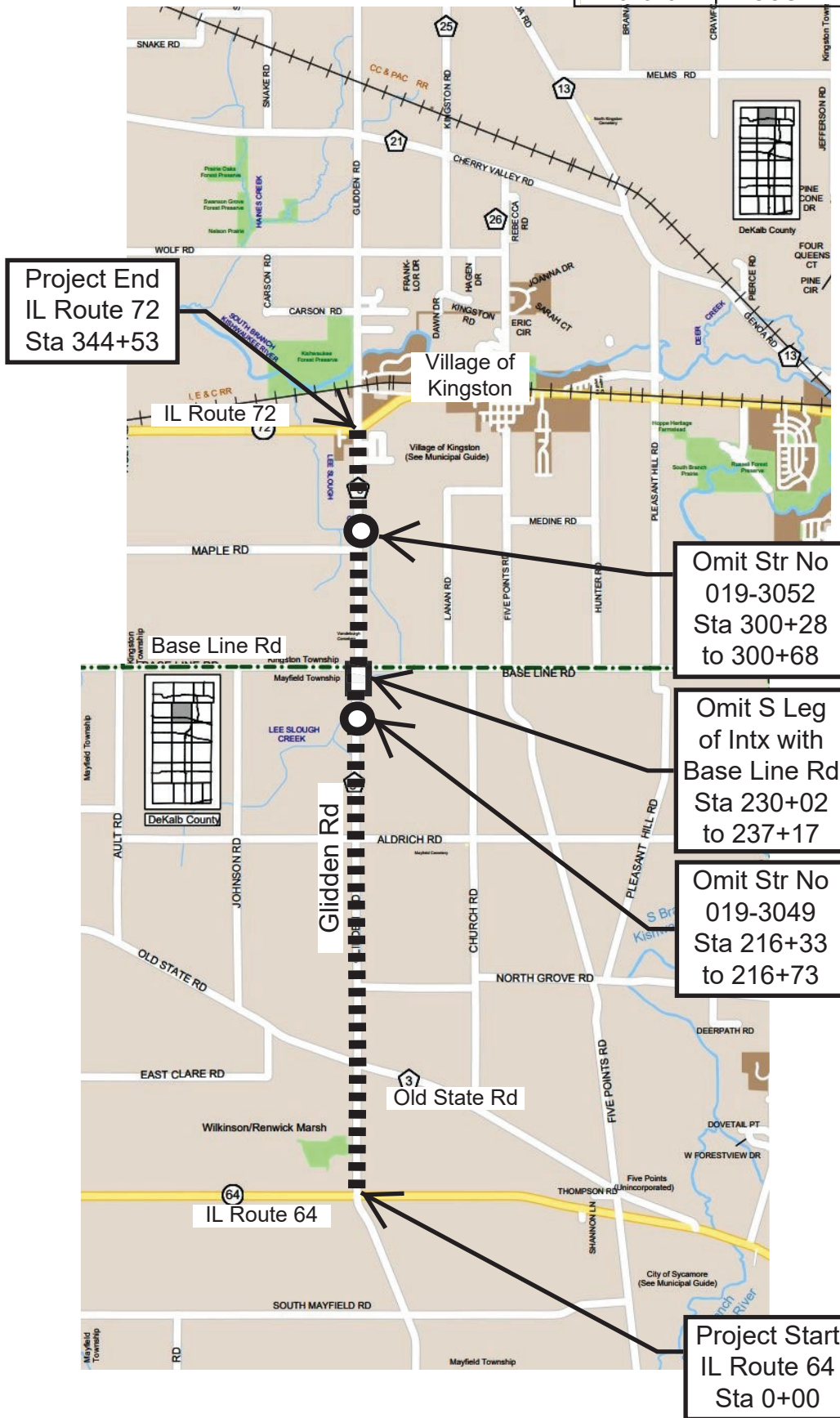

| ROUTE NO. | SECTION | TOTAL SHEETS | SHEET NO. |
|----------------|----------------|--------------------------|-----------|
| FAS 95 | 19-00088-02-RS | 9 | 3 |
| CONTRACT 87825 | DEKALB COUNTY | FED. AID PROJ. LC6S(734) | |

**CONSTRUCTION TYPE CODE 0005
SUMMARY OF QUANTITIES**

| | | | |
|-----------|--|-------|---------|
| 40600290 | Bituminous Materials (Tack Coat) | Lb | 52,838 |
| 40600370* | Longitudinal Joint Sealant | Ft | 33,658 |
| 40600982 | Hot-Mix Asphalt Surface Removal - Butt Joint | SY | 1,498 |
| 40603080 | Hot-Mix Asphalt Binder Course, IL-19.0, N50 | Ton | 17,004 |
| 40604050 | Hot-Mix Asphalt Surface Course, IL-9.5, Mix "C", N50 | Ton | 10,812 |
| 48101200 | Aggregate Shoulders, Type B | Ton | 4,264 |
| 67100100 | Mobilization | L Sum | 1 |
| 70300100 | Short Term Pavement Marking | Ft | 6,892 |
| 70300150 | Short Term Pavement Marking Removal | SF | 2,297 |
| 78001110* | Paint Pavement Marking - Line 4" | Ft | 187,732 |
| 78001180* | Paint Pavement Marking - Line 24" | Ft | 60 |
| X4823105 | Hot-Mix Asphalt Shoulders, Special | Ton | 3,401 |
| X7010216 | Traffic Control & Protection, (Special) | L Sum | 1 |
| Z0034105 | Material Transfer Device | Ton | 27,816 |
| #Z0076600 | Trainees | Hour | 1,000 |
| #Z0076604 | Trainees Training Program Graduate | Hour | 1,000 |

* Specialty Items

0042

Quantities are estimate prepared for the establishment of pay item prices and are the responsibility of the contractor to confirm prior to bidding. Quantities may be increased, decreased, or omitted to satisfactorily complete the project.

APPLICATION RATES

| | |
|---|---|
| Bituminous Materials (Tack Coat) Type of Surface to be Primed | Residual Asphalt Rate lb/sq ft (kg/sq m) |
| Milled HMA, Aged Non-Milled HMA, Milled Concrete, Non-Milled Concrete & Tined Concrete | 0.05 (0.244) |
| Fog Coat between HMA Lifts, IL-4.75 & Brick | 0.025 (0.122) |

APPLICATION RATES

| | |
|--------------------|----------------|
| Granular Materials | 2.05 tons / CY |
|--------------------|----------------|

SHORT TERM PAVEMENT MARKING

| |
|---|
| 4 ft. in length and a minimum of 4 in. wide at a maximum spacing of 40 ft between stripes |
|---|

PAINT PAVEMENT MARKING

| |
|---|
| Two applications of paint shall be placed with the first application being allowed to dry prior to placing the second application over the first. The Contractor shall not place one thick application in lieu of two regular applications. Each application shall be measured for payment. |
|---|

LONGITUDINAL JOINT SEALANT

| |
|--|
| Application rate shall be per Article 406 of the Standard Specifications for Road and Bridge Construction. |
|--|

| | | | |
|----------------|----------------|--------------------------|-----------|
| ROUTE NO. | SECTION | TOTAL SHEETS | SHEET NO. |
| FAS 95 | 19-00088-02-RS | 9 | 4 |
| CONTRACT 87825 | DEKALB COUNTY | FED. AID PROJ. LC6S(734) | |

HMA MIXTURES TABLE

| | | | |
|--|--------------------|--------------------|-----------------------------|
| LOCATIONS: | ENTIRE PROJECT | ENTIRE PROJECT | ENTIRE PROJECT |
| MIXTURE USE(S): | HMA BINDER | HMA SURFACE | HMA SHOULDERS (BOTTOM LIFT) |
| BINDER GRADE (PG): | PG 64-22 | PG 64-22 | PG 64-22 |
| DESIGN AIR VOIDS: | 4.0% @ N50 | 4.0% @ N50 | 4.0% @ N50 |
| MIXTURE COMPOSITION: (MIXTURE GRADATION) | IL 19.0 | IL 9.5 | IL 19.0 |
| FRICITION AGGREGATE: | | MIXTURE C | |
| MIXTURE WEIGHT: | 112.0 LB / SY / IN | 112.0 LB / SY / IN | 112.0 LB / SY / IN |
| QUALITY MANAGEMENT PROGRAM: | QCQA | QCQA | QCQA |
| SUBLOT SIZE: | NA | NA | NA |
| DENSITY TEST METHOD: | CORES/NUCLEAR | CORES/NUCLEAR | CORES/NUCLEAR |
| MATERIAL TRANSFER DEVICE (REQUIRED): | YES | YES | NO |

STRUCTURAL PAVEMENT DESIGN INFORMATION

Glidden Road

| | |
|----------------------------|---|
| Current ADT (2021) = 3,550 | Design Traffic ADT (2031) = 3,808 Passenger (88%); 303 SU (7%), 216 MU (5%) |
| Traffic Factor = 1.17 | Existing Pavement = 11" Aggregate + 5.5" HMA |
| Structural Number = 4.4 | Proposed Pavement = 11" Aggregate + 9.5" HMA |

**CONSTRUCTION TYPE CODE 0005
SCHEDULE OF QUANTITIES**

| | | | |
|----------------|----------------|--------------------------|-----------|
| ROUTE NO. | SECTION | TOTAL SHEETS | SHEET NO. |
| FAS 95 | 19-00088-02-RS | 9 | 5 |
| Contract 87825 | DEKALB COUNTY | FED. AID PROJ. LC6S(734) | |

| | | |
|-----------------|-------------------|-------------------|
| <u>Location</u> | <u>From</u> | <u>To</u> |
| Glidden Road | Illinois Route 64 | Illinois Route 72 |

| <u>Hot Mix Material</u> | <u>Asphalt Thickness</u> | <u>Length</u> | <u>Width</u> | <u>Area</u> |
|------------------------------|--------------------------|---------------|--------------|--------------|
| HMA BC, IL 19.0, N50 | 2.5 in | 33,658 ft | 24 ft | 89,755 sq yd |
| HMA SC, IL 9.5, Mix "C", N50 | 1.5 in | 33,658 ft | 24 ft | 89,755 sq yd |

Additional Paving Areas

| <u>Area Type</u> | <u>Number of areas</u> | <u>Estimated Area</u> | <u>Additional Total Area</u> |
|---------------------|------------------------|-----------------------|------------------------------|
| Driveway | 35 | 45 sq yd | 1575 sq yd |
| Oversized Driveway | 0 | 90 sq yd | 0 sq yd |
| Sideroads | 10 | 200 sq yd | 2000 sq yd |
| Oversized Sideroads | 0 | 400 sq yd | 0 sq yd |
| Turn Lanes | 0 | n/a sq yd | 0 sq yd |

Schedule of Quantities

| <u>Pay Item</u> | <u>Unit</u> | <u>Quantity</u> |
|--|-------------|-----------------|
| Bituminous Materials (Tack Coat) | Pound | 52,838 |
| Longitudinal Joint Sealant | Ft | 33,658 |
| Hot-Mix Asphalt Surface Removal - Butt Joint | Sq Yd | 1,498 |
| Hot-Mix Asphalt Binder Course, IL 19.0, N50 | Ton | 17,004 |
| Hot-Mix Asphalt Surface Course, IL 9.5, Mix "C", N50 | Ton | 10,812 |
| Aggregate Shoulders, Type B | Ton | 4,264 |
| Short Term Pavement Marking | Foot | 6,892 |
| Short Term Pavement Marking Removal | Sq Ft | 2,297 |
| Paint Pavement Marking - Line 4" | Ft | 187,732 |
| Paint Pavement Marking - 24" | Ft | 60 |
| Hot-Mix Asphalt Shoulders, Special | Ton | 3,401 |
| Material Transfer Device | Ton | 27,816 |

Two applications of paint shall be placed with the first application being allowed to dry prior to placing the second application over the first. The Contractor shall not place one thick application in lieu of two regular applications.

Quantities are estimate prepared for the establishment of pay item prices and are the responsibility of the contractor to confirm prior to bidding. Quantities may be increased, decreased, or omitted to satisfactorily complete the project.

EXISTING TYPICAL SECTION

Glidden Road

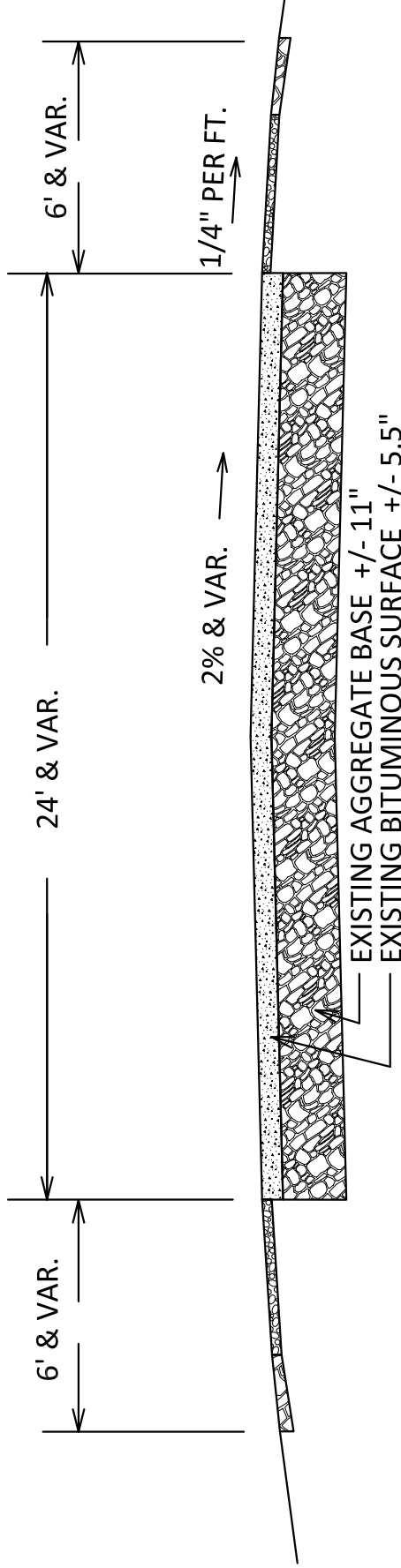

SECTION 19-00088-02-RS

STATION 0+00 TO STATION 344+53

(ILLINOIS ROUTE 64 TO ILLINOIS ROUTE 72)

| | | | |
|----------------|----------------|---------------------------|-----------|
| ROUTE NO. | SECTION | TOTAL SHEETS | SHEET NO. |
| FAS 95 | 19-00088-02-RS | 9 | 6 |
| CONTRACT 87825 | DEKALB COUNTY | FED. AID. PROJ. LC6S(734) | |

PROPOSED TYPICAL SECTION

Glidden Road

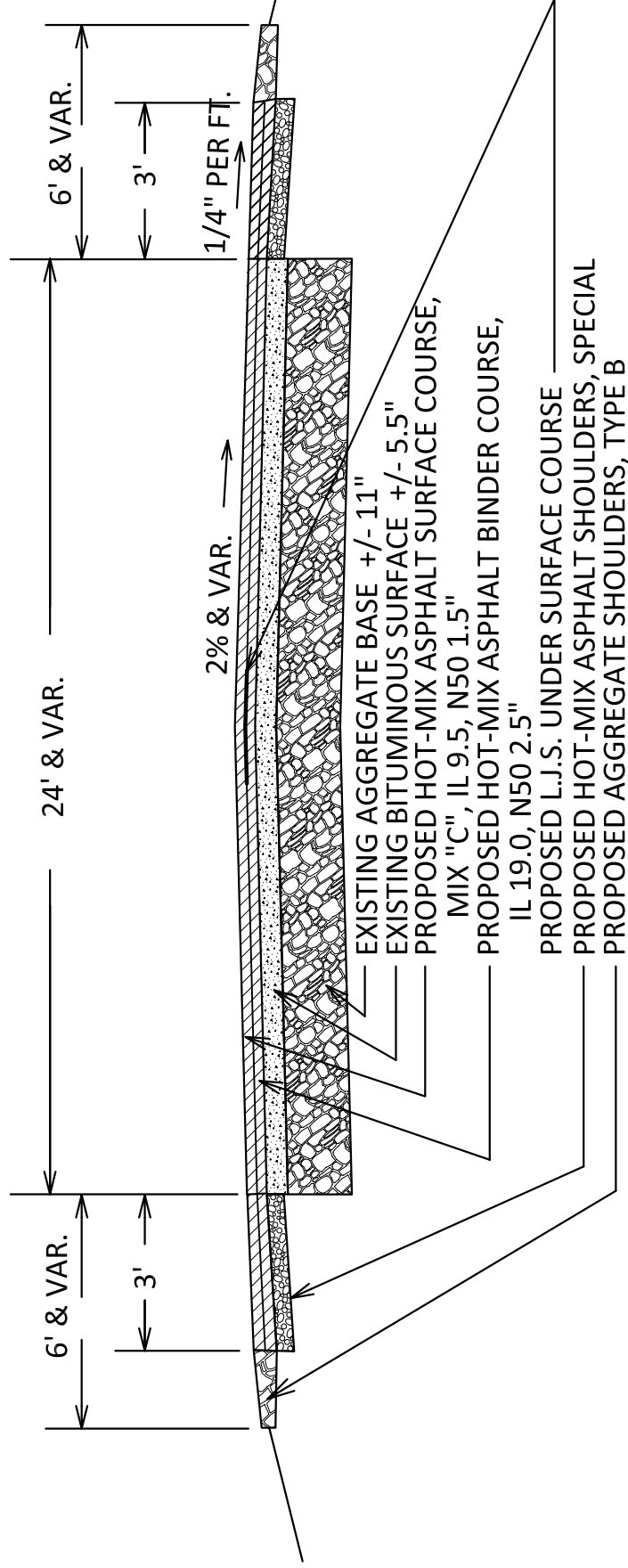

SECTION 19-00088-02-RS

STATION 0+00 TO STATION 344+53
 (ILLINOIS ROUTE 64 TO ILLINOIS ROUTE 72)
 (OMIT SN 019-3049, STA 216+33 TO 216+73, AND SN 019-3052, STA 300+28 TO 300+66
 AND SOUTH LEG OF INTERSECTION WITH BASE LINE ROAD, STA 230+02 TO 237+17)

| | | | |
|----------------|----------------|---------------------------|-----------|
| ROUTE NO. | SECTION | TOTAL SHEETS | SHEET NO. |
| FAS 95 | 19-00088-02-RS | 9 | 7 |
| CONTRACT 87825 | DEKALB COUNTY | FED. AID. PROJ. LC6S(734) | |

BUTT JOINT DETAIL

GLIDDEN ROAD

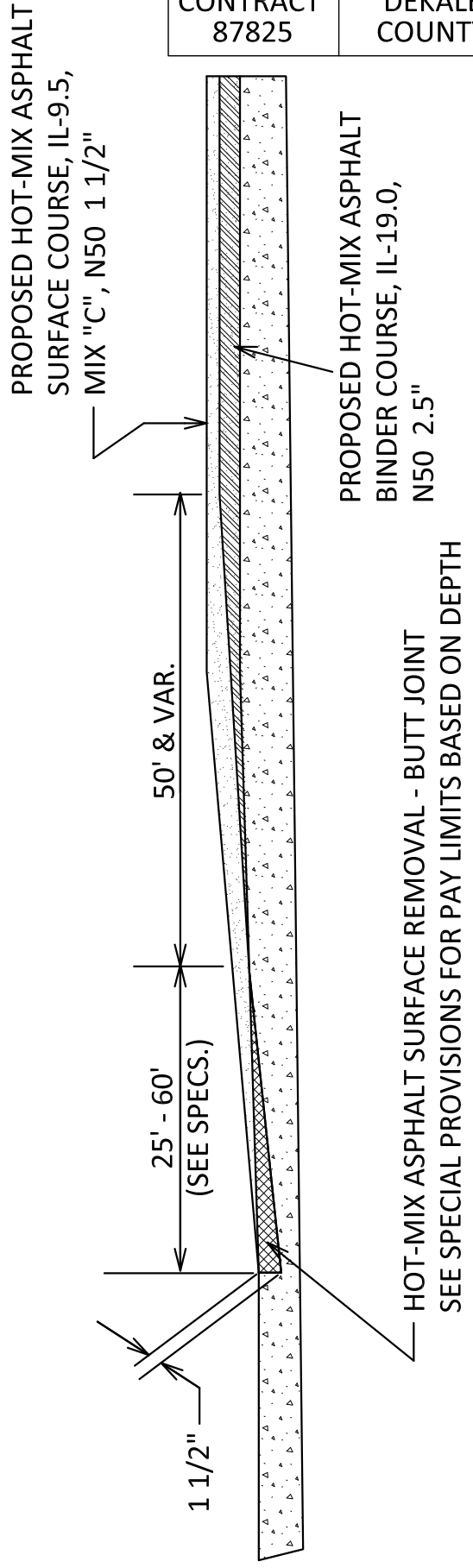

| | | | |
|----------------|----------------|---------------------------|-----------|
| ROUTE NO. | SECTION | TOTAL SHEETS | SHEET NO. |
| FAS 95 | 19-00088-02-RS | 9 | 8 |
| CONTRACT 87825 | DEKALB COUNTY | FED. AID. PROJ. LC6S(734) | |

SECTION 19-00088-02-RS

ENTRANCE DETAIL

GLIDDEN ROAD

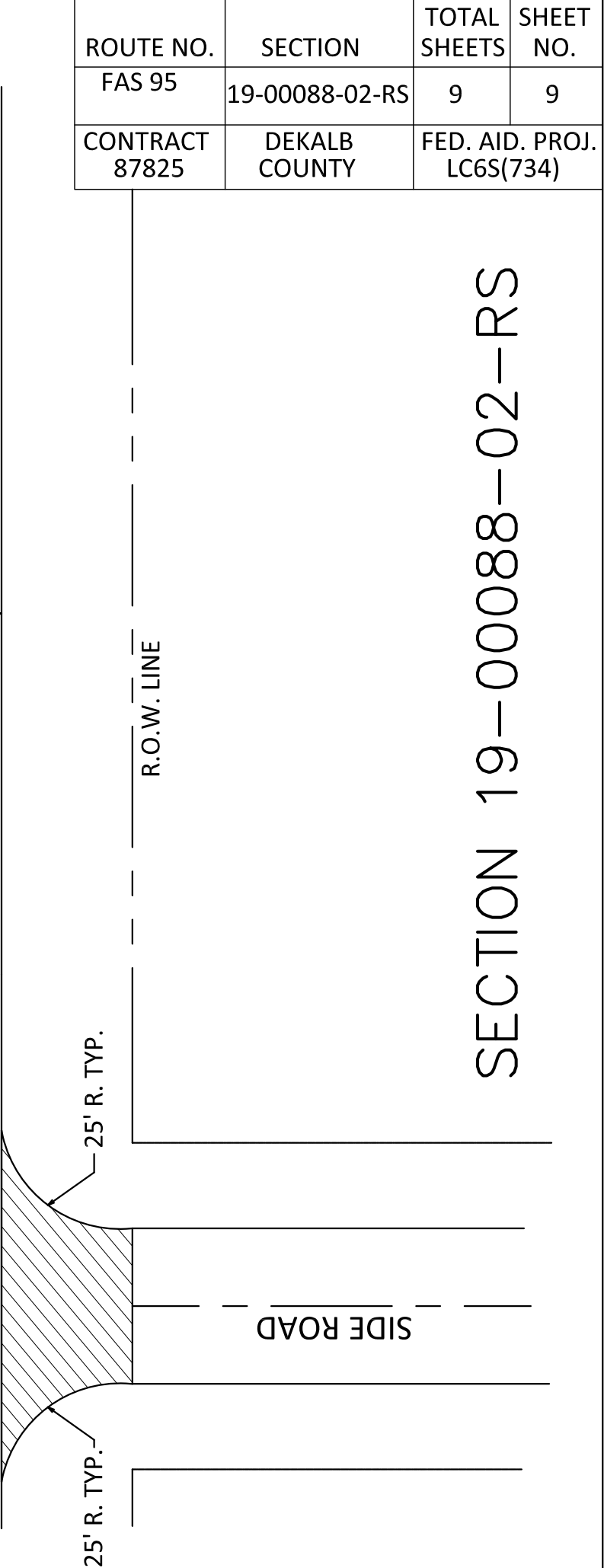
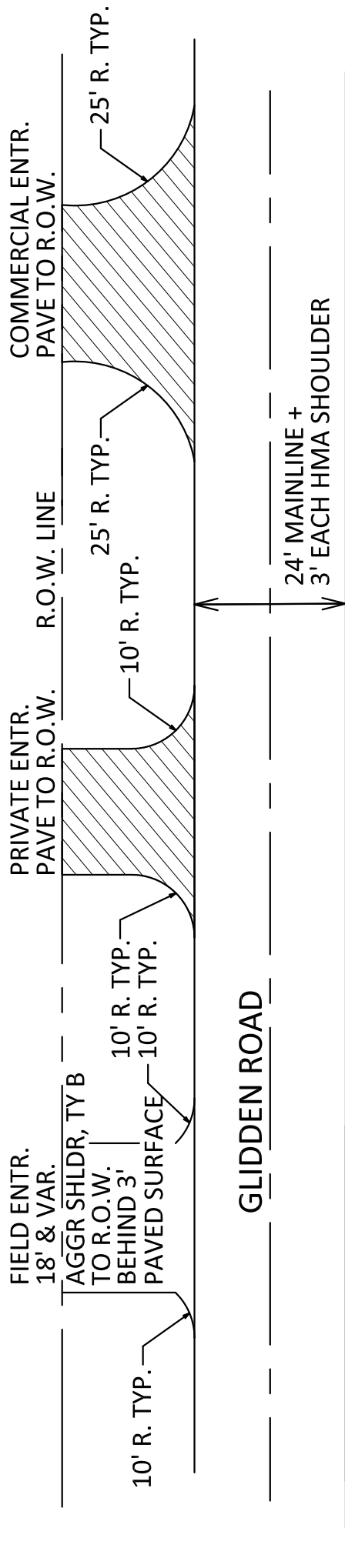

| | | | |
|----------------|----------------|---------------------------|-----------|
| ROUTE NO. | SECTION | TOTAL SHEETS | SHEET NO. |
| FAS 95 | 19-00088-02-RS | 9 | 9 |
| CONTRACT 87825 | DEKALB COUNTY | FED. AID. PROJ. LC6S(734) | |

SECTION 19-00088-02-RS

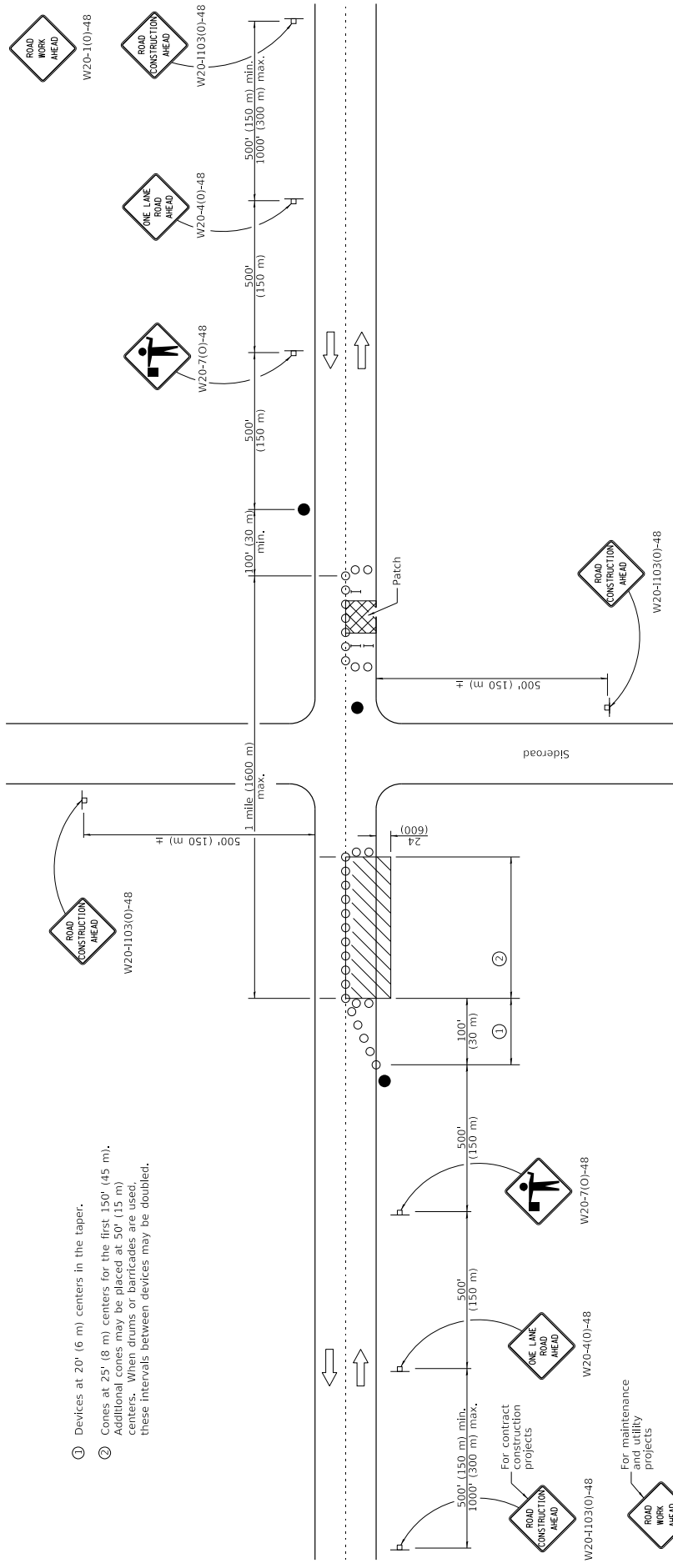

- ① Devices at 20' (6 m) centers in the taper.
- ② Cones at 25' (8 m) centers for the first 150' (45 m). Additional cones may be placed at 50' (15 m) centers. When drums or barricades are used, these intervals between devices may be doubled.

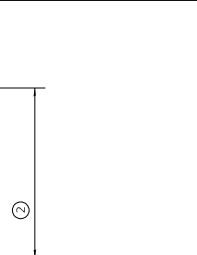

GENERAL NOTES

This Standard is used where at any time, any vehicles, equipment, workers or their activities will encroach in the area between the center line and a line 24' (600') outside the edge of pavement for daylight operation.

When the distance between successive work areas exceeds 2000' (600 m), additional warning signs, flaggers, and taper shall be placed as shown.

All dimensions are in inches (millimeters) unless otherwise shown.

SYMBOLS

- Work area
- Sign
- Barricade or drum
- Cone, drum or barricade
- Flagger with traffic control sign

TYPICAL APPLICATIONS

- Isolated patching
- Utility operations
- Storm sewer
- Culverts
- Cable placement

| DATE | REVISIONS |
|--------|----------------------------------|
| 1-1-19 | Revised device spacing in taper. |
| 1-1-11 | Revised flagger sign. |

**LANE CLOSURE, 2L, 2W,
DAY ONLY,
FOR SPEEDS ≥ 45 MPH
STANDARD 701201-05**

Illinois Department of Transportation

ISSUED 1-1-97

APPROVED January 1, 2019

 ENGINEER OF SAFETY PROGRAM AND ENGINEERING

APPROVED January 1, 2019

 ENGINEER OF DESIGN AND ENVIRONMENT

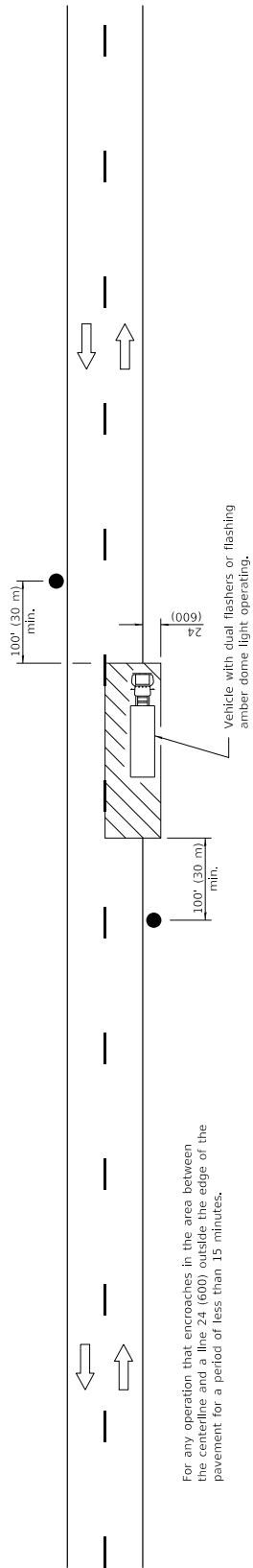

For any operation that encroaches in the area between the centerline and a line 24 (600) outside the edge of the pavement for a period of less than 15 minutes.

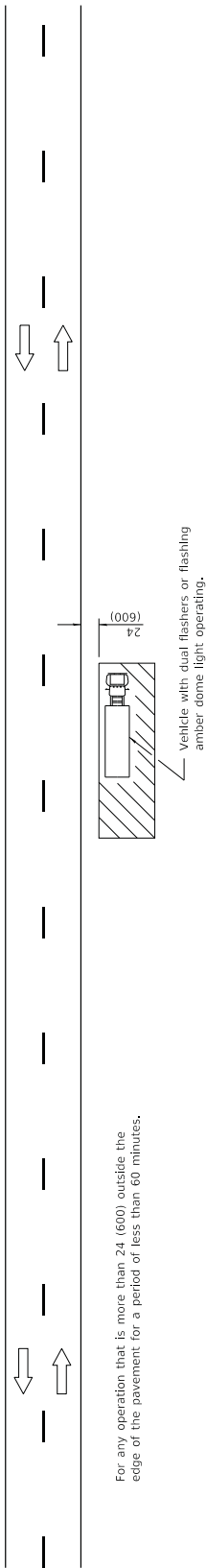

For any operation that is more than 24 (600) outside the edge of the pavement for a period of less than 60 minutes.

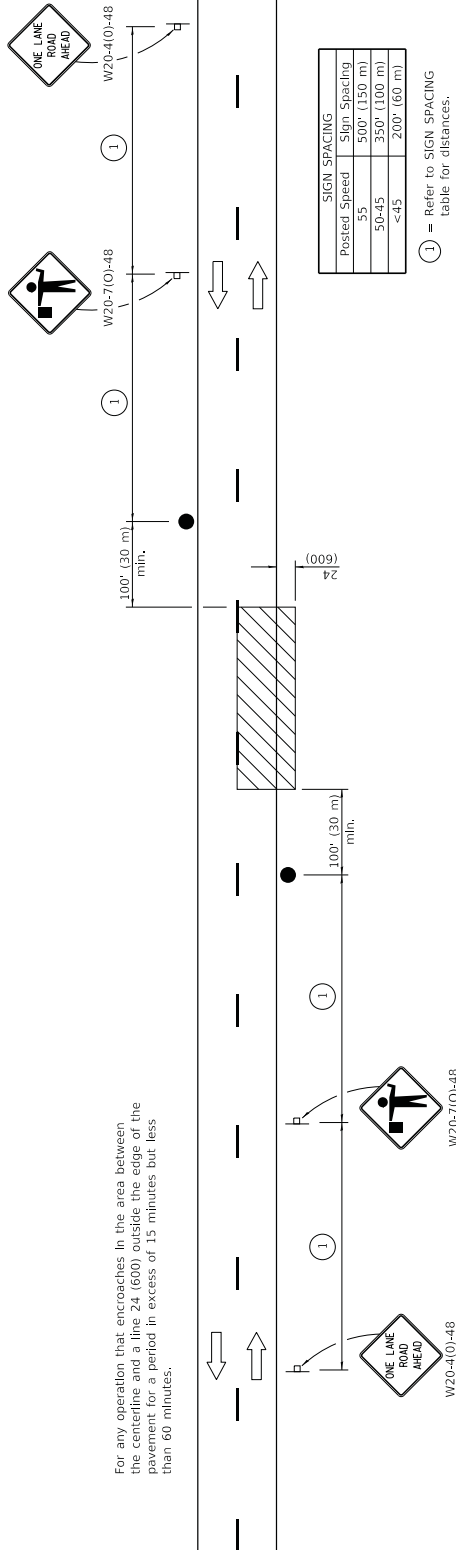

For any operation that encroaches in the area between the centerline and a line 24 (600) outside the edge of the pavement for a period in excess of 15 minutes but less than 60 minutes.

All dimensions are in inches (millimeters) unless otherwise shown.

| DATE | REVISIONS |
|--------|-------------------------------------|
| 1-1-11 | Revised flagger sign. |
| 1-1-09 | Switched units to English (metric). |

LANE CLOSURE, 2L, 2W, SHORT TIME OPERATIONS

STANDARD 701301-04

SYMBOLS

- Work area
- Sign on portable or permanent support
- Flagger with traffic control sign

TYPICAL APPLICATIONS

- Marking patches
- Field survey
- String line
- Utility operations
- Cleaning up debris on pavement

Illinois Department of Transportation
 PASSED January 1, 2011
 APPROVED January 1, 2011
 ENGINEER OF SAFETY ENGINEERING
 ENGINEER OF DESIGN AND ENVIRONMENT

ISSUED 1-1-07

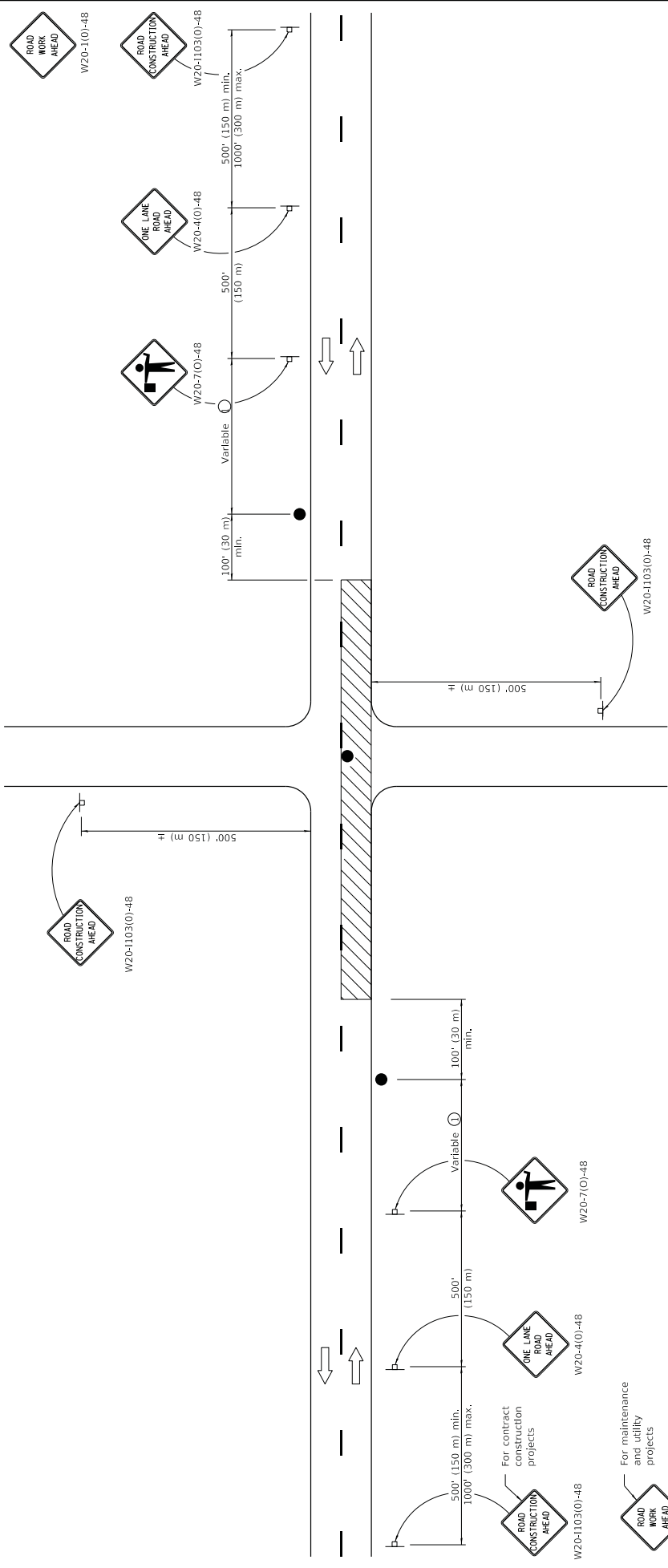

GENERAL NOTES

This Standard is used where at any time, any vehicle, equipment, workers or their activities require an intermittent or continuous moving operation on the pavement where the average speed of movement is greater than 1/2 mph (1 km/h) and less than 4 mph (6 km/h).

When the operation does not exceed 60 minutes, traffic control may be according to Standard 701301.

All dimensions are in inches (millimeters) unless otherwise shown.

① Minimum distance is 200' (60 m). Maximum distance to be determined by the Engineer but should not exceed 1/2 the length required for one normal working days' operation or 2 miles (3200 m), whichever is less.

TYPICAL APPLICATIONS

- Bituminous resurfacing
- Milling operations
- Utility operations
- Shoulder operations

For maintenance and utility projects

SYMBOLS

- Work area
- Sign on portable or permanent support
- Flagger with traffic control sign

| DATE | REVISIONS |
|--------|---|
| 1-1-18 | Revised lower speed limit for operation to 1/2 mph. |
| 1-1-11 | Revised flagger sign. |

LANE CLOSURE, 2L, 2W, SLOW MOVING OPERATIONS DAY ONLY, FOR SPEEDS ≥ 45 MPH

STANDARD 701306-04

Illinois Department of Transportation

PASSED January 1, 2018
 ENGINEER OF SAFETY PROJECTS AND ENGINEERING
 APPROVED January 1, 2018
 ENGINEER OF DESIGN AND ENVIRONMENT

ISSUED 1-1-97

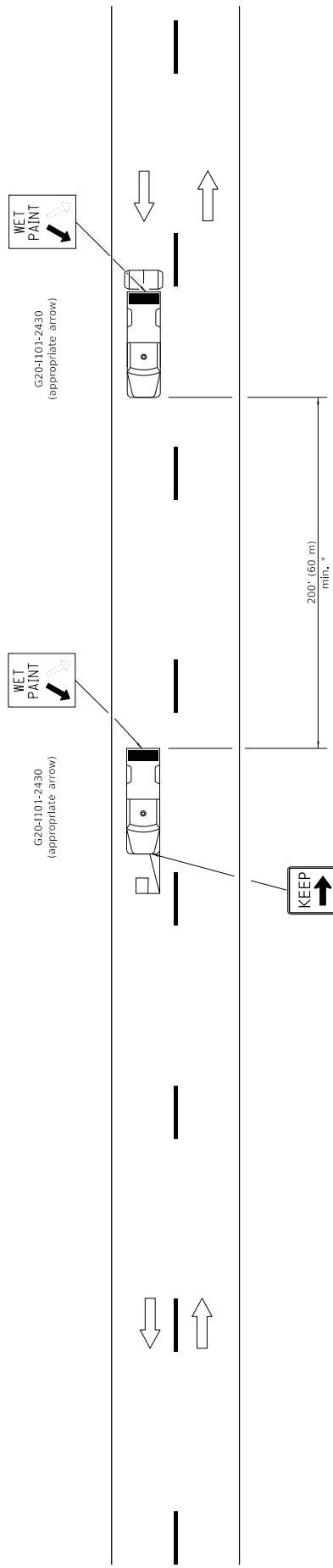

G20-1101-2430
(appropriate arrow)

G20-1101-2430
(appropriate arrow)

KEEP RIGHT
R4-7a-2430

200' (60 m)
min.*

* Distance varies depending on terrain and susceptibility of pavement marking or crack sealant to wheel tracking.

TYPICAL APPLICATIONS

- Landscape work
- Utility work
- Pavement marking
- Weed spraying
- Roadmeter measurements
- Debris cleanup
- Crack pouring

SYMBOLS

- Arrow board (Hazard Mode only)
- Truck with headlights, emergency flashers and flashing amber light, (visible from all directions)
- 18x18 (450x450) min., orange flag (use when guide wheel is used)
- Truck mounted attenuator

GENERAL NOTES

This Standard is used where any vehicle, equipment, workers or their activities will require a continuous moving operation where the average speed is greater than 3 mph (5 km/h).

For shoulder operations not encroaching on the pavement, use DETAIL A, Standard 701426.

All dimensions are in inches (millimeters) unless otherwise shown.

| DATE | REVISIONS |
|--------|--|
| 1-1-09 | Switched units to English (metric). Omitted Pass With Care sign. |
| 1-1-00 | Elim. speed restrictions in Standard title. |

LANE CLOSURE 2L, 2W MOVING OPERATIONS- DAY ONLY

STANDARD 701311-03

Illinois Department of Transportation
 PASSED January 1, 2009
 ENGINEER OF OPERATIONS
 APPROVED January 1, 2009
 ENGINEER OF DESIGN AND ENVIRONMENT

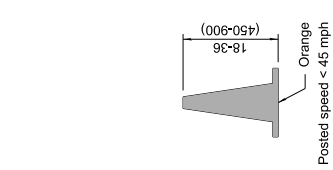
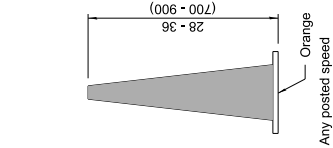
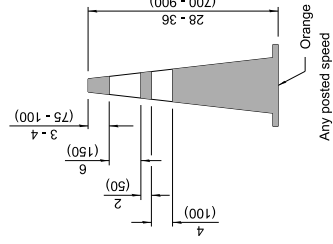

DAYTIME USE
Orange
Posted speed < 45 mph

Orange
Any posted speed

CONES

DAY OR NIGHTTIME USE

Orange
Any posted speed

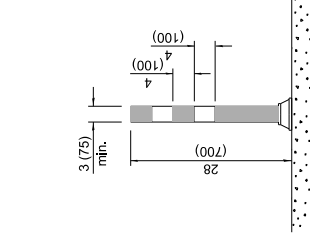

TUBULAR MARKER

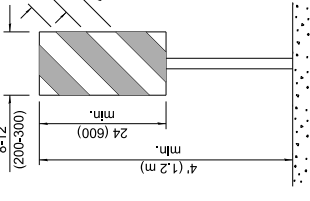

**VERTICAL PANEL
POST MOUNTED**

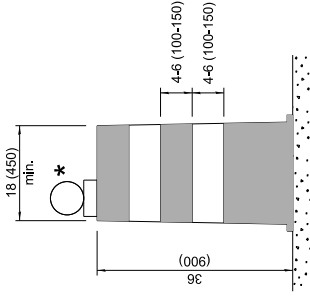

DRUM

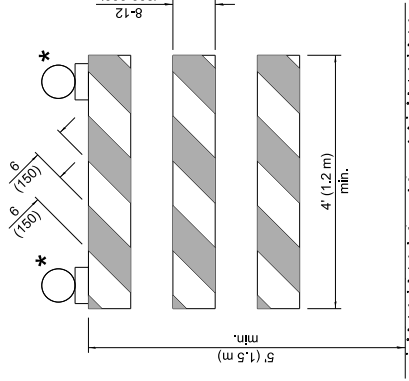

TYPE III BARRICADE

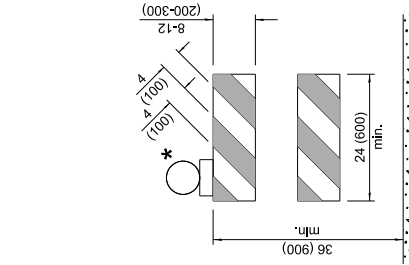

TYPE II BARRICADE

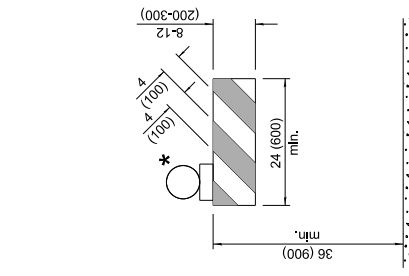

TYPE I BARRICADE

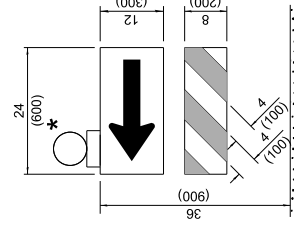

**DIRECTION INDICATOR
BARRICADE**

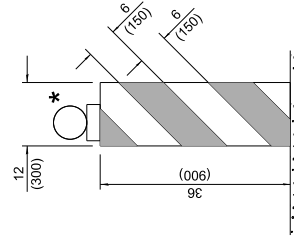

VERTICAL BARRICADE

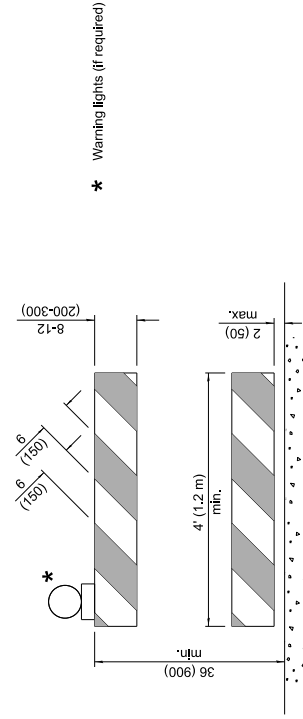

**DETECTABLE PEDESTRIAN
CHANNELIZING BARRICADE**

* Warning lights (if required)

GENERAL NOTES

All heights shown shall be measured above the pavement surface.
All dimensions are in inches (millimeters) unless otherwise shown.

| DATE | REVISIONS |
|--------|--|
| 1-1-24 | Revised Type III Barricade notes (Sht. 3) & moved warning light on post mounted signs to top center. |
| 1-1-19 | Revised cones usage and added cones > 36" (900mm) height. |

Illinois Department of Transportation
 PASSED JEROME L. JEROME L. 2024
 ENGINEER OF SAFETY PROGRAMS AND ENGINEERING
 APPROVED JEROME L. JEROME L. 2024
 ENGINEER OF DESIGN AND ENVIRONMENT

**TRAFFIC CONTROL
DEVICES**
STANDARD 701901-09

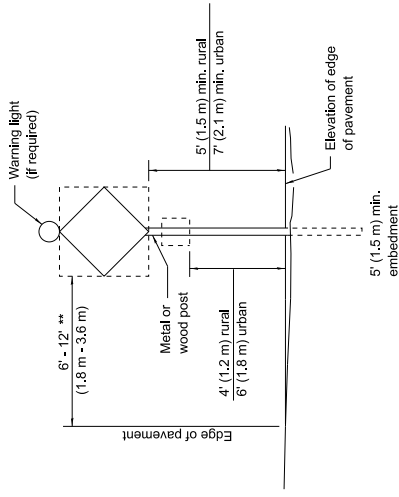

POST MOUNTED SIGNS

** When curb or paved shoulder are present this dimension shall be 24 (600) to the face of curb or 6' (1.8 m) to the outside edge of the paved shoulder.

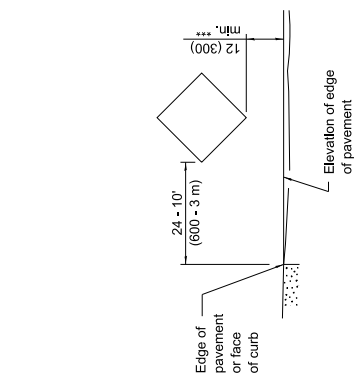

SIGNS ON TEMPORARY SUPPORTS

*** When work operations exceed four days, this dimension shall be 5' (1.5 m) min. If located behind other devices, the height shall be sufficient to be seen completely above the devices.

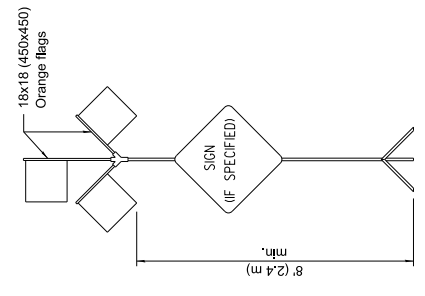

HIGH LEVEL WARNING DEVICE

ROAD CONSTRUCTION NEXT X MILES
G20-1104(0)-6036

END CONSTRUCTION
G20-1105(0)-6024

This signing is required for all projects 2 miles (3200 m) or more in length.
ROAD CONSTRUCTION NEXT X MILES sign shall be placed 500' (150 m) in advance of project limits.
END CONSTRUCTION sign shall be erected at the end of the job unless another job is within 2 miles (3200 m).
Dual sign displays shall be utilized on multi-lane highways.

WORK LIMIT SIGNING

| | |
|--------------------|---------------------|
| WORK ZONE | W21-1115(0)-3618 |
| SPEED LIMIT | R2-1-3648 |
| XX | R10-1108p-3618 **** |
| PHOTO ENFORCED | |
| \$XXX FINE MINIMUM | R2-1106p-3618 |

Sign assembly as shown on Standards or as allowed by District Operations.

| | |
|---------------------------|---------------|
| END WORK ZONE SPEED LIMIT | G20-1103-6036 |
|---------------------------|---------------|

This sign shall be used when the above sign assembly is used.

HIGHWAY CONSTRUCTION SPEED ZONE SIGNS

**** R10-1108p shall only be used along roadways under the jurisdiction of the State.

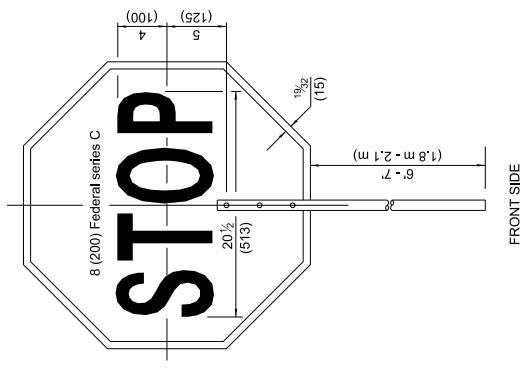

FRONT SIDE

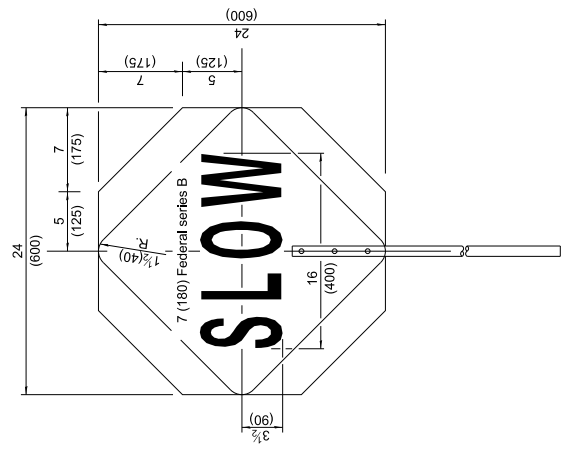

REVERSE SIDE

| | |
|-----------|-----------|
| MAX WIDTH | XX' - XX' |
| X MILES | A HEAD |

W12-1103-4646

WIDTH RESTRICTION SIGN

XX-XX' width and X miles are variable.

ILLINOIS Department of Transportation

PASSED: JEREMUD.L 2024
 ENGINEER OF SAFETY PROGRAMS AND ENGINEERING

APPROVED: JEREMUD.L 2024
 ENGINEER OF DESIGN AND ENVIRONMENT

ISSUED: 1-1-13

FLAGGER TRAFFIC CONTROL SIGN

TRAFFIC CONTROL DEVICES

(Sheet 2 of 3)

STANDARD 701901-09

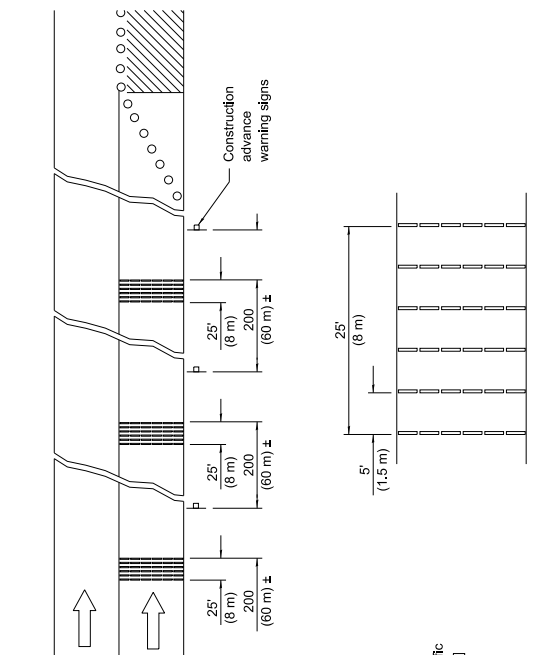

TYPICAL INSTALLATION

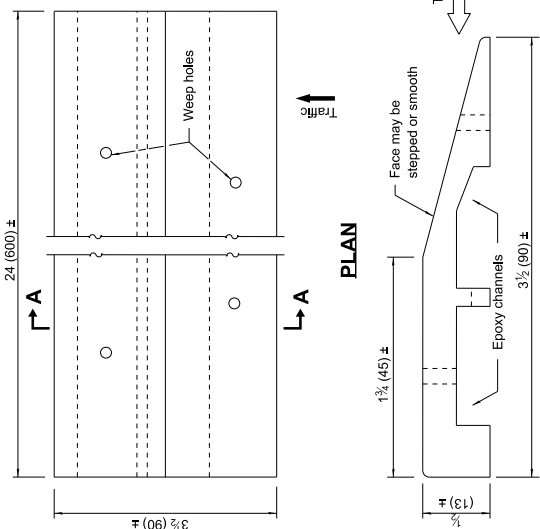

SECTION A-A

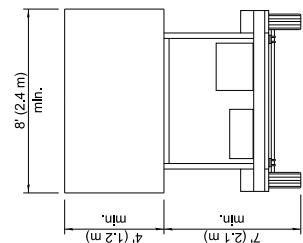

**TYPE C
TRAILER
MOUNTED**

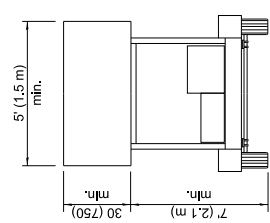

**TYPE B
ROOF OR TRAILER
MOUNTED**

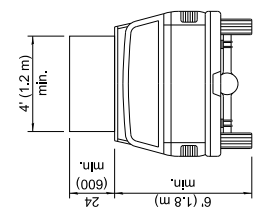

**TYPE A
ROOF
MOUNTED**

ARROW BOARDS

TEMPORARY RUMBLE STRIPS

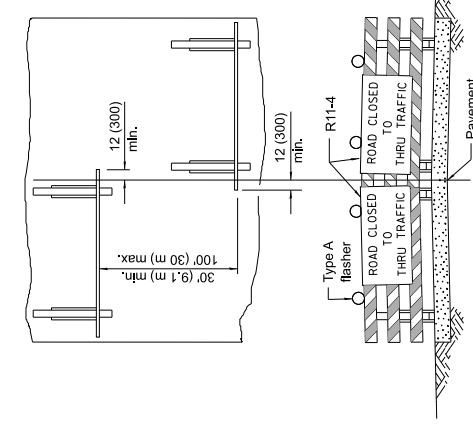

ROAD CLOSED TO THRU TRAFFIC
ReflectORIZED striping shall appear on both sides of the barricades.

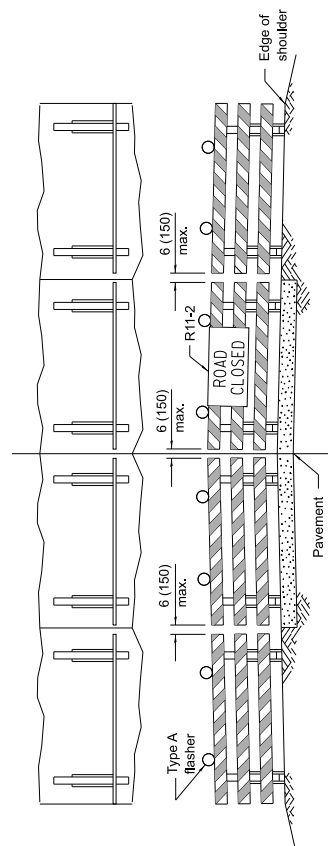

ROAD CLOSED TO ALL TRAFFIC
ReflectORIZED striping may be omitted on the back side of the barricades.

**TYPICAL APPLICATIONS OF
TYPE III BARRICADES CLOSING A ROAD**

If a Type III barricade with an attached sign panel which meets NCHRP 350 or MASH is not available, the sign may be mounted on an NCHRP 350 or MASH temporary sign support directly in front of the barricade.

**TRAFFIC CONTROL
DEVICES**

(Sheet 3 of 3)

STANDARD 701901-09

| | | |
|------------------------------------|-------------|---------------------------------|
| | ISSUED | 1-1-13 |
| | PASSED | JANUARY 1, 2024 |
| | APPROVED BY | SAFETY PROGRAMS AND ENGINEERING |
| | APPROVED | JANUARY 1, 2024 |
| ENGINEER OF DESIGN AND ENVIRONMENT | | |

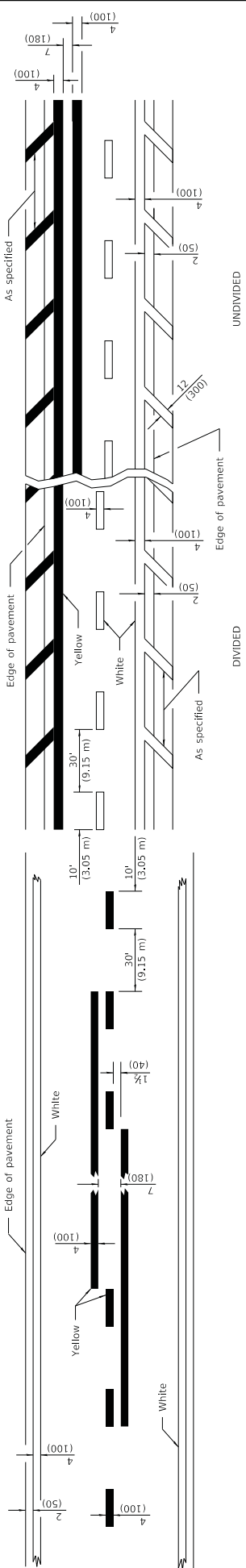

2 LANE

DIVIDED

UNDIVIDED

LANE AND EDGE LINES

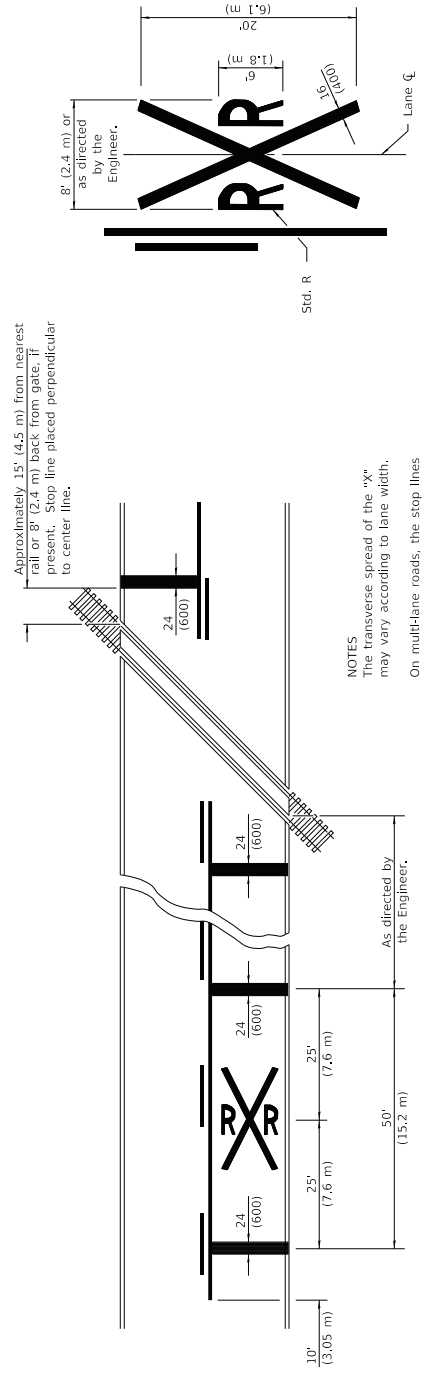

NOTES

The transverse spread of the "x" may vary according to lane width.

On multi-lane roads, the stop lines shall extend across all approach lanes and separate RRR symbols shall be placed adjacent to each other in each lane.

When the pavement marking symbol is used, a portion of the symbol should be located directly adjacent to the Advance Warning Sign (W10-1) as placed by Table 2C-4, Condition B or the MUTCD.

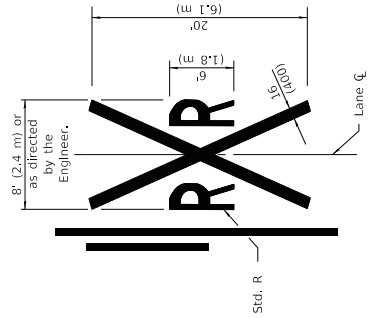

PAVEMENT MARKINGS AT RAILROAD-HIGHWAY GRADE CROSSING

| | |
|---------------------------------------|----------------------------|
| Illinois Department of Transportation | ISSUED 1-1-07 |
| PASSED | JANUARY 1, 2015 |
| ENGINEER OF OPERATIONS | <i>John A. [Signature]</i> |
| APPROVED | JANUARY 1, 2015 |
| ENGINEER OF DESIGN AND ENVIRONMENT | <i>[Signature]</i> |

| DATE | REVISIONS |
|--------|--|
| 1-1-15 | Added symbols. Revised bike symbol. Revised note for stop line at RR crossing. |
| 1-1-14 | Added bike symbol. Renamed 'LANE DROP ARROW' detail to 'LANE-REDUCTION ARROW'. |

TYPICAL PAVEMENT MARKINGS

STANDARD 780001-05

(Sheet 1 of 3)

All dimensions are in inches (millimeters) unless otherwise shown.

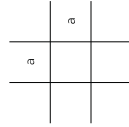
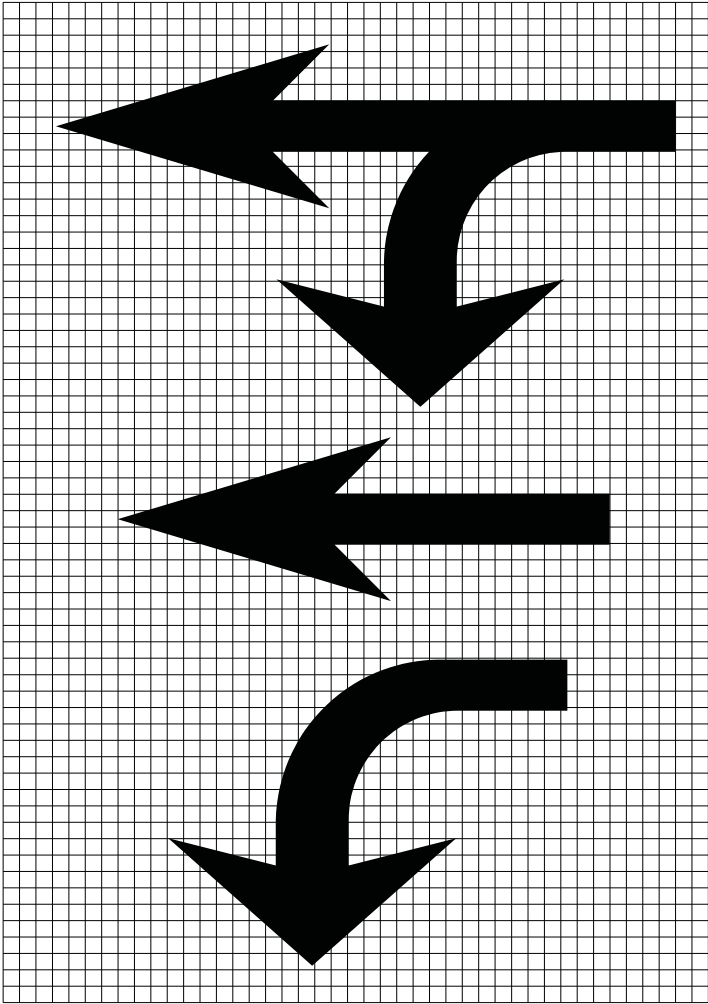
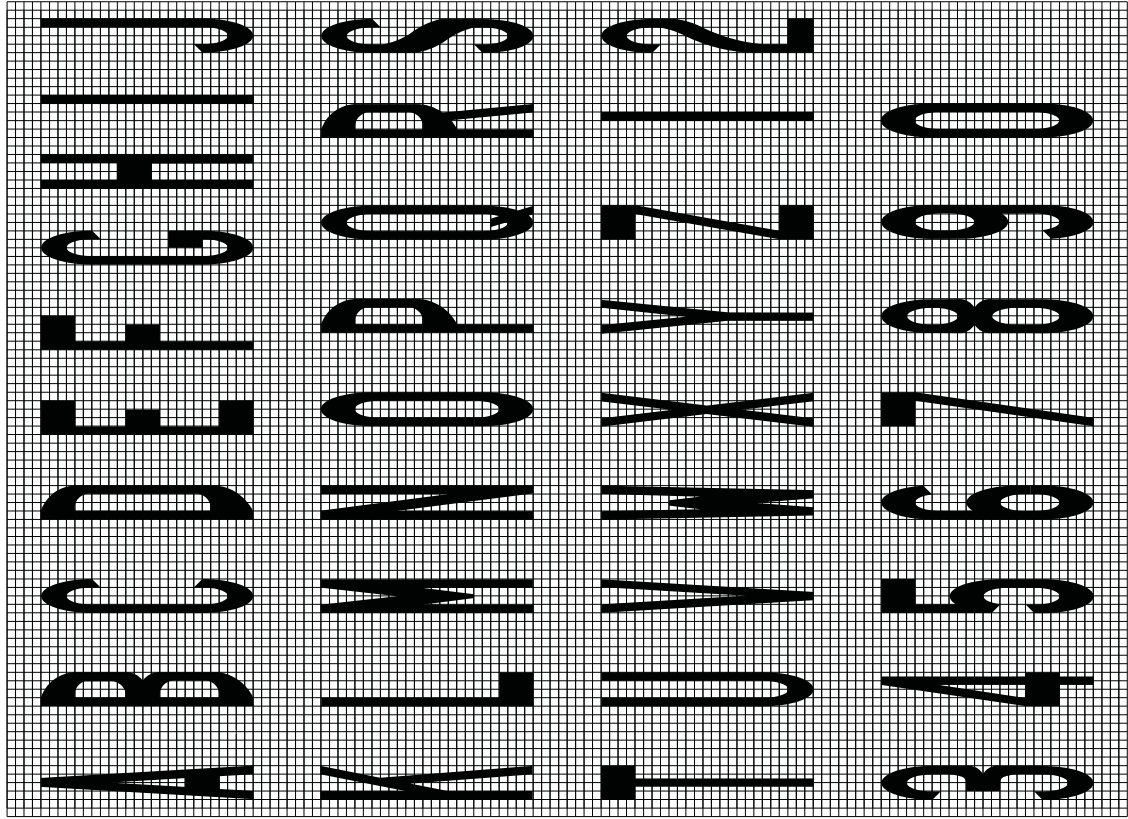

| Legend Height | Arrow Size | a |
|---------------|------------|----------|
| 6' (1.8 m) | Small | 2.9 (74) |
| 8' (2.4 m) | Large | 3.8 (96) |

The space between adjacent letters or numerals should be approximately 3/4 (75) for 6' (1.8 m) legend and 4/100 (100) for 8' (2.4 m) legend.

LETTER AND ARROW GRID SCALE

Illinois Department of Transportation
 PASSED January 1, 2015
 ENGINEER OF OPERATIONS
 APPROVED January 1, 2015
 ENGINEER OF DESIGN AND ENVIRONMENT

TYPICAL PAVEMENT MARKINGS
 (Sheet 2 of 3)
STANDARD 780001-05

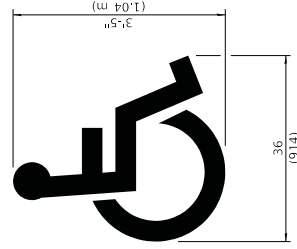

INTERNATIONAL SYMBOL OF ACCESSIBILITY

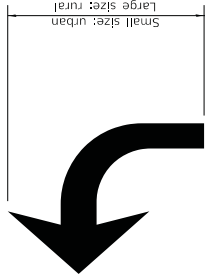

20" (508 mm): urban
50" (1270 mm): rural
(Between arrow and word or between words)

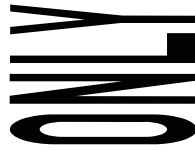

WORD AND ARROW LAYOUT

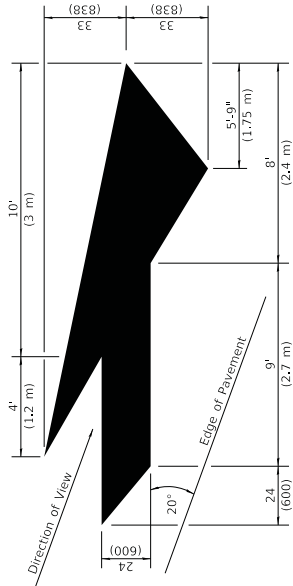

LANE-REDUCTION ARROW

Right lane-reduction arrow shown.
Use mirror image for left lane.

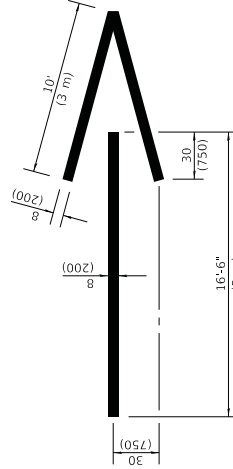

WRONG WAY ARROW

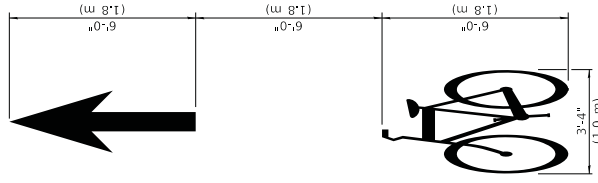

BIKE SYMBOL
(Arrow is optional)

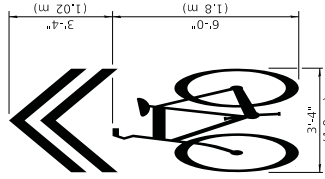

SHARED LANE SYMBOL

TYPICAL PAVEMENT MARKINGS

(Sheet 3 of 3)

STANDARD 780001-05

Illinois Department of Transportation

PASSED January 1, 2015
 ENGINEER OF OPERATIONS
 APPROVED January 1, 2015
 ENGINEER OF DESIGN AND ENVIRONMENT

ISSUED 1-1-07

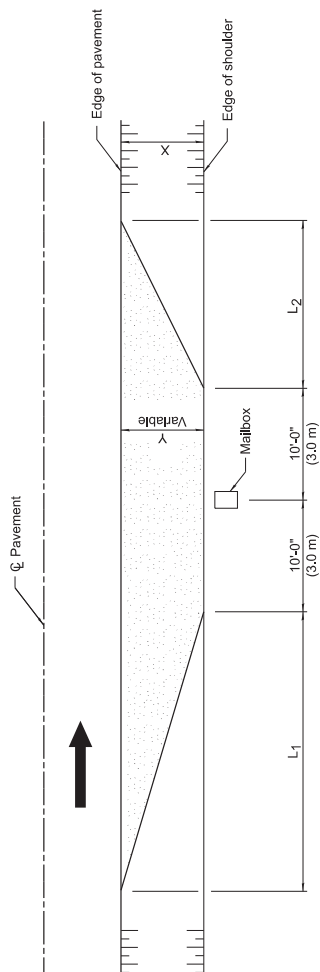

TYPICAL APPLICATION

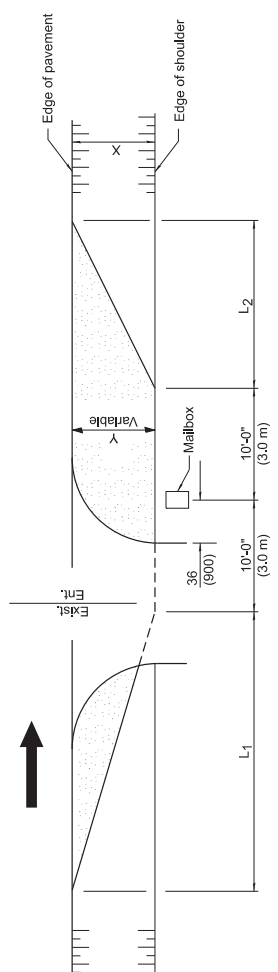

MAILBOX ON FAR SIDE OF ENTRANCE

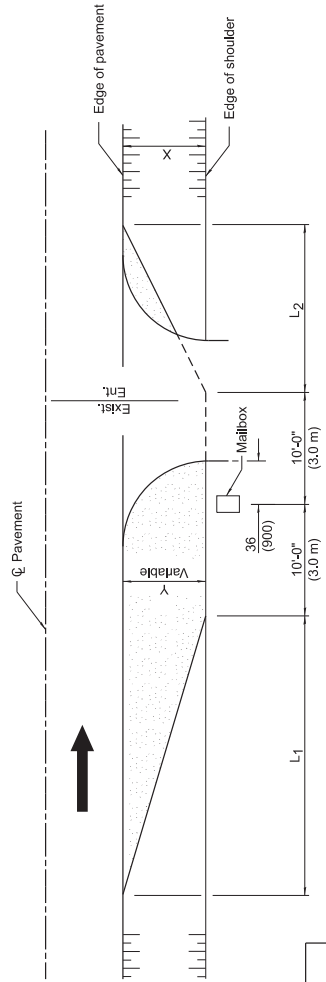

MAILBOX ON NEAR SIDE OF ENTRANCE

| DIMENSIONS - ft. (m) | | | | | | | | | | |
|-----------------------|----------|----------|----------|----------|----------|----------|--|--|--|--|
| Width of Shoulder (X) | 12 (3.6) | 10 (3.0) | 8 (2.4) | 6 (1.8) | 5 (1.5) | 4 (1.2) | | | | |
| Width of Turnout (Y) | 8 (2.4) | 8 (2.4) | 6 (1.8) | 4 (1.2) | 4 (1.2) | 4 (1.2) | | | | |
| L ₁ | 30 (9.0) | 30 (9.0) | 23 (6.9) | 15 (4.5) | 15 (4.5) | 15 (4.5) | | | | |
| L ₂ | 20 (6.0) | 20 (6.0) | 15 (4.5) | 10 (3.0) | 10 (3.0) | 10 (3.0) | | | | |

Note:
Dimensions for Township and District Roads may vary from the above dimensions.

GENERAL NOTES

Mailboxes shall be mounted such that the face of the mailbox is 6 (150) to 12 (300) and the post a minimum of 24 (600) from the edge of the turnout surfacing.

All dimensions are in inches (millimeters) unless otherwise shown.

| DATE | REVISIONS |
|--------|-------------------------------------|
| 1-1-09 | Switched units to English (metric). |
| 1-1-99 | Add width of shoulder X. |

MAILBOX TURNOUT FOR LOCAL ROADS

STANDARD B.L.R. 24-2

Illinois Department of Transportation
 APPROVED *Charles J. Casper* January 1, 2009
 ENGINEER OF TOWNSHIP AND DISTRICT ROADS AND STREETS
 APPROVED *Lee C. Haas* January 1, 2009
 ENGINEER OF DESIGN AND ENVIRONMENT
 ISSUED 1-1-97

REQUIRED CONTRACT PROVISIONS FEDERAL-AID CONSTRUCTION CONTRACTS

- I. General
- II. Nondiscrimination
- III. Non-segregated Facilities
- IV. Davis-Bacon and Related Act Provisions
- V. Contract Work Hours and Safety Standards Act Provisions
- VI. Subletting or Assigning the Contract
- VII. Safety: Accident Prevention
- VIII. False Statements Concerning Highway Projects
- IX. Implementation of Clean Air Act and Federal Water Pollution Control Act
- X. Certification Regarding Debarment, Suspension, Ineligibility and Voluntary Exclusion
- XI. Certification Regarding Use of Contract Funds for Lobbying
- XII. Use of United States-Flag Vessels:

ATTACHMENTS

A. Employment and Materials Preference for Appalachian Development Highway System or Appalachian Local Access Road Contracts (included in Appalachian contracts only)

I. GENERAL

1. Form FHWA-1273 must be physically incorporated in each construction contract funded under title 23, United States Code, as required in 23 CFR 633.102(b) (excluding emergency contracts solely intended for debris removal). The contractor (or subcontractor) must insert this form in each subcontract and further require its inclusion in all lower tier subcontracts (excluding purchase orders, rental agreements and other agreements for supplies or services). 23 CFR 633.102(e).

The applicable requirements of Form FHWA-1273 are incorporated by reference for work done under any purchase order, rental agreement or agreement for other services. The prime contractor shall be responsible for compliance by any subcontractor, lower-tier subcontractor or service provider. 23 CFR 633.102(e).

Form FHWA-1273 must be included in all Federal-aid design-build contracts, in all subcontracts and in lower tier subcontracts (excluding subcontracts for design services, purchase orders, rental agreements and other agreements for supplies or services) in accordance with 23 CFR 633.102. The design-builder shall be responsible for compliance by any subcontractor, lower-tier subcontractor or service provider.

Contracting agencies may reference Form FHWA-1273 in solicitation-for-bids or request-for-proposals documents, however, the Form FHWA-1273 must be physically incorporated (not referenced) in all contracts, subcontracts and lower-tier subcontracts (excluding purchase orders, rental agreements and other agreements for supplies or services related to a construction contract). 23 CFR 633.102(b).

2. Subject to the applicability criteria noted in the following sections, these contract provisions shall apply to all work

performed on the contract by the contractor's own organization and with the assistance of workers under the contractor's immediate superintendence and to all work performed on the contract by piecework, station work, or by subcontract. 23 CFR 633.102(d).

3. A breach of any of the stipulations contained in these Required Contract Provisions may be sufficient grounds for withholding of progress payments, withholding of final payment, termination of the contract, suspension / debarment or any other action determined to be appropriate by the contracting agency and FHWA.

4. Selection of Labor: During the performance of this contract, the contractor shall not use convict labor for any purpose within the limits of a construction project on a Federal-aid highway unless it is labor performed by convicts who are on parole, supervised release, or probation. 23 U.S.C. 114(b). The term Federal-aid highway does not include roadways functionally classified as local roads or rural minor collectors. 23 U.S.C. 101(a).

II. NONDISCRIMINATION (23 CFR 230.107(a); 23 CFR Part 230, Subpart A, Appendix A; EO 11246)

The provisions of this section related to 23 CFR Part 230, Subpart A, Appendix A are applicable to all Federal-aid construction contracts and to all related construction subcontracts of \$10,000 or more. The provisions of 23 CFR Part 230 are not applicable to material supply, engineering, or architectural service contracts.

In addition, the contractor and all subcontractors must comply with the following policies: Executive Order 11246, 41 CFR Part 60, 29 CFR Parts 1625-1627, 23 U.S.C. 140, Section 504 of the Rehabilitation Act of 1973, as amended (29 U.S.C. 794), Title VI of the Civil Rights Act of 1964, as amended (42 U.S.C. 2000d et seq.), and related regulations including 49 CFR Parts 21, 26, and 27; and 23 CFR Parts 200, 230, and 633.

The contractor and all subcontractors must comply with: the requirements of the Equal Opportunity Clause in 41 CFR 60-1.4(b) and, for all construction contracts exceeding \$10,000, the Standard Federal Equal Employment Opportunity Construction Contract Specifications in 41 CFR 60-4.3.

Note: The U.S. Department of Labor has exclusive authority to determine compliance with Executive Order 11246 and the policies of the Secretary of Labor including 41 CFR Part 60, and 29 CFR Parts 1625-1627. The contracting agency and the FHWA have the authority and the responsibility to ensure compliance with 23 U.S.C. 140, Section 504 of the Rehabilitation Act of 1973, as amended (29 U.S.C. 794), and Title VI of the Civil Rights Act of 1964, as amended (42 U.S.C. 2000d et seq.), and related regulations including 49 CFR Parts 21, 26, and 27; and 23 CFR Parts 200, 230, and 633.

The following provision is adopted from 23 CFR Part 230, Subpart A, Appendix A, with appropriate revisions to conform to the U.S. Department of Labor (US DOL) and FHWA requirements.

1. Equal Employment Opportunity: Equal Employment Opportunity (EEO) requirements not to discriminate and to take affirmative action to assure equal opportunity as set forth under laws, executive orders, rules, regulations (see 28 CFR Part 35, 29 CFR Part 1630, 29 CFR Parts 1625-1627, 41 CFR Part 60 and 49 CFR Part 27) and orders of the Secretary of Labor as modified by the provisions prescribed herein, and imposed pursuant to 23 U.S.C. 140, shall constitute the EEO and specific affirmative action standards for the contractor's project activities under this contract. The provisions of the Americans with Disabilities Act of 1990 (42 U.S.C. 12101 et seq.) set forth under 28 CFR Part 35 and 29 CFR Part 1630 are incorporated by reference in this contract. In the execution of this contract, the contractor agrees to comply with the following minimum specific requirement activities of EEO:

a. The contractor will work with the contracting agency and the Federal Government to ensure that it has made every good faith effort to provide equal opportunity with respect to all of its terms and conditions of employment and in their review of activities under the contract. 23 CFR 230.409 (g)(4) & (5).

b. The contractor will accept as its operating policy the following statement:

"It is the policy of this Company to assure that applicants are employed, and that employees are treated during employment, without regard to their race, religion, sex, sexual orientation, gender identity, color, national origin, age or disability. Such action shall include: employment, upgrading, demotion, or transfer; recruitment or recruitment advertising; layoff or termination; rates of pay or other forms of compensation; and selection for training, including apprenticeship, pre-apprenticeship, and/or on-the-job training."

2. EEO Officer: The contractor will designate and make known to the contracting officers an EEO Officer who will have the responsibility for and must be capable of effectively administering and promoting an active EEO program and who must be assigned adequate authority and responsibility to do so.

3. Dissemination of Policy: All members of the contractor's staff who are authorized to hire, supervise, promote, and discharge employees, or who recommend such action or are substantially involved in such action, will be made fully cognizant of and will implement the contractor's EEO policy and contractual responsibilities to provide EEO in each grade and classification of employment. To ensure that the above agreement will be met, the following actions will be taken as a minimum:

a. Periodic meetings of supervisory and personnel office employees will be conducted before the start of work and then not less often than once every six months, at which time the contractor's EEO policy and its implementation will be reviewed and explained. The meetings will be conducted by the EEO Officer or other knowledgeable company official.

b. All new supervisory or personnel office employees will be given a thorough indoctrination by the EEO Officer, covering all major aspects of the contractor's EEO obligations within thirty days following their reporting for duty with the contractor.

c. All personnel who are engaged in direct recruitment for the project will be instructed by the EEO Officer in the contractor's procedures for locating and hiring minorities and women.

d. Notices and posters setting forth the contractor's EEO policy will be placed in areas readily accessible to employees, applicants for employment and potential employees.

e. The contractor's EEO policy and the procedures to implement such policy will be brought to the attention of employees by means of meetings, employee handbooks, or other appropriate means.

4. Recruitment: When advertising for employees, the contractor will include in all advertisements for employees the notation: "An Equal Opportunity Employer." All such advertisements will be placed in publications having a large circulation among minorities and women in the area from which the project work force would normally be derived.

a. The contractor will, unless precluded by a valid bargaining agreement, conduct systematic and direct recruitment through public and private employee referral sources likely to yield qualified minorities and women. To meet this requirement, the contractor will identify sources of potential minority group employees and establish with such identified sources procedures whereby minority and women applicants may be referred to the contractor for employment consideration.

b. In the event the contractor has a valid bargaining agreement providing for exclusive hiring hall referrals, the contractor is expected to observe the provisions of that agreement to the extent that the system meets the contractor's compliance with EEO contract provisions. Where implementation of such an agreement has the effect of discriminating against minorities or women, or obligates the contractor to do the same, such implementation violates Federal nondiscrimination provisions.

c. The contractor will encourage its present employees to refer minorities and women as applicants for employment. Information and procedures with regard to referring such applicants will be discussed with employees.

5. Personnel Actions: Wages, working conditions, and employee benefits shall be established and administered, and personnel actions of every type, including hiring, upgrading, promotion, transfer, demotion, layoff, and termination, shall be taken without regard to race, color, religion, sex, sexual orientation, gender identity, national origin, age or disability. The following procedures shall be followed:

a. The contractor will conduct periodic inspections of project sites to ensure that working conditions and employee facilities do not indicate discriminatory treatment of project site personnel.

b. The contractor will periodically evaluate the spread of wages paid within each classification to determine any evidence of discriminatory wage practices.

c. The contractor will periodically review selected personnel actions in depth to determine whether there is evidence of discrimination. Where evidence is found, the contractor will promptly take corrective action. If the review indicates that the discrimination may extend beyond the actions reviewed, such corrective action shall include all affected persons.

d. The contractor will promptly investigate all complaints of alleged discrimination made to the contractor in connection with its obligations under this contract, will attempt to resolve such complaints, and will take appropriate corrective action

within a reasonable time. If the investigation indicates that the discrimination may affect persons other than the complainant, such corrective action shall include such other persons. Upon completion of each investigation, the contractor will inform every complainant of all of their avenues of appeal.

6. Training and Promotion:

a. The contractor will assist in locating, qualifying, and increasing the skills of minorities and women who are applicants for employment or current employees. Such efforts should be aimed at developing full journey level status employees in the type of trade or job classification involved.

b. Consistent with the contractor's work force requirements and as permissible under Federal and State regulations, the contractor shall make full use of training programs (i.e., apprenticeship and on-the-job training programs for the geographical area of contract performance). In the event a special provision for training is provided under this contract, this subparagraph will be superseded as indicated in the special provision. The contracting agency may reserve training positions for persons who receive welfare assistance in accordance with 23 U.S.C. 140(a).

c. The contractor will advise employees and applicants for employment of available training programs and entrance requirements for each.

d. The contractor will periodically review the training and promotion potential of employees who are minorities and women and will encourage eligible employees to apply for such training and promotion.

7. Unions: If the contractor relies in whole or in part upon unions as a source of employees, the contractor will use good faith efforts to obtain the cooperation of such unions to increase opportunities for minorities and women. 23 CFR 230.409. Actions by the contractor, either directly or through a contractor's association acting as agent, will include the procedures set forth below:

a. The contractor will use good faith efforts to develop, in cooperation with the unions, joint training programs aimed toward qualifying more minorities and women for membership in the unions and increasing the skills of minorities and women so that they may qualify for higher paying employment.

b. The contractor will use good faith efforts to incorporate an EEO clause into each union agreement to the end that such union will be contractually bound to refer applicants without regard to their race, color, religion, sex, sexual orientation, gender identity, national origin, age, or disability.

c. The contractor is to obtain information as to the referral practices and policies of the labor union except that to the extent such information is within the exclusive possession of the labor union and such labor union refuses to furnish such information to the contractor, the contractor shall so certify to the contracting agency and shall set forth what efforts have been made to obtain such information.

d. In the event the union is unable to provide the contractor with a reasonable flow of referrals within the time limit set forth in the collective bargaining agreement, the contractor will, through independent recruitment efforts, fill the employment vacancies without regard to race, color, religion, sex, sexual orientation, gender identity, national origin, age, or disability; making full efforts to obtain qualified and/or qualifiable minorities and women. The failure of a union to provide

sufficient referrals (even though it is obligated to provide exclusive referrals under the terms of a collective bargaining agreement) does not relieve the contractor from the requirements of this paragraph. In the event the union referral practice prevents the contractor from meeting the obligations pursuant to Executive Order 11246, as amended, and these special provisions, such contractor shall immediately notify the contracting agency.

8. Reasonable Accommodation for Applicants /

Employees with Disabilities: The contractor must be familiar with the requirements for and comply with the Americans with Disabilities Act and all rules and regulations established thereunder. Employers must provide reasonable accommodation in all employment activities unless to do so would cause an undue hardship.

9. Selection of Subcontractors, Procurement of Materials and Leasing of Equipment: The contractor shall not discriminate on the grounds of race, color, religion, sex, sexual orientation, gender identity, national origin, age, or disability in the selection and retention of subcontractors, including procurement of materials and leases of equipment. The contractor shall take all necessary and reasonable steps to ensure nondiscrimination in the administration of this contract.

a. The contractor shall notify all potential subcontractors, suppliers, and lessors of their EEO obligations under this contract.

b. The contractor will use good faith efforts to ensure subcontractor compliance with their EEO obligations.

10. Assurances Required:

a. The requirements of 49 CFR Part 26 and the State DOT's FHWA-approved Disadvantaged Business Enterprise (DBE) program are incorporated by reference.

b. The contractor, subrecipient or subcontractor shall not discriminate on the basis of race, color, national origin, or sex in the performance of this contract. The contractor shall carry out applicable requirements of 49 CFR part 26 in the award and administration of DOT-assisted contracts. Failure by the contractor to carry out these requirements is a material breach of this contract, which may result in the termination of this contract or such other remedy as the recipient deems appropriate, which may include, but is not limited to:

- (1) Withholding monthly progress payments;
- (2) Assessing sanctions;
- (3) Liquidated damages; and/or
- (4) Disqualifying the contractor from future bidding as non-responsible.

c. The Title VI and nondiscrimination provisions of U.S. DOT Order 1050.2A at Appendixes A and E are incorporated by reference. 49 CFR Part 21.

11. Records and Reports: The contractor shall keep such records as necessary to document compliance with the EEO requirements. Such records shall be retained for a period of three years following the date of the final payment to the contractor for all contract work and shall be available at reasonable times and places for inspection by authorized representatives of the contracting agency and the FHWA.

a. The records kept by the contractor shall document the following:

(1) The number and work hours of minority and non-minority group members and women employed in each work classification on the project;

(2) The progress and efforts being made in cooperation with unions, when applicable, to increase employment opportunities for minorities and women; and

(3) The progress and efforts being made in locating, hiring, training, qualifying, and upgrading minorities and women.

b. The contractors and subcontractors will submit an annual report to the contracting agency each July for the duration of the project indicating the number of minority, women, and non-minority group employees currently engaged in each work classification required by the contract work. This information is to be reported on [Form FHWA-1391](#). The staffing data should represent the project work force on board in all or any part of the last payroll period preceding the end of July. If on-the-job training is being required by special provision, the contractor will be required to collect and report training data. The employment data should reflect the work force on board during all or any part of the last payroll period preceding the end of July.

III. NONSEGREGATED FACILITIES

This provision is applicable to all Federal-aid construction contracts and to all related construction subcontracts of more than \$10,000. 41 CFR 60-1.5.

As prescribed by 41 CFR 60-1.8, the contractor must ensure that facilities provided for employees are provided in such a manner that segregation on the basis of race, color, religion, sex, sexual orientation, gender identity, or national origin cannot result. The contractor may neither require such segregated use by written or oral policies nor tolerate such use by employee custom. The contractor's obligation extends further to ensure that its employees are not assigned to perform their services at any location under the contractor's control where the facilities are segregated. The term "facilities" includes waiting rooms, work areas, restaurants and other eating areas, time clocks, restrooms, washrooms, locker rooms and other storage or dressing areas, parking lots, drinking fountains, recreation or entertainment areas, transportation, and housing provided for employees. The contractor shall provide separate or single-user restrooms and necessary dressing or sleeping areas to assure privacy between sexes.

IV. DAVIS-BACON AND RELATED ACT PROVISIONS

This section is applicable to all Federal-aid construction projects exceeding \$2,000 and to all related subcontracts and lower-tier subcontracts (regardless of subcontract size), in accordance with 29 CFR 5.5. The requirements apply to all projects located within the right-of-way of a roadway that is functionally classified as Federal-aid highway. 23 U.S.C. 113. This excludes roadways functionally classified as local roads or rural minor collectors, which are exempt. 23 U.S.C. 101. Where applicable law requires that projects be treated as a project on a Federal-aid highway, the provisions of this subpart will apply regardless of the location of the project. Examples include: Surface Transportation Block Grant Program projects funded under 23 U.S.C. 133 [excluding recreational trails projects], the Nationally Significant Freight and Highway

Projects funded under 23 U.S.C. 117, and National Highway Freight Program projects funded under 23 U.S.C. 167.

The following provisions are from the U.S. Department of Labor regulations in 29 CFR 5.5 "Contract provisions and related matters" with minor revisions to conform to the FHWA- 1273 format and FHWA program requirements.

1. Minimum wages (29 CFR 5.5)

a. *Wage rates and fringe benefits.* All laborers and mechanics employed or working upon the site of the work (or otherwise working in construction or development of the project under a development statute), will be paid unconditionally and not less often than once a week, and without subsequent deduction or rebate on any account (except such payroll deductions as are permitted by regulations issued by the Secretary of Labor under the Copeland Act ([29 CFR part 3](#))), the full amount of basic hourly wages and bona fide fringe benefits (or cash equivalents thereof) due at time of payment computed at rates not less than those contained in the wage determination of the Secretary of Labor which is attached hereto and made a part hereof, regardless of any contractual relationship which may be alleged to exist between the contractor and such laborers and mechanics. As provided in paragraphs (d) and (e) of 29 CFR 5.5, the appropriate wage determinations are effective by operation of law even if they have not been attached to the contract. Contributions made or costs reasonably anticipated for bona fide fringe benefits under the Davis-Bacon Act ([40 U.S.C. 3141\(2\)\(B\)](#)) on behalf of laborers or mechanics are considered wages paid to such laborers or mechanics, subject to the provisions of paragraph 1.e. of this section; also, regular contributions made or costs incurred for more than a weekly period (but not less often than quarterly) under plans, funds, or programs which cover the particular weekly period, are deemed to be constructively made or incurred during such weekly period. Such laborers and mechanics must be paid the appropriate wage rate and fringe benefits on the wage determination for the classification(s) of work actually performed, without regard to skill, except as provided in paragraph 4. of this section. Laborers or mechanics performing work in more than one classification may be compensated at the rate specified for each classification for the time actually worked therein: *Provided*, That the employer's payroll records accurately set forth the time spent in each classification in which work is performed. The wage determination (including any additional classifications and wage rates conformed under paragraph 1.c. of this section) and the Davis-Bacon poster (WH-1321) must be posted at all times by the contractor and its subcontractors at the site of the work in a prominent and accessible place where it can be easily seen by the workers.

b. *Frequently recurring classifications.* (1) In addition to wage and fringe benefit rates that have been determined to be prevailing under the procedures set forth in [29 CFR part 1](#), a wage determination may contain, pursuant to § 1.3(f), wage and fringe benefit rates for classifications of laborers and mechanics for which conformance requests are regularly submitted pursuant to paragraph 1.c. of this section, provided that:

(i) The work performed by the classification is not performed by a classification in the wage determination for which a prevailing wage rate has been determined;

(ii) The classification is used in the area by the construction industry; and

(iii) The wage rate for the classification bears a reasonable relationship to the prevailing wage rates contained in the wage determination.

(2) The Administrator will establish wage rates for such classifications in accordance with paragraph 1.c.(1)(iii) of this section. Work performed in such a classification must be paid at no less than the wage and fringe benefit rate listed on the wage determination for such classification.

c. *Conformance.* (1) The contracting officer must require that any class of laborers or mechanics, including helpers, which is not listed in the wage determination and which is to be employed under the contract be classified in conformance with the wage determination. Conformance of an additional classification and wage rate and fringe benefits is appropriate only when the following criteria have been met:

(i) The work to be performed by the classification requested is not performed by a classification in the wage determination; and

(ii) The classification is used in the area by the construction industry; and

(iii) The proposed wage rate, including any bona fide fringe benefits, bears a reasonable relationship to the wage rates contained in the wage determination.

(2) The conformance process may not be used to split, subdivide, or otherwise avoid application of classifications listed in the wage determination.

(3) If the contractor and the laborers and mechanics to be employed in the classification (if known), or their representatives, and the contracting officer agree on the classification and wage rate (including the amount designated for fringe benefits where appropriate), a report of the action taken will be sent by the contracting officer by email to DBAconformance@dol.gov. The Administrator, or an authorized representative, will approve, modify, or disapprove every additional classification action within 30 days of receipt and so advise the contracting officer or will notify the contracting officer within the 30-day period that additional time is necessary.

(4) In the event the contractor, the laborers or mechanics to be employed in the classification or their representatives, and the contracting officer do not agree on the proposed classification and wage rate (including the amount designated for fringe benefits, where appropriate), the contracting officer will, by email to DBAconformance@dol.gov, refer the questions, including the views of all interested parties and the recommendation of the contracting officer, to the Administrator for determination. The Administrator, or an authorized representative, will issue a determination within 30 days of receipt and so advise the contracting officer or will notify the contracting officer within the 30-day period that additional time is necessary.

(5) The contracting officer must promptly notify the contractor of the action taken by the Wage and Hour Division

under paragraphs 1.c.(3) and (4) of this section. The contractor must furnish a written copy of such determination to each affected worker or it must be posted as a part of the wage determination. The wage rate (including fringe benefits where appropriate) determined pursuant to paragraph 1.c.(3) or (4) of this section must be paid to all workers performing work in the classification under this contract from the first day on which work is performed in the classification.

d. *Fringe benefits not expressed as an hourly rate.*

Whenever the minimum wage rate prescribed in the contract for a class of laborers or mechanics includes a fringe benefit which is not expressed as an hourly rate, the contractor may either pay the benefit as stated in the wage determination or may pay another bona fide fringe benefit or an hourly cash equivalent thereof.

e. *Unfunded plans.* If the contractor does not make payments to a trustee or other third person, the contractor may consider as part of the wages of any laborer or mechanic the amount of any costs reasonably anticipated in providing bona fide fringe benefits under a plan or program, *Provided*, That the Secretary of Labor has found, upon the written request of the contractor, in accordance with the criteria set forth in § 5.28, that the applicable standards of the Davis-Bacon Act have been met. The Secretary of Labor may require the contractor to set aside in a separate account assets for the meeting of obligations under the plan or program.

f. *Interest.* In the event of a failure to pay all or part of the wages required by the contract, the contractor will be required to pay interest on any underpayment of wages.

2. Withholding (29 CFR 5.5)

a. *Withholding requirements.* The contracting agency may, upon its own action, or must, upon written request of an authorized representative of the Department of Labor, withhold or cause to be withheld from the contractor so much of the accrued payments or advances as may be considered necessary to satisfy the liabilities of the prime contractor or any subcontractor for the full amount of wages and monetary relief, including interest, required by the clauses set forth in this section for violations of this contract, or to satisfy any such liabilities required by any other Federal contract, or federally assisted contract subject to Davis-Bacon labor standards, that is held by the same prime contractor (as defined in § 5.2). The necessary funds may be withheld from the contractor under this contract, any other Federal contract with the same prime contractor, or any other federally assisted contract that is subject to Davis-Bacon labor standards requirements and is held by the same prime contractor, regardless of whether the other contract was awarded or assisted by the same agency, and such funds may be used to satisfy the contractor liability for which the funds were withheld. In the event of a contractor's failure to pay any laborer or mechanic, including any apprentice or helper working on the site of the work all or part of the wages required by the contract, or upon the contractor's failure to submit the required records as discussed in paragraph 3.d. of this section, the contracting agency may on its own initiative and after written notice to the contractor, take such action as may be necessary to cause the suspension of any further payment, advance, or guarantee of funds until such violations have ceased.

b. *Priority to withheld funds.* The Department has priority to funds withheld or to be withheld in accordance with paragraph

2.a. of this section or Section V, paragraph 3.a., or both, over claims to those funds by:

- (1) A contractor's surety(ies), including without limitation performance bond sureties and payment bond sureties;
- (2) A contracting agency for its procurement costs;
- (3) A trustee(s) (either a court-appointed trustee or a U.S. trustee, or both) in bankruptcy of a contractor, or a contractor's bankruptcy estate;
- (4) A contractor's assignee(s);
- (5) A contractor's successor(s); or
- (6) A claim asserted under the Prompt Payment Act, [31 U.S.C. 3901–3907](#).

3. Records and certified payrolls (29 CFR 5.5)

a. Basic record requirements (1) Length of record retention. All regular payrolls and other basic records must be maintained by the contractor and any subcontractor during the course of the work and preserved for all laborers and mechanics working at the site of the work (or otherwise working in construction or development of the project under a development statute) for a period of at least 3 years after all the work on the prime contract is completed.

(2) Information required. Such records must contain the name; Social Security number; last known address, telephone number, and email address of each such worker; each worker's correct classification(s) of work actually performed; hourly rates of wages paid (including rates of contributions or costs anticipated for bona fide fringe benefits or cash equivalents thereof of the types described in [40 U.S.C. 3141\(2\)\(B\)](#) of the Davis-Bacon Act); daily and weekly number of hours actually worked in total and on each covered contract; deductions made; and actual wages paid.

(3) Additional records relating to fringe benefits. Whenever the Secretary of Labor has found under paragraph 1.e. of this section that the wages of any laborer or mechanic include the amount of any costs reasonably anticipated in providing benefits under a plan or program described in [40 U.S.C. 3141\(2\)\(B\)](#) of the Davis-Bacon Act, the contractor must maintain records which show that the commitment to provide such benefits is enforceable, that the plan or program is financially responsible, and that the plan or program has been communicated in writing to the laborers or mechanics affected, and records which show the costs anticipated or the actual cost incurred in providing such benefits.

(4) Additional records relating to apprenticeship. Contractors with apprentices working under approved programs must maintain written evidence of the registration of apprenticeship programs, the registration of the apprentices, and the ratios and wage rates prescribed in the applicable programs.

b. Certified payroll requirements (1) Frequency and method of submission. The contractor or subcontractor must submit weekly, for each week in which any DBA- or Related Acts-covered work is performed, certified payrolls to the contracting

agency. The prime contractor is responsible for the submission of all certified payrolls by all subcontractors. A contracting agency or prime contractor may permit or require contractors to submit certified payrolls through an electronic system, as long as the electronic system requires a legally valid electronic signature; the system allows the contractor, the contracting agency, and the Department of Labor to access the certified payrolls upon request for at least 3 years after the work on the prime contract has been completed; and the contracting agency or prime contractor permits other methods of submission in situations where the contractor is unable or limited in its ability to use or access the electronic system.

(2) Information required. The certified payrolls submitted must set out accurately and completely all of the information required to be maintained under paragraph 3.a.(2) of this section, except that full Social Security numbers and last known addresses, telephone numbers, and email addresses must not be included on weekly transmittals. Instead, the certified payrolls need only include an individually identifying number for each worker (e.g., the last four digits of the worker's Social Security number). The required weekly certified payroll information may be submitted using Optional Form WH-347 or in any other format desired. Optional Form WH-347 is available for this purpose from the Wage and Hour Division website at <https://www.dol.gov/sites/dolgov/files/WHDLegacy/files/wh347.pdf> or its successor website. It is not a violation of this section for a prime contractor to require a subcontractor to provide full Social Security numbers and last known addresses, telephone numbers, and email addresses to the prime contractor for its own records, without weekly submission by the subcontractor to the contracting agency.

(3) Statement of Compliance. Each certified payroll submitted must be accompanied by a "Statement of Compliance," signed by the contractor or subcontractor, or the contractor's or subcontractor's agent who pays or supervises the payment of the persons working on the contract, and must certify the following:

(i) That the certified payroll for the payroll period contains the information required to be provided under paragraph 3.b. of this section, the appropriate information and basic records are being maintained under paragraph 3.a. of this section, and such information and records are correct and complete;

(ii) That each laborer or mechanic (including each helper and apprentice) working on the contract during the payroll period has been paid the full weekly wages earned, without rebate, either directly or indirectly, and that no deductions have been made either directly or indirectly from the full wages earned, other than permissible deductions as set forth in [29 CFR part 3](#); and

(iii) That each laborer or mechanic has been paid not less than the applicable wage rates and fringe benefits or cash equivalents for the classification(s) of work actually performed, as specified in the applicable wage determination incorporated into the contract.

(4) Use of Optional Form WH-347. The weekly submission of a properly executed certification set forth on the reverse side of Optional Form WH-347 will satisfy the requirement for submission of the "Statement of Compliance" required by paragraph 3.b.(3) of this section.

(5) *Signature*. The signature by the contractor, subcontractor, or the contractor's or subcontractor's agent must be an original handwritten signature or a legally valid electronic signature.

(6) *Falsification*. The falsification of any of the above certifications may subject the contractor or subcontractor to civil or criminal prosecution under [18 U.S.C. 1001](#) and [31 U.S.C. 3729](#).

(7) *Length of certified payroll retention*. The contractor or subcontractor must preserve all certified payrolls during the course of the work and for a period of 3 years after all the work on the prime contract is completed.

c. *Contracts, subcontracts, and related documents*. The contractor or subcontractor must maintain this contract or subcontract and related documents including, without limitation, bids, proposals, amendments, modifications, and extensions. The contractor or subcontractor must preserve these contracts, subcontracts, and related documents during the course of the work and for a period of 3 years after all the work on the prime contract is completed.

d. *Required disclosures and access* (1) *Required record disclosures and access to workers*. The contractor or subcontractor must make the records required under paragraphs 3.a. through 3.c. of this section, and any other documents that the contracting agency, the State DOT, the FHWA, or the Department of Labor deems necessary to determine compliance with the labor standards provisions of any of the applicable statutes referenced by § 5.1, available for inspection, copying, or transcription by authorized representatives of the contracting agency, the State DOT, the FHWA, or the Department of Labor, and must permit such representatives to interview workers during working hours on the job.

(2) *Sanctions for non-compliance with records and worker access requirements*. If the contractor or subcontractor fails to submit the required records or to make them available, or refuses to permit worker interviews during working hours on the job, the Federal agency may, after written notice to the contractor, sponsor, applicant, owner, or other entity, as the case may be, that maintains such records or that employs such workers, take such action as may be necessary to cause the suspension of any further payment, advance, or guarantee of funds. Furthermore, failure to submit the required records upon request or to make such records available, or to permit worker interviews during working hours on the job, may be grounds for debarment action pursuant to § 5.12. In addition, any contractor or other person that fails to submit the required records or make those records available to WHD within the time WHD requests that the records be produced will be precluded from introducing as evidence in an administrative proceeding under [29 CFR part 6](#) any of the required records that were not provided or made available to WHD. WHD will take into consideration a reasonable request from the contractor or person for an extension of the time for submission of records. WHD will determine the reasonableness of the request and may consider, among other things, the location of the records and the volume of production.

(3) *Required information disclosures*. Contractors and subcontractors must maintain the full Social Security number and last known address, telephone number, and email address

of each covered worker, and must provide them upon request to the contracting agency, the State DOT, the FHWA, the contractor, or the Wage and Hour Division of the Department of Labor for purposes of an investigation or other compliance action.

4. Apprentices and equal employment opportunity (29 CFR 5.5)

a. *Apprentices* (1) *Rate of pay*. Apprentices will be permitted to work at less than the predetermined rate for the work they perform when they are employed pursuant to and individually registered in a bona fide apprenticeship program registered with the U.S. Department of Labor, Employment and Training Administration, Office of Apprenticeship (OA), or with a State Apprenticeship Agency recognized by the OA. A person who is not individually registered in the program, but who has been certified by the OA or a State Apprenticeship Agency (where appropriate) to be eligible for probationary employment as an apprentice, will be permitted to work at less than the predetermined rate for the work they perform in the first 90 days of probationary employment as an apprentice in such a program. In the event the OA or a State Apprenticeship Agency recognized by the OA withdraws approval of an apprenticeship program, the contractor will no longer be permitted to use apprentices at less than the applicable predetermined rate for the work performed until an acceptable program is approved.

(2) *Fringe benefits*. Apprentices must be paid fringe benefits in accordance with the provisions of the apprenticeship program. If the apprenticeship program does not specify fringe benefits, apprentices must be paid the full amount of fringe benefits listed on the wage determination for the applicable classification. If the Administrator determines that a different practice prevails for the applicable apprentice classification, fringe benefits must be paid in accordance with that determination.

(3) *Apprenticeship ratio*. The allowable ratio of apprentices to journeyworkers on the job site in any craft classification must not be greater than the ratio permitted to the contractor as to the entire work force under the registered program or the ratio applicable to the locality of the project pursuant to paragraph 4.a.(4) of this section. Any worker listed on a payroll at an apprentice wage rate, who is not registered or otherwise employed as stated in paragraph 4.a.(1) of this section, must be paid not less than the applicable wage rate on the wage determination for the classification of work actually performed. In addition, any apprentice performing work on the job site in excess of the ratio permitted under this section must be paid not less than the applicable wage rate on the wage determination for the work actually performed.

(4) *Reciprocity of ratios and wage rates*. Where a contractor is performing construction on a project in a locality other than the locality in which its program is registered, the ratios and wage rates (expressed in percentages of the journeyworker's hourly rate) applicable within the locality in which the construction is being performed must be observed. If there is no applicable ratio or wage rate for the locality of the project, the ratio and wage rate specified in the contractor's registered program must be observed.

b. *Equal employment opportunity*. The use of apprentices and journeyworkers under this part must be in conformity with

the equal employment opportunity requirements of Executive Order 11246, as amended, and [29 CFR part 30](#).

c. Apprentices and Trainees (programs of the U.S. DOT).

Apprentices and trainees working under apprenticeship and skill training programs which have been certified by the Secretary of Transportation as promoting EEO in connection with Federal-aid highway construction programs are not subject to the requirements of paragraph 4 of this Section IV. 23 CFR 230.111(e)(2). The straight time hourly wage rates for apprentices and trainees under such programs will be established by the particular programs. The ratio of apprentices and trainees to journeyworkers shall not be greater than permitted by the terms of the particular program.

5. Compliance with Copeland Act requirements. The contractor shall comply with the requirements of 29 CFR part 3, which are incorporated by reference in this contract as provided in 29 CFR 5.5.

6. Subcontracts. The contractor or subcontractor must insert FHWA-1273 in any subcontracts, along with the applicable wage determination(s) and such other clauses or contract modifications as the contracting agency may by appropriate instructions require, and a clause requiring the subcontractors to include these clauses and wage determination(s) in any lower tier subcontracts. The prime contractor is responsible for the compliance by any subcontractor or lower tier subcontractor with all the contract clauses in this section. In the event of any violations of these clauses, the prime contractor and any subcontractor(s) responsible will be liable for any unpaid wages and monetary relief, including interest from the date of the underpayment or loss, due to any workers of lower-tier subcontractors, and may be subject to debarment, as appropriate. 29 CFR 5.5.

7. Contract termination: debarment. A breach of the contract clauses in 29 CFR 5.5 may be grounds for termination of the contract, and for debarment as a contractor and a subcontractor as provided in 29 CFR 5.12.

8. Compliance with Davis-Bacon and Related Act requirements. All rulings and interpretations of the Davis-Bacon and Related Acts contained in 29 CFR parts 1, 3, and 5 are herein incorporated by reference in this contract as provided in 29 CFR 5.5.

9. Disputes concerning labor standards. As provided in 29 CFR 5.5, disputes arising out of the labor standards provisions of this contract shall not be subject to the general disputes clause of this contract. Such disputes shall be resolved in accordance with the procedures of the Department of Labor set forth in 29 CFR parts 5, 6, and 7. Disputes within the meaning of this clause include disputes between the contractor (or any of its subcontractors) and the contracting agency, the U.S. Department of Labor, or the employees or their representatives.

10. Certification of eligibility. a. By entering into this contract, the contractor certifies that neither it nor any person or firm who has an interest in the contractor's firm is a person or firm ineligible to be awarded Government contracts by virtue of [40 U.S.C. 3144\(b\)](#) or § 5.12(a).

b. No part of this contract shall be subcontracted to any person or firm ineligible for award of a Government contract by virtue of [40 U.S.C. 3144\(b\)](#) or § 5.12(a).

c. The penalty for making false statements is prescribed in the U.S. Code, Title 18 Crimes and Criminal Procedure, [18 U.S.C. 1001](#).

11. Anti-retaliation. It is unlawful for any person to discharge, demote, intimidate, threaten, restrain, coerce, blacklist, harass, or in any other manner discriminate against, or to cause any person to discharge, demote, intimidate, threaten, restrain, coerce, blacklist, harass, or in any other manner discriminate against, any worker or job applicant for:

a. Notifying any contractor of any conduct which the worker reasonably believes constitutes a violation of the DBA, Related Acts, this part, or [29 CFR part 1](#) or [3](#);

b. Filing any complaint, initiating or causing to be initiated any proceeding, or otherwise asserting or seeking to assert on behalf of themselves or others any right or protection under the DBA, Related Acts, this part, or [29 CFR part 1](#) or [3](#);

c. Cooperating in any investigation or other compliance action, or testifying in any proceeding under the DBA, Related Acts, this part, or [29 CFR part 1](#) or [3](#); or

d. Informing any other person about their rights under the DBA, Related Acts, this part, or [29 CFR part 1](#) or [3](#).

V. CONTRACT WORK HOURS AND SAFETY STANDARDS ACT

Pursuant to 29 CFR 5.5(b), the following clauses apply to any Federal-aid construction contract in an amount in excess of \$100,000 and subject to the overtime provisions of the Contract Work Hours and Safety Standards Act. These clauses shall be inserted in addition to the clauses required by 29 CFR 5.5(a) or 29 CFR 4.6. As used in this paragraph, the terms laborers and mechanics include watchpersons and guards.

1. Overtime requirements. No contractor or subcontractor contracting for any part of the contract work which may require or involve the employment of laborers or mechanics shall require or permit any such laborer or mechanic in any workweek in which he or she is employed on such work to work in excess of forty hours in such workweek unless such laborer or mechanic receives compensation at a rate not less than one and one-half times the basic rate of pay for all hours worked in excess of forty hours in such workweek. 29 CFR 5.5.

2. Violation; liability for unpaid wages; liquidated damages. In the event of any violation of the clause set forth in paragraph 1. of this section the contractor and any subcontractor responsible therefor shall be liable for the unpaid wages and interest from the date of the underpayment. In addition, such contractor and subcontractor shall be liable to the United States (in the case of work done under contract for the District of Columbia or a territory, to such District or to such territory), for liquidated damages. Such liquidated damages shall be computed with respect to each individual laborer or

mechanic, including watchpersons and guards, employed in violation of the clause set forth in paragraph 1. of this section, in the sum currently provided in 29 CFR 5.5(b)(2)* for each calendar day on which such individual was required or permitted to work in excess of the standard workweek of forty hours without payment of the overtime wages required by the clause set forth in paragraph 1. of this section.

* \$31 as of January 15, 2023 (See 88 FR 88 FR 2210) as may be adjusted annually by the Department of Labor, pursuant to the Federal Civil Penalties Inflation Adjustment Act of 1990.

3. Withholding for unpaid wages and liquidated damages

a. *Withholding process.* The FHWA or the contracting agency may, upon its own action, or must, upon written request of an authorized representative of the Department of Labor, withhold or cause to be withheld from the contractor so much of the accrued payments or advances as may be considered necessary to satisfy the liabilities of the prime contractor or any subcontractor for any unpaid wages; monetary relief, including interest; and liquidated damages required by the clauses set forth in this section on this contract, any other Federal contract with the same prime contractor, or any other federally assisted contract subject to the Contract Work Hours and Safety Standards Act that is held by the same prime contractor (as defined in § 5.2). The necessary funds may be withheld from the contractor under this contract, any other Federal contract with the same prime contractor, or any other federally assisted contract that is subject to the Contract Work Hours and Safety Standards Act and is held by the same prime contractor, regardless of whether the other contract was awarded or assisted by the same agency, and such funds may be used to satisfy the contractor liability for which the funds were withheld.

b. *Priority to withheld funds.* The Department has priority to funds withheld or to be withheld in accordance with Section IV paragraph 2.a. or paragraph 3.a. of this section, or both, over claims to those funds by:

- (1) A contractor's surety(ies), including without limitation performance bond sureties and payment bond sureties;
- (2) A contracting agency for its procurement costs;
- (3) A trustee(s) (either a court-appointed trustee or a U.S. trustee, or both) in bankruptcy of a contractor, or a contractor's bankruptcy estate;
- (4) A contractor's assignee(s);
- (5) A contractor's successor(s); or
- (6) A claim asserted under the Prompt Payment Act, [31 U.S.C. 3901](#)–3907.

4. Subcontracts. The contractor or subcontractor must insert in any subcontracts the clauses set forth in paragraphs 1. through 5. of this section and a clause requiring the subcontractors to include these clauses in any lower tier subcontracts. The prime contractor is responsible for compliance by any subcontractor or lower tier subcontractor with the clauses set forth in paragraphs 1. through 5. In the

event of any violations of these clauses, the prime contractor and any subcontractor(s) responsible will be liable for any unpaid wages and monetary relief, including interest from the date of the underpayment or loss, due to any workers of lower-tier subcontractors, and associated liquidated damages and may be subject to debarment, as appropriate.

5. Anti-retaliation. It is unlawful for any person to discharge, demote, intimidate, threaten, restrain, coerce, blacklist, harass, or in any other manner discriminate against, or to cause any person to discharge, demote, intimidate, threaten, restrain, coerce, blacklist, harass, or in any other manner discriminate against, any worker or job applicant for:

- a. Notifying any contractor of any conduct which the worker reasonably believes constitutes a violation of the Contract Work Hours and Safety Standards Act (CWHSSA) or its implementing regulations in this part;
- b. Filing any complaint, initiating or causing to be initiated any proceeding, or otherwise asserting or seeking to assert on behalf of themselves or others any right or protection under CWHSSA or this part;
- c. Cooperating in any investigation or other compliance action, or testifying in any proceeding under CWHSSA or this part; or
- d. Informing any other person about their rights under CWHSSA or this part.

VI. SUBLETTING OR ASSIGNING THE CONTRACT

This provision is applicable to all Federal-aid construction contracts on the National Highway System pursuant to 23 CFR 635.116.

1. The contractor shall perform with its own organization contract work amounting to not less than 30 percent (or a greater percentage if specified elsewhere in the contract) of the total original contract price, excluding any specialty items designated by the contracting agency. Specialty items may be performed by subcontract and the amount of any such specialty items performed may be deducted from the total original contract price before computing the amount of work required to be performed by the contractor's own organization (23 CFR 635.116).

a. The term "perform work with its own organization" in paragraph 1 of Section VI refers to workers employed or leased by the prime contractor, and equipment owned or rented by the prime contractor, with or without operators. Such term does not include employees or equipment of a subcontractor or lower tier subcontractor, agents of the prime contractor, or any other assignees. The term may include payments for the costs of hiring leased employees from an employee leasing firm meeting all relevant Federal and State regulatory requirements. Leased employees may only be included in this term if the prime contractor meets all of the following conditions: (based on longstanding interpretation)

- (1) the prime contractor maintains control over the supervision of the day-to-day activities of the leased employees;
- (2) the prime contractor remains responsible for the quality of the work of the leased employees;

- (3) the prime contractor retains all power to accept or exclude individual employees from work on the project; and
- (4) the prime contractor remains ultimately responsible for the payment of predetermined minimum wages, the submission of payrolls, statements of compliance and all other Federal regulatory requirements.

b. "Specialty Items" shall be construed to be limited to work that requires highly specialized knowledge, abilities, or equipment not ordinarily available in the type of contracting organizations qualified and expected to bid or propose on the contract as a whole and in general are to be limited to minor components of the overall contract. 23 CFR 635.102.

2. Pursuant to 23 CFR 635.116(a), the contract amount upon which the requirements set forth in paragraph (1) of Section VI is computed includes the cost of material and manufactured products which are to be purchased or produced by the contractor under the contract provisions.

3. Pursuant to 23 CFR 635.116(c), the contractor shall furnish (a) a competent superintendent or supervisor who is employed by the firm, has full authority to direct performance of the work in accordance with the contract requirements, and is in charge of all construction operations (regardless of who performs the work) and (b) such other of its own organizational resources (supervision, management, and engineering services) as the contracting officer determines is necessary to assure the performance of the contract.

4. No portion of the contract shall be sublet, assigned or otherwise disposed of except with the written consent of the contracting officer, or authorized representative, and such consent when given shall not be construed to relieve the contractor of any responsibility for the fulfillment of the contract. Written consent will be given only after the contracting agency has assured that each subcontract is evidenced in writing and that it contains all pertinent provisions and requirements of the prime contract. (based on long-standing interpretation of 23 CFR 635.116).

5. The 30-percent self-performance requirement of paragraph (1) is not applicable to design-build contracts; however, contracting agencies may establish their own self-performance requirements. 23 CFR 635.116(d).

VII. SAFETY: ACCIDENT PREVENTION

This provision is applicable to all Federal-aid construction contracts and to all related subcontracts.

1. In the performance of this contract the contractor shall comply with all applicable Federal, State, and local laws governing safety, health, and sanitation (23 CFR Part 635). The contractor shall provide all safeguards, safety devices and protective equipment and take any other needed actions as it determines, or as the contracting officer may determine, to be reasonably necessary to protect the life and health of employees on the job and the safety of the public and to protect property in connection with the performance of the work covered by the contract. 23 CFR 635.108.

2. It is a condition of this contract, and shall be made a condition of each subcontract, which the contractor enters into pursuant to this contract, that the contractor and any subcontractor shall not permit any employee, in performance of the contract, to work in surroundings or under conditions which are unsanitary, hazardous or dangerous to his/her health or safety, as determined under construction safety and

health standards (29 CFR Part 1926) promulgated by the Secretary of Labor, in accordance with Section 107 of the Contract Work Hours and Safety Standards Act (40 U.S.C. 3704). 29 CFR 1926.10.

3. Pursuant to 29 CFR 1926.3, it is a condition of this contract that the Secretary of Labor or authorized representative thereof, shall have right of entry to any site of contract performance to inspect or investigate the matter of compliance with the construction safety and health standards and to carry out the duties of the Secretary under Section 107 of the Contract Work Hours and Safety Standards Act (40 U.S.C. 3704).

VIII. FALSE STATEMENTS CONCERNING HIGHWAY PROJECTS

This provision is applicable to all Federal-aid construction contracts and to all related subcontracts.

In order to assure high quality and durable construction in conformity with approved plans and specifications and a high degree of reliability on statements and representations made by engineers, contractors, suppliers, and workers on Federal-aid highway projects, it is essential that all persons concerned with the project perform their functions as carefully, thoroughly, and honestly as possible. Willful falsification, distortion, or misrepresentation with respect to any facts related to the project is a violation of Federal law. To prevent any misunderstanding regarding the seriousness of these and similar acts, Form FHWA-1022 shall be posted on each Federal-aid highway project (23 CFR Part 635) in one or more places where it is readily available to all persons concerned with the project:

18 U.S.C. 1020 reads as follows:

"Whoever, being an officer, agent, or employee of the United States, or of any State or Territory, or whoever, whether a person, association, firm, or corporation, knowingly makes any false statement, false representation, or false report as to the character, quality, quantity, or cost of the material used or to be used, or the quantity or quality of the work performed or to be performed, or the cost thereof in connection with the submission of plans, maps, specifications, contracts, or costs of construction on any highway or related project submitted for approval to the Secretary of Transportation; or

Whoever knowingly makes any false statement, false representation, false report or false claim with respect to the character, quality, quantity, or cost of any work performed or to be performed, or materials furnished or to be furnished, in connection with the construction of any highway or related project approved by the Secretary of Transportation; or

Whoever knowingly makes any false statement or false representation as to material fact in any statement, certificate, or report submitted pursuant to provisions of the Federal-aid Roads Act approved July 11, 1916, (39 Stat. 355), as amended and supplemented;

Shall be fined under this title or imprisoned not more than 5 years or both."

IX. IMPLEMENTATION OF CLEAN AIR ACT AND FEDERAL WATER POLLUTION CONTROL ACT (42 U.S.C. 7606; 2 CFR 200.88; EO 11738)

This provision is applicable to all Federal-aid construction contracts in excess of \$150,000 and to all related subcontracts. 48 CFR 2.101; 2 CFR 200.327.

By submission of this bid/proposal or the execution of this contract or subcontract, as appropriate, the bidder, proposer, Federal-aid construction contractor, subcontractor, supplier, or vendor agrees to comply with all applicable standards, orders or regulations issued pursuant to the Clean Air Act (42 U.S.C. 7401-7671q) and the Federal Water Pollution Control Act, as amended (33 U.S.C. 1251-1387). Violations must be reported to the Federal Highway Administration and the Regional Office of the Environmental Protection Agency. 2 CFR Part 200, Appendix II.

The contractor agrees to include or cause to be included the requirements of this Section in every subcontract, and further agrees to take such action as the contracting agency may direct as a means of enforcing such requirements. 2 CFR 200.327.

X. CERTIFICATION REGARDING DEBARMENT, SUSPENSION, INELIGIBILITY AND VOLUNTARY EXCLUSION

This provision is applicable to all Federal-aid construction contracts, design-build contracts, subcontracts, lower-tier subcontracts, purchase orders, lease agreements, consultant contracts or any other covered transaction requiring FHWA approval or that is estimated to cost \$25,000 or more – as defined in 2 CFR Parts 180 and 1200. 2 CFR 180.220 and 1200.220.

1. Instructions for Certification – First Tier Participants:

a. By signing and submitting this proposal, the prospective first tier participant is providing the certification set out below.

b. The inability of a person to provide the certification set out below will not necessarily result in denial of participation in this covered transaction. The prospective first tier participant shall submit an explanation of why it cannot provide the certification set out below. The certification or explanation will be considered in connection with the department or agency's determination whether to enter into this transaction. However, failure of the prospective first tier participant to furnish a certification or an explanation shall disqualify such a person from participation in this transaction. 2 CFR 180.320.

c. The certification in this clause is a material representation of fact upon which reliance was placed when the contracting agency determined to enter into this transaction. If it is later determined that the prospective participant knowingly rendered an erroneous certification, in addition to other remedies available to the Federal Government, the contracting agency may terminate this transaction for cause of default. 2 CFR 180.325.

d. The prospective first tier participant shall provide immediate written notice to the contracting agency to whom this proposal is submitted if any time the prospective first tier participant learns that its certification was erroneous when submitted or has become erroneous by reason of changed circumstances. 2 CFR 180.345 and 180.350.

e. The terms "covered transaction," "debarred," "suspended," "ineligible," "participant," "person," "principal," and "voluntarily excluded," as used in this clause, are defined in 2 CFR Parts 180, Subpart I, 180.900-180.1020, and 1200. "First Tier Covered Transactions" refers to any covered transaction between a recipient or subrecipient of Federal funds and a participant (such as the prime or general contract). "Lower Tier Covered Transactions" refers to any covered transaction under a First Tier Covered Transaction (such as subcontracts). "First Tier Participant" refers to the participant who has entered into a covered transaction with a recipient or subrecipient of Federal funds (such as the prime or general contractor). "Lower Tier Participant" refers any participant who has entered into a covered transaction with a First Tier Participant or other Lower Tier Participants (such as subcontractors and suppliers).

f. The prospective first tier participant agrees by submitting this proposal that, should the proposed covered transaction be entered into, it shall not knowingly enter into any lower tier covered transaction with a person who is debarred, suspended, declared ineligible, or voluntarily excluded from participation in this covered transaction, unless authorized by the department or agency entering into this transaction. 2 CFR 180.330.

g. The prospective first tier participant further agrees by submitting this proposal that it will include the clause titled "Certification Regarding Debarment, Suspension, Ineligibility and Voluntary Exclusion-Lower Tier Covered Transactions," provided by the department or contracting agency, entering into this covered transaction, without modification, in all lower tier covered transactions and in all solicitations for lower tier covered transactions exceeding the \$25,000 threshold. 2 CFR 180.220 and 180.300.

h. A participant in a covered transaction may rely upon a certification of a prospective participant in a lower tier covered transaction that is not debarred, suspended, ineligible, or voluntarily excluded from the covered transaction, unless it knows that the certification is erroneous. 2 CFR 180.300; 180.320, and 180.325. A participant is responsible for ensuring that its principals are not suspended, debarred, or otherwise ineligible to participate in covered transactions. 2 CFR 180.335. To verify the eligibility of its principals, as well as the eligibility of any lower tier prospective participants, each participant may, but is not required to, check the System for Award Management website (<https://www.sam.gov>). 2 CFR 180.300, 180.320, and 180.325.

i. Nothing contained in the foregoing shall be construed to require the establishment of a system of records in order to render in good faith the certification required by this clause. The knowledge and information of the prospective participant is not required to exceed that which is normally possessed by a prudent person in the ordinary course of business dealings.

j. Except for transactions authorized under paragraph (f) of these instructions, if a participant in a covered transaction knowingly enters into a lower tier covered transaction with a person who is suspended, debarred, ineligible, or voluntarily excluded from participation in this transaction, in addition to other remedies available to the Federal Government, the department or agency may terminate this transaction for cause or default. 2 CFR 180.325.

* * * * *

2. Certification Regarding Debarment, Suspension, Ineligibility and Voluntary Exclusion – First Tier Participants:

a. The prospective first tier participant certifies to the best of its knowledge and belief, that it and its principals:

(1) Are not presently debarred, suspended, proposed for debarment, declared ineligible, or voluntarily excluded from participating in covered transactions by any Federal department or agency, 2 CFR 180.335;

(2) Have not within a three-year period preceding this proposal been convicted of or had a civil judgment rendered against them for commission of fraud or a criminal offense in connection with obtaining, attempting to obtain, or performing a public (Federal, State, or local) transaction or contract under a public transaction; violation of Federal or State antitrust statutes or commission of embezzlement, theft, forgery, bribery, falsification or destruction of records, making false statements, or receiving stolen property, 2 CFR 180.800;

(3) Are not presently indicted for or otherwise criminally or civilly charged by a governmental entity (Federal, State or local) with commission of any of the offenses enumerated in paragraph (a)(2) of this certification, 2 CFR 180.700 and 180.800; and

(4) Have not within a three-year period preceding this application/proposal had one or more public transactions (Federal, State or local) terminated for cause or default. 2 CFR 180.335(d).

(5) Are not a corporation that has been convicted of a felony violation under any Federal law within the two-year period preceding this proposal (USDOT Order 4200.6 implementing appropriations act requirements); and

(6) Are not a corporation with any unpaid Federal tax liability that has been assessed, for which all judicial and administrative remedies have been exhausted, or have lapsed, and that is not being paid in a timely manner pursuant to an agreement with the authority responsible for collecting the tax liability (USDOT Order 4200.6 implementing appropriations act requirements).

b. Where the prospective participant is unable to certify to any of the statements in this certification, such prospective participant should attach an explanation to this proposal. 2 CFR 180.335 and 180.340.

* * * * *

3. Instructions for Certification - Lower Tier Participants:

(Applicable to all subcontracts, purchase orders, and other lower tier transactions requiring prior FHWA approval or estimated to cost \$25,000 or more - 2 CFR Parts 180 and 1200). 2 CFR 180.220 and 1200.220.

a. By signing and submitting this proposal, the prospective lower tier participant is providing the certification set out below.

b. The certification in this clause is a material representation of fact upon which reliance was placed when this transaction was entered into. If it is later determined that the prospective lower tier participant knowingly rendered an erroneous certification, in addition to other remedies available to the Federal Government, the department, or agency with which

this transaction originated may pursue available remedies, including suspension and/or debarment.

c. The prospective lower tier participant shall provide immediate written notice to the person to which this proposal is submitted if at any time the prospective lower tier participant learns that its certification was erroneous by reason of changed circumstances. 2 CFR 180.365.

d. The terms "covered transaction," "debarred," "suspended," "ineligible," "participant," "person," "principal," and "voluntarily excluded," as used in this clause, are defined in 2 CFR Parts 180, Subpart I, 180.900 – 180.1020, and 1200. You may contact the person to which this proposal is submitted for assistance in obtaining a copy of those regulations. "First Tier Covered Transactions" refers to any covered transaction between a recipient or subrecipient of Federal funds and a participant (such as the prime or general contract). "Lower Tier Covered Transactions" refers to any covered transaction under a First Tier Covered Transaction (such as subcontracts). "First Tier Participant" refers to the participant who has entered into a covered transaction with a recipient or subrecipient of Federal funds (such as the prime or general contractor). "Lower Tier Participant" refers any participant who has entered into a covered transaction with a First Tier Participant or other Lower Tier Participants (such as subcontractors and suppliers).

e. The prospective lower tier participant agrees by submitting this proposal that, should the proposed covered transaction be entered into, it shall not knowingly enter into any lower tier covered transaction with a person who is debarred, suspended, declared ineligible, or voluntarily excluded from participation in this covered transaction, unless authorized by the department or agency with which this transaction originated. 2 CFR 1200.220 and 1200.332.

f. The prospective lower tier participant further agrees by submitting this proposal that it will include this clause titled "Certification Regarding Debarment, Suspension, Ineligibility and Voluntary Exclusion-Lower Tier Covered Transaction," without modification, in all lower tier covered transactions and in all solicitations for lower tier covered transactions exceeding the \$25,000 threshold. 2 CFR 180.220 and 1200.220.

g. A participant in a covered transaction may rely upon a certification of a prospective participant in a lower tier covered transaction that is not debarred, suspended, ineligible, or voluntarily excluded from the covered transaction, unless it knows that the certification is erroneous. A participant is responsible for ensuring that its principals are not suspended, debarred, or otherwise ineligible to participate in covered transactions. To verify the eligibility of its principals, as well as the eligibility of any lower tier prospective participants, each participant may, but is not required to, check the System for Award Management website (<https://www.sam.gov>), which is compiled by the General Services Administration. 2 CFR 180.300, 180.320, 180.330, and 180.335.

h. Nothing contained in the foregoing shall be construed to require establishment of a system of records in order to render in good faith the certification required by this clause. The knowledge and information of participant is not required to exceed that which is normally possessed by a prudent person in the ordinary course of business dealings.

i. Except for transactions authorized under paragraph e of these instructions, if a participant in a covered transaction knowingly enters into a lower tier covered transaction with a person who is suspended, debarred, ineligible, or voluntarily

excluded from participation in this transaction, in addition to other remedies available to the Federal Government, the department or agency with which this transaction originated may pursue available remedies, including suspension and/or debarment. 2 CFR 180.325.

* * * * *

4. Certification Regarding Debarment, Suspension, Ineligibility and Voluntary Exclusion--Lower Tier Participants:

a. The prospective lower tier participant certifies, by submission of this proposal, that neither it nor its principals:

(1) is presently debarred, suspended, proposed for debarment, declared ineligible, or voluntarily excluded from participating in covered transactions by any Federal department or agency, 2 CFR 180.355;

(2) is a corporation that has been convicted of a felony violation under any Federal law within the two-year period preceding this proposal (USDOT Order 4200.6 implementing appropriations act requirements); and

(3) is a corporation with any unpaid Federal tax liability that has been assessed, for which all judicial and administrative remedies have been exhausted, or have lapsed, and that is not being paid in a timely manner pursuant to an agreement with the authority responsible for collecting the tax liability. (USDOT Order 4200.6 implementing appropriations act requirements)

b. Where the prospective lower tier participant is unable to certify to any of the statements in this certification, such prospective participant should attach an explanation to this proposal.

* * * * *

XI. CERTIFICATION REGARDING USE OF CONTRACT FUNDS FOR LOBBYING

This provision is applicable to all Federal-aid construction contracts and to all related subcontracts which exceed \$100,000. 49 CFR Part 20, App. A.

1. The prospective participant certifies, by signing and submitting this bid or proposal, to the best of his or her knowledge and belief, that:

a. No Federal appropriated funds have been paid or will be paid, by or on behalf of the undersigned, to any person for influencing or attempting to influence an officer or employee of any Federal agency, a Member of Congress, an officer or employee of Congress, or an employee of a Member of Congress in connection with the awarding of any Federal contract, the making of any Federal grant, the making of any Federal loan, the entering into of any cooperative agreement, and the extension, continuation, renewal, amendment, or modification of any Federal contract, grant, loan, or cooperative agreement.

b. If any funds other than Federal appropriated funds have been paid or will be paid to any person for influencing or attempting to influence an officer or employee of any Federal agency, a Member of Congress, an officer or employee of Congress, or an employee of a Member of Congress in connection with this Federal contract, grant, loan, or

cooperative agreement, the undersigned shall complete and submit Standard Form-LLL, "Disclosure Form to Report Lobbying," in accordance with its instructions.

2. This certification is a material representation of fact upon which reliance was placed when this transaction was made or entered into. Submission of this certification is a prerequisite for making or entering into this transaction imposed by 31 U.S.C. 1352. Any person who fails to file the required certification shall be subject to a civil penalty of not less than \$10,000 and not more than \$100,000 for each such failure.

3. The prospective participant also agrees by submitting its bid or proposal that the participant shall require that the language of this certification be included in all lower tier subcontracts, which exceed \$100,000 and that all such recipients shall certify and disclose accordingly.

XII. USE OF UNITED STATES-FLAG VESSELS:

This provision is applicable to all Federal-aid construction contracts, design-build contracts, subcontracts, lower-tier subcontracts, purchase orders, lease agreements, or any other covered transaction. 46 CFR Part 381.

This requirement applies to material or equipment that is acquired for a specific Federal-aid highway project. 46 CFR 381.7. It is not applicable to goods or materials that come into inventories independent of an FHWA funded-contract.

When oceanic shipments (or shipments across the Great Lakes) are necessary for materials or equipment acquired for a specific Federal-aid construction project, the bidder, proposer, contractor, subcontractor, or vendor agrees:

1. To utilize privately owned United States-flag commercial vessels to ship at least 50 percent of the gross tonnage (computed separately for dry bulk carriers, dry cargo liners, and tankers) involved, whenever shipping any equipment, material, or commodities pursuant to this contract, to the extent such vessels are available at fair and reasonable rates for United States-flag commercial vessels. 46 CFR 381.7.

2. To furnish within 20 days following the date of loading for shipments originating within the United States or within 30 working days following the date of loading for shipments originating outside the United States, a legible copy of a rated, 'on-board' commercial ocean bill-of-lading in English for each shipment of cargo described in paragraph (b)(1) of this section to both the Contracting Officer (through the prime contractor in the case of subcontractor bills-of-lading) and to the Office of Cargo and Commercial Sealift (MAR-620), Maritime Administration, Washington, DC 20590. (MARAD requires copies of the ocean carrier's (master) bills of lading, certified onboard, dated, with rates and charges. These bills of lading may contain business sensitive information and therefore may be submitted directly to MARAD by the Ocean Transportation Intermediary on behalf of the contractor). 46 CFR 381.7.

**ATTACHMENT A - EMPLOYMENT AND MATERIALS
PREFERENCE FOR APPALACHIAN DEVELOPMENT HIGHWAY
SYSTEM OR APPALACHIAN LOCAL ACCESS**

ROAD CONTRACTS (23 CFR 633, Subpart B, Appendix B)

This provision is applicable to all Federal-aid projects funded under the Appalachian Regional Development Act of 1965.

1. During the performance of this contract, the contractor undertaking to do work which is, or reasonably may be, done as on-site work, shall give preference to qualified persons who regularly reside in the labor area as designated by the DOL wherein the contract work is situated, or the subregion, or the Appalachian counties of the State wherein the contract work is situated, except:

a. To the extent that qualified persons regularly residing in the area are not available.

b. For the reasonable needs of the contractor to employ supervisory or specially experienced personnel necessary to assure an efficient execution of the contract work.

c. For the obligation of the contractor to offer employment to present or former employees as the result of a lawful collective bargaining contract, provided that the number of nonresident persons employed under this subparagraph (1c) shall not exceed 20 percent of the total number of employees employed by the contractor on the contract work, except as provided in subparagraph (4) below.

2. The contractor shall place a job order with the State Employment Service indicating (a) the classifications of the laborers, mechanics and other employees required to perform the contract work, (b) the number of employees required in each classification, (c) the date on which the participant estimates such employees will be required, and (d) any other pertinent information required by the State Employment Service to complete the job order form. The job order may be placed with the State Employment Service in writing or by telephone. If during the course of the contract work, the information submitted by the contractor in the original job order is substantially modified, the participant shall promptly notify the State Employment Service.

3. The contractor shall give full consideration to all qualified job applicants referred to him by the State Employment Service. The contractor is not required to grant employment to any job applicants who, in his opinion, are not qualified to perform the classification of work required.

4. If, within one week following the placing of a job order by the contractor with the State Employment Service, the State Employment Service is unable to refer any qualified job applicants to the contractor, or less than the number requested, the State Employment Service will forward a certificate to the contractor indicating the unavailability of applicants. Such certificate shall be made a part of the contractor's permanent project records. Upon receipt of this certificate, the contractor may employ persons who do not normally reside in the labor area to fill positions covered by the certificate, notwithstanding the provisions of subparagraph (1c) above.

5. The provisions of 23 CFR 633.207(e) allow the contracting agency to provide a contractual preference for the use of mineral resource materials native to the Appalachian region.

6. The contractor shall include the provisions of Sections 1 through 4 of this Attachment A in every subcontract for work which is, or reasonably may be, done as on-site work.