

F.A.I. RTE.	SECTION	COUNTY	TOTAL SHEETS	SHEET NO.
270	60-(2,3)I	MADISON	32	16
STA.		TO STA.		
FED. ROAD DIST. NO.	ILLINOIS	FED. AID PROJECT		

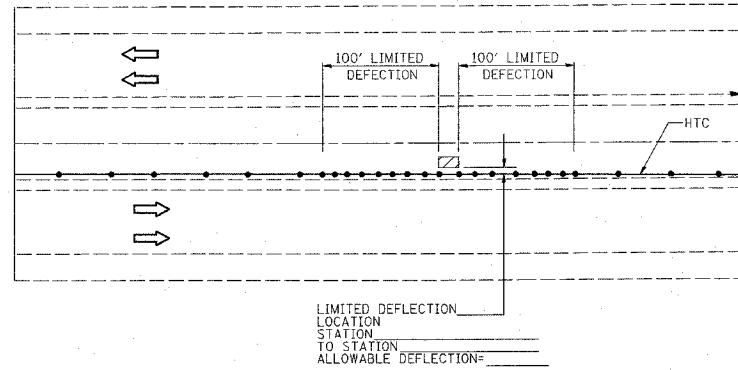

HTC LAYOUT & PLAN NOTATION FOR LIMITED DEFLECTION LOCATION

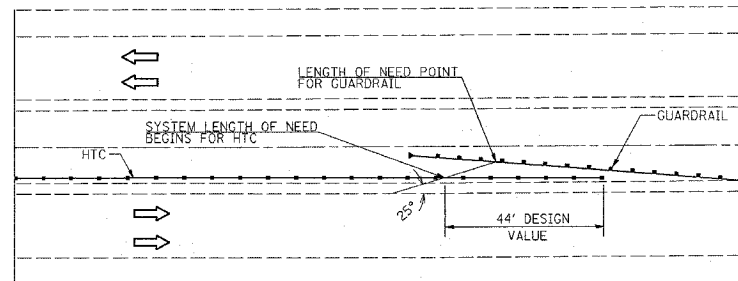

HTC LAYOUT FOR TERMINATION IN FRONT OF FLARED GUARDRAIL

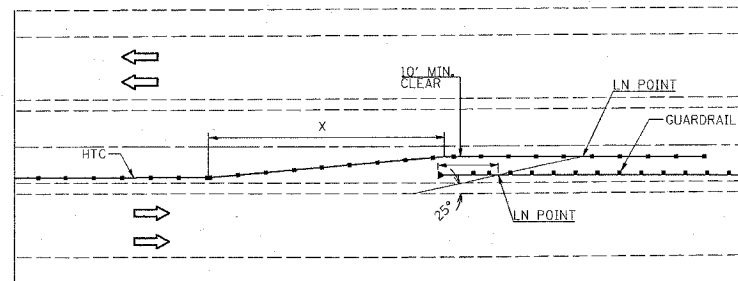

HTC LAYOUT FOR TERMINATION BEHIND TANGENT GUARDRAIL

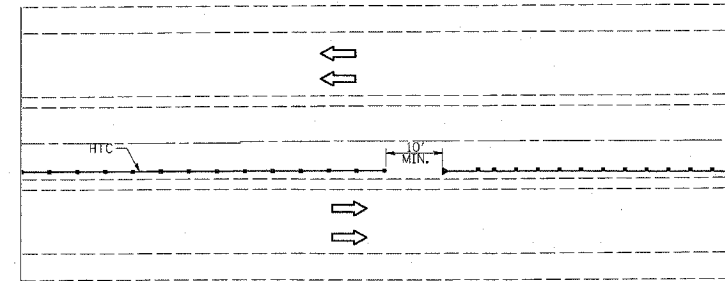

HTC LAYOUT ADJACENT TO GUARDRAIL

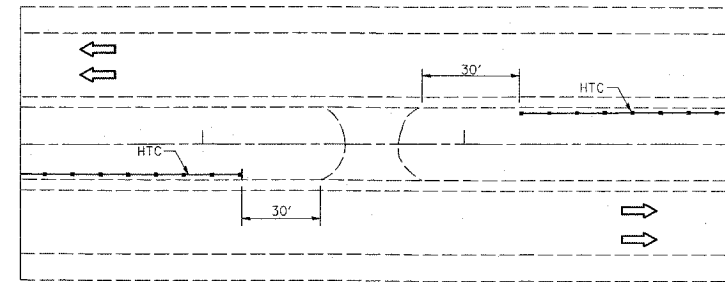

HTC LAYOUT AT MEDIAN CROSSOVERS

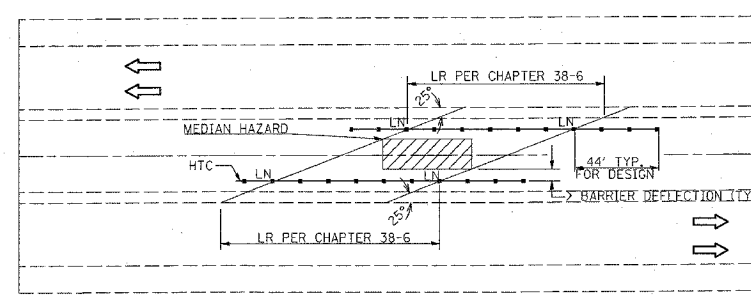

HTC LAYOUT FOR MEDIAN HAZARD PROTECTION

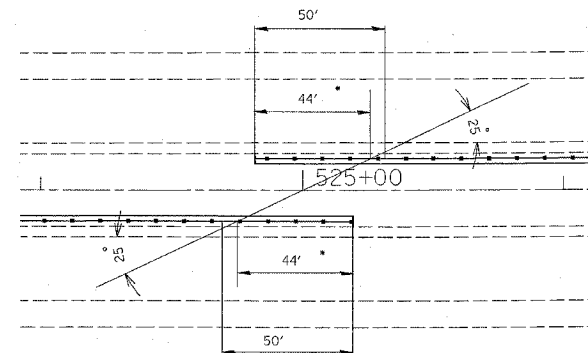

HTC LAYOUT FOR PLACEMENT ON OPPOSITE SIDES

• FOR PURPOSES OF HTC LAYOUT SHOWN IN PLANS, 44' FOR LON POINT WAS USED. ACTUAL LON POINT WILL VARY DEPENDING ON HTC SYSTEM USED.

PAY LENGTH FOR HTC MEDIAN BARRIER TERMINAL IS 50' REGARDLESS OF LON POINT.

PLOT DATE = #DATE#  
 FILE NAME = #FILE#  
 PLOT SCALE = #SCALE#  
 REFERENCE = #REF#

REVISIONS	
NAME	DATE

ILLINOIS DEPARTMENT OF TRANSPORTATION  
**HTC DETAILS**  
 FAI RTE 270  
 SECTION 60-(2,3)I  
 MADISON COUNTY

SCALE: VERT. \_\_\_\_\_  
 HORIZ. \_\_\_\_\_

DATE \_\_\_\_\_ DRAWN BY \_\_\_\_\_  
 CHECKED BY \_\_\_\_\_