

F.A.P. RTE.	SECTION	COUNTY	TOTAL SHEETS	SHEET No.
315	34-5	HANCOCK	612	73
STA. 1174+00.00 TO STA. 1388+18.00				
FED. ROAD DIST. No. ILLINOIS FED. AID PROJECT				

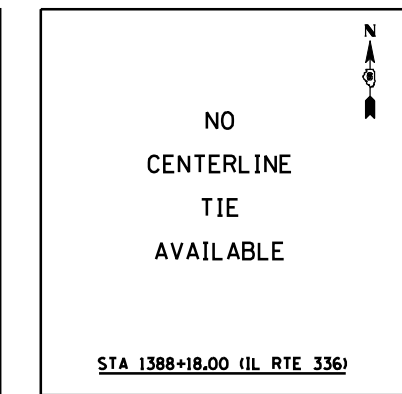
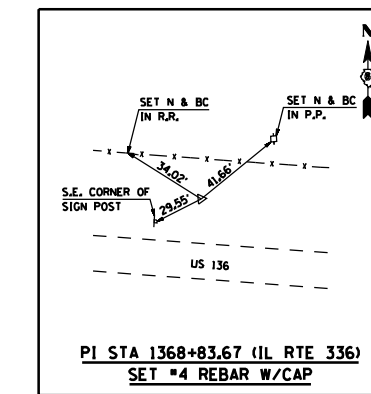
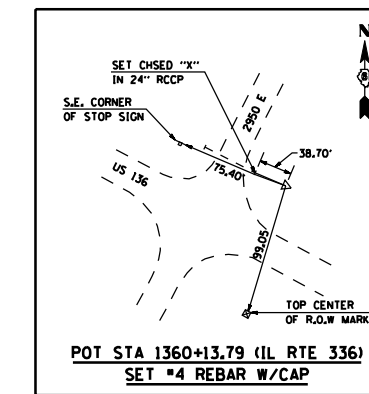
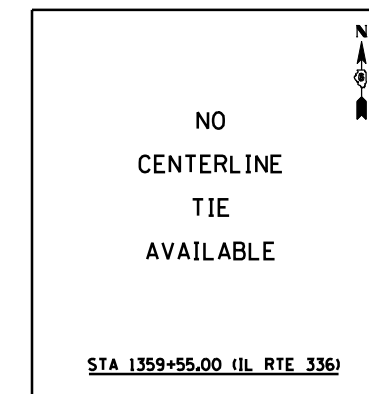
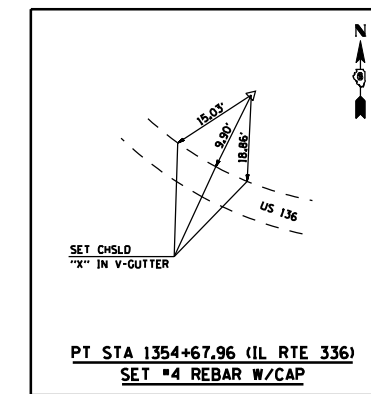
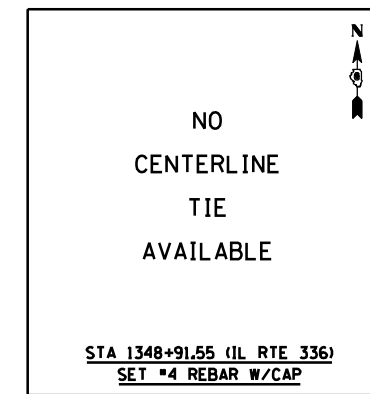
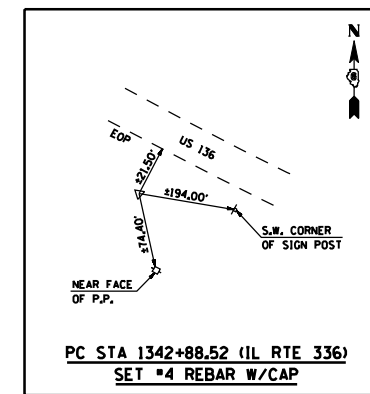
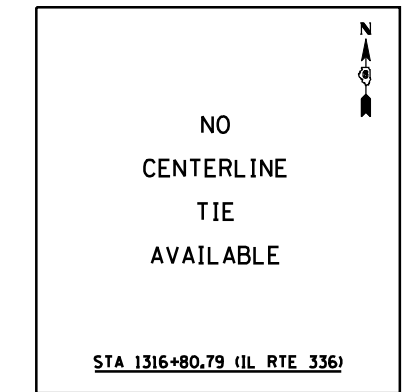
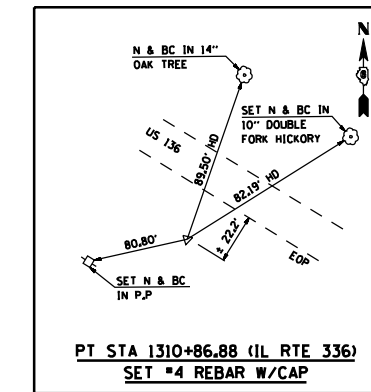
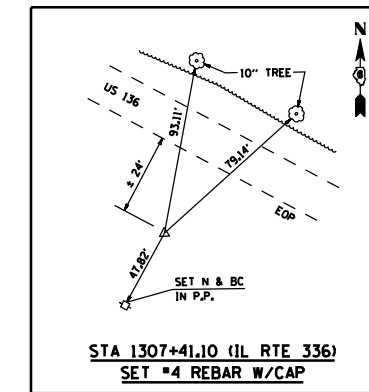
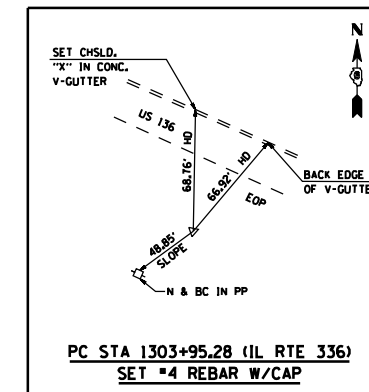
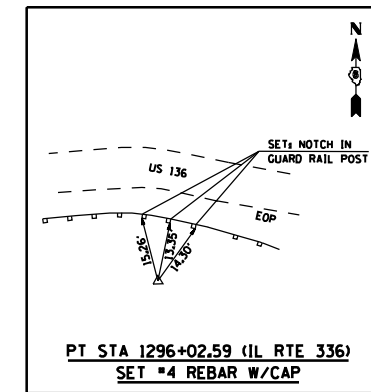
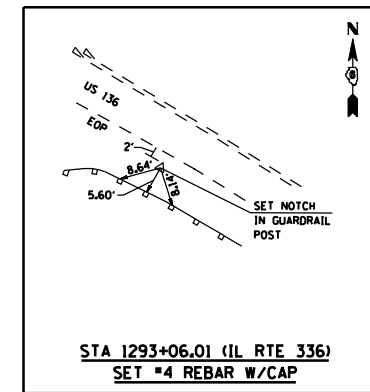
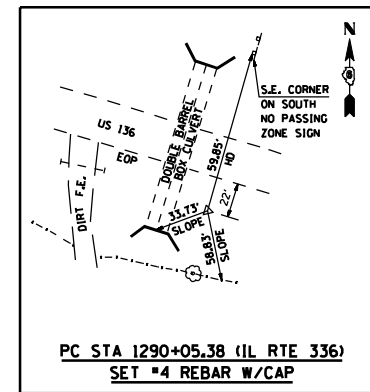
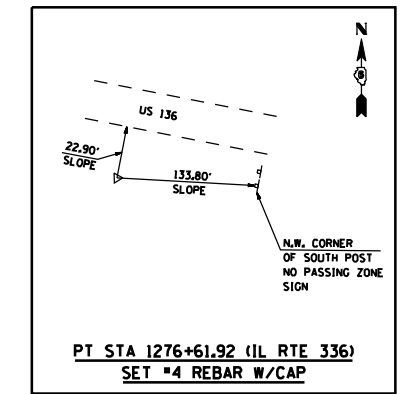
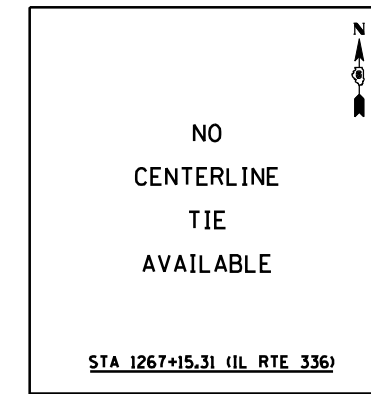
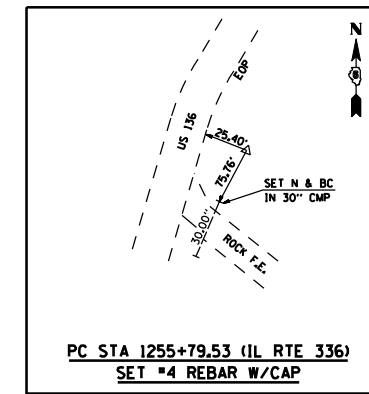
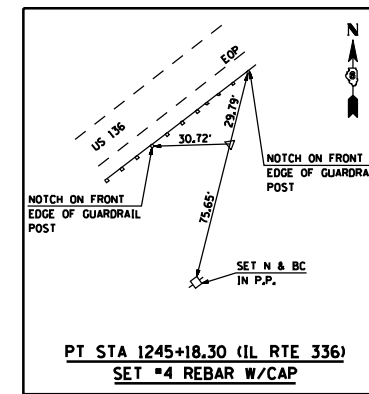
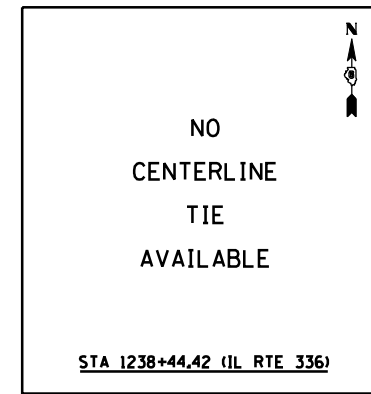
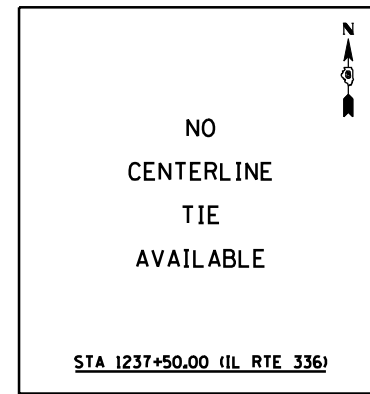
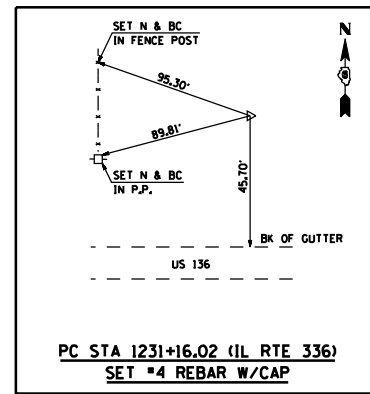
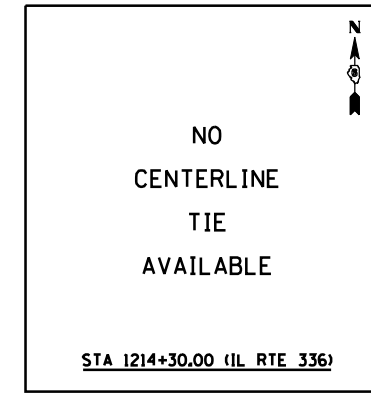
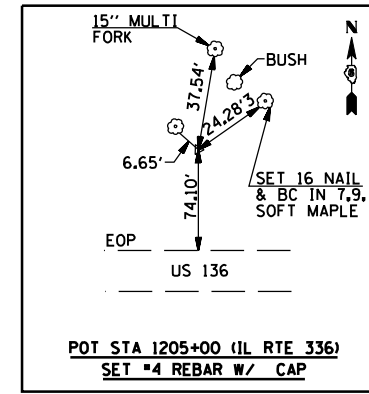
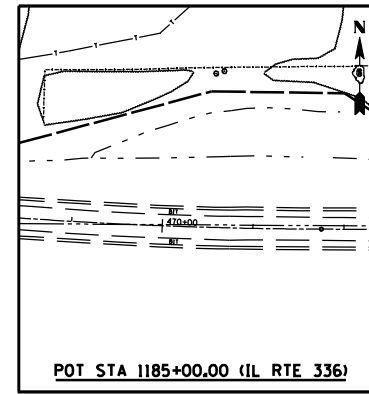
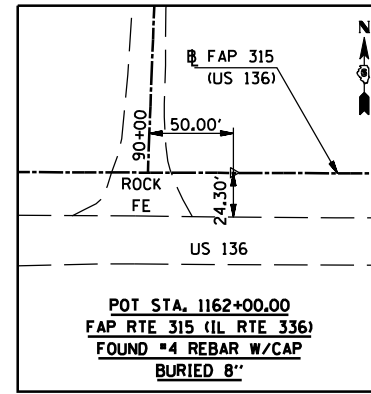
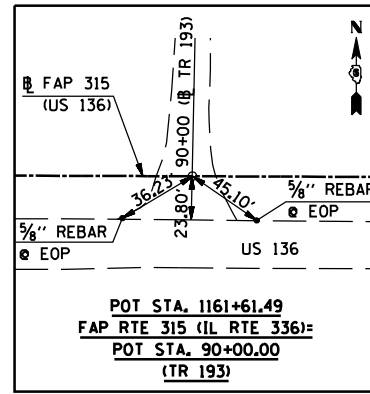
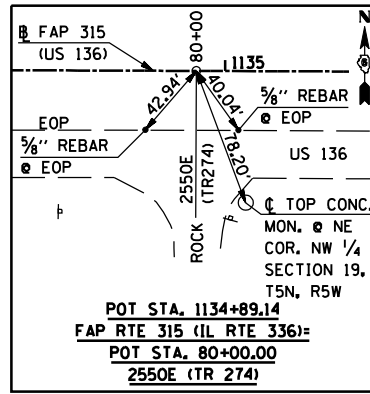

•DGN-SPEC*
•DATE-TIME*
•REF01