

F.A.I. RTE.	SECTION	COUNTY	TOTAL SHEETS	SHEET NO.
57	10-32HB-3,K	Champaign	352	165
STA.		TO STA.		
FED. ROAD DIST. NO.		ILLINOIS	FED. AID PROJECT	
CONTRACT NO. 90758				

DETAIL OF BOX CULVERT END SECTION

A.R. BOX CULVERT 1 @ 10.0' X 2'

STA. 245 + 91.59 (CULVERT NO. 26)

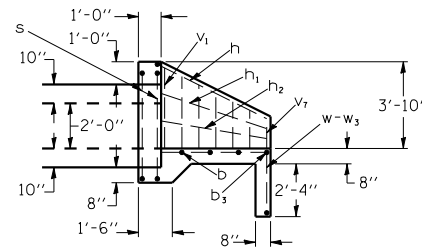

SECTION A - A

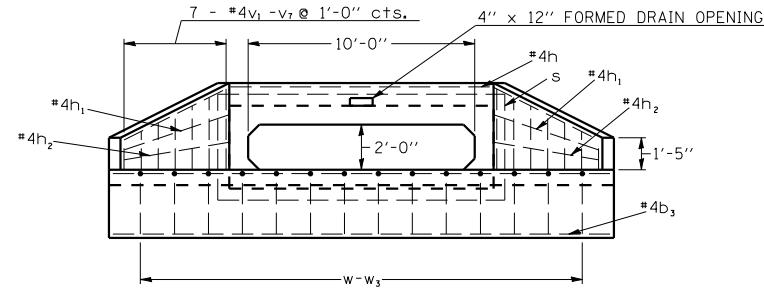

END VIEW

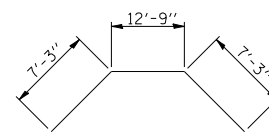

BAR h

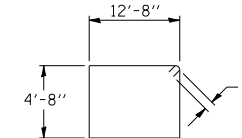

BAR s

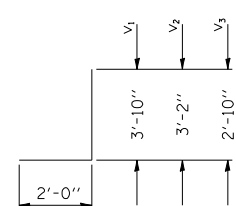

v BARS

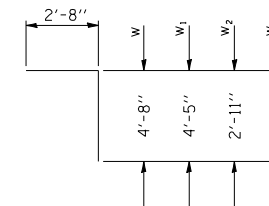

w BARS

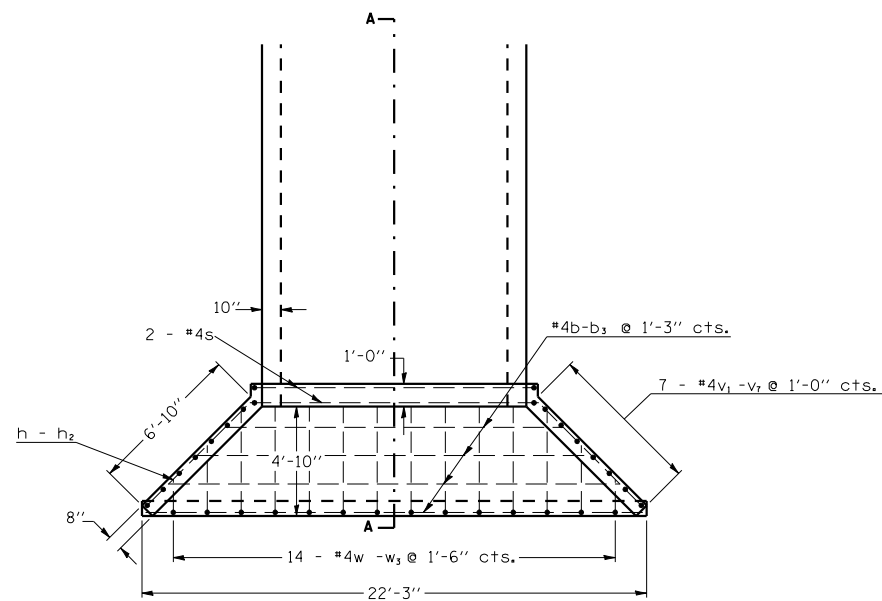

PLAN

BILL OF MATERIAL (ONE HEADWALL)

Bar	No.	Size	Length (ft)	Shape
b	1	#4	14'-11"	—
b1	1	#4	17'-5"	—
b2	1	#4	19'-11"	—
b3	2	#4	21'-11"	—
h	1	#4	27'-3"	—
h1	2	#4	7'-0"	—
h2	2	#4	6'-10"	—
s	2	#4	34'-8"	—
v1	2	#4	5'-10"	┘
v2	2	#4	5'-2"	┘
v3	2	#4	4'-10"	┘
v4	2	#4	4'-5"	┘
v5	2	#4	4'-1"	┘
v6	2	#4	3'-8"	┘
v7	2	#4	3'-4"	┘
w	8	#4	7'-4"	┘
w1	2	#4	7'-1"	┘
w2	2	#4	5'-7"	┘
w3	2	#4	4'-1"	┘

Reinforcement Bars	LB.	252
Class SI Conc. Hdwall, CU. YD.		5.8

ITEM	UNIT	QUANT.
Box Culvert End Sec. Culvert No. 26	EACH	2

NOTES

- All bars should be rounded and shall conform to the requirements of Art. 1006.10 of Standard Specs.
- Class SI Concrete shall be used throughout.
- The Precast Concrete Box Culvert Sections shall conform to the requirements of AASHTO M259.
- All dimensions are in FEET (')-INCHES (") unless otherwise noted.
- Concrete and Rebar quantities and lengths calculated for the cast-in-place End Sections will vary based on the precast box culverts supplied.
- End Sections will be paid for at the contract unit price each for BOX CULVERT END SECTION CULVERT NO., as outlined in Art. 540.08, which prices shall include all concrete, rebar, and all other items necessary to complete the proposed work.
- Drain holes shall be provided in accordance with Art. 503.12.
- Drawings not to scale.

BOX CULVERT END SECTIONS (CAST IN PLACE)
1 @ 10.0' X 2'
STA. 245+91.59 NO SKEW

REVISIONS		ILLINOIS DEPARTMENT OF TRANSPORTATION
NAME	DATE	
		CULVERT DETAILS

SCALE: VERT. DATE 110904
DRAWN BY JDC
CHECKED BY