

F.A.I. DIST.	SECTION	COUNTY	TOTAL SHEETS	SHEET NO.
155	QA DARRIS ROL	TAZEWELL	10	9
STA. 665+90.43		TO STA. 671+00.20		
FED. ROAD DIST. NO. 4 ILLINOIS FED. AID PROJECT				

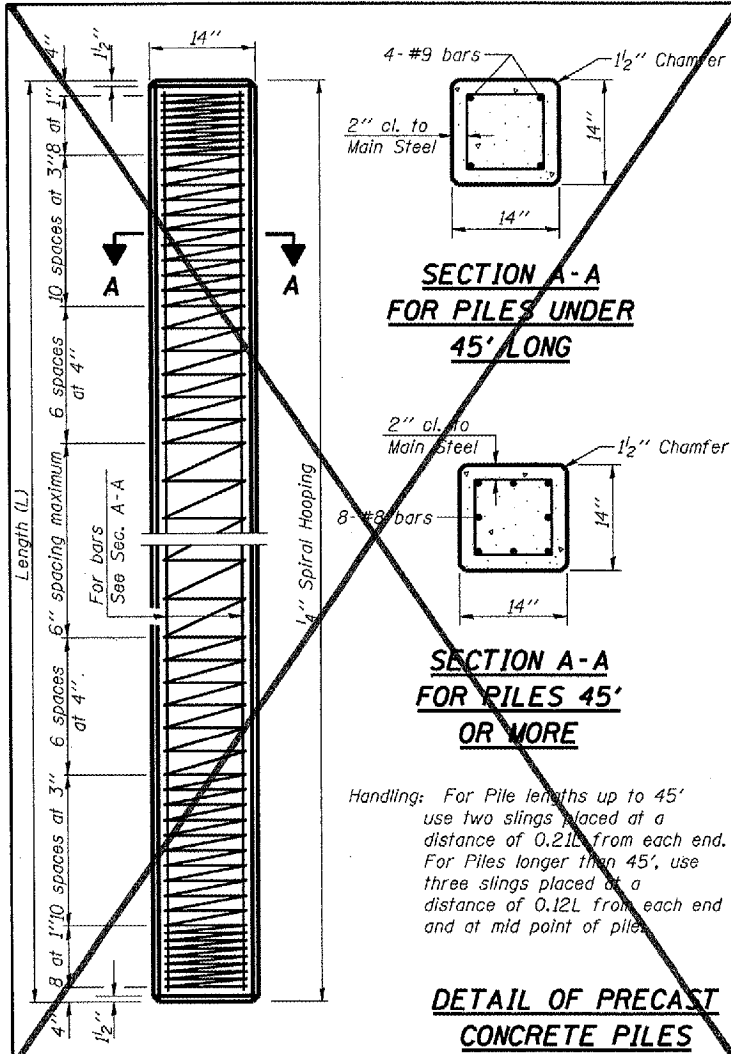

Handling: For Pile lengths up to 45' use two slings placed at a distance of 0.21L from each end. For Piles longer than 45', use three slings placed at a distance of 0.12L from each end and at mid point of pile.

DETAIL OF PRECAST CONCRETE PILES

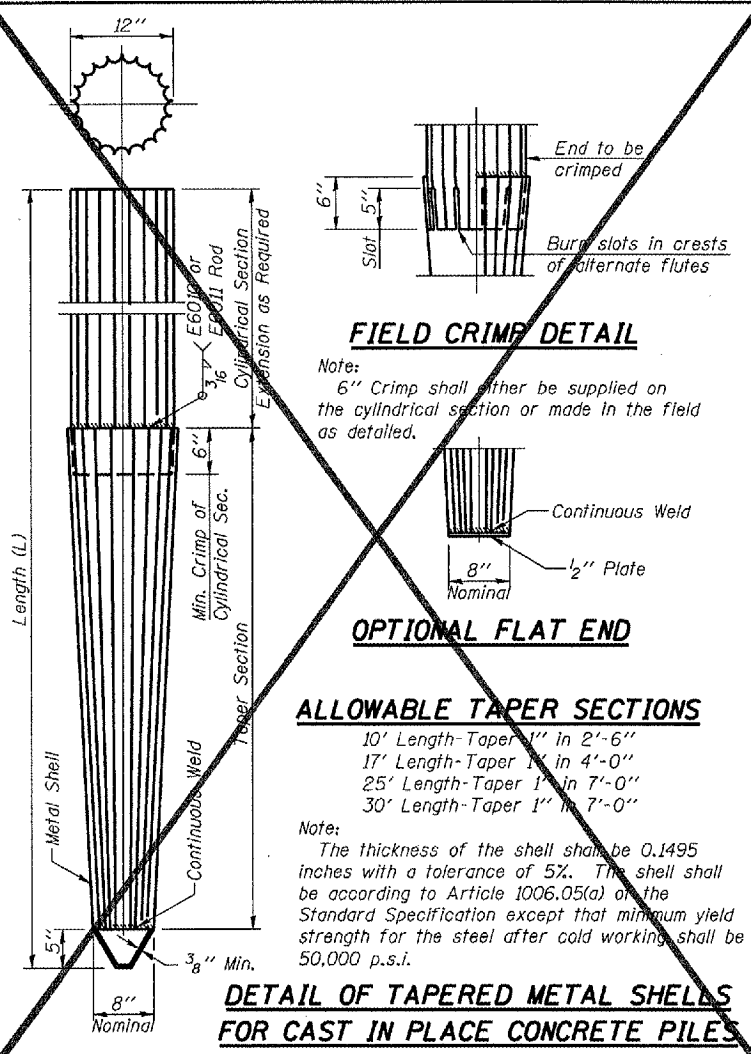

DETAIL OF TAPERED METAL SHELLS FOR CAST IN PLACE CONCRETE PILES

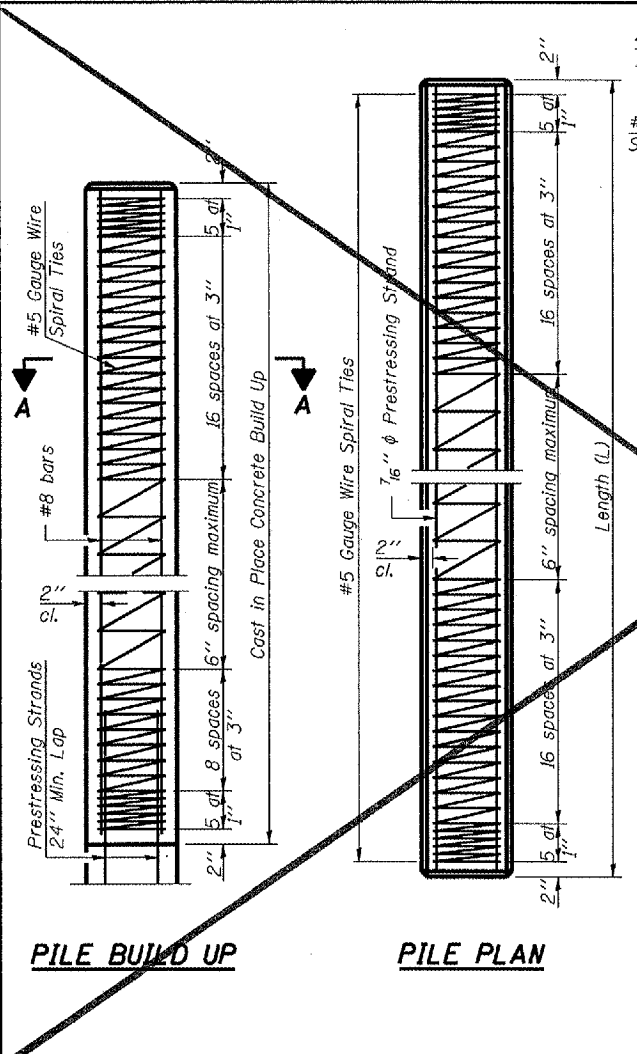

PILE BUILD UP and **PILE PLAN**

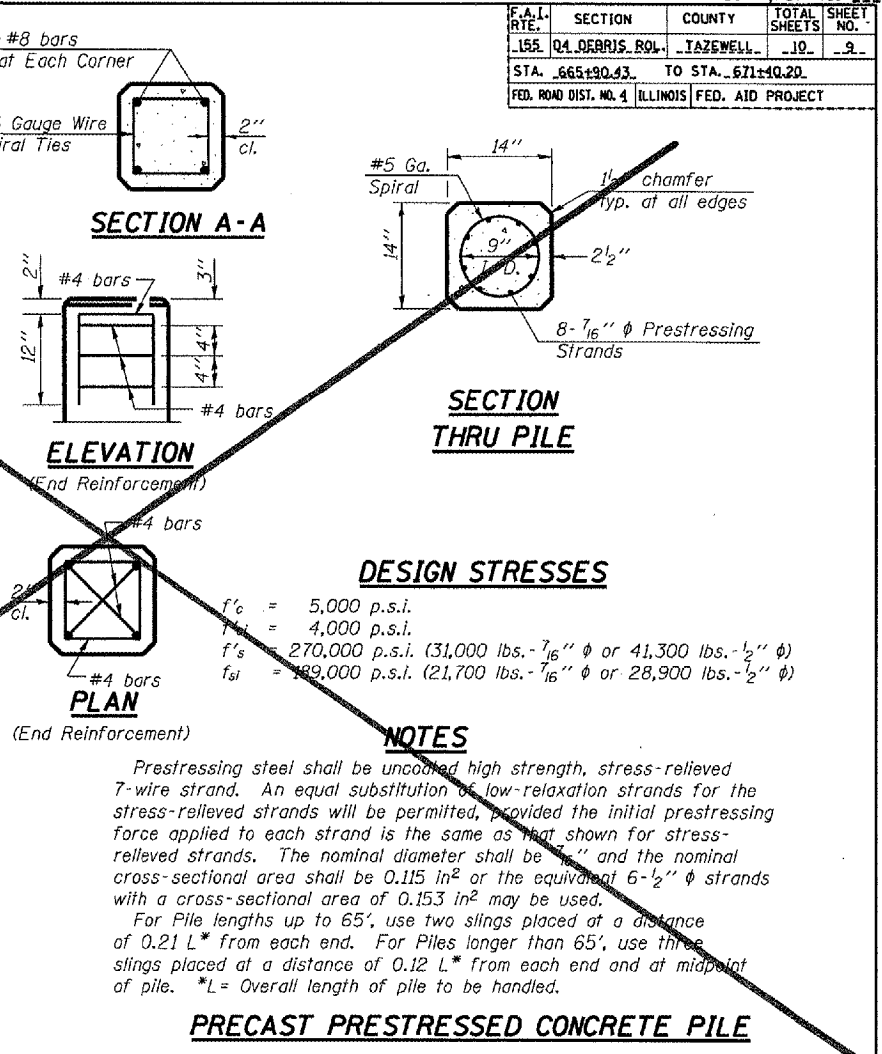

PRECAST PRESTRESSED CONCRETE PILE

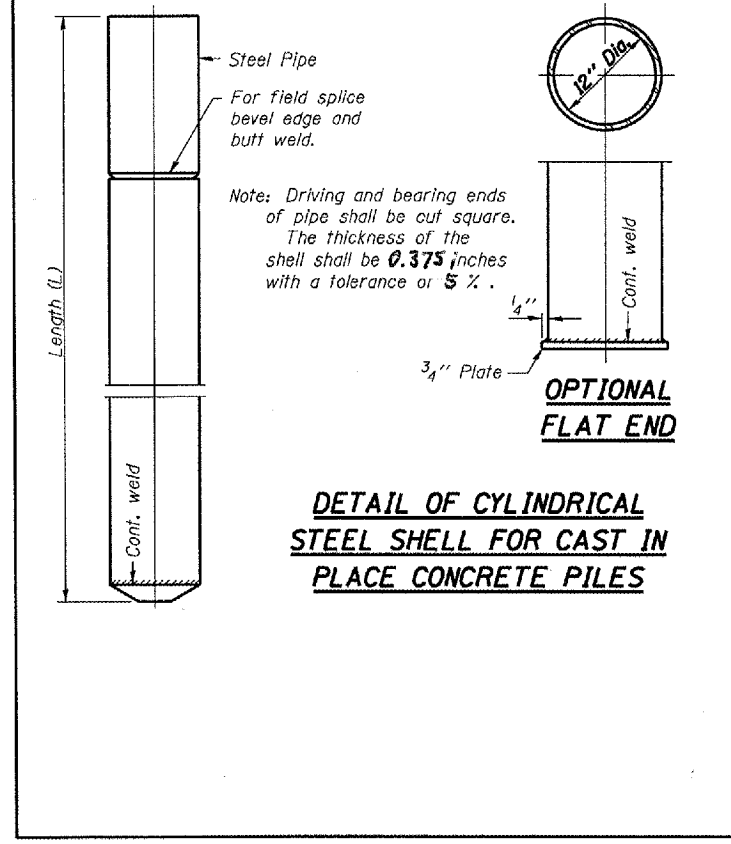

DETAIL OF CYLINDRICAL STEEL SHELL FOR CAST IN PLACE CONCRETE PILES

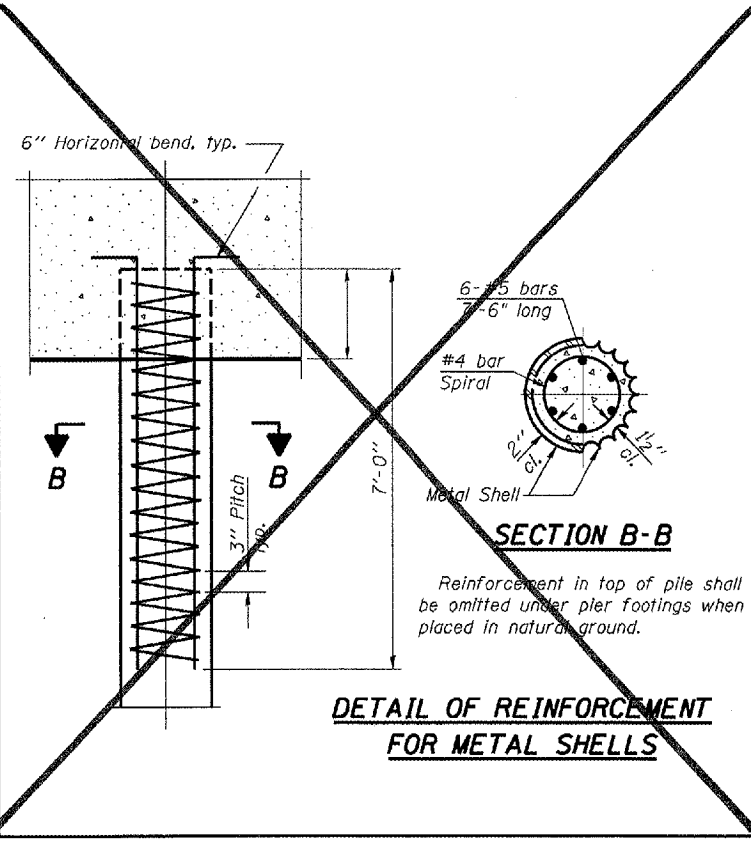

DETAIL OF REINFORCEMENT FOR METAL SHELLS

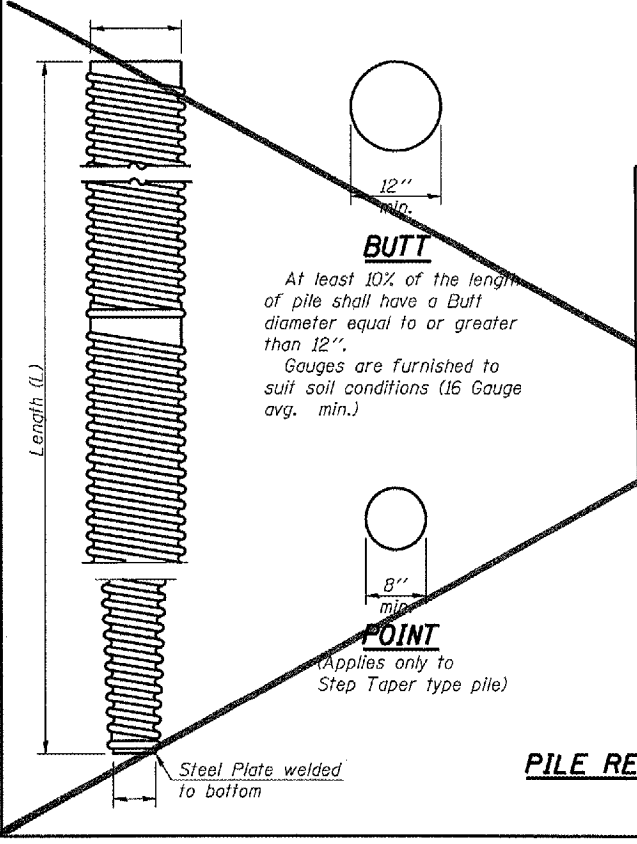

PILE REINFORCEMENT

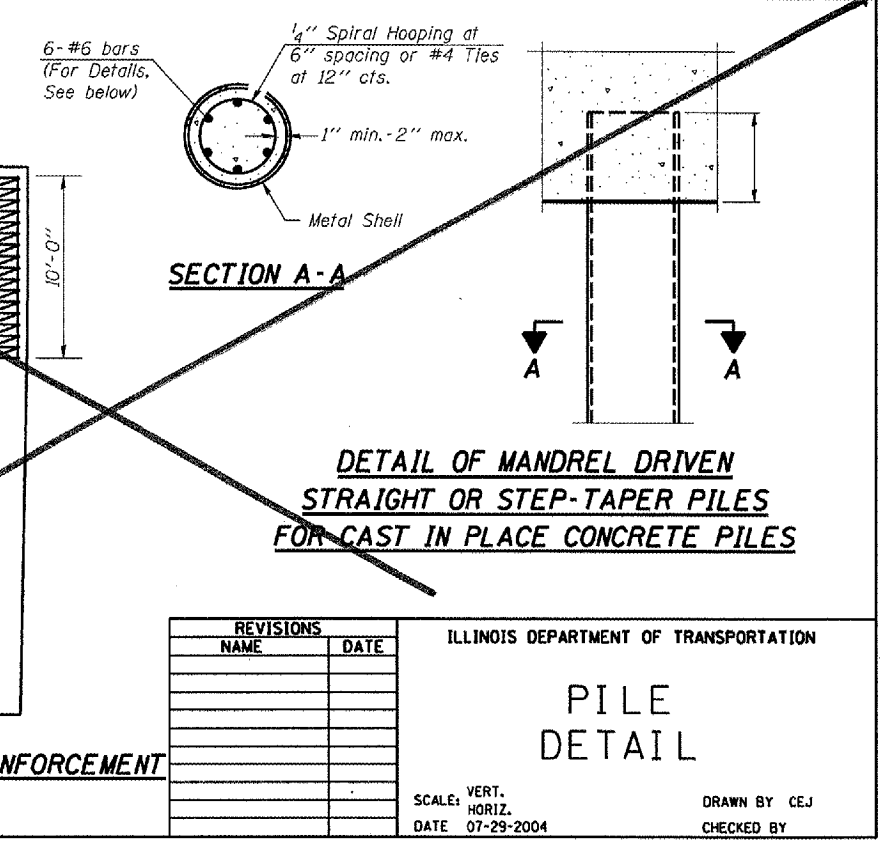

DETAIL OF MANDREL DRIVEN STRAIGHT OR STEP-TAPER PILES FOR CAST IN PLACE CONCRETE PILES

REVISIONS	
NAME	DATE

ILLINOIS DEPARTMENT OF TRANSPORTATION

PILE DETAIL

SCALE: VERT. HORIZ. DATE 07-29-2004

DRAWN BY CEJ
CHECKED BY

PLT DATE
FILE NAME
PLT SCALE
REFERENCE