

If you plan to submit a bid directly to the Department of Transportation

PREQUALIFICATION

Any contractor who desires to become pre-qualified to bid on work advertised by IDOT must submit the properly completed pre-qualification forms to the Bureau of Construction no later than 4:30 p.m. prevailing time twenty-one days prior to the letting of interest. This pre-qualification requirement applies to first time contractors, contractors renewing expired ratings, contractors maintaining continuous pre-qualification or contractors requesting revised ratings. To be eligible to bid, existing pre-qualification ratings must be effective through the date of letting.

REQUESTS FOR AUTHORIZATION TO BID

Contractors wanting to bid on items included in a particular letting must submit the properly completed "Request for Authorization to Bid/or Not For Bid Status" (BDE 124) and the ORIGINAL "Affidavit of Availability" (BC 57) to the proper office no later than 4:30 p.m. prevailing time, three (3) days prior to the letting date. This does not apply to Small Business Set-Asides.

WHO CAN BID ?

Bids will be accepted from only those companies that request and receive written **Authorization to Bid** from IDOT's Central Bureau of Construction. This does not apply to Small Business Set-Asides.

WHAT CONSTITUTES WRITTEN AUTHORIZATION TO BID?: When a prospective prime bidder submits a "Request for Authorization to Bid/or Not For Bid Status"(BDE 124) he/she must indicate at that time which items are being requested For Bidding purposes. Only those items requested For Bidding will be analyzed. After the request has been analyzed, the bidder will be issued an **Authorization to Bid or Not for Bid Report**, approved by the Central Bureau of Construction that indicates which items have been approved For Bidding. If **Authorization to Bid** cannot be approved, the **Authorization to Bid or Not for Bid Report** will indicate the reason for denial.

ABOUT AUTHORIZATION TO BID: Firms that have not received an authorization form within a reasonable time of complete and correct original document submittal should contact the department as to status. This is critical in the week before the letting. These documents must be received three days before the letting date. Firms unsure as to authorization status should call the Prequalification Section of the Bureau of Construction at the number listed at the end of these instructions.

ADDENDA AND REVISIONS: It is the contractor's responsibility to determine which, if any, addenda or revisions pertain to any project they may be bidding. Failure to incorporate all relevant addenda or revisions may cause the bid to be declared unacceptable.

Each addendum will be placed with the contract number. Addenda and revisions will also be placed on the Addendum/Revision Checklist and each subscription service subscriber will be notified by e-mail of each addendum and revision issued.

The Internet is the Department's primary way of doing business. The subscription server e-mails are an added courtesy the Department provides. It is suggested that bidders check IDOT's website at <http://www.dot.il.gov/desenv/delett.html> before submitting final bid information.

IDOT IS NOT RESPONSIBLE FOR ANY E-MAIL FAILURES.

Addenda Questions may be directed to the Plans and Contracts Office at (217)782-7806 or D&Econtracts@dot.il.gov

Technical Questions about downloading these files may be directed to Tim Garman (217)524-1642 or Timothy.Garman@illinois.gov.

WHAT MUST BE INCLUDED WHEN BIDS ARE SUBMITTED?: Bidders need not return the entire proposal when bids are submitted. That portion of the proposal that must be returned includes the following:

1. All documents from the Proposal Cover Sheet through the Proposal Bid Bond
2. Other special documentation and/or information that may be required by the contract special provisions

All proposal documents, including Proposal Guaranty Checks or Proposal Bid Bonds, should be stapled together to prevent loss when bids are processed by IDOT personnel.

ABOUT SUBMITTING BIDS: It is recommended that bidders deliver bids in person to insure they arrive at the proper location prior to the time specified for the receipt of bids. Any bid received at the place of letting after the time specified will not be accepted.

WHO SHOULD BE CALLED IF ASSISTANCE IS NEEDED?

Questions Regarding	Call
Prequalification and/or Authorization to Bid	217/782-3413
Preparation and submittal of bids	217/782-7806
Mailing of plans and proposals	217/782-7806

ADDENDUMS AND REVISIONS TO THE PROPOSAL FORMS

Planholders should verify that they have received and incorporated any addendum and/or revision prior to submitting their bid. Failure by the bidder to include an addendum or revision could result in a bid being rejected as irregular.

40

RETURN WITH BID

Proposal Submitted By
Name
Address
City

Letting June 17, 2011

BIDDERS NEED NOT RETURN THE ENTIRE PROPOSAL
(See instructions inside front cover)

NOTICE TO PROSPECTIVE BIDDERS

This proposal can be used for bidding purposes by only those companies that request and receive written **AUTHORIZATION TO BID** from IDOT's Central Bureau of Construction. This does not apply to Small Business Set-Asides.
(SEE INSTRUCTIONS ON THE INSIDE OF COVER)

Notice to Bidders, Specifications, Proposal, Contract and Contract Bond



**Illinois Department
of Transportation**

Springfield, Illinois 62764

**Contract No. 64G53
OGLE County
Section D2 PATCHING 2011-2
Route FAI 39
District 2 Construction Funds**

PLEASE MARK THE APPROPRIATE BOX BELOW:

- A Bid Bond is included.
- A Cashier's Check or a Certified Check is included.

Plans Included
Herein

Prepared by

S

Checked by

(Printed by authority of the State of Illinois)

INSTRUCTIONS

ABOUT IDOT PROPOSALS: All proposals issued by IDOT are potential bidding proposals. Each proposal contains all Certifications and Affidavits, a Proposal Signature Sheet and a Proposal Bid Bond. In addition, this proposal contains new statutory requirements applicable to the use of subcontractors and, in particular, includes the State Required Ethical Standards Governing Subcontractors to be signed and incorporated into all subcontracts.

WHO CAN BID?: Bids will be accepted from only those companies that request and receive written **Authorization to Bid** from IDOT's Central Bureau of Construction. To request authorization, a potential bidder must complete and submit Part B of the Request for Authorization to Bid/or Not For Bid Status form (BDE 124) and submit an original Affidavit of Availability (BC 57). This does not apply to Small Business Set-Asides.

WHAT CONSTITUTES WRITTEN AUTHORIZATION TO BID?: When a prospective prime bidder submits a "**Authorization to Bid or Not for Bid**" form, he/she must indicate at that time which items are being requested For Bidding purposes. Only those items requested For Bidding will be analyzed. After the request has been analyzed, the bidder will be issued a **Authorization to Bid or Not for Bid Report**, approved by the Central Bureau of Construction, that indicates which items have been approved For Bidding. If **Authorization to Bid** cannot be approved, the **Authorization to Bid or Not for Bid Report** will indicate the reason for denial. If a contractor has requested to bid but has not received a **Authorization to Bid or Not for Bid Report**, they should contact the Central Bureau of Construction in advance of the letting date.

WHAT MUST BE INCLUDED WHEN BIDS ARE SUBMITTED?: Bidders need not return the entire proposal when bids are submitted. That portion of the proposal that must be returned includes the following:

1. All documents from the Proposal Cover Sheet through the Proposal Bid Bond
2. Other special documentation and/or information that may be required by the contract special provisions

All proposal documents, including Proposal Guaranty Checks or Proposal Bid Bonds, should be stapled together to prevent loss when bids are processed by IDOT personnel.

ABOUT SUBMITTING BIDS: It is recommended that bidders deliver bids in person to insure they arrive at the proper location prior to the time specified for the receipt of bids. Any bid received at the place of letting after the time specified will not be accepted.

WHO SHOULD BE CALLED IF ASSISTANCE IS NEEDED?

Questions Regarding	Call
Prequalification and/or Authorization to Bid	217/782-3413
Preparation and submittal of bids	217/782-7806

RETURN WITH BID



PROPOSAL

TO THE DEPARTMENT OF TRANSPORTATION

1. Proposal of _____

Taxpayer Identification Number (Mandatory) _____ a

for the improvement identified and advertised for bids in the Invitation for Bids as:

**Contract No. 64G53
OGLE County
Section D2 PATCHING 2011-2
Route FAI 39
District 2 Construction Funds**

Pavement patching and intermittent milling and resurfacing on I-39 from Winnebago County to Lee County.

2. The undersigned bidder will furnish all labor, material and equipment to complete the above described project in a good and workmanlike manner as provided in the contract documents provided by the Department of Transportation. This proposal will become part of the contract and the terms and conditions contained in the contract documents shall govern performance and payments.

RETURN WITH BID

3. **ASSURANCE OF EXAMINATION AND INSPECTION/WAIVER.** The undersigned further declares that he/she has carefully examined the proposal, plans, specifications, addenda, form of contract and contract bond, and special provisions, and that he/she has inspected in detail the site of the proposed work, and that he/she has familiarized themselves with all of the local conditions affecting the contract and the detailed requirements of construction, and understands that in making this proposal he/she waives all right to plead any misunderstanding regarding the same.
4. **EXECUTION OF CONTRACT AND CONTRACT BOND.** The undersigned further agrees to execute a contract for this work and present the same to the department within fifteen (15) days after the contract has been mailed to him/her. The undersigned further agrees that he/she and his/her surety will execute and present within fifteen (15) days after the contract has been mailed to him/her contract bond satisfactory to and in the form prescribed by the Department of Transportation, in the penal sum of the full amount of the contract, guaranteeing the faithful performance of the work in accordance with the terms of the contract.
5. **PROPOSAL GUARANTY.** Accompanying this proposal is either a bid bond on the department form, executed by a corporate surety company satisfactory to the department, or a proposal guaranty check consisting of a bank cashier's check or a properly certified check for not less than 5 per cent of the amount bid or for the amount specified in the following schedule:

<u>Amount of Bid</u>		<u>Proposal Guaranty</u>	<u>Amount of Bid</u>		<u>Proposal Guaranty</u>	
Up to	\$5,000	\$150	\$2,000,000	to	\$3,000,000	\$100,000
\$5,000	to	\$10,000	\$3,000,000	to	\$5,000,000	\$150,000
\$10,000	to	\$50,000	\$5,000,000	to	\$7,500,000	\$250,000
\$50,000	to	\$100,000	\$7,500,000	to	\$10,000,000	\$400,000
\$100,000	to	\$150,000	\$10,000,000	to	\$15,000,000	\$500,000
\$150,000	to	\$250,000	\$15,000,000	to	\$20,000,000	\$600,000
\$250,000	to	\$500,000	\$20,000,000	to	\$25,000,000	\$700,000
\$500,000	to	\$1,000,000	\$25,000,000	to	\$30,000,000	\$800,000
\$1,000,000	to	\$1,500,000	\$30,000,000	to	\$35,000,000	\$900,000
\$1,500,000	to	\$2,000,000	over		\$35,000,000	\$1,000,000

Bank cashier's checks or properly certified checks accompanying proposals shall be made payable to the Treasurer, State of Illinois, when the state is awarding authority; the county treasurer, when a county is the awarding authority; or the city, village, or town treasurer, when a city, village, or town is the awarding authority.

If a combination bid is submitted, the proposal guaranties which accompany the individual proposals making up the combination will be considered as also covering the combination bid.

The amount of the proposal guaranty check is _____ \$(_____). If this proposal is accepted and the undersigned shall fail to execute a contract bond as required herein, it is hereby agreed that the amount of the proposal guaranty shall become the property of the State of Illinois, and shall be considered as payment of damages due to delay and other causes suffered by the State because of the failure to execute said contract and contract bond; otherwise, the bid bond shall become void or the proposal guaranty check shall be returned to the undersigned.

Attach Cashier's Check or Certified Check Here	
In the event that one proposal guaranty check is intended to cover two or more proposals, the amount must be equal to the sum of the proposal guaranties which would be required for each individual proposal. If the guaranty check is placed in another proposal, state below where it may be found.	
The proposal guaranty check will be found in the proposal for:	Item _____
	Section No. _____
	County _____

Mark the proposal cover sheet as to the type of proposal guaranty submitted.

RETURN WITH BID

6. **COMBINATION BIDS.** The undersigned further agrees that if awarded the contract for the sections contained in the following combination, he/she will perform the work in accordance with the requirements of each individual proposal comprising the combination bid specified in the schedule below, and that the combination bid shall be prorated against each section in proportion to the bid submitted for the same. If an error is found to exist in the gross sum bid for one or more of the individual sections included in a combination, the combination bid shall be corrected as provided in the specifications.

When a combination bid is submitted, the schedule below must be completed in each proposal comprising the combination.

If alternate bids are submitted for one or more of the sections comprising the combination, a combination bid must be submitted for each alternate.

Schedule of Combination Bids

Combination No.	Sections Included in Combination	Combination Bid	
		Dollars	Cents

7. **SCHEDULE OF PRICES.** The undersigned bidder submits herewith, in accordance with the rules and instructions, a schedule of prices for the items of work for which bids are sought. The unit prices bid are in U.S. dollars and cents, and all extensions and summations have been made. The bidder understands that the quantities appearing in the bid schedule are approximate and are provided for the purpose of obtaining a gross sum for the comparison of bids. If there is an error in the extension of the unit prices, the unit prices shall govern. Payment to the contractor awarded the contract will be made only for actual quantities of work performed and accepted or materials furnished according to the contract. The scheduled quantities of work to be done and materials to be furnished may be increased, decreased or omitted as provided elsewhere in the contract.

8. **AUTHORITY TO DO BUSINESS IN ILLINOIS.** Section 20-43 of the Illinois Procurement Code (30 ILCS 500/20-43) provides that a person (other than an individual acting as a sole proprietor) must be a legal entity authorized to do business in the State of Illinois prior to submitting the bid.

9. **The services of a subcontractor will or may be used.**

Check box Yes
 Check box No

For known subcontractors with subcontracts with an annual value of more than \$25,000, the contract shall include their name, address, and the dollar allocation for each subcontractor.

10. **EXECUTION OF CONTRACT:** The Department of Transportation will, in accordance with the rules governing Department procurements, execute the contract and shall be the sole entity having the authority to accept performance and make payments under the contract. Execution of the contract by the Chief Procurement Officer or the State Purchasing Officer is for approval of the procurement process and execution of the contract by the Department. Neither the Chief Procurement Officer nor the State Purchasing Officer shall be responsible for administration of the contract or determinations respecting performance or payment there under except as otherwise permitted in the Illinois Procurement Code.

ILLINOIS DEPARTMENT OF TRANSPORTATION
 SCHEDULE OF PRICES
 CONTRACT
 NUMBER -

64G53

State Job # - C-92-021-11
 PPS NBR - 0-01617-2004
 County Name - OGLE - -
 Code - 141 - -
 District - 2 - -
 Section Number - D2 PATCHING 2011-2

Project Number

Route
 FAI 39

Item Number	Pay Item Description	Unit of Measure	Quantity	x	Unit Price	=	Total Price
X3120600	STAB SUB-BASE REPL 4	SQ YD	40.000				
Z0010910	COLD MILLING SPL	SQ YD	2,296.000				
Z0026346	NIGHT WORK ZONE LIGHT	L SUM	1.000				
40600755	P LEV BIND HM N105	TON	5.000				
40600855	P LEV BIND MM N105	TON	148.000				
40600990	TEMPORARY RAMP	SQ YD	267.000				
40603575	P HMA SC "E" N105	TON	343.000				
44000155	HMA SURF REM 1 1/2	SQ YD	1,518.000				
44200565	CL A PATCH T2 11	SQ YD	16.000				
44200577	CL A PATCH T2 12	SQ YD	27.000				
44200624	CL A PATCH T3 14	SQ YD	20.000				
44200631	CL A PATCH T3 15	SQ YD	20.000				
44213000	PATCH REINFORCEMENT	SQ YD	83.000				
44213200	SAW CUTS	FOOT	334.000				
67100100	MOBILIZATION	L SUM	1.000				

ILLINOIS DEPARTMENT OF TRANSPORTATION
 SCHEDULE OF PRICES
 CONTRACT
 NUMBER - 64G53

State Job # - C-92-021-11
 PPS NBR - 0-01617-2004
 County Name - OGLE - -
 Code - 141 - -
 District - 2 - -
 Section Number - D2 PATCHING 2011-2

Project Number

Route
 FAI 39

Item Number	Pay Item Description	Unit of Measure	Quantity	x	Unit Price	=	Total Price
70100420	TRAF CONT-PROT 701411	EACH	1.000				
70100800	TRAF CONT-PROT 701401	L SUM	1.000				
70300100	SHORT TERM PAVT MKING	FOOT	472.000				
70301000	WORK ZONE PAVT MK REM	SQ FT	53.000				
78001110	PAINT PVT MK LINE 4	FOOT	5,922.000				
78100100	RAISED REFL PAVT MKR	EACH	21.000				
78300200	RAISED REF PVT MK REM	EACH	14.000				

CONTRACT NUMBER

64G53

THIS IS THE TOTAL BID

\$ _____

NOTES:

- 1. Each PAY ITEM should have a UNIT PRICE and a TOTAL PRICE.**
- 2. The UNIT PRICE shall govern if no TOTAL PRICE is shown or if there is a discrepancy between the product of the UNIT PRICE multiplied by the QUANTITY.**
- 3. If a UNIT PRICE is omitted, the TOTAL PRICE will be divided by the QUANTITY in order to establish a UNIT PRICE.**
- 4. A bid may be declared UNACCEPTABLE if neither a unit price nor a total price is shown.**

RETURN WITH BID

STATE REQUIRED ETHICAL STANDARDS GOVERNING CONTRACT PROCUREMENT: ASSURANCES, CERTIFICATIONS AND DISCLOSURES

I. GENERAL

A. Article 50 of the Illinois Procurement Code establishes the duty of all State chief procurement officers, State purchasing officers, and their designees to maximize the value of the expenditure of public moneys in procuring goods, services, and contracts for the State of Illinois and to act in a manner that maintains the integrity and public trust of State government. In discharging this duty, they are charged by law to use all available information, reasonable efforts, and reasonable actions to protect, safeguard, and maintain the procurement process of the State of Illinois.

B. In order to comply with the provisions of Article 50 and to carry out the duty established therein, all bidders are to adhere to ethical standards established for the procurement process, and to make such assurances, disclosures and certifications required by law. Except as otherwise required in subsection III, paragraphs J-M, by execution of the Proposal Signature Sheet, the bidder indicates that each of the mandated assurances have been read and understood, that each certification is made and understood, and that each disclosure requirement has been understood and completed.

C. In addition to all other remedies provided by law, failure to comply with any assurance, failure to make any disclosure or the making of a false certification shall be grounds for the chief procurement officer to void the contract, or subcontract, and may result in the suspension or debarment of the bidder or subcontractor.

II. ASSURANCES

The assurances hereinafter made by the bidder are each a material representation of fact upon which reliance is placed should the Department enter into the contract with the bidder.

A. Conflicts of Interest

1. The Illinois Procurement Code provides in pertinent part:

Section 50-13. Conflicts of Interest.

(a) Prohibition. It is unlawful for any person holding an elective office in this State, holding a seat in the General Assembly, or appointed to or employed in any of the offices or agencies of state government and who receives compensation for such employment in excess of 60% of the salary of the Governor of the State of Illinois, or who is an officer or employee of the Capital Development Board or the Illinois Toll Highway Authority, or who is the spouse or minor child of any such person to have or acquire any contract, or any direct pecuniary interest in any contract therein, whether for stationery, printing, paper, or any services, materials, or supplies, that will be wholly or partially satisfied by the payment of funds appropriated by the General Assembly of the State of Illinois or in any contract of the Capital Development Board or the Illinois Toll Highway authority.

(b) Interests. It is unlawful for any firm, partnership, association or corporation, in which any person listed in subsection (a) is entitled to receive (i) more than 7 1/2% of the total distributable income or (ii) an amount in excess of the salary of the Governor, to have or acquire any such contract or direct pecuniary interest therein.

(c) Combined interests. It is unlawful for any firm, partnership, association, or corporation, in which any person listed in subsection (a) together with his or her spouse or minor children is entitled to receive (i) more than 15%, in the aggregate, of the total distributable income or (ii) an amount in excess of 2 times the salary of the Governor, to have or acquire any such contract or direct pecuniary interest therein.

(d) Securities. Nothing in this Section invalidates the provisions of any bond or other security previously offered or to be offered for sale or sold by or for the State of Illinois.

(e) Prior interests. This Section does not affect the validity of any contract made between the State and an officer or employee of the State or member of the General Assembly, his or her spouse, minor child or any combination of those persons if that contract was in existence before his or her election or employment as an officer, member, or employee. The contract is voidable, however, if it cannot be completed within 365 days after the officer, member, or employee takes office or is employed.

The current salary of the Governor is \$177,412.00. Sixty percent of the salary is \$106,447.20.

RETURN WITH BID

2. The bidder assures the Department that the award and execution of the contract would not cause a violation of Section 50-13, or that an effective exemption has been issued by the Board of Ethics to any individual subject to the Section 50-13 prohibitions pursuant to the provisions of Section 50-20 of the Code and Executive Order Number 3 (1998). Information concerning the exemption process is available from the Department upon request.

B. Negotiations

1. The Illinois Procurement Code provides in pertinent part:

Section 50-15. Negotiations.

(a) It is unlawful for any person employed in or on a continual contractual relationship with any of the offices or agencies of State government to participate in contract negotiations on behalf of that office or agency with any firm, partnership, association, or corporation with whom that person has a contract for future employment or is negotiating concerning possible future employment.

2. The bidder assures the Department that the award and execution of the contract would not cause a violation of Section 50-15, and that the bidder has no knowledge of any facts relevant to the kinds of acts prohibited therein.

C. Inducements

1. The Illinois Procurement Code provides:

Section 50-25. Inducement. Any person who offers or pays any money or other valuable thing to any person to induce him or her not to bid for a State contract or as recompense for not having bid on a State contract is guilty of a Class 4 felony. Any person who accepts any money or other valuable thing for not bidding for a State contract or who withholds a bid in consideration of the promise for the payment of money or other valuable thing is guilty of a Class 4 felony.

2. The bidder assures the Department that the award and execution of the contract would not cause a violation of Section 50-25, and that the bidder has no knowledge of any facts relevant to the kinds of acts prohibited therein.

D. Revolving Door Prohibition

1. The Illinois Procurement Code provides:

Section 50-30. Revolving door prohibition. Chief procurement officers, State purchasing officers, procurement compliance monitors, their designees whose principal duties are directly related to State procurement, and executive officers confirmed by the Senate are expressly prohibited for a period of 2 years after terminating an affected position from engaging in any procurement activity relating to the State agency most recently employing them in an affected position for a period of at least 6 months. The prohibition includes, but is not limited to: lobbying the procurement process; specifying; bidding; proposing bid, proposal, or contract documents; on their own behalf or on behalf of any firm, partnership, association, or corporation. This Section applies only to persons who terminate an affected position on or after January 15, 1999.

2. The bidder assures the Department that the award and execution of the contract would not cause a violation of Section 50-30, and that the bidder has no knowledge of any facts relevant to the kinds of acts prohibited therein.

E. Reporting Anticompetitive Practices

1. The Illinois Procurement Code provides:

Section 50-40. Reporting anticompetitive practices. When, for any reason, any vendor, bidder, contractor, chief procurement officer, State purchasing officer, designee, elected official, or State employee suspects collusion or other anticompetitive practice among any bidders, offerors, contractors, proposers, or employees of the State, a notice of the relevant facts shall be transmitted to the Attorney General and the chief procurement officer.

2. The bidder assures the Department that it has not failed to report any relevant facts concerning the practices addressed in Section 50-40 which may involve the contract for which the bid is submitted.

F. Confidentiality

1. The Illinois Procurement Code provides:

Section 50-45. Confidentiality. Any chief procurement officer, State purchasing officer, designee, or executive officer who willfully uses or allows the use of specifications, competitive bid documents, proprietary competitive information, proposals, contracts, or selection information to compromise the fairness or integrity of the procurement, bidding, or contract process shall be subject to immediate dismissal, regardless of the Personnel code, any contract, or any collective bargaining agreement, and may in addition be subject to criminal prosecution.

2. The bidder assures the Department that it has no knowledge of any fact relevant to the practices addressed in Section 50-45 which may involve the contract for which the bid is submitted.

RETURN WITH BID

G. Insider Information

1. The Illinois Procurement Act provides:

Section 50-50. Insider information. It is unlawful for any current or former elected or appointed State official or State employee to knowingly use confidential information available only by virtue of that office or employment for actual or anticipated gain for themselves or another person.

2. The bidder assures the Department that it has no knowledge of any facts relevant to the practices addressed in Section 50-50 which may involve the contract for which the bid is submitted.

III. CERTIFICATIONS

The certifications hereinafter made by the bidder are each a material representation of fact upon which reliance is placed should the Department enter into the contract with the bidder. Section 50-2 of the Illinois Procurement Code provides that every person that has entered into a multi-year contract and every subcontractor with a multi-year subcontract shall certify, by July 1 of each fiscal year covered by the contract after the initial fiscal year, to the responsible chief procurement officer whether it continues to satisfy the requirements of Article 50 pertaining to the eligibility for a contract award. If a contractor or subcontractor is not able to truthfully certify that it continues to meet all requirements, it shall provide with its certification a detailed explanation of the circumstances leading to the change in certification status. A contractor or subcontractor that makes a false statement material to any given certification required under Article 50 is, in addition to any other penalties or consequences prescribed by law, subject to liability under the Whistleblower Reward and Protection Act for submission of a false claim.

A. Bribery

1. The Illinois Procurement Code provides:

Section 50-5. Bribery.

(a) Prohibition. No person or business shall be awarded a contract or subcontract under this Code who:

(1) has been convicted under the laws of Illinois or any other state of bribery or attempting to bribe an officer or employee of the State of Illinois or any other state in that officer's or employee's official capacity; or

(2) has made an admission of guilt of that conduct that is a matter of record but has not been prosecuted for that conduct.

(b) Businesses. No business shall be barred from contracting with any unit of State or local government, or subcontracting under such a contract, as a result of a conviction under this Section of any employee or agent of the business if the employee or agent is no longer employed by the business and:

(1) the business has been finally adjudicated not guilty; or

(2) the business demonstrates to the governmental entity with which it seeks to contract, or which is signatory to the contract which the subcontract relates, and that entity finds that the commission of the offense was not authorized, requested, commanded, or performed by a director, officer, or high managerial agent on behalf of the business as provided in paragraph (2) of subsection (a) of Section 5-4 of the Criminal Code of 1961.

(c) Conduct on behalf of business. For purposes of this Section, when an official, agent, or employee of a business committed the bribery or attempted bribery on behalf of the business and in accordance with the direction or authorization of a responsible official of the business, the business shall be chargeable with the conduct.

(d) Certification. Every bid submitted to and contract executed by the State, and every subcontract subject to Section 20-120 of the Procurement Code shall contain a certification by the contractor or the subcontractor, respectively, that the contractor or subcontractor is not barred from being awarded a contract or subcontract under this Section and acknowledges that the chief procurement officer may declare the related contract void if any certifications required by this Section are false. A contractor who makes a false statement, material to the certification, commits a Class 3 felony.

2. The contractor or subcontractor certifies that it is not barred from being awarded a contract under Section 50.5.

B. Felons

1. The Illinois Procurement Code provides:

Section 50-10. Felons. Unless otherwise provided, no person or business convicted of a felony shall do business with the State of Illinois or any State agency, or enter into a subcontract, from the date of conviction until 5 years after the date of completion of the sentence for that felony, unless no person held responsible by a prosecutorial office for the facts upon which the conviction was based continues to have any involvement with the business.

2. Certification. Every bid submitted to and contract executed by the State and every subcontract subject to Section 20-120 of the Procurement Code shall contain a certification by the bidder or contractor or subcontractor, respectively, that the bidder, contractor, or subcontractor is not barred from being awarded a contract or subcontract under this Section and acknowledges that the chief procurement officer may declare the related contract void if any of the certifications required by this Section are false.

RETURN WITH BID

C. Debt Delinquency

1. The Illinois Procurement Code provides:

Section 50-11 and 50-12. Debt Delinquency.

The contractor or bidder or subcontractor, respectively, certifies that it, or any affiliate, is not barred from being awarded a contract or subcontract under the Procurement Code. Section 50-11 prohibits a person from entering into a contract with a State agency, or entering into a subcontract, if it knows or should know that it, or any affiliate, is delinquent in the payment of any debt to the State as defined by the Debt Collection Board. Section 50-12 prohibits a person from entering into a contract with a State agency, or entering into a subcontract, if it, or any affiliate, has failed to collect and remit Illinois Use Tax on all sales of tangible personal property into the State of Illinois in accordance with the provisions of the Illinois Use Tax Act. The bidder or contractor or subcontractor, respectively, further acknowledges that the chief procurement officer may declare the related contract void if this certification is false or if the bidder, contractor, or subcontractor, or any affiliate, is determined to be delinquent in the payment of any debt to the State during the term of the contract.

D. Prohibited Bidders, Contractors and Subcontractors

1. The Illinois Procurement Code provides:

Section 50-10.5 and 50-60(c). Prohibited bidders, contractors and subcontractors.

The bidder or contractor or subcontractor, respectively, certifies in accordance with 30 ILCS 500/50-10.5 that no officer, director, partner or other managerial agent of the contracting business has been convicted of a felony under the Sarbanes-Oxley Act of 2002 or a Class 3 or Class 2 felony under the Illinois Securities Law of 1953 or if in violation of Subsection (c) for a period of five years from the date of conviction. Every bid submitted to and contract executed by the State and every subcontract subject to Section 20-120 of the Procurement Code shall contain a certification by the bidder, contractor, or subcontractor, respectively, that the bidder, contractor, or subcontractor is not barred from being awarded a contract or subcontract under this Section and acknowledges that the chief procurement officer shall declare the related contract void if any of the certifications completed pursuant to this Section are false.

E. Section 42 of the Environmental Protection Act

The bidder or contractor or subcontractor, respectively, certifies in accordance with 30 ILCS 500/50-12 that the bidder, contractor, or subcontractor, is not barred from being awarded a contract or entering into a subcontract under this Section which prohibits the bidding on or entering into contracts with the State of Illinois or a State agency, or entering into any subcontract, that is subject to the Procurement Code by a person or business found by a court or the Pollution Control Board to have committed a willful or knowing violation of Section 42 of the Environmental Protection Act for a period of five years from the date of the order. The bidder or contractor or subcontractor, respectively, acknowledges that the chief procurement officer may declare the contract void if this certification is false.

F. Educational Loan

1. Section 3 of the Educational Loan Default Act provides:

§ 3. No State agency shall contract with an individual for goods or services if that individual is in default, as defined in Section 2 of this Act, on an educational loan. Any contract used by any State agency shall include a statement certifying that the individual is not in default on an educational loan as provided in this Section.

2. The bidder, if an individual as opposed to a corporation, partnership or other form of business organization, certifies that the bidder is not in default on an educational loan as provided in Section 3 of the Act.

G. Bid-Rigging/Bid Rotating

1. Section 33E-11 of the Criminal Code of 1961 provides:

§ 33E-11. (a) Every bid submitted to and public contract executed pursuant to such bid by the State or a unit of local government shall contain a certification by the prime contractor that the prime contractor is not barred from contracting with any unit of State or local government as a result of a violation of either Section 33E-3 or 33E-4 of this Article. The State and units of local government shall provide the appropriate forms for such certification.

- (b) A contractor who makes a false statement, material to the certification, commits a Class 3 felony.

A violation of Section 33E-3 would be represented by a conviction of the crime of bid-rigging which, in addition to Class 3 felony sentencing, provides that any person convicted of this offense or any similar offense of any state or the United States which contains the same elements as this offense shall be barred for 5 years from the date of conviction from contracting with any unit of State or local government. No corporation shall be barred from contracting with any unit of State or local government as a result of a conviction under this Section of any employee or agent of such corporation if the employee so convicted is no longer employed by the corporation and: (1) it has been finally adjudicated not guilty or (2) if it demonstrates to the governmental entity with which it seeks to contract and that entity finds that the commission of the offense was neither authorized, requested, commanded, nor performed by a director, officer or a high managerial agent in behalf of the corporation.

RETURN WITH BID

A violation of Section 33E-4 would be represented by a conviction of the crime of bid-rotating which, in addition to Class 2 felony sentencing, provides that any person convicted of this offense or any similar offense of any state or the United States which contains the same elements as this offense shall be permanently barred from contracting with any unit of State or local government. No corporation shall be barred from contracting with any unit of State or local government as a result of a conviction under this Section of any employee or agent of such corporation if the employee so convicted is no longer employed by the corporation and: (1) it has been finally adjudicated not guilty or (2) if it demonstrates to the governmental entity with which it seeks to contract and that entity finds that the commission of the offense was neither authorized, requested, commanded, nor performed by a director, officer or a high managerial agent in behalf of the corporation.

2. The bidder certifies that it is not barred from contracting with the Department by reason of a violation of either Section 33E-3 or Section 33E-4.

H. International Anti-Boycott

1. Section 5 of the International Anti-Boycott Certification Act provides:

§ 5. State contracts. Every contract entered into by the State of Illinois for the manufacture, furnishing, or purchasing of supplies, material, or equipment or for the furnishing of work, labor, or services, in an amount exceeding the threshold for small purchases according to the purchasing laws of this State or \$10,000.00, whichever is less, shall contain certification, as a material condition of the contract, by which the contractor agrees that neither the contractor nor any substantially-owned affiliated company is participating or shall participate in an international boycott in violation of the provisions of the U.S. Export Administration Act of 1979 or the regulations of the U.S. Department of Commerce promulgated under that Act.

2. The bidder makes the certification set forth in Section 5 of the Act.

I. Drug Free Workplace

1. The Illinois "Drug Free Workplace Act" applies to this contract and it is necessary to comply with the provisions of the "Act" if the contractor is a corporation, partnership, or other entity (including a sole proprietorship) which has 25 or more employees.

2. The bidder certifies that if awarded a contract in excess of \$5,000 it will provide a drug free workplace by:

(a) Publishing a statement notifying employees that the unlawful manufacture, distribution, dispensation, possession or use of a controlled substance, including cannabis, is prohibited in the contractor's workplace; specifying the actions that will be taken against employees for violations of such prohibition; and notifying the employee that, as a condition of employment on such contract, the employee shall abide by the terms of the statement, and notify the employer of any criminal drug statute conviction for a violation occurring in the workplace no later than five (5) days after such conviction.

(b) Establishing a drug free awareness program to inform employees about the dangers of drug abuse in the workplace; the contractor's policy of maintaining a drug free workplace; any available drug counseling, rehabilitation, and employee assistance programs; and the penalties that may be imposed upon employees for drug violations.

(c) Providing a copy of the statement required by subparagraph (1) to each employee engaged in the performance of the contract and to post the statement in a prominent place in the workplace.

(d) Notifying the Department within ten (10) days after receiving notice from an employee or otherwise receiving actual notice of the conviction of an employee for a violation of any criminal drug statute occurring in the workplace.

(e) Imposing or requiring, within 30 days after receiving notice from an employee of a conviction or actual notice of such a conviction, an appropriate personnel action, up to and including termination, or the satisfactory participation in a drug abuse assistance or rehabilitation program approved by a federal, state or local health, law enforcement or other appropriate agency.

(f) Assisting employees in selecting a course of action in the event drug counseling, treatment, and rehabilitation is required and indicating that a trained referral team is in place.

(g) Making a good faith effort to continue to maintain a drug free workplace through implementation of the actions and efforts stated in this certification.

RETURN WITH BID

J. Disclosure of Business Operations in Iran

Section 50-36 of the Illinois Procurement Code, 30ILCS 500/50-36 provides that each bid, offer, or proposal submitted for a State contract shall include a disclosure of whether or not the Company acting as the bidder, offeror, or proposing entity, or any of its corporate parents or subsidiaries, within the 24 months before submission of the bid, offer, or proposal had business operations that involved contracts with or provision of supplies or services to the Government of Iran, companies in which the Government of Iran has any direct or indirect equity share, consortiums or projects commissioned by the Government of Iran, or companies involved in consortiums or projects commissioned by the Government of Iran and either of the following conditions apply:

- (1) More than 10% of the Company's revenues produced in or assets located in Iran involve oil-related activities or mineral-extraction activities; less than 75% of the Company's revenues produced in or assets located in Iran involve contracts with or provision of oil-related or mineral-extraction products or services to the Government of Iran or a project or consortium created exclusively by that government; and the Company has failed to take substantial action.
- (2) The Company has, on or after August 5, 1996, made an investment of \$20 million or more, or any combination of investments of at least \$10 million each that in the aggregate equals or exceeds \$20 million in any 12-month period, which directly or significantly contributes to the enhancement of Iran's ability to develop petroleum resources of Iran.

The terms "Business operations", "Company", "Mineral-extraction activities", "Oil-related activities", "Petroleum resources", and "Substantial action" are all defined in the Code.

Failure to make the disclosure required by the Code shall cause the bid, offer or proposal to be considered not responsive. The disclosure will be considered when evaluating the bid, offer, or proposal or awarding the contract. The name of each Company disclosed as doing business or having done business in Iran will be provided to the State Comptroller.

Check the appropriate statement:

Company has no business operations in Iran to disclose.

Company has business operations in Iran as disclosed the attached document.

K. Apprenticeship and Training Certification (Does not apply to federal aid projects)

In accordance with the provisions of Section 30-22 (6) of the Illinois Procurement Code, the bidder certifies that it is a participant, either as an individual or as part of a group program, in the approved apprenticeship and training programs applicable to each type of work or craft that the bidder will perform with its own forces. The bidder further certifies for work that will be performed by subcontract that each of its subcontractors submitted for approval either (a) is, at the time of such bid, participating in an approved, applicable apprenticeship and training program; or (b) will, prior to commencement of performance of work pursuant to this contract, begin participation in an approved apprenticeship and training program applicable to the work of the subcontract. The Department, at any time before or after award, may require the production of a copy of each applicable Certificate of Registration issued by the United States Department of Labor evidencing such participation by the contractor and any or all of its subcontractors. Applicable apprenticeship and training programs are those that have been approved and registered with the United States Department of Labor. The bidder shall list in the space below, the official name of the program sponsor holding the Certificate of Registration for all of the types of work or crafts in which the bidder is a participant and that will be performed with the bidder's forces. Types of work or craft work that will be subcontracted shall be included and listed as subcontract work. The list shall also indicate any type of work or craft job category that does not have an applicable apprenticeship or training program. **The bidder is responsible for making a complete report and shall make certain that each type of work or craft job category that will be utilized on the project as reported on the Construction Employee Workforce Projection (Form BC-1256) and returned with the bid is accounted for and listed.**

The requirements of this certification and disclosure are a material part of the contract, and the contractor shall require this certification provision to be included in all approved subcontracts. In order to fulfill this requirement, it shall not be necessary that an applicable program sponsor be currently taking or that it will take applications for apprenticeship, training or employment during the performance of the work of this contract.

TO BE RETURNED WITH BID

L. Political Contributions and Registration with the State Board of Elections

Sections 20-160 and 50-37 of the Illinois Procurement Code regulate political contributions from business entities and any affiliated entities or affiliated persons bidding on or contracting with the state. Generally under Section 50-37, any business entity, and any affiliated entity or affiliated person of the business entity, whose current year contracts with all state agencies exceed an awarded value of \$50,000, are prohibited from making any contributions to any political committees established to promote the candidacy of the officeholder responsible for the awarding of the contracts or any other declared candidate for that office for the duration of the term of office of the incumbent officeholder or a period 2 years after the termination of the contract, whichever is longer. Any business entity and affiliated entities or affiliated persons whose state contracts in the current year do not exceed an awarded value of \$50,000, but whose aggregate pending bids and proposals on state contracts exceed \$50,000, either alone or in combination with contracts not exceeding \$50,000, are prohibited from making any political contributions to any political committee established to promote the candidacy of the officeholder responsible for awarding the pending contract during the period beginning on the date the invitation for bids or request for proposals is issued and ending on the day after the date of award or selection if the entity was not awarded or selected. Section 20-160 requires certification of registration of affected business entities in accordance with procedures found in Section 9-35 of The Election Code.

By submission of a bid, the contractor business entity acknowledges and agrees that it has read and understands Sections 20-160 and 50-37 of the Illinois Procurement Code, and that it makes the following certification:

The undersigned business entity certifies that it has registered as a business with the State Board of Elections and acknowledges a continuing duty to update the registration in accordance with the above referenced statutes. A copy of the certificate of registration shall be submitted with the bid. The bidder is cautioned that the Department will not award a contract without submission of the certificate of registration.

These requirements and compliance with the above referenced statutory sections are a material part of the contract, and any breach thereof shall be cause to void the contract under Section 50-60 of the Illinois Procurement Code. This provision does not apply to Federal-aid contracts.

M. Lobbyist Disclosure

Section 50-38 of the Illinois Procurement Code requires that any bidder or offeror on a State contract that hires a person required to register under the Lobbyist Registration Act to assist in obtaining a contract shall:

- (i) Disclose all costs, fees, compensation, reimbursements, and other remunerations paid or to be paid to the lobbyist related to the contract,
- (ii) Not bill or otherwise cause the State of Illinois to pay for any of the lobbyist's costs, fees, compensation, reimbursements, or other remuneration, and
- (iii) Sign a verification certifying that none of the lobbyist's costs, fees, compensation, reimbursements, or other remuneration were billed to the State.

This information, along with all supporting documents, shall be filed with the agency awarding the contract and with the Secretary of State. The chief procurement officer shall post this information, together with the contract award notice, in the online Procurement Bulletin.

Pursuant to Subsection (c) of this Section, no person or entity shall retain a person or entity to attempt to influence the outcome of a procurement decision made under the Procurement Code for compensation contingent in whole or in part upon the decision or procurement. Any person who violates this subsection is guilty of a business offense and shall be fined not more than \$10,000.

Bidder acknowledges that it is required to disclose the hiring of any person required to register pursuant to the Illinois Lobbyist Registration Act (25 ILCS 170) in connection with this contract.

Bidder has not hired any person required to register pursuant to the Illinois Lobbyist Registration Act in connection with this contract.

Or

Bidder has hired the following persons required to register pursuant to the Illinois Lobbyist Registration Act in connection with the contract:

Name and address of person: _____
All costs, fees, compensation, reimbursements and other remuneration paid to said person: _____

RETURN WITH BID

IV. DISCLOSURES

- A. The disclosures hereinafter made by the bidder are each a material representation of fact upon which reliance is placed should the Department enter into the contract with the bidder. The bidder further certifies that the Department has received the disclosure forms for each bid.

The chief procurement officer may void the bid, contract, or subcontract, respectively, if it is later determined that the bidder or subcontractor rendered a false or erroneous disclosure. A contractor or subcontractor may be suspended or debarred for violations of the Procurement Code. Furthermore, the chief procurement officer may void the contract and the surety providing the performance bond shall be responsible for completion of the contract.

B. Financial Interests and Conflicts of Interest

1. Section 50-35 of the Illinois Procurement Code provides that all bids of more than \$25,000 shall be accompanied by disclosure of the financial interests of the bidder. This disclosed information for the successful bidder, will be maintained as public information subject to release by request pursuant to the Freedom of Information Act, filed with the Procurement Policy Board, and shall be incorporated as a material term of the contract. Furthermore, pursuant to Section 5-5, the Procurement Policy Board may review a proposal, bid, or contract and issue a recommendation to void a contract or reject a proposal or bid based on any violation of the Procurement Code or the existence of a conflict of interest as provided in subsections (b) and (d) of Section 50-35.

The financial interests to be disclosed shall include ownership or distributive income share that is in excess of 5%, or an amount greater than 60% of the annual salary of the Governor, of the bidding entity or its parent entity, whichever is less, unless the contractor or bidder is a publicly traded entity subject to Federal 10K reporting, in which case it may submit its 10K disclosure in place of the prescribed disclosure. If a bidder is a privately held entity that is exempt from Federal 10K reporting, but has more than 400 shareholders, it may submit the information that Federal 10K companies are required to report, and list the names of any person or entity holding any ownership share that is in excess of 5%. The disclosure shall include the names, addresses, and dollar or proportionate share of ownership of each person making the disclosure, their instrument of ownership or beneficial relationship, and notice of any potential conflict of interest resulting from the current ownership or beneficial interest of each person making the disclosure having any of the relationships identified in Section 50-35 and on the disclosure form.

The current annual salary of the Governor is \$177,412.00

In addition, all disclosures shall indicate any other current or pending contracts, proposals, leases, or other ongoing procurement relationships the bidding entity has with any other unit of state government and shall clearly identify the unit and the contract, proposal, lease, or other relationship.

2. Disclosure Forms. Disclosure Form A is attached for use concerning the individuals meeting the above ownership or distributive share requirements. Subject individuals should be covered each by one form. In addition, a second form (Disclosure Form B) provides for the disclosure of current or pending procurement relationships with other (non-IDOT) state agencies. **The forms must be included with each bid.**

C. Disclosure Form Instructions

Form A Instructions for Financial Information & Potential Conflicts of Interest

If the bidder is a publicly traded entity subject to Federal 10K reporting, the 10K Report may be submitted to meet the requirements of Form A. If a bidder is a privately held entity that is exempt from Federal 10K reporting, but has more than 400 shareholders, it may submit the information that Federal 10K companies are required to report, and list the names of any person or entity holding any ownership share that is in excess of 5%. If a bidder is not subject to Federal 10K reporting, the bidder must determine if any individuals are required by law to complete a financial disclosure form. To do this, the bidder should answer each of the following questions. A "YES" answer indicates Form A must be completed. If the answer to each of the following questions is "NO", then the NOT APPLICABLE STATEMENT on Form A must be signed and dated by a person that is authorized to execute contracts for the bidding company. Note: These questions are for assistance only and are not required to be completed.

1. Does anyone in your organization have a direct or beneficial ownership share of greater than 5% of the bidding entity or parent entity? YES ___ NO ___
2. Does anyone in your organization have a direct or beneficial ownership share of less than 5%, but which has a value greater than 60% of the annual salary of the Governor? YES ___ NO ___
3. Does anyone in your organization receive more than 60% of the annual salary of the Governor of the bidding entity's or parent entity's distributive income? YES ___ NO ___

(Note: Distributive income is, for these purposes, any type of distribution of profits. An annual salary is not distributive income.)

4. Does anyone in your organization receive greater than 5% of the bidding entity's or parent entity's total distributive income, but which is less than 60% of the annual salary of the Governor? YES ___ NO ___

(Note: Only one set of forms needs to be completed per person per bid even if a specific individual would require a yes answer to more than one question.)

A "YES" answer to any of these questions requires the completion of Form A. The bidder must determine each individual in the bidding entity or the bidding entity's parent company that would cause the questions to be answered "Yes". Each form must be signed and dated by a person that is authorized to execute contracts for your organization. **Photocopied or stamped signatures are not acceptable.** The person signing can be, but does not have to be, the person for which the form is being completed. The bidder is responsible for the accuracy of any information provided.

If the answer to each of the above questions is "NO", then the NOT APPLICABLE STATEMENT of Form A must be signed and dated by a person that is authorized to execute contracts for your company.

RETURN WITH BID

Form B: Instructions for Identifying Other Contracts & Procurement Related Information

Disclosure Form B must be completed for each bid submitted by the bidding entity. *Note: Checking the NOT APPLICABLE STATEMENT on Form A does not allow the bidder to ignore Form B. Form B must be completed, checked, and dated or the bidder may be considered nonresponsive and the bid will not be accepted.*

The Bidder shall identify, by checking Yes or No on Form B, whether it has any pending contracts (including leases), bids, proposals, or other ongoing procurement relationship with any other (non-IDOT) State of Illinois agency. If "No" is checked, the bidder only needs to complete the check box on the bottom of Form B. If "Yes" is checked, the bidder must do one of the following:

Option I: If the bidder did not submit an Affidavit of Availability to obtain authorization to bid, the bidder must list all non-IDOT State of Illinois agency pending contracts, leases, bids, proposals, and other ongoing procurement relationships. These items may be listed on Form B or on an attached sheet(s). Do not include IDOT contracts. Contracts with cities, counties, villages, etc. are not considered State of Illinois agency contracts and are not to be included. Contracts with other State of Illinois agencies such as the Department of Natural Resources or the Capital Development Board must be included. Bidders who submit Affidavits of Availability are suggested to use Option II.

Option II: If the bidder is required and has submitted an Affidavit of Availability in order to obtain authorization to bid, the bidder may write or type "See Affidavit of Availability" which indicates that the Affidavit of Availability is incorporated by reference and includes all non-IDOT State of Illinois agency pending contracts, leases, bids, proposals, and other ongoing procurement relationships. For any contracts that are not covered by the Affidavit of Availability, the bidder must identify them on Form B or on an attached sheet(s). These might be such things as leases.

**ILLINOIS DEPARTMENT
OF TRANSPORTATION**

**Form A
Financial Information &
Potential Conflicts of Interest
Disclosure**

Contractor Name		
Legal Address		
City, State, Zip		
Telephone Number	Email Address	Fax Number (if available)

Disclosure of the information contained in this Form is required by the Section 50-35 of the Illinois Procurement Code (30 ILCS 500). Vendors desiring to enter into a contract with the State of Illinois must disclose the financial information and potential conflict of interest information as specified in this Disclosure Form. This information shall become part of the publicly available contract file. This Form A must be completed for bids in excess of \$25,000, and for all open-ended contracts. **A publicly traded company may submit a 10K disclosure (or equivalent if applicable) in satisfaction of the requirements set forth in Form A. See Disclosure Form Instructions.**

The current annual salary of the Governor is \$177,412.00.

DISCLOSURE OF FINANCIAL INFORMATION

1. Disclosure of Financial Information. The individual named below has an interest in the BIDDER (or its parent) in terms of ownership or distributive income share in excess of 5%, or an interest which has a value of more than 60% of the annual salary of the Governor. **(Make copies of this form as necessary and attach a separate Disclosure Form A for each individual meeting these requirements)**

FOR INDIVIDUAL (type or print information)	
NAME:	_____
ADDRESS	_____
Type of ownership/distributable income share:	
stock _____ sole proprietorship _____ Partnership _____ other: (explain on separate sheet):	
% or \$ value of ownership/distributable income share:	_____

2. Disclosure of Potential Conflicts of Interest. Check "Yes" or "No" to indicate which, if any, of the following potential conflict of interest relationships apply. If the answer to any question is "Yes", please attach additional pages and describe.

(a) State employment, currently or in the previous 3 years, including contractual employment of services. Yes ___ No ___

If your answer is yes, please answer each of the following questions.

1. Are you currently an officer or employee of either the Capitol Development Board or the Illinois State Toll Highway Authority? Yes ___ No ___

2. Are you currently appointed to or employed by any agency of the State of Illinois? If you are currently appointed to or employed by any agency of the State of Illinois, and your annual salary exceeds 60% of the annual salary of the Governor, provide the name the State agency for which you are employed and your annual salary. _____

RETURN WITH BID

3. If you are currently appointed to or employed by any agency of the State of Illinois, and your annual salary exceeds 60% of the annual salary of the Governor, are you entitled to receive (i) more than 7 1/2% of the total distributable income of your firm, partnership, association or corporation, or (ii) an amount in excess of 100% of the annual salary of the Governor?
Yes ___ No ___

4. If you are currently appointed to or employed by any agency of the State of Illinois, and your annual salary exceeds 60% of the annual salary of the Governor, are you and your spouse or minor children entitled to receive (i) more than 15 % in the aggregate of the total distributable income of your firm, partnership, association or corporation, or (ii) an amount in excess of two times the salary of the Governor?
Yes ___ No ___

(b) State employment of spouse, father, mother, son, or daughter, including contractual employment services in the previous 2 years.

Yes ___ No ___

If your answer is yes, please answer each of the following questions.

1. Is your spouse or any minor children currently an officer or employee of the Capitol Development Board or the Illinois State Toll Highway Authority?
Yes ___ No ___

2. Is your spouse or any minor children currently appointed to or employed by any agency of the State of Illinois? If your spouse or minor children is/are currently appointed to or employed by any agency of the State of Illinois, and his/her annual salary exceeds 60% of the annual salary of the Governor, provide the name of your spouse and/or minor children, the name of the State agency for which he/she is employed and his/her annual salary. _____

3. If your spouse or any minor children is/are currently appointed to or employed by any agency of the State of Illinois, and his/her annual salary exceeds 60% of the annual salary of the Governor, as of 7/1/07 are you entitled to receive (i) more than 7 1/2% of the total distributable income of your firm, partnership, association or corporation, or (ii) an amount in excess of 100% of the annual salary of the Governor?
Yes ___ No ___

4. If your spouse or any minor children are currently appointed to or employed by any agency of the State of Illinois, and his/her annual salary exceeds 60% of the annual salary of the Governor, are you and your spouse or minor children entitled to receive (i) more than 15 % in the aggregate of the total distributable income of your firm, partnership, association or corporation, or (ii) an amount in excess of 2 times the salary of the Governor?
Yes ___ No ___

(c) Elective status; the holding of elective office of the State of Illinois, the government of the United States, any unit of local government authorized by the Constitution of the State of Illinois or the statutes of the State of Illinois currently or in the previous 3 years.
Yes ___ No ___

(d) Relationship to anyone holding elective office currently or in the previous 2 years; spouse, father, mother, son, or daughter.
Yes ___ No ___

(e) Appointive office; the holding of any appointive government office of the State of Illinois, the United States of America, or any unit of local government authorized by the Constitution of the State of Illinois or the statutes of the State of Illinois, which office entitles the holder to compensation in excess of the expenses incurred in the discharge of that office currently or in the previous 3 years.
Yes ___ No ___

(f) Relationship to anyone holding appointive office currently or in the previous 2 years; spouse, father, mother, son, or daughter.
Yes ___ No ___

(g) Employment, currently or in the previous 3 years, as or by any registered lobbyist of the State government.
Yes ___ No ___

RETURN WITH BID/OFFER

(h) Relationship to anyone who is or was a registered lobbyist in the previous 2 years; spouse, father, mother, son, or daughter. Yes ___ No ___

(i) Compensated employment, currently or in the previous 3 years, by any registered election or reelection committee registered with the Secretary of State or any county clerk of the State of Illinois, or any political action committee registered with either the Secretary of State or the Federal Board of Elections. Yes ___ No ___

(j) Relationship to anyone; spouse, father, mother, son, or daughter; who was a compensated employee in the last 2 years by any registered election or re-election committee registered with the Secretary of State or any county clerk of the State of Illinois, or any political action committee registered with either the Secretary of State or the Federal Board of Elections. Yes ___ No ___

2. Communication Disclosure.

Disclose the name and address of each lobbyist and other agent of the bidder or offeror who is not identified in Section 2 of this form, who is has communicated, is communicating, or may communicate with any State officer or employee concerning the bid or offer. This disclosure is a continuing obligation and must be promptly supplemented for accuracy throughout the process and throughout the term of the contract. If no person is identified, enter "None" on the line below:

Name and address of person(s): _____

RETURN WITH BID

4. Debarment Disclosure. For each of the persons identified under Sections 2 and 3 of this form, disclose whether any of the following has occurred within the previous 10 years: debarment from contracting with any governmental entity; professional licensure discipline; bankruptcies; adverse civil judgments and administrative findings; and criminal felony convictions. This disclosure is a continuing obligation and must be promptly supplemented for accuracy throughout the procurement process and term of the contract. If no person is identified, enter "None" on the line below:

Name of person(s): _____

Nature of disclosure: _____

APPLICABLE STATEMENT

This Disclosure Form A is submitted on behalf of the INDIVIDUAL named on previous page. Under penalty of perjury, I certify the contents of this disclosure to be true and accurate to the best of my knowledge.

Completed by: _____ Date _____
Signature of Individual or Authorized Representative

NOT APPLICABLE STATEMENT

Under penalty of perjury, I have determined that no individuals associated with this organization meet the criteria that would require the completion of this Form A.

This Disclosure Form A is submitted on behalf of the CONTRACTOR listed on the previous page.

_____ Date _____
Signature of Authorized Representative

The bidder has a continuing obligation to supplement these disclosures under Sec. 50-35 of the Procurement Code.

RETURN WITH BID

**ILLINOIS DEPARTMENT
OF TRANSPORTATION**

**Form B
Other Contracts &
Procurement Related Information
Disclosure**

Contractor Name		
Legal Address		
City, State, Zip		
Telephone Number	Email Address	Fax Number (if available)

Disclosure of the information contained in this Form is required by the Section 50-35 of the Illinois Procurement Act (30 ILCS 500). This information shall become part of the publicly available contract file. This Form B must be completed for bids in excess of \$25,000, and for all open-ended contracts.

DISCLOSURE OF OTHER CONTRACTS AND PROCUREMENT RELATED INFORMATION

1. Identifying Other Contracts & Procurement Related Information. The BIDDER shall identify whether it has any pending contracts (including leases), bids, proposals, or other ongoing procurement relationship with any other State of Illinois agency: Yes ___ No ___

If "No" is checked, the bidder only needs to complete the signature box on the bottom of this page.

2. If "Yes" is checked. Identify each such relationship by showing State of Illinois agency name and other descriptive information such as bid or project number (attach additional pages as necessary). SEE DISCLOSURE FORM INSTRUCTIONS:

THE FOLLOWING STATEMENT MUST BE CHECKED

<input type="checkbox"/>	_____	_____
	Signature of Authorized Representative	Date

RETURN WITH BID

SPECIAL NOTICE TO CONTRACTORS

The following requirements of the Illinois Department of Human Rights' Rules and Regulations are applicable to bidders on all construction contracts advertised by the Illinois Department of Transportation:

CONSTRUCTION EMPLOYEE UTILIZATION PROJECTION

- (a) All bidders on construction contracts shall complete and submit, along with and as part of their bids, a Bidder's Employee Utilization Form (Form BC-1256) setting forth a projection and breakdown of the total workforce intended to be hired and/or allocated to such contract work by the bidder including a projection of minority and female employee utilization in all job classifications on the contract project.
- (b) The Department of Transportation shall review the Employee Utilization Form, and workforce projections contained therein, of the contract awardee to determine if such projections reflect an underutilization of minority persons and/or women in any job classification in accordance with the Equal Employment Opportunity Clause and Section 7.2 of the Illinois Department of Human Rights' Rules and Regulations for Public Contracts adopted as amended on September 17, 1980. If it is determined that the contract awardee's projections reflect an underutilization of minority persons and/or women in any job classification, it shall be advised in writing of the manner in which it is underutilizing and such awardee shall be considered to be in breach of the contract unless, prior to commencement of work on the contract project, it submits revised satisfactory projections or an acceptable written affirmative action plan to correct such underutilization including a specific timetable geared to the completion stages of the contract.
- (c) The Department of Transportation shall provide to the Department of Human Rights a copy of the contract awardee's Employee Utilization Form, a copy of any required written affirmative action plan, and any written correspondence related thereto. The Department of Human Rights may review and revise any action taken by the Department of Transportation with respect to these requirements.

RETURN WITH BID



Contract No. 64G53
OGLE County
Section D2 PATCHING 2011-2
Route FAI 39
District 2 Construction Funds

PART I. IDENTIFICATION

Dept. Human Rights # _____ Duration of Project: _____

Name of Bidder: _____

PART II. WORKFORCE PROJECTION

A. The undersigned bidder has analyzed minority group and female populations, unemployment rates and availability of workers for the location in which this contract work is to be performed, and for the locations from which the bidder recruits employees, and hereby submits the following workforce projection including a projection for minority and female employee utilization in all job categories in the workforce to be allocated to this contract:

TABLE A

TABLE B

TOTAL Workforce Projection for Contract												
JOB CATEGORIES	TOTAL EMPLOYEES		MINORITY EMPLOYEES						TRAINEES			
			BLACK		HISPANIC		*OTHER MINOR.		APPRENTICES		ON THE JOB TRAINEES	
	M	F	M	F	M	F	M	F	M	F	M	F
OFFICIALS (MANAGERS)												
SUPERVISORS												
FOREMEN												
CLERICAL												
EQUIPMENT OPERATORS												
MECHANICS												
TRUCK DRIVERS												
IRONWORKERS												
CARPENTERS												
CEMENT MASONS												
ELECTRICIANS												
PIPEFITTERS, PLUMBERS												
PAINTERS												
LABORERS, SEMI-SKILLED												
LABORERS, UNSKILLED												
TOTAL												

CURRENT EMPLOYEES TO BE ASSIGNED TO CONTRACT			
TOTAL EMPLOYEES		MINORITY EMPLOYEES	
M	F	M	F

TABLE C

TOTAL Training Projection for Contract								
EMPLOYEES IN TRAINING	TOTAL EMPLOYEES		BLACK		HISPANIC		*OTHER MINOR.	
	M	F	M	F	M	F	M	F
APPRENTICES								
ON THE JOB TRAINEES								

FOR DEPARTMENT USE ONLY

* Other minorities are defined as Asians (A) or Native Americans (N). Please specify race of each employee shown in Other Minorities column.

Note: See instructions on page 2

RETURN WITH BID

**Contract No. 64G53
OGLE County
Section D2 PATCHING 2011-2
Route FAI 39
District 2 Construction Funds**

PART II. WORKFORCE PROJECTION - continued

- B. Included in "Total Employees" under Table A is the total number of **new hires** that would be employed in the event the undersigned bidder is awarded this contract.

The undersigned bidder projects that: (number) _____ new hires would be recruited from the area in which the contract project is located; and/or (number) _____ new hires would be recruited from the area in which the bidder's principal office or base of operation is located.

- C. Included in "Total Employees" under Table A is a projection of numbers of persons to be employed directly by the undersigned bidder as well as a projection of numbers of persons to be employed by subcontractors.

The undersigned bidder estimates that (number) _____ persons will be directly employed by the prime contractor and that (number) _____ persons will be employed by subcontractors.

PART III. AFFIRMATIVE ACTION PLAN

- A. The undersigned bidder understands and agrees that in the event the foregoing minority and female employee utilization projection included under **PART II** is determined to be an underutilization of minority persons or women in any job category, and in the event that the undersigned bidder is awarded this contract, he/she will, prior to commencement of work, develop and submit a written Affirmative Action Plan including a specific timetable (geared to the completion stages of the contract) whereby deficiencies in minority and/or female employee utilization are corrected. Such Affirmative Action Plan will be subject to approval by the contracting agency and the **Department of Human Rights**.
- B. The undersigned bidder understands and agrees that the minority and female employee utilization projection submitted herein, and the goals and timetable included under an Affirmative Action Plan if required, are deemed to be part of the contract specifications.

Company _____ Telephone Number _____

Address _____

NOTICE REGARDING SIGNATURE

The Bidder's signature on the Proposal Signature Sheet will constitute the signing of this form. The following signature block needs to be completed if revisions are required.

Signature: _____ Title: _____ Date: _____

- Instructions: All tables must include subcontractor personnel in addition to prime contractor personnel.
- Table A - Include both the number of employees that would be hired to perform the contract work and the total number currently employed (Table B) that will be allocated to contract work, and include all apprentices and on-the-job trainees. The "Total Employees" column should include all employees including all minorities, apprentices and on-the-job trainees to be employed on the contract work.
 - Table B - Include all employees currently employed that will be allocated to the contract work including any apprentices and on-the-job trainees currently employed.
 - Table C - Indicate the racial breakdown of the total apprentices and on-the-job trainees shown in Table A.

RETURN WITH BID

Contract No. 64G53

OGLE County

Section D2 PATCHING 2011-2

Route FAI 39

District 2 Construction Funds

PROPOSAL SIGNATURE SHEET

The undersigned bidder hereby makes and submits this bid on the subject Proposal, thereby assuring the Department that all requirements of the Invitation for Bids and rules of the Department have been met, that there is no misunderstanding of the requirements of paragraph 3 of this Proposal, and that the contract will be executed in accordance with the rules of the Department if an award is made on this bid.

(IF AN INDIVIDUAL) Firm Name _____
Signature of Owner _____
Business Address _____

(IF A CO-PARTNERSHIP) Firm Name _____
By _____
Business Address _____
Name and Address of All Members of the Firm:

(IF A CORPORATION)
(IF A JOINT VENTURE, USE THIS SECTION FOR THE MANAGING PARTY AND THE SECOND PARTY SHOULD SIGN BELOW) Corporate Name _____
By _____
Signature of Authorized Representative _____
Typed or printed name and title of Authorized Representative _____
Attest _____
Signature _____
Business Address _____

(IF A JOINT VENTURE) Corporate Name _____
By _____
Signature of Authorized Representative _____
Typed or printed name and title of Authorized Representative _____
Attest _____
Signature _____
Business Address _____

If more than two parties are in the joint venture, please attach an additional signature sheet.



Return with Bid

Division of Highways
Proposal Bid Bond
(Effective November 1, 1992)

Item No.
Letting Date

KNOW ALL MEN BY THESE PRESENTS, That We

as PRINCIPAL, and

as SURETY, are held jointly, severally and firmly bound unto the STATE OF ILLINOIS in the penal sum of 5 percent of the total bid price, or for the amount specified in Article 102.09 of the "Standard Specifications for Road and Bridge Construction" in effect on the date of invitation for bids, whichever is the lesser sum, well and truly to be paid unto said STATE OF ILLINOIS, for the payment of which we bind ourselves, our heirs, executors, administrators, successors and assigns.

THE CONDITION OF THE FOREGOING OBLIGATION IS SUCH, that whereas, the PRINCIPAL has submitted a bid proposal to the STATE OF ILLINOIS, acting through the Department of Transportation, for the improvement designated by the Transportation Bulletin Item Number and Letting Date indicated above.

NOW, THEREFORE, if the Department shall accept the bid proposal of the PRINCIPAL; and if the PRINCIPAL shall, within the time and as specified in the bidding and contract documents, submit a DBE Utilization Plan that is accepted and approved by the Department; and if, after award by the Department, the PRINCIPAL shall enter into a contract in accordance with the terms of the bidding and contract documents including evidence of the required insurance coverages and providing such bond as specified with good and sufficient surety for the faithful performance of such contract and for the prompt payment of labor and material furnished in the prosecution thereof; or if, in the event of the failure of the PRINCIPAL to make the required DBE submission or to enter into such contract and to give the specified bond, the PRINCIPAL pays to the Department the difference not to exceed the penalty hereof between the amount specified in the bid proposal and such larger amount for which the Department may contract with another party to perform the work covered by said bid proposal, then this obligation shall be null and void, otherwise, it shall remain in full force and effect.

IN THE EVENT the Department determines the PRINCIPAL has failed to comply with any requirement as set forth in the preceding paragraph, then Surety shall pay the penal sum to the Department within fifteen (15) days of written demand therefor. If Surety does not make full payment within such period of time, the Department may bring an action to collect the amount owed. Surety is liable to the Department for all its expenses, including attorney's fees, incurred in any litigation in which it prevails either in whole or in part.

In TESTIMONY WHEREOF, the said PRINCIPAL and the said SURETY have caused this instrument to be signed by their respective officers this day of A.D.,

PRINCIPAL SURETY
(Company Name) (Company Name)
By (Signature & Title) By: (Signature of Attorney-in-Fact)

Notary Certification for Principal and Surety

STATE OF ILLINOIS,
County of
I, , a Notary Public in and for said County, do hereby certify that
and
(Insert names of individuals signing on behalf of PRINCIPAL & SURETY)

who are each personally known to me to be the same persons whose names are subscribed to the foregoing instrument on behalf of PRINCIPAL and SURETY, appeared before me this day in person and acknowledged respectively, that they signed and delivered said instrument as their free and voluntary act for the uses and purposes therein set forth.

Given under my hand and notarial seal this day of A.D.
My commission expires
Notary Public

In lieu of completing the above section of the Proposal Bid Form, the Principal may file an Electronic Bid Bond. By signing the proposal and marking the check box next to the Signature and Title line below, the Principal is ensuring the identified electronic bid bond has been executed and the Principal and Surety are firmly bound unto the State of Illinois under the conditions of the bid bond as shown above.

Electronic Bid Bond ID# Company / Bidder Name Signature and Title

(1) Policy

It is public policy that disadvantageded businesses as defined in 49 CFR Part 26 and the Special Provision shall have the maximum opportunity to participate in the performance of contracts financed in whole or in part with Federal or State funds. Consequently the requirements of 49 CFR Part 26 apply to this contract.

(2) Obligation

The contractor agrees to ensure that disadvantageded businesses as defined in 49 CFR Part 26 and the Special Provision have the maximum opportunity to participate in the performance of contracts or subcontracts financed in whole or in part with Federal or State funds. The contractor shall take all necessary and reasonable steps in accordance with 49 CFR Part 26 and the Special Provision to ensure that said businesses have the maximum opportunity to compete for and perform under this contract. The contractor shall not discriminate on the basis of race, color, national origin or sex in the award and performance of contracts.

(3) Project and Bid Identification

Complete the following information concerning the project and bid:

Route _____	Total Bid _____
Section _____	Contract DBE Goal _____ (Percent) _____ (Dollar Amount)
Project _____	
County _____	
Letting Date _____	
Contract No. _____	
Letting Item No. _____	

(4) Assurance

I, acting in my capacity as an officer of the undersigned bidder (or bidders if a joint venture), hereby assure the Department that on this project my company : (check one)

Meets or exceeds contract award goals and has provided documented participation as follows:
Disadvantaged Business Participation _____ percent

Attached are the signed participation statements, forms SBE 2025, required by the Special Provision evidencing availability and use of each business participating in this plan and assuring that each business will perform a commercially useful function in the work of the contract.

Failed to meet contract award goals and has included good faith effort documentation to meet the goals and that my company has provided participation as follows:
Disadvantaged Business Participation _____ percent

The contract goals should be accordingly modified or waived. Attached is all information required by the Special Provision in support of this request including good faith effort. Also attached are the signed participation statements, forms SBE 2025, required by the Special Provision evidencing availability and use of each business participating in this plan and assuring that each business will perform a commercially useful function in the work of the contract.

Company

By _____

Title _____

Date _____

The "as read" Low Bidder is required to comply with the Special Provision.

Submit only one utilization plan for each project. The utilization plan shall be submitted in accordance with the special provision.

Bureau of Small Business Enterprises 2300 South Dirksen Parkway Springfield, Illinois 62764	<u>Local Let Projects</u> Submit forms to the Local Agency
---	---



Illinois Department of Transportation

DBE Participation Statement

Subcontractor Registration _____

Letting _____

Participation Statement

Item No. _____

(1) Instructions

Contract _____

This form must be completed for each disadvantaged business participating in the Utilization Plan. This form shall be submitted in accordance with the special provision and will be attached to the Utilization Plan form. If additional space is needed complete an additional form for the firm.

(2) Work

Pay Item No.	Description	Quantity	Unit Price	Total
Total				

(3) Partial Payment Items

For any of the above items which are partial pay items, specifically describe the work and subcontract dollar amount:

(4) Commitment

The undersigned certify that the information included herein is true and correct, and that the DBE firm listed below has agreed to perform a commercially useful function in the work of the contract item(s) listed above and to execute a contract with the prime contractor. The undersigned further understand that no changes to this statement may be made without prior approval from the Department's Bureau of Small Business Enterprises and that complete and accurate information regarding actual work performed on this project and the payment therefore must be provided to the Department.

Signature for Prime Contractor

Title _____
Date _____
Contact _____
Phone _____
Firm Name _____
Address _____
City/State/Zip _____

Signature for DBE Firm

Title _____
Date _____
Contact _____
Phone _____
Firm Name _____
Address _____
City/State/Zip _____

E _____
WC _____

The Department of Transportation is requesting disclosure of information that is necessary to accomplish the statutory purpose as outlined under the state and federal law. Disclosure of this information is **REQUIRED**. Failure to provide any information will result in the contract not being awarded. This form has been approved by the State Forms Management Center.

PROPOSAL ENVELOPE



PROPOSALS

for construction work advertised for bids by the
Illinois Department of Transportation

Item No.	Item No.	Item No.

Submitted By:

Name:
Address:
Phone No.

Bidders should use an IDOT proposal envelope or affix this form to the front of a 10" x 13" envelope for the submittal of bids. If proposals are mailed, they should be enclosed in a second or outer envelope addressed to:

Engineer of Design and Environment - Room 326
Illinois Department of Transportation
2300 South Dirksen Parkway
Springfield, Illinois 62764

NOTICE

Individual bids, including Bid Bond and/or supplemental information if required, should be securely stapled.

CONTRACTOR OFFICE COPY OF CONTRACT SPECIFICATIONS

NOTICE

None of the following material needs to be returned with the bid package unless the special provisions require documentation and/or other information to be submitted.

Contract No. 64G53
OGLE County
Section D2 PATCHING 2011-2
Route FAI 39
District 2 Construction Funds



Illinois Department of Transportation

SUBCONTRACTOR DOCUMENTATION

Public Acts 96-0795 and 96-0920, enacted substantial changes to the provisions of the Illinois Procurement Code (30 ILCS 500). Among the changes are provisions affecting subcontractors. The Contractor awarded this contract will be required as a material condition of the contract to implement and enforce the contract requirements applicable to subcontractors approved in accordance with article 108.01 of the Standard Specifications for Road and Bridge Construction.

If the Contractor seeks approval of subcontractors to perform a portion of the work, and approval is granted by the Department, the Contractor shall provide a copy of the subcontract to the Chief Procurement Officer within 20 calendar days after execution of the subcontract.

The subcontract shall contain the certifications required to be made by subcontractors pursuant to Article 50 of the Illinois Procurement Code. This Notice to Bidders includes a document incorporating all required subcontractor certifications and disclosures for use by the Contractor in compliance with this mandate. The document is entitled State Required Ethical Standards Governing Subcontractors.

RETURN WITH SUBCONTRACT

STATE ETHICAL STANDARDS GOVERNING SUBCONTRACTORS

Article 50 of the Illinois Procurement Code establishes the duty of all State chief procurement officers, State purchasing officers, and their designees to maximize the value of the expenditure of public moneys in procuring goods, services, and contracts for the State of Illinois and to act in a manner that maintains the integrity and public trust of State government. In discharging this duty, they are charged by law to use all available information, reasonable efforts, and reasonable actions to protect, safeguard, and maintain the procurement process of the State of Illinois.

The certifications hereinafter made by the subcontractor are each a material representation of fact upon which reliance is placed should the Department approve the subcontractor. The chief procurement officer may terminate or void the subcontract approval if it is later determined that the bidder or subcontractor rendered a false or erroneous certification.

Section 50-2 of the Illinois Procurement Code provides that every person that has entered into a multi-year contract and every subcontractor with a multi-year subcontract shall certify, by July 1 of each fiscal year covered by the contract after the initial fiscal year, to the responsible chief procurement officer whether it continues to satisfy the requirements of Article 50 pertaining to the eligibility for a contract award. If a contractor or subcontractor is not able to truthfully certify that it continues to meet all requirements, it shall provide with its certification a detailed explanation of the circumstances leading to the change in certification status. A contractor or subcontractor that makes a false statement material to any given certification required under Article 50 is, in addition to any other penalties or consequences prescribed by law, subject to liability under the Whistleblower Reward and Protection Act for submission of a false claim.

A. Bribery

1. The Illinois Procurement Code provides:

Section 50-5. Bribery.

(a) Prohibition. No person or business shall be awarded a contract or subcontract under this Code who:

(1) has been convicted under the laws of Illinois or any other state of bribery or attempting to bribe an officer or employee of the State of Illinois or any other state in that officer's or employee's official capacity; or

(2) has made an admission of guilt of that conduct that is a matter of record but has not been prosecuted for that conduct.

(b) Businesses. No business shall be barred from contracting with any unit of State or local government, or subcontracting under such a contract, as a result of a conviction under this Section of any employee or agent of the business if the employee or agent is no longer employed by the business and:

(1) the business has been finally adjudicated not guilty; or

(2) the business demonstrates to the governmental entity with which it seeks to contract, or which is signatory to the contract to which the subcontract relates, and that entity finds that the commission of the offense was not authorized, requested, commanded, or performed by a director, officer, or high managerial agent on behalf of the business as provided in paragraph (2) of subsection (a) of Section 5-4 of the Criminal Code of 1961.

(c) Conduct on behalf of business. For purposes of this Section, when an official, agent, or employee of a business committed the bribery or attempted bribery on behalf of the business and in accordance with the direction or authorization of a responsible official of the business, the business shall be chargeable with the conduct.

(d) Certification. Every bid submitted to and contract executed by the State, and every subcontract subject to Section 20-120 of the Procurement Code shall contain a certification by the contractor or the subcontractor, respectively, that the contractor or subcontractor is not barred from being awarded a contract or subcontract under this Section and acknowledges that the chief procurement officer may declare the related contract void if any certifications required by this Section are false. A contractor who makes a false statement, material to the certification, commits a Class 3 felony.

2. The contractor or subcontractor certifies that it is not barred from being awarded a contract under Section 50.5.

B. Felons

1. The Illinois Procurement Code provides:

Section 50-10. Felons. Unless otherwise provided, no person or business convicted of a felony shall do business with the State of Illinois or any State agency, or enter into a subcontract, from the date of conviction until 5 years after the date of completion of the sentence for that felony, unless no person held responsible by a prosecutorial office for the facts upon which the conviction was based continues to have any involvement with the business.

2. Certification. Every bid submitted to and contract executed by the State and every subcontract subject to Section 20-120 of the Procurement Code shall contain a certification by the bidder or contractor or subcontractor, respectively, that the bidder, contractor, or subcontractor is not barred from being awarded a contract or subcontract under this Section and acknowledges that the chief procurement officer may declare the related contract void if any of the certifications required by this Section are false.

RETURN WITH SUBCONTRACT

C. Debt Delinquency

1. The Illinois Procurement Code provides:

Section 50-11 and 50-12. Debt Delinquency.

The contractor or bidder or subcontractor, respectively, certifies that it, or any affiliate, is not barred from being awarded a contract or subcontract under the Procurement Code. Section 50-11 prohibits a person from entering into a contract with a State agency, or entering into a subcontract, if it knows or should know that it, or any affiliate, is delinquent in the payment of any debt to the State as defined by the Debt Collection Board. Section 50-12 prohibits a person from entering into a contract with a State agency, or entering into a subcontract, if it, or any affiliate, has failed to collect and remit Illinois Use Tax on all sales of tangible personal property into the State of Illinois in accordance with the provisions of the Illinois Use Tax Act. The bidder or contractor or subcontractor, respectively, further acknowledges that the chief procurement officer may declare the related contract void if this certification is false or if the bidder, contractor, or subcontractor, or any affiliate, is determined to be delinquent in the payment of any debt to the State during the term of the contract.

D. Prohibited Bidders, Contractors and Subcontractors

1. The Illinois Procurement Code provides:

Section 50-10.5 and 50-60(c). Prohibited bidders, contractors and subcontractors.

The bidder or contractor or subcontractor, respectively, certifies in accordance with 30 ILCS 500/50-10.5 that no officer, director, partner or other managerial agent of the contracting business has been convicted of a felony under the Sarbanes-Oxley Act of 2002 or a Class 3 or Class 2 felony under the Illinois Securities Law of 1953 or if in violation of Subsection (c) for a period of five years from the date of conviction.. Every bid submitted to and contract executed by the State and every subcontract subject to Section 20-120 of the Procurement Code shall contain a certification by the bidder, contractor, or subcontractor, respectively, that the bidder, contractor, or subcontractor is not barred from being awarded a contract or subcontract under this Section and acknowledges that the chief procurement officer shall declare the related contract void if any of the certifications completed pursuant to this Section are false.

E. Section 42 of the Environmental Protection Act

The bidder or contractor or subcontractor, respectively, certifies in accordance with 30 ILCS 500/50-12 that the bidder, contractor, or subcontractor, is not barred from being awarded a contract or entering into a subcontract under this Section which prohibits the bidding on or entering into contracts with the State of Illinois or a State agency, or entering into any subcontract, that is subject to the Procurement Code by a person or business found by a court or the Pollution Control Board to have committed a willful or knowing violation of Section 42 of the Environmental Protection Act for a period of five years from the date of the order. The bidder or contractor or subcontractor, respectively, acknowledges that the chief procurement officer may declare the contract void if this certification is false.

The undersigned, on behalf of the subcontracting company, has read and understands the above certifications and makes the certifications as required by law.

_____ Name of Subcontracting Company		
_____ Authorized Officer	_____ Date	

RETURN WITH SUBCONTRACT
SUBCONTRACTOR DISCLOSURES

I. DISCLOSURES

- A. The disclosures hereinafter made by the subcontractor are each a material representation of fact upon which reliance is placed. The subcontractor further certifies that the Department has received the disclosure forms for each subcontract.

The chief procurement officer may void the bid, contract, or subcontract, respectively, if it is later determined that the bidder or subcontractor rendered a false or erroneous disclosure. A contractor or subcontractor may be suspended or debarred for violations of the Procurement Code. Furthermore, the chief procurement officer may void the contract or subcontract.

B. Financial Interests and Conflicts of Interest

1. Section 50-35 of the Illinois Procurement Code provides that all subcontracts with a total value of \$25,000 or more from subcontractors identified in Section 20-120 of the Illinois Procurement Code, shall be accompanied by disclosure of the financial interests of the subcontractor. This disclosed information for the subcontractor, will be maintained as public information subject to release by request pursuant to the Freedom of Information Act, filed with the Procurement Policy Board, and shall be incorporated as a material term of the Prime Contractor's contract. Furthermore, pursuant to this Section, the Procurement Policy Board may recommend to allow or void a contract or subcontract based on a potential conflict of interest.

The financial interests to be disclosed shall include ownership or distributive income share that is in excess of 5%, or an amount greater than 60% of the annual salary of the Governor, of the subcontracting entity or its parent entity, whichever is less, unless the subcontractor is a publicly traded entity subject to Federal 10K reporting, in which case it may submit its 10K disclosure in place of the prescribed disclosure. If a subcontractor is a privately held entity that is exempt from Federal 10K reporting, but has more than 400 shareholders, it may submit the information that Federal 10K companies are required to report, and list the names of any person or entity holding any ownership share that is in excess of 5%. The disclosure shall include the names, addresses, and dollar or proportionate share of ownership of each person making the disclosure, their instrument of ownership or beneficial relationship, and notice of any potential conflict of interest resulting from the current ownership or beneficial interest of each person making the disclosure having any of the relationships identified in Section 50-35 and on the disclosure form.

The current annual salary of the Governor is \$177,412.00.

In addition, all disclosures shall indicate any other current or pending contracts, subcontracts, proposals, leases, or other ongoing procurement relationships the subcontracting entity has with any other unit of state government and shall clearly identify the unit and the contract, subcontract, proposal, lease, or other relationship.

2. Disclosure Forms. Disclosure Form A is attached for use concerning the individuals meeting the above ownership or distributive share requirements. Subject individuals should be covered each by one form. In addition, a second form (Disclosure Form B) provides for the disclosure of current or pending procurement relationships with other (non-IDOT) state agencies.

C. Disclosure Form Instructions

Form A Instructions for Financial Information & Potential Conflicts of Interest

If the subcontractor is a publicly traded entity subject to Federal 10K reporting, the 10K Report may be submitted to meet the requirements of Form A. If a subcontractor is a privately held entity that is exempt from Federal 10K reporting, but has more than 400 shareholders, it may submit the information that Federal 10K companies are required to report, and list the names of any person or entity holding any ownership share that is in excess of 5%. If a subcontractor is not subject to Federal 10K reporting, the subcontractor must determine if any individuals are required by law to complete a financial disclosure form. To do this, the subcontractor should answer each of the following questions. A "YES" answer indicates Form A must be completed. If the answer to each of the following questions is "NO", then the **NOT APPLICABLE STATEMENT** on the second page of Form A must be signed and dated by a person that is authorized to execute contracts for the subcontracting company. Note: These questions are for assistance only and are not required to be completed.

1. Does anyone in your organization have a direct or beneficial ownership share of greater than 5% of the bidding entity or parent entity? YES ___ NO ___
2. Does anyone in your organization have a direct or beneficial ownership share of less than 5%, but which has a value greater than 60% of the annual salary of the Governor? YES ___ NO ___
3. Does anyone in your organization receive more than 60% of the annual salary of the Governor of the subcontracting entity's or parent entity's distributive income? YES ___ NO ___

(Note: Distributive income is, for these purposes, any type of distribution of profits. An annual salary is not distributive income.)

4. Does anyone in your organization receive greater than 5% of the subcontracting entity's or parent entity's total distributive income, but which is less than 60% of the annual salary of the Governor? YES ___ NO ___

(Note: Only one set of forms needs to be completed per person per subcontract even if a specific individual would require a yes answer to more than one question.)

A "YES" answer to any of these questions requires the completion of Form A. The subcontractor must determine each individual in the subcontracting entity or the subcontracting entity's parent company that would cause the questions to be answered "Yes". Each form must be signed and dated by a person that is authorized to execute contracts for your organization. **Photocopied or stamped signatures are not acceptable.** The person signing can be, but does not have to be, the person for which the form is being completed. The subcontractor is responsible for the accuracy of any information provided.

If the answer to each of the above questions is "NO", then the **NOT APPLICABLE STATEMENT** on page 2 of Form A must be signed and dated by a person that is authorized to execute contracts for your company.

RETURN WITH SUBCONTRACT

Form B: Instructions for Identifying Other Contracts & Procurement Related Information

Disclosure Form B must be completed for each subcontract submitted by the subcontracting entity. *Note: Checking the NOT APPLICABLE STATEMENT on Form A does not allow the subcontractor to ignore Form B. Form B must be completed, checked, and dated or the subcontract will not be approved.*

The Subcontractor shall identify, by checking Yes or No on Form B, whether it has any pending contracts, subcontracts, leases, bids, proposals, or other ongoing procurement relationship with any other (non-IDOT) State of Illinois agency. If "No" is checked, the subcontractor only needs to complete the check box on the bottom of Form B. If "Yes" is checked, the subcontractor must list all non-IDOT State of Illinois agency pending contracts, subcontracts, leases, bids, proposals, and other ongoing procurement relationships. These items may be listed on Form B or on an attached sheet(s). Contracts with cities, counties, villages, etc. are not considered State of Illinois agency contracts and are not to be included. Contracts or subcontracts with other State of Illinois agencies such as the Department of Natural Resources or the Capital Development Board must be included.

ILLINOIS DEPARTMENT OF TRANSPORTATION

Form A Subcontractor: Financial Information & Potential Conflicts of Interest Disclosure

Subcontractor Name, Legal Address, City, State, Zip, Telephone Number, Email Address, Fax Number (if available)

Disclosure of the information contained in this Form is required by the Section 50-35 of the Illinois Procurement Code (30 ILCS 500). Subcontractors desiring to enter into a subcontract of a State of Illinois contract must disclose the financial information and potential conflict of interest information as specified in this Disclosure Form.

The current annual salary of the Governor is \$177,412.00.

DISCLOSURE OF FINANCIAL INFORMATION

1. Disclosure of Financial Information. The individual named below has an interest in the SUBCONTRACTOR (or its parent) in terms of ownership or distributive income share in excess of 5%, or an interest which has a value of more than 60% of the annual salary of the Governor.

FOR INDIVIDUAL (type or print information) NAME: ADDRESS Type of ownership/distributable income share: stock sole proprietorship Partnership other: (explain on separate sheet): % or \$ value of ownership/distributable income share:

2. Disclosure of Potential Conflicts of Interest. Check "Yes" or "No" to indicate which, if any, of the following potential conflict of interest relationships apply. If the answer to any question is "Yes", please attach additional pages and describe.

(a) State employment, currently or in the previous 3 years, including contractual employment of services. Yes ___ No ___

If your answer is yes, please answer each of the following questions.

- 1. Are you currently an officer or employee of either the Capitol Development Board or the Illinois State Toll Highway Authority? Yes ___ No ___
2. Are you currently appointed to or employed by any agency of the State of Illinois? If you are currently appointed to or employed by any agency of the State of Illinois, and your annual salary exceeds 60% of the annual salary of the Governor, provide the name the State agency for which you are employed and your annual salary.

RETURN WITH SUBCONTRACT

3. If you are currently appointed to or employed by any agency of the State of Illinois, and your annual salary exceeds 60% of the annual salary of the Governor, are you entitled to receive (i) more than 7 1/2% of the total distributable income of your firm, partnership, association or corporation, or (ii) an amount in excess of 100% of the annual salary of the Governor?
Yes ___ No ___

4. If you are currently appointed to or employed by any agency of the State of Illinois, and your annual salary exceeds 60% of the annual salary of the Governor, are you and your spouse or minor children entitled to receive (i) more than 15 % in the aggregate of the total distributable income of your firm, partnership, association or corporation, or (ii) an amount in excess of two times the salary of the Governor?
Yes ___ No ___

(b) State employment of spouse, father, mother, son, or daughter, including contractual employment services in the previous 2 years.

Yes ___ No ___

If your answer is yes, please answer each of the following questions.

1. Is your spouse or any minor children currently an officer or employee of the Capitol Development Board or the Illinois Toll Highway Authority?
Yes ___ No ___

2. Is your spouse or any minor children currently appointed to or employed by any agency of the State of Illinois? If your spouse or minor children is/are currently appointed to or employed by any agency of the State of Illinois, and his/her annual salary exceeds 60% of the annual salary of the Governor, provide the name of your spouse and/or minor children, the name of the State agency for which he/she is employed and his/her annual salary. _____

3. If your spouse or any minor children is/are currently appointed to or employed by any agency of the State of Illinois, and his/her annual salary exceeds 60% of the annual salary of the Governor, as of 7/1/07 are you entitled to receive (i) more then 7 1/2% of the total distributable income of your firm, partnership, association or corporation, or (ii) an amount in excess of 100% of the annual salary of the Governor?
Yes ___ No ___

4. If your spouse or any minor children are currently appointed to or employed by any agency of the State of Illinois, and his/her annual salary exceeds 60% of the annual salary of the Governor, are you and your spouse or minor children entitled to receive (i) more than 15 % in the aggregate of the total distributable income of your firm, partnership, association or corporation, or (ii) an amount in excess of two times the annual salary of the Governor?
Yes ___ No ___

(c) Elective status; the holding of elective office of the State of Illinois, the government of the United States, any unit of local government authorized by the Constitution of the State of Illinois or the statutes of the State of Illinois currently or in the previous 3 years.
Yes ___ No ___

(d) Relationship to anyone holding elective office currently or in the previous 2 years; spouse, father, mother, son, or daughter.
Yes ___ No ___

(e) Appointive office; the holding of any appointive government office of the State of Illinois, the United States of America, or any unit of local government authorized by the Constitution of the State of Illinois or the statutes of the State of Illinois, which office entitles the holder to compensation in excess of the expenses incurred in the discharge of that office currently or in the previous 3 years.
Yes ___ No ___

(f) Relationship to anyone holding appointive office currently or in the previous 2 years; spouse, father, mother, son, or daughter.
Yes ___ No ___

(g) Employment, currently or in the previous 3 years, as or by any registered lobbyist of the State government.
Yes ___ No ___

RETURN WITH SUBCONTRACT

(h) Relationship to anyone who is or was a registered lobbyist in the previous 2 years; spouse, father, mother, son, or daughter. Yes ___ No ___

(i) Compensated employment, currently or in the previous 3 years, by any registered election or reelection committee registered with the Secretary of State or any county clerk of the State of Illinois, or any political action committee registered with either the Secretary of State or the Federal Board of Elections. Yes ___ No ___

(j) Relationship to anyone; spouse, father, mother, son, or daughter; who was a compensated employee in the last 2 years by any registered election or re-election committee registered with the Secretary of State or any county clerk of the State of Illinois, or any political action committee registered with either the Secretary of State or the Federal Board of Elections. Yes ___ No ___

3. Communication Disclosure.

Disclose the name and address of each lobbyist and other agent of the bidder or offeror who is not identified in Section 2 of this form, who is has communicated, is communicating, or may communicate with any State officer or employee concerning the bid or offer. This disclosure is a continuing obligation and must be promptly supplemented for accuracy throughout the process and throughout the term of the contract. If no person is identified, enter "None" on the line below:

Name and address of person(s): _____

RETURN WITH SUBCONTRACT

4. Debarment Disclosure. For each of the persons identified under Sections 2 and 3 of this form, disclose whether any of the following has occurred within the previous 10 years: debarment from contracting with any governmental entity; professional licensure discipline; bankruptcies; adverse civil judgments and administrative findings; and criminal felony convictions. This disclosure is a continuing obligation and must be promptly supplemented for accuracy throughout the procurement process and term of the contract. If no person is identified, enter "None" on the line below:

Name of person(s): _____

Nature of disclosure: _____

APPLICABLE STATEMENT

This Disclosure Form A is submitted on behalf of the INDIVIDUAL named on previous page. Under penalty of perjury, I certify the contents of this disclosure to be true and accurate to the best of my knowledge.

Completed by: _____ Date _____
Signature of Individual or Authorized Officer

NOT APPLICABLE STATEMENT

Under penalty of perjury, I have determined that no individuals associated with this organization meet the criteria that would require the completion of this Form A.

This Disclosure Form A is submitted on behalf of the SUBCONTRACTOR listed on the previous page.

_____ Date _____
Signature of Authorized Officer

RETURN WITH SUBCONTRACT

ILLINOIS DEPARTMENT
OF TRANSPORTATION

Form B
Subcontractor: Other Contracts &
Procurement Related Information
Disclosure

Subcontractor Name		
Legal Address		
City, State, Zip		
Telephone Number	Email Address	Fax Number (if available)

Disclosure of the information contained in this Form is required by the Section 50-35 of the Illinois Procurement Act (30 ILCS 500). This information shall become part of the publicly available contract file. This Form B must be completed for subcontracts with a total value of \$25,000 or more, from subcontractors identified in Section 20-120 of the Illinois Procurement Code, and for all open-ended contracts.

DISCLOSURE OF OTHER CONTRACTS, SUBCONTRACTS, AND PROCUREMENT RELATED INFORMATION

1. Identifying Other Contracts & Procurement Related Information. The SUBCONTRACTOR shall identify whether it has any pending contracts, subcontracts, including leases, bids, proposals, or other ongoing procurement relationship with any other State of Illinois agency: Yes ___ No ___

If "No" is checked, the subcontractor only needs to complete the signature box on the bottom of this page.

2. If "Yes" is checked. Identify each such relationship by showing State of Illinois agency name and other descriptive information such as bid or project number (attach additional pages as necessary). SEE DISCLOSURE FORM INSTRUCTIONS:

THE FOLLOWING STATEMENT MUST BE CHECKED

<input type="checkbox"/>	_____	_____
	Signature of Authorized Officer	Date



- 1. TIME AND PLACE OF OPENING BIDS.** Sealed proposals for the improvement described herein will be received by the Department of Transportation at the Harry R. Hanley Building, 2300 South Dirksen Parkway, in Springfield, Illinois until 10:00 o'clock a.m., June 17, 2011. All bids will be gathered, sorted, publicly opened and read in the auditorium at the Department of Transportation's Harry R. Hanley Building shortly after the 10:00 a.m. cut off time.
- 2. DESCRIPTION OF WORK.** The proposed improvement is identified and advertised for bids in the Invitation for Bids as:

**Contract No. 64G53
OGLE County
Section D2 PATCHING 2011-2
Route FAI 39
District 2 Construction Funds**

Pavement patching and intermittent milling and resurfacing on I-39 from Winnebago County to Lee County.

- 3. INSTRUCTIONS TO BIDDERS.** (a) This Notice, the invitation for bids, proposal and letter of award shall, together with all other documents in accordance with Article 101.09 of the Standard Specifications for Road and Bridge Construction, become part of the contract. Bidders are cautioned to read and examine carefully all documents, to make all required inspections, and to inquire or seek explanation of the same prior to submission of a bid.

(b) State law, and, if the work is to be paid wholly or in part with Federal-aid funds, Federal law requires the bidder to make various certifications as a part of the proposal and contract. By execution and submission of the proposal, the bidder makes the certification contained therein. A false or fraudulent certification shall, in addition to all other remedies provided by law, be a breach of contract and may result in termination of the contract.
- 4. AWARD CRITERIA AND REJECTION OF BIDS.** This contract will be awarded to the lowest responsive and responsible bidder considering conformity with the terms and conditions established by the Department in the rules, Invitation for Bids and contract documents. The issuance of plans and proposal forms for bidding based upon a prequalification rating shall not be the sole determinant of responsibility. The Department reserves the right to determine responsibility at the time of award, to reject any or all proposals, to readvertise the proposed improvement, and to waive technicalities.

By Order of the
Illinois Department of Transportation

Gary Hannig,
Secretary

INDEX
FOR
SUPPLEMENTAL SPECIFICATIONS
AND RECURRING SPECIAL PROVISIONS

Adopted January 1, 2011

This index contains a listing of SUPPLEMENTAL SPECIFICATIONS and frequently used RECURRING SPECIAL PROVISIONS.

ERRATA Standard Specifications for Road and Bridge Construction (Adopted 1-1-07) (Revised 1-1-11)

SUPPLEMENTAL SPECIFICATIONS

<u>Std. Spec. Sec.</u>	<u>Page No.</u>
201 Clearing, Tree Removal and Protection	1
205 Embankment	2
251 Mulch	3
253 Planting Woody Plants	4
280 Temporary Erosion Control	6
406 Hot-Mix Asphalt Binder and Surface Course	7
420 Portland Cement Concrete Pavement	11
443 Reflective Crack Control Treatment	12
501 Removal of Existing Structures	15
502 Excavation for Structures	16
503 Concrete Structures	17
504 Precast Concrete Structures	18
505 Steel Structures	19
508 Reinforcement Bars	20
540 Box Culverts	21
581 Waterproofing Membrane System	22
606 Concrete Gutter, Curb, Median, and Paved Ditch	23
630 Steel Plate Beam Guardrail	24
633 Removing and Reerecting Guardrail and Terminals	25
637 Concrete Barrier	26
664 Chain Link Fence	27
669 Removal and Disposal of Regulated Substances	28
672 Sealing Abandoned Water Wells	29
701 Work Zone Traffic Control and Protection	30
720 Sign Panels and Appurtenances	32
721 Sign Panel Overlay	33
722 Demountable Sign Legend Characters and Arrows	34
726 Mile Post Marker Assembly	35
733 Overhead Sign Structures	36
780 Pavement Striping	37
782 Prismatic Reflectors	42
783 Pavement Marking and Marker Removal	43
801 Electrical Requirements	44
805 Electrical Service Installation – Traffic Signals	45
821 Roadway Luminaires	46
836 Pole Foundation	47
838 Breakaway Devices	48
843 Removal of Navigational Obstruction Warning Lighting System	49
862 Uninterruptable Power Supply	50
873 Electric Cable	52
878 Traffic Signal Concrete Foundation	54
1003 Fine Aggregates	55
1004 Coarse Aggregates	56
1005 Stone and Broken Concrete	57
1006 Metals	58

1008	Structural Steel Coatings	60
1010	Finely Divided Materials	65
1020	Portland Cement Concrete	66
1022	Concrete Curing Materials	77
1024	Nonshrink Grout	78
1026	Concrete Sealer	79
1030	Hot-Mix Asphalt	80
1032	Bituminous Materials	87
1042	Precast Concrete Products	90
1062	Reflective Crack Control System	92
1069	Pole and Tower	94
1074	Control Equipment	97
1076	Wire and Cable	102
1077	Post and Foundation	103
1080	Fabric Materials	105
1081	Materials for Planting	106
1083	Elastomeric Bearings	108
1090	Sign Base	109
1091	Sign Face	111
1092	Sign Legend and Supplemental Panels	119
1093	Sign Supports	120
1094	Overhead Sign Structures	122
1095	Pavement Markings	128
1097	Reflectors	136
1101	General Equipment	137
1102	Hot-Mix Asphalt Equipment	138
1103	Portland Cement Concrete Equipment	140
1105	Pavement Marking Equipment	141
1106	Work Zone Traffic Control Devices	143

RECURRING SPECIAL PROVISIONS

The following RECURRING SPECIAL PROVISIONS indicated by an "X" are applicable to this contract and are included by reference:

<u>CHECK SHEET #</u>	<u>PAGE NO.</u>
1	145
2	148
3	149
4	159
5	164
6	169
7	170
8	171
9	172
10	175
11	178
12	180
13	184
14	186
15	187
16	189
17	190
18	192
19	193
20	194
21	198
22	200
23	202
24	204
25	205
26	206
27	207
28	208
29	209
30	210
31	218
32	230
33	231

TABLE OF CONTENTS

LOCATION OF PROJECT	1
DESCRIPTION OF PROJECT	1
TRAFFIC CONTROL PLAN	1
MAINTENANCE OF TRAFFIC.....	2
WORK RESTRICTIONS	3
CLASS A PATCHES	3
STABILIZED SUB-BASE REPLACEMENT, 4 INCH	3
COLD MILLING (SPECIAL)	4
MILLING RESTRICTIONS	4
APPROVAL OF PROPOSED BORROW AREAS, USE AREAS, AND/OR WASTE AREAS (BDE)	5
CEMENT (BDE)	5
CONCRETE ADMIXTURES (BDE)	7
CONSTRUCTION AIR QUALITY - DIESEL VEHICLE EMISSIONS CONTROL (BDE)	10
CONSTRUCTION AIR QUALITY - IDLING RESTRICTIONS (BDE).....	11
DISADVANTAGED BUSINESS ENTERPRISE PARTICIPATION (BDE)	12
EQUIPMENT RENTAL RATES (BDE).....	19
FRICTION AGGREGATE (BDE)	20
HOT-MIX ASPHALT – ANTI-STRIPPING ADDITIVE (BDE).....	23
HOT-MIX ASPHALT - DENSITY TESTING OF LONGITUDINAL JOINTS (BDE)	23
HOT-MIX ASPHALT – DROP-OFFS (BDE)	24
HOT-MIX ASPHALT - FINE AGGREGATE (BDE)	24
LIQUIDATED DAMAGES (BDE).....	25
NATIONAL POLLUTANT DISCHARGE ELIMINATION SYSTEM / EROSION AND SEDIMENT CONTROL DEFICIENCY DEDUCTION (BDE)	25
NIGHTTIME WORK ZONE LIGHTING (BDE)	27
PAVEMENT PATCHING (BDE).....	28
PAYMENTS TO SUBCONTRACTORS (BDE)	29
POST MOUNTING OF SIGNS (BDE).....	30
RAISED REFLECTIVE PAVEMENT MARKERS (BDE).....	30
RECLAIMED ASPHALT PAVEMENT (RAP) (BDE)	30
SELECTION OF LABOR (BDE).....	36
SUBCONTRACTOR MOBILIZATION PAYMENTS (BDE)	37
TRUCK MOUNTED/TRAILER MOUNTED ATTENUATORS (BDE)	37
UTILITY COORDINATION AND CONFLICTS (BDE).....	38
WORKING DAYS (BDE).....	43

STATE OF ILLINOIS
SPECIAL PROVISIONS

The following Special Provisions supplement the "Standard Specifications for Road and Bridge Construction," adopted January 1, 2007, the latest edition of the "Manual on Uniform Traffic Control Devices for Streets and Highways," and the "Manual of Test Procedures for Materials" in effect on the date of invitation for bids, and the Supplemental Specifications and Recurring Special Provisions indicated on the Check Sheet included herein which apply to and govern the construction of FAI 39 (I-39), Section D2 Patching 2011-2, in Ogle County, Contract 64G53 and in case of conflict with any part or parts of said Specifications, the said Special Provisions shall take precedence and shall govern.

LOCATION OF PROJECT

Work will be on Interstate 39 from Winnebago County to Lee County.

DESCRIPTION OF PROJECT

Work will be pavement patching and intermittent cold milling and resurfacing.

TRAFFIC CONTROL PLAN

Effective: January 14, 1999

Traffic Control shall be according to the applicable sections of the Standard Specifications for Road and Bridge Construction, the applicable guidelines contained in the National Manual on Uniform Traffic Control Devices for Streets and Highways, Illinois Supplement to the National Manual on Uniform Traffic Control Devices, these special provisions, and any special details and Highway Standards contained herein and in the plans.

Special attention is called to Articles 107.09 and 107.14 of the Standard Specifications for Road and Bridge Construction and the following Highway Standards relating to traffic control.

Standards:

701101	701400	701401	701411	701901
720001	720011	728001	729001	

Details:

District Standards 41.1, 44.1, 91.2

Signs:

No bracing shall be allowed on post-mounted signs.

Post-mounted signs shall be installed using standard 720011, 728001, 729001, on 4"x4" wood posts, or on any other "break away" connection if accepted by the FHWA and corresponding letter is provided to the resident.

All signs are required on both sides of the road when the median is greater than 10 feet and on one way roadways.

The "WORKERS" (W21-1a(O)-48) signs shall be replaced with symbol "Right or Left Lane Closed Ahead" (W4-2R or L(O)-48) signs on multilane roadways.

"BUMP" (W8-1(O)48) signs shall be installed as directed by the Engineer.

"UNEVEN LANES" W8-11(O)48 signs shall be installed at 1 mile intervals or as directed by the Engineer.

When covering existing Department signs, no tape shall be used on the reflective portion of the sign. Contact the District sign shop for covering techniques.

All regulatory signs shall be maintained at a 5 foot minimum bottom (rural), 7 foot minimum (urban).

Devices:

Vertical barricades shall not be used as a device.

Flaggers:

Flaggers shall comply with all requirements contained in the Department's "Flagger Handbook" with the following exception: The ANSI Class 2 vest will not be supplied by the Department.

Traffic Control and Protection Standard 701411:

Method of Measurement. Each ramp will be measured as a separate location and will be considered as a separate location for payment, regardless of the number of installations at that ramp.

The Contractor shall equip all machinery and vehicles with revolving amber lights, installed so the illumination is visible from all directions.

The median crossover will generally not be available for Contractor use. It may be used only when both lanes adjacent to the median are closed. Under no condition shall left turn lanes be made to cross the median from lanes open to traffic.

Parking of personal vehicles within the interstate right of way will be strictly prohibited. Parking of construction equipment within the right of way will be permitted only at locations approved by the Engineer.

MAINTENANCE OF TRAFFIC

The Class A patching shall be completed using Traffic Control and Protection Standard 701400 and Traffic Control and Protection Standard 701401.

The milling and resurfacing operations, and the removal and placement of the of the raised reflective pavement markers shall be completed using Traffic Control and Protection Standards 701400, 701401, and 701411.

The paint pavement markings shall be completed using Traffic Control and Protection Standard 701426.

WORK RESTRICTIONS

Work on this project will not be allowed on weekends. All lanes must be open to traffic by 3:00 pm on Thursday through 11:00 pm on Sunday. During legal holidays, section 107 of the Standard Specifications shall apply.

Additionally, no lane closures will be allowed between 3:00 pm and 6:00 pm Mondays through Wednesdays.

Traffic control devices shall be removed from the traffic lanes and all lanes shall be open to traffic 30 minutes after the Contractor ceases his work operations, or defined by work restriction hours, whichever comes first.

The Contractor shall become liable if they fail to completely open and keep open all traffic lanes on Interstate 39 in accordance with limitations specified. The Contractor shall be liable to the Department in the amount of \$700.00 for each lane blocked as liquidated and ascertained damages for each and every fifteen (15) minute interval, or portion thereof, that a lane is blocked outside the allowable time limitations. Such damages may be deducted by the Department from any monies due to the Contractor. These damages shall apply during the contract time and during any extensions of the contract time.

These work restrictions shall be considered to be included in the contract unit price per LUMP SUM for TRAFFIC CONTROL AND PROTECTION STANDARD 701401

CLASS A PATCHES

This work shall be completed in accordance with the applicable portions of Section 442 of the Standard Specifications for Road and Bridge Construction Standard 442001, as shown in the plans, as directed by the Engineer and as stated herein.

The areas where patching is required have been resurfaced with various thicknesses of bituminous material.

When constructing these patches, all work is to be done as typical Class A patches except when placing the concrete. The concrete is to be poured and struck off flush with the surrounding bituminous material. No extra reinforcement is to be placed in the area where the various bituminous thickness was above the existing concrete.

This work shall be paid for at the contract unit price per SQ YD. for CLASS A PATCHES of the type and thickness specified.

STABILIZED SUB-BASE REPLACEMENT, 4 INCH

This work shall be done in accordance with the applicable portions of Section 312 of the Standard Specifications.

This work shall consist of the removal of the disturbed or unsuitable sub-base material under areas of pavement patching. The sub-base replacement material shall meet the requirements in Section 442, Article 442.02, Note 1, and be used to restore the sub-base to the existing line and grade.

The placement of the material for the patch shall be placed upon the newly replaced sub-base upon the approval of the Engineer.

Quantities for this work have been estimated at 50% of the pavement removal and replacement and the final quantities shall be determined in the field by the Engineer.

This work will be measured and paid for at the contract unit price per Square Yard for STABILIZED SUB-BASE REPLACEMENT, 4 INCH.

COLD MILLING (SPECIAL)

This work shall be completed in accordance with the applicable portions of Section 440 of the Standard Specifications for Road and Bridge Construction, as directed by the engineer as shown in the plans and as stated here in.

Grinding will be in the area where the existing hot-mix asphalt surface has been tapered down from 5 inches to ½ inch at the bridge approach pavement or where it has been tapered down to ½ inch to maintain proper clearance at a structure over I-39.

Work will include the milling of both concrete and hot-mix asphalt. Grinding at the bridge approach should be 2½ inches deep. The Bridge Engineer says there should not be any reinforcement in this depth. If however, reinforcement bars are encountered before the proposed depth is obtained, the depth to the top of the re-bar shall be used.

Also included in this work will be the removal of expansion joints. The joints will not have to be constructed in the surfacing operations.

This work shall be measured and paid for at the contract unit price per SQ YD for COLD MILLING (SPECIAL).

MILLING RESTRICTIONS

Milling operations shall be performed such that a vertical milled face not greater than 1 ½ inches exists between open lanes of traffic. This can be accomplished by one of the following treatment methods; Make multiple passes with the mill, each one less the 1 ½ inches, place a temporary wedge or have milled sloped edge with a minimum 1:3 slope, or mill both lanes the same day so that no difference in elevation exists when the lanes are opened. Other methods may be used if approved by the Engineer prior to implementing the procedure.

This work shall be included in the cost of COLD MILLING (SPECIAL).

APPROVAL OF PROPOSED BORROW AREAS, USE AREAS, AND/OR WASTE AREAS (BDE)

Effective: November 1, 2008

Revised: November 1, 2010

Replace the first paragraph of Article 107.22 of the Standard Specifications with the following:

“All proposed borrow areas, including commercial borrow areas; use areas, including, but not limited to temporary access roads, detours, runarounds, plant sites, and staging and storage areas; and/or waste areas are to be designated by the Contractor to the Engineer and approved prior to their use. Such areas outside the State of Illinois shall be evaluated, at no additional cost to the Department, according to the requirements of the state in which the area lies; and approval by the authority within that state having jurisdiction for such areas shall be forwarded to the Engineer. Such areas within Illinois shall be evaluated as described herein.

A location map delineating the proposed borrow area, use area, and/or waste area shall be submitted to the Engineer for approval along with an agreement from the property owner granting the Department permission to enter the property and conduct cultural and biological resource reconnaissance surveys of the site for archaeological resources, threatened or endangered species or their designated essential habitat, wetlands, prairies, and savannahs. The type of location map submitted shall be a topographic map, a plat map, or a 7.5 minute quadrangle map. Submittals shall include the intended use of the site and provide sufficient detail for the Engineer to determine the extent of impacts to the site. The Engineer will initiate cultural and biological resource reconnaissance surveys of the site, as necessary, at no cost to the Contractor. The Engineer will advise the Contractor of the expected time required to complete all surveys. If the proposed area is within 150 ft (45 m) of the highway right-of-way, a topographic map of the proposed site will be required as specified in Article 204.02.”

CEMENT (BDE)

Effective: January 1, 2007

Revised: April 1, 2011

Revise Section 1001 of the Standard Specifications to read:

“SECTION 1001. CEMENT

1001.01 Cement Types. Cement shall be according to the following.

- (a) Portland Cement. Acceptance of portland cement shall be according to the current Bureau of Materials and Physical Research’s Policy Memorandum, “Portland or Blended Cement Acceptance Procedure for Qualified and Non-Qualified Plants”.

Portland cement shall be according to AASHTO M 85, and shall meet the standard physical and chemical requirements. The Contractor has the option to use any type of portland cement listed in AASHTO M 85 unless a specific cement is specified for a construction item. Inorganic processing additions shall be limited to granulated blast-furnace slag according to the chemical requirements of AASHTO M 302, Class C or F fly ash according to the chemical requirements of AASHTO M 295, and cement kiln dust.

- (b) Portland-Pozzolan Cement. Acceptance of portland-pozzolan cement shall be according to the current Bureau of Materials and Physical Research’s Policy Memorandum, “Portland or Blended Cement Acceptance Procedure for Qualified and Non-Qualified Plants”.

Portland-pozzolan cement shall be according to AASHTO M 240 and shall meet the standard physical and chemical requirements. The Contractor has the option to use portland-pozzolan cement unless a specific cement is specified for a construction item. Inorganic processing additions shall be limited to granulated blast-furnace slag according to the chemical requirements of AASHTO M 302, Class C or F fly ash according to the chemical requirements of AASHTO M 295, and cement kiln dust. The pozzolan constituent for Type IP using Class F fly ash shall be a maximum of 25 percent of the weight (mass) of the portland-pozzolan cement. The pozzolan constituent for Type IP using Class C fly ash shall be a maximum of 30 percent of the weight (mass) of the portland-pozzolan cement. The pozzolan constituent for Type IP using microsilica or high-reactivity metakaolin shall be a maximum of ten percent. The pozzolan constituent for Type IP using other materials shall have the approval of the Engineer.

Portland-pozzolan cement may be used in concrete mixtures when the air temperature is below 40 °F (4 °C), but the Engineer may request a trial batch of the concrete mixture to show the mix design strength requirement will be met.

- (c) Portland Blast-Furnace Slag Cement. Acceptance of portland blast-furnace slag cement shall be according to the current Bureau of Materials and Physical Research's Policy Memorandum, "Portland or Blended Cement Acceptance Procedure for Qualified and Non-Qualified Plants".

Portland blast-furnace slag cement shall be according to AASHTO M 240 and shall meet the standard physical and chemical requirements. The Contractor has the option to use portland blast-furnace slag cement unless a specific cement is specified for a construction item. Inorganic processing additions shall be limited to granulated blast-furnace slag according to the chemical requirements of AASHTO M 302, Class C or F fly ash according to the chemical requirements of AASHTO M 295, and cement kiln dust. The blast-furnace slag constituent for Type IS shall be a maximum of 35 percent of the weight (mass) of the portland blast-furnace slag cement.

Portland blast-furnace slag cement may be used in concrete mixtures when the air temperature is below 40 °F (4 °C), but the Engineer may request a trial batch of the concrete mixture to show the mix design strength requirement will be met.

- (d) Rapid Hardening Cement. Rapid hardening cement shall be used according to Article 1020.04 or when approved by the Engineer. The cement shall be on the Department's current "Approved List of Packaged, Dry, Rapid Hardening Cementitious Materials for Concrete Repairs", and shall be according to the following.
- (1) The cement shall have a maximum final set of 25 minutes, according to Illinois Modified AASHTO T 131.
 - (2) The cement shall have a minimum compressive strength of 2000 psi (13,800 kPa) at 3.0 hours, 3200 psi (22,100 kPa) at 6.0 hours, and 4000 psi (27,600 kPa) at 24.0 hours, according to Illinois Modified AASHTO T 106.
 - (3) The cement shall have a maximum drying shrinkage of 0.050 percent at seven days, according to Illinois Modified ASTM C 596.
 - (4) The cement shall have a maximum expansion of 0.020 percent at 14 days, according to Illinois Modified ASTM C 1038.

(5) The cement shall have a minimum 80 percent relative dynamic modulus of elasticity; and shall not have a weight (mass) gain in excess of 0.15 percent or a weight (mass) loss in excess of 1.0 percent, after 100 cycles, according to Illinois Modified AASHTO T 161, Procedure B.

(e) Calcium Aluminate Cement. Calcium aluminate cement shall be used according to Article 1020.04 or when approved by the Engineer. The cement shall meet the standard physical requirements for Type I cement according to AASHTO M 85, except the time of setting shall not apply. The chemical requirements shall be determined according to AASHTO T 105 and shall be as follows: minimum 38 percent aluminum oxide (Al_2O_3), maximum 42 percent calcium oxide (CaO), maximum 1 percent magnesium oxide (MgO), maximum 0.4 percent sulfur trioxide (SO_3), maximum 1 percent loss on ignition, and maximum 3.5 percent insoluble residue.

1001.02 Uniformity of Color. Cement contained in single loads or in shipments of several loads to the same project shall not have visible differences in color.

1001.03 Mixing Brands and Types. Different brands or different types of cement from the same manufacturing plant, or the same brand or type from different plants shall not be mixed or used alternately in the same item of construction unless approved by the Engineer.

1001.04 Storage. Cement shall be stored and protected against damage, such as dampness which may cause partial set or hardened lumps. Different brands or different types of cement from the same manufacturing plant, or the same brand or type from different plants shall be kept separate.”

CONCRETE ADMIXTURES (BDE)

Effective: January 1, 2003

Revised: April 1, 2009

Replace the first paragraph of Article 1020.05(b) of the Standard Specifications to read:

“(b) Admixtures. The use of admixtures to increase the workability or to accelerate the hardening of the concrete will be permitted when approved by the Engineer. Admixture dosages shall result in the mixture meeting the specified plastic and hardened properties. The Department will maintain an Approved List of Corrosion Inhibitors. Corrosion inhibitor dosage rates shall be according to Article 1020.05(b)(12). The Department will also maintain an Approved List of Concrete Admixtures, and an admixture technical representative shall be consulted when determining an admixture dosage from this list. The dosage shall be within the range indicated on the approved list unless the influence by other admixtures, jobsite conditions (such as a very short haul time), or other circumstances warrant a dosage outside the range. The Engineer shall be notified when a dosage is proposed outside the range. To determine an admixture dosage, air temperature, concrete temperature, cement source and quantity, finely divided mineral sources(s) and quantity, influence of other admixtures, haul time, placement conditions, and other factors as appropriate shall be considered. The Engineer may request the Contractor to have a batch of concrete mixed in the lab or field to verify the admixture dosage is correct. An admixture dosage or combination of admixture dosages shall not delay the initial set of concrete by more than one hour. When a retarding admixture is required or appropriate for a bridge deck or bridge deck overlay pour, the initial set time shall be delayed until the deflections due to the concrete dead load are no longer a concern for inducing cracks in the completed work.

However, a retarding admixture shall not be used to further extend the pour time and justify the alteration of a bridge deck pour sequence.

When determining water in admixtures for water/cement ratio, the Contractor shall calculate 70 percent of the admixture dosage as water, except a value of 50 percent shall be used for a latex admixture used in bridge deck latex concrete overlays.”

Revise Section 1021 of the Standard Specifications to read:

“SECTION 1021. CONCRETE ADMIXTURES

1021.01 General. Admixtures shall be furnished in liquid form ready for use. The admixtures shall be delivered in the manufacturer's original containers, bulk tank trucks or such containers or tanks as are acceptable to the Engineer. Delivery shall be accompanied by a ticket which clearly identifies the manufacturer and trade name of the material. Containers shall be readily identifiable as to manufacturer and trade name of the material they contain.

Corrosion inhibitors will be maintained on the Department's Approved List of Corrosion Inhibitors. All other concrete admixture products will be maintained on the Department's Approved List of Concrete Admixtures. For the admixture submittal, a report prepared by an independent laboratory accredited by the AASHTO Materials Reference Laboratory (AMRL) for Portland Cement Concrete shall be provided. The report shall show the results of physical tests conducted no more than five years prior to the time of submittal, according to applicable specifications. However, for corrosion inhibitors the ASTM G 109 test information specified in ASTM C 1582 is not required to be from an independent lab. All other information in ASTM C 1582 shall be from an independent lab.

Tests shall be conducted using materials and methods specified on a "test" concrete and a "reference" concrete, together with a certification that no changes have been made in the formulation of the material since the performance of the tests. Per the manufacturer's option, the cement content for all required tests shall either be according to applicable specifications or 5.65 cwt/cu yd (335 kg/cu m). Compressive strength test results for six months and one year will not be required.

Prior to the approval of an admixture, the Engineer reserves the right to request a sample for testing. The test and reference concrete mixtures tested by the Engineer will contain a cement content of 5.65 cwt/cu yd (335 kg/cu m). For freeze-thaw testing, the Department will perform the test according to AASHTO T 161, Procedure B. The flexural strength test will be performed according to AASHTO T 177. If the Engineer decides to test the admixture, the manufacturer shall submit AASHTO T 197 water content and set time test results on the standard cement used by the Department. The test and reference concrete mixture shall contain a cement content of 5.65 cwt/cu yd (335 kg/cu m). The manufacturer may select their lab or an independent lab to perform this testing. The laboratory is not required to be accredited by AASHTO.

The manufacturer shall include in the submittal the following admixture information: the manufacturing range for specific gravity, the midpoint and manufacturing range for residue by oven drying, and the manufacturing range for pH. The submittal shall also include an infrared spectrophotometer trace no more than five years old.

For air-entraining admixtures according to Article 1021.02, the specific gravity allowable manufacturing range shall be established by the manufacturer and the test method shall be according to ASTM C 494. For residue by oven drying and pH, the allowable manufacturing range and test methods shall be according to ASTM C 260.

For admixtures according to Articles 1021.03, 1021.04, 1021.05, 1021.06, and 1021.07, the pH allowable manufacturing range shall be established by the manufacturer and the test method shall be according to ASTM E 70. For specific gravity and residue by oven drying, the allowable manufacturing range and test methods shall be according to ASTM C 494.

When test results are more than seven years old, the manufacturer shall re-submit the infrared spectrophotometer trace and the report prepared by an independent laboratory accredited by AASHTO.

All admixtures, except chloride-based accelerators, shall contain a maximum of 0.3 percent chloride by weight (mass).

Random field samples may be taken by the Department to verify an admixture meets specification. A split sample will be provided to the manufacturer if requested. Admixtures that do not meet specification requirements or an allowable manufacturing range established by the manufacturer shall be replaced with new material.

1021.02 Air-Entraining Admixtures. Air-entraining admixtures shall be according to AASHTO M 154.

1021.03 Retarding and Water-Reducing Admixtures. The admixture shall be according to the following.

- (a) The retarding admixture shall be according to AASHTO M 194, Type B (retarding) or Type D (water-reducing and retarding).
- (b) The water-reducing admixture shall be according to AASHTO M 194, Type A.
- (c) The high range water-reducing admixture shall be according to AASHTO M 194, Type F (high range water-reducing) or Type G (high range water-reducing and retarding).

1021.04 Accelerating Admixtures. The admixture shall be according to AASHTO M 194, Type C (accelerating) or Type E (water reducing and accelerating).

1021.05 Self-Consolidating Admixtures. The self-consolidating admixture system shall consist of either a high range water-reducing admixture only or a high range water-reducing admixture combined with a separate viscosity modifying admixture. The one or two component admixture system shall be capable of producing a concrete mixture that can flow around reinforcement and consolidate under its own weight without additional effort and without segregation.

The high range water-reducing admixture shall be according to AASHTO M 194, Type F.

The viscosity modifying admixture shall be according to ASTM C 494, Type S (specific performance).

1021.06 Rheology-Controlling Admixture. The rheology-controlling admixture shall be capable of producing a concrete mixture with a lower yield stress that will consolidate easier for slipform applications used by the Contractor. The rheology-controlling admixture shall be according to ASTM C 494, Type S (specific performance).

1021.07 Corrosion Inhibitor. The corrosion inhibitor shall be according to one of the following.

(a) Calcium Nitrite. The corrosion inhibitor shall contain a minimum 30 percent calcium nitrite by weight (mass) of solution, and shall comply with the requirements of AASHTO M 194, Type C (accelerating).

(b) Other Materials. The corrosion inhibitor shall be according to ASTM C 1582.”

CONSTRUCTION AIR QUALITY - DIESEL VEHICLE EMISSIONS CONTROL (BDE)

Effective: April 1, 2009

Revised: July 1, 2009

Diesel Vehicle Emissions Control. The reduction of construction air emissions shall be accomplished by using cleaner burning diesel fuel. The term “equipment” refers to any and all diesel fuel powered devices rated at 50 hp and above, to be used on the project site in excess of seven calendar days over the course of the construction period on the project site (including any “rental” equipment).

All equipment on the jobsite, with engine ratings of 50 hp and above, shall be required to: use Ultra Low Sulfur Diesel fuel (ULSD) exclusively (15 ppm sulfur content or less).

Diesel powered equipment in non-compliance will not be allowed to be used on the project site, and is also subject to a notice of non-compliance as outlined below.

The Contractor shall submit copies of monthly summary reports and include certified copies of the ULSD diesel fuel delivery slips for diesel fuel delivered to the jobsite for the reporting time period, noting the quantity of diesel fuel used.

If any diesel powered equipment is found to be in non-compliance with any portion of this specification, the Engineer will issue the Contractor a notice of non-compliance and identify an appropriate period of time, as outlined below under environmental deficiency deduction, in which to bring the equipment into compliance or remove it from the project site.

Any costs associated with bringing any diesel powered equipment into compliance with these diesel vehicle emissions controls shall be considered as included in the contract unit prices bid for the various items of work involved and no additional compensation will be allowed. The Contractor's compliance with this notice and any associated regulations shall also not be grounds for a claim.

Environmental Deficiency Deduction. When the Engineer is notified, or determines that an environmental control deficiency exists, he/she will notify the Contractor in writing, and direct the Contractor to correct the deficiency within a specified time period. The specified time-period, which begins upon Contractor notification, will be from 1/2 hour to 24 hours long, based on the urgency of the situation and the nature of the deficiency. The Engineer shall be the sole judge regarding the time period.

The deficiency will be based on lack of repair, maintenance and diesel vehicle emissions control.

If the Contractor fails to correct the deficiency within the specified time frame, a daily monetary deduction will be imposed for each calendar day or fraction thereof the deficiency continues to exist. The calendar day(s) will begin when the time period for correction is exceeded and end with the Engineer's written acceptance of the correction. The daily monetary deduction will be \$1,000.00 for each deficiency identified.

If a Contractor or subcontractor accumulates three environmental deficiency deductions in a contract period, the Contractor will be shutdown until the deficiency is corrected. Such a shutdown will not be grounds for any extension of contract time, waiver of penalties, or be grounds for any claim.

CONSTRUCTION AIR QUALITY - IDLING RESTRICTIONS (BDE)

Effective: April 1, 2009

Idling Restrictions. The Contractor shall establish truck-staging areas for all diesel powered vehicles that are waiting to load or unload material at the jobsite. Staging areas shall be located where the diesel emissions from the equipment will have a minimum impact on adjacent sensitive receptors. The Department will review the selection of staging areas, whether within or outside the existing highway right-of-way, to avoid locations near sensitive areas or populations to the extent possible. Sensitive receptors include, but are not limited to, hospitals, schools, residences, motels, hotels, daycare facilities, elderly housing and convalescent facilities. Diesel powered engines shall also be located as far away as possible from fresh air intakes, air conditioners, and windows. The Engineer will approve staging areas before implementation.

Diesel powered vehicle operators may not cause or allow the motor vehicle, when it is not in motion, to idle for more than a total of 10 minutes within any 60 minute period, except under any of the following circumstances:

- 1) The motor vehicle has a gross vehicle weight rating of less than 8000 lb (3630 kg).
- 2) The motor vehicle idles while forced to remain motionless because of on-highway traffic, an official traffic control device or signal, or at the direction of a law enforcement official.
- 3) The motor vehicle idles when operating defrosters, heaters, air conditioners, or other equipment solely to prevent a safety or health emergency.
- 4) A police, fire, ambulance, public safety, other emergency or law enforcement motor vehicle, or any motor vehicle used in an emergency capacity, idles while in an emergency or training mode and not for the convenience of the vehicle operator.
- 5) The primary propulsion engine idles for maintenance, servicing, repairing, or diagnostic purposes if idling is necessary for such activity.
- 6) A motor vehicle idles as part of a government inspection to verify that all equipment is in good working order, provided idling is required as part of the inspection.
- 7) When idling of the motor vehicle is required to operate auxiliary equipment to accomplish the intended use of the vehicle (such as loading, unloading, mixing, or processing cargo; controlling cargo temperature; construction operations, lumbering operations; oil or gas well servicing; or farming operations), provided that this exemption does not apply when the vehicle is idling solely for cabin comfort or to operate non-essential equipment such as air conditioning, heating, microwave ovens, or televisions.

- 8) When the motor vehicle idles due to mechanical difficulties over which the operator has no control.
- 9) The outdoor temperature is less than 32 °F (0 °C) or greater than 80 °F (26 °C).

When the outdoor temperature is greater than or equal to 32 °F (0 °C) or less than or equal to 80 °F (26 °C), a person who operates a motor vehicle operating on diesel fuel shall not cause or allow the motor vehicle to idle for a period greater than 30 minutes in any 60 minute period while waiting to weigh, load, or unload cargo or freight, unless the vehicle is in a line of vehicles that regularly and periodically moves forward.

The above requirements do not prohibit the operation of an auxiliary power unit or generator set as an alternative to idling the main engine of a motor vehicle operating on diesel fuel.

Environmental Deficiency Deduction. When the Engineer is notified, or determines that an environmental control deficiency exists based on non-compliance with the idling restrictions, he/she will notify the Contractor, and direct the Contractor to correct the deficiency.

If the Contractor fails to correct the deficiency a monetary deduction will be imposed. The monetary deduction will be \$1,000.00 for each deficiency identified.

DISADVANTAGED BUSINESS ENTERPRISE PARTICIPATION (BDE)

Effective: September 1, 2000

Revised: January 1, 2011

FEDERAL OBLIGATION. The Department of Transportation, as a recipient of federal financial assistance, is required to take all necessary and reasonable steps to ensure nondiscrimination in the award and administration of contracts. Consequently, the federal regulatory provisions of 49 CFR part 26 apply to this contract concerning the utilization of disadvantaged business enterprises. For the purposes of this Special Provision, a disadvantaged business enterprise (DBE) means a business certified by the Department in accordance with the requirements of 49 CFR part 26 and listed in the Illinois Unified Certification Program (IL UCP) DBE Directory.

STATE OBLIGATION. This Special Provision will also be used by the Department to satisfy the requirements of the Business Enterprise for Minorities, Females, and Persons with Disabilities Act, 30 ILCS 575. When this Special Provision is used to satisfy state law requirements on 100 percent state-funded contracts, the federal government has no involvement in such contracts (not a federal-aid contract) and no responsibility to oversee the implementation of this Special Provision by the Department on those contracts. DBE participation on 100 percent state-funded contracts will not be credited toward fulfilling the Department's annual overall DBE goal required by the US Department of Transportation to comply with the federal DBE program requirements.

CONTRACTOR ASSURANCE. The Contractor makes the following assurance and agrees to include the assurance in each subcontract that the Contractor signs with a subcontractor:

The Contractor, subrecipient, or subcontractor shall not discriminate on the basis of race, color, national origin, or sex in the performance of this contract. The Contractor shall carry out applicable requirements of 49 CFR part 26 in the award and administration of contracts funded in whole or in part with federal or state funds. Failure by the Contractor to carry out these requirements is a material breach of this contract, which may result in the termination of this contract or such other remedy as the recipient deems appropriate.

OVERALL GOAL SET FOR THE DEPARTMENT. As a requirement of compliance with 49 CFR part 26, the Department has set an overall goal for DBE participation in its federally assisted contracts. That goal applies to all federal-aid funds the Department will expend in its federally assisted contracts for the subject reporting fiscal year. The Department is required to make a good faith effort to achieve the overall goal. The dollar amount paid to all approved DBE companies performing work called for in this contract is eligible to be credited toward fulfillment of the Department's overall goal.

CONTRACT GOAL TO BE ACHIEVED BY THE CONTRACTOR. This contract includes a specific DBE utilization goal established by the Department. The goal has been included because the Department has determined that the work of this contract has subcontracting opportunities that may be suitable for performance by DBE companies. This determination is based on an assessment of the type of work, the location of the work, and the availability of DBE companies to do a part of the work. The assessment indicates that, in the absence of unlawful discrimination, and in an arena of fair and open competition, DBE companies can be expected to perform **0.00%** of the work. This percentage is set as the DBE participation goal for this contract. Consequently, in addition to the other award criteria established for this contract, the Department will only award this contract to a bidder who makes a good faith effort to meet this goal of DBE participation in the performance of the work. A bidder makes a good faith effort for award consideration if either of the following is done in accordance with the procedures set forth in this Special Provision:

- (a) The bidder documents that enough DBE participation has been obtained to meet the goal; or
- (b) The bidder documents that a good faith effort has been made to meet the goal, even though the effort did not succeed in obtaining enough DBE participation to meet the goal.

DBE LOCATOR REFERENCES. Bidders may consult the IL UCP DBE Directory as a reference source for DBE-certified companies. In addition, the Department maintains a letting and item specific DBE locator information system whereby DBE companies can register their interest in providing quotes on particular bid items advertised for letting. Information concerning DBE companies willing to quote work for particular contracts may be obtained by contacting the Department's Bureau of Small Business Enterprises at telephone number (217)785-4611, or by visiting the Department's web site at www.dot.il.gov.

BIDDING PROCEDURES. Compliance with this Special Provision is a material bidding requirement. The failure of the bidder to comply will render the bid not responsive.

- (a) The bidder shall submit a Disadvantaged Business Utilization Plan on Department forms SBE 2025 and 2026 with the bid.
- (b) The Utilization Plan shall indicate that the bidder either has obtained sufficient DBE participation commitments to meet the contract goal or has not obtained enough DBE participation commitments in spite of a good faith effort to meet the goal. The Utilization Plan shall further provide the name, telephone number, and telefax number of a responsible official of the bidder designated for purposes of notification of plan approval or disapproval under the procedures of this Special Provision.

- (c) The Utilization Plan shall include a DBE Participation Commitment Statement, Department form SBE 2025, for each DBE proposed for the performance of work to achieve the contract goal. For bidding purposes, submission of the completed SBE 2025 forms, signed by the DBEs and faxed to the bidder will be acceptable as long as the original is available and provided upon request. All elements of information indicated on the said form shall be provided, including but not limited to the following:
- (1) The names and addresses of DBE firms that will participate in the contract;
 - (2) A description, including pay item numbers, of the work each DBE will perform;
 - (3) The dollar amount of the participation of each DBE firm participating. The dollar amount of participation for identified work shall specifically state the quantity, unit price, and total subcontract price for the work to be completed by the DBE. If partial pay items are to be performed by the DBE, indicate the portion of each item, a unit price where appropriate and the subcontract price amount;
 - (4) DBE Participation Commitment Statements, form SBE 2025, signed by the bidder and each participating DBE firm documenting the commitment to use the DBE subcontractors whose participation is submitted to meet the contract goal;
 - (5) If the bidder is a joint venture comprised of DBE companies and non-DBE companies, the plan must also include a clear identification of the portion of the work to be performed by the DBE partner(s); and,
 - (6) If the contract goal is not met, evidence of good faith efforts.

GOOD FAITH EFFORT PROCEDURES. The contract will not be awarded until the Utilization Plan submitted by the apparent successful bidder is approved. All information submitted by the bidder must be complete, accurate and adequately document that enough DBE participation has been obtained or document the good faith efforts of the bidder, in the event enough DBE participation has not been obtained, before the Department will commit to the performance of the contract by the bidder. The Utilization Plan will be approved by the Department if the Utilization Plan documents sufficient commercially useful DBE work performance to meet the contract goal or the bidder submits sufficient documentation of a good faith effort to meet the contract goal pursuant to 49 CFR part 26, Appendix A. The Utilization Plan will not be approved by the Department if the Utilization Plan does not document sufficient DBE participation to meet the contract goal unless the apparent successful bidder documented in the Utilization Plan that it made a good faith effort to meet the goal. This means that the bidder must show that all necessary and reasonable steps were taken to achieve the contract goal. Necessary and reasonable steps are those which, by their scope, intensity and appropriateness to the objective, could reasonably be expected to obtain sufficient DBE participation, even if they were not successful. The Department will consider the quality, quantity, and intensity of the kinds of efforts that the bidder has made. Mere *pro forma* efforts, in other words, efforts done as a matter of form, are not good faith efforts; rather, the bidder is expected to have taken genuine efforts that would be reasonably expected of a bidder actively and aggressively trying to obtain DBE participation sufficient to meet the contract goal.

- (a) The following is a list of types of action that the Department will consider as part of the evaluation of the bidder's good faith efforts to obtain participation. These listed factors are not intended to be a mandatory checklist and are not intended to be exhaustive. Other factors or efforts brought to the attention of the Department may be relevant in appropriate cases, and will be considered by the Department.

- (1) Soliciting through all reasonable and available means (e.g. attendance at pre-bid meetings, advertising and/or written notices) the interest of all certified DBE companies that have the capability to perform the work of the contract. The bidder must solicit this interest within sufficient time to allow the DBE companies to respond to the solicitation. The bidder must determine with certainty if the DBE companies are interested by taking appropriate steps to follow up initial solicitations.
- (2) Selecting portions of the work to be performed by DBE companies in order to increase the likelihood that the DBE goals will be achieved. This includes, where appropriate, breaking out contract work items into economically feasible units to facilitate DBE participation, even when the prime Contractor might otherwise prefer to perform these work items with its own forces.
- (3) Providing interested DBE companies with adequate information about the plans, specifications, and requirements of the contract in a timely manner to assist them in responding to a solicitation.
- (4) a. Negotiating in good faith with interested DBE companies. It is the bidder's responsibility to make a portion of the work available to DBE subcontractors and suppliers and to select those portions of the work or material needs consistent with the available DBE subcontractors and suppliers, so as to facilitate DBE participation. Evidence of such negotiation includes the names, addresses, and telephone numbers of DBE companies that were considered; a description of the information provided regarding the plans and specifications for the work selected for subcontracting; and evidence as to why additional agreements could not be reached for DBE companies to perform the work.

b. A bidder using good business judgment would consider a number of factors in negotiating with subcontractors, including DBE subcontractors, and would take a firm's price and capabilities as well as contract goals into consideration. However, the fact that there may be some additional costs involved in finding and using DBE companies is not in itself sufficient reason for a bidder's failure to meet the contract DBE goal, as long as such costs are reasonable. Also, the ability or desire of a bidder to perform the work of a contract with its own organization does not relieve the bidder of the responsibility to make good faith efforts. Bidders are not, however, required to accept higher quotes from DBE companies if the price difference is excessive or unreasonable.
- (5) Not rejecting DBE companies as being unqualified without sound reasons based on a thorough investigation of their capabilities. The bidder's standing within its industry, membership in specific groups, organizations, or associations and political or social affiliations (for example union vs. non-union employee status) are not legitimate causes for the rejection or non-solicitation of bids in the bidder's efforts to meet the project goal.
- (6) Making efforts to assist interested DBE companies in obtaining bonding, lines of credit, or insurance as required by the recipient or Contractor.
- (7) Making efforts to assist interested DBE companies in obtaining necessary equipment, supplies, materials, or related assistance or services.

- (8) Effectively using the services of available minority/women community organizations; minority/women contractors' groups; local, state, and federal minority/women business assistance offices; and other organizations as allowed on a case-by-case basis to provide assistance in the recruitment and placement of DBE companies.
- (b) If the Department determines that the apparent successful bidder has made a good faith effort to secure the work commitment of DBE companies to meet the contract goal, the Department will award the contract provided that it is otherwise eligible for award. If the Department determines that the bidder has failed to meet the requirements of this Special Provision or that a good faith effort has not been made, the Department will notify the responsible company official designated in the Utilization Plan that the bid is not responsive. The notification shall include a statement of reasons for the determination.
- (c) The bidder may request administrative reconsideration of a determination adverse to the bidder within the five working days after receipt of the notification date of the determination by delivering the request to the Department of Transportation, Bureau of Small Business Enterprises, Contract Compliance Section, 2300 South Dirksen Parkway, Room 319, Springfield, Illinois 62764 (Telefax: (217)785-1524). Deposit of the request in the United States mail on or before the fifth business day shall not be deemed delivery. The determination shall become final if a request is not made and delivered. A request may provide additional written documentation and/or argument concerning the issues raised in the determination statement of reasons, provided the documentation and arguments address efforts made prior to submitting the bid. The request will be forwarded to the Department's Reconsideration Officer. The Reconsideration Officer will extend an opportunity to the bidder to meet in person in order to consider all issues of documentation and whether the bidder made a good faith effort to meet the goal. After the review by the Reconsideration Officer, the bidder will be sent a written decision within ten working days after receipt of the request for reconsideration, explaining the basis for finding that the bidder did or did not meet the goal or make adequate good faith efforts to do so. A final decision by the Reconsideration Officer that a good faith effort was made shall approve the Utilization Plan submitted by the bidder and shall clear the contract for award. A final decision that a good faith effort was not made shall render the bid not responsive.

CALCULATING DBE PARTICIPATION. The Utilization Plan values represent work anticipated to be performed and paid for upon satisfactory completion. The Department is only able to count toward the achievement of the overall goal and the contract goal the value of payments made for the work actually performed by DBE companies. In addition, a DBE must perform a commercially useful function on the contract to be counted. A commercially useful function is generally performed when the DBE is responsible for the work and is carrying out its responsibilities by actually performing, managing, and supervising the work involved. The Department and Contractor are governed by the provisions of 49 CFR part 26.55(c) on questions of commercially useful functions as it affects the work. Specific counting guidelines are provided in 49 CFR part 26.55, the provisions of which govern over the summary contained herein.

- (a) DBE as the Contractor: 100 percent goal credit for that portion of the work performed by the DBE's own forces, including the cost of materials and supplies. Work that a DBE subcontracts to a non-DBE does not count toward the DBE goals.

- (b) DBE as a joint venture Contractor: 100 percent goal credit for that portion of the total dollar value of the contract equal to the distinct, clearly defined portion of the work performed by the DBE's own forces.
- (c) DBE as a subcontractor: 100 percent goal credit for the work of the subcontract performed by the DBE's own forces, including the cost of materials and supplies, excluding the purchase of materials and supplies or the lease of equipment by the DBE subcontractor from the prime Contractor or its affiliates. Work that a DBE subcontractor in turn subcontracts to a non-DBE does not count toward the DBE goal.
- (d) DBE as a trucker: 100 percent goal credit for trucking participation provided the DBE is responsible for the management and supervision of the entire trucking operation for which it is responsible. At least one truck owned, operated, licensed, and insured by the DBE must be used on the contract. Credit will be given for the following:
 - (1) The DBE may lease trucks from another DBE firm, including an owner-operator who is certified as a DBE. The DBE who leases trucks from another DBE receives credit for the total value of the transportation services the lessee DBE provides on the contract.
 - (2) The DBE may also lease trucks from a non-DBE firm, including from an owner-operator. The DBE who leases trucks from a non-DBE is entitled to credit only for the fee or commission it receives as a result of the lease arrangement.
- (e) DBE as a material supplier:
 - (1) 60 percent goal credit for the cost of the materials or supplies purchased from a DBE regular dealer.
 - (2) 100 percent goal credit for the cost of materials or supplies obtained from a DBE manufacturer.
 - (3) 100 percent credit for the value of reasonable fees and commissions for the procurement of materials and supplies if not a regular dealer or manufacturer.

CONTRACT COMPLIANCE. Compliance with this Special Provision is an essential part of the contract. The Department is prohibited by federal regulations from crediting the participation of a DBE included in the Utilization Plan toward either the contract goal or the Department's overall goal until the amount to be applied toward the goals has been paid to the DBE. The following administrative procedures and remedies govern the compliance by the Contractor with the contractual obligations established by the Utilization Plan. After approval of the Utilization Plan and award of the contract, the Utilization Plan and individual DBE Participation Statements become part of the contract. If the Contractor did not succeed in obtaining enough DBE participation to achieve the advertised contract goal, and the Utilization Plan was approved and contract awarded based upon a determination of good faith, the total dollar value of DBE work calculated in the approved Utilization Plan as a percentage of the awarded contract value shall become the amended contract goal.

- (a) No amendment to the Utilization Plan may be made without prior written approval from the Department's Bureau of Small Business Enterprises. All requests for amendment to the Utilization Plan shall be submitted to the Department of Transportation, Bureau of Small Business Enterprises, Contract Compliance Section, 2300 South Dirksen Parkway, Room 319, Springfield, Illinois 62764. Telephone number (217) 785-4611. Telefax number (217) 785-1524.

- (b) The Contractor must notify and obtain written approval from the Department's Bureau of Small Business Enterprises prior to replacing a DBE or making any change in the participation of a DBE. Approval for replacement will be granted only if it is demonstrated that the DBE is unable or unwilling to perform. The Contractor must make every good faith effort to find another certified DBE subcontractor to substitute for the original DBE. The good faith efforts shall be directed at finding another DBE to perform at least the same amount of work under the contract as the original DBE, to the extent needed to meet the contract goal.
- (c) Any deviation from the DBE condition-of-award or contract specifications must be approved, in writing, by the Department. The Contractor shall notify affected DBEs in writing of any changes in the scope of work which result in a reduction in the dollar amount condition-of-award to the contract.
- (d) In addition to the above requirements for reductions in the condition of award, additional requirements apply to the two cases of Contractor-initiated work substitution proposals. Where the contract allows alternate work methods which serve to delete or create underruns in condition of award DBE work, and the Contractor selects that alternate method or, where the Contractor proposes a substitute work method or material that serves to diminish or delete work committed to a DBE and replace it with other work, then the Contractor must demonstrate one of the following:
 - (1) That the replacement work will be performed by the same DBE (as long as the DBE is certified in the respective item of work) in a modification of the condition of award; or
 - (2) That the DBE is aware that its work will be deleted or will experience underruns and has agreed in writing to the change. If this occurs, the Contractor shall substitute other work of equivalent value to a certified DBE or provide documentation of good faith efforts to do so; or
 - (3) That the DBE is not capable of performing the replacement work or has declined to perform the work at a reasonably competitive price. If this occurs, the Contractor shall substitute other work of equivalent value to a certified DBE or provide documentation of good faith efforts to do so.
- (e) Where the revision includes work committed to a new DBE subcontractor, not previously involved in the project, then a Request for Approval of Subcontractor, Department form BC 260A, must be signed and submitted.
- (f) If the commitment of work is in the form of additional tasks assigned to an existing subcontract, then a new Request for Approval of Subcontractor shall not be required. However, the Contractor must document efforts to assure that the existing DBE subcontractor is capable of performing the additional work and has agreed in writing to the change.
- (g) All work indicated for performance by an approved DBE shall be performed, managed, and supervised by the DBE executing the Participation Statement. The Contractor shall not terminate for convenience a DBE listed in the Utilization Plan and then perform the work of the terminated DBE with its own forces, those of an affiliate or those of another subcontractor, whether DBE or not, without first obtaining the written consent of the Bureau of Small Business Enterprises to amend the Utilization Plan.

The Contractor shall notify the Bureau of Small Business Enterprises of any termination for reasons other than convenience, and shall obtain approval for inclusion of the substitute DBE in the Utilization Plan. If good faith efforts following a termination of a DBE for cause are not successful, the Contractor shall contact the Bureau of Small Business Enterprises and provide a full accounting of the efforts undertaken to obtain substitute DBE participation. The Bureau of Small Business Enterprises will evaluate the good faith efforts in light of all circumstances surrounding the performance status of the contract, and determine whether the contract goal should be amended.

- (h) The Contractor shall maintain a record of payments for work performed to the DBE participants. The records shall be made available to the Department for inspection upon request. After the performance of the final item of work or delivery of material by a DBE and final payment therefore to the DBE by the Contractor, but not later than thirty calendar days after payment has been made by the Department to the Contractor for such work or material, the Contractor shall submit a DBE Payment Agreement on Department form SBE 2115 to the Regional Engineer. If full and final payment has not been made to the DBE, the DBE Payment Agreement shall indicate whether a disagreement as to the payment required exists between the Contractor and the DBE or if the Contractor believes that the work has not been satisfactorily completed. If the Contractor does not have the full amount of work indicated in the Utilization Plan performed by the DBE companies indicated in the Utilization Plan and after good faith efforts are reviewed, the Department may deduct from contract payments to the Contractor the amount of the goal not achieved as liquidated and ascertained damages. The Contractor may request an administrative reconsideration of any amount deducted as damages pursuant to subsection (j) of this part.
- (i) The Department reserves the right to withhold payment to the Contractor to enforce the provisions of this Special Provision. Final payment shall not be made on the contract until such time as the Contractor submits sufficient documentation demonstrating achievement of the goal in accordance with this Special Provision or after liquidated damages have been determined and collected.
- (j) Notwithstanding any other provision of the contract, including but not limited to Article 109.09 of the Standard Specifications, the Contractor may request administrative reconsideration of a decision to deduct the amount of the goal not achieved as liquidated damages. A request to reconsider shall be delivered to the Contract Compliance Section and shall be handled and considered in the same manner as set forth in paragraph (c) of "Good Faith Effort Procedures" of this Special Provision, except a final decision that a good faith effort was not made during contract performance to achieve the goal agreed to in the Utilization Plan shall be the final administrative decision of the Department.

EQUIPMENT RENTAL RATES (BDE)

Effective: August 2, 2007

Revised: January 2, 2008

Replace the second and third paragraphs of Article 105.07(b)(4)a. of the Standard Specifications with the following:

"Equipment idled which cannot be used on other work, and which is authorized to standby on the project site by the Engineer, will be paid for according to Article 109.04(b)(4)."

Replace Article 109.04(b)(4) of the Standard Specifications with the following:

“(4) Equipment. Equipment used for extra work shall be authorized by the Engineer. The equipment shall be specifically described, be of suitable size and capacity for the work to be performed, and be in good operating condition. For such equipment, the Contractor will be paid as follows.

- a. Contractor Owned Equipment. Contractor owned equipment will be paid for by the hour using the applicable FHWA hourly rate from the “Equipment Watch Rental Rate Blue Book” (Blue Book) in effect when the force account work begins. The FHWA hourly rate is calculated as follows.

$$\text{FHWA hourly rate} = (\text{monthly rate}/176) \times (\text{model year adj.}) \times (\text{Illinois adj.}) + \text{EOC}$$

Where: EOC = Estimated Operating Costs per hour (from the Blue Book)

The time allowed will be the actual time the equipment is operating on the extra work. For the time required to move the equipment to and from the site of the extra work and any authorized idle (standby) time, payment will be made at the following hourly rate: 0.5 x (FHWA hourly rate - EOC).

All time allowed shall fall within the working hours authorized for the extra work.

The rates above include the cost of fuel, oil, lubrication, supplies, small tools, necessary attachments, repairs, overhaul and maintenance of any kind, depreciation, storage, overhead, profits, insurance, and all incidentals. The rates do not include labor.

The Contractor shall submit to the Engineer sufficient information for each piece of equipment and its attachments to enable the Engineer to determine the proper equipment category. If a rate is not established in the Blue Book for a particular piece of equipment, the Engineer will establish a rate for that piece of equipment that is consistent with its cost and use in the industry.

- b. Rented Equipment. Whenever it is necessary for the Contractor to rent equipment to perform extra work, the rental and transportation costs of the equipment plus five percent for overhead will be paid. In no case shall the rental rates exceed those of established distributors or equipment rental agencies.

All prices shall be agreed to in writing before the equipment is used.”

FRICTION AGGREGATE (BDE)

Effective: January 1, 2011

Revise Article 1004.01(a)(4) of the Standard Specifications to read:

“(4)Crushed Stone. Crushed stone shall be the angular fragments resulting from crushing undisturbed, consolidated deposits of rock by mechanical means. Crushed stone shall be divided into the following, when specified.

- a. Carbonate Crushed Stone. Carbonate crushed stone shall be either dolomite or limestone. Dolomite shall contain 11.0 percent or more magnesium oxide (MgO). Limestone shall contain less than 11.0 percent magnesium oxide (MgO).
- b. Crystalline Crushed Stone. Crystalline crushed stone shall be either metamorphic or igneous stone, including but is not limited to, quartzite, granite, rhyolite and diabase.”

Revise Article 1004.03(a) of the Standard Specifications to read:

“1004.03 Coarse Aggregate for Hot-Mix Asphalt (HMA). The aggregate shall be according to Article 1004.01 and the following.

(a) Description. The coarse aggregate for HMA shall be according to the following table.

Use	Mixture	Aggregates Allowed
Class A	Seal or Cover	<u>Allowed Alone or in Combination:</u> Gravel Crushed Gravel Carbonate Crushed Stone Crystalline Crushed Stone Crushed Sandstone Crushed Slag (ACBF) Crushed Steel Slag Crushed Concrete
HMA All Other	Stabilized Subbase or Shoulders	<u>Allowed Alone or in Combination:</u> Gravel Crushed Gravel Carbonate Crushed Stone Crystalline Crushed Stone Crushed Sandstone Crushed Slag (ACBF) Crushed Steel Slag ^{1/} Crushed Concrete
HMA High ESAL Low ESAL	Binder IL-25.0, IL-19.0, or IL-19.0L SMA Binder	<u>Allowed Alone or in Combination:</u> Crushed Gravel Carbonate Crushed Stone ^{2/} Crystalline Crushed Stone Crushed Sandstone Crushed Slag (ACBF) Crushed Concrete ^{3/}
HMA High ESAL Low ESAL	C Surface and Leveling Binder IL-12.5,IL-9.5, or IL-9.5L SMA Ndesign 50 Surface	<u>Allowed Alone or in Combination:</u> Crushed Gravel Carbonate Crushed Stone ^{2/} Crystalline Crushed Stone Crushed Sandstone Crushed Slag (ACBF) Crushed Steel Slag ^{4/} Crushed Concrete ^{3/}

Use	Mixture	Aggregates Allowed
HMA High ESAL	D Surface and Leveling Binder IL-12.5 or IL-9.5 SMA Ndesign 50 Surface	<u>Allowed Alone or in Combination:</u> Crushed Gravel Carbonate Crushed Stone (other than Limestone) ^{2/} Crystalline Crushed Stone Crushed Sandstone Crushed Slag (ACBF) ^{5/} Crushed Steel Slag ^{4/ 5/} Crushed Concrete ^{3/}
		<u>Other Combinations Allowed:</u> <i>Up to...</i> <i>With...</i>
		25% Limestone Dolomite
		50% Limestone Any Mixture D aggregate other than Dolomite
		75% Limestone Crushed Slag (ACBF) ^{5/} or Crushed Sandstone
HMA High ESAL	E Surface IL-12.5 or IL-9.5 SMA Ndesign 80 Surface	<u>Allowed Alone or in Combination:</u> Crushed Gravel Crystalline Crushed Stone Crushed Sandstone Crushed Slag (ACBF) ^{5/} Crushed Steel Slag ^{5/} Crushed Concrete ^{3/}
		No Limestone. <u>Other Combinations Allowed:</u> <i>Up to...</i> <i>With...</i>
		50% Dolomite ^{2/} Any Mixture E aggregate
		75% Dolomite ^{2/} Crushed Sandstone, Crushed Slag (ACBF) ^{5/} , Crushed Steel Slag ^{5/} , or Crystalline Crushed Stone
		75% Crushed Gravel or Crushed Concrete ^{3/} Crushed Sandstone, Crystalline Crushed Stone, Crushed Slag (ACBF) ^{5/} , or Crushed Steel Slag ^{5/}
HMA High ESAL	F Surface IL-12.5 or IL-9.5 SMA Ndesign 80 Surface	<u>Allowed Alone or in Combination:</u> Crystalline Crushed Stone Crushed Sandstone Crushed Slag (ACBF) ^{5/} Crushed Steel Slag ^{5/} No Limestone.

		Other Combinations Allowed:	
		Up to...	With...
		50% Crushed Gravel, Concrete ^{3/} , or Dolomite ^{2/}	Crushed Sandstone, Crushed Slag (ACBF) ^{5/} , Crushed Steel Slag ^{5/} , or Crystalline Crushed Stone

- 1/ Crushed steel slag allowed in shoulder surface only.
- 2/ Carbonate crushed stone shall not be used in SMA Ndesign 80. In SMA Ndesign 50, carbonate crushed stone shall not be blended with any of the other aggregates allowed alone in Ndesign 50 SMA binder or Ndesign 50 SMA surface.
- 3/ Crushed concrete will not be permitted in SMA mixes.
- 4/ Crushed steel slag shall not be used as leveling binder.
- 5/ When either slag is used, the blend percentages listed shall be by volume.”

HOT-MIX ASPHALT – ANTI-STRIPPING ADDITIVE (BDE)

Effective: November 1, 2009

Revise the first and second paragraphs of Article 1030.04(c) of the Standard Specifications to read:

“(c) Determination of Need for Anti-Stripping Additive. The mixture designer shall determine if an additive is needed in the mix to prevent stripping. The determination will be made on the basis of tests performed according to Illinois Modified AASHTO T 283. To be considered acceptable by the Department as a mixture not susceptible to stripping, the conditioned to unconditioned split tensile strength ratio (TSR) shall be equal to or greater than 0.85 for 6 in. (150 mm) specimens. Mixtures, either with or without an additive, with TSRs less than 0.85 for 6 in. (150 mm) specimens will be considered unacceptable. Also, the conditioned tensile strength for mixtures containing an anti-strip additive shall not be lower than the original conditioned tensile strength determined for the same mixture without the anti-strip additive.

If it is determined that an additive is required, the additive may be hydrated lime, slaked quicklime, or a liquid additive, at the Contractor's option.”

HOT-MIX ASPHALT - DENSITY TESTING OF LONGITUDINAL JOINTS (BDE)

Effective: January 1, 2010

Description. This work shall consist of testing the density of longitudinal joints as part of the quality control/quality assurance (QC/QA) of hot-mix asphalt (HMA). Work shall be according to Section 1030 of the Standard Specifications except as follows.

Quality Control/Quality Assurance (QC/QA). Delete the second and third sentence of the third paragraph of Article 1030.05(d)(3) of the Standard Specifications.

Add the following paragraphs to the end of Article 1030.05(d)(3) of the Standard Specifications:

“Longitudinal joint density testing shall be performed at each random density test location.

Longitudinal joint testing shall be located at a distance equal to the lift thickness or a minimum of 2 in. (50 mm), from each pavement edge. (i.e. for a 4 in. (100 mm) lift the near edge of the density gauge or core barrel shall be within 4 in. (100 mm) from the edge of pavement.) Longitudinal joint density testing shall be performed using either a correlated nuclear gauge or cores.

- a. Confined Edge. Each confined edge density shall be represented by a one-minute nuclear density reading or a core density and shall be included in the average of density readings or core densities taken across the mat which represents the Individual Test.
- b. Unconfined Edge. Each unconfined edge joint density shall be represented by an average of three one-minute density readings or a single core density at the given density test location and shall meet the density requirements specified herein. The three one-minute readings shall be spaced ten feet apart longitudinally along the unconfined pavement edge and centered at the random density test location.”

Revise the Density Control Limits table in Article 1030.05(d)(4) of the Standard Specifications to read:

“Mixture Composition	Parameter	Individual Test (includes confined edges)	Unconfined Edge Joint Density Minimum
IL-9.5, IL-12.5	Ndesign ≥ 90	92.0 – 96.0%	90.0%
IL-9.5,IL-9.5L, IL-12.5	Ndesign < 90	92.5 – 97.4%	90.0%
IL-19.0, IL-25.0	Ndesign ≥ 90	93.0 – 96.0%	90.0%
IL-19.0, IL-19.0L, IL-25.0	Ndesign < 90	93.0 – 97.4%	90.0%
SMA	Ndesign = 50 & 80	93.5 – 97.4%	91.0%
All Other	Ndesign = 30	93.0 - 97.4%	90.0%”

HOT-MIX ASPHALT – DROP-OFFS (BDE)

Effective: January 1, 2010

Revise the third paragraph of Article 701.07 of the Standard Specifications to read:

“At locations where construction operations result in a differential in elevation exceeding 3 in. (75 mm) between the edge of pavement or edge of shoulder within 3 ft (900 mm) of the edge of the pavement and the earth or aggregate shoulders, Type I or II barricades or vertical panels shall be placed at 100 ft (30 m) centers on roadways where the posted speed limit is 45 mph or greater and at 50 ft (15 m) centers on roadways where the posted speed limit is less than 45 mph.”

HOT-MIX ASPHALT - FINE AGGREGATE (BDE)

Effective: April 1, 2010

Add the following to the gradation tables of Article 1003.01(c) of the Standard Specifications:

"FINE AGGREGATE GRADATIONS"					
Grad No.	Sieve Size and Percent Passing				
	3/8	No. 4	No. 8	No. 16	No. 200
FA 22	100	6/	6/	8±8	2±2

FINE AGGREGATE GRADATIONS (Metric)					
Grad No.	Sieve Size and Percent Passing				
	9.5 mm	4.75 mm	2.36 mm	1.18 mm	75 µm
FA 22	100	6/	6/	8±8	2±2

6/ For the fine aggregate gradation FA 22, the aggregate producer shall set the midpoint percent passing, and the Department will apply a range of ± ten percent. The midpoint shall not be changed without Department approval."

Revise Article 1003.03(a) of the Standard Specifications to read:

"(a) Description. Fine aggregate for HMA shall consist of sand, stone sand, chats, slag sand, or steel slag sand. For gradation FA 22, uncrushed material will not be permitted."

Revise Article 1003.03(c) of the Standard Specifications to read:

"(c) Gradation. The fine aggregate gradation for all HMA shall be FA 1, FA 2, FA 20, FA 21, or FA 22.

Gradation FA 1, FA 2, or FA 3 shall be used when required for prime coat aggregate application for HMA."

LIQUIDATED DAMAGES (BDE)

Effective: April 1, 2009

Revised: April 1, 2011

Revise the table in Article 108.09 of the Standard Specifications to read:

"Schedule of Deductions for Each Day of Overrun in Contract Time"			
Original Contract Amount		Daily Charges	
From More Than	To and Including	Calendar Day	Work Day
\$ 0	\$ 100,000	\$ 475	\$ 675
100,000	500,000	750	1,050
500,000	1,000,000	1,025	1,425
1,000,000	3,000,000	1,275	1,725
3,000,000	6,000,000	1,425	2,000
6,000,000	12,000,000	2,300	3,450
12,000,000	And over	5,800	8,125"

NATIONAL POLLUTANT DISCHARGE ELIMINATION SYSTEM / EROSION AND SEDIMENT CONTROL DEFICIENCY DEDUCTION (BDE)

Effective: April 1, 2007

Revised: November 1, 2009

Revise Article 105.03(a) of the Standard Specifications to read:

“(a) National Pollutant Discharge Elimination System (NPDES) / Erosion and Sediment Control Deficiency Deduction When the Engineer is notified or determines an erosion and/or sediment control deficiency(s) exists, or the Contractor’s activities represents a violation of the Department’s NPDES permits, the Engineer will notify and direct the Contractor to correct the deficiency within a specified time. The specified time, which begins upon notification to the Contractor, will be from 1/2 hour to 1 week based on the urgency of the situation and the nature of the work effort required. The Engineer will be the sole judge.

A deficiency may be any lack of repair, maintenance, or implementation of erosion and/or sediment control devices included in the contract, or any failure to comply with the conditions of the Department’s NPDES permits. A deficiency may also be applied to situations where corrective action is not an option such as the failure to participate in a jobsite inspection of the project, failure to install required measures prior to initiating earth moving operations, disregard of concrete washout requirements, or other disregard of the NPDES permit.

If the Contractor fails to correct a deficiency within the specified time, a daily monetary deduction will be imposed for each calendar day or portion of a calendar day until the deficiency is corrected to the satisfaction of the Engineer. The calendar day(s) will begin with notification to the Contractor and end with the Engineer’s acceptance of the correction. The base value of the daily monetary deduction is \$1000.00 and will be applied to each location for which a deficiency exists. The value of the deficiency deduction assessed for each infraction will be determined by multiplying the base value by a Gravity Adjustment Factor provided in Table A. Except for failure to participate in a required jobsite inspection of the project prior to initiating earthmoving operations which will be based on the total acreage of planned disturbance at the following multipliers: <5 Acres: 1; 5-10 Acres: 2; >10-25 Acres: 3; >25 Acres: 5. For those deficiencies where corrective action was not an option, the monetary deduction will be immediate and will be valued at one calendar day multiplied by a Gravity Adjustment Factor.

Table A Deficiency Deduction Gravity Adjustment Factors				
Types of Violations	Soil Disturbed and Not Permanently Stabilized At Time of Violation			
	< 5 Acres	5 - 10 Acres	>10 - 25 Acres	> 25 Acres
Failure to Install or Properly Maintain BMP	0.1 - 0.5	0.2 - 1.0	0.5 - 2.5	1.0 - 5
Careless Destruction of BMP	0.2 - 1	0.5 - 2.5	1.0 - 5.	1.0 - 5
Intrusion into Protected Resource	1.0 - 5	1.0 - 5	2.0 - 10	2.0 - 10
Failure to properly manage Chemicals, Concrete Washouts or Residuals, Litter or other Wastes	0.2 - 1	0.2 - 1	0.5 - 2.5	1.0 - 5
Improper Vehicle and Equipment Maintenance, Fueling or Cleaning	0.1 - 0.5	0.2 - 1	0.2 - 1	0.5 - 2.5
Failure to Provide or Update Written or Graphic Plans Required by SWPPP	0.2 - 1	0.5 - 2.5	1.0 - 5	1.0 - 5
Failure to comply with Other Provisions of the NPDES Permit	0.1 - 0.5	0.2 - 1	0.2 - 1	0.5 - 2.5”

NIGHTTIME WORK ZONE LIGHTING (BDE)

Effective: November 1, 2008

Description. This work shall consist of furnishing, installing, maintaining, moving, and removing lighting for nighttime work zones. Nighttime shall be defined as occurring shortly before sunset until after sunrise.

Materials. The lighting shall consist of mobile and/or stationary lighting systems as required herein for the specific type of construction. Mobile lighting systems shall consist of luminaires attached to construction equipment or moveable carts. Stationary lighting systems shall consist of roadway luminaires mounted on temporary poles or trailer mounted light towers at fixed locations. Some lighting systems, such as balloon lights, may be adapted to both mobile and stationary applications.

Equipment. The Contractor shall furnish an illuminance meter for use by the Engineer. The meter shall have a digital display calibrated to NIST standards, shall be cosine and color corrected, and shall have an accuracy of \pm five percent. The sensor shall have a level indicator to ensure measurements are taken in a horizontal plane.

CONSTRUCTION REQUIREMENTS

General. At the preconstruction conference, the Contractor shall submit the type(s) of lighting system to be used and the locations of all devices.

Before nighttime construction may begin, the lighting system shall be demonstrated as being operational.

Nighttime Flagging. The requirements for nighttime flagging shall be according to Article 701.13 of the Standard Specifications and the glare control requirements contained herein.

Lighting System Design. The lighting system shall be designed to meet the following.

- (a) Lighting Levels. The lighting system shall provide a minimum of 5 foot candles (54 lux) throughout the work area. For mobile operations, the work area shall be defined as 25 ft (9 m) in front of and behind moving equipment. For stationary operations, the work area shall be defined as the entire area where work is being performed.

Lighting levels will be measured with an illuminance meter. Readings will be taken in a horizontal plane 3 ft (1 m) above the pavement or ground surface.

- (b) Glare Control. The lighting system shall be designed and operated so as to avoid glare that interferes with traffic, workers, or inspection personnel. Lighting systems with flood, spot, or stadium type luminaires shall be aimed downward at the work and rotated outward no greater than 30 degrees from nadir (straight down). Balloon lights shall be positioned at least 12 ft (3.6 m) above the roadway.

As a large component of glare, the headlights of construction vehicles and equipment shall not be operated within the work zone except as allowed for specific construction operations. Headlights shall never be used when facing oncoming traffic.

- (c) Light Trespass. The lighting system shall be designed to effectively light the work area without spilling over to adjoining property. When, in the opinion of the Engineer, the lighting is disturbing adjoining property, the Contractor shall modify the lighting arrangement or add hardware to shield the light trespass.

Construction Operations. The lighting design required above shall be provided at any location where construction equipment is operating or workers are present on foot. When multiple operations are being carried on simultaneously, lighting shall be provided at each separate work area.

The lighting requirements for specific construction operations shall be as follows.

- (a) Installation or Removal of Work Zone Traffic Control. The required lighting level shall be provided at each truck and piece of equipment used during the installation or removal of work zone traffic control. Headlights may be operated in the work zone.
- (b) Milling and Paving. The required lighting level shall be provided by mounting a minimum of one balloon light to each piece of mobile construction equipment used in the work zone. This would include milling machines, mechanical sweepers, material transfer devices, spreading and finishing machines, and rollers; but not include trucks used to transport materials and personnel or other vehicles that are continuously moving in and out of the work zone. The headlights of construction equipment shall not be operated within the work zone.
- (c) Patching. The required lighting level shall be provided at each patching location where work is being performed.
- (d) Pavement Marking and Raised Reflective Pavement Marker Removal/Installation. The striping truck and the attenuator/arrow board trucks may be operated by headlights alone; however, additional lighting may be necessary for the operator of the striping truck to perform the work.

For raised reflective pavement marker removal and installation and other pavement marking operations where workers are on foot, the required lighting level shall be provided at each truck and piece of equipment.

- (e) Layout, Testing, and Inspection. The required lighting level shall be provided for each active area of construction layout, material testing, and inspection. The work area shall be defined as 15 ft (7.6 m) in front and back of the individual(s) performing the tasks.

Basis of Payment. This work will be paid for at the contract lump sum price for NIGHTTIME WORK ZONE LIGHTING.

PAVEMENT PATCHING (BDE)

Effective: January 1, 2010

Revise the first sentence of the second paragraph of Article 701.17(e)(1) of the Standard Specifications to read:

“In addition to the traffic control and protection shown elsewhere in the contract for pavement, two devices shall be placed immediately in front of each open patch, open hole, and broken pavement where temporary concrete barriers are not used to separate traffic from the work area.”

PAYMENTS TO SUBCONTRACTORS (BDE)

Effective: June 1, 2000

Revised: January 1, 2006

Federal regulations found at 49 CFR §26.29 mandate the Department to establish a contract clause to require Contractors to pay subcontractors for satisfactory performance of their subcontracts and to set the time for such payments.

State law also addresses the timing of payments to be made to subcontractors and material suppliers. Section 7 of the Prompt Payment Act, 30 ILCS 540/7, requires that when a Contractor receives any payment from the Department, the Contractor shall make corresponding, proportional payments to each subcontractor and material supplier performing work or supplying material within 15 calendar days after receipt of the Department payment. Section 7 of the Act further provides that interest in the amount of two percent per month, in addition to the payment due, shall be paid to any subcontractor or material supplier by the Contractor if the payment required by the Act is withheld or delayed without reasonable cause. The Act also provides that the time for payment required and the calculation of any interest due applies to transactions between subcontractors and lower-tier subcontractors and material suppliers throughout the contracting chain.

This Special Provision establishes the required federal contract clause, and adopts the 15 calendar day requirement of the State Prompt Payment Act for purposes of compliance with the federal regulation regarding payments to subcontractors. This contract is subject to the following payment obligations.

When progress payments are made to the Contractor according to Article 109.07 of the Standard Specifications, the Contractor shall make a corresponding payment to each subcontractor and material supplier in proportion to the work satisfactorily completed by each subcontractor and for the material supplied to perform any work of the contract. The proportionate amount of partial payment due to each subcontractor and material supplier throughout the contracting chain shall be determined by the quantities measured or otherwise determined as eligible for payment by the Department and included in the progress payment to the Contractor. Subcontractors and material suppliers shall be paid by the Contractor within 15 calendar days after the receipt of payment from the Department. The Contractor shall not hold retainage from the subcontractors. These obligations shall also apply to any payments made by subcontractors and material suppliers to their subcontractors and material suppliers; and to all payments made to lower tier subcontractors and material suppliers throughout the contracting chain. Any payment or portion of a payment subject to this provision may only be withheld from the subcontractor or material supplier to whom it is due for reasonable cause.

This Special Provision does not create any rights in favor of any subcontractor or material supplier against the State or authorize any cause of action against the State on account of any payment, nonpayment, delayed payment, or interest claimed by application of the State Prompt Payment Act. The Department will not approve any delay or postponement of the 15 day requirement except for reasonable cause shown after notice and hearing pursuant to Section 7(b) of the State Prompt Payment Act. State law creates other and additional remedies available to any subcontractor or material supplier, regardless of tier, who has not been paid for work properly performed or material furnished.

These remedies are a lien against public funds set forth in Section 23(c) of the Mechanics Lien Act, 770 ILCS 60/23(c), and a recovery on the Contractor's payment bond according to the Public Construction Bond Act, 30 ILCS 550.

POST MOUNTING OF SIGNS (BDE)

Effective: January 1, 2011

Revise the second paragraph of Article 701.14 of the Standard Specifications to read:

“Post mounted signs shall be a breakaway design. The sign shall be within five degrees of vertical. Two posts shall be used for signs greater than 16 sq ft (1.5 sq m) in area or where the height between the sign and the ground exceeds 7 ft (2.1 m).”

RAISED REFLECTIVE PAVEMENT MARKERS (BDE)

Effective: November 1, 2009

Revised: April 1, 2010

Revise the first sentence of the second paragraph of Article 781.03(a) of the Standard Specifications to read:

“The pavement shall be cut to match the bottom contour of the marker using a concrete saw fitted with 18 and 20 in. (450 and 500 mm) diameter blades.”

RECLAIMED ASPHALT PAVEMENT (RAP) (BDE)

Effective: January 1, 2007

Revised: January 1, 2011

In Article 1030.02(g), delete the last sentence of the first paragraph in (Note 2).

Revise Section 1031 of the Standard Specifications to read:

“SECTION 1031. RECLAIMED ASPHALT PAVEMENT

1031.01 Description. Reclaimed asphalt pavement (RAP) is reclaimed asphalt pavement resulting from cold milling or crushing of an existing dense graded hot-mix asphalt (HMA) pavement. The Contractor shall supply written documentation that the RAP originated from routes or airfields under federal, state, or local agency jurisdiction.

1031.02 Stockpiles. The Contractor shall construct individual, sealed RAP stockpiles meeting one of the following definitions. No additional RAP shall be added to the pile after the pile has been sealed. Stockpiles shall be sufficiently separated to prevent intermingling at the base. Stockpiles shall be identified by signs indicating the type as listed below (i.e. “Homogeneous Surface”).

Prior to milling, the Contractor shall request the District to provide verification of the quality of the RAP to clarify appropriate stockpile.

- (a) Fractionated RAP (FRAP). FRAP shall consist of RAP from Class I, Superpave (High ESAL), HMA (High ESAL), or equivalent mixtures. The coarse aggregate in FRAP shall be crushed aggregate and may represent more than one aggregate type and/or quality but shall be at least C quality.

All FRAP shall be fractionated prior to testing by screening into a minimum of two size fractions with the separation occurring on or between the #4 (4.75 mm) and 1/2 in. (12.5 mm) sieves. Agglomerations shall be minimized such that 100 percent of the RAP in the coarse fraction shall pass one sieve size larger than the maximum sieve size specified for the mix the RAP will be used in.

- (b) Homogeneous. Homogeneous RAP stockpiles shall consist of RAP from Class I, Superpave (High ESAL), HMA (High ESAL), or equivalent mixtures and represent: 1) the same aggregate quality, but shall be at least C quality; 2) the same type of crushed aggregate (either crushed natural aggregate, ACBF slag, or steel slag); 3) similar gradation; and 4) similar asphalt binder content. If approved by the Engineer, combined single pass surface/binder millings may be considered "homogenous" with a quality rating dictated by the lowest coarse aggregate quality present in the mixture.
- (c) Conglomerate. Conglomerate RAP stockpiles shall consist of RAP from Class I, Superpave (High ESAL), HMA (High ESAL), or equivalent mixtures. The coarse aggregate in this RAP shall be crushed aggregate and may represent more than one aggregate type and/or quality but shall be at least C quality. This RAP may have an inconsistent gradation and/or asphalt binder content prior to processing. All conglomerate RAP shall be processed prior to testing by crushing to where all RAP shall pass the 5/8 in. (16 mm) or smaller screen. Conglomerate RAP stockpiles shall not contain steel slag or other expansive material as determined by the Department.
- (d) Conglomerate "D" Quality (DQ). Conglomerate DQ RAP stockpiles shall consist of RAP from Class I, Superpave (High or Low ESAL), HMA (High or Low ESAL), or equivalent mixtures. The coarse aggregate in this RAP may be crushed or round but shall be at least D quality. This RAP may have an inconsistent gradation and/or asphalt binder content. Conglomerate DQ RAP stockpiles shall not contain steel slag or other expansive material as determined by the Department.
- (e) Non-Quality. RAP stockpiles that do not meet the requirements of the stockpile categories listed above shall be classified as "Non-Quality".

RAP/FRAP containing contaminants, such as earth, brick, sand, concrete, sheet asphalt, bituminous surface treatment (i.e. chip seal), pavement fabric, joint sealants, etc., will be unacceptable unless the contaminants are removed to the satisfaction of the Engineer. Sheet asphalt shall be stockpiled separately.

1031.03 Testing. When used in HMA, the RAP/FRAP shall be sampled and tested either during or after stockpiling.

For testing during stockpiling, washed extraction samples shall be run at the minimum frequency of one sample per 500 tons (450 metric tons) for the first 2000 tons (1800 metric tons) and one sample per 2000 tons (1800 metric tons) thereafter. A minimum of five tests shall be required for stockpiles less than 4000 tons (3600 metric tons).

For testing after stockpiling, the Contractor shall submit a plan for approval to the District proposing a satisfactory method of sampling and testing the RAP/FRAP pile either in-situ or by restockpiling. The sampling plan shall meet the minimum frequency required above and detail the procedure used to obtain representative samples throughout the pile for testing.

Before extraction, each field sample shall be split to obtain two samples of test sample size. One of the two test samples from the final split shall be labeled and stored for Department use. The Contractor shall extract the other test sample according to Department procedure. The Engineer reserves the right to test any sample (split or Department-taken) to verify Contractor test results.

Evaluation of Test Results. All of the extraction results shall be compiled and averaged for asphalt binder content and gradation and, when applicable G_{mm} . Individual extraction test results, when compared to the averages, will be accepted if within the tolerances listed below.

Parameter	FRAP/Homogeneous/Conglomerate	Conglomerate "D" Quality
1 in. (25 mm)		± 5 %
1/2 in. (12.5 mm)	± 8 %	± 15 %
No. 4 (4.75 mm)	± 6 %	± 13 %
No. 8 (2.36 mm)	± 5 %	
No. 16 (1.18 mm)		± 15 %
No. 30 (600 μm)	± 5 %	
No. 200 (75 μm)	± 2.0 %	± 4.0 %
Asphalt Binder	± 0.4 % ^{1/}	± 0.5 %
G_{mm}	± 0.03	

1/ The tolerance for FRAP shall be ± 0.3 %.

If more than 20 percent of the individual sieves are out of the gradation tolerances, or if more than 20 percent of the asphalt binder content test results fall outside the appropriate tolerances, the RAP/FRAP shall not be used in HMA unless the RAP/FRAP representing the failing tests is removed from the stockpile. All test data and acceptance ranges shall be sent to the District for evaluation.

With the approval of the Engineer, the ignition oven may be substituted for extractions according to the Illinois Test Procedure, "Calibration of the Ignition Oven for the Purpose of Characterizing Reclaimed Asphalt Pavement (RAP)".

1031.04 Quality Designation of Aggregate in RAP/FRAP.

- (a) The aggregate quality of the RAP for homogenous, conglomerate, and conglomerate "D" quality stockpiles shall be set by the lowest quality of coarse aggregate in the RAP stockpile and are designated as follows.
 - (1) RAP from Class I, Superpave (High ESAL)/HMA (High ESAL), or HMA (Low ESAL) IL-9.5L surface mixtures are designated as containing Class B quality coarse aggregate.
 - (2) RAP from Superpave (Low ESAL)/HMA (Low ESAL) IL-19.0L binder mixture is designated as Class D quality coarse aggregate.
 - (3) RAP from Class I, Superpave (High ESAL), or HMA (High ESAL) binder mixtures, bituminous base course mixtures, and bituminous base course widening mixtures are designated as containing Class C quality coarse aggregate.
 - (4) RAP from bituminous stabilized subbase and BAM shoulders are designated as containing Class D quality coarse aggregate.

- (b) The aggregate quality of FRAP shall be determined as follows.

- (1) If the Engineer has documentation of the quality of the FRAP aggregate, the Contractor shall use the assigned quality provided by the Engineer. If the quality is not known, the quality shall be determined according to Article 1031.04(b)(2).
- (2) Fractionated stockpiles containing plus #4 (4.75 mm) sieve coarse aggregate shall have a maximum tonnage of 5000 tons (4500 metric tons). The Contractor shall obtain a representative sample witnessed by the Engineer. The sample shall be a minimum of 50 lb (25 kg). The sample shall be extracted according to Illinois Modified AASHTO T 164 by a consultant prequalified by the Department for the specified testing. The consultant shall submit the test results along with the recovered aggregate to the District Office. The cost for this testing shall be paid by the Contractor. The District will forward the sample to the BMPR Aggregate Lab for MicroDeval Testing, according to Illinois Modified AASHTO T 327. A maximum loss of 15.0 percent will be applied for all HMA applications.”

1031.05 Use of RAP/FRAP in HMA. The use of RAP/FRAP shall be a Contractor’s option when constructing HMA in all contracts. The use of RAP/FRAP in HMA shall be as follows.

- (a) Coarse Aggregate Size. The coarse aggregate in all RAP shall be equal to or less than the nominal maximum size requirement for the HMA mixture to be produced.
- (b) Steel Slag Stockpiles. RAP stockpiles containing steel slag or other expansive material, as determined by the Department, shall be homogeneous and will be approved for use in HMA (High ESAL and Low ESAL) surface mixtures only.
- (c) Use in HMA Surface Mixtures (High and Low ESAL). RAP/FRAP stockpiles for use in HMA surface mixtures (High and Low ESAL) shall be FRAP or homogeneous in which the coarse aggregate is Class B quality or better.
- (d) Use in HMA Binder Mixtures (High and Low ESAL), HMA Base Course, and HMA Base Course Widening. RAP/FRAP stockpiles for use in HMA binder mixtures (High and Low ESAL), HMA base course, and HMA base course widening shall be FRAP, homogeneous, or conglomerate, in which the coarse aggregate is Class C quality or better.
- (e) Use in Shoulders and Subbase. RAP/FRAP stockpiles for use in HMA shoulders and stabilized subbase (HMA) shall be FRAP, homogeneous, conglomerate, or conglomerate DQ.
- (f) When the Contractor chooses the RAP option, the percentage of RAP shall not exceed the amounts indicated in the table below for a given N Design.

Max RAP Percentage

HMA Mixtures ^{1, 3/}	Maximum % RAP		
	Binder/Leveling Binder	Surface	Polymer Modified
Ndesign 30	30	30	10
50	25	15	10
70	15 / 25 ^{2/}	10 / 15 ^{2/}	10
90	10	10	10
105	10	10	10

- 1/ For HMA shoulder and stabilized subbase (HMA) N-30, the amount of RAP shall not exceed 50% of the mixture.
- 2/ Value of Max % RAP if homogeneous RAP stockpile of IL-9.5 RAP is utilized.
- 3/ When RAP exceeds 20 percent, the high and low virgin asphalt binder grades shall each be reduced by one grade (i.e. 25 percent RAP would require a virgin asphalt binder grade of PG64-22 to be reduced to a PG58-28). If warm mix asphalt (WMA) technology is utilized, and production temperatures do not exceed 275 °F (135 °C) the grades shall be reduced as follows:

Overlays:

When WMA contains between 20 and 30 percent RAP the high temperature shall be reduced by one grade (i.e. 25 percent RAP would require a virgin asphalt binder grade of PG64-22 to be reduced to a PG58-22). When WMA contains 30 percent or more RAP the high and low temperature grades shall each be reduced by one grade (i.e. 35 percent RAP would require a virgin asphalt binder grade of PG64-22 to be reduced to a PG58-28).

Full Depth:

When WMA contains between 20 and 30 percent RAP, the low temperature shall be reduced by one grade (i.e. 25 percent RAP would require a virgin asphalt binder grade of PG64-22 to be reduced to a PG64-28). When the WMA contains 30 percent or more RAP the high and low temperature grades shall each be reduced by one grade (i.e. 35 percent RAP would require a virgin asphalt binder grade of PG64-22 to be reduced to a PG58-28).

- (g) When the Contractor chooses the FRAP option, the percentage of FRAP shall not exceed the amounts indicated in the table below for a given N Design.

Max FRAP Percentage

HMA Mixtures ^{1/, 2/}	Maximum % FRAP			
	Ndesign	Binder/Leveling Binder	Surface	Polymer Modified
30	35	35	10	10
50	30	25	10	10
70	25	20	10	10
90	20	15	10	10
105	10	10	10	10

- 1/ For HMA shoulder and stabilized subbase (HMA) N30, the amount of FRAP shall not exceed 50 percent of the mixture.
- 2/ When FRAP exceeds 20 percent, the high and low virgin asphalt binder grades shall each be reduced by one grade (i.e. 25 percent FRAP would require a virgin asphalt binder grade of PG64-22 to be reduced to a PG58-28). If warm mix asphalt (WMA) technology is utilized, and production temperatures do not exceed 275°F (135 °C) the grades shall be reduced as follows:

Overlays:

When WMA contains between 20 and 30 percent FRAP the high temperature shall be reduced by one grade (i.e. 25 percent FRAP would require a virgin asphalt binder grade of PG64-22 to be reduced to a PG58-22). When WMA contains 30 percent or more FRAP the high and low temperature grades shall each be reduced by one grade (i.e. 35 percent FRAP would require a virgin asphalt binder grade of PG64-22 to be reduced to a PG58-28).

Full Depth:

When WMA contains between 20 and 30 percent FRAP, the low temperature shall be reduced by one grade (i.e. 25 percent FRAP would require a virgin asphalt binder grade of PG64-22 to be reduced to a PG64-28). When the WMA contains 30 percent or more FRAP the high and low temperature grades shall each be reduced by one grade (i.e. 35 percent FRAP would require a virgin asphalt binder grade of PG64-22 to be reduced to a PG58-28).

1031.06 HMA Mix Designs. At the Contractor's option, HMA mixtures may be constructed utilizing RAP/FRAP material meeting the above detailed requirements.

RAP/FRAP designs shall be submitted for volumetric verification. If additional RAP/FRAP stockpiles are tested and found that no more than 20 percent of the results, as defined under "Testing" herein, are outside of the control tolerances set for the original RAP/FRAP stockpile and HMA mix design, and meets all of the requirements herein, the additional RAP/FRAP stockpiles may be used in the original mix design at the percent previously verified.

1031.07 HMA Production. The coarse aggregate in all RAP used shall be equal to or less than the nominal maximum size requirement for the HMA mixture being produced.

To remove or reduce agglomerated material, a scalping screen, gator, crushing unit, or comparable sizing device approved by the Engineer shall be used in the RAP feed system to remove or reduce oversized material. If material passing the sizing device adversely affects the mix production or quality of the mix, the sizing device shall be set at a size specified by the Engineer.

If the RAP/FRAP control tolerances or QC/QA test results require corrective action, the Contractor shall cease production of the mixture containing RAP/FRAP and either switch to the virgin aggregate design or submit a new RAP/FRAP design.

HMA plants utilizing RAP/FRAP shall be capable of automatically recording and printing the following information.

(a) Dryer Drum Plants.

- (1) Date, month, year, and time to the nearest minute for each print.
- (2) HMA mix number assigned by the Department.
- (3) Accumulated weight of dry aggregate (combined or individual) in tons (metric tons) to the nearest 0.1 ton (0.1 metric ton).

- (4) Accumulated dry weight of RAP/FRAP in tons (metric tons) to the nearest 0.1 ton (0.1 metric ton).
- (5) Accumulated mineral filler in revolutions, tons (metric tons), etc. to the nearest 0.1 unit.
- (6) Accumulated asphalt binder in gallons (liters), tons (metric tons), etc. to the nearest 0.1 unit.
- (7) Residual asphalt binder in the RAP/FRAP material as a percent of the total mix to the nearest 0.1 percent.
- (8) Aggregate and RAP/FRAP moisture compensators in percent as set on the control panel. (Required when accumulated or individual aggregate and RAP/FRAP are printed in wet condition.)

(b) Batch Plants.

- (1) Date, month, year, and time to the nearest minute for each print.
- (2) HMA mix number assigned by the Department.
- (3) Individual virgin aggregate hot bin batch weights to the nearest pound (kilogram).
- (4) Mineral filler weight to the nearest pound (kilogram).
- (5) RAP/FRAP weight to the nearest pound (kilogram).
- (6) Virgin asphalt binder weight to the nearest pound (kilogram).
- (7) Residual asphalt binder in the RAP/FRAP material as a percent of the total mix to the nearest 0.1 percent.

The printouts shall be maintained in a file at the plant for a minimum of one year or as directed by the Engineer and shall be made available upon request. The printing system will be inspected by the Engineer prior to production and verified at the beginning of each construction season thereafter.

1031.08 RAP in Aggregate Surface Course and Aggregate Shoulders. The use of RAP in aggregate surface course and aggregate shoulders shall be as follows.

- (a) Stockpiles and Testing. RAP stockpiles may be any of those listed in Article 1031.02, except "Non-Quality" and "FRAP". The testing requirements of Article 1031.03 shall not apply.
- (b) Gradation. One hundred percent of the RAP material shall pass the 1 1/2 in. (37.5 mm) sieve. The RAP material shall be reasonably well graded from coarse to fine. RAP material that is gap-graded or single sized will not be accepted."

SELECTION OF LABOR (BDE)

Effective: July 2, 2010

Revise Section I of Check Sheet #5 of the Recurring Special Provisions to read:

"I. SELECTION OF LABOR

The Contractor shall comply with all Illinois statutes pertaining to the selection of labor.

**EMPLOYMENT OF ILLINOIS WORKERS DURING PERIODS OF EXCESSIVE
UNEMPLOYMENT**

Whenever there is a period of excessive unemployment in Illinois, which is defined herein as any month immediately following two consecutive calendar months during which the level of unemployment in the State of Illinois has exceeded five percent as measured by the United States Bureau of Labor Statistics in its monthly publication of employment and unemployment figures, the Contractor shall employ at least 90 percent Illinois laborers. "Illinois laborer" means any person who has resided in Illinois for at least 30 days and intends to become or remain an Illinois resident.

Other laborers may be used when Illinois laborers as defined herein are not available, or are incapable of performing the particular type of work involved, if so certified by the Contractor and approved by the Engineer. The Contractor may place no more than three of his/her regularly employed non-resident executive and technical experts, who do not qualify as Illinois laborers, to do work encompassed by this contract during period of excessive unemployment.

This provision applies to all labor, whether skilled, semi-skilled, or unskilled, whether manual or non-manual."

SUBCONTRACTOR MOBILIZATION PAYMENTS (BDE)

Effective: April 2, 2005

Revised: April 1, 2011

To account for the preparatory work and operations necessary for the movement of subcontractor personnel, equipment, supplies, and incidentals to the project site and for all other work or operations that must be performed or costs incurred when beginning work approved for subcontracting according to Article 108.01 of the Standard Specifications, the Contractor shall make a mobilization payment to each subcontractor.

This mobilization payment shall be made at least 14 days prior to the subcontractor starting work. The amount paid shall be equal to 3 percent of the amount of the subcontract reported on form BC 260A submitted for the approval of the subcontractor's work.

The mobilization payment to the subcontractor is an advance payment of the reported amount of the subcontract and is not a payment in addition to the amount of the subcontract; therefore, the amount of the advance payment will be deducted from future progress payments.

This provision shall be incorporated directly or by reference into each subcontract approved by the Department.

TRUCK MOUNTED/TRAILER MOUNTED ATTENUATORS (BDE)

Effective: January 1, 2010

Revise Article 701.03(k) of the Standard Specifications to read:

"(k) Truck Mounted/Trailer Mounted Attenuators 1106.02"

Revise Article 701.15(h) of the Standard Specifications to read:

“(h) Truck Mounted/Trailer Mounted Attenuators (TMA). TMA units shall have a roll ahead distance in the event of an impact. The TMA shall be between 100 and 200 ft (30 and 60 m) behind the vehicle ahead or the workers. This distance may be extended by the Engineer.

TMA host vehicles shall have the parking brake engaged when stationary.

The driver and passengers of the TMA host vehicle should exit the vehicle if the TMA is to remain stationary for 15 minutes or more in duration.”

Revise Article 1106.02(g) of the Standard Specifications to read:

“(g) Truck Mounted/Trailer Mounted Attenuators. The attenuator shall be a NCHRP 350 approved unit for Test Level 3. Test Level 2 may be used as directed by the Engineer for normal posted speeds less than or equal to 45 mph.”

UTILITY COORDINATION AND CONFLICTS (BDE)

Effective: April 1, 2011

Revise Article 105.07 of the Standard Specifications to read:

“**105.07 Cooperation with Utilities.** The Department reserves the right at any time to allow work by utilities on or near the work covered by the contract. The Contractor shall conduct his/her work so as not to interfere with or hinder the progress or completion of the work being performed by utilities. The Contractor shall also arrange the work and shall place and dispose of the materials being used so as not to interfere with the operations of utility work in the area.

The Contractor shall cooperate with the owners of utilities in their removal and rearrangement operations so work may progress in a reasonable manner, duplication or rearrangement of work may be reduced to a minimum, and services rendered by those parties will not be unnecessarily interrupted.

The Contractor shall coordinate with any planned utility adjustment or new installation and the Contractor shall take all precautions to prevent disturbance or damage to utility facilities. Any failure on the part of the utility owner, or their representative, to proceed with any planned utility adjustment or new installation shall be reported promptly by the Contractor to the Engineer.”

Revise the first sentence of the last paragraph of Article 107.19 of the Standard Specifications to read:

“When the Contractor encounters unexpected regulated substances due to the presence of utilities in unanticipated locations, the provisions of Article 107.40 shall apply; otherwise, if the Engineer does not direct a resumption of operations, the provisions of Article 108.07 shall apply.”

Revise Article 107.31 of the Standard Specification to read:

“**107.31 Reserved.**”

Add the following four Articles to Section 107 of the Standard Specifications:

“107.37 Locations of Utilities within the Project Limits. All known utilities existing within the limits of construction are either indicated on the plans or visible above ground. For the purpose of this Article, the limits of proposed construction are defined as follows:

(a) Limits of Proposed Construction for Utilities Paralleling the Roadway.

- (1) The horizontal limits shall be a vertical plane, outside of, parallel to, and 2 ft (600 mm) distant at right angles from the plan or revised slope limits.

In cases where the limits of excavation for structures are not shown on the plans, the horizontal limits shall be a vertical plane 4 ft (1.2 m) outside the edges of structure footings or the structure where no footings are required.

- (2) The upper vertical limits shall be the regulations governing the roadbed clearance for the specific utility involved.
- (3) The lower vertical limits shall be either the top of the utility at the depth below the proposed grade as prescribed by the governing agency or the limits of excavation, whichever is less.

(b) Limits of Proposed Construction for Utilities Crossing the Roadway in a Generally Transverse Direction.

- (1) Utilities crossing excavations for structures that are normally made by trenching such as sewers, underdrains, etc. and all minor structures such as manholes, inlets, foundations for signs, foundations for traffic signals, etc., the limits shall be the space to be occupied by the proposed permanent construction, unless otherwise required by the regulations governing the specific utility involved.
- (2) For utilities crossing the proposed site of major structures such as bridges, sign trusses, etc., the limits shall be as defined above for utilities extending in the same general direction as the roadway.

It is understood and agreed that the Contractor has considered in the bid all of the permanent and temporary utilities in their present and/or adjusted positions as indicated in the contract. It is further understood the actual location of the utilities may be located anywhere within the tolerances provided in 220 ILCS 50/2.8 or Administrative Code Title 92 Part 530.40(c), and the proximity of some utilities to construction may require extraordinary measures by the Contractor to protect those utilities.

No additional compensation will be allowed for any delays, inconveniences, or damages sustained by the Contractor due to the presence of or any claimed interference from known utility facilities or any adjustment of them, except as specifically provided in the contract.

107.38 Adjustments of Utilities within the Project Limits. The adjustment of utilities consists of the relocation, removal, replacement, rearrangements, reconstruction, improvement, disconnection, connection, shifting, new installation, or altering of an existing utility facility in any manner.

Utilities which are to be adjusted shall be adjusted by the utility owner or the owner's representative or by the Contractor as a contract item. Generally, arrangements for adjusting known utilities will be made by the Department prior to project construction; however, utilities will not necessarily be adjusted in advance of project construction and, in some cases, utilities will not be removed from the proposed construction limits as described in Article 107.37. When utility adjustments must be performed in conjunction with construction, the utility adjustment work will be indicated in the contract.

The Contractor may make arrangements for adjustment of utilities indicated in the contract, but not scheduled by the Department for adjustment, provided the Contractor furnishes the Department with a signed agreement with the utility owner covering the adjustments to be made. The cost of any such adjustments shall be the responsibility of the Contractor.

107.39 Contractor's Responsibility for Locating and Protecting Utility Property and Services. At points where the Contractor's operations are adjacent to properties or facilities of utility companies, or are adjacent to other property, damage to which might result in considerable expense, loss, or inconvenience, work shall not be commenced until all arrangements necessary for the protection thereof have been made.

Within the State of Illinois, a State-Wide One Call Notice System has been established for notifying utilities. Outside the city limits of the City of Chicago, the system is known as the Joint Utility Locating Information for Excavators (JULIE) System. Within the city limits of the City of Chicago the system is known as DIGGER. All utility companies and municipalities which have buried utility facilities in the State of Illinois are a part of this system.

The Contractor shall call JULIE (800-892-0123) or DIGGER (312-744-7000), a minimum of 48 hours in advance of work being done in the area, and they will notify all member utility companies involved their respective utility should be located.

For utilities which are not members of JULIE or DIGGER, the Contractor shall contact the owners directly. The plan general notes will indicate which utilities are not members of JULIE or DIGGER.

The following table indicates the color of markings required of the State-Wide One Call Notification System.

Utility Service	Color
Electric Power, Distribution and Transmission	Safety Red
Municipal Electric Systems	Safety Red
Gas Distribution and Transmission	High Visibility Safety Yellow
Oil Distribution and Transmission	High Visibility Safety Yellow
Telephone and Telegraph System	Safety Alert Orange
Community Antenna Television Systems	Safety Alert Orange
Water Systems	Safety Precaution Blue
Sewer Systems	Safety Green
Non-Potable Water and Slurry Lines	Safety Purple
Temporary Survey	Safety Pink
Proposed Excavation	Safety White (Black when snow is on the ground)

The State-Wide One Call Notification System will provide for horizontal locations of utilities. When it is determined that the vertical location of the utility is necessary to facilitate construction, the Engineer may make the request for location from the utility after receipt of notice from the Contractor. If the utility owner does not field locate their facilities to the satisfaction of the Engineer, the Engineer will authorize the Contractor in writing to proceed to locate the facilities in the most economical and reasonable manner, subject to the approval of the Engineer, and be paid according to Article 109.04.

The Contractor shall be responsible for maintaining the excavations or markers provided by the utility owners.

The Contractor shall take all necessary precautions for the protection of the utility facilities. The Contractor shall be responsible for any damage or destruction of utility facilities resulting from neglect, misconduct, or omission in the Contractor's manner or method of execution or nonexecution of the work, or caused by defective work or the use of unsatisfactory materials. Whenever any damage or destruction of a utility facility occurs as a result of work performed by the Contractor, the utility company will be immediately notified. The utility company will make arrangements to restore such facility to a condition equal to that existing before any such damage or destruction was done.

In the event of interruption of utility services as a result of accidental breakage or as a result of being exposed or unsupported, the Contractor shall promptly notify the proper authority and shall cooperate with the said authority in the restoration of service. If water service is interrupted, repair work shall be continuous until the service is restored. No work shall be undertaken around fire hydrants until provisions for continued service have been approved by the local fire authority.

107.40 Conflicts with Utilities. Except as provided hereinafter, the discovery of a utility in an unanticipated location will be evaluated according to Article 104.03. It is understood and agreed that the Contractor has considered in the bid all facilities not meeting the definition of a utility in an unanticipated location and no additional compensation will be allowed for any delays, inconveniences, or damages sustained by the Contractor due to the presence of or any claimed interference from such facilities.

When the Contractor discovers a utility in an unanticipated location, the Contractor shall not interfere with said utility, shall take proper precautions to prevent damage or interruption of the utility, and shall promptly notify the Engineer of the nature and location of said utility.

- (a) Definition. A utility in an unanticipated location is defined as an active or inactive utility, which is either:
- (1) Located underground and (a) not shown in any way in any location on the contract documents; (b) not identified in writing by the Department to the Contractor prior to the letting; or (c) not located relative to the location shown in the contract within the tolerances provided in 220 ILCS 50/2.8 or Administrative Code Title 92 Part 530.40(c); or
 - (2) Located above ground or underground and not relocated as provided in the contract.

Service connections shall not be considered to be utilities in unanticipated locations.

(b) Compensation. Compensation will not be allowed for delays, inconveniences, or damages sustained by the Contractor from conflicts with facilities not meeting the above definition; or if a conflict with a utility in an unanticipated location does not cause a shutdown of the work applicable to the utility or a documentable reduction in the rate of progress exceeding the limits set herein. The provisions of Article 104.03 notwithstanding, compensation for delays caused by a utility in an unanticipated location will be paid according to the provisions of this Article governing minor and major delays or reduced rate of production which are defined as follows:

- (1) Minor Delay. A minor delay occurs when the Contractor's operation is completely stopped by a utility in an unanticipated location for more than two hours, but not to exceed three weeks.
- (2) Major Delay. A major delay occurs when the Contractor's operation is completely stopped by a utility in an unanticipated location for more than three weeks.
- (3) Reduced Rate of Production Delay. A reduced rate of production delay occurs when the contractor's rate of production decreases by more than 25 percent and lasts longer than seven days.

(c) Payment. Payment for Minor, Major and Reduced Rate of Production Delays will be made as follows.

- (1) Minor Delay. Labor idled which cannot be used on other work will be paid for according to Article 109.04(b)(1) and (2) for the time between start of the delay and the minimum remaining hours in the work shift required by the prevailing practice in the area.

Equipment idled which cannot be used on other work will be paid for according to Article 109.04(b)(4). The length of time paid for will be the time between start of delay and eight hours working time from start of shift being worked.

For delays exceeding the initial shift, excluding Saturdays, Sundays, and holidays, Contractor-owned equipment idled by the delay which cannot be used on other work and remaining at the work site, will be paid at one-half the rate permitted in Article 109.04(b)(4) using a maximum eight hours per day for computation purposes. Equipment rented from an independent source will be paid at rates being paid by the Contractor plus move-in move-out costs, but the total amount paid will not exceed three weeks rental.

- (2) Major Delay. Labor will be the same as for a minor delay.

Equipment will be the same as for a minor delay, except Contractor-owned equipment will be limited to three weeks plus the cost of move-out to either the Contractor's yard or another job, whichever is less. Rental equipment may be paid for longer than three weeks provided the Contractor presents adequate support to the Department (including lease agreement) to show retaining equipment on the job is the most economical course to follow and in the public interest.

- (3) Reduced Rate of Production Delay. The Contractor will be compensated for the reduced productivity for labor and equipment time in excess of the 25 percent threshold for that portion of the delay in excess of seven days. Determination of compensation will be in accordance with Article 104.02, except labor and material additives will not be permitted.

Whether covered by (1), (2) or (3) above, additional traffic control required as a result of the operation(s) delayed will be paid for according to Article 109.04 for the total length of the delay.

If the delay is clearly shown to have caused work, which would have otherwise been completed, to be done after material or labor costs have increased, such increases may be paid. Payment for materials will be limited to increased cost substantiated by documentation furnished by the Contractor. Payment for increased labor rates will include those items in Article 109.04(b)(1) and (2), except the 35 percent and ten percent additives will not be permitted. On a working day contract, a delay occurring between November 30 and May 1, when work has not started, will not be considered as eligible for payment of measured labor and material costs.

Project overhead (not including interest) will be allowed when all progress on the contract has been delayed, and will be calculated as 15 percent of the delay claim.

- (d) Other Obligations of Contractor. Upon payment of a claim under this provision, the Contractor shall assign subrogation rights to the Department for the Department's efforts of recovery from any other party for monies paid by the Department as a result of any claim under this Provision. The Contractor shall fully cooperate with the Department in its efforts to recover from another party any money paid to the Contractor for delay damages under this Provision."

WORKING DAYS (BDE)

Effective: January 1, 2002

The Contractor shall complete the work within **20** working days.

STATE OF ILLINOIS

DEPARTMENT OF TRANSPORTATION
PLANS FOR PROPOSED ROADWORK

Sheet 1 of 31 *

* 31-1-30

FAI 39 (I-39)

C-92-021-11

D-92-119-10

D2 Patching 2011-2

Ogle County

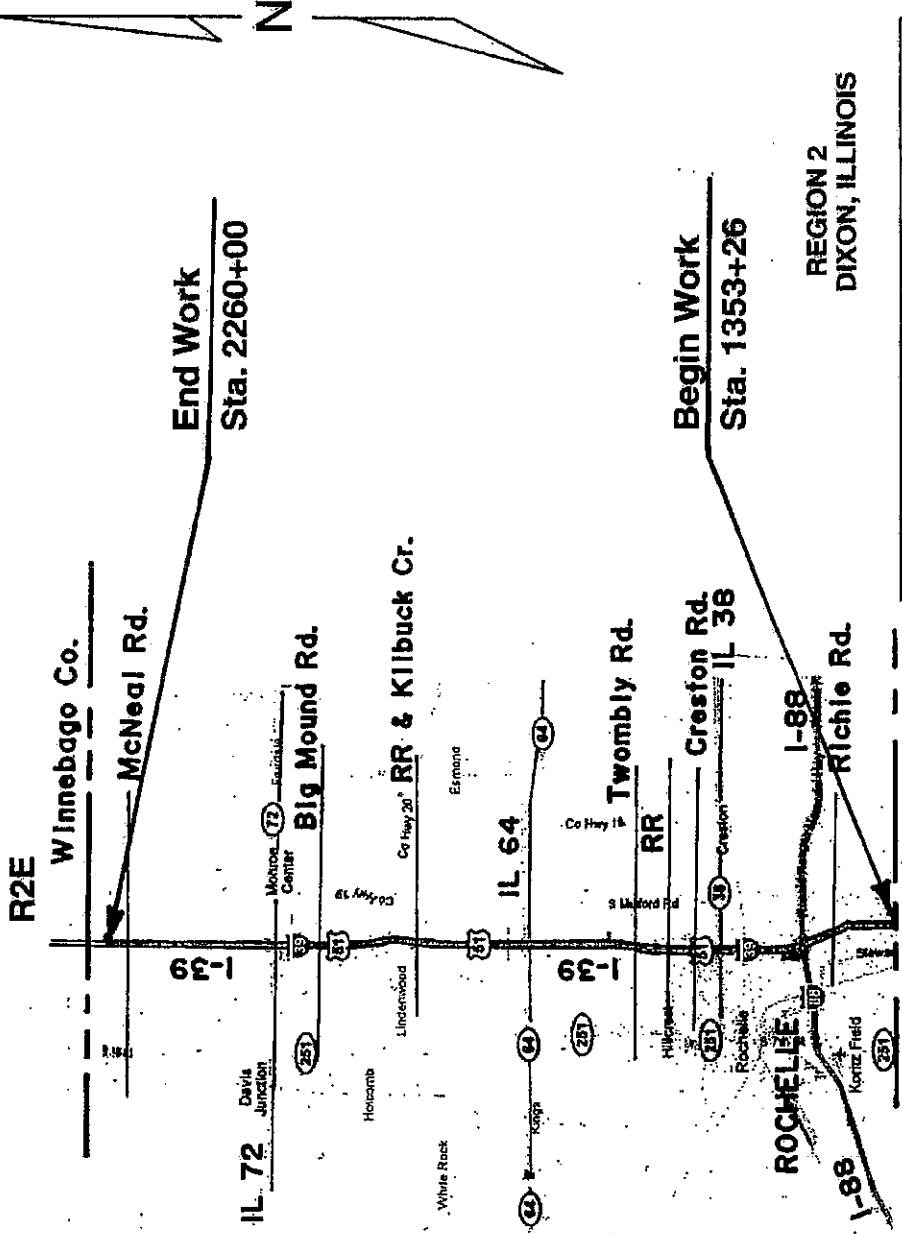

REGION 2
DIXON, ILLINOIS

STATE OF ILLINOIS
DEPARTMENT OF TRANSPORTATION
DIVISION OF HIGHWAYS

SUBMITTED *March 29, 2011*

DEPUTY DIRECTOR OF HIGHWAYS, REGION 2 ENGINEER

MONROE TWP. Sec. 5, 29, 32

LYNNVILLE TWP. Sec. 8, 9

DEMENT TWP. Sec. 8, 17, 20, 29, 32

Gross Length of Project = 90,674' = 17.173 Miles.

Net Length of Project = 1,573' = 0.298 Mile.

INDEX OF SHEETS

- 1. Cover Sheet
- Index of Sheets
- 2-3 Summary of Quantities
- 4-5 General Notes
- 6-13 Typical Sections
- 14-20 Plan Sheet
- 21-25 Schedule of Work
- 26. (This sheet was removed)
- 27-31 District Standards
(41.1, 44.1, 91.2)

STANDARDS

- 442001-05
- 701101-02
- 701400-05
- 701401-06
- 701411-07
- 701426-04
- 701901-01
- 720001-01
- 720011-01
- 728001-01
- 729001-01
- 780001-02
- 781001-03

CONTRACT NUMBER 64G53

CALL J.U.L.I.E. BEFORE YOU DIG

800-892-0123

File Name: Patching2011-2

SUMMARY OF QUANTITIES

Construction Code 0005
100% STATE

CODE NUMBER	ITEM	UNIT	QUANTITY
40600755	POLYMERIZED LEVELING BINDER, (HAND METHOD), N105	TON	5
40600855	POLYMERIZED LEVELING BINDER, (MACHINE METHOD), N105	TON	148
40603575	POLYMERIZED HOT-MIX ASPHALT SURFACE COURSE, MIX "E", N105	TON	343
40600990	TEMPORARY RAMP	SQ YD	267
44000155	HOT-MIX ASPHALT SURFACE REMOVAL, 1-1/2"	SQ YD	1,518
44213000	PATCHING REINFORCEMENT	SQ YD	83
44213200	SAW CUTS	FOOT	334
67100100	MOBILIZATION	L SUM	1
70100420	TRAFFIC CONTROL AND PROTECTION, STANDARD 701411	EACH	1
70100800	TRAFFIC CONTROL AND PROTECTION, STANDARD 701401	L SUM	1
70300100	SHORT TERM PAVEMENT MARKING	FOOT	472
70301000	WORK ZONE PAVEMENT MARKING REMOVAL	SQ FT	53
* 78001110	PAINT PAVEMENT MARKING - LINE 4"	FOOT	5,922
* 78100100	RAISED REFLECTIVE PAVEMENT MARKER	EACH	21

** Specialty Items*

GENERAL NOTES

When laying out for patching, the minimum distance between new patches (saw cut to saw cut) shall be 15 feet. When patch spacing is less than 15 feet, the pavement between patches shall also be removed and replaced.

All mandatory joint sealing for Class A, Class B and Class B (Hinge Jointed) patches as shown on the plans will not be measured for payment. Optional sawing of the joint for the sealant reservoir will not be measured for payment.

For all concrete patching that will not be resurfaced, the concrete shall be struck off flush with the existing pavement surface at each end of the patch.

The Engineer reserves the right to check all patches for smoothness by the use of a 10' rolling straight edge set to a 3/16' tolerance in the wheel paths. Any patch areas higher than 3/16" must be ground smooth with an approved grinding device consisting of multiple saws. The use of bushhammer or other impact devices will not be permitted. Any patch with depressions greater than 3/16" shall be repaired in a manner approved by the Engineer.

The mandatory saw cuts for pavement patching are:

Class A Patch: Cut two transverse saw cuts at each end of the patch; one full depth and one partial depth. The longitudinal edges of the patch shall be cut full depth. When the patch is adjacent to a pcc shoulder, two saw cuts along the shoulder will be required.

The mandatory saw cuts will be paid for at the contract unit price per Foot for SAW CUTS.

The area to be primed shall be limited to that which can be covered with HMA the same day, unless otherwise permitted by the Engineer.

NOTE:

Bituminous and Aggregate prime coat shall be placed in accordance with Section 406 of the Standard Specifications. The cost of the prime coats shall be included in the contract unit price per ton for POLYMERIZED LEVELING BINDER (MACHINE METHOD) of the type specified.

If this project is in progress at the same time as another project, work shall be scheduled to keep interference between projects to a minimum. The contractors shall inform each other of progress of the projects and give fair warning to the other contractors when a problem might be encountered.

GENERAL NOTES (Continued)

The Following Mixture Requirements are Applicable for all Locations in the Project.

Mixture Uses	Surface	Level Binder
PG:	SBS PG 70-22	SBS PG 70-22
Design Air Voids	4.0 @ N105	4.0 @ N105
Mixture Composition (Gradation Mixture)	IL 9.5 or 12.5	IL 9.5
Friction Aggregate	E	N/A
20 Year ESAL	31.8	31.8
Mixture Unit Weight	119 lbs/sy/in	

Tie bars shall be installed to tie PCC appurtenance to adjacent existing concrete pavement.

Tie the following
to the existing
concrete pavement

Length, size, and
spacing of Tie Bars

Gutter or Curb & Gutter	Std. 606001	24" long No. 6 @ 24" centers
PCC Base Course	Std. 353001	24" long No. 6 @ 30" centers
PCC Pavement	Std. 420101	24" long No. 6 @ 30" centers

Tie bars to be installed in accordance with the applicable portions of Article 420.05(b) of the Standard Specifications. See Highway Standard 420001 for detail on longitudinal construction joint grouted-in-place tie bar. The tie bars will be paid for at the contract unit price EACH for TIE BARS.

The millings from cold milling (Special) and from hot-mix asphalt surface removal, 1-1/2 inch shall become the property of the Contractor, to be properly disposed of. No grindings will be allowed on the foreslopes. This work shall be included in the contract unit price per SQ. YD. for COLD-MILLING (SPECIAL) or per SQ. YD. for HOT-MIX ASPHALT SURFACE REMOVAL, 1-1/2 INCH.

The Contractor will be required to furnish 5-1/2 high brass stencils as approved by the Engineer and install stationing at 250' intervals. Stationing shall be placed on both lanes of 2-lane highways and on the outside lanes on 4-lane highways. The stations shall be placed 6" inside the pavement marking edge so they can be read from the shoulder. This work will be included in the cost of the final pavement surface.

TYPICAL SECTIONS

I-39

(Southbound)

FAI 39 (I-39)
 D2 Patching 2011-2
 Ogle County
 Sheet 6 of 31
 Contract Number: 64G53

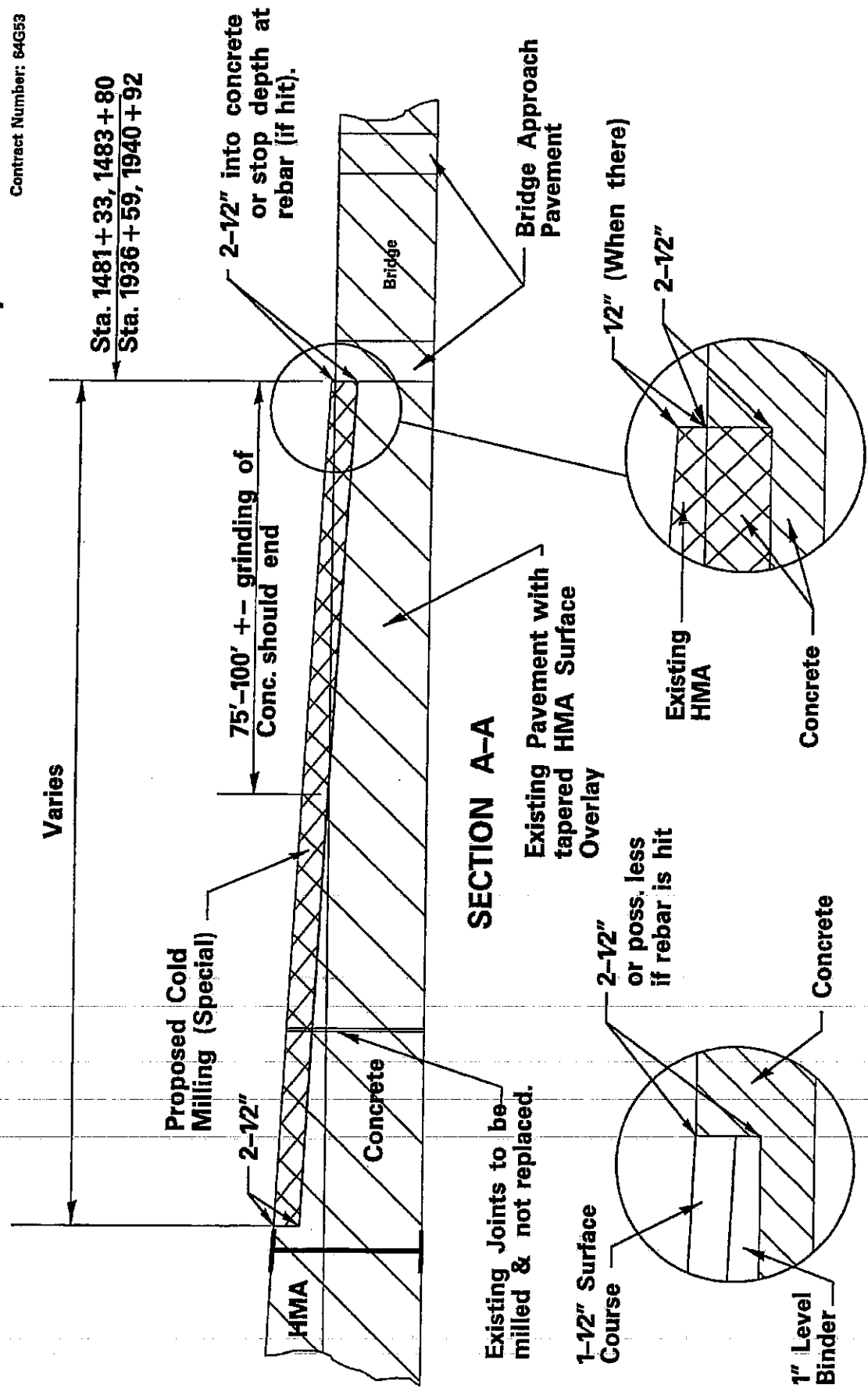

HOT-MIX ASPHALT APPLICATION RATES:
 All Hot-Mix Asphalt Mixtures: 119lb/sq. yd/finch
 Bituminous Materials (Prime Coat) = 0.000286 Ton/Sq. Yd.
 Aggregate (Prime Coat) = 0.0015 Ton/Sq. Yd.

Proposed HMA Replacement

powerdraftMRS: Patching2011-2brappro(I-39).dgn

TYPICAL SECTIONS

I-39 (Southbound)

Near McNeal Road
Sta. 2258 + 93 - 2259 + 58
&
Near Creston Road
Sta. 1464 + 18 - 1465 + 38

FAI 39
D2 Patching 2011-2
Ogle County
Sheet 7 of 31
Contract Number: 64G53

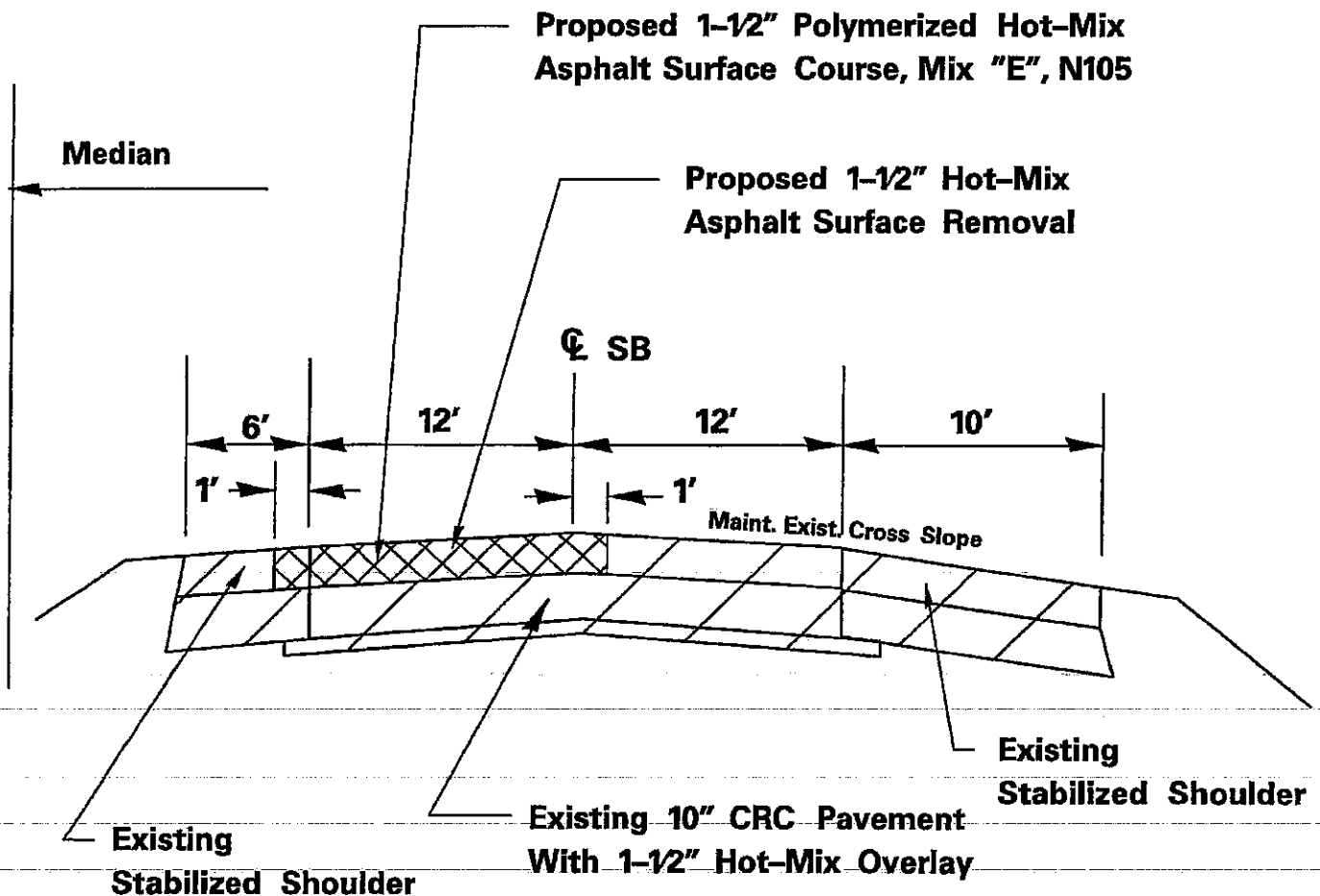

HOT-MIX ASPHALT APPLICATION RATES:
All Hot-Mix Mixtures: 119 lb/sq. yd/inch
Bituminous Materials (Prime Coat) = 0.000286 Ton/Sq. Yd.
Aggregate (Prime Coat) = 0.0015 Ton/Sq. Yd.

TYPICAL SECTIONS

I-39 (Southbound)
Near Big Mound Road
Sta. 2043+25 - 2046+70

FAI 39
D2 Patching 2011-2
Ogle County
Sheet 8 of 31
Contract Number: 64G53

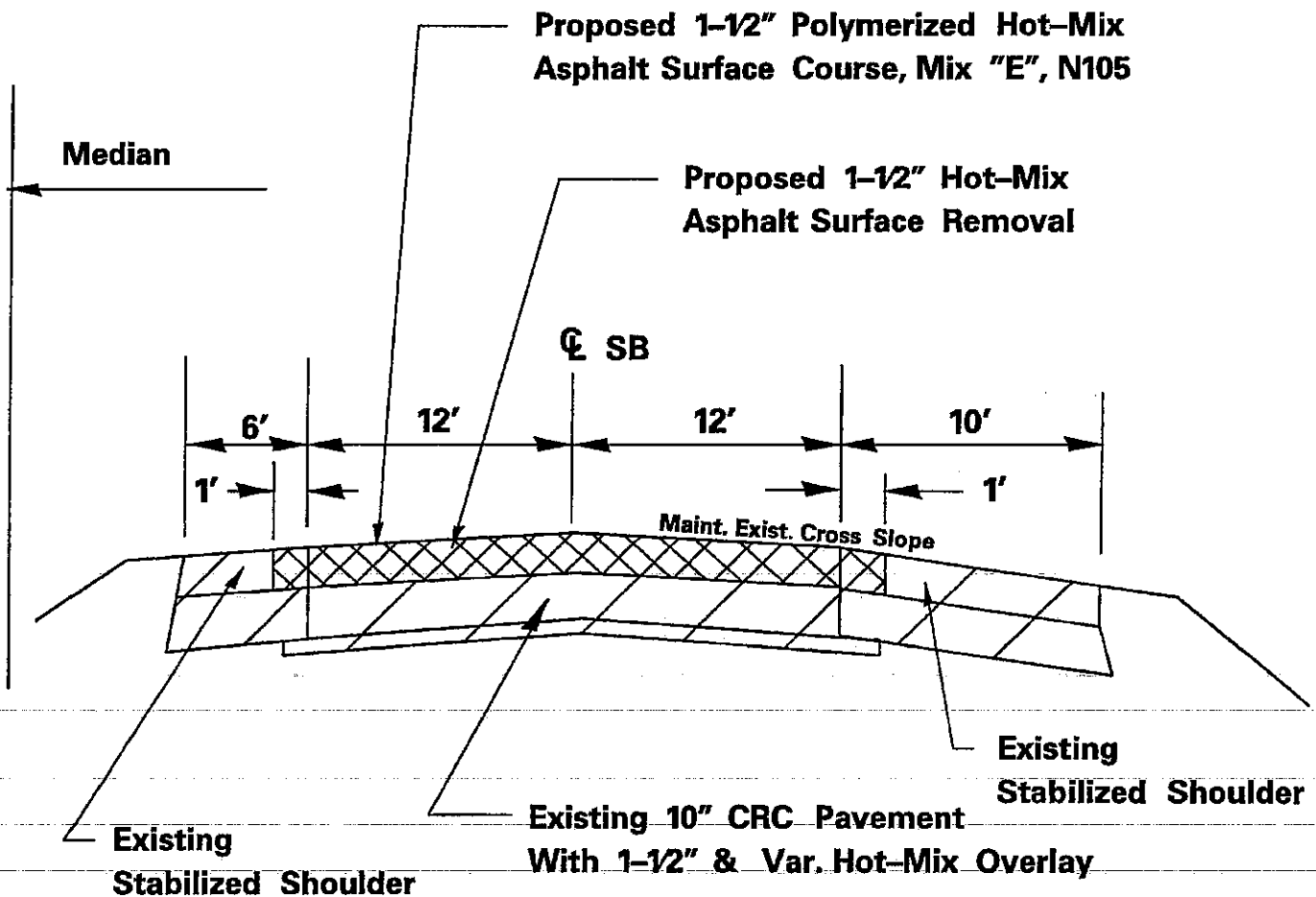

HOT-MIX ASPHALT APPLICATION RATES:

All Hot-Mix Mixtures: 119 lb/sq. yd/inch

Bituminous Materials (Prime Coat) = 0.000286 Ton/Sq. Yd.

Aggregate (Prime Coat) = 0.0015 Ton/Sq. Yd.

TYPICAL SECTIONS

FA139

D2 Patching 2011-2

Ogle County

Sheet 9 of 31

Contract Number: 64G53

I-39 Southbound

At Bridge Approaches

Sta. 1940+92 - 1942+10

* Sta. 1935+41 - 1936+59 (outside lane only)

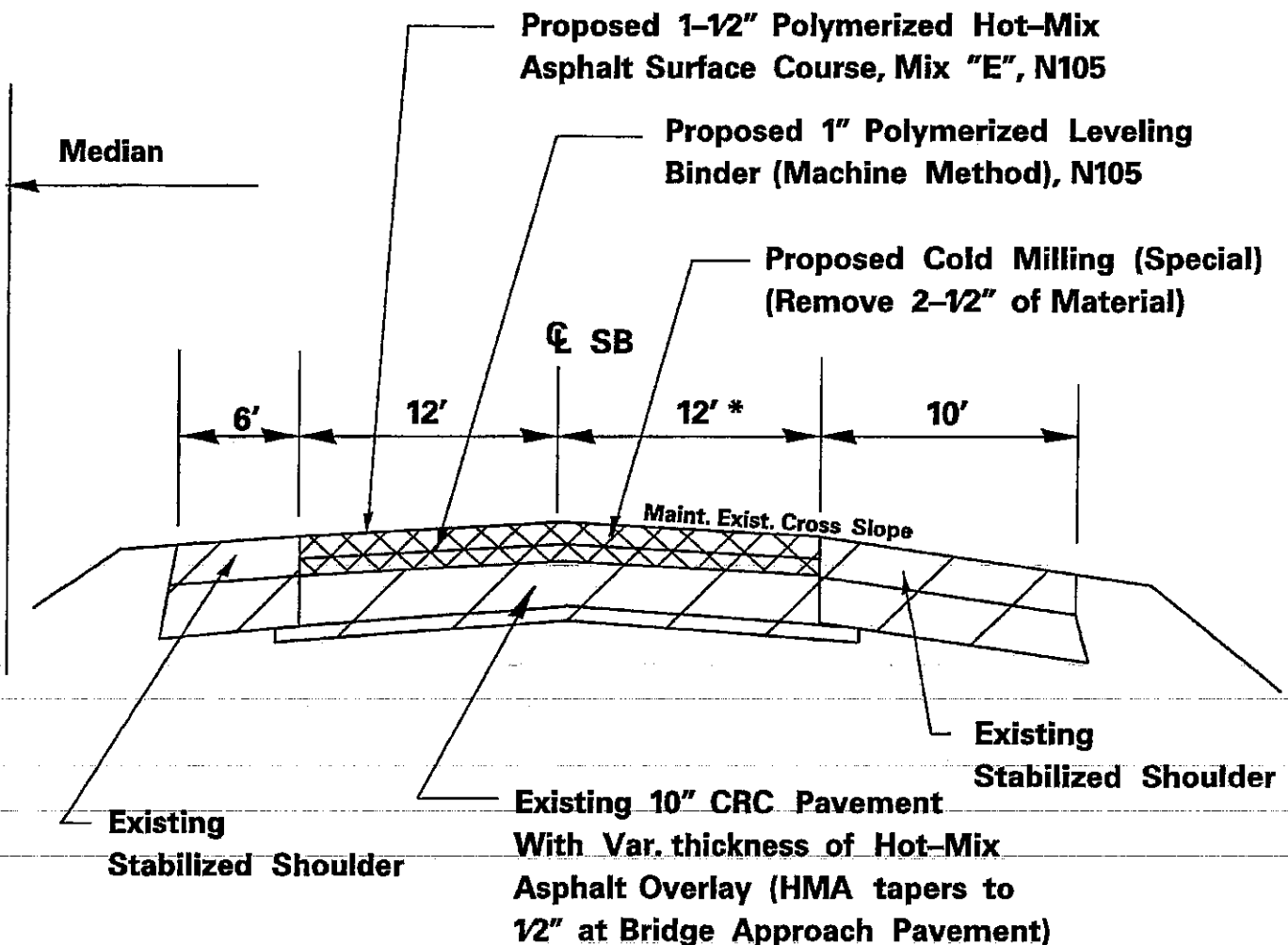

HOT-MIX ASPHALT APPLICATION RATES:

All Hot-Mix Mixtures: 119 lb/sq. yd/inch

Bituminous Materials (Prime Coat) = 0.000286 Ton/Sq. Yd.

Aggregate (Prime Coat) = 0.0015 Ton/Sq. Yd.

TYPICAL SECTIONS

**I-39 Southbound
Near Twombly Road
Sta. 1567 + 38 - 1569 + 28
Sta. 1571 + 13 - 1573 + 20**

FAI 39
D2 Patching 2011-2
Ogle County
Sheet 10 of 31
Contract Number: 64G53

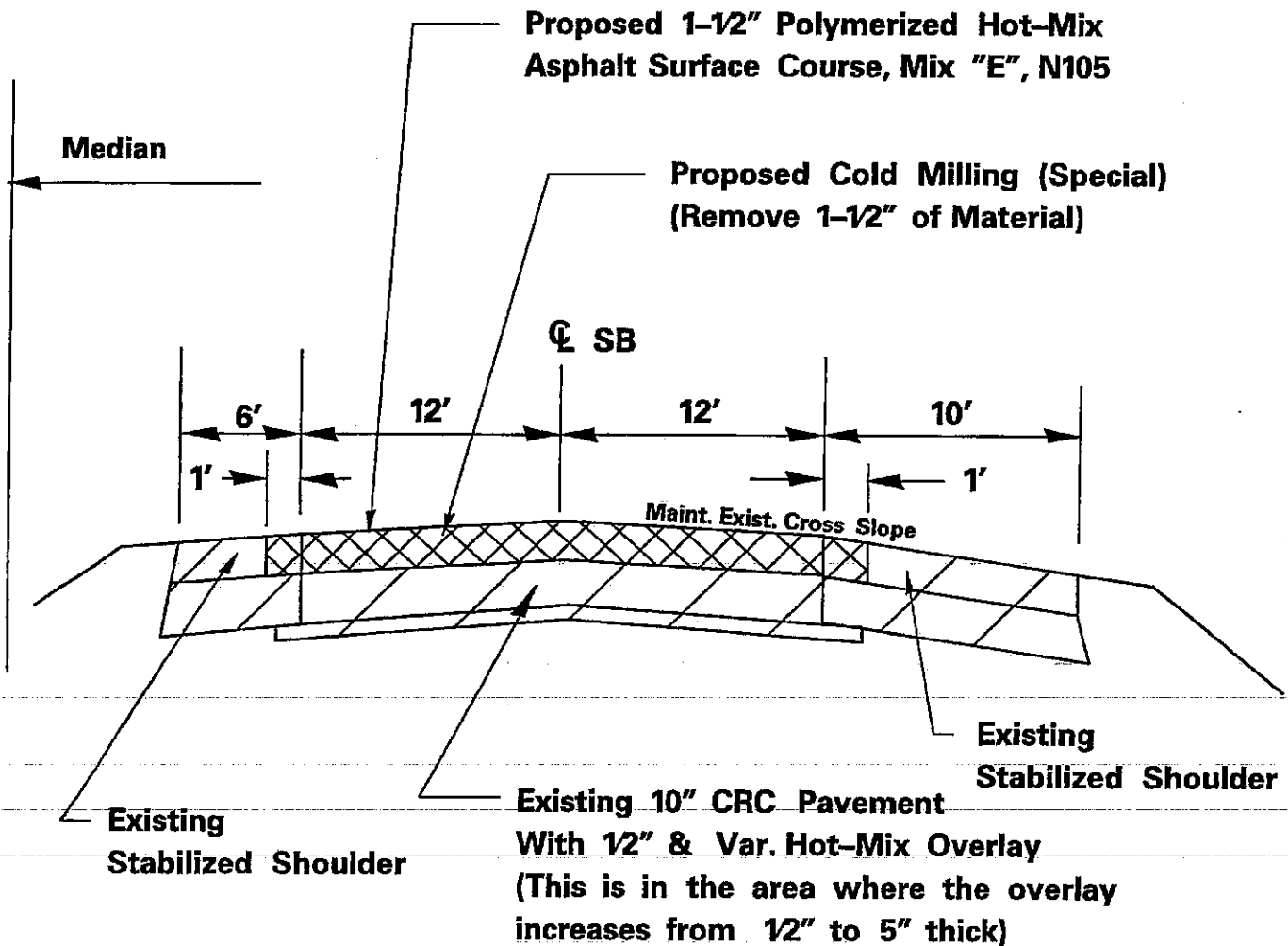

HOT-MIX ASPHALT APPLICATION RATES:
All Hot-Mix Mixtures: 119 lb/sq. yd/inch
Bituminous Materials (Prime Coat) = 0.000286 Ton/Sq. Yd.
Aggregate (Prime Coat) = 0.0015 Ton/Sq. Yd.

TYPICAL SECTIONS

FAI 39
D2 Patching 2011-2
Ogle County
Sheet 11 of 31
Contract Number: 64G53

I-39 Southbound

At Bridge Approaches

Sta. 1483+80 - 1485+10

* Sta. 1480+03 - 1481+33 (outside lane only)

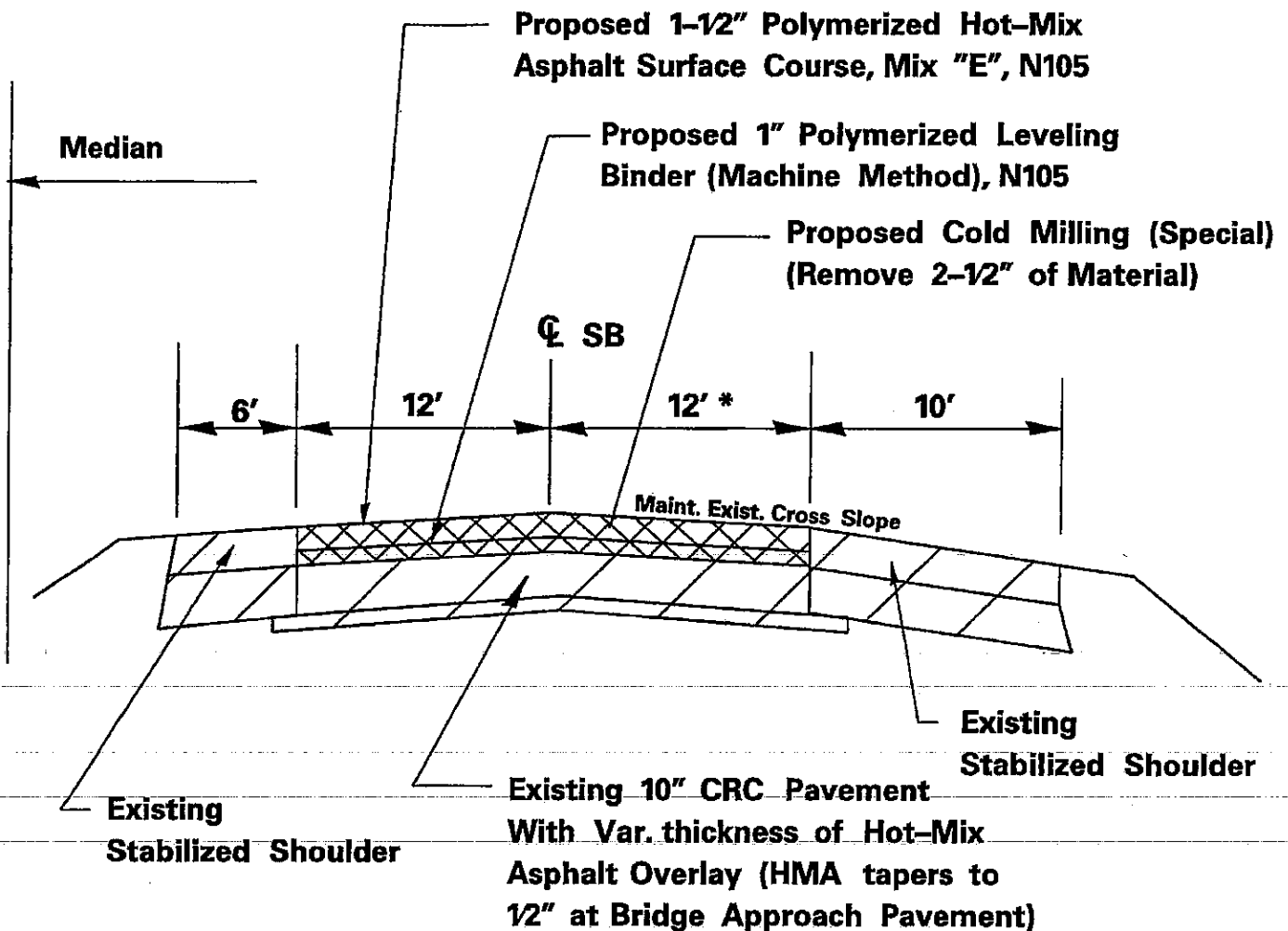

HOT-MIX ASPHALT APPLICATION RATES:

All Hot-Mix Mixtures: 119 lb/sq. yd/inch

Bituminous Materials (Prime Coat) = 0.000286 Ton/Sq. Yd.

Aggregate (Prime Coat) = 0.0015 Ton/Sq. Yd.

TYPICAL SECTIONS

I-39 (Southbound)
Near Richie Road
Sta. 1381+82 - 1383+32

FAI 39
D2 Patching 2011-2
Ogle County
Sheet 12 of 31
Contract Number: 64G53

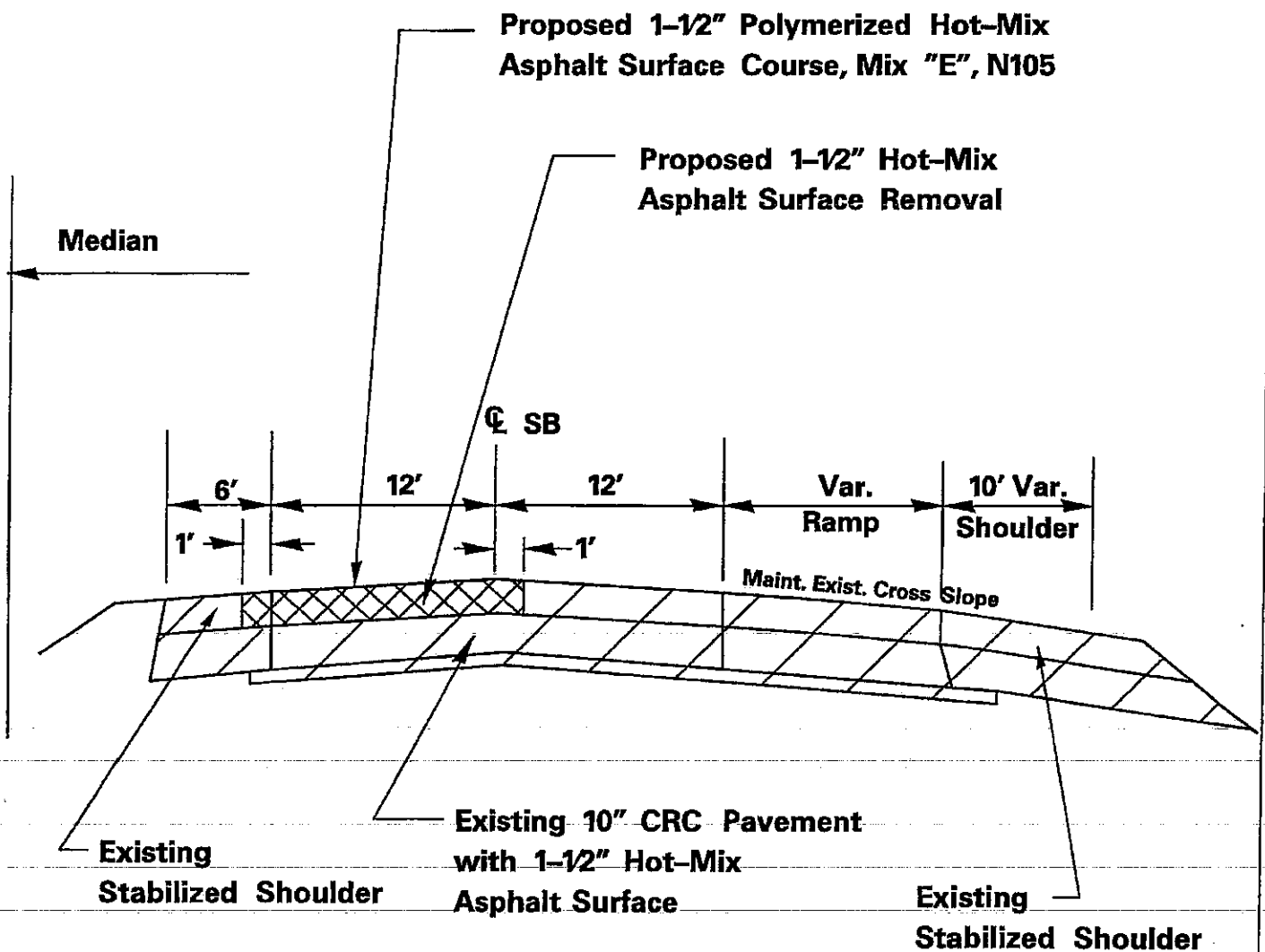

HOT-MIX ASPHALT APPLICATION RATES:
All Hot-Mix Mixtures: 119 lb/sq. yd/inch
Bituminous Materials (Prime Coat) = 0.000286 Ton/Sq. Yd.
Aggregate (Prime Coat) = 0.0015 Ton/Sq. Yd.

I-39

Typical Section

FAI 39
D2 Patching 2011-2
Ogle County
Sheet 13 of 31
Contract Number: 64G53

*

The new concrete patch will require removal of some bituminous material. The replacement patches shall be all concrete, poured to match the elevation of the existing bituminous overlay. All added costs to patch in these areas shall be considered included in the contract unit cost per Sq Yd. for CLASS A PATCHES (SPECIAL).

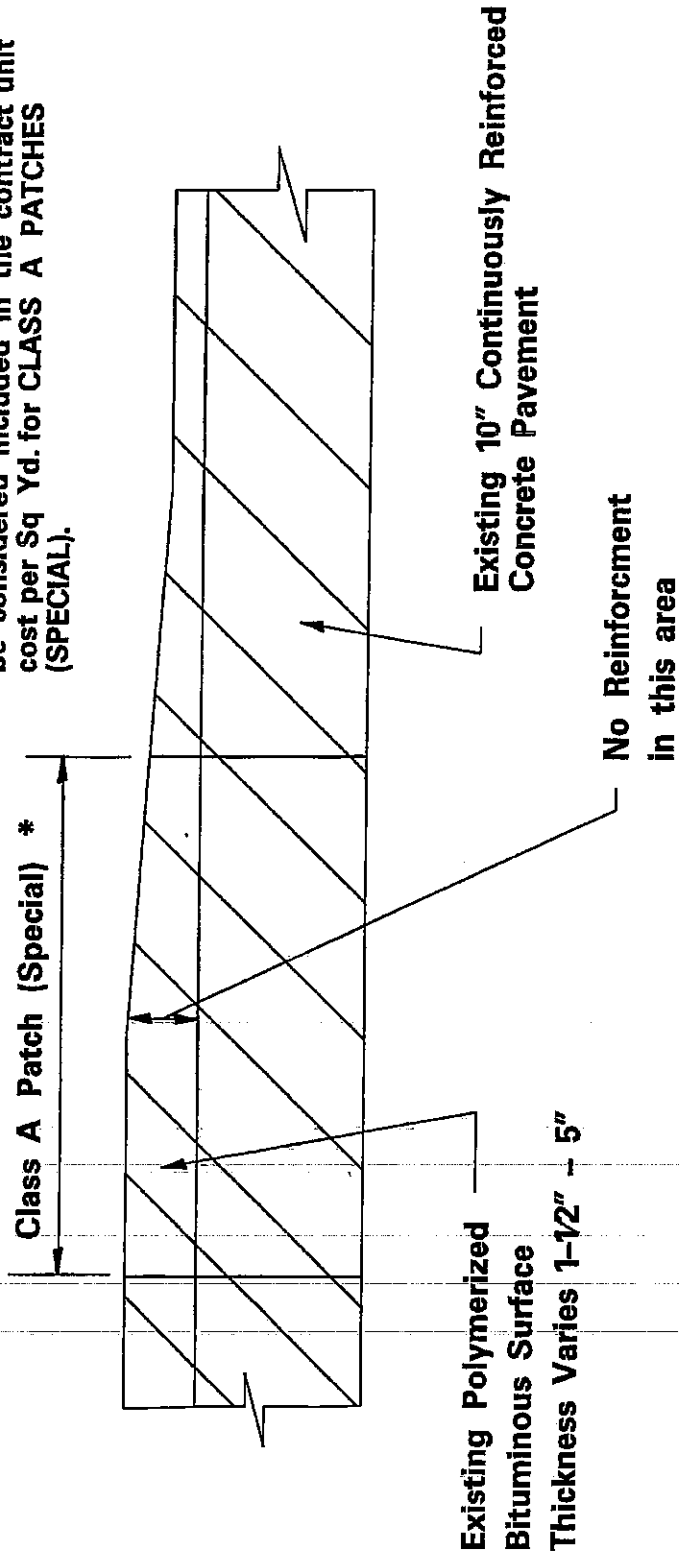

PLAN SHEET

I-39 (Southbound)



FAI 39 (I-39)

D2 Patching 2011-2

Ogle County

Sheet 14 of 31

Contract Number: 64G53

2259 + 58

Proposed Hot-Mix Asphalt
Surface Removal, 1-1/2"

2258 + 93

Shoulder

1'

12'

1'

Shoulder

Proposed Class A Patches (Special)
12'W x 15' L Sta. 2259 + 28
(Asphalt is 5" thick here)

McNeal Road (Over) 2257 + 04

CL I-39 SB

HOT-MIX ASPHALT APPLICATION RATES:

All Hot-Mix Mixtures: 119 lb/sq. yd/inch

Bituminous Materials (Prime Coat) = 0.000286 Ton/Sq. Yd.

Aggregate (Prime Coat) = 0.0015 Ton/Sq. Yd.

powerdraft: patching2011-2plansheet6.dgn

PLAN SHEET I-39 (Southbound)

FAI 39 (I-39)

D2 Patching 2011-2

Ogle County

Sheet 16 of 31

Contract Number: 64053

I-39 Over RR & Kibuck Cr.



Proposed Cold Milling (Special)
(Remove 2-1/2" of Material,
some will be Concrete)

Proposed Cold Milling (Special)
(Remove 2-1/2" of Material,
some will be Concrete)

Existing Joint to
be milled & Not
Replaced

Existing Joint to
be milled & Not
Replaced

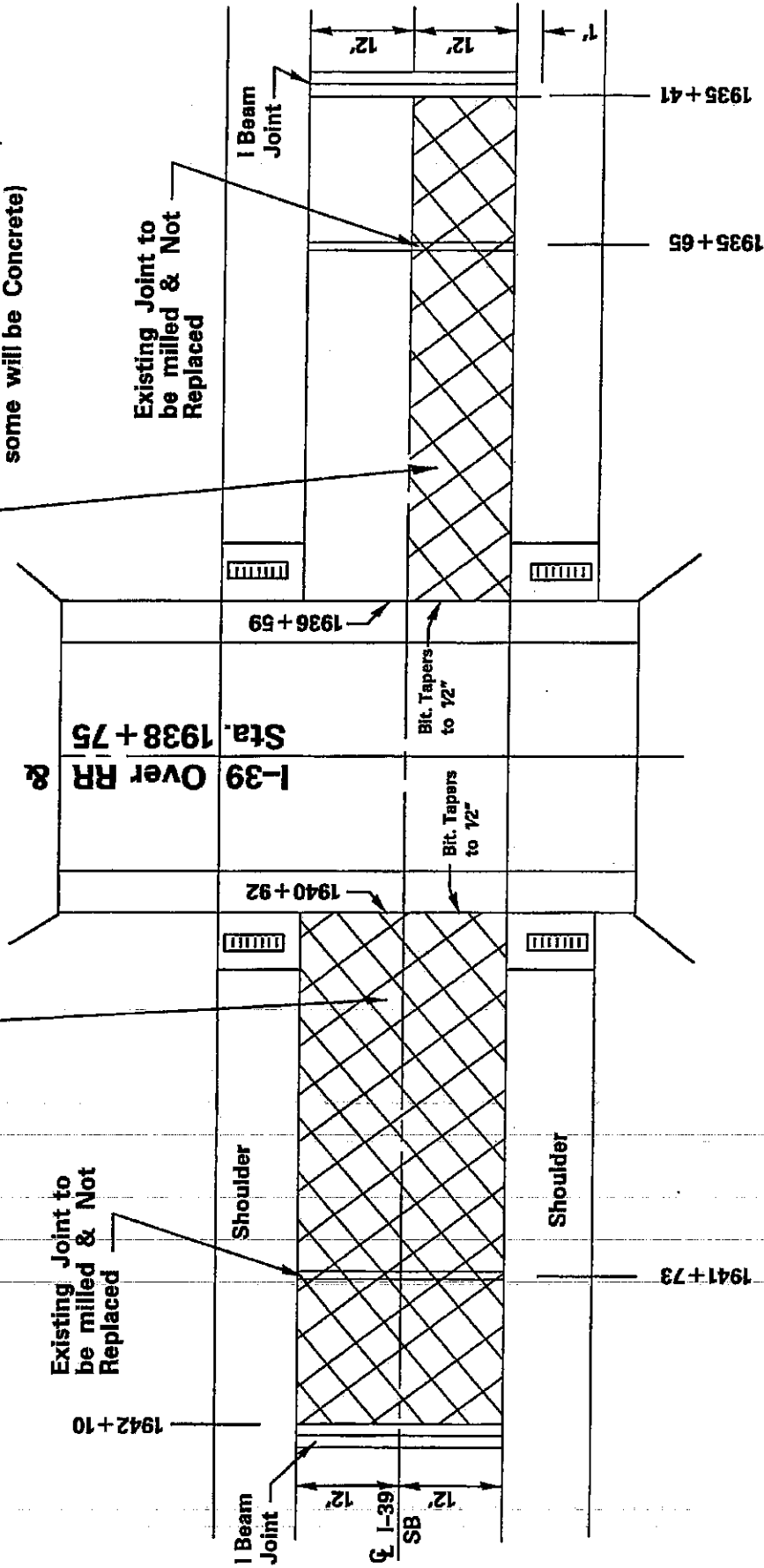

HOT-MIX ASPHALT APPLICATION RATES:
All Hot-Mix Asphalt Mixtures: 119 lb/sq. yd/inch
Bituminous Materials (Prime Coat) = 0.000286 Ton/Sq. Yd.
Aggregate (Prime Coat) = 0.0015 Ton/Sq. Yd.

PLAN SHEET

I-39 (Southbound)

FAI 39 (I-39)

D2 Patching 2011-2

Ogle County

Sheet 17 of 31

Contract Number: 64353

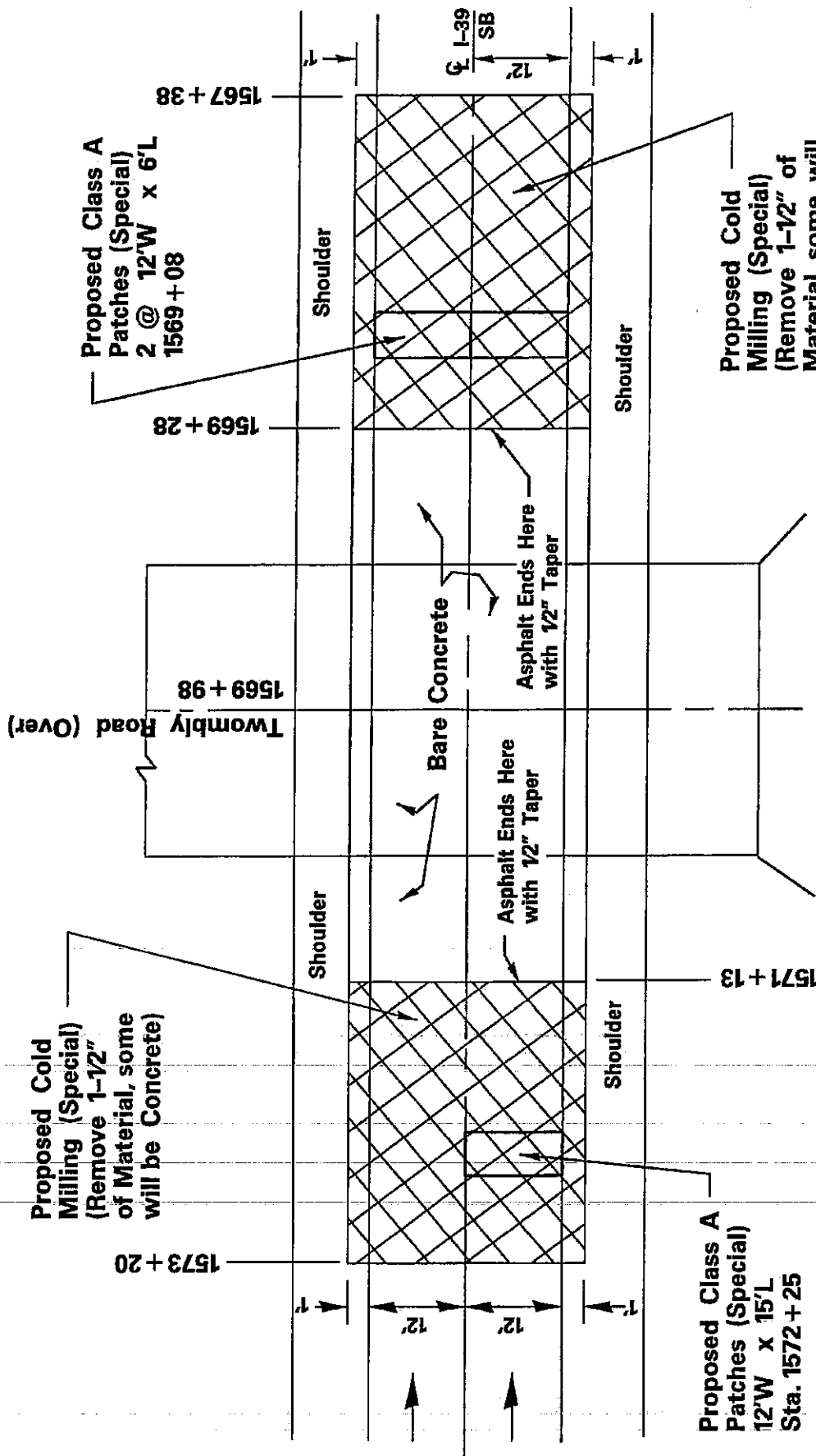

Proposed Cold Milling (Special) (Remove 1-1/2" of Material, some will be Concrete)

Proposed Class A Patches (Special) 2 @ 12'W x 6'L 1569+08

Proposed Class A Patches (Special) 12'W x 15'L Sta. 1572+25

Proposed Cold Milling (Special) (Remove 1-1/2" of Material, some will be Concrete)

HOT-MIX ASPHALT APPLICATION RATES:
All Hot-Mix Asphalt Mixtures: 119 lb/sq. yd/inch
Bituminous Materials (Prime Coat) = 0.000286 Ton/Sq. Yd.
Aggregate (Prime Coat) = 0.0015 Ton/Sq. Yd.

PLAN SHEET

I-39 (Southbound)

FAI 39 (I-39)
DZ Patching 2011-2
Ogle County
Sheet 18 of 31
Contract Number: 64G53

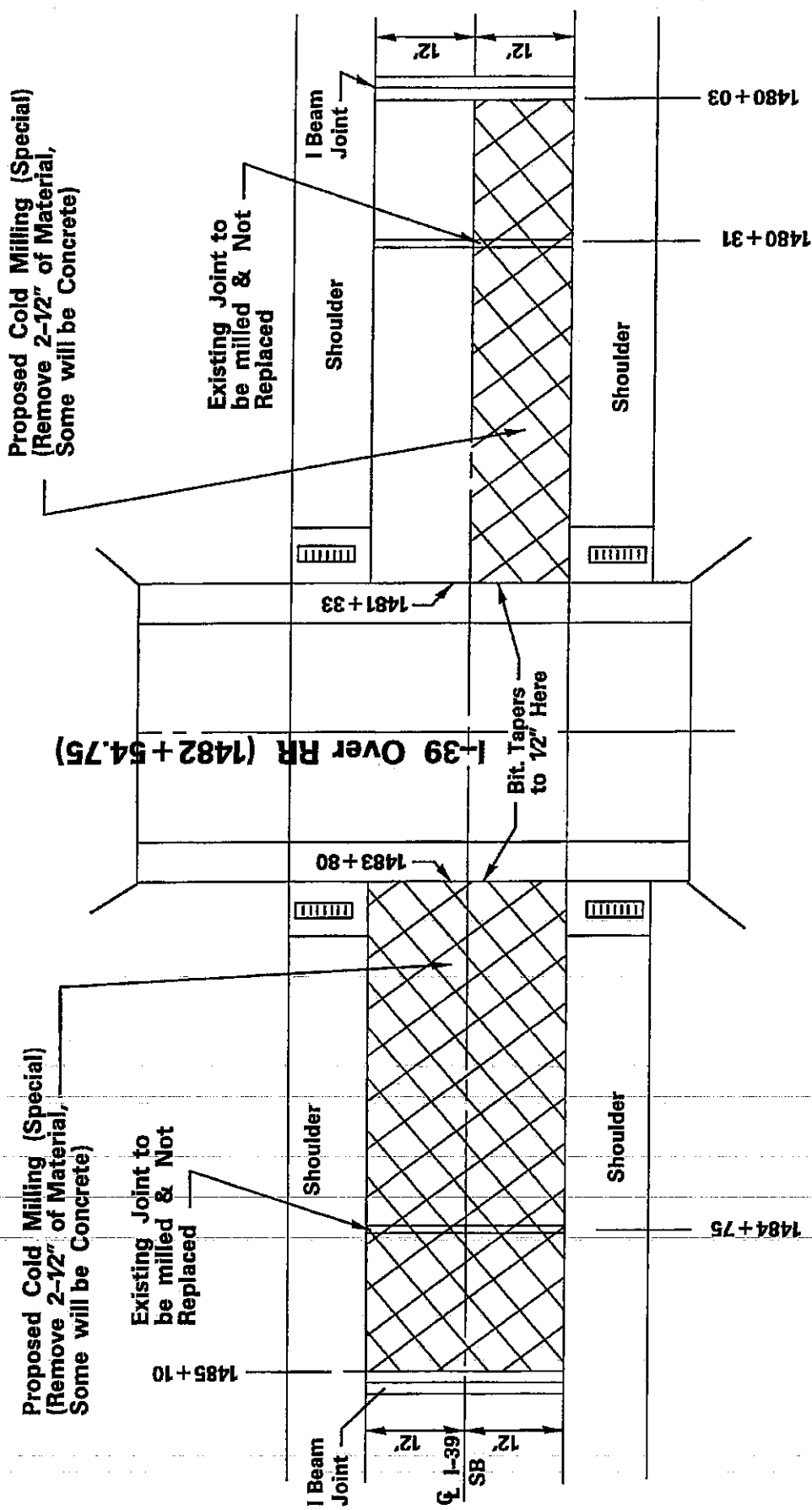

HOT-MIX ASPHALT APPLICATION RATES:
All Hot-Mix Asphalt Mixtures: 119 lb/sq. yd/inch
Bituminous Materials (Prime Coat) = 0.000286 Ton/Sq. Yd.
Aggregate (Prime Coat) = 0.0015 Ton/Sq. Yd.

PLAN SHEET

I-39 (Southbound)

FAI 39 (I-39)

D2 Patching 2011-2

Ogle County

Sheet 19 of 31

Contract Number: 64G53

Creston Road
(Over) 1464 + 18

Proposed Hot-Mix
Asphalt Surface
Removal, 1-1/2"

1465 + 38

Shoulder

1'

12'

Shoulder

Asphalt Thickness Increases
From 1-1/2" to 5"

1465 + 33

1-1/2" Asphalt

I-39 SB

HOT-MIX ASPHALT APPLICATION RATES:
All Hot-Mix Asphalt Mixtures: 119lb/sq. yd/finch
Bituminous Materials (Prime Coat) = 0.000286 Ton/Sq. Yd.
Aggregate (Prime Coat) = 0.0015 Ton/Sq. Yd.

PLAN SHEET

I-39 (Southbound)

FAI 39 (I-39)
D2 Patching 2011-2
Ogle County
Sheet 20 of 31
Contract Number: 64G53

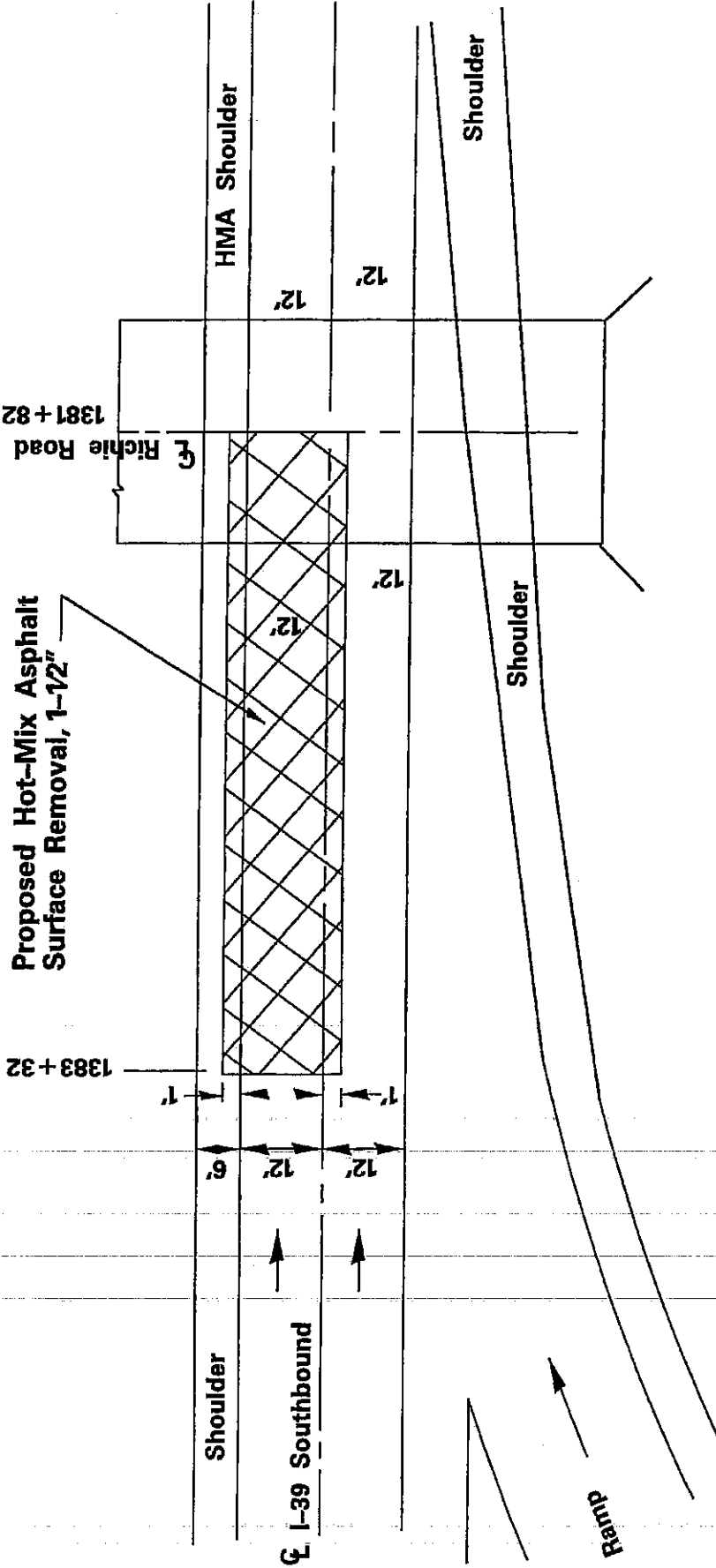

HOT-MIX ASPHALT APPLICATION RATES:
All Hot-Mix Asphalt Mixtures: 119lb/sq. yd/inch
Bituminous Materials (Prime Coat) = 0.000286 Ton/Sq. Yd.
Aggregate (Prime Coat) = 0.0015 Ton/Sq. Yd.

Schedule of Work

Raised Reflective Pavement Marker

Location (Maintain the 80' center to center Spacing with existing adjacent markers) (one-way Crystal)	Each
Sta. 2259+58 – 2258+93	1
Sta. 2046+70 – 2043+25	6
Sta. 1942+10 – 1940+92	1
Sta. 1936+59 – 1935+41	2
Sta. 1573+20 – 1572+13	3
Sta. 1569+28 – 1567+38	2
Sta. 1485+10 – 1483+80	2
Sta. 1481+33 – 1480+03	2
Sta. 1465+38 – 1464+18	<u>2</u>
Total	21

Raised Reflective Pavement Marker Removal

Location	Each
Sta. 2259+58 – 2258+93	1
Sta. 2046+70 – 2043+25	1
Sta. 1942+10 – 1940+92	1
Sta. 1936+59 – 1935+41	2
Sta. 1573+20 – 1572+13	2
Sta. 1569+28 – 1567+38	2
Sta. 1485+10 – 1483+80	2
Sta. 1481+33 – 1480+03	1
Sta. 1465+38 – 1464+18	<u>2</u>
Total	14

Schedule of Work (Continued)

<u>Temporary Ramp</u> Location	Sq. Yd.
Sta. 2259+58 (14') (Pass Lane)	7.8
Sta. 2258+93 (14') (Pass Lane)	7.8
Sta. 2046+70 (26')	14.5
Sta. 2043+25 (26')	14.5
Sta. 1942+10 (24')	22.1
Sta. 1940+92 (24')	22.1
Sta. 1936+59 (24') (Drive Lane)	11.1
Sta. 1935+41 (24') (Drive Lane)	11.1
Sta. 1573+20 (26')	14.5
Sta. 1571+13 (26')	14.5
Sta. 1569+28 (26')	14.5
Sta. 1567+38 (26')	14.5
Sta. 1485+10 (24')	22.1
Sta. 1483+80 (24')	22.1
Sta. 1481+33 (12')(Drive Lane)	11.1
Sta. 1480+03 (12') (Drive Lane)	11.1
Sta. 1465+38 (14') (Pass Lane)	7.8
Sta. 1464+18 (14')(Pass Lane)	7.8
Sta. 1383+32 (14')(Pass Lane)	7.8
Sta. 1381+82 (14')(Pass Lane)	7.8
Total	266.6

FAI 39

D2 Patching 2011-2

Ogle County

Sheet 27 of 31

Contract Number: 64G53

TYPICAL PAVEMENT MARKINGS

TYPICAL PAVEMENT MARKING FOR FLUSH MEDIAN AT LEFT TURN LANE

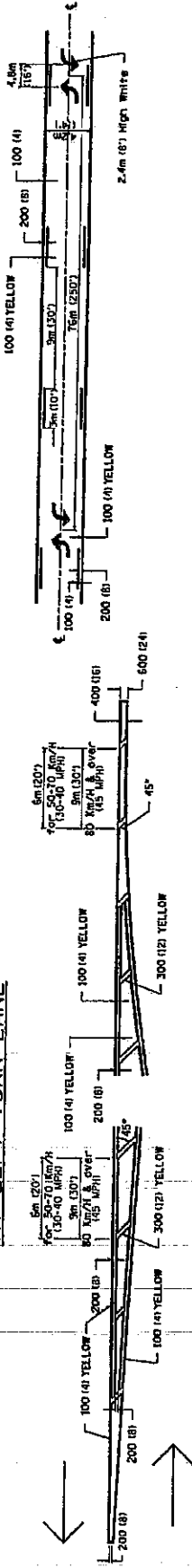

MEDIAN PAVEMENT MARKING

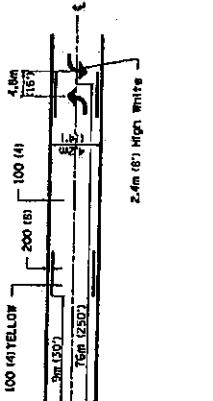

TYPICAL ISLAND OFFSET SHOULDER WIDTH

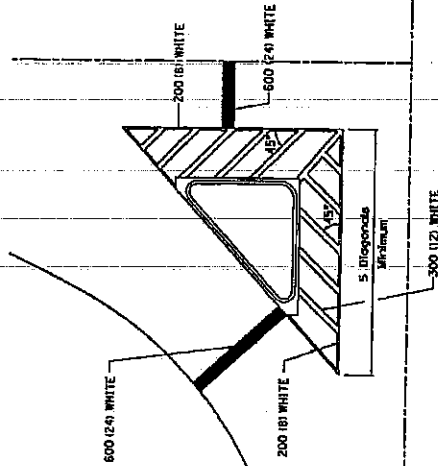

TYPICAL PARKING SPACING

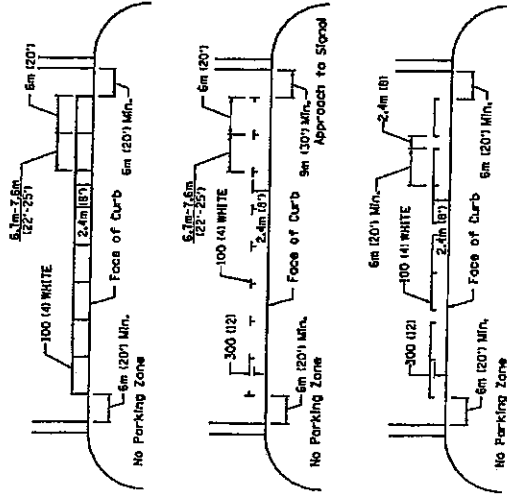

** ALL DIMENSIONS ARE IN MILLIMETERS (INCHES) UNLESS OTHERWISE NOTED.

STANDARD CROSSWALK MARKING

See Schedules for Locations

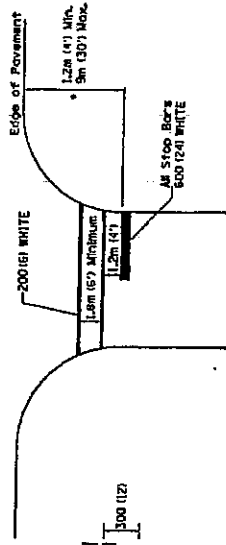

* Distances to the nearest edge of the intersecting roadway in the absence of a marked crosswalk.

FILE NAME	64G53.DWG	REVISED	10-21-08
DESIGNED		REVISED	
CHECKED		REVISED	
DATE		REVISED	

STATE OF ILLINOIS
DEPARTMENT OF TRANSPORTATION

REGION	2 / DISTRICT	2 STANDARD
SHEET NO.	27	OF 31
CONTRACT NO.	64G53	

FAI 39

D2 Patching 2011-2
 Ogle County
 Sheet 28 of 31
 Contract Number: 64G53

TYPICAL PAVEMENT MARKINGS

ARROW LAYOUT

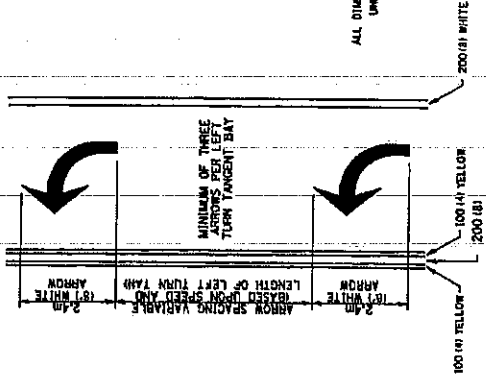

- ▲ ONE-WAY ARROW MARKER
- ◀ ONE-WAY ARROW MARKER
- ◊ TWO-WAY ARROW MARKER
- ◆ AMBER MARKER

ALL DIMENSIONS ARE IN MILLIMETERS (INCHES) UNLESS OTHERWISE NOTED.

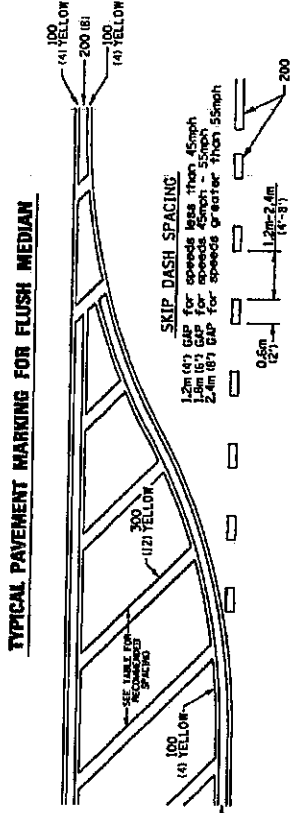

RECOMMENDED SPACING BETWEEN DIAGONALS (IN FEET)

Speed Limit Range	Continuous Median Area	Intersection Channelization	Objects (Microdots)
less than 50km/h (30MPH)	15.3m (50')	4.53m (15')	3.05m (10')
50-60km/h (30-40MPH)	22.9m (75')	6.1m (20')	4.53m (15')
70km/h (45MPH) & over	22.9m (75')	9.05m (30')	6.1m (20')

NOTE: If the spacing recommended in the Table does not permit at least five diagonal lines in the area being marked, the spacing from the next lowest speed range should be used. The recommended spacing is measured parallel to the pavement center line.

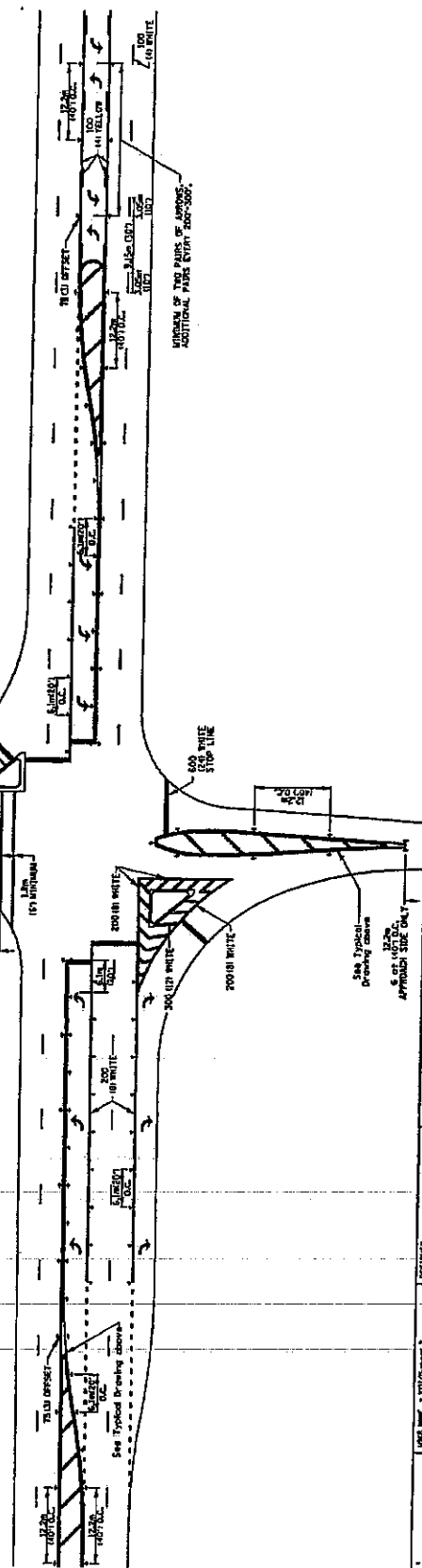

STATE OF ILLINOIS DEPARTMENT OF TRANSPORTATION	REGION 1 / DISTRICT 2 STANDARD	SHEET NO. OF SHEETS	SECTION	COUNT	LOWEY SHEET NO.
DATE	DATE	DATE	DATE	DATE	DATE
DESIGNED BY	CHECKED BY	DATE	DATE	DATE	DATE
SCALE	SCALE	SCALE	SCALE	SCALE	SCALE
CONTRACT NO.	CONTRACT NO.	CONTRACT NO.	CONTRACT NO.	CONTRACT NO.	CONTRACT NO.

FAI 39
 D2 Patching 2011-2
 Ogle County
 Sheet 29 of 31
 Contract Number: 64G53

TYPICAL PAVEMENT MARKINGS

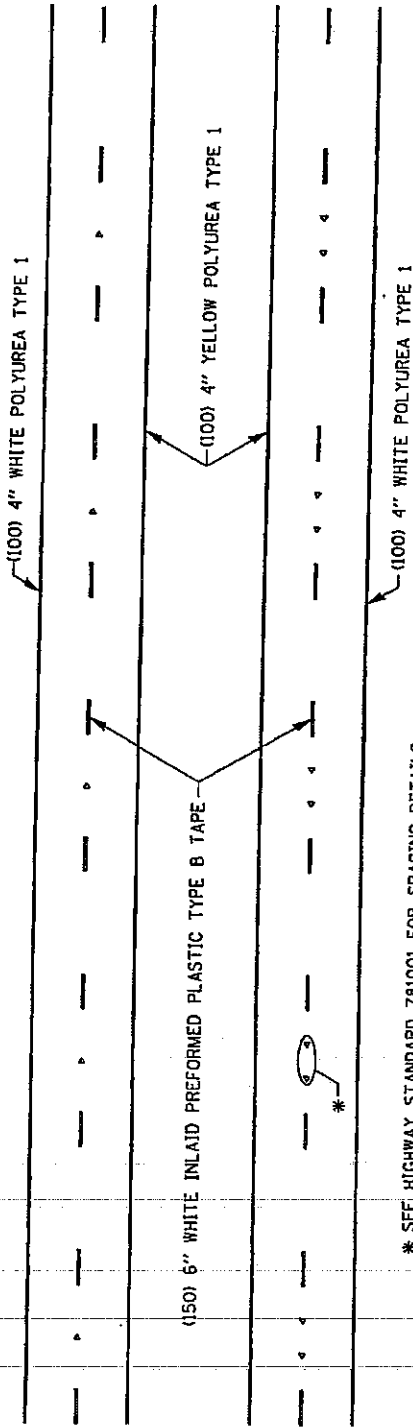

* SEE HIGHWAY STANDARD 781001 FOR SPACING DETAILS.
 USE DOUBLE MARKERS WHEN ADT \geq 25,000.

MULTI-LANE / DIVIDED

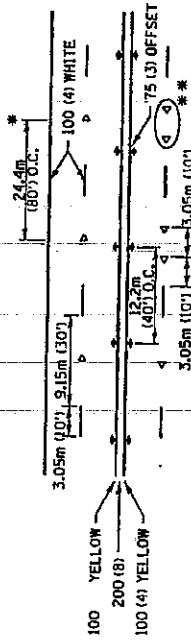

* REDUCE TO 12.2m (40') O.C. ON CURVES WHERE ADVISORY SPEEDS ARE 15km/H (10MPH) LOWER THAN POSTED SPEEDS.
 ** USE DOUBLE MARKERS WHEN ADT \geq 25,000

MULTI-LANE / UNDIVIDED

DESIGNED BY	DATE	REVISED BY	DATE
ADT 1000	10-21-08	ADT 1000	10-21-08
ADT 1000	10-21-08	ADT 1000	10-21-08
ADT 1000	10-21-08	ADT 1000	10-21-08

STATE OF ILLINOIS		PERSON 2 / DISTRICT 2 STANDARD	
DEPARTMENT OF TRANSPORTATION		SECTION	
SHEET NO.	SHEET 1 OF 3	SECTION	COUNTY
PROJECT NO.	64G53	SECTION	COUNTY
TYPICAL PAVEMENT MARKINGS		SHEET 3 OF 3	

PAINTING DETAILS

FAI 39
 D2 Patching 2011-2
 Ogle County
 Sheet 30 of 31
 Contract Number: 64G53

EXIT RAMP

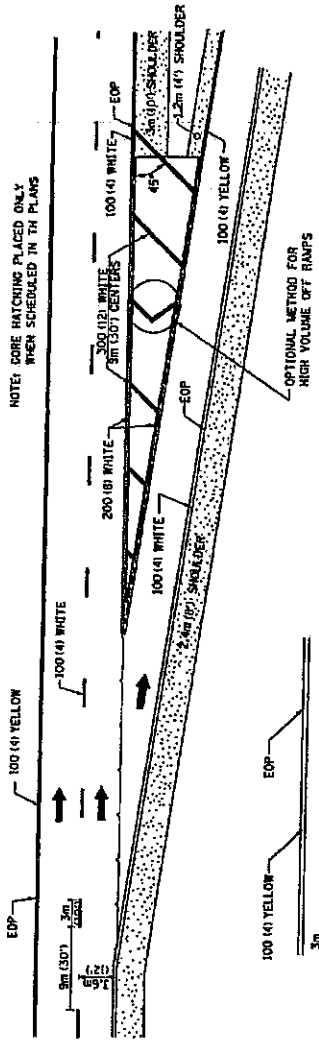

ENTRANCE RAMP

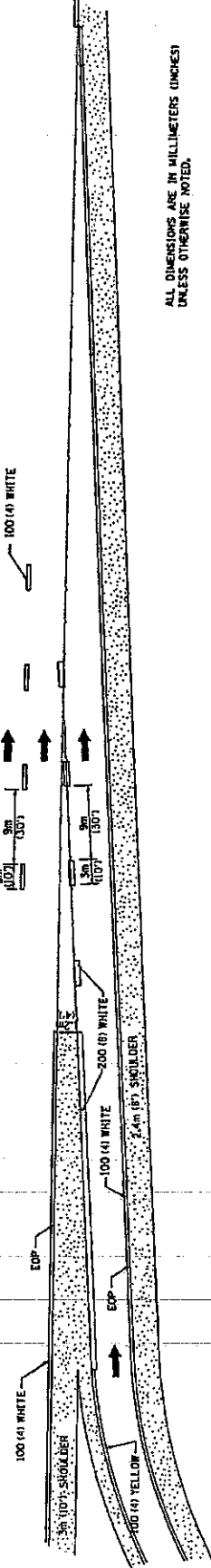

CLOVERLEAF

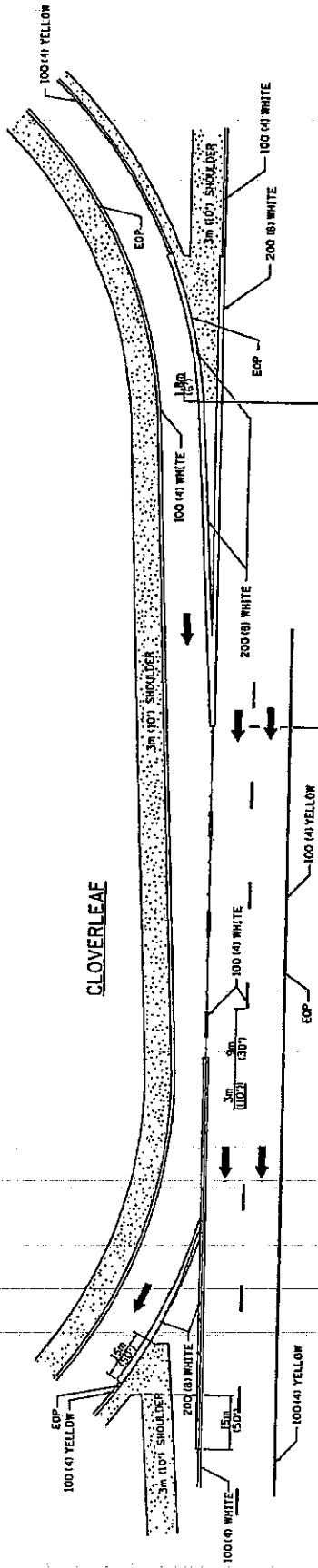

STATE OF ILLINOIS DEPARTMENT OF TRANSPORTATION	REVISION 2 / DISTRICT 2 STANDARD	SCALE	SHEET NO. OF	SHEETS	TO SET.
DATE: 11-27-07	DESIGNED BY: [blank]	SCALE: 1" = 100'	NO. OF SHEETS: 31	TOTAL SHEETS: 31	CONTRACT NO.:
PROJECT NO.:	DATE: 11-27-07	DESIGNED BY: [blank]	NO. OF SHEETS: 31	TOTAL SHEETS: 31	CONTRACT NO.:
PROJECT NO.:	DATE: 11-27-07	DESIGNED BY: [blank]	NO. OF SHEETS: 31	TOTAL SHEETS: 31	CONTRACT NO.:

ROUGH GROOVED SURFACE SIGN

FAI 39
D2 Patching 2011-2
Ogle County
Sheet 31 of 31
Contract Number: 64G53

ILLINOIS STANDARD W8-I107
SIGN PANEL TYPE 1

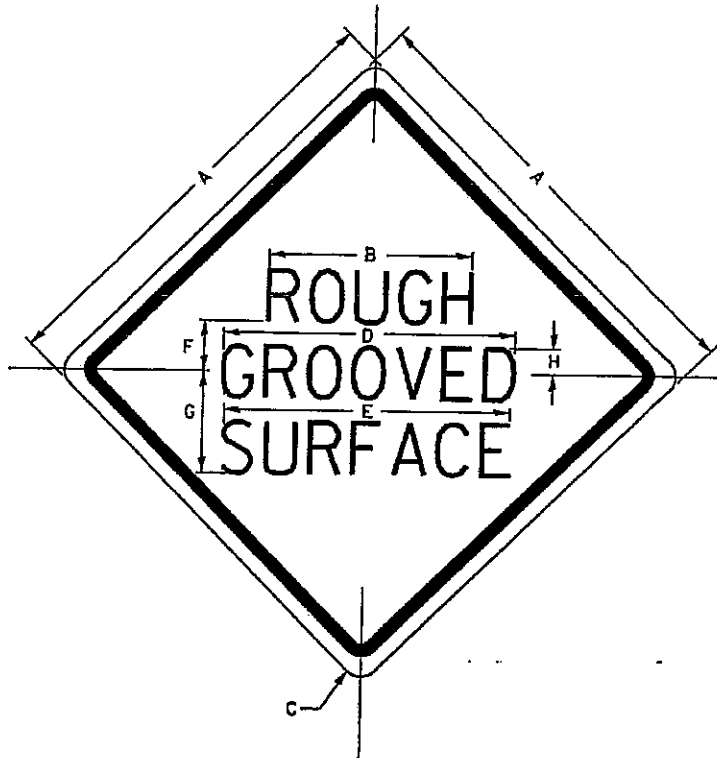

COLOR: LEGEND AND BORDER - BLACK NON-REFLECTIVE
BACKGROUND - ORANGE REFLECTORIZED

GENERAL NOTES

SIGN PANELS AND FACE MATERIALS SHALL BE ACCORDING TO SECTION 720 OF THE STANDARD SPECIFICATIONS

METAL POSTS SHALL BE IN ACCORDANCE WITH STD. 720011.

ALL MOUNTING HARDWARE SHALL BE ALUMINUM, STAINLESS STEEL, ZINC OR CADMIUM PLATED STEEL AND SHALL BE INCLUDED TO THE COST OF THE INSTALLATION.

ALL DIMENSIONS ARE IN MILLIMETERS (INCHES) UNLESS OTHERWISE NOTED.

SIGN SIZE	DIMENSIONS							
	A	B	C	D	E	F	G	H
1200x1200 (48x48)	1200 (48.0)	600 (24.1)	75 (3.0)	850 (34.0)	825 (33.0)	150 (6.0)	325 (13.0)	88 (3.5)

SIGN SIZE	SERIES LINES			MARGIN	BORDER	BLANK STD.
	1	2	3			
1200x1200 (48x48)	7C	7C	7C	20 (0.8)	30 (1.2)	B4-48D

ALL DIMENSIONS IN INCHES.

REVISED - 1-09-08	REGION 2 / DISTRICT 2 STANDARD				F.A. RTE.	SECTION	COUNTY	TOTAL SHEETS	SHEET NO.
REVISED -	SCALE: 1:800	SHEET NO.	OF	SHEETS	STA.	TO STA.	CONTRACT NO.		
REVISED -	PLOT DATE = Fri Dec 15 11:02:43 2010				FED. ROAD DIST. NO.		ILLINOIS FED. AID PROJECT		

ROUGH GROOVED SURFACE SIGN

91.2

ILLINOIS DEPARTMENT OF LABOR

PREVAILING WAGES FOR OGLE COUNTY EFFECTIVE MAY 2011

The Prevailing rates of wages are included in the Contract proposals which are subject to Check Sheet #5 of the Supplemental Specifications and Recurring Special Provisions. The rates have been ascertained and certified by the Illinois Department of Labor for the locality in which the work is to be performed and for each craft or type of work or mechanic needed to execute the work of the Contract. As required by Prevailing Wage Act (820 ILCS 130/0.01, et seq.) and Check Sheet #5 of the Contract, not less than the rates of wages ascertained by the Illinois Department of Labor and as revised during the performance of a Contract shall be paid to all laborers, workers and mechanics performing work under the Contract. Post the scale of wages in a prominent and easily accessible place at the site of work.

If the Illinois Department of Labor revises the prevailing rates of wages to be paid as listed in the specification of rates, the contractor shall post the revised rates of wages and shall pay not less than the revised rates of wages. Current wage rate information shall be obtained by visiting the Illinois Department of Labor web site at <http://www.state.il.us/agency/idol/> or by calling 312-793-2814. It is the responsibility of the contractor to review the rates applicable to the work of the contract at regular intervals in order to insure the timely payment of current rates. Provision of this information to the contractor by means of the Illinois Department of Labor web site satisfies the notification of revisions by the Department to the contractor pursuant to the Act, and the contractor agrees that no additional notice is required. The contractor shall notify each of its subcontractors of the revised rates of wages.

Ogle County Prevailing Wage for May 2011

Trade Name	RG	TYP	C	Base	FRMAN	*M-F>8	OSA	OSH	H/W	Pensn	Vac	Trng
=====	==	===	=	=====	=====	=====	===	===	=====	=====	=====	=====
ASBESTOS ABT-GEN		BLD		29.200	30.200	1.5	1.5	2.0	7.590	11.29	0.000	0.800
ASBESTOS ABT-MEC		BLD		18.950	0.000	1.5	1.5	2.0	2.700	3.350	0.000	0.000
BOILERMAKER		BLD		34.170	37.170	2.0	2.0	2.0	6.820	8.550	0.000	0.350
BRICK MASON		BLD		35.000	37.750	1.5	1.5	2.0	6.900	11.58	0.000	0.540
CARPENTER		HWY		31.550	33.300	1.5	1.5	2.0	8.190	10.99	0.000	0.490
CARPENTER	N	BLD		36.320	40.320	1.5	1.5	2.0	6.900	10.70	0.000	0.600
CARPENTER	S	BLD		32.040	35.560	1.5	1.5	2.0	8.190	11.87	0.000	0.600
CEMENT MASON		ALL		32.500	35.250	1.5	1.5	2.0	6.900	12.88	0.000	0.250
CERAMIC TILE FNSHER		BLD		30.530	0.000	1.5	1.5	2.0	6.900	4.840	0.000	0.470
COMMUNICATION TECH		BLD		34.000	37.400	1.5	1.5	2.0	9.740	10.60	0.000	0.680
ELECTRIC PWR EQMT OP		ALL		34.240	45.510	1.5	1.5	2.0	5.000	10.62	0.000	0.260
ELECTRIC PWR GRNDMAN		ALL		26.480	45.510	1.5	1.5	2.0	5.000	8.200	0.000	0.200
ELECTRIC PWR LINEMAN		ALL		41.000	45.510	1.5	1.5	2.0	5.000	12.71	0.000	0.310
ELECTRIC PWR TRK DRV		ALL		27.420	45.510	1.5	1.5	2.0	5.000	8.500	0.000	0.210
ELECTRICIAN		BLD		40.000	44.000	1.5	1.5	2.0	9.740	15.83	0.000	0.800
ELEVATOR CONSTRUCTOR		BLD		43.790	49.260	2.0	2.0	2.0	10.53	10.71	2.630	0.000
GLAZIER		BLD		32.730	33.730	1.5	1.5	2.0	8.950	8.200	0.000	1.250
HT/FROST INSULATOR		BLD		33.280	35.770	1.5	1.5	2.0	7.450	14.32	0.000	0.000
IRON WORKER		ALL		35.000	36.750	2.0	2.0	2.0	8.000	19.34	0.000	1.200
LABORER		BLD		29.200	30.200	1.5	1.5	2.0	7.590	11.29	0.000	0.800
LABORER		HWY		28.800	29.550	1.5	1.5	2.0	7.590	11.29	0.000	0.800
LABORER, SKILLED		HWY		30.800	31.550	1.5	1.5	2.0	7.590	11.29	0.000	0.800
LATHER	N	BLD		36.320	40.320	1.5	1.5	2.0	6.900	10.70	0.000	0.600
LATHER	S	BLD		32.040	35.560	1.5	1.5	2.0	8.190	11.87	0.000	0.600
MACHINIST		BLD		43.160	45.160	1.5	1.5	2.0	7.640	8.700	0.000	0.000
MARBLE FINISHERS		BLD		30.530	0.000	1.5	1.5	2.0	6.900	4.840	0.000	0.470
MARBLE MASON		BLD		33.380	33.630	1.5	1.5	2.0	6.900	6.980	0.000	0.500
MATERIAL TESTER I		ALL		21.550	0.000	1.5	1.5	2.0	7.460	4.840	0.000	0.170
MATERIALS TESTER II		ALL		26.550	0.000	1.5	1.5	2.0	7.460	4.840	0.000	0.170
MILLWRIGHT		BLD		33.970	37.370	1.5	1.5	2.0	6.550	12.35	0.000	0.500
OPERATING ENGINEER		BLD	1	40.350	44.350	2.0	2.0	2.0	13.05	8.800	2.350	1.300
OPERATING ENGINEER		BLD	2	39.650	44.350	2.0	2.0	2.0	13.05	8.800	2.350	1.300
OPERATING ENGINEER		BLD	3	37.200	44.350	2.0	2.0	2.0	13.05	8.800	2.350	1.300
OPERATING ENGINEER		BLD	4	35.200	44.350	2.0	2.0	2.0	13.05	8.800	2.350	1.300
OPERATING ENGINEER		BLD	5	44.100	44.350	2.0	2.0	2.0	13.05	8.800	2.350	1.300
OPERATING ENGINEER		BLD	6	43.350	44.350	2.0	2.0	2.0	13.05	8.800	2.350	1.300
OPERATING ENGINEER		BLD	7	40.350	44.350	2.0	2.0	2.0	13.05	8.800	2.350	1.300
OPERATING ENGINEER		HWY	1	40.200	44.200	1.5	1.5	2.0	13.05	8.800	2.350	1.300
OPERATING ENGINEER		HWY	2	39.650	44.200	1.5	1.5	2.0	13.05	8.800	2.350	1.300
OPERATING ENGINEER		HWY	3	38.350	44.200	1.5	1.5	2.0	13.05	8.800	2.350	1.300
OPERATING ENGINEER		HWY	4	36.900	44.200	1.5	1.5	2.0	13.05	8.800	2.350	1.300
OPERATING ENGINEER		HWY	5	35.450	44.200	1.5	1.5	2.0	13.05	8.800	2.350	1.300
OPERATING ENGINEER		HWY	6	43.200	44.200	1.5	1.5	2.0	13.05	8.800	2.350	1.300
OPERATING ENGINEER		HWY	7	41.200	44.200	1.5	1.5	2.0	13.05	8.800	2.350	1.300
PAINTER		ALL		35.000	37.000	1.5	1.5	1.5	8.950	8.200	0.000	1.250
PILEDRIVER		HWY		31.550	33.300	1.5	1.5	2.0	8.190	10.99	0.000	0.490
PILEDRIVER	N	BLD		37.320	41.430	1.5	1.5	2.0	6.900	10.70	0.000	0.600
PILEDRIVER	S	BLD		33.040	36.670	1.5	1.5	2.0	8.190	11.87	0.000	0.600
PIPEFITTER		BLD		38.500	41.200	1.5	1.5	2.0	7.890	10.38	0.000	0.900
PLASTERER		BLD		32.540	35.790	2.0	2.0	2.0	6.900	10.70	0.000	0.250
PLUMBER		BLD		38.500	41.200	1.5	1.5	2.0	7.890	10.38	0.000	0.900
ROOFER		BLD		37.650	40.650	1.5	1.5	2.0	7.750	6.570	0.000	0.430
SHEETMETAL WORKER		BLD		35.190	37.120	1.5	1.5	2.0	5.250	14.43	0.520	0.290
SPRINKLER FITTER		BLD		36.140	38.890	1.5	1.5	2.0	8.100	8.200	0.000	0.350
STONE MASON		BLD		35.000	37.750	1.5	1.5	2.0	6.900	11.58	0.000	0.540
TERRAZZO FINISHER		BLD		30.530	0.000	1.5	1.5	2.0	6.900	4.840	0.000	0.470
TERRAZZO MASON		BLD		33.380	33.630	1.5	1.5	2.0	6.900	6.980	0.000	0.500
TILE LAYER	N	BLD		36.320	40.320	1.5	1.5	2.0	6.900	10.70	0.000	0.600

TILE LAYER	S	BLD	32.040	35.560	1.5	1.5	2.0	8.190	11.87	0.000	0.600
TILE MASON		BLD	33.380	33.630	1.5	1.5	2.0	6.900	6.980	0.000	0.500
TRUCK DRIVER		O&C 1	23.580	0.000	1.5	1.5	2.0	9.050	4.347	0.000	0.250
TRUCK DRIVER		O&C 2	23.920	0.000	1.5	1.5	2.0	9.050	4.347	0.000	0.250
TRUCK DRIVER		O&C 3	24.090	0.000	1.5	1.5	2.0	9.050	4.347	0.000	0.250
TRUCK DRIVER		O&C 4	24.300	0.000	1.5	1.5	2.0	9.050	4.347	0.000	0.250
TRUCK DRIVER		O&C 5	24.930	0.000	1.5	1.5	2.0	9.050	4.347	0.000	0.250
TRUCK DRIVER	E	ALL 1	32.550	33.100	1.5	1.5	2.0	6.500	4.350	0.000	0.000
TRUCK DRIVER	E	ALL 2	32.700	33.100	1.5	1.5	2.0	6.500	4.350	0.000	0.000
TRUCK DRIVER	E	ALL 3	32.900	33.100	1.5	1.5	2.0	6.500	4.350	0.000	0.000
TRUCK DRIVER	E	ALL 4	33.100	33.100	1.5	1.5	2.0	6.500	4.350	0.000	0.000
TRUCK DRIVER	N	ALL 1	32.960	33.420	1.5	1.5	2.0	6.900	8.220	0.000	0.000
TRUCK DRIVER	N	ALL 2	33.110	33.420	1.5	1.5	2.0	6.900	8.220	0.000	0.000
TRUCK DRIVER	N	ALL 3	33.310	33.420	1.5	1.5	2.0	6.900	8.220	0.000	0.000
TRUCK DRIVER	N	ALL 4	33.420	33.420	1.5	1.5	2.0	6.900	8.220	0.000	0.000
TRUCK DRIVER	S	ALL 1	29.480	0.000	1.5	1.5	2.0	9.050	4.347	0.000	0.250
TRUCK DRIVER	S	ALL 2	29.900	0.000	1.5	1.5	2.0	9.050	4.347	0.000	0.250
TRUCK DRIVER	S	ALL 3	30.110	0.000	1.5	1.5	2.0	9.050	4.347	0.000	0.250
TRUCK DRIVER	S	ALL 4	30.370	0.000	1.5	1.5	2.0	9.050	4.347	0.000	0.250
TRUCK DRIVER	S	ALL 5	31.160	0.000	1.5	1.5	2.0	9.050	4.347	0.000	0.250
TUCKPOINTER		BLD	35.000	37.750	1.5	1.5	2.0	6.900	11.58	0.000	0.540

Legend:

M-F>8 (Overtime is required for any hour greater than 8 worked each day, Monday through Friday.)

OSA (Overtime is required for every hour worked on Saturday)

OSH (Overtime is required for every hour worked on Sunday and Holidays)

H/W (Health & Welfare Insurance)

Pensn (Pension)

Vac (Vacation)

Trng (Training)

Explanations

OGLE COUNTY

CARPENTER, LATHER, MILLWRIGHT, PILEDRIIVER AND TILE LAYER (NORTH) - That part of Ogle County East from the Winnebago County western boundary and North of an imaginary line running east and west located 4 miles north of the City of Oregon.

TRUCK DRIVER (EAST) - That part of the county East of Rt. 251, including all portions of the city of Rochelle, and South of Rt. 72.

TRUCK DRIVER (SOUTH) - That part of the county West of Rt. 251 and South of Rt. 72.

TRUCK DRIVER (NORTH) - That part of the county North of Route 72.

The following list is considered as those days for which holiday rates of wages for work performed apply: New Years Day, Memorial Day, Fourth of July, Labor Day, Thanksgiving Day, Christmas Day and

Veterans Day in some classifications/counties. Generally, any of these holidays which fall on a Sunday is celebrated on the following Monday. This then makes work performed on that Monday payable at the appropriate overtime rate for holiday pay. Common practice in a given local may alter certain days of celebration. If in doubt, please check with IDOL.

Oil and chip resealing (O&C) means the application of road oils and liquid asphalt to coat an existing road surface, followed by application of aggregate chips or gravel to coated surface, and subsequent rolling of material to seal the surface.

EXPLANATION OF CLASSES

ASBESTOS - GENERAL - removal of asbestos material/mold and hazardous materials from any place in a building, including mechanical systems where those mechanical systems are to be removed. This includes the removal of asbestos materials/mold and hazardous materials from ductwork or pipes in a building when the building is to be demolished at the time or at some close future date.

ASBESTOS - MECHANICAL - removal of asbestos material from mechanical systems, such as pipes, ducts, and boilers, where the mechanical systems are to remain.

CERAMIC TILE FINISHER, MARBLE FINISHER, TERRAZZO FINISHER

Assisting, helping or supporting the tile, marble and terrazzo mechanic by performing their historic and traditional work assignments required to complete the proper installation of the work covered by said crafts. The term "Ceramic" is used for naming the classification only and is in no way a limitation of the product handled. Ceramic takes into consideration most hard tiles.

COMMUNICATIONS TECHNICIAN

Installing, manufacturing, assembling and maintaining sound and intercom, protection alarm (security), fire alarm, master antenna television, closed circuit television, low voltage control for computers and/or door monitoring, school communications systems, telephones and servicing of nurse and emergency calls, and the installation and maintenance of transmit and receive antennas, transmitters, receivers, and associated apparatus which operates in conjunction with above systems. All work associated with these system installations will be included EXCEPT the installation of protective metallic conduit in new construction projects (excluding less than ten-foot runs strictly for protection of cable) and 120 volt AC (or higher) power wiring and associated hardware.

LABORER, SKILLED - HIGHWAY

Individuals engaged in the following types of work, irrespective of the site of the work: asbestos abatement worker, handling of any materials with any foreign matter harmful to skin or clothing, track laborer, cement handlers, chloride handlers, the unloading and loading with steel workers and re-bars, concrete workers wet, tunnel helpers in free air, batch dumpers, mason tenders, kettle and tar men, tank cleaners, plastic installers, scaffold workers, motorized buggies or motorized unit used for wet concrete or handling of building materials, laborers with de-watering systems, sewer workers plus depth, rod and chainmen with technical engineers, rod and chainmen with land surveyors, rod and chainmen with surveyors, vibrator operators, cement silica, clay, fly ash, lime and plasters, handlers

(bulk or bag), cofferdam workers plus depth, on concrete paving, placing, cutting and tying of reinforcing, deck hand, dredge hand, and shore laborers, bankmen on floating plant, grade checker, power tools, front end man on chip spreaders, cession workers plus depth, gunnite nozzle men, lead man on sewer work, welders, cutters, burners and torchmen, chainsaw operators, jackhammer and drill operators, layout man and/or drainage tile layer, steel form setter - street and highway, air tamping hammermen, signal man on crane, concrete saw operator, screedman on asphalt pavers, laborers tending masons with hot material or where foreign materials are used, mortar mixer operators, multiple concrete duct - leadsman, lumen, asphalt raker, curb asphalt machine operator, ready mix scalemen (permanent, portable or temporary plant), laborers handling masterplate or similar materials, laser beam operator, concrete burning machine operator, coring machine operator, plaster tender, underpinning and shoring of buildings, pump men, manhole and catch basin, dirt and stone tamper, hose men on concrete pumps, hazardous waste worker, lead base paint abatement worker, lining of pipe, refusing machine, assisting on direct boring machine, the work of laying watermain, fire hydrants, all mechanical joints to watermain work, sewer worker, and tapping water service and forced lift station mechanical worker.

MATERIAL TESTER I: Hand coring and drilling for testing of materials; field inspection of uncured concrete and asphalt.

MATERIAL TESTER II: Field inspection of welds, structural steel, fireproofing, masonry, soil, facade, reinforcing steel, formwork, cured concrete, and concrete and asphalt batch plants; adjusting proportions of bituminous mixtures.

OPERATING ENGINEERS - BUILDING

Class 1. Asphalt Plant; Asphalt Spreader; Autograde; Backhoes with Caisson Attachment; Batch Plant; Benoto (requires Two Engineers); Boiler and Throttle Valve; Caisson Rigs; Central Redi-Mix Plant; Combination Back Hoe Front End-loader Machine; Compressor and Throttle Valve; Concrete Breaker (Truck Mounted); Concrete Conveyor; Concrete Paver (over 27E cu. ft.): Concrete Paver (27 cu. ft. and under); Concrete Placer; Concrete Pump (Truck Mounted); Concrete Conveyor (Truck Mounted); Concrete Tower; Cranes, All; GCI and similar types (required two operators only); Cranes, Hammerhead; Creter Crane; Crusher, Stone, etc.; Derricks, All; Derricks, Traveling; Formless Curb and Gutter Machine; Grader, Elevating; Grouting Machines; Highlift Shovels or Front Endloader 2-1/4 yd. and over; Hoists, Elevators, outside type rack and pinion and similar machines; Hoists, one, two and three Drum; Hoists, Two Tugger One Floor; Hydraulic Backhoes; Hydraulic Boom Trucks; Locomotives, All; Lubrication Technician; Manipulators; Motor Patrol; Pile Drivers and Skid Rig; Post Hole Digger; Pre-Stress Machine; Pump Cretes Dual Ram; Pump Cretes: Squeeze Cretes - Screw Type Pumps, Gypsum Bulker and Pump; Raised and Blind Hole Drill; Rock Drill (self-propelled); Rock Drill - Truck Mounted; Roto Mill Grinder; Scoops - Tractor Drawn; Slipform Paver; Scrapers Prime Movers; Straddle Buggies; Tie Back Machine; Tractor with Boom and Side Boom; Trenching Machines.

Class 2. Bobcat (over 3/4 cu. yd.); Boilers; Brick Forklift; Broom, All Power Propelled; Bulldozers; Concrete Mixer (Two Bag and Over); Conveyor, Portable; Forklift Trucks; Highlift Shovels or Front Endloaders under 2-1/4 yd.; Hoists, Automatic; Hoists, Sewer Dragging Machine; Hoists, Tugger Single Drum; Rollers, All; Steam Generators; Tractors, All; Tractor Drawn Vibratory Roller; Winch Trucks with "A" Frame.

Class 3. Air Compressor; Asphalt Spreader; Combination - Small Equipment Operator; Generators; Heaters, Mechanical; Hoists, Inside Elevators - (Rheostat Manual Controlled); Hydraulic Power Units (Pile Driving and Extracting); Pumps, Over 3" (1 to 3 not to exceed total of 300 ft.); Pumps, Well Points; Welding Machines (2 through 5); Winches, 4 Small Electric Drill Winches; Bobcat (up to and including 3/4 cu. yd.).

Class 4. Elevator push button with automatic doors; Hoists, Inside; Oilers; Brick Forklift.

Class 5. Assistant Craft Foreman

Class 6. Mechanics

Class 7. Gradall

OPERATING ENGINEERS - HIGHWAY CONSTRUCTION

Class 1. Asphalt Plant; Asphalt Heater and Planer Combination; Asphalt Heater Scarfire; Asphalt Silo Tender; Asphalt Spreader; Autograder; ABG Paver; Backhoes with Caisson Attachment; Ballast Regulator; Belt Loader; Caisson Rigs; Car Dumper; Central Redi-Mix Plant; Backhoe w/shear attachments; Combination Backhoe Front Endloader Machine, (1 cu. yd. Backhoe Bucket or over or with attachments); Concrete Breaker (Truck Mounted); Concrete Conveyor; Concrete Paver over 27E cu. ft.; Concrete Placer; Concrete Tube Float; Cranes, all attachments; Cranes, Tower of all types; Creter Crane; Crusher, Stone, etc.; Derricks, All; Derrick Boats; Derricks, Traveling; Directional Boring Machine over 12"; Dredges; Formless Curb and Gutter Machine; Grader, Elevating; Grader, Motor Grader, Motor Patrol, Auto Patrol, Form Grader, Pull Grader, Subgrader; Guard Rail Post Driver Mounted; Hoists, One, Two and Three Drum; Hydraulic Backhoes; Lubrication Technician; Manipulators; Pile Drivers and Skid Rig; Pre-Stress Machine; Pump Cretes Dual Ram; Rock Drill - Crawler or Skid Rig; Rock Drill - Truck Mounted; Rock/Track Tamper; Roto Mill Grinder; Slip-Form Paver; Soil Test Drill Rig (Truck Mounted); Straddle Buggies; GCI Crane; Hydraulic Telescoping Form (Tunnel); Tie Back Machine; Tractor Drawn Belt Loader; Tractor Drawn Belt Loader with attached pusher; Tractor with Boom; Tractaire with Attachments; Traffic Barrier Conveyor Machine; Raised or Blind Hole Drills; Trenching Machine (over 12"); Truck Mounted Concrete Pump with Boom; Truck Mounted Concrete Conveyor; Underground Boring and/or Mining Machines; Wheel Excavator; Widener (APSCO).

Class 2. Batch Plant; Bituminous Mixer; Boiler and Throttle Valve; Bulldozers; Car Loader Trailing Conveyors; Combination Backhoe Front Endloader Machine (less than 1 cu. yd. Backhoe Bucket or over or with attachments); Compressor and Throttle Valve; Compressor, Common Receiver (3); Concrete Breaker or Hydro Hammer; Concrete Grinding Machine; Concrete Mixer or Paver 7S Series to and including 27 cu. ft.; Concrete Spreader; Concrete Curing Machine, Burlap Machine, Belting Machine and Sealing Machine; Conveyor Muck Cars (Haglund or Similar Type); Drills, all; Finishing Machine - Concrete; Highlift Shovels or Front Endloader; Hoist - Sewer Dragging Machine; Hydraulic Boom Trucks (All Attachments); Hydro Blaster; All Locomotives, Dinky; Off-Road Hauling Units (including articulating) / 2 ton capacity or more; Non-Self Loading Ejection Dump; Pump Cretes: Squeeze Cretes - Screw Type Pumps, Gypsum Bulker and Pump; Roller, Asphalt; Rotary Snow Plows; Rototiller, Seaman, etc., self-propelled; Scoops - Tractor Drawn; Self-Propelled Compactor; Spreader - Chip - Stone, etc.; Scraper; Scraper - Prime Mover in Tandem (Regardless of Size); Tank

Car Heater; Tractors, Push, Pulling Sheeps Foot, Disc, Compactor, etc.; Tug Boats.

Class 3. Boilers; Brooms, All Power Propelled; Cement Supply Tender; Compressor, Common Receiver (2); Concrete Mixer (Two Bag and Over); Conveyor, Portable; Farm-Type Tractors Used for Mowing, Seeding, etc.; Fireman on Boilers; Forklift Trucks; Grouting Machine; Hoists, Automatic; Hoists, All Elevators; Hoists, Tugger Single Drum; Jeep Diggers; Low Boys; Pipe Jacking Machines; Post-Hole Digger; Power Saw, Concrete Power Driven; Pug Mills; Rollers, other than asphalt; Seed and Straw Blower; Steam Generators; Stump Machine; Winch Trucks with "A" Frame; Work Boats; Tamper - Form - Motor Driven.

Class 4. Air Compressor - Small and Large; Asphalt Spreader, Backend Man; Bobcat (Skid Steer) all; Brick Forklift; Combination - Small Equipment Operator; Directional Boring Machine up to 12"; Generators; Heaters, Mechanical; Hydraulic Power Unit (Pile Driving, Extracting, or Drilling); Hydro-Blaster; Light Plants, All (1 through 5); Pumps, over 3" (1 to 3 not to exceed a total of 300 ft.); Pumps, Well Points; Tractaire; Trencher 12" and under; Welding Machines (2 through 5); Winches, 4 Small Electric Drill Winches.

Class 5. Oilers and Directional Boring Machine Locator.

Class 6. Field Mechanics and Field Welders

Class 7. Gradall and machines of like nature.

TRUCK DRIVER - BUILDING, HEAVY AND HIGHWAY CONSTRUCTION - SOUTH

Class 1. Drivers on 2 axle trucks hauling less than 9 ton. Air compressor and welding machines and brooms, including those pulled by separate units, truck driver helpers, warehouse employees, mechanic helpers, greasers and tiremen, pickup trucks when hauling materials, tools, or workers to and from and on-the-job site, and fork lifts up to 6,000 lb. capacity.

Class 2. Two or three axle trucks hauling more than 9 ton but hauling less than 16 ton. A-frame winch trucks, hydrolift trucks, vector trucks or similar equipment when used for transportation purposes. Fork lifts over 6,000 lb. capacity, winch trucks, four axle combination units, and ticket writers.

Class 3. Two, three or four axle trucks hauling 16 ton or more. Drivers on water pulls, articulated dump trucks, mechanics and working forepersons, and dispatchers. Five axle or more combination units.

Class 4. Low Boy and Oil Distributors.

Class 5. Drivers who require special protective clothing while employed on hazardous waste work.

TRUCK DRIVER - OIL AND CHIP RESEALING ONLY.

This shall encompass laborers, workers and mechanics who drive contractor or subcontractor owned, leased, or hired pickup, dump, service, or oil distributor trucks. The work includes transporting materials and equipment (including but not limited to, oils, aggregate supplies, parts, machinery and tools) to or from the job site; distributing oil or liquid asphalt and aggregate; stock piling

material when in connection with the actual oil and chip contract. The Truck Driver (Oil & Chip Resealing) wage classification does not include supplier delivered materials.

TRUCK DRIVER - BUILDING, HEAVY AND HIGHWAY CONSTRUCTION - EAST AND NORTH

Class 1. Two or three Axle Trucks. A-frame Truck when used for transportation purposes; Air Compressors and Welding Machines, including those pulled by cars, pick-up trucks and tractors; Ambulances; Batch Gate Lockers; Batch Hopperman; Car and Truck Washers; Carry-alls; Fork Lifts and Hoisters; Helpers; Mechanics Helpers and Greasers; Oil Distributors 2-man operation; Pavement Breakers; Pole Trailer, up to 40 feet; Power Mower Tractors; Self-propelled Chip Spreader; Skipman; Slurry Trucks, 2-man operation; Slurry Truck Conveyor Operation, 2 or 3 man; Teamsters; Unskilled dumpman; and Truck Drivers hauling warning lights, barricades, and portable toilets on the job site.

Class 2. Four axle trucks; Dump Crets and Adgetors under 7 yards; Dumpsters, Track Trucks, Euclids, Hug Bottom Dump Turnapulls or Turnatrailers when pulling other than self-loading equipment or similar equipment under 16 cubic yards; Mixer Trucks under 7 yards; Ready-mix Plant Hopper Operator, and Winch Trucks, 2 Axles.

Class 3. Five axle trucks; Dump Crets and Adgetors 7 yards and over; Dumpsters, Track Trucks, Euclids, Hug Bottom Dump Turnatrailers or turnapulls when pulling other than self-loading equipment or similar equipment over 16 cubic yards; Explosives and/or Fission Material Trucks; Mixer Trucks 7 yards or over; Mobile Cranes while in transit; Oil Distributors, 1-man operation; Pole Trailer, over 40 feet; Pole and Expandable Trailers hauling material over 50 feet long; Slurry trucks, 1-man operation; Winch trucks, 3 axles or more; mechanic--Truck Welder and Truck Painter.

Class 4. Six axle trucks; Dual-purpose vehicles, such as mounted crane trucks with hoist and accessories; Foreman; Master Mechanic; Self-loading equipment like P.B. and trucks with scoops on the front.

Other Classifications of Work:

For definitions of classifications not otherwise set out, the Department generally has on file such definitions which are available. If a task to be performed is not subject to one of the classifications of pay set out, the Department will upon being contacted state which neighboring county has such a classification and provide such rate, such rate being deemed to exist by reference in this document. If no neighboring county rate applies to the task, the Department shall undertake a special determination, such special determination being then deemed to have existed under this determination. If a project requires these, or any classification not listed, please contact IDOL at 217-782-1710 for wage rates or clarifications.

LANDSCAPING

Landscaping work falls under the existing classifications for laborer, operating engineer and truck driver. The work performed by landscape plantsman and landscape laborer is covered by the existing classification of laborer. The work performed by landscape operators

(regardless of equipment used or its size) is covered by the classifications of operating engineer. The work performed by landscape truck drivers (regardless of size of truck driven) is covered by the classifications of truck driver.