

The contractor shall furnish and install a light pole identification of each new light pole, as shown above, incidental to the respective light pole pay item. The numerals shall be 75 (3) series "D", black, screened on silver-white type B pressure sensitive reflective sheeting conforming to the requirements of section T602.01 of the Standard Specifications for Traffic Control Items. The numerals shall conform to the FHWA "Standard Alphabets for Highway Signs".

The light pole identification shall be applied to sign base material as specified in section 1069.06 of the Standard Specifications, approximately 180 (7) above the adjacent pavement grade visible to approaching traffic in accordance with Highway Standard 720001.

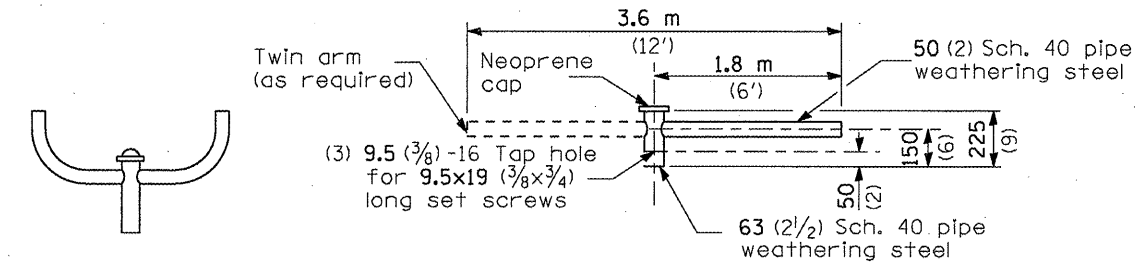

TWIN TENON

TENON MOUNT BRACKET ARM

NOTE: Single or twin arm assembly shall be tilted 3° above horizontal.

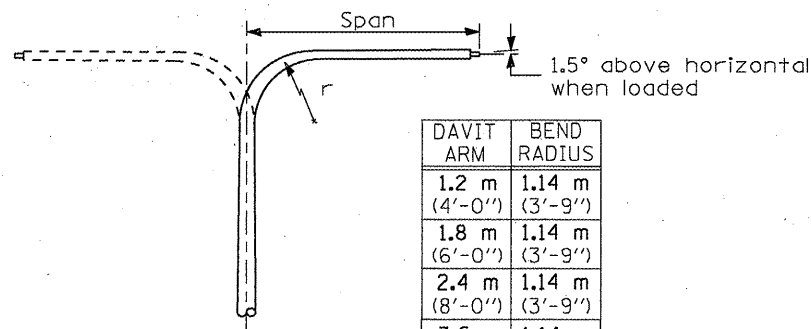

DAVIT ARM

DAVIT ARM-TWIN

DAVIT ARM	BEND RADIUS
1.2 m (4'-0")	1.14 m (3'-9")
1.8 m (6'-0")	1.14 m (3'-9")
2.4 m (8'-0")	1.14 m (3'-9")
3.6 m (12'-0")	1.14 m (3'-9")

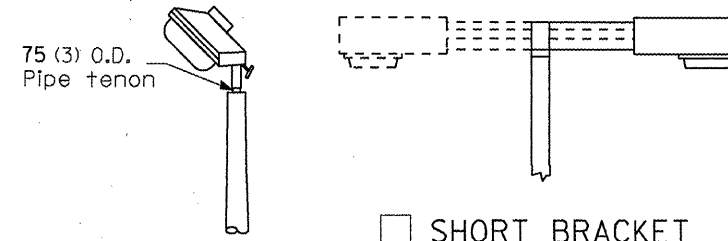

TENON

SHORT BRACKET

SHORT BRACKET - TWIN

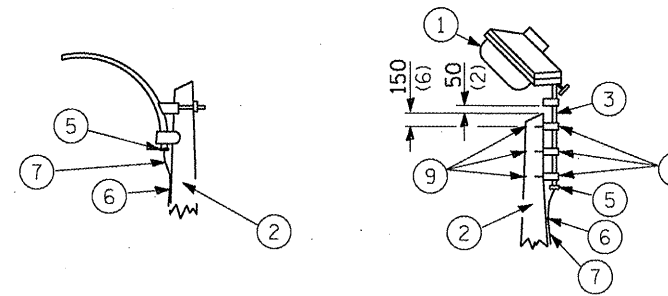

MAST ARM

TENON

- ① Luminaire
- ② Wood pole, class 3 or better
- ③ 63 (2 1/2) Galv. steel conduit
- ④ Single offset pole band
- ⑤ Conduit bushing
- ⑥ Cable clamps on 600 (24) centers
- ⑦ 2/c #12 Type use cable
- ⑧ 25 (1) Galv. steel conduit 3.0 m (10') in length
- ⑨ 16 (5/8) Ø hot dipped galvanized bolt with flat washer & locknut (3 req'd)
- ⑩ Conduit clamps on 900 (36) centers
- ⑪ Unit duct
- ⑫ Threaded reducer
- ⑬ "C" Condulet, threaded
- ⑭ 40 (1 1/2) Galv. steel conduit for 1 unit duct or 75 (3) galv. steel conduit for 2 or 3 unit ducts.

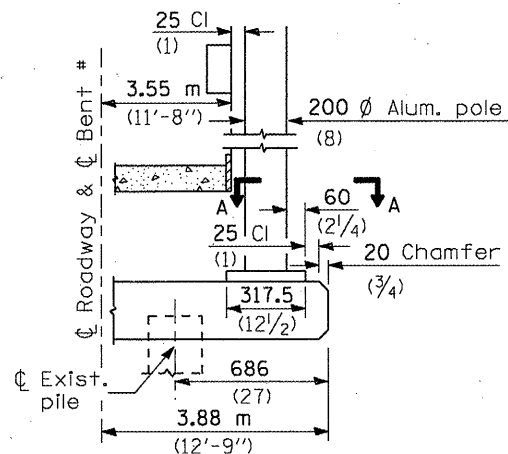

BENT #
(Looking)

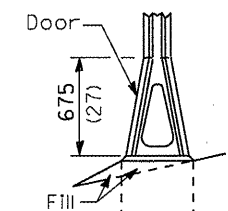

STAINLESS STEEL FLAIR BASE

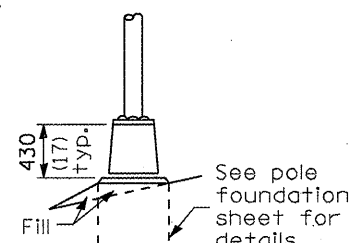

TRANSFORMER BASE

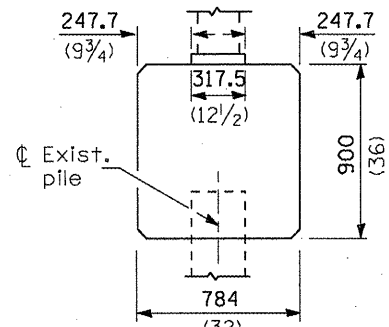

BRIDGE PIER MOUNT

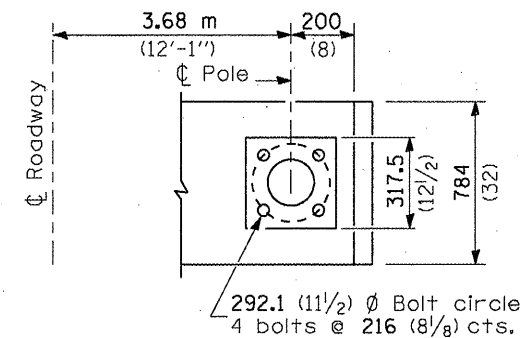

SECTION A-A

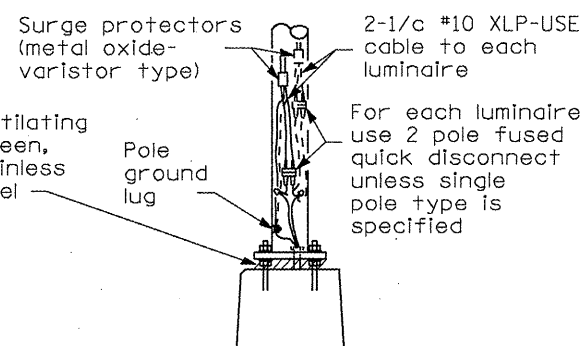

ANCHOR

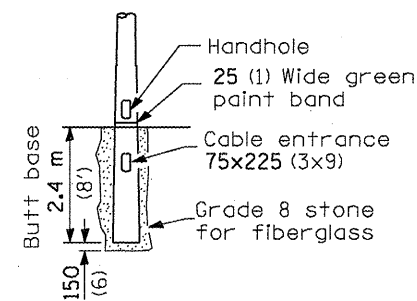

BUTT BASE

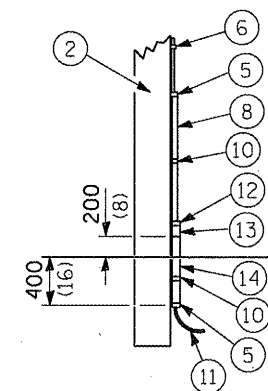

POLE, WOOD

POLE LENGTH	DEPTH IN GROUND
19.8 m (65')	3.6 m (12')
18.0 m (60')	3.0 m (10')
16.8 m (55')	2.7 m (9')
16.0 m (50')	2.4 m (8')
13.7 m (45')	2.1 m (7')
12.0 m (40')	2.0 m (6.5')
10.7 m (35')	1.8 m (6')
9.0 m (30')	1.7 m (5.5')

All dimensions are in millimeters (inches) unless otherwise shown.

Corrected 6/24/09

DRAFT COPY
not for distribution

METAL OR CONCRETE

Details for underground distribution if required

FILE NAME	USER NAME	DESIGNED	REVISED	STATE OF ILLINOIS DEPARTMENT OF TRANSPORTATION			F.A.P. RTE.	SECTION	COUNTY	TOTAL SHEETS	SHEET NO.
oi\pwwork\pwwork\bas\dms20086\d653802	basj			POLE STANDARDS DRAFT			310	69-3(3HB)	MORGAN	311C	311C
				SCALE: SHEET NO. OF SHEETS STA. TO STA.			CONTRACT NO. 72667				
							ILLINOIS FED. AID PROJECT				