

PARAPET EXPANSION JOINT DETAILS

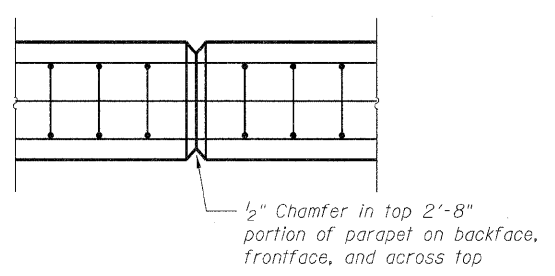

PARAPET CONTRACTION JOINT

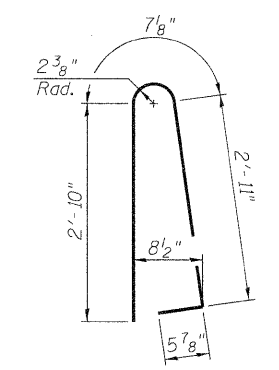

BAR d700(E)

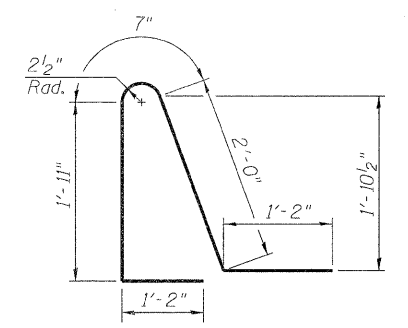

BAR d701(E)

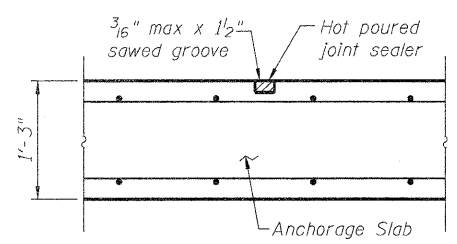

TRANSVERSE CONTRACTION JOINT

See Article 420.05 & 420.12 of the Standard Specifications

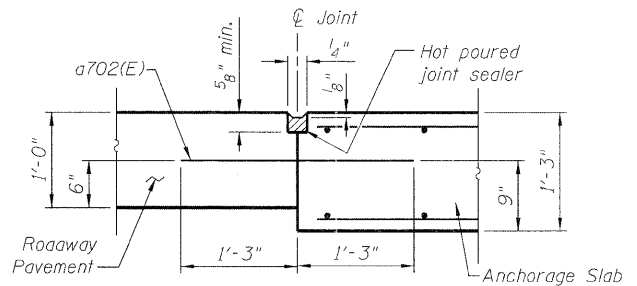

LONGITUDINAL CONSTRUCTION JOINT

See Article 420.05 & 420.12 of the Standard Specifications

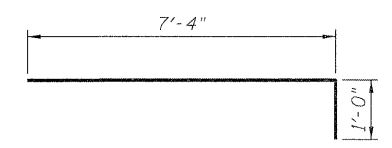

BAR a700(E)

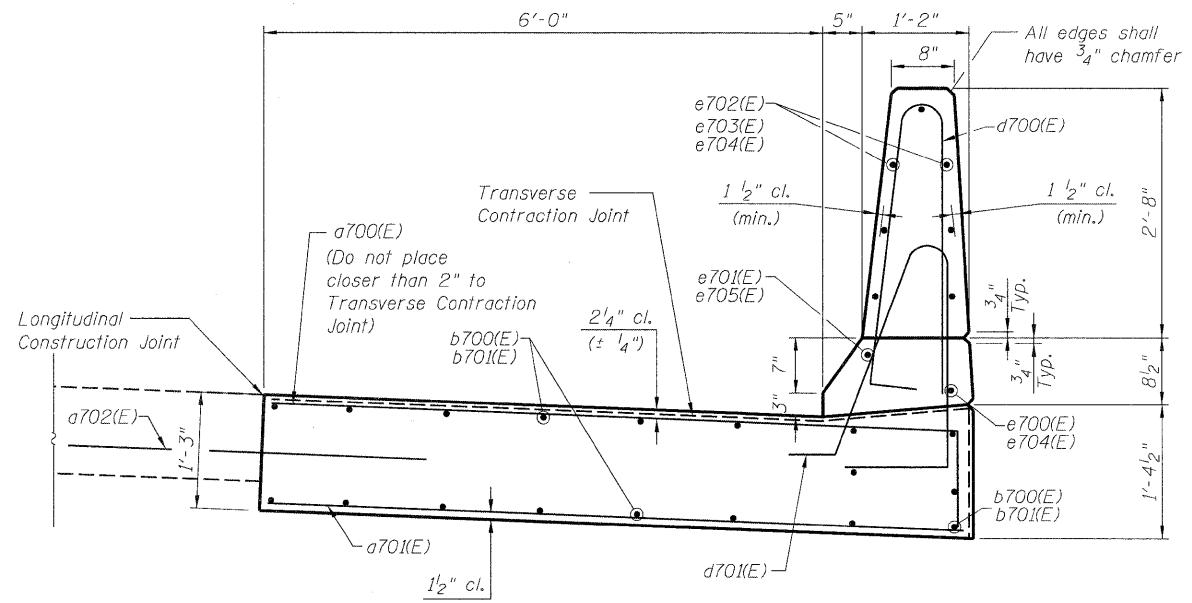

SECTION A-A

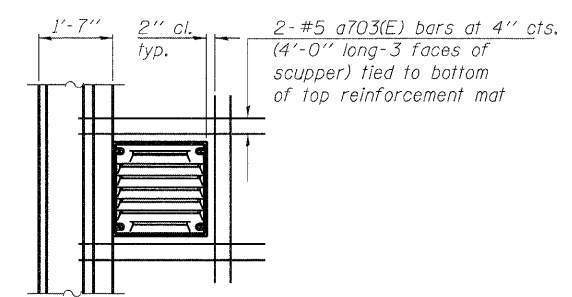

PLAN AT DRAINAGE STRUCTURE OPENING

Note:
Cut longitudinal reinforcement to clear drainage scuppers.
Parapet concrete shall be paid for as Concrete Superstructure.

BILL OF MATERIAL

| Bar | No. | Size | Length | Shape |
|----------------------------------|-----|---------|---------|--------|
| a700(E) | 456 | #7 | 8'-4" | U |
| a701(E) | 456 | #7 | 7'-4" | U |
| a702(E) | 171 | #6 | 2'-6" | U |
| a703(E) | 18 | #5 | 4'-0" | U |
| b700(E) | 170 | #6 | 31'-10" | U |
| b701(E) | 34 | #6 | 26'-4" | U |
| d700(E) | 372 | #5 | 6'-10" | U |
| d701(E) | 372 | #5 | 6'-10" | U |
| e700(E) | 12 | #4 | 26'-2" | U |
| e701(E) | 11 | #8 | 31'-3" | U |
| e702(E) | 63 | #4 | 31'-3" | U |
| e703(E) | 7 | #4 | 21'-4" | U |
| e704(E) | 16 | #4 | 25'-10" | U |
| e705(E) | 2 | #8 | 27'-5" | U |
| Reinforcement Bars, Epoxy Coated | | Pound | | 33,220 |
| Concrete Superstructure | | Cu. Yd. | | 47 |
| Concrete Structures | | Cu. Yd. | | 120 |

| | | |
|---------------------------|-------------------|-----------|
| USER NAME = BhattA | DESIGNED - DEV | REVISED - |
| | DRAWN - JHR | REVISED - |
| PLOT SCALE = 2,000' / in. | CHECKED - DD | REVISED - |
| PLOT DATE = #DATE# | DATE - 04-07-2011 | REVISED - |

STATE OF ILLINOIS
DEPARTMENT OF TRANSPORTATION

| | |
|------------------------------|---|
| PARAPET & ANCHORAGE SLAB III | |
| SCALE: | SHEET NO. S-3 OF S-3SHEETS STA. 70+90.00 TO STA. 73+81.72 |

| | | | | |
|---|------------------|--------------------|------------------|---------------|
| F.A.I. RTE. 70 | SECTION 82-1-B-1 | COUNTY ST. CLAIR | TOTAL SHEETS 319 | SHEET NO. 289 |
| FED. ROAD DIST. NO. ILLINOIS FED. AID PROJECT | | CONTRACT NO. 76C75 | | |