

**If you plan to submit a bid directly to the Department of Transportation**

**PREQUALIFICATION**

Any contractor who desires to become pre-qualified to bid on work advertised by IDOT must submit the properly completed pre-qualification forms to the Bureau of Construction no later than 4:30 p.m. prevailing time twenty-one days prior to the letting of interest. This pre-qualification requirement applies to first time contractors, contractors renewing expired ratings, contractors maintaining continuous pre-qualification or contractors requesting revised ratings. To be eligible to bid, existing pre-qualification ratings must be effective through the date of letting.

**REQUESTS FOR AUTHORIZATION TO BID**

Contractors wanting to bid on items included in a particular letting must submit the properly completed "Request for Authorization to Bid/or Not For Bid Status" (BDE 124) and the ORIGINAL "Affidavit of Availability" (BC 57) to the proper office no later than 4:30 p.m. prevailing time, three (3) days prior to the letting date. This does not apply to Small Business Set-Asides.

**WHO CAN BID ?**

Bids will be accepted from only those companies that request and receive written **Authorization to Bid** from IDOT's Central Bureau of Construction. This does not apply to Small Business Set-Asides.

**WHAT CONSTITUTES WRITTEN AUTHORIZATION TO BID?:** When a prospective prime bidder submits a "Request for Authorization to Bid/or Not For Bid Status" (BDE 124) he/she must indicate at that time which items are being requested For Bidding purposes. Only those items requested For Bidding will be analyzed. After the request has been analyzed, the bidder will be issued an **Authorization to Bid or Not for Bid Report**, approved by the Central Bureau of Construction that indicates which items have been approved For Bidding. If **Authorization to Bid** cannot be approved, the **Authorization to Bid or Not for Bid Report** will indicate the reason for denial.

**ABOUT AUTHORIZATION TO BID:** Firms that have not received an authorization form within a reasonable time of complete and correct original document submittal should contact the department as to status. This is critical in the week before the letting. These documents must be received three days before the letting date. Firms unsure as to authorization status should call the Prequalification Section of the Bureau of Construction at the number listed at the end of these instructions.

**ADDENDA AND REVISIONS:** It is the contractor's responsibility to determine which, if any, addenda or revisions pertain to any project they may be bidding. Failure to incorporate all relevant addenda or revisions may cause the bid to be declared unacceptable.

Each addendum will be placed with the contract number. Addenda and revisions will also be placed on the Addendum/Revision Checklist and each subscription service subscriber will be notified by e-mail of each addendum and revision issued.

The Internet is the Department's primary way of doing business. The subscription server e-mails are an added courtesy the Department provides. It is suggested that bidders check IDOT's website at <http://www.dot.il.gov/desenv/delett.html> before submitting final bid information.

---

***IDOT IS NOT RESPONSIBLE FOR ANY E-MAIL FAILURES.***

Addenda Questions may be directed to the Plans and Contracts Office at (217)782-7806 or [D&Econtracts@dot.il.gov](mailto:D&Econtracts@dot.il.gov)

---

Technical Questions about downloading these files may be directed to Tim Garman (217)524-1642 or [Timothy.Garman@illinois.gov](mailto:Timothy.Garman@illinois.gov).

---

**WHAT MUST BE INCLUDED WHEN BIDS ARE SUBMITTED?:** Bidders need not return the entire proposal when bids are submitted. That portion of the proposal that must be returned includes the following:

1. All documents from the Proposal Cover Sheet through the Proposal Bid Bond
2. Other special documentation and/or information that may be required by the contract special provisions

All proposal documents, including Proposal Guaranty Checks or Proposal Bid Bonds, should be stapled together to prevent loss when bids are processed by IDOT personnel.

**ABOUT SUBMITTING BIDS:** It is recommended that bidders deliver bids in person to insure they arrive at the proper location prior to the time specified for the receipt of bids. Any bid received at the place of letting after the time specified will not be accepted.

**WHO SHOULD BE CALLED IF ASSISTANCE IS NEEDED?**

<b>Questions Regarding</b>	<b>Call</b>
Prequalification and/or Authorization to Bid	217/782-3413
Preparation and submittal of bids	217/782-7806
Mailing of plans and proposals	217/782-7806

**ADDENDUMS AND REVISIONS TO THE PROPOSAL FORMS**

Planholders should verify that they have received and incorporated any addendum and/or revision prior to submitting their bid. Failure by the bidder to include an addendum or revision could result in a bid being rejected as irregular.

# 280

RETURN WITH BID

Proposal Submitted By
Name
Address
City

## Letting June 17, 2011

**BIDDERS NEED NOT RETURN THE ENTIRE PROPOSAL**  
(See instructions inside front cover)

### NOTICE TO PROSPECTIVE BIDDERS

This proposal can be used for bidding purposes by only those companies that request and receive written **AUTHORIZATION TO BID** from IDOT's Central Bureau of Construction. This does not apply to Small Business Set-Asides.  
(SEE INSTRUCTIONS ON THE INSIDE OF COVER)

# Notice to Bidders, Specifications, Proposal, Contract and Contract Bond



**Illinois Department  
of Transportation**

Springfield, Illinois 62764

**Contract No. 78239  
Various Counties  
Section D9 GUARDRAIL REPAIR FY12-1  
Various Routes  
District 9 Construction Funds**

PLEASE MARK THE APPROPRIATE BOX BELOW:

- A Bid Bond is included.
- A Cashier's Check or a Certified Check is included.

Plans Included  
Herein

Prepared by	
Checked by	S

(Printed by authority of the State of Illinois)

---

---

## INSTRUCTIONS

**ABOUT IDOT PROPOSALS:** All proposals issued by IDOT are potential bidding proposals. Each proposal contains all Certifications and Affidavits, a Proposal Signature Sheet and a Proposal Bid Bond. In addition, this proposal contains new statutory requirements applicable to the use of subcontractors and, in particular, includes the State Required Ethical Standards Governing Subcontractors to be signed and incorporated into all subcontracts.

**WHO CAN BID?:** Bids will be accepted from only those companies that request and receive written **Authorization to Bid** from IDOT's Central Bureau of Construction. To request authorization, a potential bidder must complete and submit Part B of the Request for Authorization to Bid/or Not For Bid Status form (BDE 124) and submit an original Affidavit of Availability (BC 57). This does not apply to Small Business Set-Asides.

**WHAT CONSTITUTES WRITTEN AUTHORIZATION TO BID?:** When a prospective prime bidder submits a "**Authorization to Bid or Not for Bid**" form, he/she must indicate at that time which items are being requested For Bidding purposes. Only those items requested For Bidding will be analyzed. After the request has been analyzed, the bidder will be issued a **Authorization to Bid or Not for Bid Report**, approved by the Central Bureau of Construction, that indicates which items have been approved For Bidding. If **Authorization to Bid** cannot be approved, the **Authorization to Bid or Not for Bid Report** will indicate the reason for denial. If a contractor has requested to bid but has not received a **Authorization to Bid or Not for Bid Report**, they should contact the Central Bureau of Construction in advance of the letting date.

**WHAT MUST BE INCLUDED WHEN BIDS ARE SUBMITTED?:** Bidders need not return the entire proposal when bids are submitted. That portion of the proposal that must be returned includes the following:

1. All documents from the Proposal Cover Sheet through the Proposal Bid Bond
2. Other special documentation and/or information that may be required by the contract special provisions

All proposal documents, including Proposal Guaranty Checks or Proposal Bid Bonds, should be stapled together to prevent loss when bids are processed by IDOT personnel.

**ABOUT SUBMITTING BIDS:** It is recommended that bidders deliver bids in person to insure they arrive at the proper location prior to the time specified for the receipt of bids. Any bid received at the place of letting after the time specified will not be accepted.

### WHO SHOULD BE CALLED IF ASSISTANCE IS NEEDED?

Questions Regarding	Call
Prequalification and/or Authorization to Bid	217/782-3413
Preparation and submittal of bids	217/782-7806

RETURN WITH BID



PROPOSAL

TO THE DEPARTMENT OF TRANSPORTATION

1. Proposal of \_\_\_\_\_

\_\_\_\_\_

Taxpayer Identification Number (Mandatory) \_\_\_\_\_ a

for the improvement identified and advertised for bids in the Invitation for Bids as:

**Contract No. 78239  
Various Counties  
Section D9 GUARDRAIL REPAIR FY12-1  
Various Routes  
District 9 Construction Funds**

**This project consists of repairing and replacing damaged guardrail, barrier terminals, attenuators, cable median barrier and fencing on a "call out" basis throughout District 9.**

2. The undersigned bidder will furnish all labor, material and equipment to complete the above described project in a good and workmanlike manner as provided in the contract documents provided by the Department of Transportation. This proposal will become part of the contract and the terms and conditions contained in the contract documents shall govern performance and payments.

**RETURN WITH BID**

3. **ASSURANCE OF EXAMINATION AND INSPECTION/WAIVER.** The undersigned further declares that he/she has carefully examined the proposal, plans, specifications, addenda, form of contract and contract bond, and special provisions, and that he/she has inspected in detail the site of the proposed work, and that he/she has familiarized themselves with all of the local conditions affecting the contract and the detailed requirements of construction, and understands that in making this proposal he/she waives all right to plead any misunderstanding regarding the same.
4. **EXECUTION OF CONTRACT AND CONTRACT BOND.** The undersigned further agrees to execute a contract for this work and present the same to the department within fifteen (15) days after the contract has been mailed to him/her. The undersigned further agrees that he/she and his/her surety will execute and present within fifteen (15) days after the contract has been mailed to him/her contract bond satisfactory to and in the form prescribed by the Department of Transportation, in the penal sum of the full amount of the contract, guaranteeing the faithful performance of the work in accordance with the terms of the contract.
5. **PROPOSAL GUARANTY.** Accompanying this proposal is either a bid bond on the department form, executed by a corporate surety company satisfactory to the department, or a proposal guaranty check consisting of a bank cashier's check or a properly certified check for not less than 5 per cent of the amount bid or for the amount specified in the following schedule:

<u>Amount of Bid</u>		<u>Proposal Guaranty</u>	<u>Amount of Bid</u>		<u>Proposal Guaranty</u>	
Up to	\$5,000 .....	\$150	\$2,000,000	to	\$3,000,000 .....	\$100,000
\$5,000	to \$10,000 .....	\$300	\$3,000,000	to	\$5,000,000 .....	\$150,000
\$10,000	to \$50,000 .....	\$1,000	\$5,000,000	to	\$7,500,000 .....	\$250,000
\$50,000	to \$100,000 .....	\$3,000	\$7,500,000	to	\$10,000,000 .....	\$400,000
\$100,000	to \$150,000 .....	\$5,000	\$10,000,000	to	\$15,000,000 .....	\$500,000
\$150,000	to \$250,000 .....	\$7,500	\$15,000,000	to	\$20,000,000 .....	\$600,000
\$250,000	to \$500,000 .....	\$12,500	\$20,000,000	to	\$25,000,000 .....	\$700,000
\$500,000	to \$1,000,000 .....	\$25,000	\$25,000,000	to	\$30,000,000 .....	\$800,000
\$1,000,000	to \$1,500,000 .....	\$50,000	\$30,000,000	to	\$35,000,000 .....	\$900,000
\$1,500,000	to \$2,000,000 .....	\$75,000	over		\$35,000,000 .....	\$1,000,000

Bank cashier's checks or properly certified checks accompanying proposals shall be made payable to the Treasurer, State of Illinois, when the state is awarding authority; the county treasurer, when a county is the awarding authority; or the city, village, or town treasurer, when a city, village, or town is the awarding authority.

If a combination bid is submitted, the proposal guaranties which accompany the individual proposals making up the combination will be considered as also covering the combination bid.

The amount of the proposal guaranty check is \_\_\_\_\_ \$(\_\_\_\_\_). If this proposal is accepted and the undersigned shall fail to execute a contract bond as required herein, it is hereby agreed that the amount of the proposal guaranty shall become the property of the State of Illinois, and shall be considered as payment of damages due to delay and other causes suffered by the State because of the failure to execute said contract and contract bond; otherwise, the bid bond shall become void or the proposal guaranty check shall be returned to the undersigned.

**Attach Cashier's Check or Certified Check Here**

In the event that one proposal guaranty check is intended to cover two or more proposals, the amount must be equal to the sum of the proposal guaranties which would be required for each individual proposal. If the guaranty check is placed in another proposal, state below where it may be found.

The proposal guaranty check will be found in the proposal for:

Item \_\_\_\_\_

Section No. \_\_\_\_\_

County \_\_\_\_\_

**Mark the proposal cover sheet as to the type of proposal guaranty submitted.**

**RETURN WITH BID**

6. **COMBINATION BIDS.** The undersigned further agrees that if awarded the contract for the sections contained in the following combination, he/she will perform the work in accordance with the requirements of each individual proposal comprising the combination bid specified in the schedule below, and that the combination bid shall be prorated against each section in proportion to the bid submitted for the same. If an error is found to exist in the gross sum bid for one or more of the individual sections included in a combination, the combination bid shall be corrected as provided in the specifications.

**When a combination bid is submitted, the schedule below must be completed in each proposal comprising the combination.**

**If alternate bids are submitted for one or more of the sections comprising the combination, a combination bid must be submitted for each alternate.**

**Schedule of Combination Bids**

Combination No.	Sections Included in Combination	Combination Bid	
		Dollars	Cents

7. **SCHEDULE OF PRICES.** The undersigned bidder submits herewith, in accordance with the rules and instructions, a schedule of prices for the items of work for which bids are sought. The unit prices bid are in U.S. dollars and cents, and all extensions and summations have been made. The bidder understands that the quantities appearing in the bid schedule are approximate and are provided for the purpose of obtaining a gross sum for the comparison of bids. If there is an error in the extension of the unit prices, the unit prices shall govern. Payment to the contractor awarded the contract will be made only for actual quantities of work performed and accepted or materials furnished according to the contract. The scheduled quantities of work to be done and materials to be furnished may be increased, decreased or omitted as provided elsewhere in the contract.

8. **AUTHORITY TO DO BUSINESS IN ILLINOIS.** Section 20-43 of the Illinois Procurement Code (30 ILCS 500/20-43) provides that a person (other than an individual acting as a sole proprietor) must be a legal entity authorized to do business in the State of Illinois prior to submitting the bid.

9. **The services of a subcontractor will or may be used.**

Check box Yes   
 Check box No

For known subcontractors with subcontracts with an annual value of more than \$25,000, the contract shall include their name, address, and the dollar allocation for each subcontractor.

---



---

10. **EXECUTION OF CONTRACT:** The Department of Transportation will, in accordance with the rules governing Department procurements, execute the contract and shall be the sole entity having the authority to accept performance and make payments under the contract. Execution of the contract by the Chief Procurement Officer or the State Purchasing Officer is for approval of the procurement process and execution of the contract by the Department. Neither the Chief Procurement Officer nor the State Purchasing Officer shall be responsible for administration of the contract or determinations respecting performance or payment there under except as otherwise permitted in the Illinois Procurement Code.

ILLINOIS DEPARTMENT OF TRANSPORTATION  
 SCHEDULE OF PRICES  
 CONTRACT  
 NUMBER - 78239

State Job # - C-99-026-11  
 PPS NBR - 9-00405-0122  
 County Name - VARIOUS- -  
 Code - 0 - -  
 District - 9 - -  
 Section Number - D9 GUARDRAIL REPAIR FY12-1

Project Number

Route  
 VARIOUS

Item Number	Pay Item Description	Unit of Measure	Quantity	x	Unit Price	=	Total Price
X0325411	F&I EXTRUDER HEAD	EACH	2.000				
X6310088	TRAF BAR TERM T6A SPL	EACH	3.000				
X6310176	TRAF BAR TERM T2 SPL	EACH	4.000				
X6310178	TRAF BAR TERM T4 SPL	EACH	4.000				
X6310218	TRAF BAR TERM T6 SPL	EACH	4.000				
X6311205	TRAF BAR TERM T5A SPL	EACH	4.000				
X6311217	TRAF BAR TERM T6B SPL	EACH	4.000				
X6640298	CH LK FENCE SPL	FOOT	150.000				
X6650208	WOV W FENCE REM & RPL	FOOT	75.000				
X7010520	TC-PROT 701201 SPL	L SUM	1.000				
X7010600	TC-PROT 701406 SPL	L SUM	1.000				
X8030110	LOC UNDERGR CABLE SPL	EACH	5.000				
Z0012754	STR REP CON DP = < 5	SQ FT	102.000				
Z0025548	F&I RAD RAIL ELE PLTS	EACH	2.000				
Z0026692	F&S CBL RD GD POST HT	EACH	75.000				



ILLINOIS DEPARTMENT OF TRANSPORTATION  
 SCHEDULE OF PRICES  
 CONTRACT  
 NUMBER -

78239

State Job # - C-99-026-11  
 PPS NBR - 9-00405-0122  
 County Name - VARIOUS- -  
 Code - 0 - -  
 District - 9 - -  
 Section Number - D9 GUARDRAIL REPAIR FY12-1

Project Number

Route  
 VARIOUS

Item Number	Pay Item Description	Unit of Measure	Quantity	x	Unit Price	=	Total Price
Z0026700	F & S STEEL POSTS	EACH	240.000				
Z0026800	F & S STEEL POSTS MOD	EACH	2.000				
Z0026900	F & S STEEL POSTS SPL	EACH	2.000				
Z0029654	HT CBL MED BAR TERM	EACH	5.000				
Z0029656	REP TB TERM T3 SPL	EACH	2.000				
Z0030050	IMP ATTEN FRD WID TL3	EACH	3.000				
Z0050000	REM REIN IMPACT ATTEN	EACH	40.000				
Z0052410	REPAIR TRBT T1 SP TAN	EACH	6.000				
Z0052415	REPAIR TRBT T1 SP FLR	EACH	4.000				
Z0052600	REPAIR TR BAR TERM T2	EACH	4.000				
Z0053000	REPAIR TR BAR TERM T5	EACH	4.000				
Z0053100	REPAIR TR BAR TERM 5A	EACH	4.000				
Z0053200	REPAIR TR BAR TERM T6	EACH	4.000				
Z0053210	REPAIR TR BAR TRM T6A	EACH	4.000				
Z0053220	REPAIR TR BAR TRM T6B	EACH	3.000				

ILLINOIS DEPARTMENT OF TRANSPORTATION  
 SCHEDULE OF PRICES  
 CONTRACT  
 NUMBER - 78239

State Job # - C-99-026-11  
 PPS NBR - 9-00405-0122  
 County Name - VARIOUS- -  
 Code - 0 - -  
 District - 9 - -  
 Section Number - D9 GUARDRAIL REPAIR FY12-1

Project Number

Route  
 VARIOUS

Item Number	Pay Item Description	Unit of Measure	Quantity	x	Unit Price	=	Total Price
25000100	SEEDING CL 1	ACRE	4.000				
63000025	SPBGR ATTACH TO STR	FOOT	10.000				
63001105	F & I GDRL BLOCKS	EACH	240.000				
63001305	F & I RAIL ELE PLATES	EACH	235.000				
63100167	TR BAR TRM T1 SPL TAN	EACH	51.000				
63100169	TR BAR TRM T1 SPL FLR	EACH	5.000				
67100100	MOBILIZATION	L SUM	1.000				
70100310	TRAF CONT-PROT 701421	L SUM	1.000				
78201000	TERMINAL MARKER - DA	EACH	51.000				

CONTRACT NUMBER                      78239

THIS IS THE TOTAL BID                      \$ \_\_\_\_\_

**NOTES:**

1. Each PAY ITEM should have a UNIT PRICE and a TOTAL PRICE.
2. The UNIT PRICE shall govern if no TOTAL PRICE is shown or if there is a discrepancy between the product of the UNIT PRICE multiplied by the QUANTITY.
3. If a UNIT PRICE is omitted, the TOTAL PRICE will be divided by the QUANTITY in order to establish a UNIT PRICE.
4. A bid may be declared UNACCEPTABLE if neither a unit price nor a total price is shown.

## RETURN WITH BID

### **STATE REQUIRED ETHICAL STANDARDS GOVERNING CONTRACT PROCUREMENT: ASSURANCES, CERTIFICATIONS AND DISCLOSURES**

#### **I. GENERAL**

**A.** Article 50 of the Illinois Procurement Code establishes the duty of all State chief procurement officers, State purchasing officers, and their designees to maximize the value of the expenditure of public moneys in procuring goods, services, and contracts for the State of Illinois and to act in a manner that maintains the integrity and public trust of State government. In discharging this duty, they are charged by law to use all available information, reasonable efforts, and reasonable actions to protect, safeguard, and maintain the procurement process of the State of Illinois.

**B.** In order to comply with the provisions of Article 50 and to carry out the duty established therein, all bidders are to adhere to ethical standards established for the procurement process, and to make such assurances, disclosures and certifications required by law. Except as otherwise required in subsection III, paragraphs J-M, by execution of the Proposal Signature Sheet, the bidder indicates that each of the mandated assurances have been read and understood, that each certification is made and understood, and that each disclosure requirement has been understood and completed.

**C.** In addition to all other remedies provided by law, failure to comply with any assurance, failure to make any disclosure or the making of a false certification shall be grounds for the chief procurement officer to void the contract, or subcontract, and may result in the suspension or debarment of the bidder or subcontractor.

#### **II. ASSURANCES**

The assurances hereinafter made by the bidder are each a material representation of fact upon which reliance is placed should the Department enter into the contract with the bidder.

##### **A. Conflicts of Interest**

1. The Illinois Procurement Code provides in pertinent part:

Section 50-13. Conflicts of Interest.

(a) Prohibition. It is unlawful for any person holding an elective office in this State, holding a seat in the General Assembly, or appointed to or employed in any of the offices or agencies of state government and who receives compensation for such employment in excess of 60% of the salary of the Governor of the State of Illinois, or who is an officer or employee of the Capital Development Board or the Illinois Toll Highway Authority, or who is the spouse or minor child of any such person to have or acquire any contract, or any direct pecuniary interest in any contract therein, whether for stationery, printing, paper, or any services, materials, or supplies, that will be wholly or partially satisfied by the payment of funds appropriated by the General Assembly of the State of Illinois or in any contract of the Capital Development Board or the Illinois Toll Highway authority.

(b) Interests. It is unlawful for any firm, partnership, association or corporation, in which any person listed in subsection (a) is entitled to receive (i) more than 7 1/2% of the total distributable income or (ii) an amount in excess of the salary of the Governor, to have or acquire any such contract or direct pecuniary interest therein.

(c) Combined interests. It is unlawful for any firm, partnership, association, or corporation, in which any person listed in subsection (a) together with his or her spouse or minor children is entitled to receive (i) more than 15%, in the aggregate, of the total distributable income or (ii) an amount in excess of 2 times the salary of the Governor, to have or acquire any such contract or direct pecuniary interest therein.

(d) Securities. Nothing in this Section invalidates the provisions of any bond or other security previously offered or to be offered for sale or sold by or for the State of Illinois.

(e) Prior interests. This Section does not affect the validity of any contract made between the State and an officer or employee of the State or member of the General Assembly, his or her spouse, minor child or any combination of those persons if that contract was in existence before his or her election or employment as an officer, member, or employee. The contract is voidable, however, if it cannot be completed within 365 days after the officer, member, or employee takes office or is employed.

The current salary of the Governor is \$177,412.00. Sixty percent of the salary is \$106,447.20.

## RETURN WITH BID

2. The bidder assures the Department that the award and execution of the contract would not cause a violation of Section 50-13, or that an effective exemption has been issued by the Board of Ethics to any individual subject to the Section 50-13 prohibitions pursuant to the provisions of Section 50-20 of the Code and Executive Order Number 3 (1998). Information concerning the exemption process is available from the Department upon request.

### **B. Negotiations**

1. The Illinois Procurement Code provides in pertinent part:

Section 50-15. Negotiations.

(a) It is unlawful for any person employed in or on a continual contractual relationship with any of the offices or agencies of State government to participate in contract negotiations on behalf of that office or agency with any firm, partnership, association, or corporation with whom that person has a contract for future employment or is negotiating concerning possible future employment.

2. The bidder assures the Department that the award and execution of the contract would not cause a violation of Section 50-15, and that the bidder has no knowledge of any facts relevant to the kinds of acts prohibited therein.

### **C. Inducements**

1. The Illinois Procurement Code provides:

Section 50-25. Inducement. Any person who offers or pays any money or other valuable thing to any person to induce him or her not to bid for a State contract or as recompense for not having bid on a State contract is guilty of a Class 4 felony. Any person who accepts any money or other valuable thing for not bidding for a State contract or who withholds a bid in consideration of the promise for the payment of money or other valuable thing is guilty of a Class 4 felony.

2. The bidder assures the Department that the award and execution of the contract would not cause a violation of Section 50-25, and that the bidder has no knowledge of any facts relevant to the kinds of acts prohibited therein.

### **D. Revolving Door Prohibition**

1. The Illinois Procurement Code provides:

Section 50-30. Revolving door prohibition. Chief procurement officers, State purchasing officers, procurement compliance monitors, their designees whose principal duties are directly related to State procurement, and executive officers confirmed by the Senate are expressly prohibited for a period of 2 years after terminating an affected position from engaging in any procurement activity relating to the State agency most recently employing them in an affected position for a period of at least 6 months. The prohibition includes, but is not limited to: lobbying the procurement process; specifying; bidding; proposing bid, proposal, or contract documents; on their own behalf or on behalf of any firm, partnership, association, or corporation. This Section applies only to persons who terminate an affected position on or after January 15, 1999.

2. The bidder assures the Department that the award and execution of the contract would not cause a violation of Section 50-30, and that the bidder has no knowledge of any facts relevant to the kinds of acts prohibited therein.

### **E. Reporting Anticompetitive Practices**

1. The Illinois Procurement Code provides:

Section 50-40. Reporting anticompetitive practices. When, for any reason, any vendor, bidder, contractor, chief procurement officer, State purchasing officer, designee, elected official, or State employee suspects collusion or other anticompetitive practice among any bidders, offerors, contractors, proposers, or employees of the State, a notice of the relevant facts shall be transmitted to the Attorney General and the chief procurement officer.

2. The bidder assures the Department that it has not failed to report any relevant facts concerning the practices addressed in Section 50-40 which may involve the contract for which the bid is submitted.

### **F. Confidentiality**

1. The Illinois Procurement Code provides:

Section 50-45. Confidentiality. Any chief procurement officer, State purchasing officer, designee, or executive officer who willfully uses or allows the use of specifications, competitive bid documents, proprietary competitive information, proposals, contracts, or selection information to compromise the fairness or integrity of the procurement, bidding, or contract process shall be subject to immediate dismissal, regardless of the Personnel code, any contract, or any collective bargaining agreement, and may in addition be subject to criminal prosecution.

2. The bidder assures the Department that it has no knowledge of any fact relevant to the practices addressed in Section 50-45 which may involve the contract for which the bid is submitted.

## RETURN WITH BID

### **G. Insider Information**

1. The Illinois Procurement Act provides:

Section 50-50. Insider information. It is unlawful for any current or former elected or appointed State official or State employee to knowingly use confidential information available only by virtue of that office or employment for actual or anticipated gain for themselves or another person.

2. The bidder assures the Department that it has no knowledge of any facts relevant to the practices addressed in Section 50-50 which may involve the contract for which the bid is submitted.

### **III. CERTIFICATIONS**

The certifications hereinafter made by the bidder are each a material representation of fact upon which reliance is placed should the Department enter into the contract with the bidder. Section 50-2 of the Illinois Procurement Code provides that every person that has entered into a multi-year contract and every subcontractor with a multi-year subcontract shall certify, by July 1 of each fiscal year covered by the contract after the initial fiscal year, to the responsible chief procurement officer whether it continues to satisfy the requirements of Article 50 pertaining to the eligibility for a contract award. If a contractor or subcontractor is not able to truthfully certify that it continues to meet all requirements, it shall provide with its certification a detailed explanation of the circumstances leading to the change in certification status. A contractor or subcontractor that makes a false statement material to any given certification required under Article 50 is, in addition to any other penalties or consequences prescribed by law, subject to liability under the Whistleblower Reward and Protection Act for submission of a false claim.

#### **A. Bribery**

1. The Illinois Procurement Code provides:

Section 50-5. Bribery.

(a) Prohibition. No person or business shall be awarded a contract or subcontract under this Code who:

(1) has been convicted under the laws of Illinois or any other state of bribery or attempting to bribe an officer or employee of the State of Illinois or any other state in that officer's or employee's official capacity; or

(2) has made an admission of guilt of that conduct that is a matter of record but has not been prosecuted for that conduct.

(b) Businesses. No business shall be barred from contracting with any unit of State or local government, or subcontracting under such a contract, as a result of a conviction under this Section of any employee or agent of the business if the employee or agent is no longer employed by the business and:

(1) the business has been finally adjudicated not guilty; or

(2) the business demonstrates to the governmental entity with which it seeks to contract, or which is signatory to the contract which the subcontract relates, and that entity finds that the commission of the offense was not authorized, requested, commanded, or performed by a director, officer, or high managerial agent on behalf of the business as provided in paragraph (2) of subsection (a) of Section 5-4 of the Criminal Code of 1961.

(c) Conduct on behalf of business. For purposes of this Section, when an official, agent, or employee of a business committed the bribery or attempted bribery on behalf of the business and in accordance with the direction or authorization of a responsible official of the business, the business shall be chargeable with the conduct.

(d) Certification. Every bid submitted to and contract executed by the State, and every subcontract subject to Section 20-120 of the Procurement Code shall contain a certification by the contractor or the subcontractor, respectively, that the contractor or subcontractor is not barred from being awarded a contract or subcontract under this Section and acknowledges that the chief procurement officer may declare the related contract void if any certifications required by this Section are false. A contractor who makes a false statement, material to the certification, commits a Class 3 felony.

2. The contractor or subcontractor certifies that it is not barred from being awarded a contract under Section 50.5.

#### **B. Felons**

1. The Illinois Procurement Code provides:

Section 50-10. Felons. Unless otherwise provided, no person or business convicted of a felony shall do business with the State of Illinois or any State agency, or enter into a subcontract, from the date of conviction until 5 years after the date of completion of the sentence for that felony, unless no person held responsible by a prosecutorial office for the facts upon which the conviction was based continues to have any involvement with the business.

2. Certification. Every bid submitted to and contract executed by the State and every subcontract subject to Section 20-120 of the Procurement Code shall contain a certification by the bidder or contractor or subcontractor, respectively, that the bidder, contractor, or subcontractor is not barred from being awarded a contract or subcontract under this Section and acknowledges that the chief procurement officer may declare the related contract void if any of the certifications required by this Section are false.

## RETURN WITH BID

### **C. Debt Delinquency**

1. The Illinois Procurement Code provides:

Section 50-11 and 50-12. Debt Delinquency.

The contractor or bidder or subcontractor, respectively, certifies that it, or any affiliate, is not barred from being awarded a contract or subcontract under the Procurement Code. Section 50-11 prohibits a person from entering into a contract with a State agency, or entering into a subcontract, if it knows or should know that it, or any affiliate, is delinquent in the payment of any debt to the State as defined by the Debt Collection Board. Section 50-12 prohibits a person from entering into a contract with a State agency, or entering into a subcontract, if it, or any affiliate, has failed to collect and remit Illinois Use Tax on all sales of tangible personal property into the State of Illinois in accordance with the provisions of the Illinois Use Tax Act. The bidder or contractor or subcontractor, respectively, further acknowledges that the chief procurement officer may declare the related contract void if this certification is false or if the bidder, contractor, or subcontractor, or any affiliate, is determined to be delinquent in the payment of any debt to the State during the term of the contract.

### **D. Prohibited Bidders, Contractors and Subcontractors**

1. The Illinois Procurement Code provides:

Section 50-10.5 and 50-60(c). Prohibited bidders, contractors and subcontractors.

The bidder or contractor or subcontractor, respectively, certifies in accordance with 30 ILCS 500/50-10.5 that no officer, director, partner or other managerial agent of the contracting business has been convicted of a felony under the Sarbanes-Oxley Act of 2002 or a Class 3 or Class 2 felony under the Illinois Securities Law of 1953 or if in violation of Subsection (c) for a period of five years from the date of conviction. Every bid submitted to and contract executed by the State and every subcontract subject to Section 20-120 of the Procurement Code shall contain a certification by the bidder, contractor, or subcontractor, respectively, that the bidder, contractor, or subcontractor is not barred from being awarded a contract or subcontract under this Section and acknowledges that the chief procurement officer shall declare the related contract void if any of the certifications completed pursuant to this Section are false.

### **E. Section 42 of the Environmental Protection Act**

The bidder or contractor or subcontractor, respectively, certifies in accordance with 30 ILCS 500/50-12 that the bidder, contractor, or subcontractor, is not barred from being awarded a contract or entering into a subcontract under this Section which prohibits the bidding on or entering into contracts with the State of Illinois or a State agency, or entering into any subcontract, that is subject to the Procurement Code by a person or business found by a court or the Pollution Control Board to have committed a willful or knowing violation of Section 42 of the Environmental Protection Act for a period of five years from the date of the order. The bidder or contractor or subcontractor, respectively, acknowledges that the chief procurement officer may declare the contract void if this certification is false.

### **F. Educational Loan**

1. Section 3 of the Educational Loan Default Act provides:

§ 3. No State agency shall contract with an individual for goods or services if that individual is in default, as defined in Section 2 of this Act, on an educational loan. Any contract used by any State agency shall include a statement certifying that the individual is not in default on an educational loan as provided in this Section.

2. The bidder, if an individual as opposed to a corporation, partnership or other form of business organization, certifies that the bidder is not in default on an educational loan as provided in Section 3 of the Act.

### **G. Bid-Rigging/Bid Rotating**

1. Section 33E-11 of the Criminal Code of 1961 provides:

§ 33E-11. (a) Every bid submitted to and public contract executed pursuant to such bid by the State or a unit of local government shall contain a certification by the prime contractor that the prime contractor is not barred from contracting with any unit of State or local government as a result of a violation of either Section 33E-3 or 33E-4 of this Article. The State and units of local government shall provide the appropriate forms for such certification.

- (b) A contractor who makes a false statement, material to the certification, commits a Class 3 felony.

A violation of Section 33E-3 would be represented by a conviction of the crime of bid-rigging which, in addition to Class 3 felony sentencing, provides that any person convicted of this offense or any similar offense of any state or the United States which contains the same elements as this offense shall be barred for 5 years from the date of conviction from contracting with any unit of State or local government. No corporation shall be barred from contracting with any unit of State or local government as a result of a conviction under this Section of any employee or agent of such corporation if the employee so convicted is no longer employed by the corporation and: (1) it has been finally adjudicated not guilty or (2) if it demonstrates to the governmental entity with which it seeks to contract and that entity finds that the commission of the offense was neither authorized, requested, commanded, nor performed by a director, officer or a high managerial agent in behalf of the corporation.

## RETURN WITH BID

A violation of Section 33E-4 would be represented by a conviction of the crime of bid-rotating which, in addition to Class 2 felony sentencing, provides that any person convicted of this offense or any similar offense of any state or the United States which contains the same elements as this offense shall be permanently barred from contracting with any unit of State or local government. No corporation shall be barred from contracting with any unit of State or local government as a result of a conviction under this Section of any employee or agent of such corporation if the employee so convicted is no longer employed by the corporation and: (1) it has been finally adjudicated not guilty or (2) if it demonstrates to the governmental entity with which it seeks to contract and that entity finds that the commission of the offense was neither authorized, requested, commanded, nor performed by a director, officer or a high managerial agent in behalf of the corporation.

2. The bidder certifies that it is not barred from contracting with the Department by reason of a violation of either Section 33E-3 or Section 33E-4.

### **H. International Anti-Boycott**

1. Section 5 of the International Anti-Boycott Certification Act provides:

§ 5. State contracts. Every contract entered into by the State of Illinois for the manufacture, furnishing, or purchasing of supplies, material, or equipment or for the furnishing of work, labor, or services, in an amount exceeding the threshold for small purchases according to the purchasing laws of this State or \$10,000.00, whichever is less, shall contain certification, as a material condition of the contract, by which the contractor agrees that neither the contractor nor any substantially-owned affiliated company is participating or shall participate in an international boycott in violation of the provisions of the U.S. Export Administration Act of 1979 or the regulations of the U.S. Department of Commerce promulgated under that Act.

2. The bidder makes the certification set forth in Section 5 of the Act.

### **I. Drug Free Workplace**

1. The Illinois "Drug Free Workplace Act" applies to this contract and it is necessary to comply with the provisions of the "Act" if the contractor is a corporation, partnership, or other entity (including a sole proprietorship) which has 25 or more employees.

2. The bidder certifies that if awarded a contract in excess of \$5,000 it will provide a drug free workplace by:

(a) Publishing a statement notifying employees that the unlawful manufacture, distribution, dispensation, possession or use of a controlled substance, including cannabis, is prohibited in the contractor's workplace; specifying the actions that will be taken against employees for violations of such prohibition; and notifying the employee that, as a condition of employment on such contract, the employee shall abide by the terms of the statement, and notify the employer of any criminal drug statute conviction for a violation occurring in the workplace no later than five (5) days after such conviction.

(b) Establishing a drug free awareness program to inform employees about the dangers of drug abuse in the workplace; the contractor's policy of maintaining a drug free workplace; any available drug counseling, rehabilitation, and employee assistance programs; and the penalties that may be imposed upon employees for drug violations.

(c) Providing a copy of the statement required by subparagraph (1) to each employee engaged in the performance of the contract and to post the statement in a prominent place in the workplace.

(d) Notifying the Department within ten (10) days after receiving notice from an employee or otherwise receiving actual notice of the conviction of an employee for a violation of any criminal drug statute occurring in the workplace.

(e) Imposing or requiring, within 30 days after receiving notice from an employee of a conviction or actual notice of such a conviction, an appropriate personnel action, up to and including termination, or the satisfactory participation in a drug abuse assistance or rehabilitation program approved by a federal, state or local health, law enforcement or other appropriate agency.

(f) Assisting employees in selecting a course of action in the event drug counseling, treatment, and rehabilitation is required and indicating that a trained referral team is in place.

(g) Making a good faith effort to continue to maintain a drug free workplace through implementation of the actions and efforts stated in this certification.



## RETURN WITH BID

### **J. Disclosure of Business Operations in Iran**

Section 50-36 of the Illinois Procurement Code, 30ILCS 500/50-36 provides that each bid, offer, or proposal submitted for a State contract shall include a disclosure of whether or not the Company acting as the bidder, offeror, or proposing entity, or any of its corporate parents or subsidiaries, within the 24 months before submission of the bid, offer, or proposal had business operations that involved contracts with or provision of supplies or services to the Government of Iran, companies in which the Government of Iran has any direct or indirect equity share, consortiums or projects commissioned by the Government of Iran, or companies involved in consortiums or projects commissioned by the Government of Iran and either of the following conditions apply:

- (1) More than 10% of the Company's revenues produced in or assets located in Iran involve oil-related activities or mineral-extraction activities; less than 75% of the Company's revenues produced in or assets located in Iran involve contracts with or provision of oil-related or mineral-extraction products or services to the Government of Iran or a project or consortium created exclusively by that government; and the Company has failed to take substantial action.
- (2) The Company has, on or after August 5, 1996, made an investment of \$20 million or more, or any combination of investments of at least \$10 million each that in the aggregate equals or exceeds \$20 million in any 12-month period, which directly or significantly contributes to the enhancement of Iran's ability to develop petroleum resources of Iran.

The terms "Business operations", "Company", "Mineral-extraction activities", "Oil-related activities", "Petroleum resources", and "Substantial action" are all defined in the Code.

Failure to make the disclosure required by the Code shall cause the bid, offer or proposal to be considered not responsive. The disclosure will be considered when evaluating the bid, offer, or proposal or awarding the contract. The name of each Company disclosed as doing business or having done business in Iran will be provided to the State Comptroller.

Check the appropriate statement:

Company has no business operations in Iran to disclose.

Company has business operations in Iran as disclosed the attached document.

### **K. Apprenticeship and Training Certification (Does not apply to federal aid projects)**

In accordance with the provisions of Section 30-22 (6) of the Illinois Procurement Code, the bidder certifies that it is a participant, either as an individual or as part of a group program, in the approved apprenticeship and training programs applicable to each type of work or craft that the bidder will perform with its own forces. The bidder further certifies for work that will be performed by subcontract that each of its subcontractors submitted for approval either (a) is, at the time of such bid, participating in an approved, applicable apprenticeship and training program; or (b) will, prior to commencement of performance of work pursuant to this contract, begin participation in an approved apprenticeship and training program applicable to the work of the subcontract. The Department, at any time before or after award, may require the production of a copy of each applicable Certificate of Registration issued by the United States Department of Labor evidencing such participation by the contractor and any or all of its subcontractors. Applicable apprenticeship and training programs are those that have been approved and registered with the United States Department of Labor. The bidder shall list in the space below, the official name of the program sponsor holding the Certificate of Registration for all of the types of work or crafts in which the bidder is a participant and that will be performed with the bidder's forces. Types of work or craft work that will be subcontracted shall be included and listed as subcontract work. The list shall also indicate any type of work or craft job category that does not have an applicable apprenticeship or training program. **The bidder is responsible for making a complete report and shall make certain that each type of work or craft job category that will be utilized on the project as reported on the Construction Employee Workforce Projection (Form BC-1256) and returned with the bid is accounted for and listed.**

---

---

---

The requirements of this certification and disclosure are a material part of the contract, and the contractor shall require this certification provision to be included in all approved subcontracts. In order to fulfill this requirement, it shall not be necessary that an applicable program sponsor be currently taking or that it will take applications for apprenticeship, training or employment during the performance of the work of this contract.

**TO BE RETURNED WITH BID**

**L. Political Contributions and Registration with the State Board of Elections**

Sections 20-160 and 50-37 of the Illinois Procurement Code regulate political contributions from business entities and any affiliated entities or affiliated persons bidding on or contracting with the state. Generally under Section 50-37, any business entity, and any affiliated entity or affiliated person of the business entity, whose current year contracts with all state agencies exceed an awarded value of \$50,000, are prohibited from making any contributions to any political committees established to promote the candidacy of the officeholder responsible for the awarding of the contracts or any other declared candidate for that office for the duration of the term of office of the incumbent officeholder or a period 2 years after the termination of the contract, whichever is longer. Any business entity and affiliated entities or affiliated persons whose state contracts in the current year do not exceed an awarded value of \$50,000, but whose aggregate pending bids and proposals on state contracts exceed \$50,000, either alone or in combination with contracts not exceeding \$50,000, are prohibited from making any political contributions to any political committee established to promote the candidacy of the officeholder responsible for awarding the pending contract during the period beginning on the date the invitation for bids or request for proposals is issued and ending on the day after the date of award or selection if the entity was not awarded or selected. Section 20-160 requires certification of registration of affected business entities in accordance with procedures found in Section 9-35 of The Election Code.

By submission of a bid, the contractor business entity acknowledges and agrees that it has read and understands Sections 20-160 and 50-37 of the Illinois Procurement Code, and that it makes the following certification:

**The undersigned business entity certifies that it has registered as a business with the State Board of Elections and acknowledges a continuing duty to update the registration in accordance with the above referenced statutes. A copy of the certificate of registration shall be submitted with the bid. The bidder is cautioned that the Department will not award a contract without submission of the certificate of registration.**

These requirements and compliance with the above referenced statutory sections are a material part of the contract, and any breach thereof shall be cause to void the contract under Section 50-60 of the Illinois Procurement Code. This provision does not apply to Federal-aid contracts.

**M. Lobbyist Disclosure**

Section 50-38 of the Illinois Procurement Code requires that any bidder or offeror on a State contract that hires a person required to register under the Lobbyist Registration Act to assist in obtaining a contract shall:

- (i) Disclose all costs, fees, compensation, reimbursements, and other remunerations paid or to be paid to the lobbyist related to the contract,
- (ii) Not bill or otherwise cause the State of Illinois to pay for any of the lobbyist's costs, fees, compensation, reimbursements, or other remuneration, and
- (iii) Sign a verification certifying that none of the lobbyist's costs, fees, compensation, reimbursements, or other remuneration were billed to the State.

This information, along with all supporting documents, shall be filed with the agency awarding the contract and with the Secretary of State. The chief procurement officer shall post this information, together with the contract award notice, in the online Procurement Bulletin.

Pursuant to Subsection (c) of this Section, no person or entity shall retain a person or entity to attempt to influence the outcome of a procurement decision made under the Procurement Code for compensation contingent in whole or in part upon the decision or procurement. Any person who violates this subsection is guilty of a business offense and shall be fined not more than \$10,000.

Bidder acknowledges that it is required to disclose the hiring of any person required to register pursuant to the Illinois Lobbyist Registration Act (25 ILCS 170) in connection with this contract.

Bidder has not hired any person required to register pursuant to the Illinois Lobbyist Registration Act in connection with this contract.

Or

Bidder has hired the following persons required to register pursuant to the Illinois Lobbyist Registration Act in connection with the contract:

Name and address of person: \_\_\_\_\_  
All costs, fees, compensation, reimbursements and other remuneration paid to said person: \_\_\_\_\_  
\_\_\_\_\_  
\_\_\_\_\_

## RETURN WITH BID

### IV. DISCLOSURES

- A. The disclosures hereinafter made by the bidder are each a material representation of fact upon which reliance is placed should the Department enter into the contract with the bidder. The bidder further certifies that the Department has received the disclosure forms for each bid.

The chief procurement officer may void the bid, contract, or subcontract, respectively, if it is later determined that the bidder or subcontractor rendered a false or erroneous disclosure. A contractor or subcontractor may be suspended or debarred for violations of the Procurement Code. Furthermore, the chief procurement officer may void the contract and the surety providing the performance bond shall be responsible for completion of the contract.

### B. Financial Interests and Conflicts of Interest

1. Section 50-35 of the Illinois Procurement Code provides that all bids of more than \$25,000 shall be accompanied by disclosure of the financial interests of the bidder. This disclosed information for the successful bidder, will be maintained as public information subject to release by request pursuant to the Freedom of Information Act, filed with the Procurement Policy Board, and shall be incorporated as a material term of the contract. Furthermore, pursuant to Section 5-5, the Procurement Policy Board may review a proposal, bid, or contract and issue a recommendation to void a contract or reject a proposal or bid based on any violation of the Procurement Code or the existence of a conflict of interest as provided in subsections (b) and (d) of Section 50-35.

The financial interests to be disclosed shall include ownership or distributive income share that is in excess of 5%, or an amount greater than 60% of the annual salary of the Governor, of the bidding entity or its parent entity, whichever is less, unless the contractor or bidder is a publicly traded entity subject to Federal 10K reporting, in which case it may submit its 10K disclosure in place of the prescribed disclosure. If a bidder is a privately held entity that is exempt from Federal 10K reporting, but has more than 400 shareholders, it may submit the information that Federal 10K companies are required to report, and list the names of any person or entity holding any ownership share that is in excess of 5%. The disclosure shall include the names, addresses, and dollar or proportionate share of ownership of each person making the disclosure, their instrument of ownership or beneficial relationship, and notice of any potential conflict of interest resulting from the current ownership or beneficial interest of each person making the disclosure having any of the relationships identified in Section 50-35 and on the disclosure form.

**The current annual salary of the Governor is \$177,412.00**

In addition, all disclosures shall indicate any other current or pending contracts, proposals, leases, or other ongoing procurement relationships the bidding entity has with any other unit of state government and shall clearly identify the unit and the contract, proposal, lease, or other relationship.

2. Disclosure Forms. Disclosure Form A is attached for use concerning the individuals meeting the above ownership or distributive share requirements. Subject individuals should be covered each by one form. In addition, a second form (Disclosure Form B) provides for the disclosure of current or pending procurement relationships with other (non-IDOT) state agencies. **The forms must be included with each bid.**

### C. Disclosure Form Instructions

#### Form A Instructions for Financial Information & Potential Conflicts of Interest

If the bidder is a publicly traded entity subject to Federal 10K reporting, the 10K Report may be submitted to meet the requirements of Form A. If a bidder is a privately held entity that is exempt from Federal 10K reporting, but has more than 400 shareholders, it may submit the information that Federal 10K companies are required to report, and list the names of any person or entity holding any ownership share that is in excess of 5%. If a bidder is not subject to Federal 10K reporting, the bidder must determine if any individuals are required by law to complete a financial disclosure form. To do this, the bidder should answer each of the following questions. A "YES" answer indicates Form A must be completed. If the answer to each of the following questions is "NO", then the NOT APPLICABLE STATEMENT on Form A must be signed and dated by a person that is authorized to execute contracts for the bidding company. Note: These questions are for assistance only and are not required to be completed.

1. Does anyone in your organization have a direct or beneficial ownership share of greater than 5% of the bidding entity or parent entity? YES \_\_\_ NO \_\_\_
2. Does anyone in your organization have a direct or beneficial ownership share of less than 5%, but which has a value greater than 60% of the annual salary of the Governor? YES \_\_\_ NO \_\_\_
3. Does anyone in your organization receive more than 60% of the annual salary of the Governor of the bidding entity's or parent entity's distributive income? YES \_\_\_ NO \_\_\_

(Note: Distributive income is, for these purposes, any type of distribution of profits. An annual salary is not distributive income.)

4. Does anyone in your organization receive greater than 5% of the bidding entity's or parent entity's total distributive income, but which is less than 60% of the annual salary of the Governor? YES \_\_\_ NO \_\_\_

(Note: Only one set of forms needs to be completed per person per bid even if a specific individual would require a yes answer to more than one question.)

A "YES" answer to any of these questions requires the completion of Form A. The bidder must determine each individual in the bidding entity or the bidding entity's parent company that would cause the questions to be answered "Yes". Each form must be signed and dated by a person that is authorized to execute contracts for your organization. **Photocopied or stamped signatures are not acceptable.** The person signing can be, but does not have to be, the person for which the form is being completed. The bidder is responsible for the accuracy of any information provided.

If the answer to each of the above questions is "NO", then the NOT APPLICABLE STATEMENT of Form A must be signed and dated by a person that is authorized to execute contracts for your company.

## RETURN WITH BID

### **Form B: Instructions for Identifying Other Contracts & Procurement Related Information**

Disclosure Form B must be completed for each bid submitted by the bidding entity. *Note: Checking the NOT APPLICABLE STATEMENT on Form A does not allow the bidder to ignore Form B. Form B must be completed, checked, and dated or the bidder may be considered nonresponsive and the bid will not be accepted.*

The Bidder shall identify, by checking Yes or No on Form B, whether it has any pending contracts (including leases), bids, proposals, or other ongoing procurement relationship with any other (non-IDOT) State of Illinois agency. If "No" is checked, the bidder only needs to complete the check box on the bottom of Form B. If "Yes" is checked, the bidder must do one of the following:

Option I: If the bidder did not submit an Affidavit of Availability to obtain authorization to bid, the bidder must list all non-IDOT State of Illinois agency pending contracts, leases, bids, proposals, and other ongoing procurement relationships. These items may be listed on Form B or on an attached sheet(s). Do not include IDOT contracts. Contracts with cities, counties, villages, etc. are not considered State of Illinois agency contracts and are not to be included. Contracts with other State of Illinois agencies such as the Department of Natural Resources or the Capital Development Board must be included. Bidders who submit Affidavits of Availability are suggested to use Option II.

Option II: If the bidder is required and has submitted an Affidavit of Availability in order to obtain authorization to bid, the bidder may write or type "See Affidavit of Availability" which indicates that the Affidavit of Availability is incorporated by reference and includes all non-IDOT State of Illinois agency pending contracts, leases, bids, proposals, and other ongoing procurement relationships. For any contracts that are not covered by the Affidavit of Availability, the bidder must identify them on Form B or on an attached sheet(s). These might be such things as leases.

**ILLINOIS DEPARTMENT  
OF TRANSPORTATION**

**Form A  
Financial Information &  
Potential Conflicts of Interest  
Disclosure**

Contractor Name		
Legal Address		
City, State, Zip		
Telephone Number	Email Address	Fax Number (if available)

Disclosure of the information contained in this Form is required by the Section 50-35 of the Illinois Procurement Code (30 ILCS 500). Vendors desiring to enter into a contract with the State of Illinois must disclose the financial information and potential conflict of interest information as specified in this Disclosure Form. This information shall become part of the publicly available contract file. This Form A must be completed for bids in excess of \$25,000, and for all open-ended contracts. **A publicly traded company may submit a 10K disclosure (or equivalent if applicable) in satisfaction of the requirements set forth in Form A. See Disclosure Form Instructions.**

*The current annual salary of the Governor is \$177,412.00.*

**DISCLOSURE OF FINANCIAL INFORMATION**

**1. Disclosure of Financial Information.** The individual named below has an interest in the BIDDER (or its parent) in terms of ownership or distributive income share in excess of 5%, or an interest which has a value of more than 60% of the annual salary of the Governor. **(Make copies of this form as necessary and attach a separate Disclosure Form A for each individual meeting these requirements)**

<b>FOR INDIVIDUAL (type or print information)</b>	
<b>NAME:</b>	_____
<b>ADDRESS</b>	_____
<b>Type of ownership/distributable income share:</b>	
stock _____ sole proprietorship _____ Partnership _____ other: (explain on separate sheet):	
% or \$ value of ownership/distributable income share:	_____

**2. Disclosure of Potential Conflicts of Interest.** Check "Yes" or "No" to indicate which, if any, of the following potential conflict of interest relationships apply. If the answer to any question is "Yes", please attach additional pages and describe.

(a) State employment, currently or in the previous 3 years, including contractual employment of services. Yes \_\_\_ No \_\_\_

If your answer is yes, please answer each of the following questions.

1. Are you currently an officer or employee of either the Capitol Development Board or the Illinois State Toll Highway Authority? Yes \_\_\_ No \_\_\_

2. Are you currently appointed to or employed by any agency of the State of Illinois? If you are currently appointed to or employed by any agency of the State of Illinois, and your annual salary exceeds 60% of the annual salary of the Governor, provide the name the State agency for which you are employed and your annual salary. \_\_\_\_\_

**RETURN WITH BID**

3. If you are currently appointed to or employed by any agency of the State of Illinois, and your annual salary exceeds 60% of the annual salary of the Governor, are you entitled to receive (i) more than 7 1/2% of the total distributable income of your firm, partnership, association or corporation, or (ii) an amount in excess of 100% of the annual salary of the Governor?  
Yes \_\_\_ No \_\_\_

4. If you are currently appointed to or employed by any agency of the State of Illinois, and your annual salary exceeds 60% of the annual salary of the Governor, are you and your spouse or minor children entitled to receive (i) more than 15 % in the aggregate of the total distributable income of your firm, partnership, association or corporation, or (ii) an amount in excess of two times the salary of the Governor?  
Yes \_\_\_ No \_\_\_

---

(b) State employment of spouse, father, mother, son, or daughter, including contractual employment services in the previous 2 years.

Yes \_\_\_ No \_\_\_

If your answer is yes, please answer each of the following questions.

1. Is your spouse or any minor children currently an officer or employee of the Capitol Development Board or the Illinois State Toll Highway Authority?  
Yes \_\_\_ No \_\_\_

2. Is your spouse or any minor children currently appointed to or employed by any agency of the State of Illinois? If your spouse or minor children is/are currently appointed to or employed by any agency of the State of Illinois, and his/her annual salary exceeds 60% of the annual salary of the Governor, provide the name of your spouse and/or minor children, the name of the State agency for which he/she is employed and his/her annual salary. \_\_\_\_\_

3. If your spouse or any minor children is/are currently appointed to or employed by any agency of the State of Illinois, and his/her annual salary exceeds 60% of the annual salary of the Governor, as of 7/1/07 are you entitled to receive (i) more than 7 1/2% of the total distributable income of your firm, partnership, association or corporation, or (ii) an amount in excess of 100% of the annual salary of the Governor?  
Yes \_\_\_ No \_\_\_

4. If your spouse or any minor children are currently appointed to or employed by any agency of the State of Illinois, and his/her annual salary exceeds 60% of the annual salary of the Governor, are you and your spouse or minor children entitled to receive (i) more than 15 % in the aggregate of the total distributable income of your firm, partnership, association or corporation, or (ii) an amount in excess of 2 times the salary of the Governor?  
Yes \_\_\_ No \_\_\_

---

(c) Elective status; the holding of elective office of the State of Illinois, the government of the United States, any unit of local government authorized by the Constitution of the State of Illinois or the statutes of the State of Illinois currently or in the previous 3 years.  
Yes \_\_\_ No \_\_\_

---

(d) Relationship to anyone holding elective office currently or in the previous 2 years; spouse, father, mother, son, or daughter.  
Yes \_\_\_ No \_\_\_

---

(e) Appointive office; the holding of any appointive government office of the State of Illinois, the United States of America, or any unit of local government authorized by the Constitution of the State of Illinois or the statutes of the State of Illinois, which office entitles the holder to compensation in excess of the expenses incurred in the discharge of that office currently or in the previous 3 years.  
Yes \_\_\_ No \_\_\_

---

(f) Relationship to anyone holding appointive office currently or in the previous 2 years; spouse, father, mother, son, or daughter.  
Yes \_\_\_ No \_\_\_

---

(g) Employment, currently or in the previous 3 years, as or by any registered lobbyist of the State government.  
Yes \_\_\_ No \_\_\_

---

**RETURN WITH BID/OFFER**

(h) Relationship to anyone who is or was a registered lobbyist in the previous 2 years; spouse, father, mother, son, or daughter. Yes \_\_\_ No \_\_\_

(i) Compensated employment, currently or in the previous 3 years, by any registered election or reelection committee registered with the Secretary of State or any county clerk of the State of Illinois, or any political action committee registered with either the Secretary of State or the Federal Board of Elections. Yes \_\_\_ No \_\_\_

(j) Relationship to anyone; spouse, father, mother, son, or daughter; who was a compensated employee in the last 2 years by any registered election or re-election committee registered with the Secretary of State or any county clerk of the State of Illinois, or any political action committee registered with either the Secretary of State or the Federal Board of Elections. Yes \_\_\_ No \_\_\_

**2. Communication Disclosure.**

Disclose the name and address of each lobbyist and other agent of the bidder or offeror who is not identified in Section 2 of this form, who is has communicated, is communicating, or may communicate with any State officer or employee concerning the bid or offer. This disclosure is a continuing obligation and must be promptly supplemented for accuracy throughout the process and throughout the term of the contract. If no person is identified, enter "None" on the line below:

Name and address of person(s): \_\_\_\_\_  
\_\_\_\_\_  
\_\_\_\_\_  
\_\_\_\_\_

**RETURN WITH BID**

**4. Debarment Disclosure.** For each of the persons identified under Sections 2 and 3 of this form, disclose whether any of the following has occurred within the previous 10 years: debarment from contracting with any governmental entity; professional licensure discipline; bankruptcies; adverse civil judgments and administrative findings; and criminal felony convictions. This disclosure is a continuing obligation and must be promptly supplemented for accuracy throughout the procurement process and term of the contract. If no person is identified, enter "None" on the line below:

Name of person(s): \_\_\_\_\_

Nature of disclosure: \_\_\_\_\_

\_\_\_\_\_  
\_\_\_\_\_

**APPLICABLE STATEMENT**

**This Disclosure Form A is submitted on behalf of the INDIVIDUAL named on previous page. Under penalty of perjury, I certify the contents of this disclosure to be true and accurate to the best of my knowledge.**

Completed by:  \_\_\_\_\_ Date \_\_\_\_\_  
Signature of Individual or Authorized Representative

**NOT APPLICABLE STATEMENT**

**Under penalty of perjury, I have determined that no individuals associated with this organization meet the criteria that would require the completion of this Form A.**

**This Disclosure Form A is submitted on behalf of the CONTRACTOR listed on the previous page.**

\_\_\_\_\_ Date \_\_\_\_\_  
Signature of Authorized Representative

The bidder has a continuing obligation to supplement these disclosures under Sec. 50-35 of the Procurement Code.



RETURN WITH BID

ILLINOIS DEPARTMENT OF TRANSPORTATION

Form B Other Contracts & Procurement Related Information Disclosure

Contractor Name		
Legal Address		
City, State, Zip		
Telephone Number	Email Address	Fax Number (if available)

Disclosure of the information contained in this Form is required by the Section 50-35 of the Illinois Procurement Act (30 ILCS 500). This information shall become part of the publicly available contract file. This Form B must be completed for bids in excess of \$25,000, and for all open-ended contracts.

DISCLOSURE OF OTHER CONTRACTS AND PROCUREMENT RELATED INFORMATION

1. Identifying Other Contracts & Procurement Related Information. The BIDDER shall identify whether it has any pending contracts (including leases), bids, proposals, or other ongoing procurement relationship with any other State of Illinois agency: Yes \_\_\_ No \_\_\_

If "No" is checked, the bidder only needs to complete the signature box on the bottom of this page.

2. If "Yes" is checked. Identify each such relationship by showing State of Illinois agency name and other descriptive information such as bid or project number (attach additional pages as necessary). SEE DISCLOSURE FORM INSTRUCTIONS:

THE FOLLOWING STATEMENT MUST BE CHECKED

<input type="checkbox"/>	<hr style="border: none; border-top: 1px solid black;"/> Signature of Authorized Representative	<hr style="border: none; border-top: 1px solid black;"/> Date
--------------------------	---	---

## **RETURN WITH BID**

### **SPECIAL NOTICE TO CONTRACTORS**

The following requirements of the Illinois Department of Human Rights' Rules and Regulations are applicable to bidders on all construction contracts advertised by the Illinois Department of Transportation:

#### **CONSTRUCTION EMPLOYEE UTILIZATION PROJECTION**

- (a) All bidders on construction contracts shall complete and submit, along with and as part of their bids, a Bidder's Employee Utilization Form (Form BC-1256) setting forth a projection and breakdown of the total workforce intended to be hired and/or allocated to such contract work by the bidder including a projection of minority and female employee utilization in all job classifications on the contract project.
- (b) The Department of Transportation shall review the Employee Utilization Form, and workforce projections contained therein, of the contract awardee to determine if such projections reflect an underutilization of minority persons and/or women in any job classification in accordance with the Equal Employment Opportunity Clause and Section 7.2 of the Illinois Department of Human Rights' Rules and Regulations for Public Contracts adopted as amended on September 17, 1980. If it is determined that the contract awardee's projections reflect an underutilization of minority persons and/or women in any job classification, it shall be advised in writing of the manner in which it is underutilizing and such awardee shall be considered to be in breach of the contract unless, prior to commencement of work on the contract project, it submits revised satisfactory projections or an acceptable written affirmative action plan to correct such underutilization including a specific timetable geared to the completion stages of the contract.
- (c) The Department of Transportation shall provide to the Department of Human Rights a copy of the contract awardee's Employee Utilization Form, a copy of any required written affirmative action plan, and any written correspondence related thereto. The Department of Human Rights may review and revise any action taken by the Department of Transportation with respect to these requirements.

**RETURN WITH BID**



**Contract No. 78239  
 Various Counties  
 Section D9 GUARDRAIL REPAIR FY12-1  
 Various Routes  
 District 9 Construction Funds**

**PART I. IDENTIFICATION**

Dept. Human Rights # \_\_\_\_\_ Duration of Project: \_\_\_\_\_  
 Name of Bidder: \_\_\_\_\_

**PART II. WORKFORCE PROJECTION**

A. The undersigned bidder has analyzed minority group and female populations, unemployment rates and availability of workers for the location in which this contract work is to be performed, and for the locations from which the bidder recruits employees, and hereby submits the following workforce projection including a projection for minority and female employee utilization in all job categories in the workforce to be allocated to this contract:

**TABLE A**

TOTAL Workforce Projection for Contract												
JOB CATEGORIES	TOTAL EMPLOYEES		MINORITY EMPLOYEES						TRAINEES			
			BLACK		HISPANIC		*OTHER MINOR.		APPRENTICES		ON THE JOB TRAINEES	
	M	F	M	F	M	F	M	F	M	F	M	F
OFFICIALS (MANAGERS)												
SUPERVISORS												
FOREMEN												
CLERICAL												
EQUIPMENT OPERATORS												
MECHANICS												
TRUCK DRIVERS												
IRONWORKERS												
CARPENTERS												
CEMENT MASONS												
ELECTRICIANS												
PIPEFITTERS, PLUMBERS												
PAINTERS												
LABORERS, SEMI-SKILLED												
LABORERS, UNSKILLED												
<b>TOTAL</b>												

**TABLE B**

CURRENT EMPLOYEES TO BE ASSIGNED TO CONTRACT				
TOTAL EMPLOYEES			MINORITY EMPLOYEES	
M	F		M	F

**TABLE C**

TOTAL Training Projection for Contract								
EMPLOYEES IN TRAINING	TOTAL EMPLOYEES		BLACK		HISPANIC		*OTHER MINOR.	
	M	F	M	F	M	F	M	F
APPRENTICES								
ON THE JOB TRAINEES								

FOR DEPARTMENT USE ONLY

\* Other minorities are defined as Asians (A) or Native Americans (N).  
 Please specify race of each employee shown in Other Minorities column.

**Note: See instructions on page 2**

**RETURN WITH BID**

**Contract No. 78239  
Various Counties  
Section D9 GUARDRAIL REPAIR FY12-1  
Various Routes  
District 9 Construction Funds**

**PART II. WORKFORCE PROJECTION - continued**

- B. Included in "Total Employees" under Table A is the total number of **new hires** that would be employed in the event the undersigned bidder is awarded this contract.

The undersigned bidder projects that: (number) \_\_\_\_\_ new hires would be recruited from the area in which the contract project is located; and/or (number) \_\_\_\_\_ new hires would be recruited from the area in which the bidder's principal office or base of operation is located.

- C. Included in "Total Employees" under Table A is a projection of numbers of persons to be employed directly by the undersigned bidder as well as a projection of numbers of persons to be employed by subcontractors.

The undersigned bidder estimates that (number) \_\_\_\_\_ persons will be directly employed by the prime contractor and that (number) \_\_\_\_\_ persons will be employed by subcontractors.

**PART III. AFFIRMATIVE ACTION PLAN**

- A. The undersigned bidder understands and agrees that in the event the foregoing minority and female employee utilization projection included under **PART II** is determined to be an underutilization of minority persons or women in any job category, and in the event that the undersigned bidder is awarded this contract, he/she will, prior to commencement of work, develop and submit a written Affirmative Action Plan including a specific timetable (geared to the completion stages of the contract) whereby deficiencies in minority and/or female employee utilization are corrected. Such Affirmative Action Plan will be subject to approval by the contracting agency and the **Department of Human Rights**.
- B. The undersigned bidder understands and agrees that the minority and female employee utilization projection submitted herein, and the goals and timetable included under an Affirmative Action Plan if required, are deemed to be part of the contract specifications.

Company \_\_\_\_\_ Telephone Number \_\_\_\_\_

Address \_\_\_\_\_

**NOTICE REGARDING SIGNATURE**

The Bidder's signature on the Proposal Signature Sheet will constitute the signing of this form. The following signature block needs to be completed if revisions are required.

Signature:  \_\_\_\_\_ Title: \_\_\_\_\_ Date: \_\_\_\_\_

- Instructions: All tables must include subcontractor personnel in addition to prime contractor personnel.
- Table A - Include both the number of employees that would be hired to perform the contract work and the total number currently employed (Table B) that will be allocated to contract work, and include all apprentices and on-the-job trainees. The "Total Employees" column should include all employees including all minorities, apprentices and on-the-job trainees to be employed on the contract work.
- Table B - Include all employees currently employed that will be allocated to the contract work including any apprentices and on-the-job trainees currently employed.
- Table C - Indicate the racial breakdown of the total apprentices and on-the-job trainees shown in Table A.

**RETURN WITH BID**  
**Contract No. 78239**  
**Various Counties**  
**Section D9 GUARDRAIL REPAIR FY12-1**  
**Various Routes**  
**District 9 Construction Funds**

PROPOSAL SIGNATURE SHEET

The undersigned bidder hereby makes and submits this bid on the subject Proposal, thereby assuring the Department that all requirements of the Invitation for Bids and rules of the Department have been met, that there is no misunderstanding of the requirements of paragraph 3 of this Proposal, and that the contract will be executed in accordance with the rules of the Department if an award is made on this bid.

Firm Name \_\_\_\_\_

(IF AN INDIVIDUAL)                      Signature of Owner \_\_\_\_\_

Business Address \_\_\_\_\_

\_\_\_\_\_

---

Firm Name \_\_\_\_\_

By \_\_\_\_\_

(IF A CO-PARTNERSHIP)                      Business Address \_\_\_\_\_

\_\_\_\_\_

Name and Address of All Members of the Firm:

\_\_\_\_\_

\_\_\_\_\_

---

Corporate Name \_\_\_\_\_

By \_\_\_\_\_

Signature of Authorized Representative

\_\_\_\_\_

Typed or printed name and title of Authorized Representative

(IF A CORPORATION)

(IF A JOINT VENTURE, USE THIS SECTION FOR THE MANAGING PARTY AND THE SECOND PARTY SHOULD SIGN BELOW)

Attest \_\_\_\_\_

Signature

Business Address \_\_\_\_\_

\_\_\_\_\_

---

Corporate Name \_\_\_\_\_

By \_\_\_\_\_

Signature of Authorized Representative

\_\_\_\_\_

Typed or printed name and title of Authorized Representative

(IF A JOINT VENTURE)

Attest \_\_\_\_\_

Signature

Business Address \_\_\_\_\_

\_\_\_\_\_

---

If more than two parties are in the joint venture, please attach an additional signature sheet.



Item No. \_\_\_\_\_

Letting Date \_\_\_\_\_

KNOW ALL MEN BY THESE PRESENTS, That We \_\_\_\_\_

as PRINCIPAL, and \_\_\_\_\_

\_\_\_\_\_ as SURETY, are held jointly, severally and firmly bound unto the STATE OF ILLINOIS in the penal sum of 5 percent of the total bid price, or for the amount specified in Article 102.09 of the "Standard Specifications for Road and Bridge Construction" in effect on the date of invitation for bids, whichever is the lesser sum, well and truly to be paid unto said STATE OF ILLINOIS, for the payment of which we bind ourselves, our heirs, executors, administrators, successors and assigns.

THE CONDITION OF THE FOREGOING OBLIGATION IS SUCH, that whereas, the PRINCIPAL has submitted a bid proposal to the STATE OF ILLINOIS, acting through the Department of Transportation, for the improvement designated by the Transportation Bulletin Item Number and Letting Date indicated above.

NOW, THEREFORE, if the Department shall accept the bid proposal of the PRINCIPAL; and if the PRINCIPAL shall, within the time and as specified in the bidding and contract documents, submit a DBE Utilization Plan that is accepted and approved by the Department; and if, after award by the Department, the PRINCIPAL shall enter into a contract in accordance with the terms of the bidding and contract documents including evidence of the required insurance coverages and providing such bond as specified with good and sufficient surety for the faithful performance of such contract and for the prompt payment of labor and material furnished in the prosecution thereof; or if, in the event of the failure of the PRINCIPAL to make the required DBE submission or to enter into such contract and to give the specified bond, the PRINCIPAL pays to the Department the difference not to exceed the penalty hereof between the amount specified in the bid proposal and such larger amount for which the Department may contract with another party to perform the work covered by said bid proposal, then this obligation shall be null and void, otherwise, it shall remain in full force and effect.

IN THE EVENT the Department determines the PRINCIPAL has failed to comply with any requirement as set forth in the preceding paragraph, then Surety shall pay the penal sum to the Department within fifteen (15) days of written demand therefor. If Surety does not make full payment within such period of time, the Department may bring an action to collect the amount owed. Surety is liable to the Department for all its expenses, including attorney's fees, incurred in any litigation in which it prevails either in whole or in part.

In TESTIMONY WHEREOF, the said PRINCIPAL and the said SURETY have caused this instrument to be signed by their respective officers this \_\_\_\_\_ day of \_\_\_\_\_ A.D., \_\_\_\_\_.

**PRINCIPAL**

**SURETY**

\_\_\_\_\_  
(Company Name)

\_\_\_\_\_  
(Company Name)

By \_\_\_\_\_  
(Signature & Title)

By: \_\_\_\_\_  
(Signature of Attorney-in-Fact)

**Notary Certification for Principal and Surety**

STATE OF ILLINOIS,  
County of \_\_\_\_\_

I, \_\_\_\_\_, a Notary Public in and for said County, do hereby certify that \_\_\_\_\_ and \_\_\_\_\_  
(Insert names of individuals signing on behalf of PRINCIPAL & SURETY)

who are each personally known to me to be the same persons whose names are subscribed to the foregoing instrument on behalf of PRINCIPAL and SURETY, appeared before me this day in person and acknowledged respectively, that they signed and delivered said instrument as their free and voluntary act for the uses and purposes therein set forth.

Given under my hand and notarial seal this \_\_\_\_\_ day of \_\_\_\_\_ A.D. \_\_\_\_\_

My commission expires \_\_\_\_\_

\_\_\_\_\_  
Notary Public

In lieu of completing the above section of the Proposal Bid Form, the Principal may file an Electronic Bid Bond. By signing the proposal and marking the check box next to the Signature and Title line below, the Principal is ensuring the identified electronic bid bond has been executed and the Principal and Surety are firmly bound unto the State of Illinois under the conditions of the bid bond as shown above.

Electronic Bid Bond ID# \_\_\_\_\_ Company / Bidder Name \_\_\_\_\_  \_\_\_\_\_  
Signature and Title

**(1) Policy**

It is public policy that disadvantageded businesses as defined in 49 CFR Part 26 and the Special Provision shall have the maximum opportunity to participate in the performance of contracts financed in whole or in part with Federal or State funds. Consequently the requirements of 49 CFR Part 26 apply to this contract.

**(2) Obligation**

The contractor agrees to ensure that disadvantageded businesses as defined in 49 CFR Part 26 and the Special Provision have the maximum opportunity to participate in the performance of contracts or subcontracts financed in whole or in part with Federal or State funds. The contractor shall take all necessary and reasonable steps in accordance with 49 CFR Part 26 and the Special Provision to ensure that said businesses have the maximum opportunity to compete for and perform under this contract. The contractor shall not discriminate on the basis of race, color, national origin or sex in the award and performance of contracts.

**(3) Project and Bid Identification**

Complete the following information concerning the project and bid:

Route _____	Total Bid _____
Section _____	Contract DBE Goal _____ (Percent) _____ (Dollar Amount)
Project _____	
County _____	
Letting Date _____	
Contract No. _____	
Letting Item No. _____	

**(4) Assurance**

I, acting in my capacity as an officer of the undersigned bidder (or bidders if a joint venture), hereby assure the Department that on this project my company : (check one)

Meets or exceeds contract award goals and has provided documented participation as follows:  
Disadvantaged Business Participation \_\_\_\_\_ percent

Attached are the signed participation statements, forms SBE 2025, required by the Special Provision evidencing availability and use of each business participating in this plan and assuring that each business will perform a commercially useful function in the work of the contract.

Failed to meet contract award goals and has included good faith effort documentation to meet the goals and that my company has provided participation as follows:

Disadvantaged Business Participation \_\_\_\_\_ percent

The contract goals should be accordingly modified or waived. Attached is all information required by the Special Provision in support of this request including good faith effort. Also attached are the signed participation statements, forms SBE 2025, required by the Special Provision evidencing availability and use of each business participating in this plan and assuring that each business will perform a commercially useful function in the work of the contract.

\_\_\_\_\_  
Company

By \_\_\_\_\_

Title \_\_\_\_\_

Date \_\_\_\_\_

The "as read" Low Bidder is required to comply with the Special Provision.

Submit only one utilization plan for each project. The utilization plan shall be submitted in accordance with the special provision.

Bureau of Small Business Enterprises      **Local Let Projects**  
2300 South Dirksen Parkway                  Submit forms to the  
Springfield, Illinois 62764                      Local Agency



**Illinois Department  
of Transportation**

**DBE Participation Statement**

Subcontractor Registration \_\_\_\_\_

Letting \_\_\_\_\_

**Participation Statement**

Item No. \_\_\_\_\_

(1) Instructions

Contract \_\_\_\_\_

This form must be completed for each disadvantaged business participating in the Utilization Plan. This form shall be submitted in accordance with the special provision and will be attached to the Utilization Plan form. If additional space is needed complete an additional form for the firm.

(2) Work

Pay Item No.	Description	Quantity	Unit Price	Total
Total				

(3) Partial Payment Items

For any of the above items which are partial pay items, specifically describe the work and subcontract dollar amount:

(4) Commitment

The undersigned certify that the information included herein is true and correct, and that the DBE firm listed below has agreed to perform a commercially useful function in the work of the contract item(s) listed above and to execute a contract with the prime contractor. The undersigned further understand that no changes to this statement may be made without prior approval from the Department's Bureau of Small Business Enterprises and that complete and accurate information regarding actual work performed on this project and the payment therefore must be provided to the Department.

\_\_\_\_\_  
Signature for Prime Contractor

\_\_\_\_\_  
Signature for DBE Firm

Title \_\_\_\_\_

Title \_\_\_\_\_

Date \_\_\_\_\_

Date \_\_\_\_\_

Contact \_\_\_\_\_

Contact \_\_\_\_\_

Phone \_\_\_\_\_

Phone \_\_\_\_\_

Firm Name \_\_\_\_\_

Firm Name \_\_\_\_\_

Address \_\_\_\_\_

Address \_\_\_\_\_

City/State/Zip \_\_\_\_\_

City/State/Zip \_\_\_\_\_

E \_\_\_\_\_

WC \_\_\_\_\_

The Department of Transportation is requesting disclosure of information that is necessary to accomplish the statutory purpose as outlined under the state and federal law. Disclosure of this information is **REQUIRED**. Failure to provide any information will result in the contract not being awarded. This form has been approved by the State Forms Management Center.



# PROPOSAL ENVELOPE



# PROPOSALS

for construction work advertised for bids by the  
Illinois Department of Transportation

Item No.	Item No.	Item No.

Submitted By:

Name:
Address:
Phone No.

Bidders should use an IDOT proposal envelope or affix this form to the front of a 10" x 13" envelope for the submittal of bids. If proposals are mailed, they should be enclosed in a second or outer envelope addressed to:

Engineer of Design and Environment - Room 326  
Illinois Department of Transportation  
2300 South Dirksen Parkway  
Springfield, Illinois 62764

## **NOTICE**

**Individual bids, including Bid Bond and/or supplemental information if required, should be securely stapled.**

# CONTRACTOR OFFICE COPY OF CONTRACT SPECIFICATIONS

---

## NOTICE

None of the following material needs to be returned with the bid package unless the special provisions require documentation and/or other information to be submitted.

**Contract No. 78239**  
**Various Counties**  
**Section D9 GUARDRAIL REPAIR FY12-1**  
**Various Routes**  
**District 9 Construction Funds**



**Illinois Department of Transportation**

## **SUBCONTRACTOR DOCUMENTATION**

Public Acts 96-0795 and 96-0920, enacted substantial changes to the provisions of the Illinois Procurement Code (30 ILCS 500). Among the changes are provisions affecting subcontractors. The Contractor awarded this contract will be required as a material condition of the contract to implement and enforce the contract requirements applicable to subcontractors approved in accordance with article 108.01 of the Standard Specifications for Road and Bridge Construction.

If the Contractor seeks approval of subcontractors to perform a portion of the work, and approval is granted by the Department, the Contractor shall provide a copy of the subcontract to the Chief Procurement Officer within 20 calendar days after execution of the subcontract.

The subcontract shall contain the certifications required to be made by subcontractors pursuant to Article 50 of the Illinois Procurement Code. This Notice to Bidders includes a document incorporating all required subcontractor certifications and disclosures for use by the Contractor in compliance with this mandate. The document is entitled State Required Ethical Standards Governing Subcontractors.

## RETURN WITH SUBCONTRACT

### STATE ETHICAL STANDARDS GOVERNING SUBCONTRACTORS

Article 50 of the Illinois Procurement Code establishes the duty of all State chief procurement officers, State purchasing officers, and their designees to maximize the value of the expenditure of public moneys in procuring goods, services, and contracts for the State of Illinois and to act in a manner that maintains the integrity and public trust of State government. In discharging this duty, they are charged by law to use all available information, reasonable efforts, and reasonable actions to protect, safeguard, and maintain the procurement process of the State of Illinois.

The certifications hereinafter made by the subcontractor are each a material representation of fact upon which reliance is placed should the Department approve the subcontractor. The chief procurement officer may terminate or void the subcontract approval if it is later determined that the bidder or subcontractor rendered a false or erroneous certification.

Section 50-2 of the Illinois Procurement Code provides that every person that has entered into a multi-year contract and every subcontractor with a multi-year subcontract shall certify, by July 1 of each fiscal year covered by the contract after the initial fiscal year, to the responsible chief procurement officer whether it continues to satisfy the requirements of Article 50 pertaining to the eligibility for a contract award. If a contractor or subcontractor is not able to truthfully certify that it continues to meet all requirements, it shall provide with its certification a detailed explanation of the circumstances leading to the change in certification status. A contractor or subcontractor that makes a false statement material to any given certification required under Article 50 is, in addition to any other penalties or consequences prescribed by law, subject to liability under the Whistleblower Reward and Protection Act for submission of a false claim.

#### **A. Bribery**

1. The Illinois Procurement Code provides:

Section 50-5. Bribery.

(a) Prohibition. No person or business shall be awarded a contract or subcontract under this Code who:

(1) has been convicted under the laws of Illinois or any other state of bribery or attempting to bribe an officer or employee of the State of Illinois or any other state in that officer's or employee's official capacity; or

(2) has made an admission of guilt of that conduct that is a matter of record but has not been prosecuted for that conduct.

(b) Businesses. No business shall be barred from contracting with any unit of State or local government, or subcontracting under such a contract, as a result of a conviction under this Section of any employee or agent of the business if the employee or agent is no longer employed by the business and:

(1) the business has been finally adjudicated not guilty; or

(2) the business demonstrates to the governmental entity with which it seeks to contract, or which is signatory to the contract to which the subcontract relates, and that entity finds that the commission of the offense was not authorized, requested, commanded, or performed by a director, officer, or high managerial agent on behalf of the business as provided in paragraph (2) of subsection (a) of Section 5-4 of the Criminal Code of 1961.

(c) Conduct on behalf of business. For purposes of this Section, when an official, agent, or employee of a business committed the bribery or attempted bribery on behalf of the business and in accordance with the direction or authorization of a responsible official of the business, the business shall be chargeable with the conduct.

(d) Certification. Every bid submitted to and contract executed by the State, and every subcontract subject to Section 20-120 of the Procurement Code shall contain a certification by the contractor or the subcontractor, respectively, that the contractor or subcontractor is not barred from being awarded a contract or subcontract under this Section and acknowledges that the chief procurement officer may declare the related contract void if any certifications required by this Section are false. A contractor who makes a false statement, material to the certification, commits a Class 3 felony.

2. The contractor or subcontractor certifies that it is not barred from being awarded a contract under Section 50.5.

#### **B. Felons**

1. The Illinois Procurement Code provides:

Section 50-10. Felons. Unless otherwise provided, no person or business convicted of a felony shall do business with the State of Illinois or any State agency, or enter into a subcontract, from the date of conviction until 5 years after the date of completion of the sentence for that felony, unless no person held responsible by a prosecutorial office for the facts upon which the conviction was based continues to have any involvement with the business.

2. Certification. Every bid submitted to and contract executed by the State and every subcontract subject to Section 20-120 of the Procurement Code shall contain a certification by the bidder or contractor or subcontractor, respectively, that the bidder, contractor, or subcontractor is not barred from being awarded a contract or subcontract under this Section and acknowledges that the chief procurement officer may declare the related contract void if any of the certifications required by this Section are false.

**RETURN WITH SUBCONTRACT**

**C. Debt Delinquency**

1. The Illinois Procurement Code provides:

Section 50-11 and 50-12. Debt Delinquency.

The contractor or bidder or subcontractor, respectively, certifies that it, or any affiliate, is not barred from being awarded a contract or subcontract under the Procurement Code. Section 50-11 prohibits a person from entering into a contract with a State agency, or entering into a subcontract, if it knows or should know that it, or any affiliate, is delinquent in the payment of any debt to the State as defined by the Debt Collection Board. Section 50-12 prohibits a person from entering into a contract with a State agency, or entering into a subcontract, if it, or any affiliate, has failed to collect and remit Illinois Use Tax on all sales of tangible personal property into the State of Illinois in accordance with the provisions of the Illinois Use Tax Act. The bidder or contractor or subcontractor, respectively, further acknowledges that the chief procurement officer may declare the related contract void if this certification is false or if the bidder, contractor, or subcontractor, or any affiliate, is determined to be delinquent in the payment of any debt to the State during the term of the contract.

**D. Prohibited Bidders, Contractors and Subcontractors**

1. The Illinois Procurement Code provides:

Section 50-10.5 and 50-60(c). Prohibited bidders, contractors and subcontractors.

The bidder or contractor or subcontractor, respectively, certifies in accordance with 30 ILCS 500/50-10.5 that no officer, director, partner or other managerial agent of the contracting business has been convicted of a felony under the Sarbanes-Oxley Act of 2002 or a Class 3 or Class 2 felony under the Illinois Securities Law of 1953 or if in violation of Subsection (c) for a period of five years from the date of conviction.. Every bid submitted to and contract executed by the State and every subcontract subject to Section 20-120 of the Procurement Code shall contain a certification by the bidder, contractor, or subcontractor, respectively, that the bidder, contractor, or subcontractor is not barred from being awarded a contract or subcontract under this Section and acknowledges that the chief procurement officer shall declare the related contract void if any of the certifications completed pursuant to this Section are false.

**E. Section 42 of the Environmental Protection Act**

The bidder or contractor or subcontractor, respectively, certifies in accordance with 30 ILCS 500/50-12 that the bidder, contractor, or subcontractor, is not barred from being awarded a contract or entering into a subcontract under this Section which prohibits the bidding on or entering into contracts with the State of Illinois or a State agency, or entering into any subcontract, that is subject to the Procurement Code by a person or business found by a court or the Pollution Control Board to have committed a willful or knowing violation of Section 42 of the Environmental Protection Act for a period of five years from the date of the order. The bidder or contractor or subcontractor, respectively, acknowledges that the chief procurement officer may declare the contract void if this certification is false.

**The undersigned, on behalf of the subcontracting company, has read and understands the above certifications and makes the certifications as required by law.**

_____ Name of Subcontracting Company		
_____ Authorized Officer	_____ Date	

**RETURN WITH SUBCONTRACT**  
**SUBCONTRACTOR DISCLOSURES**

**I. DISCLOSURES**

- A.** The disclosures hereinafter made by the subcontractor are each a material representation of fact upon which reliance is placed. The subcontractor further certifies that the Department has received the disclosure forms for each subcontract.

The chief procurement officer may void the bid, contract, or subcontract, respectively, if it is later determined that the bidder or subcontractor rendered a false or erroneous disclosure. A contractor or subcontractor may be suspended or debarred for violations of the Procurement Code. Furthermore, the chief procurement officer may void the contract or subcontract.

**B. Financial Interests and Conflicts of Interest**

1. Section 50-35 of the Illinois Procurement Code provides that all subcontracts with a total value of \$25,000 or more from subcontractors identified in Section 20-120 of the Illinois Procurement Code, shall be accompanied by disclosure of the financial interests of the subcontractor. This disclosed information for the subcontractor, will be maintained as public information subject to release by request pursuant to the Freedom of Information Act, filed with the Procurement Policy Board, and shall be incorporated as a material term of the Prime Contractor's contract. Furthermore, pursuant to this Section, the Procurement Policy Board may recommend to allow or void a contract or subcontract based on a potential conflict of interest.

The financial interests to be disclosed shall include ownership or distributive income share that is in excess of 5%, or an amount greater than 60% of the annual salary of the Governor, of the subcontracting entity or its parent entity, whichever is less, unless the subcontractor is a publicly traded entity subject to Federal 10K reporting, in which case it may submit its 10K disclosure in place of the prescribed disclosure. If a subcontractor is a privately held entity that is exempt from Federal 10K reporting, but has more than 400 shareholders, it may submit the information that Federal 10K companies are required to report, and list the names of any person or entity holding any ownership share that is in excess of 5%. The disclosure shall include the names, addresses, and dollar or proportionate share of ownership of each person making the disclosure, their instrument of ownership or beneficial relationship, and notice of any potential conflict of interest resulting from the current ownership or beneficial interest of each person making the disclosure having any of the relationships identified in Section 50-35 and on the disclosure form.

**The current annual salary of the Governor is \$177,412.00.**

In addition, all disclosures shall indicate any other current or pending contracts, subcontracts, proposals, leases, or other ongoing procurement relationships the subcontracting entity has with any other unit of state government and shall clearly identify the unit and the contract, subcontract, proposal, lease, or other relationship.

2. **Disclosure Forms.** Disclosure Form A is attached for use concerning the individuals meeting the above ownership or distributive share requirements. Subject individuals should be covered each by one form. In addition, a second form (Disclosure Form B) provides for the disclosure of current or pending procurement relationships with other (non-IDOT) state agencies.

**C. Disclosure Form Instructions**

**Form A Instructions for Financial Information & Potential Conflicts of Interest**

If the subcontractor is a publicly traded entity subject to Federal 10K reporting, the 10K Report may be submitted to meet the requirements of Form A. If a subcontractor is a privately held entity that is exempt from Federal 10K reporting, but has more than 400 shareholders, it may submit the information that Federal 10K companies are required to report, and list the names of any person or entity holding any ownership share that is in excess of 5%. If a subcontractor is not subject to Federal 10K reporting, the subcontractor must determine if any individuals are required by law to complete a financial disclosure form. To do this, the subcontractor should answer each of the following questions. A "YES" answer indicates Form A must be completed. If the answer to each of the following questions is "NO", then the **NOT APPLICABLE STATEMENT** on the second page of Form A must be signed and dated by a person that is authorized to execute contracts for the subcontracting company. Note: These questions are for assistance only and are not required to be completed.

1. Does anyone in your organization have a direct or beneficial ownership share of greater than 5% of the bidding entity or parent entity? YES \_\_\_ NO \_\_\_
2. Does anyone in your organization have a direct or beneficial ownership share of less than 5%, but which has a value greater than 60% of the annual salary of the Governor? YES \_\_\_ NO \_\_\_
3. Does anyone in your organization receive more than 60% of the annual salary of the Governor of the subcontracting entity's or parent entity's distributive income? YES \_\_\_ NO \_\_\_

(Note: Distributive income is, for these purposes, any type of distribution of profits. An annual salary is not distributive income.)

4. Does anyone in your organization receive greater than 5% of the subcontracting entity's or parent entity's total distributive income, but which is less than 60% of the annual salary of the Governor? YES \_\_\_ NO \_\_\_

(Note: Only one set of forms needs to be completed per person per subcontract even if a specific individual would require a yes answer to more than one question.)

A "YES" answer to any of these questions requires the completion of Form A. The subcontractor must determine each individual in the subcontracting entity or the subcontracting entity's parent company that would cause the questions to be answered "Yes". Each form must be signed and dated by a person that is authorized to execute contracts for your organization. **Photocopied or stamped signatures are not acceptable.** The person signing can be, but does not have to be, the person for which the form is being completed. The subcontractor is responsible for the accuracy of any information provided.

If the answer to each of the above questions is "NO", then the **NOT APPLICABLE STATEMENT** on page 2 of Form A must be signed and dated by a person that is authorized to execute contracts for your company.

## RETURN WITH SUBCONTRACT

### **Form B: Instructions for Identifying Other Contracts & Procurement Related Information**

Disclosure Form B must be completed for each subcontract submitted by the subcontracting entity. *Note: Checking the NOT APPLICABLE STATEMENT on Form A does not allow the subcontractor to ignore Form B. Form B must be completed, checked, and dated or the subcontract will not be approved.*

The Subcontractor shall identify, by checking Yes or No on Form B, whether it has any pending contracts, subcontracts, leases, bids, proposals, or other ongoing procurement relationship with any other (non-IDOT) State of Illinois agency. If "No" is checked, the subcontractor only needs to complete the check box on the bottom of Form B. If "Yes" is checked, the subcontractor must list all non-IDOT State of Illinois agency pending contracts, subcontracts, leases, bids, proposals, and other ongoing procurement relationships. These items may be listed on Form B or on an attached sheet(s). Contracts with cities, counties, villages, etc. are not considered State of Illinois agency contracts and are not to be included. Contracts or subcontracts with other State of Illinois agencies such as the Department of Natural Resources or the Capital Development Board must be included.

ILLINOIS DEPARTMENT OF TRANSPORTATION

Form A Subcontractor: Financial Information & Potential Conflicts of Interest Disclosure

Subcontractor Name, Legal Address, City, State, Zip, Telephone Number, Email Address, Fax Number (if available)

Disclosure of the information contained in this Form is required by the Section 50-35 of the Illinois Procurement Code (30 ILCS 500). Subcontractors desiring to enter into a subcontract of a State of Illinois contract must disclose the financial information and potential conflict of interest information as specified in this Disclosure Form.

The current annual salary of the Governor is \$177,412.00.

DISCLOSURE OF FINANCIAL INFORMATION

1. Disclosure of Financial Information. The individual named below has an interest in the SUBCONTRACTOR (or its parent) in terms of ownership or distributive income share in excess of 5%, or an interest which has a value of more than 60% of the annual salary of the Governor.

FOR INDIVIDUAL (type or print information) NAME: ADDRESS Type of ownership/distributable income share: stock sole proprietorship Partnership other: (explain on separate sheet): % or \$ value of ownership/distributable income share:

2. Disclosure of Potential Conflicts of Interest. Check "Yes" or "No" to indicate which, if any, of the following potential conflict of interest relationships apply. If the answer to any question is "Yes", please attach additional pages and describe.

(a) State employment, currently or in the previous 3 years, including contractual employment of services. Yes \_\_\_ No \_\_\_

If your answer is yes, please answer each of the following questions.

- 1. Are you currently an officer or employee of either the Capitol Development Board or the Illinois State Toll Highway Authority? Yes \_\_\_ No \_\_\_
2. Are you currently appointed to or employed by any agency of the State of Illinois? If you are currently appointed to or employed by any agency of the State of Illinois, and your annual salary exceeds 60% of the annual salary of the Governor, provide the name the State agency for which you are employed and your annual salary.



**RETURN WITH SUBCONTRACT**

3. If you are currently appointed to or employed by any agency of the State of Illinois, and your annual salary exceeds 60% of the annual salary of the Governor, are you entitled to receive (i) more than 7 1/2% of the total distributable income of your firm, partnership, association or corporation, or (ii) an amount in excess of 100% of the annual salary of the Governor?  
Yes \_\_\_ No \_\_\_

4. If you are currently appointed to or employed by any agency of the State of Illinois, and your annual salary exceeds 60% of the annual salary of the Governor, are you and your spouse or minor children entitled to receive (i) more than 15 % in the aggregate of the total distributable income of your firm, partnership, association or corporation, or (ii) an amount in excess of two times the salary of the Governor?  
Yes \_\_\_ No \_\_\_

---

(b) State employment of spouse, father, mother, son, or daughter, including contractual employment services in the previous 2 years.

Yes \_\_\_ No \_\_\_

If your answer is yes, please answer each of the following questions.

1. Is your spouse or any minor children currently an officer or employee of the Capitol Development Board or the Illinois Toll Highway Authority?  
Yes \_\_\_ No \_\_\_

2. Is your spouse or any minor children currently appointed to or employed by any agency of the State of Illinois? If your spouse or minor children is/are currently appointed to or employed by any agency of the State of Illinois, and his/her annual salary exceeds 60% of the annual salary of the Governor, provide the name of your spouse and/or minor children, the name of the State agency for which he/she is employed and his/her annual salary. \_\_\_\_\_

---

3. If your spouse or any minor children is/are currently appointed to or employed by any agency of the State of Illinois, and his/her annual salary exceeds 60% of the annual salary of the Governor, as of 7/1/07 are you entitled to receive (i) more than 7 1/2% of the total distributable income of your firm, partnership, association or corporation, or (ii) an amount in excess of 100% of the annual salary of the Governor?  
Yes \_\_\_ No \_\_\_

4. If your spouse or any minor children are currently appointed to or employed by any agency of the State of Illinois, and his/her annual salary exceeds 60% of the annual salary of the Governor, are you and your spouse or minor children entitled to receive (i) more than 15 % in the aggregate of the total distributable income of your firm, partnership, association or corporation, or (ii) an amount in excess of two times the annual salary of the Governor?  
Yes \_\_\_ No \_\_\_

---

(c) Elective status; the holding of elective office of the State of Illinois, the government of the United States, any unit of local government authorized by the Constitution of the State of Illinois or the statutes of the State of Illinois currently or in the previous 3 years.  
Yes \_\_\_ No \_\_\_

---

(d) Relationship to anyone holding elective office currently or in the previous 2 years; spouse, father, mother, son, or daughter.  
Yes \_\_\_ No \_\_\_

---

(e) Appointive office; the holding of any appointive government office of the State of Illinois, the United States of America, or any unit of local government authorized by the Constitution of the State of Illinois or the statutes of the State of Illinois, which office entitles the holder to compensation in excess of the expenses incurred in the discharge of that office currently or in the previous 3 years.  
Yes \_\_\_ No \_\_\_

---

(f) Relationship to anyone holding appointive office currently or in the previous 2 years; spouse, father, mother, son, or daughter.  
Yes \_\_\_ No \_\_\_

---

(g) Employment, currently or in the previous 3 years, as or by any registered lobbyist of the State government.  
Yes \_\_\_ No \_\_\_

**RETURN WITH SUBCONTRACT**

(h) Relationship to anyone who is or was a registered lobbyist in the previous 2 years; spouse, father, mother, son, or daughter. Yes \_\_\_ No \_\_\_

(i) Compensated employment, currently or in the previous 3 years, by any registered election or reelection committee registered with the Secretary of State or any county clerk of the State of Illinois, or any political action committee registered with either the Secretary of State or the Federal Board of Elections. Yes \_\_\_ No \_\_\_

(j) Relationship to anyone; spouse, father, mother, son, or daughter; who was a compensated employee in the last 2 years by any registered election or re-election committee registered with the Secretary of State or any county clerk of the State of Illinois, or any political action committee registered with either the Secretary of State or the Federal Board of Elections. Yes \_\_\_ No \_\_\_

**3. Communication Disclosure.**

Disclose the name and address of each lobbyist and other agent of the bidder or offeror who is not identified in Section 2 of this form, who is has communicated, is communicating, or may communicate with any State officer or employee concerning the bid or offer. This disclosure is a continuing obligation and must be promptly supplemented for accuracy throughout the process and throughout the term of the contract. If no person is identified, enter "None" on the line below:

Name and address of person(s): \_\_\_\_\_  
\_\_\_\_\_  
\_\_\_\_\_  
\_\_\_\_\_

**RETURN WITH SUBCONTRACT**

**4. Debarment Disclosure.** For each of the persons identified under Sections 2 and 3 of this form, disclose whether any of the following has occurred within the previous 10 years: debarment from contracting with any governmental entity; professional licensure discipline; bankruptcies; adverse civil judgments and administrative findings; and criminal felony convictions. This disclosure is a continuing obligation and must be promptly supplemented for accuracy throughout the procurement process and term of the contract. If no person is identified, enter "None" on the line below:

Name of person(s): \_\_\_\_\_

Nature of disclosure: \_\_\_\_\_  
\_\_\_\_\_  
\_\_\_\_\_

**APPLICABLE STATEMENT**

**This Disclosure Form A is submitted on behalf of the INDIVIDUAL named on previous page. Under penalty of perjury, I certify the contents of this disclosure to be true and accurate to the best of my knowledge.**

Completed by:  \_\_\_\_\_ Date \_\_\_\_\_  
Signature of Individual or Authorized Officer

**NOT APPLICABLE STATEMENT**

**Under penalty of perjury, I have determined that no individuals associated with this organization meet the criteria that would require the completion of this Form A.**

**This Disclosure Form A is submitted on behalf of the SUBCONTRACTOR listed on the previous page.**

\_\_\_\_\_ Date \_\_\_\_\_  
Signature of Authorized Officer

RETURN WITH SUBCONTRACT

ILLINOIS DEPARTMENT  
OF TRANSPORTATION

Form B  
Subcontractor: Other Contracts &  
Procurement Related Information  
Disclosure

Subcontractor Name		
Legal Address		
City, State, Zip		
Telephone Number	Email Address	Fax Number (if available)

Disclosure of the information contained in this Form is required by the Section 50-35 of the Illinois Procurement Act (30 ILCS 500). This information shall become part of the publicly available contract file. This Form B must be completed for subcontracts with a total value of \$25,000 or more, from subcontractors identified in Section 20-120 of the Illinois Procurement Code, and for all open-ended contracts.

**DISCLOSURE OF OTHER CONTRACTS, SUBCONTRACTS, AND PROCUREMENT RELATED INFORMATION**

**1. Identifying Other Contracts & Procurement Related Information.** The SUBCONTRACTOR shall identify whether it has any pending contracts, subcontracts, including leases, bids, proposals, or other ongoing procurement relationship with any other State of Illinois agency: Yes \_\_\_ No \_\_\_

If "No" is checked, the subcontractor only needs to complete the signature box on the bottom of this page.

**2. If "Yes" is checked.** Identify each such relationship by showing State of Illinois agency name and other descriptive information such as bid or project number (attach additional pages as necessary). SEE DISCLOSURE FORM INSTRUCTIONS:

**THE FOLLOWING STATEMENT MUST BE CHECKED**

<input type="checkbox"/>	_____	_____
	Signature of Authorized Officer	Date



## NOTICE TO BIDDERS

- 1. TIME AND PLACE OF OPENING BIDS.** Sealed proposals for the improvement described herein will be received by the Department of Transportation at the Harry R. Hanley Building, 2300 South Dirksen Parkway, in Springfield, Illinois until 10:00 o'clock a.m., June 17, 2011. All bids will be gathered, sorted, publicly opened and read in the auditorium at the Department of Transportation's Harry R. Hanley Building shortly after the 10:00 a.m. cut off time.
- 2. DESCRIPTION OF WORK.** The proposed improvement is identified and advertised for bids in the Invitation for Bids as:

**Contract No. 78239  
Various Counties  
Section D9 GUARDRAIL REPAIR FY12-1  
Various Routes  
District 9 Construction Funds**

**This project consists of repairing and replacing damaged guardrail, barrier terminals, attenuators, cable median barrier and fencing on a "call out" basis throughout District 9.**

- 3. INSTRUCTIONS TO BIDDERS.** (a) This Notice, the invitation for bids, proposal and letter of award shall, together with all other documents in accordance with Article 101.09 of the Standard Specifications for Road and Bridge Construction, become part of the contract. Bidders are cautioned to read and examine carefully all documents, to make all required inspections, and to inquire or seek explanation of the same prior to submission of a bid.  
  
(b) State law, and, if the work is to be paid wholly or in part with Federal-aid funds, Federal law requires the bidder to make various certifications as a part of the proposal and contract. By execution and submission of the proposal, the bidder makes the certification contained therein. A false or fraudulent certification shall, in addition to all other remedies provided by law, be a breach of contract and may result in termination of the contract.
- 4. AWARD CRITERIA AND REJECTION OF BIDS.** This contract will be awarded to the lowest responsive and responsible bidder considering conformity with the terms and conditions established by the Department in the rules, Invitation for Bids and contract documents. The issuance of plans and proposal forms for bidding based upon a prequalification rating shall not be the sole determinant of responsibility. The Department reserves the right to determine responsibility at the time of award, to reject any or all proposals, to readvertise the proposed improvement, and to waive technicalities.

By Order of the  
Illinois Department of Transportation

Gary Hannig,  
Secretary

INDEX  
FOR  
SUPPLEMENTAL SPECIFICATIONS  
AND RECURRING SPECIAL PROVISIONS

Adopted January 1, 2011

This index contains a listing of SUPPLEMENTAL SPECIFICATIONS and frequently used RECURRING SPECIAL PROVISIONS.

ERRATA            Standard Specifications for Road and Bridge Construction (Adopted 1-1-07) (Revised 1-1-11)

SUPPLEMENTAL SPECIFICATIONS

<u>Std. Spec. Sec.</u>	<u>Page No.</u>
201 Clearing, Tree Removal and Protection .....	1
205 Embankment .....	2
251 Mulch .....	3
253 Planting Woody Plants .....	4
280 Temporary Erosion Control .....	6
406 Hot-Mix Asphalt Binder and Surface Course .....	7
420 Portland Cement Concrete Pavement .....	11
443 Reflective Crack Control Treatment .....	12
501 Removal of Existing Structures .....	15
502 Excavation for Structures .....	16
503 Concrete Structures .....	17
504 Precast Concrete Structures .....	18
505 Steel Structures .....	19
508 Reinforcement Bars .....	20
540 Box Culverts .....	21
581 Waterproofing Membrane System .....	22
606 Concrete Gutter, Curb, Median, and Paved Ditch .....	23
630 Steel Plate Beam Guardrail .....	24
633 Removing and Reerecting Guardrail and Terminals .....	25
637 Concrete Barrier .....	26
664 Chain Link Fence .....	27
669 Removal and Disposal of Regulated Substances .....	28
672 Sealing Abandoned Water Wells .....	29
701 Work Zone Traffic Control and Protection .....	30
720 Sign Panels and Appurtenances .....	32
721 Sign Panel Overlay .....	33
722 Demountable Sign Legend Characters and Arrows .....	34
726 Mile Post Marker Assembly .....	35
733 Overhead Sign Structures .....	36
780 Pavement Striping .....	37
782 Prismatic Reflectors .....	42
783 Pavement Marking and Marker Removal .....	43
801 Electrical Requirements .....	44
805 Electrical Service Installation – Traffic Signals .....	45
821 Roadway Luminaires .....	46
836 Pole Foundation .....	47
838 Breakaway Devices .....	48
843 Removal of Navigational Obstruction Warning Lighting System .....	49
862 Uninterruptable Power Supply .....	50
873 Electric Cable .....	52
878 Traffic Signal Concrete Foundation .....	54
1003 Fine Aggregates .....	55
1004 Coarse Aggregates .....	56
1005 Stone and Broken Concrete .....	57
1006 Metals .....	58

1008	Structural Steel Coatings .....	60
1010	Finely Divided Materials .....	65
1020	Portland Cement Concrete .....	66
1022	Concrete Curing Materials .....	77
1024	Nonshrink Grout .....	78
1026	Concrete Sealer .....	79
1030	Hot-Mix Asphalt .....	80
1032	Bituminous Materials .....	87
1042	Precast Concrete Products .....	90
1062	Reflective Crack Control System .....	92
1069	Pole and Tower .....	94
1074	Control Equipment .....	97
1076	Wire and Cable .....	102
1077	Post and Foundation .....	103
1080	Fabric Materials .....	105
1081	Materials for Planting .....	106
1083	Elastomeric Bearings .....	108
1090	Sign Base .....	109
1091	Sign Face .....	111
1092	Sign Legend and Supplemental Panels .....	119
1093	Sign Supports .....	120
1094	Overhead Sign Structures .....	122
1095	Pavement Markings .....	128
1097	Reflectors .....	136
1101	General Equipment .....	137
1102	Hot-Mix Asphalt Equipment .....	138
1103	Portland Cement Concrete Equipment .....	140
1105	Pavement Marking Equipment .....	141
1106	Work Zone Traffic Control Devices .....	143

RECURRING SPECIAL PROVISIONS

The following RECURRING SPECIAL PROVISIONS indicated by an "X" are applicable to this contract and are included by reference:

<u>CHECK SHEET #</u>	<u>PAGE NO.</u>
1	145
2	148
3 X	149
4 X	159
5 X	164
6	169
7	170
8	171
9	172
10	175
11	178
12	180
13	184
14	186
15	187
16	189
17	190
18	192
19	193
20 X	194
21	198
22	200
23	202
24	204
25	205
26	206
27	207
28	208
29	209
30	210
31	218
32	230
33	231



## TABLE OF CONTENTS

LOCATION OF PROJECT .....	1
DESCRIPTION OF PROJECT .....	1
MONTHLY LABOR SUMMARY AND ACTIVITY REPORTING SYSTEM .....	1
TRAFFIC CONTROL PLAN .....	4
CONSTRUCTION AND MAINTENANCE SIGN SUPPORTS .....	4
STATUS OF UTILITIES TO BE ADJUSTED .....	5
TERM OF CONTRACT .....	5
PROSECUTION OF THE WORK .....	5
CONTROL OF WORK .....	5
COMPLETION DATE .....	6
FAILURE TO COMPLETE OR REPAIR – LIQUIDATED DAMAGES .....	6
TRAFFIC CONTROL AUTHORIZATION REQUEST .....	6
INTERPRETATION OF QUANTITIES AND PAYMENT .....	7
WORK ORDER .....	7
CLASS OF WORK .....	10
COMPLETION TIME FOR WORK ORDERS .....	10
CONTRACTOR'S RESPONSIBILITY FOR DAMAGE TO EXISTING STRUCTURES.....	10
THE CONTRACTOR'S LIABILITY .....	10
PROTECTION FOR DAMAGED LOCATIONS.....	11
REALIGNING POSTS.....	11
REMOVAL OR REPAIR OF GUARDRAIL.....	11
FINAL CLEAN UP .....	12
CONTRACTOR CONTACTS.....	12
CLEARING.....	12
FURNISHING AND INSTALLING GUARDRAIL BLOCKS .....	13
FURNISHING AND INSTALLING RAIL ELEMENT PLATES.....	13
TRAFFIC BARRIER TERMINAL, TYPE 1, SPECIAL AND TYPE 1 SPECIAL (FLARED).....	14
FURNISHING AND INSTALLING RADIUS RAIL ELEMENT PLATES .....	15
TRAFFIC BARRIER TERMINAL, TYPE 5, 5A, 6, 6A & 6B (SPECIAL).....	15
TRAFFIC BARRIER TERMINAL, TYPE 2 (SPECIAL) .....	16
HIGH TENSION CABLE MEDIAN BARRIER TERMINAL.....	16
FURNISHING AND SETTING STEEL POSTS.....	17
REMOVAL AND REINSTALLATION OF EXISTING IMPACT ATTENUATORS.....	17
REPAIR TRAFFIC BARRIER TERMINAL TYPE 1 SPECIAL (TANGENT).....	18
FURNISHING AND INSTALLING EXTRUDER HEAD .....	18
REPAIR TRAFFIC BARRIER TERMINAL TYPE 1 SPECIAL (FLARED) AND TYPE 3 (SPECIAL).....	19
REPAIR TRAFFIC BARRIER TERMINAL TYPE 2, 5, 5A, 6, 6A & 6B.....	19
REPAIR HIGH TENSION CABLE MEDIAN BARRIER TERMINAL .....	20

FURNISHING AND SETTING CABLE ROAD GUARDPOSTS (HIGH TENSION) ..... 20  
FURNISHING AND SETTING STEEL POSTS (MODIFIED)..... 21  
FURNISHING AND SETTING STEEL POSTS (SPECIAL) ..... 21  
REALIGNING POSTS..... 21  
LOCATING UNDERGROUND CABLE, SPECIAL..... 22  
CHAIN LINK FENCE (SPECIAL) ..... 22  
GRADING..... 22  
STRUCTURAL REPAIR OF CONCRETE ..... 22  
APPROVAL OF PROPOSED BORROW AREAS, USE AREAS, AND/OR WASTE AREAS (BDE) ..... 30  
CEMENT (BDE) ..... 31  
CONCRETE ADMIXTURES (BDE) ..... 33  
CONSTRUCTION AIR QUALITY - DIESEL VEHICLE EMISSIONS CONTROL (BDE) ..... 36  
CONSTRUCTION AIR QUALITY - IDLING RESTRICTIONS (BDE)..... 37  
DISADVANTAGED BUSINESS ENTERPRISE PARTICIPATION (BDE) ..... 38  
EQUIPMENT RENTAL RATES (BDE)..... 45  
HIGH TENSION CABLE MEDIAN BARRIER (BDE) ..... 46  
IMPACT ATTENUATORS (BDE) ..... 48  
LIQUIDATED DAMAGES (BDE)..... 49  
NATIONAL POLLUTANT DISCHARGE ELIMINATION SYSTEM / EROSION AND SEDIMENT  
CONTROL DEFICIENCY DEDUCTION (BDE) ..... 50  
PAYMENTS TO SUBCONTRACTORS (BDE) ..... 51  
POST MOUNTING OF SIGNS (BDE)..... 52  
PUBLIC CONVENIENCE AND SAFETY (BDE) ..... 52  
SEEDING (BDE) ..... 52  
SELECTION OF LABOR (BDE)..... 55  
SUBCONTRACTOR MOBILIZATION PAYMENTS (BDE) ..... 55  
TRAFFIC BARRIER TERMINAL, TYPE 6 (BDE) ..... 56  
UTILITY COORDINATION AND CONFLICTS (BDE)..... 56  
STEEL COST ADJUSTMENT (BDE) (RETURN FORM WITH BID) ..... 61

**STATE OF ILLINOIS**  
**SPECIAL PROVISIONS**

The following Special Provisions supplement the "Standard Specifications for Road and Bridge Construction," adopted January 1, 2007, the latest edition of the "Manual on Uniform Traffic Control Devices for Streets and Highways," and the "Manual of Test Procedures for Materials" in effect on the date of invitation for bids, and the Supplemental Specifications and Recurring Special Provisions indicated on the Check Sheet included herein which apply to and govern the construction of Various Routes; Section D9 Guardrail Repair FY12-1; Various Counties; Contract No. 78239 and in case of conflict with any part or parts of said Specifications, the said Special Provisions shall take precedence and shall govern.

**LOCATION OF PROJECT**

This work is located on various State maintained routes district wide in Perry, Jefferson, Jackson, Franklin, Hamilton, White, Williamson, Saline, Gallatin, Union, Johnson, Pope, Hardin, Alexander, Pulaski and Massac Counties.

**DESCRIPTION OF PROJECT**

The work to be completed under this contract consists of repairing or replacing existing damaged steel plate beam guardrail, high tension cable median barrier and traffic barrier terminals on a work order basis. Items shall be repaired or replaced in accordance with the details and standards in the plans.

Other items of work include: sand barrels and cable median barrier.

**MONTHLY LABOR SUMMARY AND ACTIVITY REPORTING SYSTEM**

Effective: 1-1-1995

Revised June 2001

I. Monthly Labor Summary Report, Form SBE 148

The prime contractor and each first and second tier sub-contractor, (hereinafter referred to as "subcontractor") shall submit a certified Monthly Labor Summary Report directly to the District Engineer.

This report is in lieu of submittal of the Monthly Workforce Analysis Report, Form SBE 956.

This report must be received in District 9 no later than the tenth day of the next month.

This Report shall be submitted by the prime contractor and each subcontractor, for each consecutive month, from the start, to the completion of their work on the contract.

The data source for this Report will be a summation of all personnel and hours worked on each subject contract for the month based on weekly payrolls for that month.

The Monthly Labor Summary Report is required to be submitted in one of the following formats:

- a.) For contractors having IDOT contracts valued in the aggregate at \$250,000 or less, the report may be typed or clearly handwritten using Form SBE 148 for submittal to the District Engineer for District Eight.
- b.) For contractors having IDOT contracts valued in the aggregate at more than \$250,000, the report must be submitted in a specific "Fixed Length Comma Delimited ASCII Text File Format". The subject file format is detailed on the next page. Submittal of this file may be by 3.5 inch disk, modem, or by e-mail.

II. Monthly Contract Activity Report, Form SBE 248

The prime contractor and each subcontractor shall submit a monthly report directly to the District Engineer reflecting their contract activity on all Illinois Department of Transportation contracts they have in force in District Eight.

This report shall be submitted for each consecutive month, from the start, to the completion of all contracts in District Eight.

The report must be received in the District Office no later than the tenth day of the next month.

Monthly Labor Summary and Activity Reporting System Codes and Formats

Indicated below for your reference are the Employee Codes and File Formats required for this system.

I.) Monthly Labor Summary Report, Form SBE 148

The following employee codes are to be used to identify each individual on the Summary Report:

- 1. **Gender:** M - Male F - Female
- 2. **Ethnic Group:** 1 - White 2 - Black 3 - Hispanic  
4 - American Indian/Alaskan Native 5 - Asian/Pacific Islander
- 3. **Work Classification:** OF - Official SU - Supervisor FO - Foremen  
CL - Clerical CA - Carpenter EO - Operator ME - Mechanic  
TD - Truck Driver IW - Ironworker PA - Painter OT - Other  
EL - Electrician PP - Pipefitter TE - Technical LA - Laborer  
CM - Cement Mason
- 4. **Employee Status:** O - Owner Operator J - Journeyman  
C - Company A - Apprentice T - Trainee

Specific “Fixed Length Comma Delimited ASCII File Format”

Order	Field Name	Type	Size
1	Contractor Number	A	4
2	Contractor Reference Number	A	6
3	Contract Number	A	5
4	Period (07/28/2000)	D	10
5	SSN (111-11-1111)	A	11
6	Name	A	40
7	Gender	A	1
8	Ethnic Group	A	1
9	Work Classification	A	1
10	Employee Status	A	1
11	Total Hours (000060.00)	N	10

File Name Conventions: (Contractor Number + Report Month/Year).Txt  
i.e. 20001298.Txt

II.) Monthly Contract Activity Report, Form SBE 248

The following activity codes are to be used to identify the contractor’s contract status each month on the Monthly Activity Report, Form SBE 248:

- A. Contract Status:      1 - Not Started      2 - Active      3 - No Work  
                                 4 - Suspended      5 - Complete

Failure to comply with this special provision may result in the withholding of payments to the contractor, and/or cancellation, termination, or suspension of the contract in whole or part.

Compliance with this Special Provision shall be considered incidental to the cost of the contract and no additional compensation will be allowed for any costs incurred.

All prime and subcontractors having contracts in the aggregate exceeding \$250,000 must provide a “Fixed Length Comma Delimited ASCII File” for approval prior to the start of construction.

This Special Provision must be included in each subcontract agreement.

The Department of Transportation is requesting disclosure of information necessary to accomplish the statutory purpose as outlined under 23CFR part 230 and 41CFR part 60.4 and the Illinois Human Rights Act. Disclosure of this information is REQUIRED. Failure to comply with this special provision may result in the withholding of payments to the contractor, and/or cancellation, termination, or suspension of the contract in whole or part.

Compliance with this Special Provision shall be considered incidental to the cost of the contract and no additional compensation will be allowed for any costs incurred.

This Special Provision must be included in each subcontract agreement.

**TRAFFIC CONTROL PLAN**

*Effective: July 12, 1993*

*Revised: May 12, 1997*

Traffic control shall be in accordance with the applicable sections of the "Standard Specifications for Road and Bridge Construction", the applicable guidelines contained in the "National Manual on Uniform Traffic Control Devices for Streets and Highways", Illinois Supplement to the National Manual of Uniform Traffic Control Devices, these Special Provisions, and any special details and Highway Standards contained herein and in the plans.

Special attention is called to Articles 107.09 and 107.14 of the "Standard Specifications for Road and Bridge Construction and the following Highway Standards relating to traffic control:

701001	701006	701011	701101	701106
701201	701301	701400	701406	701421

In addition, the following Special Provision(s) will also govern traffic control for this project:

Construction and Maintenance Sign Supports  
Reflective Sheeting on Channelizing Devices

Traffic Control and Protection Standard 701201 (Special) – Traffic Control for two lane rural highways shall be provided in accordance with Standard 701201. It is anticipated this setup will be used 33 times. Each setup shall be paid for as 1/33 of the LUMP SUM unit cost. Additional setups that exceed 33 will also be paid for at the 1/33 cost.

Traffic Control and Protection Standard 701400 – Traffic Control for approach to lane closure on Interstate highways shall be provided in accordance with Standard 701400.

Traffic Control and Protection Standard 701406 (Special) – Traffic Control for lane closure on Interstate highways shall be provided in accordance with Standard 701406. It is anticipated this setup will be used 8 times. Each setup shall be paid for as 1/8 of the LUMP SUM unit cost. Additional setups that exceed 8 will also be paid for at the 1/8 cost.

Traffic Control and Protection Standard 701421 (Special) – Traffic Control for lane closure on multilane non-Interstate highways shall be provided in accordance with Standard 701421. It is anticipated this setup will be used 6 times. Each setup shall be paid for as 1/6 of the LUMP SUM unit cost. Additional setups that exceed 6 will also be paid for at the 1/6 cost.

Traffic Control and Protection will be paid for at the contract unit price LUMP SUM for TRAFFIC CONTROL AND PROTECTION STANDARD 701201 (SPECIAL), TRAFFIC CONTROL AND PROTECTION STANDARD 701406 (SPECIAL) and TRAFFIC CONTROL AND PROTECTION STANDARD 701421 (SPECIAL).

**CONSTRUCTION AND MAINTENANCE SIGN SUPPORTS**

*Effective: April 21, 1981*

*Revised: November 1, 2006*

This work shall be done according to Section 1106 of the Standard Specifications and Highway Standard 702001 except as herein modified.

All construction signs mounted on permanent support for use in temporary traffic control having an area of 10 square feet (1 square meter) or more shall be mounted on two 4 in x 4 in (100 mm x 100 mm) or two 4 in x 6 in (100 mm x 150 mm) wood posts.

Type A metal post (two for each sign) conforming to Article 1006.29 of the Standard Specifications may be used in lieu of wood posts. Type A metal posts used for these signs may be unfinished.

This work shall not be paid for separately; but shall be considered included in the cost of the traffic control items in this contract.

## **STATUS OF UTILITIES TO BE ADJUSTED**

### **NO UTILITIES TO BE ADJUSTED**

The above represents the best information of the Department and is only included for the convenience of the bidder. The applicable provisions of Sections 102, 103, and Articles 105.07 and 107.20 of the Standard Specifications for Road and Bridge Construction shall apply.

If any utility adjustment or removal has not been completed when required by the Contractor's operation, the Contractor should notify the Engineer in writing. A request for an extension of time will be considered to the extent the Contractor's operations were affected.

## **TERM OF CONTRACT**

The term of this contract shall start on date of contract execution and end one calendar year later.

## **PROSECUTION OF THE WORK**

The Resident will issue a work order to the Contractor prior to the Contractor proceeding with any work on this contract.

## **CONTROL OF WORK**

The Department may conduct frequent inspections of the respective work order locations to determine if the Contractor is performing repairs promptly and satisfactorily and in the manner specified in the contract. A final inspection will be made by the Department of all work locations and final quantities can be adjusted at that time.

The Department reserves the right to place maximum or minimum limits on the work force and/or equipment utilized by the Contractor to execute a work order.

**COMPLETION DATE**

The Contractor shall schedule his/her operations in order to complete all work orders issued during the Term of Contract, including all clean-up work and open all roadways to traffic on or before one month after the term of the contract expires.

The provisions of Article 108.09 of the Standard Specifications shall apply to both contract completion dates.

**FAILURE TO COMPLETE OR REPAIR – LIQUIDATED DAMAGES**

Time is of the essence in the completion of each work issued by the Department. Failure to make timely repairs will cause public inconvenience, endanger the public safety and subject the Department to public criticism. All repairs shall be completed within the completion time designated for each work order. The Contractor understands and agrees that performance will be expected in varying amounts and at various locations on the roadways designated in the contract in accordance with the work orders issued by the Resident.

Should the Contractor fail to complete the work order within the completion time stipulated, the Contractor shall be liable to the Department for liquidated damages as specified in the following amounts:

<b>WORK ORDER AMOUNT</b>		<b>LIQUIDATED DAMAGES PER DAY</b>
From More Than	To And Including	
\$0	\$500	\$25
\$500	\$1000	\$50
\$1000	And over	\$100

The Department will deduct these liquidated damages from the monies due or to become due to the Contractor from the Department.

All repairs in progress may be halted immediately by the Resident and completion will not be permitted until the Contractor complies with the terms and condition of the contract.

Any repairs completed in disregard of the conditions specified under this contract can result in the total non-payment for the job or in the partial payment of an amount determined by the Resident.

No additional compensation will be given for compliance with the completion date. The cost shall be considered included in the contract.

**TRAFFIC CONTROL AUTHORIZATION REQUEST**

The Contractor will submit a OPER 725 – Traffic Control Authorization Request prior to any work requiring traffic control. The Department will review the request and will either approve or reject the request. If the Department rejects the request, the Contractor will not be allowed to implement the work zone.



Conformance to these traffic control and protecting standards will not be paid for as separate item, but will be considered incidental to the contract.

The Contractor must notify the Project Implementation Engineer at (618) 351-5250 or by fax number (618) 457-8622 of the scheduling of work one workday prior to repair. The jobs should be listed in order of repair. A penalty of the loss of traffic control value for the project will be assessed if work is started prior to notification. If no traffic control is associated with the project, a penalty of \$100 will be assessed for each start of work prior to notification. Verification of telephone contact may be made by facsimile machine to District Headquarters, Bureau of Construction, at Fax Number (618) 457-8622.

Damaged areas to be repaired will be identified in orange fluorescent paint and/or survey ribbon. The work order number should be visible at the repair site.

The traffic control standard recommended is based on the Department's estimate of the nature of work, duration and equipment required to perform the repairs. Any deviation must remain in compliance to the Standard Specifications for Road and Bridge Construction Standard Specifications for Traffic Control Items, and the Manual on Uniform Traffic Control Devices, most recent edition and prior approval by the Department is required.

## **INTERPRETATION OF QUANTITIES AND PAYMENT**

The quantities in the Summary of Quantities are approximate and include items necessary to repair existing damaged guardrail and an estimate of items necessary to repair damage that may occur during the Term of Contract.

The quantities in the Summary of Quantities may be increased, decreased or deleted. Adjustments in contract unit prices will not be made due to an increase, decrease or deletion of items.

Payment for the work under this contract shall be made in accordance with the schedule of prices in the contract and as herein after described. Prices shall include all labor, materials and equipment necessary to complete the work satisfactorily. Before any payment for work is authorized, for a given work order, all repairs must be completed satisfactorily and the guardrail installation must be functional as intended.

The Contractor is hereby informed and shall understand that payment will be made only for actual quantities utilized and accepted as satisfactory.

## **WORK ORDER**

No work, except for priority work, is to be performed by the Contractor without the issuance of a work order authorizing the work. Work orders may be issued for this during the Term of Contract. A work order will show the class of work, date issued to the Contractor, work order number, location, item description, and quantity of removals or repairs to be made. Only the amount of replacement or repairs shown on the work order is to be done by the Contractor. If, at the time repairs are being made, it is found that additional work is needed, prior approval must be obtained from the Resident before work is done. Any additional work done by the Contractor, without prior approval of the Resident, will not be paid. A sample work order is included in the special provisions.

The Contractor shall contact the Resident by telephone no later than 7:00 AM each work day, or at another time specified by the Resident, to coordinate and obtain approval for daily work. The Contractor shall not revise the sequence of daily planned work without the Resident's approval. The Contractor shall contact the Resident (on a Monday through Friday), and at least 24 hours in advance of Saturday, Sunday or holiday work.

The Resident shall issue all work orders except priority work to the Contractor at a location or method as approved by the Resident.

The Contractor shall inspect in detail the site of the work to determine the traffic control and protection requirements before proceeding with the work.

After the work is completed, the Contractor shall initial and record the completion date on the work order, the work order again will be signed and dated by the Resident when the work has been inspected and accepted. The Contractor will be given one copy of the work order for his/her records.

Priority work will be initiated by a verbal order from the Resident. This verbal order will always be confirmed by a written work order.

Regular work will be initiated by a written work order from the Resident.



## Guardrail Repair Work Order

Date: \_\_\_\_\_ Prepared by: \_\_\_\_\_

<input type="checkbox"/> Perry	<input type="checkbox"/> Jefferson	<input type="checkbox"/> Wayne	<input type="checkbox"/> Edwards	<input type="checkbox"/> Walbash
<input type="checkbox"/> Jackson	<input type="checkbox"/> Franklin	<input type="checkbox"/> Hamilton	<input type="checkbox"/> White	<input type="checkbox"/> Williamson
<input type="checkbox"/> Saline	<input type="checkbox"/> Gallatin	<input type="checkbox"/> Union	<input type="checkbox"/> Johnson	<input type="checkbox"/> Pope
<input type="checkbox"/> Hardin	<input type="checkbox"/> Alexander	<input type="checkbox"/> Pulaski	<input type="checkbox"/> Massac	

Marked Route: \_\_\_\_\_ Municipality: \_\_\_\_\_

Location: \_\_\_\_\_

Job Number \_\_\_\_\_

ITEM	UNIT	QUANTITY
F&I GUARD RAIL BLOCKS	EACH	
F&I RAIL ELEMENT PLATES	EACH	
F&I T.B. TERM. T-1 SPECIAL (TAN)	EACH	
F&I T.B. TERM. T-1 SPECIAL (FLRD)	EACH	
F&I RADIUS RAIL ELEMENT PLATES	EACH	
T.B. TERM. T-5 (SPEC)	EACH	
T.B. TERM. T-5A (SPEC)	EACH	
T.B. TERM. T-6 (SPEC)	EACH	
T.B. TERM. T-6A (SPEC)	EACH	
T.B. TERM. T-6B (SPEC)	EACH	
T.B. TERM. T-2 (SPEC)	EACH	
F&S STEEL POSTS	EACH	
IMPACT ATT. (F.R., WIDE), T.L. 3	EACH	
R&R OF EXIST IMPACT ATT.	EACH	
REPAIR T.B. TERM. T-1 SPEC (TAN)	EACH	
REPAIR T.B. TERM. T-1 SPEC (FLRD)	EACH	
REPAIR T.B. TERM. T-2	EACH	
REPAIR T.B. TERM. T-5	EACH	
REPAIR T.B. TERM. T-6	EACH	
HT CBL MEDIAN BARRIER	EACH	
REPAIR T.B. TERM. T-5A	EACH	
REPAIR T.B. TERM. T-6A	EACH	
REPAIR T.B. TERM. T-6B	EACH	
REPAIR T.B. TERM. T-3 (SPEC)	EACH	
SPBGR ATTACH TO STR	FOOT	

**PICTURE**

**TRAFFIC CONTROL**

<input type="checkbox"/> 701006	<input type="checkbox"/> 701101	<input type="checkbox"/> 701201
<input type="checkbox"/> 701406	<input type="checkbox"/> 701701	<input type="checkbox"/> 702001
<input type="checkbox"/> No Work 6-9 AM	<input type="checkbox"/> 701421	
<input type="checkbox"/> No Work 3-6 PM		

Special Instructions: \_\_\_\_\_

Authorization of Work	
Resident	
Date Work Order Issued	Contractor Initials

Inspection and Acceptance of Completed Work	
Inspector Signature	DATE
Date work order inspected and accepted. This is to certify the work order has been completed.	

## **CLASS OF WORK**

### **1. Priority Work**

Priority work is defined as work that is required to correct a condition which is an immediate hazard to the public, or is designated by the Resident to be an immediate hazard of such severity that life and/or property are potentially endangered and first priority corrective action is required.

The location of guardrail and appurtenances to be repaired as priority work shall be determined by the Resident and may be required at any time between the starting date and the completion date.

### **2. Regular Work**

Regular Work is defined as work that involves those situations where the amount or nature of damage does not pose an immediate hazard to the public. Work of this type shall generally be grouped by locations for efficiency of repair.

## **COMPLETION TIME FOR WORK ORDERS**

The Contractor shall schedule his/her operations in order to complete a Priority Work Order within seven (7) calendar days after the date issued.

The Contractor shall schedule his/her operations in order to complete a Regular Work Order within fifteen (15) calendar days after the date issued.

## **CONTRACTOR'S RESPONSIBILITY FOR DAMAGE TO EXISTING STRUCTURES**

Extreme care shall be exercised when driving posts since there are drainage structures, storm sewers, sign foundations, culverts, electrical and surveillance conduit, and other existing objects within the immediate work limits of this project. Operations are to be conducted in a manner, which will minimize damage to the surrounding area.

The Contractor shall be held responsible for any damage to existing structures resulting from his operations. The Contractor shall, at his own expense, restore the damaged structures to a condition equal to that existing before such damaged was done by repairing, rebuilding or replacing it as directed by the Resident. Where, in the opinion of the Resident, the Contractor through his operations has excessively damaged the surrounding area, the Contractor shall restore the surrounding area to a condition meeting the satisfaction of the Resident at his own expense.

No extra compensation will be allowed the Contractor for compliance with this requirement.

## **THE CONTRACTOR'S LIABILITY**

The trees, shrubs and seeded areas on or adjacent to the work should be protected from unnecessary damage by the Contractor's operations in a manner satisfactory to the Resident.

The Contractor shall be responsible for the damage or destruction of property of any character resulting from neglect, misconduct, or omission in the execution or non-execution of the work, or caused by defective work or the use of unsatisfactory materials. Such responsibilities shall not be released until the work has been completed and accepted in accordance with the requirements of these Special Provisions.

The Contractor shall repair damage to any property, public or private, to a condition equivalent to its original condition at no cost to the Department. This work shall be done according to the applicable sections of the Standard Specifications or to the satisfaction of the Resident.

## **PROTECTION FOR DAMAGED LOCATIONS**

The Contractor shall be required to install and maintain barricades with flashing lights at priority locations that have not been repaired within (7) seven calendar days after the date of the issuance of the work order.

The Department will initially have barricades installed at the priority locations and the Contractor will have the option to assume the cost of these rented barricades after the (7) seven days referred to above or have the barricades replaced with others. If the Contractor fails to exercise either of the above options, he shall be liable to the Department in the amount of \$1.00 per barricade per day, not as a penalty but as liquidated damages.

## **REALIGNING POSTS**

At designated locations of steel plate beam guardrail where the existing undamaged posts can be realigned and restored to the proper alignment without removing said posts from the ground, the posts shall be so plumbed and realigned by a method which does not require the pulling of the posts out of the existing post holes. The posts shall be straightened with their front faces on the line shown on the plans, or as ordered by the Resident and with their tops and bolt holes at the correct height so that the rail element plates bolted to them will be parallel to the surface of the shoulder.

The work as described herein shall be included in the contract unit bid price for the pay items involved.

## **REMOVAL OR REPAIR OF GUARDRAIL**

No guardrail shall be removed from State right-of-way under this contract unless each section to be removed is clearly marked for removal. A representative of the Department of Transportation will paint an "X" on each piece of guardrail to be removed. The type and quantity of each piece so marked will be listed on a work order. This work order, when issued to the Contractor by a State Representative, will be authorization for the removal or repair of the guardrail.

Material removed from State right-of-way will be disposed of by the Contractor outside the right-of-way limits at locations provided by him. None of this material shall be reused on this project. The removal, transportation and storage of material removed from the State right-of-way under this contract will not be paid for separately, but the cost thereof shall be included in the contract unit price for replacement items.

New material shall conform to the dimensions and shapes of the material to be replaced except as noted, and shall meet the requirements as specified under each item in these Special Provisions and on the plans. Damaged guardrail that has been removed shall be totally and completely replaced on the same day that it has been removed.

Any ground bituminous material adjacent to a concrete footing, which is removed or disturbed during the removal operations, shall be restored to its original condition and to the satisfaction of the Resident after the work has been completed. This restoration will not be paid for separately but shall be considered incidental to this item of work.

After the work is completed, the Contractor shall mark a rail element plate in the repair area using a paint stick with the work order number and date of repairs.

Immediately after the specified repairs have been made, all nut, bolts, washers, posts, rail elements and any other guardrail components, damaged or undamaged, which are to be scrapped, shall be completely removed from the State right-of-way. Failure to do so will be cause for rejection of work.

The Contractor shall install and maintain a minimum of two Type I or Type II Barricades with flashing warning lights for each direction of traffic per damaged location. Additional barricades will be required for each additional length of 25 feet of damaged guardrail per direction of traffic or as directed by the Resident.

The cost of furnishing, installing, maintaining and removal of the Type I or Type II Barricades will not be paid for separately, but shall be included in the contract unit bid price for the pay items involved.

## **FINAL CLEAN UP**

Final clean up shall conform to the requirements set forth in Article 104.06 of the Standard Specifications.

This will be required at each location where repair has been completed.

This work will not be paid for separately but shall be included in the contract unit bid price for the pay items involved.

## **CONTRACTOR CONTACTS**

The Contractor shall furnish a cellular phone with service meeting the approval of the Resident. At the Contractor's option, the Contractor shall also provide the Resident with either a digital camera or Polaroid camera with film as need by the Engineer. The cost of the above items shall be included in the contract unit bid price for the pay items involved and no additional compensation will be allowed.

## **CLEARING**

The Contractor is hereby informed and shall understand that at some locations of repairs shrubs, brush, weeds, and other vegetation may be encountered that must be removed in order to make the necessary repairs.

The cleaning of shrubs, brush, weeds and other vegetation will not be paid for separately but shall be included in the contract unit bid price for the pay items involved. All work shall be done in a neat and workmanlike manner and to the satisfaction of the Resident.

### **FURNISHING AND INSTALLING GUARDRAIL BLOCKS**

This work consists of removing and replacing existing damaged guardrail block-outs. This work shall be done as directed by the Resident and according to Sections 630 and 632 of the Standard Specifications, the detail in the plans, and this provision.

Replacement block-outs shall conform to the details and standards included in the plans.

Removal, furnishing, and installing of all bolts, nuts, washers and other hardware necessary to complete the work will not be paid for separately, but shall be included in the contract unit bid price for the pay items involved.

This work shall be paid for at the contract unit price per each for FURNISHING AND INSTALLING GUARD RAIL BLOCKS, which price shall include all labor, equipment, and materials.

### **FURNISHING AND INSTALLING RAIL ELEMENT PLATES**

This work consists of removing all sections of damaged rail element plates including all associated hardware, and furnishing and installing new guardrail elements including all necessary hardware at locations as directed by the Resident. This work shall be done as directed by the Resident and according to applicable sections of the Standard Specifications, the plans, and this provision.

Plates, nuts, bolts, washers and other hardware shall be galvanized and shall match the original and adjacent installation as to type and design.

The Contractor shall adjust and realign existing rail element plates adjacent to rail elements removed and replaced as directed by the Resident. Unbolting, bolting, adjusting, realigning or any other work necessary to accomplish the desired realignment shall be included in the contract unit bid price for the pay items involved.

The furnishing and installing of all bolts, nuts, washers and other hardware necessary to comply with the above mentioned Special Provision will not be paid for separately, but shall be included in the contract unit bid price for the pay items involved.

In order to clarify measurement and payment for work, the standard length of rail element plate shall be considered to be 12'-6". In the event existing damaged rail element plates to be removed and replaced measures 25 feet in length, they shall be considered as two (2) rail element plates of standard 12'-6" length.

This work shall be paid for at the contract unit price each for FURNISHING AND INSTALLING RAIL ELEMENT PLATES, which price shall include realigning adjacent rail element plates and/or posts as specified by the Resident.

### **TRAFFIC BARRIER TERMINAL, TYPE 1, SPECIAL AND TYPE 1 SPECIAL (FLARED)**

This work shall consist of furnishing and installing a Traffic Barrier Terminal Type 1, Special and Type 1 Special (Flared) of the type specified by the Resident according to Section 631 of the Standard Specifications, the details in the plans, and this provision.

Delete all references to Type 1 terminal in Section 631 in the Standard Specifications.

All Terminals shall meet the testing criteria contained in the National Cooperative Highway Research Program (NCHRP) Report 350 and be approved by the Department.

The terminal shall be installed according to the manufacturer's specifications and shall include all necessary transitions between the terminal and the item to which it is attached.

The terminals shall follow the manufacturer's specifications for installation as to type and number of posts, foundation tubes, and soil plates.

The terminal section shall provide a minimum length of need of 11.4m (37.5 ft.).

Included in this item is the complete removal of an existing damaged or undamaged terminal section having a length of approximately fifty (50) feet, where the rail element is twisted 90 degrees, terminating at an end post flush with the ground. All posts, rail element plates and related components of the existing terminal section, including the steel end post, shall be removed. The existing steel end post encountered may be set in a concrete anchor or may have been driven in accord with the alternate requirements permissible at the time of the guardrail installation. In the event a concrete anchor is encountered, said concrete anchor shall be completely removed. After the concrete anchor is removed, the remaining hole shall be filled with sand or other suitable material approved by the Resident.

Also included in this item is the complete removal of an existing damaged or undamaged Traffic Barrier Terminal Type 1, Traffic Barrier Type 1A, Traffic Barrier Terminal Type 1, Special and any guardrail necessary to accommodate the new Traffic Barrier Terminal Type 1, Special. The Resident will make this determination and inform the Contractor prior to commencing repairs. All old posts shall be removed and the remaining holes shall be filled with sand or other suitable material approved by the Resident.

The Contractor shall adjust and realign existing rail element plates and posts adjacent to the new traffic barrier terminal, as directed by the Resident. Unbolting, bolting, adjusting, realigning, guardrail removal, or any other work necessary to accomplish the desired realignment shall be included in the contract unit bid price for the pay items involved.

This item shall also include the furnishing and installing of a Terminal Marker - Direct Applied which shall comply with the applicable portions of the Recurring Special Provision for GUARDRAIL AND BARRIER WALL DELINEATION. This work shall be included in the contract unit bid price for the pay items involved.

This work shall be paid for at the contract unit price each for TRAFFIC BARRIER TERMINAL TYPE 1, SPECIAL (TANGENT) and for TRAFFIC BARRIER TERMINAL TYPE 1, SPECIAL (FLARED), which price shall include all labor, equipment and material to satisfactorily complete the work as described herein.



## **FURNISHING AND INSTALLING RADIUS RAIL ELEMENT PLATES**

This work consists of removing all sections of damaged rail element plates including all associated hardware, and furnishing and installing new guardrail curved elements including all necessary hardware at locations as directed by the Resident. This work shall be done as directed by the Resident and according to applicable sections of the Standard Specifications, the plans, and this provision.

Plates, nuts, bolts, washers and other hardware shall be galvanized and shall match the original and adjacent installation as to type and design.

The Contractor shall adjust and realign existing rail element plates adjacent to rail elements removed and replaced as directed by the Resident. Unbolting, bolting, adjusting, realigning or any other work necessary to accomplish the desired realignment shall be included in the contract unit bid price for the pay items involved.

The furnishing and installing of all bolts, nuts, washers and other hardware necessary to comply with the above mentioned Special Provision will not be paid for separately, but shall be considered included in the contract unit bid price for the pay items involved.

The guardrail element plates will be factory fabricated to the radius of curvature necessary to match the existing guardrail configuration or as specified by the Resident.

In order to clarify measurement and payment for work, the standard length of radial rail element plate shall be considered to be 12'-6". In the event existing damaged rail element plates to be removed and replaced measures 25 feet in length, they shall be considered as two (2) rail element plates of standard 12'-6".

If any portion of a standard 12'-6" rail element plate is factory fabricated to a radial shape the rail element plate shall be paid as one Radius Element Plate each.

This work shall be paid for at the contract unit price per each for FURNISHING AND INSTALLING RADIUS RAIL ELEMENT PLATES, which price shall include realigning adjacent rail element plates and/or posts as specified by the Resident inclusive the element.

## **TRAFFIC BARRIER TERMINAL, TYPE 5, 5A, 6, 6A & 6B (SPECIAL)**

This work consists of furnishing and installing a Traffic Barrier Terminal Type 5, 5A, 6, 6A and 6B at the locations as specified by the Resident in accordance with Section 631 of the Standard Specifications, the details in the plans, and this provision.

Also included in this item is the complete removal of an existing damaged or undamaged sub standard, Traffic Barrier Terminal Type 5, 5A, 6, 6A and 6B. The Resident will make this determination and inform the Contractor prior to commencing repairs. All posts, rail element plates and related components of the existing terminal section, as well as any length of the guardrail types needed to accommodate the new Traffic Barrier Type 5, 5A, 6, 6A and 6B shall be removed. Included in this item are all shims and blocks required by the Resident to facilitate proper attachment to structure walls.

The Contractor shall adjust and realign existing rail element plates and posts adjacent to the new traffic barrier terminal, as directed by the Resident. Unbolting, bolting, adjusting, realigning, guardrail removal, or any other work necessary to accomplish the desired realignment shall be included in the contract unit bid price for the pay items involved.

This work will be paid for at the contract unit price each for TRAFFIC BARRIER TERMINAL, TYPE 5 (SPECIAL), TRAFFIC BARRIER TERMINAL, TYPE 5A (SPECIAL), TRAFFIC BARRIER TERMINAL, TYPE 6 (SPECIAL), TRAFFIC BARRIER TERMINAL, TYPE 6A (SPECIAL) and TRAFFIC BARRIER TERMINAL, TYPE 6B (SPECIAL) which price shall include all labor, equipment and material necessary to satisfactorily complete the work as described herein.

### **TRAFFIC BARRIER TERMINAL, TYPE 2 (SPECIAL)**

This work consists of furnishing and installing a Traffic Barrier Terminal Type 2 at the locations as specified by the Resident in accordance with Section 631 of the Standard Specifications, the details in the plans, and this provision.

All posts, rail element plates and related components of the existing terminal section, including the steel end post, shall be removed. The existing steel end post encountered may be set in a concrete anchor or may have been driven in accord with the alternate requirements permissible at the time of the guardrail installation. In the event a concrete anchor is encountered, said concrete anchor shall be completely removed. After the concrete anchor is removed, the remaining hole shall be filled with sand or other suitable material approved by the Resident.

Also included in this item is the complete removal of an existing damaged Traffic Barrier Terminal Type 2. The Resident will make this determination and inform the Contractor prior to commencing repairs.

The Contractor shall adjust and realign existing rail element plates and posts adjacent to the new traffic barrier terminal, as directed by the Resident. Unbolting, bolting, adjusting, realigning, or any other work necessary to accomplish the desired realignment shall be included in the contract unit bid price for the pay items involved.

This work shall be paid for at the contract unit price each for TRAFFIC BARRIER TERMINAL, TYPE 2, (SPECIAL) which price shall include all labor, equipment and material necessary to satisfactorily complete the work as described herein.

### **HIGH TENSION CABLE MEDIAN BARRIER TERMINAL**

This work consists of furnishing and installing a High Tension Cable Median Barrier Terminal at the locations as specified by the Resident.

Also included in this item is the complete removal of an existing damaged or undamaged sub standard, High Tension Cable Median Barrier Terminal. The Resident will make this determination and inform the Contractor prior to commencing repairs. All related components of the existing terminal section shall be removed.

The Contractor shall adjust and realign existing posts adjacent to the new traffic barrier terminal, as directed by the Resident. Any other work necessary to accomplish the desired realignment shall be included in the contract unit bid price for the pay items involved.

This work will be paid for at the contract unit price each for HIGH TENSION CABLE MEDIAN BARRIER TERMINAL which price shall include all labor, equipment and material necessary to satisfactorily complete the work as described herein.

### **FURNISHING AND SETTING STEEL POSTS**

Refer to Standard 630001. This work consists of removing a damaged guardrail post and erecting a new guardrail post at the same location. This work shall be done as directed by the Resident and according to Sections 630 and 632 of the Standard Specifications, the plans, and this provision.

The proposed guardrail post will match the existing and adjacent guardrail posts as to type, length, and design.

The replacement guardrail post shall conform to the length, size and type of the original installation of the steel plate beam guardrail.

Removal, furnishing, and installing of all bolts, nuts, washers and other hardware necessary to complete the work will not be paid for separately, but shall be included in the contract unit bid price for the pay items involved.

This work shall be paid for at the contract unit price each for FURNISHING AND SETTING STEEL POSTS which price shall include all labor, equipment, and material necessary to satisfactorily complete the work as described herein.

### **REMOVAL AND REINSTALLATION OF EXISTING IMPACT ATTENUATORS**

This work includes replacing sand module impact attenuators damaged by traffic at various locations. Impact attenuators shall be in accordance with the attached special provision for Impact Attenuators (BDE), Effective November 1, 2003. Impact attenuators shall meet the testing criteria contained in National Cooperative Highway Research Program \*NCHRP) Report 350 for Test Level 3 and shall be on the Department's approval list. The attenuators are installed on existing base pads located on various multi-lane highways throughout the district and region.

Work shall include removing and disposing of each damaged sand module impact attenuator and its contents off the right-of-way, cleaning up any remaining debris from the damaged attenuator, and replacing the damaged attenuator with one matching the kind/type of the remaining attenuators. Mixing sand module impact attenuators of different manufacturers at any one location shall not be permitted. The replacement modules(s) shall be filled with the designated weight of sand matching the number painted on the base pad or the weight shown in the plan detail.

Adjacent sand module impact attenuators that are not damaged, but have been shifted laterally from their original position shall be realigned or moved back to their original position, as directed by the Engineer.

This work shall be paid for at the contract unit price EACH for REMOVAL AND REINSTALLATION OF EXISTING IMPACT ATTENUATORS. Each individual replacement module, complete with the required hardware, filled with sand and properly installed, shall constitute one each. Realignment or moving adjacent undamaged modules back to their original positions shall not be paid for separately, but shall be considered included in the cost of replacement.

### **REPAIR TRAFFIC BARRIER TERMINAL TYPE 1 SPECIAL (TANGENT)**

This work consists of removing and replacing all damaged components from the extruder head to 25' from the end of the extruder head at the locations as specified by the Resident in accordance with the Standard Specifications, the plans, and this provision.

The Contractor shall adjust and realign existing rail element plates and posts adjacent to or within the traffic barrier terminal repaired, as directed by the Resident. Unbolting, bolting, adjusting, realigning, excavating, filling post holes or any other work necessary to accomplish the desired realignment shall be included in the contract unit bid price for the pay items involved.

This item shall also include the furnishing and installing of a Terminal Marker – Direct Applied, if needed, which shall comply with the applicable portions of the Recurring Special Provision for GUARDRAIL AND BARRIER WALL DELINEATION. This work shall be included in the contract unit bid price for the pay items involved.

The entire 25 feet of guardrail shall be replaced when the existing guardrail is damaged. Replacement of the 25 feet of steel plate beam guardrail shall not be included in the measurement for payment but shall be considered included in the cost of the item. Also included in the cost of this item are cable assemblies, strut, soil tubes, and all other hardware, excluding the extruder head.

The existing extruder head will be reused and reattached to the Traffic Barrier Terminal if undamaged. This work is considered included in the cost of this pay item.

This work will be paid for at the contract unit price per each for REPAIR TRAFFIC BARRIER TERMINAL TYPE 1 SPECIAL (TANGENT), which price shall include all labor, equipment and material necessary to satisfactorily complete the work as described herein.

When the extruder head is damaged, a new extruder head will be paid for separately as FURNISHING AND INSTALLING EXTRUDER HEAD. If more than 25' of the terminal is damaged the entire terminal should be replaced and paid for as a complete new installation. The R.E. will determine whether the unit is to be repaired or replaced.

### **FURNISHING AND INSTALLING EXTRUDER HEAD**

This work consists of removal and replacement of a Traffic Barrier Terminal Type 1 Extruder Head as specified by the Resident in accordance with the Standard Specifications, the plans, and this provision.

This work will be used in conjunction with the pay item REPAIR TRAFFIC BARRIER TERMINAL TYPE 1 SPECIAL.

This item shall also include the furnishing and installing of a Terminal Marker – Direct Applied, if needed, which shall comply with the applicable portions of the Recurring Special Provision for GUARDRAIL AND BARRIER WALL DELINEATION. This work shall be included in the contract unit bid price for the pay items involved.

This work will be paid for at the contract unit price per each for FURNISHING AND INSTALLING EXTRUDER HEAD, which price shall include all labor, equipment and material necessary to satisfactorily complete the work as described herein.

### **REPAIR TRAFFIC BARRIER TERMINAL TYPE 1 SPECIAL (FLARED) AND TYPE 3 (SPECIAL)**

This work consists of removing and replacing all damaged components from the extruder head of the terminal to 25' from the extruder head, up to and including the second post and the first 25 feet of rail element plate at the locations as specified by the Resident in accordance with the Standard Specifications, the plans, and this provision.

The Contractor shall adjust and realign existing rail element plates and posts adjacent to or within the traffic barrier terminal repaired, as directed by the Resident. Unbolting, bolting, adjusting, realigning, excavating, filling post holes or any other work necessary to accomplish the desired realignment shall be included in the contract unit bid price for the pay items involved.

This item shall also include the furnishing and installing of a Terminal Marker - Direct Applied, if needed, which shall comply with the applicable portions of the Recurring Special Provision for GUARDRAIL AND BARRIER WALL DELINEATION. This work shall be included in the contract unit bid price for the pay items involved.

The entire 25 feet of guardrail shall be replaced when the existing guardrail is damaged. Replacement of the 25 feet of steel plate beam guardrail shall not be included in the measurement for payment but shall be considered included in the cost of this item. Also included in the cost of this item are cable assemblies, noses, strut, and all other hardware.

The repair of type 3 special shall include repairing an existing C.A.T. system only.

This work will be paid for at the contract unit price per each for REPAIR TRAFFIC BARRIER TERMINAL TYPE 1 SPECIAL (FLARED) and REPAIR TRAFFIC BARRIER TERMINAL TYPE 3 SPECIAL, which price shall include all labor, equipment and material necessary to satisfactorily complete the work as described herein.

When the extruder head is damaged, a new extruder head will be paid for separately as FURNISHING AND INSTALLING EXTRUDER HEAD. If more than 25' of the terminal is damaged the entire terminal should be replaced and paid for as a complete new installation. The R.E. will determine whether the unit is to be repaired or replaced.

### **REPAIR TRAFFIC BARRIER TERMINAL TYPE 2, 5, 5A, 6, 6A & 6B**

This work consists of removing and replacing damaged components of existing Traffic Barrier Terminals Type 2, 5A, 6, 6A and 6B at the locations as specified by the Resident in accordance with the applicable portions of the Standard Specifications, Standards 631011, 631026, 631031, the plans, and this provision.

The Contractor shall adjust and realign existing rail element plates and posts adjacent to the traffic barrier terminal repaired, as directed by the Resident. Unbolting, bolting, adjusting, realigning, excavating or any other work necessary to accomplish the desired realignment shall be included in the contract unit bid price for the pay items involved.

This work will be paid for at the contract unit price each for REPAIR TRAFFIC BARRIER TERMINAL, of the type specified, which price shall include all labor, equipment, and material necessary to satisfactorily complete the work as described herein.

### **REPAIR HIGH TENSION CABLE MEDIAN BARRIER TERMINAL**

This work consists of removing and replacing damaged components of existing High Tension Cable Median Barrier Terminals at the locations as specified by the Resident in accordance with the applicable portions of the Standard Specifications, Standards 631011, 631026, 631031, the plans, and this provision.

The Contractor shall adjust and realign existing rail element plates and posts adjacent to the traffic barrier terminal repaired, as directed by the Resident. Unbolting, bolting, adjusting, realigning, excavating or any other work necessary to accomplish the desired realignment shall be included in the contract unit bid price for the pay items involved.

This work will be paid for at the contract unit price each for REPAIR TRAFFIC BARRIER TERMINAL, of the type specified, which price shall include all labor, equipment, and material necessary to satisfactorily complete the work as described herein.

### **FURNISHING AND SETTING CABLE ROAD GUARDPOSTS (HIGH TENSION)**

This work consists of removing a damaged cable road guardpost and erecting a new cable road guardpost at the same location. This work shall be done as directed by the Resident and according to the manufacturer's specifications, the plans, and the special provisions.

The proposed cable road guardpost will match the existing and adjacent cable road guardpost as to type, length, and design.

The replacement cable road guardpost shall conform to the length, size and type of the original installation of the cable road guardpost.

If required, reflectors, meeting the manufacturer's specifications for the type of guardpost being replaced, or as approved by the Engineer, shall also be included with the replaced guardpost, at a spacing determined by the Engineer.

Reinstalling and retensioning of the cable and all hardware necessary to complete the work including cable splices and turn buckles will not be paid for separately, but shall be included in the contract unit bid price for FURNISHING AND SETTING CABLE ROAD GUARDPOSTS (HIGH TENSION).

This work shall be paid for at the contract unit price each for FURNISHING AND SETTING CABLE ROAD GUARDPOSTS (HIGH TENSION) which price shall include all labor, equipment, and material necessary to satisfactorily complete the work as described herein.

### **FURNISHING AND SETTING STEEL POSTS (MODIFIED)**

Refer to Standard 630101. This work consists of removing a damaged guardrail post attached to a structure and erecting a new guardrail post attached to a structure at the same location. This work shall be done as directed by the Resident and according to Sections 630 and 632 of the Standard Specifications, the detail in the plans, and this provision.

The proposed and replacement guardrail post is to match the existing and adjacent guardrail posts as to type, length and design.

Removal, furnishing and installing of all bolts, nuts, washers and other hardware necessary to complete the work will not be paid for separately, but shall be included in the contract unit bid price for the pay items involved.

This work shall be paid for at the contract unit price each for FURNISHING AND SETTING STEEL POSTS (MODIFIED).

### **FURNISHING AND SETTING STEEL POSTS (SPECIAL)**

Refer to Standard 630001. This work consists of unbolting the rail elements, removing a guardrail post that could be set in concrete, and furnishing and setting a new guardrail post set in portland cement concrete. This work shall be done as directed by the Resident and according to Sections 630 and 632 of the Standard Specifications, the detail in the plans, and this provision.

Where existing damaged posts are set in concrete, the Contractor shall remove the damaged guardrail post and concrete. The Contractor shall set a new guardrail post of the same length as that removed in concrete on the same alignment and at the proper height to coincide with the adjacent and adjoining guardrail. New guardrail posts shall match the existing installation.

Where existing damaged posts are not set in concrete and are shorter than the length specified in the appropriate standard due to impervious material or underground utilities encountered, the new guardrail posts shall be set in concrete in accordance with the details as shown in Standard 630001 and at the proper height to coincide with the adjacent guardrail. New guardrail posts shall match the existing installation.

This work shall be paid for at the contract unit price each for FURNISHING AND SETTING STEEL POSTS (SPECIAL), which price shall include all labor, material and equipment to complete the work as specified.

### **REALIGNING POSTS**

At the designated locations of steel plate beam guardrail repairs where the existing undamaged posts can be realigned and restored to the proper alignment without removing said posts from the ground, the posts shall be plumbed and realigned by a method which does not require the pulling of the posts out of the existing post holes.

The posts shall be straightened with their front faces on the line shown on the plans, or as ordered by the Engineer and with their top and bolt holes at the correct height so that the rail element plates bolted to them will be parallel to the surface of the shoulder.

The Contractor is hereby informed and shall understand that the work, as described under this special provision entitled "Realigning Posts" shall be included in adjacent work being performed with no additional compensation provided.

### **LOCATING UNDERGROUND CABLE, SPECIAL**

This work shall consist of locating and marking all state owned buried cable.

The Contractor shall take whatever precautions to protect the underground cable from damage during location and construction operations. In the event that the cable is damaged, the Contractor shall replace the cable in a manner satisfactory to the Resident, at his/her own expense.

This work will be paid for at the contract unit price each for LOCATING UNDERGROUND CABLE, SPECIAL, which price shall include locating and marking the underground cable and protecting it from damage during location and construction operations.

### **CHAIN LINK FENCE (SPECIAL)**

This work consists of furnishing and installing Chain Link Fence at the locations as specified by the Resident in accordance with Section 664 of the Standard Specifications, the details in the plans, and this provision.

Also included in this item is the complete removal of existing damaged Chain Link Fence, limits to be specified by the Resident.

This work will be paid for at the contract unit price per foot for CHAIN LINK FENCE (SPECIAL) which price shall include all labor, equipment and material necessary to satisfactorily complete the work as described herein.

### **GRADING**

Miscellaneous grading in medians or on sideslopes required to fill any ruts and smooth the earth slopes disturbed by errant vehicles or vehicle recovery operations shall be paid for according to section 109.04 of the standard specifications. Any ruts or damage to the earth slopes caused by the contractor's operations shall be repaired at the contractor's expense.

### **STRUCTURAL REPAIR OF CONCRETE**

Effective: March 15, 2006

Revised: January 22, 2010

Description. This work shall consist of structurally repairing concrete.

Materials. Materials shall be according to the following.



Item	Article/Section
(a) Portland Cement Concrete (Note 1) .....	1020
(b) R1 or R2 Mortar (Note2)	
(c) Normal Weight Concrete (Note 3)	
(d) Shotcrete (High Performance) (Note 4)	
(e) Reinforcement Bars .....	1006.10
(f) Anchor Bolts .....	1006.09
(g) Water .....	1002
(h) Curing Compound (Type I) .....	1022
(i) Cotton Mats .....	1022.02
(j) Protective Coat .....	1023.01
(k) Epoxy (Note 5) .....	1025
(l) Mechanical Bar Splicers (Note 6)	

Note 1. The concrete shall be Class SI, except the cement factor shall be a minimum 6.65 cwt/cu. yd. (395 kg/cu. m), the coarse aggregate shall be a CA 16, and the strength shall be a minimum 4000 psi (27,500 kPa) compressive or 675 psi (4650 kPa) flexural at 14 days. A high range water-reducing admixture shall be used to obtain a 5-7 in. (125-175 mm) slump, but the cement factor shall not be reduced. This cement factor restriction shall also apply if a water-reducing admixture is used.

Note 2. The R1 or R2 mortar shall be from the Department's approved list of Packaged, Dry, Rapid Hardening, Cementitious Materials for Concrete Repairs with coarse aggregate added. The amount of coarse aggregate added to the R1 or R2 Mortar shall be per the manufacturer's recommendations. The coarse aggregate gradation shall be CA 16 from an Aggregate Gradation Control System source or a packaged aggregate meeting Article 1004.02 with a maximum size of 1/2 in. (12.5 mm). The R1 or R2 Mortar and coarse aggregate mixture shall comply with the air content and strength requirements for Class SI concrete as indicated in Note 1. Mixing shall be per the manufacturer's recommendations, except the water/cement ratio shall not exceed the value specified for Class SI concrete as indicated in Note 1. A high range water-reducing admixture shall be used to obtain a 5-7 in. (125-175 mm) slump.

Note 3. The packaged concrete mixture shall be from the Department's approved list of Packaged, Dry, Formed, Concrete Repair Mixtures. The materials and preparation of aggregate shall be according to ASTM C 387. Proportioning shall be according to ASTM C 387, except the minimum cement factor shall be 6.65 cwt/cu. yd. (395 kg/cu. m). Cement replacement with fly ash or ground granulated blast-furnace slag shall be according to Section 1020. The coarse aggregate shall be a maximum size of 1/2 in. (12.5 mm). The packaged concrete mixture shall comply with the air content and strength requirements for Class SI concrete as indicated in Note 1. Mixing shall be per the manufacturer's recommendations, except the water/cement ratio shall not exceed the value specified for Class SI concrete as indicated in Note 1. A high range water-reducing admixture shall be used to obtain a 5-7 in. (125-175 mm) slump.

Note 4. A packaged, pre-blended, and dry combination of materials, for the wet-mix shotcrete method shall be provided according to ASTM C 1480. An accelerator is prohibited, except the shotcrete may be modified at the nozzle with a non-chloride accelerator for overhead applications. The shotcrete shall be Type FA or CA, Grade FR, and Class I.

The fibers shall be Type III synthetic according to ASTM C 1116.

The packaged shotcrete shall have a maximum water soluble chloride ion content of 0.06 % by weight (mass) of cement. The test shall be performed according to ASTM C 1218, and the hardened shotcrete shall have an age of 28 to 42 days at the time of test. The test shall be performed a minimum of once every two years.

Each individual aggregate used in the packaged shotcrete shall have either a maximum ASTM C 1260 expansion of 0.16 percent or a maximum ASTM C 1293 expansion of 0.040 percent. However, the ASTM C 1260 value may be increased to 0.27 percent for each individual aggregate if the cement total equivalent alkali content ( $\text{Na}_2\text{O} + 0.658\text{K}_2\text{O}$ ) does not exceed 0.60 percent. As an alternative to these requirements, ASTM C 1567 testing which shows the packaged shotcrete has a maximum expansion of 0.16 percent may be submitted. The ASTM C 1260, C 1293, or C 1567 test shall be performed a minimum of once every two years.

The 7 and 28 day compressive strength requirements in ASTM C 1480 shall not apply. Instead the shotcrete shall obtain a minimum compressive strength of 4000 psi (27,500 kPa) at 14 days.

The packaged shotcrete shall be limited to the following proportions:

The portland cement and finely divided minerals shall be 6.05 cwt/cu. yd. (360 kg/cu. m) to 8.50 cwt/cu. yd. (505 kg/cu. m) for Type FA and 6.05 cwt/cu. yd. (360 kg/cu. m) to 7.50 cwt/cu. yd. (445 kg/cu. m) for Type CA. The portland cement shall not be below 4.70 cwt/cu. yd. (279 kg/cu. m) for Type FA or CA.

The finely divided mineral(s) shall constitute a maximum of 35 percent of the total cement plus finely divided mineral(s).

Class F fly ash is optional and the maximum shall be 20 percent by weight (mass) of cement.

Class C fly ash is optional and the maximum shall be 25 percent by weight (mass) of cement.

Ground granulated blast-furnace slag is optional and the maximum shall be 30 percent by weight (mass) of cement.

Microsilica is required and shall be a minimum of 5 percent by weight (mass) of cement, and a maximum of 10 percent. As an alternative to microsilica, high-reactivity metakaolin may be used at a minimum of 5 percent by weight (mass) of cement, and a maximum of 10 percent.

Fly ash shall not be used in combination with ground granulated blast-furnace slag. Class F fly ash shall not be used in combination with Class C fly ash. Microsilica shall not be used in combination with high-reactivity metakaolin. A finely divided mineral shall not be used in combination with a blended hydraulic cement, except for microsilica or high-reactivity metakaolin.

The water/cement ratio as defined in Article 1020.06 shall be a maximum of 0.42.

The air content as shot shall be 4.0 – 8.0 percent.

Note 5. In addition ASTM C 881, Type IV, Grade 2 or 3, Class A, B, or C may be used.

Note 6. Mechanical bar splicers shall be from the approved list of Mechanical Reinforcing Bar Splicers / Coupler Systems, and shall be capable of developing in tension at least 125 percent of the yield strength of the existing reinforcement bar.

Equipment. Equipment shall be according to Article 503.03 and the following.

Chipping Hammer – The chipping hammer for removing concrete shall be a light-duty pneumatic or electric tool with a 15 lb. (7 kg) maximum class or less.

Blast Cleaning Equipment – Blast cleaning equipment for concrete surface preparation shall be the abrasive type, and the equipment shall have oil traps.

Hydrodemolition Equipment – Hydrodemolition equipment for removing concrete shall be calibrated, and shall use water according to Section 1002.

High Performance Shotcrete Equipment – The batching, mixing, pumping, hose, nozzle, and auxiliary equipment shall be for the wet-mix shotcrete method, and shall meet the requirements of ACI 506R.

### Construction Requirements

General. The repair methods shall be either formed concrete repair or shotcrete. The repair method shall be selected by the Contractor with the following rules.

- (a) Rule 1. For formed concrete repair, a subsequent patch to repair the placement point after initial concrete placement will not be allowed. As an example, this may occur in a vertical location located at the top of the repair.
- (b) Rule 2. Formed concrete repair shall not be used for overhead applications.
- (c) Rule 3. Shotcrete shall not be used for column repairs greater than 4 in. (100 mm) in depth, or any repair location greater than 8 in. (205 mm) in depth. The only exception to this rule would be for a horizontal application, where the shotcrete may be placed from above in one lift.
- (d) Rule 4. If formed concrete repair is used for locations that have reinforcement with less than 0.75 in. (19 mm) of concrete cover, the concrete mixture shall contain fly ash or ground granulated blast-furnace slag at the maximum cement replacement allowed.

Temporary Shoring or Cribbing. When a temporary shoring or cribbing support system is required, the Contractor shall provide details and computations, prepared and sealed by an Illinois licensed Structural Engineer, to the Department for review and approval. When ever possible the support system shall be installed prior to starting the associated concrete removal. If no system is specified, but during the course of removal the need for temporary shoring or cribbing becomes apparent or is directed by the Engineer due to a structural concern, the Contractor shall not proceed with any further removal work until an appropriate and approved support system is installed.

Concrete Removal. The Contractor shall provide ladders or other appropriate equipment for the Engineer to mark the removal areas. Repair configurations will be kept simple, and squared corners will be preferred.

The repair perimeter shall be sawed a depth of 1/2 in. (13 mm) or less, as required to avoid cutting the reinforcement. Any cut reinforcement shall be repaired or replaced at the expense of the Contractor. If the concrete is broken or removed beyond the limits of the initial saw cut, the new repair perimeter shall be recut. The areas to be repaired shall have all loose, unsound concrete removed completely by the use of chipping hammers, hydrodemolition equipment, or other methods approved by the Engineer. The concrete removal shall extend along the reinforcement bar until the reinforcement is free of bond inhibiting corrosion. The outermost layer of reinforcement bar within the repair area shall be undercut to a depth of 3/4 in. (19 mm) or the diameter of the reinforcement bar, whichever value is larger. The underlying transverse reinforcement bar shall also be undercut as previously described, unless the reinforcement is not corroded, and the reinforcement bar is encased and well bonded to the surrounding concrete.

If sound concrete is encountered before existing reinforcement bars are exposed, further removal of concrete shall not be performed unless the minimum repair depth is not met.

The repair depth shall be a minimum of 1 in. (25 mm). The substrate profile shall be  $\pm 1/16$  in. ( $\pm 1.5$  mm). The perimeter of the repair area shall have a vertical face.

If a repair is located at the ground line, any excavation required below the ground line to complete the repair shall be included in this work.

The Contractor shall have a maximum of 14 calendar days to complete each repair location with concrete or shotcrete, once concrete removal has started for the repair.

The Engineer shall be notified of concrete removal that exceeds 6 in. (150 mm) in depth, one fourth the cross section of a structural member, more than half the vertical column reinforcement is exposed in a cross section, more than 6 consecutive reinforcement bars are exposed in any direction, within 1.5 in. (38 mm) of a bearing area, or other structural concern. Excessive deterioration or removal may require further evaluation of the structure or installation of temporary shoring and cribbing support system.

Surface Preparation. Prior to placing the concrete or shotcrete, the Contractor shall prepare the repair area and exposed reinforcement by blast cleaning. The blast cleaning shall provide a surface that is free of oil, dirt, and loose material.

If a succeeding layer of shotcrete is to be applied, the initial shotcrete surface and remaining exposed reinforcement shall be free of curing compound, oil, dirt, loose material, rebound (i.e. shotcrete material leaner than the original mixture which ricochets off the receiving surface), and overspray. Preparation may be by lightly brushing or blast cleaning if the previous shotcrete surface is less than 36 hours old. If more than 36 hours old, the surface shall be prepared by blast cleaning.

The repair area and perimeter vertical face shall have a rough surface. Care shall be taken to ensure the perimeter sawcut is roughened. Just prior to concrete or shotcrete placement, saturate the repair area with water to a saturated surface-dry condition. Any standing water shall be removed.

Concrete or shotcrete placement shall be done within 3 calendar days of the surface preparation or the repair area shall be prepared again.

Reinforcement. Exposed reinforcement bars shall be cleaned of concrete and corrosion by blast cleaning. After cleaning, all exposed reinforcement shall be carefully evaluated to determine if replacement or additional reinforcement bars are required.

Reinforcing bars that have been cut or have lost 25 percent or more of their original cross sectional area shall be supplemented by new in kind reinforcement bars. New bars shall be lapped a minimum of 32 bar diameters to existing bars. A mechanical bar splicer shall be used when it is not feasible to provide the minimum bar lap. No welding of bars shall be performed.

Intersecting reinforcement bars shall be tightly secured to each other using 0.006 in. (1.6 mm) or heavier gauge tie wire, and shall be adequately supported to minimize movement during concrete placement or application of shotcrete.

For reinforcement bar locations with less than 0.75 in. (19 mm) of cover, protective coat shall be applied to the completed repair. The application of the protective coat shall be according to Article 503.19, 2nd paragraph, except blast cleaning shall be performed to remove curing compound.

The Contractor shall anchor the new concrete to the existing concrete with 3/4 in. (19 mm) diameter hook bolts for all repair areas where the depth of concrete removal is greater than 8 in. (205 mm) and there is no existing reinforcement extending into the repair area. The hook bolts shall be spaced at 15 in. (380 mm) maximum centers both vertically and horizontally, and shall be a minimum of 12 in. (305 mm) away from the perimeter of the repair. The hook bolts shall be installed according to Section 584.

Repair Methods. All repair areas shall be inspected and approved by the Engineer prior to placement of the concrete or application of the shotcrete.

- (a) Formed Concrete Repair. Falsework shall be according to Article 503.05. Forms shall be according to Article 503.06. Formwork shall provide a smooth and uniform concrete finish, and shall approximately match the existing concrete structure. Formwork shall be mortar tight and closely fitted where they adjoin the existing concrete surface to prevent leakage. Air vents may be provided to reduce voids and improve surface appearance. The Contractor may use exterior mechanical vibration, as approved by the Engineer, to release air pockets that may be entrapped.

The concrete for formed concrete repair shall be a Class SI Concrete, or a packaged R1 or R2 Mortar with coarse aggregate added, or a packaged Normal Weight Concrete at the Contractor's option. The concrete shall be placed and consolidated according to Article 503.07. The concrete shall not be placed when frost is present on the surface of the repair area, or the surface temperature of the repair area is less than 40 °F (4 °C). All repaired members shall be restored as close as practicable to their original dimensions.

Curing shall be done according to Article 1020.13.

If temperatures below 45°F (7°C) are forecast during the curing period, protection methods shall be used. Protection Method I according to Article 1020.13(d)(1), or Protection Method II according to Article 1020.13(d)(2) shall be used during the curing period.

The surfaces of the completed repair shall be finished according to Article 503.15.

- (b) Shotcrete. Shotcrete shall be tested by the Engineer for air content according to Illinois Modified AASHTO T 152. Obtain the sample in a damp, non-absorbent container from the discharge end of the nozzle.

For compressive strength of shotcrete, a 18 x 18 x 3.5 in. (457 x 457 x 89 mm) test panel shall be shot by the Contractor for testing by the Engineer. A steel form test panel shall have a minimum thickness of 3/16 in. (5 mm) for the bottom and sides. A wood form test panel shall have a minimum 3/4 in. (19 mm) thick bottom, and a minimum 1.5 in. (38 mm) thickness for the sides. The test panel shall be cured according to Article 1020.13 (a) (3) or (5) while stored at the jobsite and during delivery to the laboratory. After delivery to the laboratory for testing, curing and testing shall be according to ASTM C 1140.

The method of alignment control (i.e. ground wires, guide strips, depth gages, depth probes, and formwork) to ensure the specified shotcrete thickness and reinforcing bar cover is obtained shall be according to ACI 506R. Ground wires shall be removed after completion of cutting operations. Guide strips and formwork shall be of dimensions and a configuration that do not prevent proper application of shotcrete. Metal depth gauges shall be cut 1/4 in. (6 mm) below the finished surface. All repaired members shall be restored as close as practicable to their original dimensions.

For air temperature limits when applying shotcrete in cold weather, the first paragraph of Article 1020.14(b) shall apply. For hot weather, shotcrete shall not be applied when the air temperature is greater than 90°F (32°C). The applied shotcrete shall have a minimum temperature of 50°F (10°C) and a maximum temperature of 90°F (32°C). The shotcrete shall not be applied during periods of rain unless protective covers or enclosures are installed. The shotcrete shall not be applied when frost is present on the surface of the repair area, or the surface temperature of the repair area is less than 40°F (4°C). If necessary, lighting shall be provided to provide a clear view of the shooting area.

The shotcrete shall be applied according to ACI 506R, and shall be done in a manner that does not result in cold joints, laminations, sandy areas, voids, sags, or separations. In addition, the shotcrete shall be applied in a manner that results in maximum densification of the shotcrete. Shotcrete which is identified as being unacceptable while still plastic shall be removed and re-applied.

The nozzle shall normally be at a distance of 2 to 5 ft. (0.6 to 1.5 m) from the receiving surface, and shall be oriented at right angles to the receiving surface. Exceptions to this requirement will be permitted to fill corners, encase large diameter reinforcing bars, or as approved by the Engineer. For any exception, the nozzle shall never be oriented more than 45 degrees from the surface. Care shall be taken to keep the front face of the reinforcement bar clean during shooting operations. Shotcrete shall be built up from behind the reinforcement bar. Accumulations of rebound and overspray shall be continuously removed prior to application of new shotcrete. Rebound material shall not be incorporated in the work.

Whenever possible, shotcrete shall be applied to the full thickness in a single layer.

The maximum thickness shall be 4 in. (100 mm) unless the shotcrete is applied from above on a horizontal surface, or a thicker application is approved by the Engineer. When two or more layers are required, the minimum number shall be used and shall be done in a manner without sagging or separation. A flash coat (i.e. a thin layer of up to 1/4 in. (6 mm) applied shotcrete) may be used as the final lift for overhead applications.

Prior to application of a succeeding layer of shotcrete, the initial layer of shotcrete shall be prepared according to the surface preparation and reinforcement bar cleaning requirements. Upon completion of the surface preparation and reinforcement bar treatment, water shall be applied according to the surface preparation requirements unless the surface is moist. The second layer of shotcrete shall then be applied within 30 minutes.

Shotcrete shall be cut back to line and grade using trowels, cutting rods, screeds or other suitable devices. The shotcrete shall be allowed to stiffen sufficiently before cutting. Cutting shall not cause cracks or delaminations in the shotcrete. For depressions, cut material may be used for small areas. Rebound material shall not be incorporated in the work. For the final finish, a wood float shall be used to approximately match the existing concrete texture. All repaired members shall be restored as close as practicable to their original dimensions.

Contractor operations for curing shall be continuous with shotcrete placement and finishing operations. The Engineer may require modification of operations to ensure satisfactory results are obtained. Cotton mats shall be applied according to Article 1020.13(a)(5) except the exposed layer of shotcrete shall be covered within 10 minutes after finishing, and wet curing shall begin immediately. As an alternative to this method, Type I curing compound shall be applied according to Article 1020.13(a)(4) within 10 minutes and moist curing with cotton mats shall begin within 3 hours. For overhead applications where the final shotcrete layer has been applied, the Contractor has the option to use Type I curing compound in lieu of the cotton mats. Note 5 of the Index Table in Article 1020.13 shall apply to the membrane curing method. The curing compound shall be applied according to Article 1020.13(a)(4).

When a shotcrete layer is to be covered by a succeeding shotcrete layer within 36 hours, the repair area shall be protected with intermittent hand fogging, or wet curing with either burlap or cotton mats shall begin within 10 minutes. Intermittent hand fogging may be used only for the first hour. Thereafter, wet curing with burlap or cotton mats shall be used until the succeeding shotcrete layer is applied. Intermittent hand fogging may be extended to the first hour and a half if the succeeding shotcrete layer is applied by the end of this time.

The curing period shall be for 7 days, except when there is a succeeding layer of shotcrete. In this instance, the initial shotcrete layer shall be cured until the surface preparation and reinforcement bar treatment is started.

If temperatures below 45°F (7°C) are forecast during the curing period, protection methods shall be used. Protection Method I according to Article 1020.13(d)(1), or Protection Method II according to Article 1020.13(d)(2) shall be used during the curing period

Inspection of Completed Work. The Contractor shall provide ladders or other appropriate equipment for the Engineer to inspect the repaired areas. After curing but no sooner than 28 days after placement of concrete or shooting of shotcrete, the repair shall be examined for conformance with original dimensions, cracks, voids, and delaminations. Sounding for delaminations will be done with a hammer or by other methods determined by the Engineer.

The repaired area shall be removed and replaced, as determined by the Engineer, for nonconformance with original dimensions, surface cracks greater than 0.01 in. (0.25 mm) in width, map cracking with a crack spacing in any direction of 18 in. (0.45 m) or less, voids, or delaminations.

If a nonconforming repair is allowed to remain in place, cracks 0.01 in. (0.25 mm) or less shall be repaired with epoxy according to Section 590. For cracks less than 0.007 in. (2 mm), the epoxy may be applied to the surface of the crack. Voids shall be repaired according to Article 503.15.

Publications and Personnel Requirements. The Contractor shall provide a current copy of ACI 506R to the Engineer a minimum of one week prior to start of construction.

The shotcrete personnel who perform the work shall have current American Concrete Institute (ACI) nozzlemen certification for vertical wet and overhead wet applications, except one individual may be in training. This individual shall be adequately supervised by a certified ACI nozzlemen as determined by the Engineer. A copy of the nozzlemen certificate(s) shall be given to the Engineer.

Method of Measurement. This work will be measured for payment in place and the area computed in square feet (square meters). For a repair at a corner, both sides will be measured.

Basis of Payment. This work will be paid for at the contract unit price per square foot (square meter) for STRUCTURAL REPAIR OF CONCRETE (DEPTH GREATER THAN 5 IN. (125 MM), STRUCTURAL REPAIR OF CONCRETE (DEPTH EQUAL TO OR LESS THAN 5 IN. (125 MM)).

When not specified to be paid for elsewhere, the work to design, install, and remove the temporary shoring and cribbing will be paid for according to Article 109.04.

With the exception of reinforcement damaged by the Contractor during removal, the furnishing and installation of supplemental reinforcement bars, mechanical bar splicers, hook bolts, and protective coat will be paid according to Article 109.04.

## **APPROVAL OF PROPOSED BORROW AREAS, USE AREAS, AND/OR WASTE AREAS (BDE)**

Effective: November 1, 2008

Revised: November 1, 2010

Replace the first paragraph of Article 107.22 of the Standard Specifications with the following:

“All proposed borrow areas, including commercial borrow areas; use areas, including, but not limited to temporary access roads, detours, runarounds, plant sites, and staging and storage areas; and/or waste areas are to be designated by the Contractor to the Engineer and approved prior to their use.



Such areas outside the State of Illinois shall be evaluated, at no additional cost to the Department, according to the requirements of the state in which the area lies; and approval by the authority within that state having jurisdiction for such areas shall be forwarded to the Engineer. Such areas within Illinois shall be evaluated as described herein.

A location map delineating the proposed borrow area, use area, and/or waste area shall be submitted to the Engineer for approval along with an agreement from the property owner granting the Department permission to enter the property and conduct cultural and biological resource reconnaissance surveys of the site for archaeological resources, threatened or endangered species or their designated essential habitat, wetlands, prairies, and savannahs. The type of location map submitted shall be a topographic map, a plat map, or a 7.5 minute quadrangle map. Submittals shall include the intended use of the site and provide sufficient detail for the Engineer to determine the extent of impacts to the site. The Engineer will initiate cultural and biological resource reconnaissance surveys of the site, as necessary, at no cost to the Contractor. The Engineer will advise the Contractor of the expected time required to complete all surveys. If the proposed area is within 150 ft (45 m) of the highway right-of-way, a topographic map of the proposed site will be required as specified in Article 204.02.”

## **CEMENT (BDE)**

Effective: January 1, 2007

Revised: April 1, 2011

Revise Section 1001 of the Standard Specifications to read:

### **“SECTION 1001. CEMENT**

**1001.01 Cement Types.** Cement shall be according to the following.

- (a) Portland Cement. Acceptance of portland cement shall be according to the current Bureau of Materials and Physical Research’s Policy Memorandum, “Portland or Blended Cement Acceptance Procedure for Qualified and Non-Qualified Plants”.

Portland cement shall be according to AASHTO M 85, and shall meet the standard physical and chemical requirements. The Contractor has the option to use any type of portland cement listed in AASHTO M 85 unless a specific cement is specified for a construction item. Inorganic processing additions shall be limited to granulated blast-furnace slag according to the chemical requirements of AASHTO M 302, Class C or F fly ash according to the chemical requirements of AASHTO M 295, and cement kiln dust.

- (b) Portland-Pozzolan Cement. Acceptance of portland-pozzolan cement shall be according to the current Bureau of Materials and Physical Research’s Policy Memorandum, “Portland or Blended Cement Acceptance Procedure for Qualified and Non-Qualified Plants”.

Portland-pozzolan cement shall be according to AASHTO M 240 and shall meet the standard physical and chemical requirements. The Contractor has the option to use portland-pozzolan cement unless a specific cement is specified for a construction item. Inorganic processing additions shall be limited to granulated blast-furnace slag according to the chemical requirements of AASHTO M 302, Class C or F fly ash according to the chemical requirements of AASHTO M 295, and cement kiln dust. The pozzolan constituent for Type IP using Class F fly ash shall be a maximum of 25 percent of the weight (mass) of the portland-pozzolan cement.

The pozzolan constituent for Type IP using Class C fly ash shall be a maximum of 30 percent of the weight (mass) of the portland-pozzolan cement. The pozzolan constituent for Type IP using microsilica or high-reactivity metakaolin shall be a maximum of ten percent. The pozzolan constituent for Type IP using other materials shall have the approval of the Engineer.

Portland-pozzolan cement may be used in concrete mixtures when the air temperature is below 40 °F (4 °C), but the Engineer may request a trial batch of the concrete mixture to show the mix design strength requirement will be met.

- (c) Portland Blast-Furnace Slag Cement. Acceptance of portland blast-furnace slag cement shall be according to the current Bureau of Materials and Physical Research's Policy Memorandum, "Portland or Blended Cement Acceptance Procedure for Qualified and Non-Qualified Plants".

Portland blast-furnace slag cement shall be according to AASHTO M 240 and shall meet the standard physical and chemical requirements. The Contractor has the option to use portland blast-furnace slag cement unless a specific cement is specified for a construction item. Inorganic processing additions shall be limited to granulated blast-furnace slag according to the chemical requirements of AASHTO M 302, Class C or F fly ash according to the chemical requirements of AASHTO M 295, and cement kiln dust. The blast-furnace slag constituent for Type IS shall be a maximum of 35 percent of the weight (mass) of the portland blast-furnace slag cement.

Portland blast-furnace slag cement may be used in concrete mixtures when the air temperature is below 40 °F (4 °C), but the Engineer may request a trial batch of the concrete mixture to show the mix design strength requirement will be met.

- (d) Rapid Hardening Cement. Rapid hardening cement shall be used according to Article 1020.04 or when approved by the Engineer. The cement shall be on the Department's current "Approved List of Packaged, Dry, Rapid Hardening Cementitious Materials for Concrete Repairs", and shall be according to the following.

- (1) The cement shall have a maximum final set of 25 minutes, according to Illinois Modified AASHTO T 131.
- (2) The cement shall have a minimum compressive strength of 2000 psi (13,800 kPa) at 3.0 hours, 3200 psi (22,100 kPa) at 6.0 hours, and 4000 psi (27,600 kPa) at 24.0 hours, according to Illinois Modified AASHTO T 106.
- (3) The cement shall have a maximum drying shrinkage of 0.050 percent at seven days, according to Illinois Modified ASTM C 596.
- (4) The cement shall have a maximum expansion of 0.020 percent at 14 days, according to Illinois Modified ASTM C 1038.
- (5) The cement shall have a minimum 80 percent relative dynamic modulus of elasticity; and shall not have a weight (mass) gain in excess of 0.15 percent or a weight (mass) loss in excess of 1.0 percent, after 100 cycles, according to Illinois Modified AASHTO T 161, Procedure B.

- (e) Calcium Aluminate Cement. Calcium aluminate cement shall be used according to Article 1020.04 or when approved by the Engineer. The cement shall meet the standard physical requirements for Type I cement according to AASHTO M 85, except the time of setting shall not apply.

The chemical requirements shall be determined according to AASHTO T 105 and shall be as follows: minimum 38 percent aluminum oxide ( $Al_2O_3$ ), maximum 42 percent calcium oxide (CaO), maximum 1 percent magnesium oxide (MgO), maximum 0.4 percent sulfur trioxide ( $SO_3$ ), maximum 1 percent loss on ignition, and maximum 3.5 percent insoluble residue.

**1001.02 Uniformity of Color.** Cement contained in single loads or in shipments of several loads to the same project shall not have visible differences in color.

**1001.03 Mixing Brands and Types.** Different brands or different types of cement from the same manufacturing plant, or the same brand or type from different plants shall not be mixed or used alternately in the same item of construction unless approved by the Engineer.

**1001.04 Storage.** Cement shall be stored and protected against damage, such as dampness which may cause partial set or hardened lumps. Different brands or different types of cement from the same manufacturing plant, or the same brand or type from different plants shall be kept separate.”

## **CONCRETE ADMIXTURES (BDE)**

Effective: January 1, 2003

Revised: April 1, 2009

Replace the first paragraph of Article 1020.05(b) of the Standard Specifications to read:

“(b) Admixtures. The use of admixtures to increase the workability or to accelerate the hardening of the concrete will be permitted when approved by the Engineer. Admixture dosages shall result in the mixture meeting the specified plastic and hardened properties. The Department will maintain an Approved List of Corrosion Inhibitors. Corrosion inhibitor dosage rates shall be according to Article 1020.05(b)(12). The Department will also maintain an Approved List of Concrete Admixtures, and an admixture technical representative shall be consulted when determining an admixture dosage from this list. The dosage shall be within the range indicated on the approved list unless the influence by other admixtures, jobsite conditions (such as a very short haul time), or other circumstances warrant a dosage outside the range. The Engineer shall be notified when a dosage is proposed outside the range. To determine an admixture dosage, air temperature, concrete temperature, cement source and quantity, finely divided mineral sources(s) and quantity, influence of other admixtures, haul time, placement conditions, and other factors as appropriate shall be considered. The Engineer may request the Contractor to have a batch of concrete mixed in the lab or field to verify the admixture dosage is correct. An admixture dosage or combination of admixture dosages shall not delay the initial set of concrete by more than one hour. When a retarding admixture is required or appropriate for a bridge deck or bridge deck overlay pour, the initial set time shall be delayed until the deflections due to the concrete dead load are no longer a concern for inducing cracks in the completed work. However, a retarding admixture shall not be used to further extend the pour time and justify the alteration of a bridge deck pour sequence.

When determining water in admixtures for water/cement ratio, the Contractor shall calculate 70 percent of the admixture dosage as water, except a value of 50 percent shall be used for a latex admixture used in bridge deck latex concrete overlays.”

Revise Section 1021 of the Standard Specifications to read:

## **“SECTION 1021. CONCRETE ADMIXTURES**

**1021.01 General.** Admixtures shall be furnished in liquid form ready for use. The admixtures shall be delivered in the manufacturer's original containers, bulk tank trucks or such containers or tanks as are acceptable to the Engineer. Delivery shall be accompanied by a ticket which clearly identifies the manufacturer and trade name of the material. Containers shall be readily identifiable as to manufacturer and trade name of the material they contain.

Corrosion inhibitors will be maintained on the Department's Approved List of Corrosion Inhibitors. All other concrete admixture products will be maintained on the Department's Approved List of Concrete Admixtures. For the admixture submittal, a report prepared by an independent laboratory accredited by the AASHTO Materials Reference Laboratory (AMRL) for Portland Cement Concrete shall be provided. The report shall show the results of physical tests conducted no more than five years prior to the time of submittal, according to applicable specifications. However, for corrosion inhibitors the ASTM G 109 test information specified in ASTM C 1582 is not required to be from an independent lab. All other information in ASTM C 1582 shall be from an independent lab.

Tests shall be conducted using materials and methods specified on a "test" concrete and a "reference" concrete, together with a certification that no changes have been made in the formulation of the material since the performance of the tests. Per the manufacturer's option, the cement content for all required tests shall either be according to applicable specifications or 5.65 cwt/cu yd (335 kg/cu m). Compressive strength test results for six months and one year will not be required.

Prior to the approval of an admixture, the Engineer reserves the right to request a sample for testing. The test and reference concrete mixtures tested by the Engineer will contain a cement content of 5.65 cwt/cu yd (335 kg/cu m). For freeze-thaw testing, the Department will perform the test according to AASHTO T 161, Procedure B. The flexural strength test will be performed according to AASHTO T 177. If the Engineer decides to test the admixture, the manufacturer shall submit AASHTO T 197 water content and set time test results on the standard cement used by the Department. The test and reference concrete mixture shall contain a cement content of 5.65 cwt/cu yd (335 kg/cu m). The manufacturer may select their lab or an independent lab to perform this testing. The laboratory is not required to be accredited by AASHTO.

The manufacturer shall include in the submittal the following admixture information: the manufacturing range for specific gravity, the midpoint and manufacturing range for residue by oven drying, and the manufacturing range for pH. The submittal shall also include an infrared spectrophotometer trace no more than five years old.

For air-entraining admixtures according to Article 1021.02, the specific gravity allowable manufacturing range shall be established by the manufacturer and the test method shall be according to ASTM C 494. For residue by oven drying and pH, the allowable manufacturing range and test methods shall be according to ASTM C 260.

For admixtures according to Articles 1021.03, 1021.04, 1021.05, 1021.06, and 1021.07, the pH allowable manufacturing range shall be established by the manufacturer and the test method shall be according to ASTM E 70. For specific gravity and residue by oven drying, the allowable manufacturing range and test methods shall be according to ASTM C 494.

When test results are more than seven years old, the manufacturer shall re-submit the infrared spectrophotometer trace and the report prepared by an independent laboratory accredited by AASHTO.

All admixtures, except chloride-based accelerators, shall contain a maximum of 0.3 percent chloride by weight (mass).

Random field samples may be taken by the Department to verify an admixture meets specification. A split sample will be provided to the manufacturer if requested. Admixtures that do not meet specification requirements or an allowable manufacturing range established by the manufacturer shall be replaced with new material.

**1021.02 Air-Entraining Admixtures.** Air-entraining admixtures shall be according to AASHTO M 154.

**1021.03 Retarding and Water-Reducing Admixtures.** The admixture shall be according to the following.

- (a) The retarding admixture shall be according to AASHTO M 194, Type B (retarding) or Type D (water-reducing and retarding).
- (b) The water-reducing admixture shall be according to AASHTO M 194, Type A.
- (c) The high range water-reducing admixture shall be according to AASHTO M 194, Type F (high range water-reducing) or Type G (high range water-reducing and retarding).

**1021.04 Accelerating Admixtures.** The admixture shall be according to AASHTO M 194, Type C (accelerating) or Type E (water reducing and accelerating).

**1021.05 Self-Consolidating Admixtures.** The self-consolidating admixture system shall consist of either a high range water-reducing admixture only or a high range water-reducing admixture combined with a separate viscosity modifying admixture. The one or two component admixture system shall be capable of producing a concrete mixture that can flow around reinforcement and consolidate under its own weight without additional effort and without segregation.

The high range water-reducing admixture shall be according to AASHTO M 194, Type F.

The viscosity modifying admixture shall be according to ASTM C 494, Type S (specific performance).

**1021.06 Rheology-Controlling Admixture.** The rheology-controlling admixture shall be capable of producing a concrete mixture with a lower yield stress that will consolidate easier for slipform applications used by the Contractor. The rheology-controlling admixture shall be according to ASTM C 494, Type S (specific performance).

**1021.07 Corrosion Inhibitor.** The corrosion inhibitor shall be according to one of the following.

- (a) Calcium Nitrite. The corrosion inhibitor shall contain a minimum 30 percent calcium nitrite by weight (mass) of solution, and shall comply with the requirements of AASHTO M 194, Type C (accelerating).

(b) Other Materials. The corrosion inhibitor shall be according to ASTM C 1582.”

**CONSTRUCTION AIR QUALITY - DIESEL VEHICLE EMISSIONS CONTROL (BDE)**

Effective: April 1, 2009

Revised: July 1, 2009

Diesel Vehicle Emissions Control. The reduction of construction air emissions shall be accomplished by using cleaner burning diesel fuel. The term “equipment” refers to any and all diesel fuel powered devices rated at 50 hp and above, to be used on the project site in excess of seven calendar days over the course of the construction period on the project site (including any “rental” equipment).

All equipment on the jobsite, with engine ratings of 50 hp and above, shall be required to: use Ultra Low Sulfur Diesel fuel (ULSD) exclusively (15 ppm sulfur content or less).

Diesel powered equipment in non-compliance will not be allowed to be used on the project site, and is also subject to a notice of non-compliance as outlined below.

The Contractor shall submit copies of monthly summary reports and include certified copies of the ULSD diesel fuel delivery slips for diesel fuel delivered to the jobsite for the reporting time period, noting the quantity of diesel fuel used.

If any diesel powered equipment is found to be in non-compliance with any portion of this specification, the Engineer will issue the Contractor a notice of non-compliance and identify an appropriate period of time, as outlined below under environmental deficiency deduction, in which to bring the equipment into compliance or remove it from the project site.

Any costs associated with bringing any diesel powered equipment into compliance with these diesel vehicle emissions controls shall be considered as included in the contract unit prices bid for the various items of work involved and no additional compensation will be allowed. The Contractor's compliance with this notice and any associated regulations shall also not be grounds for a claim.

Environmental Deficiency Deduction. When the Engineer is notified, or determines that an environmental control deficiency exists, he/she will notify the Contractor in writing, and direct the Contractor to correct the deficiency within a specified time period. The specified time-period, which begins upon Contractor notification, will be from 1/2 hour to 24 hours long, based on the urgency of the situation and the nature of the deficiency. The Engineer shall be the sole judge regarding the time period.

The deficiency will be based on lack of repair, maintenance and diesel vehicle emissions control.

If the Contractor fails to correct the deficiency within the specified time frame, a daily monetary deduction will be imposed for each calendar day or fraction thereof the deficiency continues to exist. The calendar day(s) will begin when the time period for correction is exceeded and end with the Engineer's written acceptance of the correction. The daily monetary deduction will be \$1,000.00 for each deficiency identified.

If a Contractor or subcontractor accumulates three environmental deficiency deductions in a contract period, the Contractor will be shutdown until the deficiency is corrected.

Such a shutdown will not be grounds for any extension of contract time, waiver of penalties, or be grounds for any claim.

### **CONSTRUCTION AIR QUALITY - IDLING RESTRICTIONS (BDE)**

Effective: April 1, 2009

Idling Restrictions. The Contractor shall establish truck-staging areas for all diesel powered vehicles that are waiting to load or unload material at the jobsite. Staging areas shall be located where the diesel emissions from the equipment will have a minimum impact on adjacent sensitive receptors. The Department will review the selection of staging areas, whether within or outside the existing highway right-of-way, to avoid locations near sensitive areas or populations to the extent possible. Sensitive receptors include, but are not limited to, hospitals, schools, residences, motels, hotels, daycare facilities, elderly housing and convalescent facilities. Diesel powered engines shall also be located as far away as possible from fresh air intakes, air conditioners, and windows. The Engineer will approve staging areas before implementation.

Diesel powered vehicle operators may not cause or allow the motor vehicle, when it is not in motion, to idle for more than a total of 10 minutes within any 60 minute period, except under any of the following circumstances:

- 1) The motor vehicle has a gross vehicle weight rating of less than 8000 lb (3630 kg).
- 2) The motor vehicle idles while forced to remain motionless because of on-highway traffic, an official traffic control device or signal, or at the direction of a law enforcement official.
- 3) The motor vehicle idles when operating defrosters, heaters, air conditioners, or other equipment solely to prevent a safety or health emergency.
- 4) A police, fire, ambulance, public safety, other emergency or law enforcement motor vehicle, or any motor vehicle used in an emergency capacity, idles while in an emergency or training mode and not for the convenience of the vehicle operator.
- 5) The primary propulsion engine idles for maintenance, servicing, repairing, or diagnostic purposes if idling is necessary for such activity.
- 6) A motor vehicle idles as part of a government inspection to verify that all equipment is in good working order, provided idling is required as part of the inspection.
- 7) When idling of the motor vehicle is required to operate auxiliary equipment to accomplish the intended use of the vehicle (such as loading, unloading, mixing, or processing cargo; controlling cargo temperature; construction operations, lumbering operations; oil or gas well servicing; or farming operations), provided that this exemption does not apply when the vehicle is idling solely for cabin comfort or to operate non-essential equipment such as air conditioning, heating, microwave ovens, or televisions.
- 8) When the motor vehicle idles due to mechanical difficulties over which the operator has no control.
- 9) The outdoor temperature is less than 32 °F (0 °C) or greater than 80 °F (26 °C).

When the outdoor temperature is greater than or equal to 32 °F (0 °C) or less than or equal to 80 °F (26 °C), a person who operates a motor vehicle operating on diesel fuel shall not cause or allow the motor vehicle to idle for a period greater than 30 minutes in any 60 minute period while waiting to weigh, load, or unload cargo or freight, unless the vehicle is in a line of vehicles that regularly and periodically moves forward.

The above requirements do not prohibit the operation of an auxiliary power unit or generator set as an alternative to idling the main engine of a motor vehicle operating on diesel fuel.

Environmental Deficiency Deduction. When the Engineer is notified, or determines that an environmental control deficiency exists based on non-compliance with the idling restrictions, he/she will notify the Contractor, and direct the Contractor to correct the deficiency.

If the Contractor fails to correct the deficiency a monetary deduction will be imposed. The monetary deduction will be \$1,000.00 for each deficiency identified.

**DISADVANTAGED BUSINESS ENTERPRISE PARTICIPATION (DBE)**

Effective: September 1, 2000

Revised: January 1, 2011

FEDERAL OBLIGATION. The Department of Transportation, as a recipient of federal financial assistance, is required to take all necessary and reasonable steps to ensure nondiscrimination in the award and administration of contracts. Consequently, the federal regulatory provisions of 49 CFR part 26 apply to this contract concerning the utilization of disadvantaged business enterprises. For the purposes of this Special Provision, a disadvantaged business enterprise (DBE) means a business certified by the Department in accordance with the requirements of 49 CFR part 26 and listed in the Illinois Unified Certification Program (IL UCP) DBE Directory.

STATE OBLIGATION. This Special Provision will also be used by the Department to satisfy the requirements of the Business Enterprise for Minorities, Females, and Persons with Disabilities Act, 30 ILCS 575. When this Special Provision is used to satisfy state law requirements on 100 percent state-funded contracts, the federal government has no involvement in such contracts (not a federal-aid contract) and no responsibility to oversee the implementation of this Special Provision by the Department on those contracts. DBE participation on 100 percent state-funded contracts will not be credited toward fulfilling the Department's annual overall DBE goal required by the US Department of Transportation to comply with the federal DBE program requirements.

CONTRACTOR ASSURANCE. The Contractor makes the following assurance and agrees to include the assurance in each subcontract that the Contractor signs with a subcontractor:

The Contractor, subrecipient, or subcontractor shall not discriminate on the basis of race, color, national origin, or sex in the performance of this contract. The Contractor shall carry out applicable requirements of 49 CFR part 26 in the award and administration of contracts funded in whole or in part with federal or state funds. Failure by the Contractor to carry out these requirements is a material breach of this contract, which may result in the termination of this contract or such other remedy as the recipient deems appropriate.

OVERALL GOAL SET FOR THE DEPARTMENT. As a requirement of compliance with 49 CFR part 26, the Department has set an overall goal for DBE participation in its federally assisted contracts. That goal applies to all federal-aid funds the Department will expend in its federally assisted contracts for the subject reporting fiscal year. The Department is required to make a good faith effort to achieve the overall goal. The dollar amount paid to all approved DBE companies performing work called for in this contract is eligible to be credited toward fulfillment of the Department's overall goal.

CONTRACT GOAL TO BE ACHIEVED BY THE CONTRACTOR. This contract includes a specific DBE utilization goal established by the Department. The goal has been included because the Department has determined that the work of this contract has subcontracting opportunities that may be suitable for performance by DBE companies.



This determination is based on an assessment of the type of work, the location of the work, and the availability of DBE companies to do a part of the work. The assessment indicates that, in the absence of unlawful discrimination, and in an arena of fair and open competition, DBE companies can be expected to perform **7.00%** of the work. This percentage is set as the DBE participation goal for this contract. Consequently, in addition to the other award criteria established for this contract, the Department will only award this contract to a bidder who makes a good faith effort to meet this goal of DBE participation in the performance of the work. A bidder makes a good faith effort for award consideration if either of the following is done in accordance with the procedures set forth in this Special Provision:

- (a) The bidder documents that enough DBE participation has been obtained to meet the goal; or
- (b) The bidder documents that a good faith effort has been made to meet the goal, even though the effort did not succeed in obtaining enough DBE participation to meet the goal.

**DBE LOCATOR REFERENCES.** Bidders may consult the IL UCP DBE Directory as a reference source for DBE-certified companies. In addition, the Department maintains a letting and item specific DBE locator information system whereby DBE companies can register their interest in providing quotes on particular bid items advertised for letting. Information concerning DBE companies willing to quote work for particular contracts may be obtained by contacting the Department's Bureau of Small Business Enterprises at telephone number (217)785-4611, or by visiting the Department's web site at [www.dot.il.gov](http://www.dot.il.gov).

**BIDDING PROCEDURES.** Compliance with this Special Provision is a material bidding requirement. The failure of the bidder to comply will render the bid not responsive.

- (a) The bidder shall submit a Disadvantaged Business Utilization Plan on Department forms SBE 2025 and 2026 with the bid.
- (b) The Utilization Plan shall indicate that the bidder either has obtained sufficient DBE participation commitments to meet the contract goal or has not obtained enough DBE participation commitments in spite of a good faith effort to meet the goal. The Utilization Plan shall further provide the name, telephone number, and telefax number of a responsible official of the bidder designated for purposes of notification of plan approval or disapproval under the procedures of this Special Provision.
- (c) The Utilization Plan shall include a DBE Participation Commitment Statement, Department form SBE 2025, for each DBE proposed for the performance of work to achieve the contract goal. For bidding purposes, submission of the completed SBE 2025 forms, signed by the DBEs and faxed to the bidder will be acceptable as long as the original is available and provided upon request. All elements of information indicated on the said form shall be provided, including but not limited to the following:
  - (1) The names and addresses of DBE firms that will participate in the contract;
  - (2) A description, including pay item numbers, of the work each DBE will perform;
  - (3) The dollar amount of the participation of each DBE firm participating. The dollar amount of participation for identified work shall specifically state the quantity, unit price, and total subcontract price for the work to be completed by the DBE. If partial pay items are to be performed by the DBE, indicate the portion of each item, a unit price where appropriate and the subcontract price amount;

- (4) DBE Participation Commitment Statements, form SBE 2025, signed by the bidder and each participating DBE firm documenting the commitment to use the DBE subcontractors whose participation is submitted to meet the contract goal;
- (5) If the bidder is a joint venture comprised of DBE companies and non-DBE companies, the plan must also include a clear identification of the portion of the work to be performed by the DBE partner(s); and,
- (6) If the contract goal is not met, evidence of good faith efforts.

GOOD FAITH EFFORT PROCEDURES. The contract will not be awarded until the Utilization Plan submitted by the apparent successful bidder is approved. All information submitted by the bidder must be complete, accurate and adequately document that enough DBE participation has been obtained or document the good faith efforts of the bidder, in the event enough DBE participation has not been obtained, before the Department will commit to the performance of the contract by the bidder. The Utilization Plan will be approved by the Department if the Utilization Plan documents sufficient commercially useful DBE work performance to meet the contract goal or the bidder submits sufficient documentation of a good faith effort to meet the contract goal pursuant to 49 CFR part 26, Appendix A. The Utilization Plan will not be approved by the Department if the Utilization Plan does not document sufficient DBE participation to meet the contract goal unless the apparent successful bidder documented in the Utilization Plan that it made a good faith effort to meet the goal. This means that the bidder must show that all necessary and reasonable steps were taken to achieve the contract goal. Necessary and reasonable steps are those which, by their scope, intensity and appropriateness to the objective, could reasonably be expected to obtain sufficient DBE participation, even if they were not successful. The Department will consider the quality, quantity, and intensity of the kinds of efforts that the bidder has made. Mere *pro forma* efforts, in other words, efforts done as a matter of form, are not good faith efforts; rather, the bidder is expected to have taken genuine efforts that would be reasonably expected of a bidder actively and aggressively trying to obtain DBE participation sufficient to meet the contract goal.

- (a) The following is a list of types of action that the Department will consider as part of the evaluation of the bidder's good faith efforts to obtain participation. These listed factors are not intended to be a mandatory checklist and are not intended to be exhaustive. Other factors or efforts brought to the attention of the Department may be relevant in appropriate cases, and will be considered by the Department.
  - (1) Soliciting through all reasonable and available means (e.g. attendance at pre-bid meetings, advertising and/or written notices) the interest of all certified DBE companies that have the capability to perform the work of the contract. The bidder must solicit this interest within sufficient time to allow the DBE companies to respond to the solicitation. The bidder must determine with certainty if the DBE companies are interested by taking appropriate steps to follow up initial solicitations.
  - (2) Selecting portions of the work to be performed by DBE companies in order to increase the likelihood that the DBE goals will be achieved. This includes, where appropriate, breaking out contract work items into economically feasible units to facilitate DBE participation, even when the prime Contractor might otherwise prefer to perform these work items with its own forces.
  - (3) Providing interested DBE companies with adequate information about the plans, specifications, and requirements of the contract in a timely manner to assist them in responding to a solicitation.

- (4) a. Negotiating in good faith with interested DBE companies. It is the bidder's responsibility to make a portion of the work available to DBE subcontractors and suppliers and to select those portions of the work or material needs consistent with the available DBE subcontractors and suppliers, so as to facilitate DBE participation. Evidence of such negotiation includes the names, addresses, and telephone numbers of DBE companies that were considered; a description of the information provided regarding the plans and specifications for the work selected for subcontracting; and evidence as to why additional agreements could not be reached for DBE companies to perform the work.
    - b. A bidder using good business judgment would consider a number of factors in negotiating with subcontractors, including DBE subcontractors, and would take a firm's price and capabilities as well as contract goals into consideration. However, the fact that there may be some additional costs involved in finding and using DBE companies is not in itself sufficient reason for a bidder's failure to meet the contract DBE goal, as long as such costs are reasonable. Also, the ability or desire of a bidder to perform the work of a contract with its own organization does not relieve the bidder of the responsibility to make good faith efforts. Bidders are not, however, required to accept higher quotes from DBE companies if the price difference is excessive or unreasonable.
  - (5) Not rejecting DBE companies as being unqualified without sound reasons based on a thorough investigation of their capabilities. The bidder's standing within its industry, membership in specific groups, organizations, or associations and political or social affiliations (for example union vs. non-union employee status) are not legitimate causes for the rejection or non-solicitation of bids in the bidder's efforts to meet the project goal.
  - (6) Making efforts to assist interested DBE companies in obtaining bonding, lines of credit, or insurance as required by the recipient or Contractor.
  - (7) Making efforts to assist interested DBE companies in obtaining necessary equipment, supplies, materials, or related assistance or services.
  - (8) Effectively using the services of available minority/women community organizations; minority/women contractors' groups; local, state, and federal minority/women business assistance offices; and other organizations as allowed on a case-by-case basis to provide assistance in the recruitment and placement of DBE companies.
- (b) If the Department determines that the apparent successful bidder has made a good faith effort to secure the work commitment of DBE companies to meet the contract goal, the Department will award the contract provided that it is otherwise eligible for award. If the Department determines that the bidder has failed to meet the requirements of this Special Provision or that a good faith effort has not been made, the Department will notify the responsible company official designated in the Utilization Plan that the bid is not responsive. The notification shall include a statement of reasons for the determination.
  - (c) The bidder may request administrative reconsideration of a determination adverse to the bidder within the five working days after receipt of the notification date of the determination by delivering the request to the Department of Transportation, Bureau of Small Business Enterprises, Contract Compliance Section, 2300 South Dirksen Parkway, Room 319, Springfield, Illinois 62764 (Telefax: (217)785-1524).

Deposit of the request in the United States mail on or before the fifth business day shall not be deemed delivery. The determination shall become final if a request is not made and delivered. A request may provide additional written documentation and/or argument concerning the issues raised in the determination statement of reasons, provided the documentation and arguments address efforts made prior to submitting the bid. The request will be forwarded to the Department's Reconsideration Officer. The Reconsideration Officer will extend an opportunity to the bidder to meet in person in order to consider all issues of documentation and whether the bidder made a good faith effort to meet the goal. After the review by the Reconsideration Officer, the bidder will be sent a written decision within ten working days after receipt of the request for reconsideration, explaining the basis for finding that the bidder did or did not meet the goal or make adequate good faith efforts to do so. A final decision by the Reconsideration Officer that a good faith effort was made shall approve the Utilization Plan submitted by the bidder and shall clear the contract for award. A final decision that a good faith effort was not made shall render the bid not responsive.

CALCULATING DBE PARTICIPATION. The Utilization Plan values represent work anticipated to be performed and paid for upon satisfactory completion. The Department is only able to count toward the achievement of the overall goal and the contract goal the value of payments made for the work actually performed by DBE companies. In addition, a DBE must perform a commercially useful function on the contract to be counted. A commercially useful function is generally performed when the DBE is responsible for the work and is carrying out its responsibilities by actually performing, managing, and supervising the work involved. The Department and Contractor are governed by the provisions of 49 CFR part 26.55(c) on questions of commercially useful functions as it affects the work. Specific counting guidelines are provided in 49 CFR part 26.55, the provisions of which govern over the summary contained herein.

- (a) DBE as the Contractor: 100 percent goal credit for that portion of the work performed by the DBE's own forces, including the cost of materials and supplies. Work that a DBE subcontracts to a non-DBE does not count toward the DBE goals.
- (b) DBE as a joint venture Contractor: 100 percent goal credit for that portion of the total dollar value of the contract equal to the distinct, clearly defined portion of the work performed by the DBE's own forces.
- (c) DBE as a subcontractor: 100 percent goal credit for the work of the subcontract performed by the DBE's own forces, including the cost of materials and supplies, excluding the purchase of materials and supplies or the lease of equipment by the DBE subcontractor from the prime Contractor or its affiliates. Work that a DBE subcontractor in turn subcontracts to a non-DBE does not count toward the DBE goal.
- (d) DBE as a trucker: 100 percent goal credit for trucking participation provided the DBE is responsible for the management and supervision of the entire trucking operation for which it is responsible. At least one truck owned, operated, licensed, and insured by the DBE must be used on the contract. Credit will be given for the following:
  - (1) The DBE may lease trucks from another DBE firm, including an owner-operator who is certified as a DBE. The DBE who leases trucks from another DBE receives credit for the total value of the transportation services the lessee DBE provides on the contract.

- (2) The DBE may also lease trucks from a non-DBE firm, including from an owner-operator. The DBE who leases trucks from a non-DBE is entitled to credit only for the fee or commission it receives as a result of the lease arrangement.

(e) DBE as a material supplier:

- (1) 60 percent goal credit for the cost of the materials or supplies purchased from a DBE regular dealer.
- (2) 100 percent goal credit for the cost of materials or supplies obtained from a DBE manufacturer.
- (3) 100 percent credit for the value of reasonable fees and commissions for the procurement of materials and supplies if not a regular dealer or manufacturer.

**CONTRACT COMPLIANCE.** Compliance with this Special Provision is an essential part of the contract. The Department is prohibited by federal regulations from crediting the participation of a DBE included in the Utilization Plan toward either the contract goal or the Department's overall goal until the amount to be applied toward the goals has been paid to the DBE. The following administrative procedures and remedies govern the compliance by the Contractor with the contractual obligations established by the Utilization Plan. After approval of the Utilization Plan and award of the contract, the Utilization Plan and individual DBE Participation Statements become part of the contract. If the Contractor did not succeed in obtaining enough DBE participation to achieve the advertised contract goal, and the Utilization Plan was approved and contract awarded based upon a determination of good faith, the total dollar value of DBE work calculated in the approved Utilization Plan as a percentage of the awarded contract value shall become the amended contract goal.

- (a) No amendment to the Utilization Plan may be made without prior written approval from the Department's Bureau of Small Business Enterprises. All requests for amendment to the Utilization Plan shall be submitted to the Department of Transportation, Bureau of Small Business Enterprises, Contract Compliance Section, 2300 South Dirksen Parkway, Room 319, Springfield, Illinois 62764. Telephone number (217) 785-4611. Telefax number (217) 785-1524.
- (b) The Contractor must notify and obtain written approval from the Department's Bureau of Small Business Enterprises prior to replacing a DBE or making any change in the participation of a DBE. Approval for replacement will be granted only if it is demonstrated that the DBE is unable or unwilling to perform. The Contractor must make every good faith effort to find another certified DBE subcontractor to substitute for the original DBE. The good faith efforts shall be directed at finding another DBE to perform at least the same amount of work under the contract as the original DBE, to the extent needed to meet the contract goal.
- (c) Any deviation from the DBE condition-of-award or contract specifications must be approved, in writing, by the Department. The Contractor shall notify affected DBEs in writing of any changes in the scope of work which result in a reduction in the dollar amount condition-of-award to the contract.
- (d) In addition to the above requirements for reductions in the condition of award, additional requirements apply to the two cases of Contractor-initiated work substitution proposals.

Where the contract allows alternate work methods which serve to delete or create underruns in condition of award DBE work, and the Contractor selects that alternate method or, where the Contractor proposes a substitute work method or material that serves to diminish or delete work committed to a DBE and replace it with other work, then the Contractor must demonstrate one of the following:

- (1) That the replacement work will be performed by the same DBE (as long as the DBE is certified in the respective item of work) in a modification of the condition of award; or
  - (2) That the DBE is aware that its work will be deleted or will experience underruns and has agreed in writing to the change. If this occurs, the Contractor shall substitute other work of equivalent value to a certified DBE or provide documentation of good faith efforts to do so; or
  - (3) That the DBE is not capable of performing the replacement work or has declined to perform the work at a reasonably competitive price. If this occurs, the Contractor shall substitute other work of equivalent value to a certified DBE or provide documentation of good faith efforts to do so.
- (e) Where the revision includes work committed to a new DBE subcontractor, not previously involved in the project, then a Request for Approval of Subcontractor, Department form BC 260A, must be signed and submitted.
- (f) If the commitment of work is in the form of additional tasks assigned to an existing subcontract, then a new Request for Approval of Subcontractor shall not be required. However, the Contractor must document efforts to assure that the existing DBE subcontractor is capable of performing the additional work and has agreed in writing to the change.
- (g) All work indicated for performance by an approved DBE shall be performed, managed, and supervised by the DBE executing the Participation Statement. The Contractor shall not terminate for convenience a DBE listed in the Utilization Plan and then perform the work of the terminated DBE with its own forces, those of an affiliate or those of another subcontractor, whether DBE or not, without first obtaining the written consent of the Bureau of Small Business Enterprises to amend the Utilization Plan. The Contractor shall notify the Bureau of Small Business Enterprises of any termination for reasons other than convenience, and shall obtain approval for inclusion of the substitute DBE in the Utilization Plan. If good faith efforts following a termination of a DBE for cause are not successful, the Contractor shall contact the Bureau of Small Business Enterprises and provide a full accounting of the efforts undertaken to obtain substitute DBE participation. The Bureau of Small Business Enterprises will evaluate the good faith efforts in light of all circumstances surrounding the performance status of the contract, and determine whether the contract goal should be amended.
- (h) The Contractor shall maintain a record of payments for work performed to the DBE participants. The records shall be made available to the Department for inspection upon request. After the performance of the final item of work or delivery of material by a DBE and final payment therefore to the DBE by the Contractor, but not later than thirty calendar days after payment has been made by the Department to the Contractor for such work or material, the Contractor shall submit a DBE Payment Agreement on Department form SBE 2115 to the Regional Engineer.

If full and final payment has not been made to the DBE, the DBE Payment Agreement shall indicate whether a disagreement as to the payment required exists between the Contractor and the DBE or if the Contractor believes that the work has not been satisfactorily completed. If the Contractor does not have the full amount of work indicated in the Utilization Plan performed by the DBE companies indicated in the Utilization Plan and after good faith efforts are reviewed, the Department may deduct from contract payments to the Contractor the amount of the goal not achieved as liquidated and ascertained damages. The Contractor may request an administrative reconsideration of any amount deducted as damages pursuant to subsection (j) of this part.

- (i) The Department reserves the right to withhold payment to the Contractor to enforce the provisions of this Special Provision. Final payment shall not be made on the contract until such time as the Contractor submits sufficient documentation demonstrating achievement of the goal in accordance with this Special Provision or after liquidated damages have been determined and collected.
- (j) Notwithstanding any other provision of the contract, including but not limited to Article 109.09 of the Standard Specifications, the Contractor may request administrative reconsideration of a decision to deduct the amount of the goal not achieved as liquidated damages. A request to reconsider shall be delivered to the Contract Compliance Section and shall be handled and considered in the same manner as set forth in paragraph (c) of "Good Faith Effort Procedures" of this Special Provision, except a final decision that a good faith effort was not made during contract performance to achieve the goal agreed to in the Utilization Plan shall be the final administrative decision of the Department.

**EQUIPMENT RENTAL RATES (BDE)**

Effective: August 2, 2007

Revised: January 2, 2008

Replace the second and third paragraphs of Article 105.07(b)(4)a. of the Standard Specifications with the following:

"Equipment idled which cannot be used on other work, and which is authorized to standby on the project site by the Engineer, will be paid for according to Article 109.04(b)(4)."

Replace Article 109.04(b)(4) of the Standard Specifications with the following:

- "(4) Equipment. Equipment used for extra work shall be authorized by the Engineer. The equipment shall be specifically described, be of suitable size and capacity for the work to be performed, and be in good operating condition. For such equipment, the Contractor will be paid as follows.
  - a. Contractor Owned Equipment. Contractor owned equipment will be paid for by the hour using the applicable FHWA hourly rate from the "Equipment Watch Rental Rate Blue Book" (Blue Book) in effect when the force account work begins. The FHWA hourly rate is calculated as follows.

FHWA hourly rate = (monthly rate/176) x (model year adj.) x (Illinois adj.) + EOC

Where: EOC = Estimated Operating Costs per hour (from the Blue Book)

The time allowed will be the actual time the equipment is operating on the extra work. For the time required to move the equipment to and from the site of the extra work and any authorized idle (standby) time, payment will be made at the following hourly rate: 0.5 x (FHWA hourly rate - EOC).

All time allowed shall fall within the working hours authorized for the extra work.

The rates above include the cost of fuel, oil, lubrication, supplies, small tools, necessary attachments, repairs, overhaul and maintenance of any kind, depreciation, storage, overhead, profits, insurance, and all incidentals. The rates do not include labor.

The Contractor shall submit to the Engineer sufficient information for each piece of equipment and its attachments to enable the Engineer to determine the proper equipment category. If a rate is not established in the Blue Book for a particular piece of equipment, the Engineer will establish a rate for that piece of equipment that is consistent with its cost and use in the industry.

- b. Rented Equipment. Whenever it is necessary for the Contractor to rent equipment to perform extra work, the rental and transportation costs of the equipment plus five percent for overhead will be paid. In no case shall the rental rates exceed those of established distributors or equipment rental agencies.

All prices shall be agreed to in writing before the equipment is used.”

### **HIGH TENSION CABLE MEDIAN BARRIER (BDE)**

Effective: January 1, 2007

Revised: April 1, 2009

Description. This work shall consist of furnishing and installing a high tension cable (HTC) median barrier with terminals/end anchorages.

Materials. Materials shall be according to the following.

Item	Article/Section
(a) Reinforcement Bars	1006.10(a)
(b) Portland Cement Concrete (Note 1)	1020
(c) Wire Rope (Cable) and Fittings (Note 2)	

Note 1. The portland cement concrete shall be Class SI.

Note 2. The wire rope (cable) shall be according to AASHTO M 30, Type 1 with Class A coating, of the diameter shown in the manufacturer's specifications. Additionally, the wire rope shall be prestretched and shall have a breaking strength of 39,285 lbs (175 kN) for 3/4 in. (19 mm) wire rope (individual wire strength equivalent to 174,000 psi (1200 N/mm)) and the prestretched wire rope shall have a minimum modulus of elasticity of 11,805,000 psi (8300 kg/mm).



The barrier shall be tested and accepted under the National Cooperative Highway Research Program (NCHRP) Report 350 for the required test level and be on the Department's approved list. Barriers installed on front slope grades of 1:6 or flatter shall be Test Level 4. Barriers installed on front slope grades steeper than 1:6 but 1:4 or flatter shall be Test Level 3.

The barrier shall include four longitudinal cables, each separated vertically from adjacent cable(s) by a minimum of 4 in. (100 mm), and according to the specific acceptance document issued by FHWA. Each cable shall run to a point of anchorage at the terminal without connection to any other cable. The maximum spacing for line posts in the cable barrier system shall be no more than shown in the specific document issued by FHWA, or 15 ft (4.6 m), whichever is less.

The terminals/end anchorages shall be tested and accepted under NCHRP Report 350 Test Level 3 and be on the Department's approved list.

Equipment. Equipment shall be according to the barrier manufacturer's specifications.

### Construction Requirements

General. The HTC median barrier shall be constructed to the lines and grades shown on the plans and according to the manufacturer's specifications except as modified by the contracts documents.

Line Post Foundations. Line posts for the HTC median barrier shall be placed in concrete socket foundations. The minimum depth of the foundations shall be as shown on the plans. The minimum diameter for the foundations shall be 12 in. (300 mm) and the tops of the foundations shall be crowned 1/2 in. (13 mm).

When the barrier is to be placed within paved shoulders or mow strips, the paved area(s) shall be constructed first and the concrete foundations placed in cored or formed holes.

End Anchorages. The Contractor shall submit shop drawings and calculations to the Engineer prepared and sealed by an Illinois Licensed Structural Engineer detailing the required end anchorage foundation system at each location. The system shall utilize drilled shaft foundation of a diameter, depth, reinforcement, and cable connection determined by the supplier. The design shall utilize Broms method utilizing a minimum factor of safety of 1.5. The design loadings shall consist of the theoretical cumulative cable tension expected for temperature fluctuations to -10 °F (-23 °C). The dynamic vehicle impact loading shall not be added to the cable temperature loading for the analysis. The foundation soils shall be assumed to be submerged granular material with a friction angle of 30 degrees or clay soils with a cohesive intercept of 1.0 kip/sq ft (48 kPa), unless site specific soil parameters are specified.

Tensioning. Prior to acceptance of the work, the tension of the HTC median barrier shall be checked, and adjusted as necessary, according to the manufacturer's temperature/tension chart or relationship.

Hands-On Demonstration. When included in the contract, a hands-on demonstration(s) of maintenance/repair procedures, recommendations and discussion of vehicle recovery, and provisions for emergency openings in the barrier shall be conducted. These demonstrations shall be for emergency responders, maintenance personnel, and others invited by the Engineer and shall either be conducted either at the job-site or at another agreed to meeting facility. Up to 30 attendees shall be accommodated at each demonstration.

Method of Measurement. HTC median barrier will be measured for payment in feet (meters) along the top cable between terminals. Terminals shall be defined as the end anchorages and other components from the extreme ends of a run to a point 50 ft (15.2 m) into the run. This definition of the terminal applies regardless of the length of need point, transitions from anchorage to full height cable, or other features that may vary between systems.

Basis of Payment. This work will be paid for at the contract unit price per foot (meter) for HIGH TENSION CABLE MEDIAN BARRIER.

The terminals/end anchorages and demonstrations will be paid for at the contract per each for HIGH TENSION CABLE MEDIAN BARRIER TERMINALS and HIGH TENSION CABLE MEDIAN BARRIER DEMONSTRATION respectively.

### **IMPACT ATTENUATORS (BDE)**

Effective: November 1, 2003

Revised: November 1, 2008

Description. This work shall consist of furnishing and installing impact attenuators of the category and test level specified.

Materials. Materials shall meet the requirements of the impact attenuator manufacturer and the following:

Item	Article/Section
(a) Fine Aggregate (Note 1).....	1003.01
(b) Steel Posts, Structural Shapes, and Plates .....	1006.04
(c) Rail Elements, End Section Plates, and Splice Plates .....	1006.25
(d) Bolts, Nuts, Washers and Hardware .....	1006.25
(e) Hollow Structural Tubing .....	1006.27(b)
(f) Wood Posts and Wood Blockouts .....	1007.01, 1007.02, 1007.06
(g) Preservative Treatment.....	1007.12

Note 1. Fine aggregate shall be FA 1 or FA 2, Class A quality. The sand shall be unbagged and shall have a maximum moisture content of five percent.

### **CONSTRUCTION REQUIREMENTS**

General. Impact attenuators shall meet the testing criteria contained in National Cooperative Highway Research Program (NCHRP) Report 350 for the test level specified and shall be on the Department's approved list. Fully redirective and partially redirective attenuators shall also be designed for bi-directional impacts.

Installation. Regrading of slopes or approaches for the installation shall be as shown on the plans.

Bases for impact attenuators, other than sand modules, shall be installed when required by the manufacturer. The bases shall be constructed on a prepared subgrade according to the manufacturer's specifications. The surface of the base shall be slightly sloped or crowned to facilitate drainage.

Bases for sand module impact attenuators will be required. The bases shall be constructed of either portland cement concrete or hot-mix asphalt (HMA).

Portland cement concrete bases shall be 6 in. (150 mm) thick and be according to the applicable requirements of Section 424 of the Standard Specifications. HMA bases shall be 8 in. (200 mm) thick and be according to the applicable requirements of Section 408 of the Standard Specifications. The surface of the base shall be slightly sloped or crowned to facilitate drainage. The perimeter of each module and the specified weight (mass) of sand in each module shall be painted on the surface of the base.

Impact attenuators shall be installed according to the manufacturer's specifications and include all necessary transitions between the impact attenuator and the item to which it is attached.

Method of Measurement. This work will be measured for payment as each, where each is defined as one complete installation.

Contract quantities for sand module attenuator bases may be accepted according to Article 202.07(a) of the Standard Specifications. When measured, sand module attenuator bases will be measured in place and the dimensions used to calculate square yards (square meters) will not exceed those as shown on the plans.

Basis of Payment. This work, will be paid for at the contract unit price per each for IMPACT ATTENUATORS (FULLY REDIRECTIVE, NARROW); IMPACT ATTENUATORS (FULLY REDIRECTIVE, WIDE); IMPACT ATTENUATORS (FULLY REDIRECTIVE, RESETTABLE); IMPACT ATTENUATORS (SEVERE USE, NARROW); IMPACT ATTENUATORS (SEVERE USE, WIDE); IMPACT ATTENUATORS (PARTIALLY REDIRECTIVE); or IMPACT ATTENUATORS (NON-REDIRECTIVE), of the test level specified.

Sand module attenuator bases will be paid for at the contract unit price per square yard (square meter) for ATTENUATOR BASE.

Regrading of slopes or approaches will be paid for according to Section 202 and/or Section 204 of the Standard Specifications.

**LIQUIDATED DAMAGES (BDE)**

Effective: April 1, 2009

Revised: April 1, 2011

Revise the table in Article 108.09 of the Standard Specifications to read:

"Schedule of Deductions for Each Day of Overrun in Contract Time			
Original Contract Amount		Daily Charges	
From More Than	To and Including	Calendar Day	Work Day
\$ 0	\$ 100,000	\$ 475	\$ 675
100,000	500,000	750	1,050
500,000	1,000,000	1,025	1,425
1,000,000	3,000,000	1,275	1,725
3,000,000	6,000,000	1,425	2,000
6,000,000	12,000,000	2,300	3,450
12,000,000	And over	5,800	8,125"

**NATIONAL POLLUTANT DISCHARGE ELIMINATION SYSTEM / EROSION AND SEDIMENT CONTROL DEFICIENCY DEDUCTION (BDE)**

Effective: April 1, 2007

Revised: November 1, 2009

Revise Article 105.03(a) of the Standard Specifications to read:

“(a) National Pollutant Discharge Elimination System (NPDES) / Erosion and Sediment Control Deficiency Deduction When the Engineer is notified or determines an erosion and/or sediment control deficiency(s) exists, or the Contractor’s activities represents a violation of the Department’s NPDES permits, the Engineer will notify and direct the Contractor to correct the deficiency within a specified time. The specified time, which begins upon notification to the Contractor, will be from 1/2 hour to 1 week based on the urgency of the situation and the nature of the work effort required. The Engineer will be the sole judge.

A deficiency may be any lack of repair, maintenance, or implementation of erosion and/or sediment control devices included in the contract, or any failure to comply with the conditions of the Department’s NPDES permits. A deficiency may also be applied to situations where corrective action is not an option such as the failure to participate in a jobsite inspection of the project, failure to install required measures prior to initiating earth moving operations, disregard of concrete washout requirements, or other disregard of the NPDES permit.

If the Contractor fails to correct a deficiency within the specified time, a daily monetary deduction will be imposed for each calendar day or portion of a calendar day until the deficiency is corrected to the satisfaction of the Engineer. The calendar day(s) will begin with notification to the Contractor and end with the Engineer’s acceptance of the correction. The base value of the daily monetary deduction is \$1000.00 and will be applied to each location for which a deficiency exists. The value of the deficiency deduction assessed for each infraction will be determined by multiplying the base value by a Gravity Adjustment Factor provided in Table A. Except for failure to participate in a required jobsite inspection of the project prior to initiating earthmoving operations which will be based on the total acreage of planned disturbance at the following multipliers: <5 Acres: 1; 5-10 Acres: 2; >10-25 Acres: 3; >25 Acres: 5. For those deficiencies where corrective action was not an option, the monetary deduction will be immediate and will be valued at one calendar day multiplied by a Gravity Adjustment Factor.

Table A Deficiency Deduction Gravity Adjustment Factors				
Types of Violations	Soil Disturbed and Not Permanently Stabilized At Time of Violation			
	< 5 Acres	5 - 10 Acres	>10 - 25 Acres	> 25 Acres
Failure to Install or Properly Maintain BMP	0.1 - 0.5	0.2 - 1.0	0.5 - 2.5	1.0 - 5
Careless Destruction of BMP	0.2 - 1	0.5 - 2.5	1.0 - 5.	1.0 - 5
Intrusion into Protected Resource	1.0 - 5	1.0 - 5	2.0 - 10	2.0 - 10
Failure to properly manage Chemicals, Concrete Washouts or Residuals, Litter or other Wastes	0.2 - 1	0.2 - 1	0.5 - 2.5	1.0 - 5
Improper Vehicle and Equipment Maintenance, Fueling or Cleaning	0.1 - 0.5	0.2 - 1	0.2 - 1	0.5 - 2.5
Failure to Provide or Update Written or Graphic Plans Required by SWPPP	0.2 - 1	0.5 - 2.5	1.0 - 5	1.0 - 5
Failure to comply with Other Provisions of the NPDES Permit	0.1 - 0.5	0.2 - 1	0.2 - 1	0.5 - 2.5"

**PAYMENTS TO SUBCONTRACTORS (BDE)**

Effective: June 1, 2000

Revised: January 1, 2006

Federal regulations found at 49 CFR §26.29 mandate the Department to establish a contract clause to require Contractors to pay subcontractors for satisfactory performance of their subcontracts and to set the time for such payments.

State law also addresses the timing of payments to be made to subcontractors and material suppliers. Section 7 of the Prompt Payment Act, 30 ILCS 540/7, requires that when a Contractor receives any payment from the Department, the Contractor shall make corresponding, proportional payments to each subcontractor and material supplier performing work or supplying material within 15 calendar days after receipt of the Department payment. Section 7 of the Act further provides that interest in the amount of two percent per month, in addition to the payment due, shall be paid to any subcontractor or material supplier by the Contractor if the payment required by the Act is withheld or delayed without reasonable cause. The Act also provides that the time for payment required and the calculation of any interest due applies to transactions between subcontractors and lower-tier subcontractors and material suppliers throughout the contracting chain.

This Special Provision establishes the required federal contract clause, and adopts the 15 calendar day requirement of the State Prompt Payment Act for purposes of compliance with the federal regulation regarding payments to subcontractors. This contract is subject to the following payment obligations.

When progress payments are made to the Contractor according to Article 109.07 of the Standard Specifications, the Contractor shall make a corresponding payment to each subcontractor and material supplier in proportion to the work satisfactorily completed by each subcontractor and for the material supplied to perform any work of the contract. The proportionate amount of partial payment due to each subcontractor and material supplier throughout the contracting chain shall be determined by the quantities measured or otherwise determined as eligible for payment by the Department and included in the progress payment to the Contractor.

Subcontractors and material suppliers shall be paid by the Contractor within 15 calendar days after the receipt of payment from the Department. The Contractor shall not hold retainage from the subcontractors. These obligations shall also apply to any payments made by subcontractors and material suppliers to their subcontractors and material suppliers; and to all payments made to lower tier subcontractors and material suppliers throughout the contracting chain. Any payment or portion of a payment subject to this provision may only be withheld from the subcontractor or material supplier to whom it is due for reasonable cause.

This Special Provision does not create any rights in favor of any subcontractor or material supplier against the State or authorize any cause of action against the State on account of any payment, nonpayment, delayed payment, or interest claimed by application of the State Prompt Payment Act. The Department will not approve any delay or postponement of the 15 day requirement except for reasonable cause shown after notice and hearing pursuant to Section 7(b) of the State Prompt Payment Act. State law creates other and additional remedies available to any subcontractor or material supplier, regardless of tier, who has not been paid for work properly performed or material furnished. These remedies are a lien against public funds set forth in Section 23(c) of the Mechanics Lien Act, 770 ILCS 60/23(c), and a recovery on the Contractor's payment bond according to the Public Construction Bond Act, 30 ILCS 550.

#### **POST MOUNTING OF SIGNS (BDE)**

Effective: January 1, 2011

Revise the second paragraph of Article 701.14 of the Standard Specifications to read:

“Post mounted signs shall be a breakaway design. The sign shall be within five degrees of vertical. Two posts shall be used for signs greater than 16 sq ft (1.5 sq m) in area or where the height between the sign and the ground exceeds 7 ft (2.1 m).”

#### **PUBLIC CONVENIENCE AND SAFETY (BDE)**

Effective: January 1, 2000

Add the following paragraph after the fourth paragraph of Article 107.09 of the Standard Specifications.

“On weekends, excluding holidays, roadways with Average Daily Traffic of 25,000 or greater, all lanes shall be open to traffic from 3:00 P.M. Friday to midnight Sunday except where structure construction or major rehabilitation makes it impractical.”

#### **SEEDING (BDE)**

Effective: July 1, 2004

Revised: July 1, 2010

Revise the following seeding mixtures shown in Table 1 of Article 250.07 of the Standard Specifications to read:

"Table 1 - SEEDING MIXTURES		
Class – Type	Seeds	lb/acre (kg/hectare)
1A Salt Tolerant Lawn Mixture 7/	Bluegrass	60 (70)
	Perennial Ryegrass	20 (20)
	Red Fescue (Audubon, Sea Link, or Epic)	20 (20)
	Hard Fescue (Rescue 911, Spartan II, or Reliant IV)	20 (20)
	Fults Salt Grass 1/ or Salty Alkaligrass	60 (70)
2 Roadside Mixture 7/	Tall Fescue (Inferno, Tarheel II, Quest, Blade Runner, or Falcon IV)	100 (110)
	Perennial Ryegrass	50 (55)
	Creeping Red Fescue	40 (50)
	Red Top	10 (10)
2A Salt Tolerant Roadside Mixture 7/	Tall Fescue (Inferno, Tarheel II, Quest, Blade Runner, or Falcon IV)	60 (70)
	Perennial Ryegrass	20 (20)
	Red Fescue (Audubon, Sea Link, or Epic)	30 (20)
	Hard Fescue (Rescue 911, Spartan II, or Reliant IV)	30 (20)
	Fults Salt Grass 1/ or Salty Alkaligrass	60 (70)
3 Northern Illinois Slope Mixture 7/	Elymus Canadensis (Canada Wild Rye)	5 (5)
	Perennial Ryegrass	20 (20)
	Alsike Cover 2/	5 (5)
	Desmanthus Illinoensis (Illinois Bundleflower) 2/, 5/	2 (2)
	Andropogon Scoparius (Little Bluestem) 5/	12 (12)
	Bouteloua Curtipendula (Side-Oats Grama)	10 (10)
	Fults Salt Grass 1/ or Salty Alkaligrass	30 (35)
	Oats, Spring	50 (55)
	Slender Wheat Grass 5/	15 (15)
	Buffalo Grass (Cody or Bowie) 4/, 5/, 9/	5 (5)
6A Salt Tolerant Conservation Mixture	Andropogon Scoparius (Little Bluestem) 5/	5 (5)
	Elymus Canadensis (Canada Wild Rye) 5/	2 (2)
	Buffalo Grass (Cody or Bowie) 4/, 5/, 9/	5 (5)
	Vernal Alfalfa 2/	15 (15)
	Oats, Spring	48 (55)
	Fults Salt Grass 1/ or Salty Alkaligrass	20 (20)"

Revise Note 7 of Table 1 – Seeding Mixtures of Article 250.07 of the Standard Specifications to read:

“7/ In Districts 1 through 6, the planting times shall be April 1 to June 15 and August 1 to November 1. In Districts 7 through 9, the planting times shall be March 1 to June 1 and August 1 to November 15.

Seeding may be performed outside these dates provided the Contractor guarantees a minimum of 75 percent uniform growth over the entire seeded area(s) after a period of establishment. Inspection dates for the period of establishment will be as follows: Seeding conducted in Districts 1 through 6 between June 16 and July 31 will be inspected after April 15 and seeding conducted between November 2 and March 31 will be inspected after September 15. Seeding conducted in Districts 7 through 9 between June 2 and July 31 will be inspected after April 15 and seeding conducted between November 16 and February 28 will be inspected after September 15. The guarantee shall be submitted to the Engineer in writing prior to performing the work. After the period of establishment, areas not exhibiting 75 percent uniform growth shall be interseeded or reseeded, as determined by the Engineer, at no additional cost to the Department.”

Revise the first paragraph of Article 1081.04(a) of the Standard Specifications to read:

“(a) Sampling and Testing. Each lot of seed furnished shall be tested by a State Agriculture Department (including other States) or by land grant college or university agricultural sections or by a Registered Seed Technologist. Germination testing of seed shall be accomplished within the 12 months prior to the seed being installed on the project.”

Delete the last sentence of the first paragraph of Article 1081.04(c)(2) of the Standard Specifications.

Revise Table II of Article 1081.04(c)(6) of the Standard Specifications to read:

TABLE II						
Variety of Seeds	Hard Seed	Purity	Pure Live Seed %	Weed %	Secondary * Noxious Weeds No. per oz (kg)	Notes
	% Max.	% Min.	Min.	% Max.	Max. Permitted	
Alfalfa	20	92	89	0.50	6 (211)	1/
Clover, Alsike	15	92	87	0.30	6 (211)	2/
Red Fescue, Audubon	0	97	82	0.10	3 (105)	-
Red Fescue, Creeping	-	97	82	1.00	6 (211)	-
Red Fescue, Epic	-	98	83	0.05	1 (35)	-
Red Fescue, Sea Link	-	98	83	0.10	3 (105)	-
Tall Fescue, Blade Runner	-	98	83	0.10	2 (70)	-
Tall Fescue, Falcon IV	-	98	83	0.05	1 (35)	-
Tall Fescue, Inferno	0	98	83	0.10	2 (70)	-
Tall Fescue, Tarheel II	-	97	82	1.00	6 (211)	-
Tall Fescue, Quest	0	98	83	0.10	2 (70)	-
Fults Salt Grass	0	98	85	0.10	2 (70)	-
Salty Alkaligrass	0	98	85	0.10	2 (70)	-
Kentucky Bluegrass	-	97	80	0.30	7 (247)	4/
Oats	-	92	88	0.50	2 (70)	3/
Redtop	-	90	78	1.80	5 (175)	3/
Ryegrass, Perennial, Annual	-	97	85	0.30	5 (175)	3/
Rye, Grain, Winter	-	92	83	0.50	2 (70)	3/
Hard Fescue, Reliant IV	-	98	83	0.05	1 (35)	-
Hard Fescue, Rescue 911	0	97	82	0.10	3 (105)	-
Hard Fescue, Spartan II	-	98	83	0.10	3 (105)	-
Timothy	-	92	84	0.50	5 (175)	3/
Wheat, hard Red Winter	-	92	89	0.50	2 (70)	3/”



Revise the first sentence of the first paragraph of Article 1081.04(c)(7) of the Standard Specifications to read:

“The seed quantities indicated per acre (hectare) for Prairie Grass Seed in Classes 3, 3A, 4, 4A, 6, and 6A in Article 250.07 shall be the amounts of pure, live seed per acre (hectare) for each species listed.”

### **SELECTION OF LABOR (BDE)**

Effective: July 2, 2010

Revise Section I of Check Sheet #5 of the Recurring Special Provisions to read:

#### **“I. SELECTION OF LABOR**

The Contractor shall comply with all Illinois statutes pertaining to the selection of labor.

#### **EMPLOYMENT OF ILLINOIS WORKERS DURING PERIODS OF EXCESSIVE UNEMPLOYMENT**

Whenever there is a period of excessive unemployment in Illinois, which is defined herein as any month immediately following two consecutive calendar months during which the level of unemployment in the State of Illinois has exceeded five percent as measured by the United States Bureau of Labor Statistics in its monthly publication of employment and unemployment figures, the Contractor shall employ at least 90 percent Illinois laborers. "Illinois laborer" means any person who has resided in Illinois for at least 30 days and intends to become or remain an Illinois resident.

Other laborers may be used when Illinois laborers as defined herein are not available, or are incapable of performing the particular type of work involved, if so certified by the Contractor and approved by the Engineer. The Contractor may place no more than three of his/her regularly employed non-resident executive and technical experts, who do not qualify as Illinois laborers, to do work encompassed by this contract during period of excessive unemployment.

This provision applies to all labor, whether skilled, semi-skilled, or unskilled, whether manual or non-manual.”

### **SUBCONTRACTOR MOBILIZATION PAYMENTS (BDE)**

Effective: April 2, 2005

Revised: April 1, 2011

To account for the preparatory work and operations necessary for the movement of subcontractor personnel, equipment, supplies, and incidentals to the project site and for all other work or operations that must be performed or costs incurred when beginning work approved for subcontracting according to Article 108.01 of the Standard Specifications, the Contractor shall make a mobilization payment to each subcontractor.

This mobilization payment shall be made at least 14 days prior to the subcontractor starting work. The amount paid shall be equal to 3 percent of the amount of the subcontract reported on form BC 260A submitted for the approval of the subcontractor's work.

The mobilization payment to the subcontractor is an advance payment of the reported amount of the subcontract and is not a payment in addition to the amount of the subcontract; therefore, the amount of the advance payment will be deducted from future progress payments.

This provision shall be incorporated directly or by reference into each subcontract approved by the Department.

**TRAFFIC BARRIER TERMINAL, TYPE 6 (BDE)**

Effective: January 1, 2010

Delete the fourth paragraph of Article 631.07 of the Standard Specifications.

**UTILITY COORDINATION AND CONFLICTS (BDE)**

Effective: April 1, 2011

Revise Article 105.07 of the Standard Specifications to read:

**“105.07 Cooperation with Utilities.** The Department reserves the right at any time to allow work by utilities on or near the work covered by the contract. The Contractor shall conduct his/her work so as not to interfere with or hinder the progress or completion of the work being performed by utilities. The Contractor shall also arrange the work and shall place and dispose of the materials being used so as not to interfere with the operations of utility work in the area.

The Contractor shall cooperate with the owners of utilities in their removal and rearrangement operations so work may progress in a reasonable manner, duplication or rearrangement of work may be reduced to a minimum, and services rendered by those parties will not be unnecessarily interrupted.

The Contractor shall coordinate with any planned utility adjustment or new installation and the Contractor shall take all precautions to prevent disturbance or damage to utility facilities. Any failure on the part of the utility owner, or their representative, to proceed with any planned utility adjustment or new installation shall be reported promptly by the Contractor to the Engineer.”

Revise the first sentence of the last paragraph of Article 107.19 of the Standard Specifications to read:

“When the Contractor encounters unexpected regulated substances due to the presence of utilities in unanticipated locations, the provisions of Article 107.40 shall apply; otherwise, if the Engineer does not direct a resumption of operations, the provisions of Article 108.07 shall apply.”

Revise Article 107.31 of the Standard Specification to read:

**“107.31 Reserved.”**

Add the following four Articles to Section 107 of the Standard Specifications:

**“107.37 Locations of Utilities within the Project Limits.** All known utilities existing within the limits of construction are either indicated on the plans or visible above ground. For the purpose of this Article, the limits of proposed construction are defined as follows:

(a) Limits of Proposed Construction for Utilities Paralleling the Roadway.

- (1) The horizontal limits shall be a vertical plane, outside of, parallel to, and 2 ft (600 mm) distant at right angles from the plan or revised slope limits.

In cases where the limits of excavation for structures are not shown on the plans, the horizontal limits shall be a vertical plane 4 ft (1.2 m) outside the edges of structure footings or the structure where no footings are required.

- (2) The upper vertical limits shall be the regulations governing the roadbed clearance for the specific utility involved.
- (3) The lower vertical limits shall be either the top of the utility at the depth below the proposed grade as prescribed by the governing agency or the limits of excavation, whichever is less.

(b) Limits of Proposed Construction for Utilities Crossing the Roadway in a Generally Transverse Direction.

- (1) Utilities crossing excavations for structures that are normally made by trenching such as sewers, underdrains, etc. and all minor structures such as manholes, inlets, foundations for signs, foundations for traffic signals, etc., the limits shall be the space to be occupied by the proposed permanent construction, unless otherwise required by the regulations governing the specific utility involved.
- (2) For utilities crossing the proposed site of major structures such as bridges, sign trusses, etc., the limits shall be as defined above for utilities extending in the same general direction as the roadway.

It is understood and agreed that the Contractor has considered in the bid all of the permanent and temporary utilities in their present and/or adjusted positions as indicated in the contract. It is further understood the actual location of the utilities may be located anywhere within the tolerances provided in 220 ILCS 50/2.8 or Administrative Code Title 92 Part 530.40(c), and the proximity of some utilities to construction may require extraordinary measures by the Contractor to protect those utilities.

No additional compensation will be allowed for any delays, inconveniences, or damages sustained by the Contractor due to the presence of or any claimed interference from known utility facilities or any adjustment of them, except as specifically provided in the contract.

**107.38 Adjustments of Utilities within the Project Limits.** The adjustment of utilities consists of the relocation, removal, replacement, rearrangements, reconstruction, improvement, disconnection, connection, shifting, new installation, or altering of an existing utility facility in any manner.

Utilities which are to be adjusted shall be adjusted by the utility owner or the owner's representative or by the Contractor as a contract item.

Generally, arrangements for adjusting known utilities will be made by the Department prior to project construction; however, utilities will not necessarily be adjusted in advance of project construction and, in some cases, utilities will not be removed from the proposed construction limits as described in Article 107.37. When utility adjustments must be performed in conjunction with construction, the utility adjustment work will be indicated in the contract.

The Contractor may make arrangements for adjustment of utilities indicated in the contract, but not scheduled by the Department for adjustment, provided the Contractor furnishes the Department with a signed agreement with the utility owner covering the adjustments to be made. The cost of any such adjustments shall be the responsibility of the Contractor.

**107.39 Contractor’s Responsibility for Locating and Protecting Utility Property and Services.** At points where the Contractor’s operations are adjacent to properties or facilities of utility companies, or are adjacent to other property, damage to which might result in considerable expense, loss, or inconvenience, work shall not be commenced until all arrangements necessary for the protection thereof have been made.

Within the State of Illinois, a State-Wide One Call Notice System has been established for notifying utilities. Outside the city limits of the City of Chicago, the system is known as the Joint Utility Locating Information for Excavators (JULIE) System. Within the city limits of the City of Chicago the system is known as DIGGER. All utility companies and municipalities which have buried utility facilities in the State of Illinois are a part of this system.

The Contractor shall call JULIE (800-892-0123) or DIGGER (312-744-7000), a minimum of 48 hours in advance of work being done in the area, and they will notify all member utility companies involved their respective utility should be located.

For utilities which are not members of JULIE or DIGGER, the Contractor shall contact the owners directly. The plan general notes will indicate which utilities are not members of JULIE or DIGGER.

The following table indicates the color of markings required of the State-Wide One Call Notification System.

Utility Service	Color
Electric Power, Distribution and Transmission	Safety Red
Municipal Electric Systems	Safety Red
Gas Distribution and Transmission	High Visibility Safety Yellow
Oil Distribution and Transmission	High Visibility Safety Yellow
Telephone and Telegraph System	Safety Alert Orange
Community Antenna Television Systems	Safety Alert Orange
Water Systems	Safety Precaution Blue
Sewer Systems	Safety Green
Non-Potable Water and Slurry Lines	Safety Purple
Temporary Survey	Safety Pink
Proposed Excavation	Safety White (Black when snow is on the ground)

The State-Wide One Call Notification System will provide for horizontal locations of utilities.

When it is determined that the vertical location of the utility is necessary to facilitate construction, the Engineer may make the request for location from the utility after receipt of notice from the Contractor. If the utility owner does not field locate their facilities to the satisfaction of the Engineer, the Engineer will authorize the Contractor in writing to proceed to locate the facilities in the most economical and reasonable manner, subject to the approval of the Engineer, and be paid according to Article 109.04.

The Contractor shall be responsible for maintaining the excavations or markers provided by the utility owners.

The Contractor shall take all necessary precautions for the protection of the utility facilities. The Contractor shall be responsible for any damage or destruction of utility facilities resulting from neglect, misconduct, or omission in the Contractor's manner or method of execution or nonexecution of the work, or caused by defective work or the use of unsatisfactory materials. Whenever any damage or destruction of a utility facility occurs as a result of work performed by the Contractor, the utility company will be immediately notified. The utility company will make arrangements to restore such facility to a condition equal to that existing before any such damage or destruction was done.

In the event of interruption of utility services as a result of accidental breakage or as a result of being exposed or unsupported, the Contractor shall promptly notify the proper authority and shall cooperate with the said authority in the restoration of service. If water service is interrupted, repair work shall be continuous until the service is restored. No work shall be undertaken around fire hydrants until provisions for continued service have been approved by the local fire authority.

**107.40 Conflicts with Utilities.** Except as provided hereinafter, the discovery of a utility in an unanticipated location will be evaluated according to Article 104.03. It is understood and agreed that the Contractor has considered in the bid all facilities not meeting the definition of a utility in an unanticipated location and no additional compensation will be allowed for any delays, inconveniences, or damages sustained by the Contractor due to the presence of or any claimed interference from such facilities.

When the Contractor discovers a utility in an unanticipated location, the Contractor shall not interfere with said utility, shall take proper precautions to prevent damage or interruption of the utility, and shall promptly notify the Engineer of the nature and location of said utility.

- (a) Definition. A utility in an unanticipated location is defined as an active or inactive utility, which is either:
  - (1) Located underground and (a) not shown in any way in any location on the contract documents; (b) not identified in writing by the Department to the Contractor prior to the letting; or (c) not located relative to the location shown in the contract within the tolerances provided in 220 ILCS 50/2.8 or Administrative Code Title 92 Part 530.40(c); or
  - (2) Located above ground or underground and not relocated as provided in the contract.

Service connections shall not be considered to be utilities in unanticipated locations.

(b) Compensation. Compensation will not be allowed for delays, inconveniences, or damages sustained by the Contractor from conflicts with facilities not meeting the above definition; or if a conflict with a utility in an unanticipated location does not cause a shutdown of the work applicable to the utility or a documentable reduction in the rate of progress exceeding the limits set herein. The provisions of Article 104.03 notwithstanding, compensation for delays caused by a utility in an unanticipated location will be paid according to the provisions of this Article governing minor and major delays or reduced rate of production which are defined as follows:

- (1) Minor Delay. A minor delay occurs when the Contractor's operation is completely stopped by a utility in an unanticipated location for more than two hours, but not to exceed three weeks.
- (2) Major Delay. A major delay occurs when the Contractor's operation is completely stopped by a utility in an unanticipated location for more than three weeks.
- (3) Reduced Rate of Production Delay. A reduced rate of production delay occurs when the contractor's rate of production decreases by more than 25 percent and lasts longer than seven days.

(c) Payment. Payment for Minor, Major and Reduced Rate of Production Delays will be made as follows.

- (1) Minor Delay. Labor idled which cannot be used on other work will be paid for according to Article 109.04(b)(1) and (2) for the time between start of the delay and the minimum remaining hours in the work shift required by the prevailing practice in the area.

Equipment idled which cannot be used on other work will be paid for according to Article 109.04(b)(4). The length of time paid for will be the time between start of delay and eight hours working time from start of shift being worked.

For delays exceeding the initial shift, excluding Saturdays, Sundays, and holidays, Contractor-owned equipment idled by the delay which cannot be used on other work and remaining at the work site, will be paid at one-half the rate permitted in Article 109.04(b)(4) using a maximum eight hours per day for computation purposes. Equipment rented from an independent source will be paid at rates being paid by the Contractor plus move-in move-out costs, but the total amount paid will not exceed three weeks rental.

- (2) Major Delay. Labor will be the same as for a minor delay.

Equipment will be the same as for a minor delay, except Contractor-owned equipment will be limited to three weeks plus the cost of move-out to either the Contractor's yard or another job, whichever is less. Rental equipment may be paid for longer than three weeks provided the Contractor presents adequate support to the Department (including lease agreement) to show retaining equipment on the job is the most economical course to follow and in the public interest.

- (3) Reduced Rate of Production Delay. The Contractor will be compensated for the reduced productivity for labor and equipment time in excess of the 25 percent threshold for that portion of the delay in excess of seven days. Determination of compensation will be in accordance with Article 104.02, except labor and material additives will not be permitted.

Whether covered by (1), (2) or (3) above, additional traffic control required as a result of the operation(s) delayed will be paid for according to Article 109.04 for the total length of the delay.

If the delay is clearly shown to have caused work, which would have otherwise been completed, to be done after material or labor costs have increased, such increases may be paid. Payment for materials will be limited to increased cost substantiated by documentation furnished by the Contractor. Payment for increased labor rates will include those items in Article 109.04(b)(1) and (2), except the 35 percent and ten percent additives will not be permitted. On a working day contract, a delay occurring between November 30 and May 1, when work has not started, will not be considered as eligible for payment of measured labor and material costs.

Project overhead (not including interest) will be allowed when all progress on the contract has been delayed, and will be calculated as 15 percent of the delay claim.

- (d) Other Obligations of Contractor. Upon payment of a claim under this provision, the Contractor shall assign subrogation rights to the Department for the Department's efforts of recovery from any other party for monies paid by the Department as a result of any claim under this Provision. The Contractor shall fully cooperate with the Department in its efforts to recover from another party any money paid to the Contractor for delay damages under this Provision."

#### **STEEL COST ADJUSTMENT (BDE) (RETURN FORM WITH BID)**

Effective: April 2, 2004

Revised: April 1, 2009

Description. Steel cost adjustments will be made to provide additional compensation to the Contractor, or a credit to the Department, for fluctuations in steel prices when optioned by the Contractor. The bidder shall indicate on the attached form whether or not this special provision will be part of the contract and submit the completed form with his/her bid. Failure to submit the form or failure to indicate contract number, company name, and sign and date the form shall make this contract exempt of steel cost adjustments for all items of steel. Failure to indicate "Yes" for any item of work will make that item of steel exempt from steel cost adjustment.

Types of Steel Products. An adjustment will be made for fluctuations in the cost of steel used in the manufacture of the following items:

- Metal Piling (excluding temporary sheet piling)
- Structural Steel
- Reinforcing Steel

Other steel materials such as dowel bars, tie bars, mesh reinforcement, guardrail, steel traffic signal and light poles, towers and mast arms, metal railings (excluding wire fence), and frames and grates will be subject to a steel cost adjustment when the pay items they are used in has a contract value of \$10,000 or greater.

Documentation. Sufficient documentation shall be furnished to the Engineer to verify the following:

- (a) The dates and quantity of steel, in lb (kg), shipped from the mill to the fabricator.
- (b) The quantity of steel, in lb (kg), incorporated into the various items of work covered by this special provision. The Department reserves the right to verify submitted quantities.

Method of Adjustment. Steel cost adjustments will be computed as follows:

$$SCA = Q \times D$$

Where: SCA = steel cost adjustment, in dollars  
Q = quantity of steel incorporated into the work, in lb (kg)  
D = price factor, in dollars per lb (kg)

$$D = MPI_M - MPI_L$$

Where:  $MPI_M$  = The Materials Cost Index for steel as published by the Engineering News-Record for the month the steel is shipped from the mill. The indices will be converted from dollars per 100 lb to dollars per lb (kg).

$MPI_L$  = The Materials Cost Index for steel as published by the Engineering News-Record for the month prior to the letting. The indices will be converted from dollars per 100 lb to dollars per lb (kg).

The unit weights (masses) of steel that will be used to calculate the steel cost adjustment for the various items are shown in the attached table.

No steel cost adjustment will be made for any products manufactured from steel having a mill shipping date prior to the letting date.

If the Contractor fails to provide the required documentation, the method of adjustment will be calculated as described above; however, the  $MPI_M$  will be based on the date the steel arrives at the job site. In this case, an adjustment will only be made when there is a decrease in steel costs.

Basis of Payment. Steel cost adjustments may be positive or negative but will only be made when there is a difference between the  $MPI_L$  and  $MPI_M$  in excess of five percent, as calculated by:

$$\text{Percent Difference} = \{(MPI_L - MPI_M) \div MPI_L\} \times 100$$

Steel cost adjustments will be calculated by the Engineer and will be paid or deducted when all other contract requirements for the items of work are satisfied. Adjustments will only be made for fluctuations in the cost of the steel as described herein. No adjustment will be made for changes in the cost of manufacturing, fabrication, shipping, storage, etc.

The adjustments shall not apply during contract time subject to liquidated damages for completion of the entire contract.



**Attachment**

Item	Unit Mass (Weight)
Metal Piling (excluding temporary sheet piling)	
Furnishing Metal Pile Shells 12 in. (305 mm), 0.179 in. (3.80 mm) wall thickness)	23 lb/ft (34 kg/m)
Furnishing Metal Pile Shells 12 in. (305 mm), 0.250 in. (6.35 mm) wall thickness)	32 lb/ft (48 kg/m)
Furnishing Metal Pile Shells 14 in. (356 mm), 0.250 in. (6.35 mm) wall thickness)	37 lb/ft (55 kg/m)
Other piling	See plans
Structural Steel	See plans for weights (masses)
Reinforcing Steel	See plans for weights (masses)
Dowel Bars and Tie Bars	6 lb (3 kg) each
Mesh Reinforcement	63 lb/100 sq ft (310 kg/sq m)
Guardrail	
Steel Plate Beam Guardrail, Type A w/steel posts	20 lb/ft (30 kg/m)
Steel Plate Beam Guardrail, Type B w/steel posts	30 lb/ft (45 kg/m)
Steel Plate Beam Guardrail, Types A and B w/wood posts	8 lb/ft (12 kg/m)
Steel Plate Beam Guardrail, Type 2	305 lb (140 kg) each
Steel Plate Beam Guardrail, Type 6	1260 lb (570 kg) each
Traffic Barrier Terminal, Type 1 Special (Tangent)	730 lb (330 kg) each
Traffic Barrier Terminal, Type 1 Special (Flared)	410 lb (185 kg) each
Steel Traffic Signal and Light Poles, Towers and Mast Arms	
Traffic Signal Post	11 lb/ft (16 kg/m)
Light Pole, Tenon Mount and Twin Mount, 30 - 40 ft (9 - 12 m)	14 lb/ft (21 kg/m)
Light Pole, Tenon Mount and Twin Mount, 45 - 55 ft (13.5 - 16.5 m)	21 lb/ft (31 kg/m)
Light Pole w/Mast Arm, 30 - 50 ft (9 - 15.2 m)	13 lb/ft (19 kg/m)
Light Pole w/Mast Arm, 55 - 60 ft (16.5 - 18 m)	19 lb/ft (28 kg/m)
Light Tower w/Luminaire Mount, 80 - 110 ft (24 - 33.5 m)	31 lb/ft (46 kg/m)
Light Tower w/Luminaire Mount, 120 - 140 ft (36.5 - 42.5 m)	65 lb/ft (97 kg/m)
Light Tower w/Luminaire Mount, 150 - 160 ft (45.5 - 48.5 m)	80 lb/ft (119 kg/m)
Metal Railings (excluding wire fence)	
Steel Railing, Type SM	64 lb/ft (95 kg/m)
Steel Railing, Type S-1	39 lb/ft (58 kg/m)
Steel Railing, Type T-1	53 lb/ft (79 kg/m)
Steel Bridge Rail	52 lb/ft (77 kg/m)
Frames and Grates	
Frame	250 lb (115 kg)
Lids and Grates	150 lb (70 kg)

## RETURN WITH BID

### ILLINOIS DEPARTMENT OF TRANSPORTATION

### OPTION FOR STEEL COST ADJUSTMENT

The bidder shall submit this completed form with his/her bid. Failure to submit the form or properly complete contract number, company name, and sign and date the form shall make this contract exempt of steel cost adjustments for all items of steel. Failure to indicate "Yes" for any item of work will make that item of steel exempt from steel cost adjustment. After award, this form, when submitted shall become part of the contract.

**Contract No.:** \_\_\_\_\_

**Company Name:** \_\_\_\_\_

#### **Contractor's Option:**

Is your company opting to include this special provision as part of the contract plans for the following items of work?

Metal Piling	Yes	<input type="checkbox"/>
Structural Steel	Yes	<input type="checkbox"/>
Reinforcing Steel	Yes	<input type="checkbox"/>
Dowel Bars, Tie Bars and Mesh Reinforcement	Yes	<input type="checkbox"/>
Guardrail	Yes	<input type="checkbox"/>
Steel Traffic Signal and Light Poles, Towers and Mast Arms	Yes	<input type="checkbox"/>
Metal Railings (excluding wire fence)	Yes	<input type="checkbox"/>
Frames and Grates	Yes	<input type="checkbox"/>

**Signature:** \_\_\_\_\_ **Date:** \_\_\_\_\_

STATE OF ILLINOIS  
 DEPARTMENT OF TRANSPORTATION  
 DIVISION OF HIGHWAYS  
**PLANS FOR PROPOSED  
 HIGHWAY**  
 D9 GUARDRAIL REPAIR FY12-1  
 VARIOUS COUNTIES  
 C-99-026-11

D-99-016-11

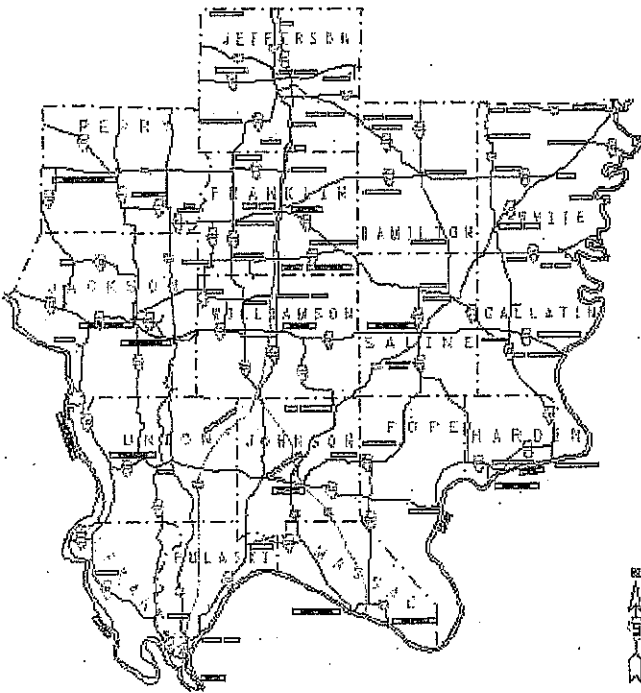

FOR SIGNATURE SHEET, SEE SHEET NO. 2  
 FOR INDEX OF SHEETS/ STANDARDS, SEE SHEET NO. 3  
 FOR GENERAL NOTES, SEE SHEET NO. 4  
 FOR SUMMARY OF QUANTITIES, SEE SHEET NO. 5 AND 6

PROJECT ENGINEER: SUSAN FOE

SUBMITTED	3/17/11 <i>M. Chami</i>
	DEPUTY DIRECTOR OF HIGHWAYS, REGION ENGINEER
PASSED	
	ENGINEER OF DESIGN & ENVIRONMENT
APPROVED	
	DIRECTOR, DIVISION OF HIGHWAYS

CONTRACT NO. 78239  
 JULIE 1-800-892-0123

### SIGNATURE SHEET

PREPARED BY: *Joe Wlaniewicz*  
DISTRICT STUDIES & PLANS ENGINEER

EXAMINED BY: *James Louis Emery*  
DISTRICT LAND ACQUISITION ENGINEER

EXAMINED BY: *Carrie Nelson*  
DISTRICT PROGRAM DEVELOPMENT ENGINEER

EXAMINED BY: *Keth Hely*  
DISTRICT OPERATIONS ENGINEER

EXAMINED BY: *KRS*  
DISTRICT CONSTRUCTION ENGINEER

EXAMINED BY: *Bruce W. Pugh*  
DISTRICT MATERIALS ENGINEER

## INDEX OF SHEETS

<u>SHEET NO.</u>	<u>DESCRIPTION</u>
1	COVER SHEET
2	SIGNATURE SHEET
3	INDEX OF SHEETS, STANDARDS
4	GENERAL NOTES
5 - 6	SUMMARY OF QUANTITIES
7	DETAIL - TRAFFIC BARRIER TERMINAL TYPE 5 AND 5A
8 - 11	DETAIL - STEEL PLATE BEAM GUARDRAIL

## STANDARDS

630001-09	STEEL PLATE BEAM GUARDRAIL
630101-09	GUARDRAIL MOUNTED ON EXISTING CULVERTS
630301-05	SHOULDER WIDENING FOR TYPE 1 (SPECIAL) GUARDRAIL TERMINALS
631011-07	TRAFFIC BARRIER TERMINAL, TYPE 2
631026-05	TRAFFIC BARRIER TERMINAL, TYPE 5
631031-09	TRAFFIC BARRIER TERMINAL, TYPE 6
631032-06	TRAFFIC BARRIER TERMINAL, TYPE 6A
631033-04	TRAFFIC BARRIER TERMINAL, TYPE 6B
635001-01	DELINEATORS
635006-03	REFLECTOR AND TERMINAL MARKER TREATMENT
635011-02	REFLECTOR MARKER AND MOUNTING DETAILS
664001-02	CHAIN LINK FENCE
665001-02	WOVEN WIRE FENCE
701001-02	OFF ROAD OPERATIONS, 2L, 2W, MORE THAN 15' AWAY
701006-03	OFF ROAD OPERATIONS, 2L, 2W, 15' TO 24" FROM PAVEMENT EDGE
701011-02	OFF ROAD OPERATIONS, 2L, 2W, DAY ONLY
701101-02	OFF ROAD OPERATIONS, MULTILANE, 15' TO 24" FROM PAVEMENT EDGE
701106-02	OFF ROAD OPERATIONS, MULTILANE, MORE THAN 15' AWAY
701201-04	LANE CLOSURE, 2L, 2W, DAY ONLY FOR SPEEDS GREATER OR EQUAL TO 45 MPH
701301-04	LANE CLOSURE, 2L, 2W, SHORT TERM OPERATIONS
701400-05	APPROACH TO LANE CLOSURE, FREEWAY/EXPRESSWAY
701406-06	LANE CLOSURE, FREEWAY/EXPRESSWAY, DAY OPERATIONS ONLY
701421-03	LANE CLOSURE, MULTILANE, DAY OPERATIONS ONLY FOR SPEEDS GREATER OR EQUAL TO 45 MPH
701701-07	URBAN LANE CLOSURE, MULTILANE INTERSECTION
701901-01	TRAFFIC CONTROL DEVICES
000001-06	STANDARD SYMBOLS, ABBREVIATIONS AND PATTERNS
001006	DECIMAL OF AN INCH AND A FOOT

## GENERAL NOTES

BEFORE ORDERING THE IMPACT ATTENUATORS, THE CONTRACTOR MUST CONTACT THE OPERATIONS ENGINEER AT (618)351-5240 TO RECEIVE APPROVAL OF THE PROPOSED INSTALLATION.

ALL WORK IS TO BE REPLACED IN KIND OR AS INDICATED ON THE CONTRACT PLANS AND PROVISIONS.

THE LOCATIONS OF THE REPAIR AREAS SHALL BE DETERMINED BY THE ENGINEER.

GUARDRAIL WORK WILL INCLUDE ALIGNMENT AS NECESSARY TO RESTORE THE RAIL TO THE ORIGINAL CONDITIONS.

REMOVAL OF DAMAGED MATERIALS WILL INCLUDE DISMANTLING, LOADING, HAULING AND DISPOSAL. THE WORK SITE WILL BE LEFT IN A SAFE AND ORDERLY CONDITION.

THE LIMITS OF THE DAMAGED GUARDRAIL WILL BE MARKED WITH PAINT. THE REPLACEMENT PARTS AND THE QUANTITIES INDICATED ARE WITHIN THESE LIMITS AS MARKED.

REMOVED GUARDRAIL THAT IS NOT REPLACED ON THE SAME DAY MUST BE DELINEATED WITH LIGHTED BARRICADES. NO LOCATIONS WILL BE LEFT WITHOUT EITHER LIGHTED BARRICADES OR RESTORED GUARDRAIL AT ANY TIME.

GUARDRAIL MARKERS SHALL BE ATTACHED TO TERMINAL SECTIONS. ALL OTHER MARKERS SHALL BE PLACED AT THE DISCRETION OF THE ENGINEER.

ILLINOIS STATE LAW REQUIRES A 48-HOUR NOTICE TO BE GIVEN TO UTILITIES BEFORE DIGGING. FIELD MARKING OF FACILITIES MAY BE OBTAINED BY CONTACTING J.U.L.I.E. (PHONE: 800 892-0123) OR FOR NON-MEMBER, THE UTILITY COMPANY DIRECTLY.

NO OVERNIGHT LANE CLOSURES WILL BE ALLOWED.

THE CONTRACTOR SHALL BE ADVISED THAT THE GUARDRAIL PAY ITEMS INCLUDED IN THE PLANS MAY BE USED TO REPLACE/REPAIR SPBGR AND TRAFFIC BARRIER TERMINALS FOR THE NEW MIDWEST STANDARD AS SHOWN ON THE HIGHWAY STANDARDS AS WELL AS SPBGR AND TRAFFIC BARRIER TERMINAL INSTALLED PRIOR TO JAN. 1, 2007 AS SHOWN IN THE PLAN DETAILS. NO ADDITIONAL COMPENSATION WILL BE ALLOWED FOR UTILIZING THE CURRENT MIDWEST STANDARDS.

# SUMMARY OF QUANTITIES

VARIOUS ROUTES  
 SECTION D9 GUARDRAIL REPAIR FY12-1  
 CONTRACT: 78239  
 VARIOUS COUNTIES  
 SHEET 5 OF 11

CODE NO.	ITEM	CONSTRUCTION TYPE CODE				
		UNIT	TOTAL QUANTITIES	100% STATE MCHD	100% STATE HIT AND RUN	100% STATE HIGH TENSION CABLE GUARD RAIL
X0325411	FURNISHING AND INSTALLING EXTRUDER HEAD	EACH	2	2		
X6310088	TRAFFIC BARRIER TERMINAL, TYPE 6A (SPECIAL)	EACH	3	2	1	
X6310176	TRAFFIC BARRIER TERMINAL, TYPE 2 (SPECIAL)	EACH	4	3	1	
X6310178	TRAFFIC BARRIER TERMINAL, TYPE 4 (SPECIAL)	EACH	4	3	1	
X6310218	TRAFFIC BARRIER TERMINAL, TYPE 6 (SPECIAL)	EACH	4	3	1	
X7010520	TRAFFIC CONTROL AND PROTECTION, STANDARD 701201 (SPECIAL)	L SUM	1	.9	.1	
X7010600	TRAFFIC CONTROL AND PROTECTION, STANDARD 701406 (SPECIAL)	L SUM	1	.6	.1	.5
X6311205	TRAFFIC BARRIER TERMINAL, TYPE 5A (SPECIAL)	EACH	4	3	1	
X6311217	TRAFFIC BARRIER TERMINAL, TYPE 6B (SPECIAL)	EACH	4	3	1	
X6640296	CHAIN LINK FENCE (SPECIAL)	FOOT	150	100	50	
X6650208	WOVEN WIRE FENCE REMOVAL AND REPLACEMENT	FOOT	75	50	25	
X8030110	LOCATING UNDERGROUND CABLE, SPECIAL	EACH	5	4	1	
Z0012754	STRUCTURAL REPAIR OF CONCRETE, (DEPTH EQUAL TO OR LESS THAN 5 INCHES)	SQ FT	102	72	30	
Z0025548	FURNISHING AND INSTALLING RADIUS RAIL ELEMENT PLATES	EACH	2	2		
Z0026692	FURNISHING AND SETTING CABLE RAIL GUARDPOSTS (HIGH TENSION)	EACH	75			75
Z0026700	FURNISHING AND SETTING STEEL POSTS	EACH	240	225	15	
Z0026800	FURNISHING AND SETTING STEEL POSTS (MODIFIED)	EACH	2	2		
Z0026900	FURNISHING AND SETTING STEEL POSTS (SPECIAL)	EACH	2	2		
Z0028654	HIGH TENSION CABLE MEDIAN BARRIER TERMINALS	EACH	5			5

# SUMMARY OF QUANTITIES

VARIOUS ROUTES  
 SECTION D9 GUARDRAIL REPAIR FY12-1  
 CONTRACT: 78239  
 VARIOUS COUNTIES  
 SHEET 6 OF 11

CODE NO.	ITEM	CONSTRUCTION TYPE CODE				
		UNIT	TOTAL QUANTITIES	100% STATE MCHD	100% STATE HIT AND RUN	100% STATE HIGH TENSION CABLE GUARD RAIL
Z0029556	REPAIR TRAFFIC BARRIER TERMINAL TYPE 3 SPECIAL	EACH	2	2		
Z0030050	IMPACT ATTENUATORS (FULLY REDIRECTIVE, WIDE), TEST LEVEL 3	EACH	3	3		
Z0050000	REMOVAL AND REINSTALLATION OF EXISTING IMPACT ATTENUATORS	EACH	40	40		
Z0052410	REPAIR TRAFFIC BARRIER TERMINAL, TYPE 1 SPECIAL (TANGENT)	EACH	6	5	1	
Z0052415	REPAIR TRAFFIC BARRIER TERMINAL, TYPE 1 SPECIAL (FLARED)	EACH	4	3	1	
Z0052500	REPAIR TRAFFIC BARRIER TERMINAL, TYPE 2	EACH	4	3	1	
Z0053000	REPAIR TRAFFIC BARRIER TERMINAL, TYPE 5	EACH	4	3	1	
Z0053100	REPAIR TRAFFIC BARRIER TERMINAL, TYPE 5A	EACH	4	3	1	
Z0053200	REPAIR TRAFFIC BARRIER TERMINAL, TYPE 6	EACH	4	3	1	
Z0053210	REPAIR TRAFFIC BARRIER TERMINAL, TYPE 6A	EACH	4	3	1	
Z0053220	REPAIR TRAFFIC BARRIER TERMINAL, TYPE 6B	EACH	3	3		
25000100	SEEDING, CLASS 1	ACRE	4	3	0.5	0.5
63000025	STEELPLATE BEAM GUARD RAIL, ATTACHED TO STRUCTURES	FOOT	10	5	5	
63001105	FURNISHING AND INSTALLING GUARD RAIL BLOCKS	EACH	240	225	15	
63001305	FURNISHING AND INSTALLING RAIL ELEMENT PLATES	EACH	235	225	10	
63100167	TRAFFIC BARRIER TERMINAL, TYPE 1, SPECIAL (TANGENT)	EACH	51	50	1	
63100169	TRAFFIC BARRIER TERMINAL, TYPE 1, SPECIAL (FLARED)	EACH	5	4	1	
67100100	MOBILIZATION	LUMP SUM	1	0.75	0.15	0.1
<b>70100310</b>	<b>TRAFFIC CONTROL AND PROTECTION, STANDARD 701421</b>	<b>L SUM</b>	<b>1</b>	<b>.8</b>	<b>.2</b>	
78201000	TERMINAL MARKERS - DIRECT APPLIED	EACH	51	50	1	



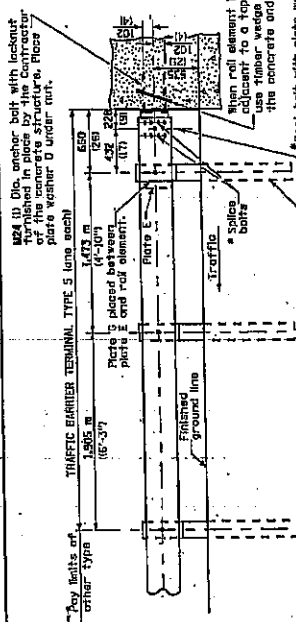
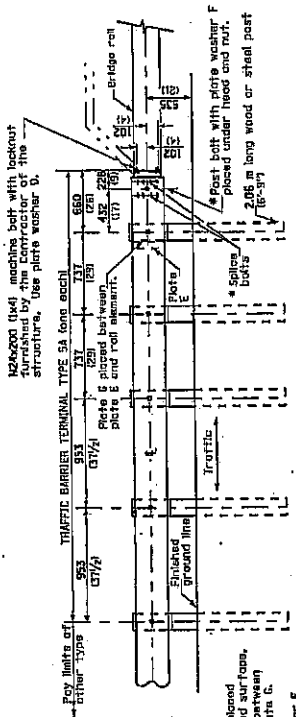

**TYPE 5A - STEEL BRIDGE RAIL**

**TYPE 5 - CONCRETE BRIDGE PARAPET**

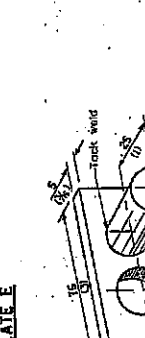
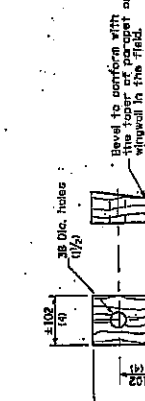
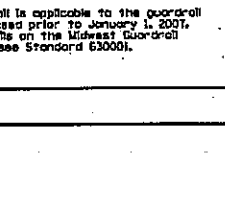
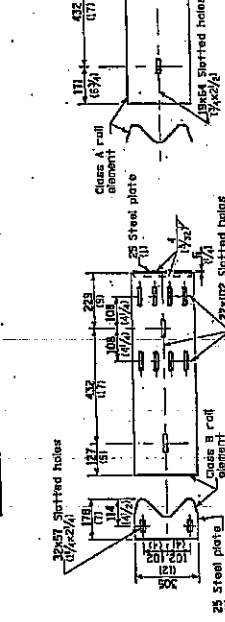
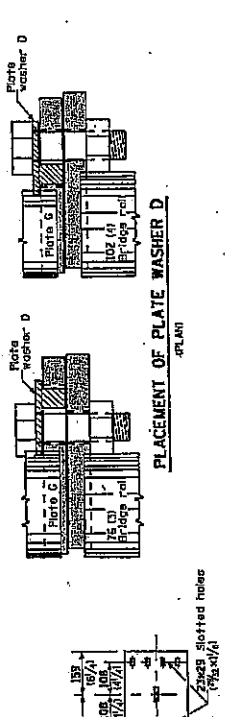

**GENERAL NOTES**

- Install plate washer D so that the 25 mm (1") projection fills the remainder of the staggered holes in the 25 mm (1") and plate on plate G after the M24 (1 1/2") dia. bolts are in place.
- Bolts shall be provided with locknut or double nut and shall be tightened only to a point that will allow plate G to be free to move when an expansion joint exists below the connector.
- All dimensions are in millimeters (inches) unless otherwise shown.

**TRAFFIC BARRIER  
 TERMINAL  
 TYPE 5 & 5A**

This detail is applicable to the guardrail system used prior to January 1, 2007. For details on the Midwest Guardrail system, see Standard 630001.

PLOT DATE: DATE-TIME:

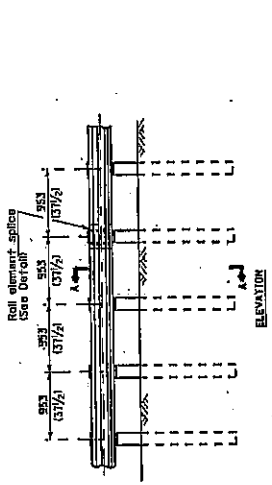

**TYPE B**  
 953 (37 1/2) Board post spacing

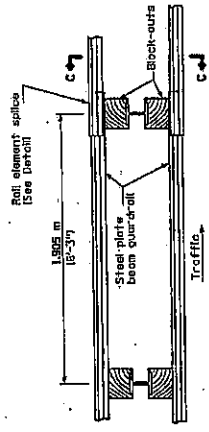

**TYPE D**  
 Double steel plate beam guardrail  
 1,805 (6'-3 3/4) Typical post spacing

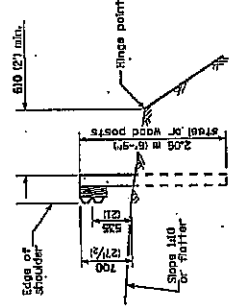

**SECTION A-A**

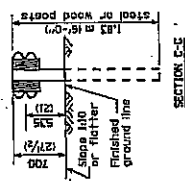

**SECTION C-C**

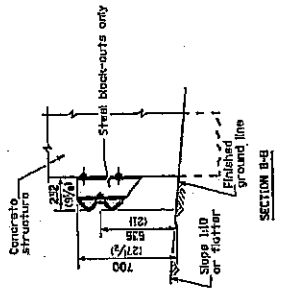

**SECTION B-B**

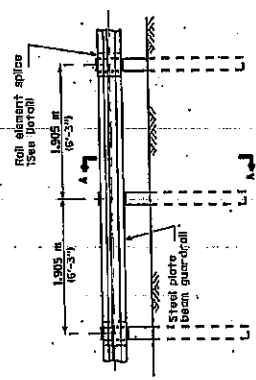

**TYPE A**  
 1,805 (6'-3 3/4) Typical post spacing

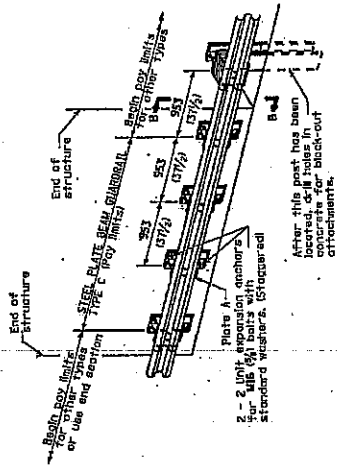

**TYPE C**  
 953 (37 1/2) Back-out spacing

**GENERAL NOTES**

All slope ratios are expressed as units of vertical displacement to units of horizontal displacement (V:H).  
 All dimensions are in millimeters (inches) unless otherwise shown.  
 The existing steel posts may be drilled to match the bolt pattern shown herein for the wood back-out, or a new steel post shall be provided.  
 This detail is applicable to the guardrail system used prior to January 1, 2001. For details on the Midwest Guardrail System, see Standard 630001.

**STEEL PLATE BEAM GUARDRAIL**

This detail is applicable to the guardrail system used prior to January 1, 2001. For details on the Midwest Guardrail System, see Standard 630001.



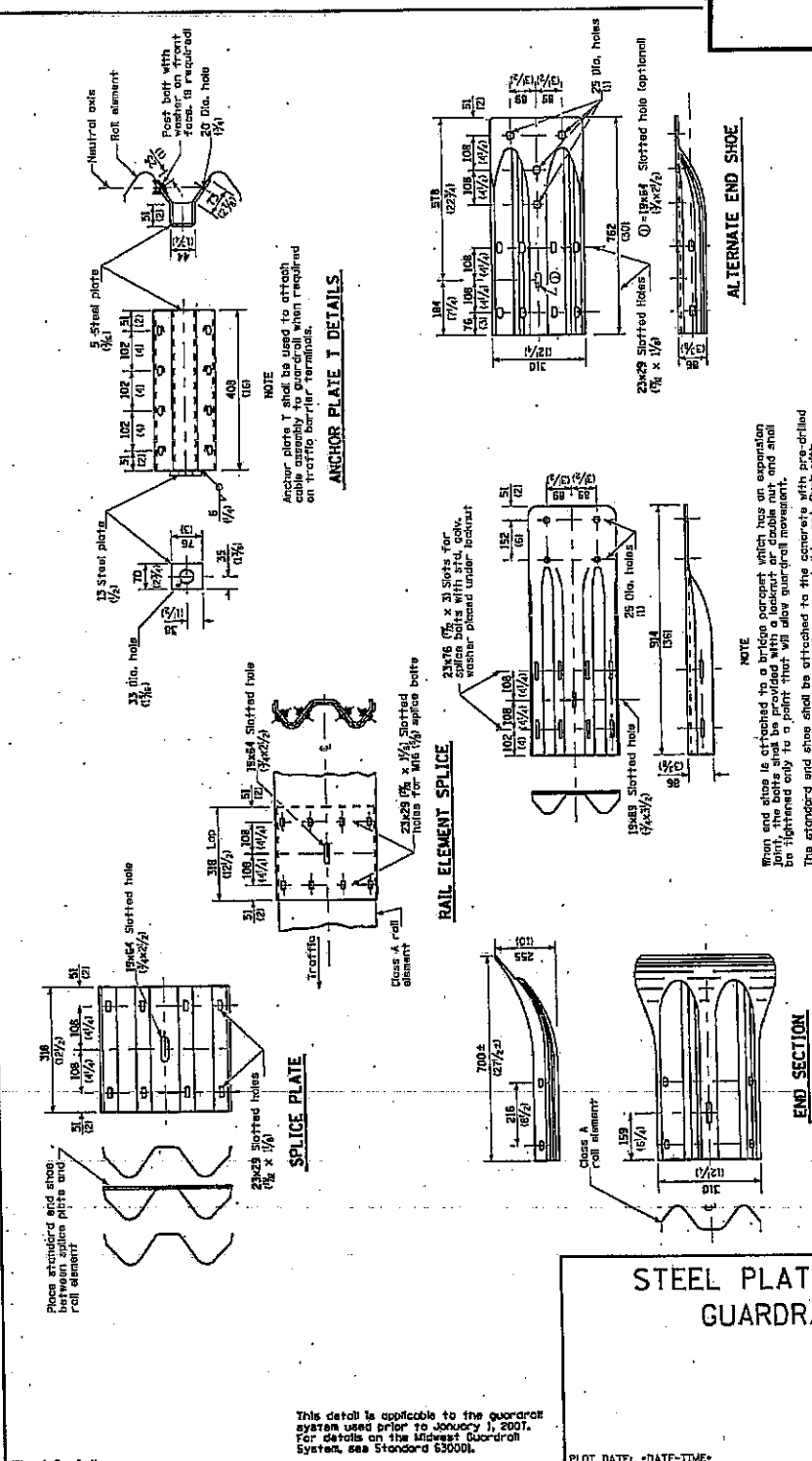

**STEEL PLATE BEAM  
 GUARDRAIL**

This detail is applicable to the guardrail system used prior to January 1, 2001. For details on the Midsize Guardrail System, see Standard 63000.

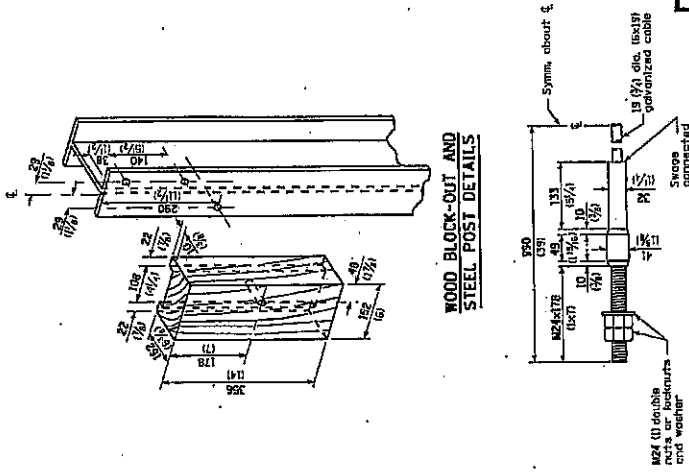

**WOOD BLOCK-OUT AND STEEL POST DETAILS**

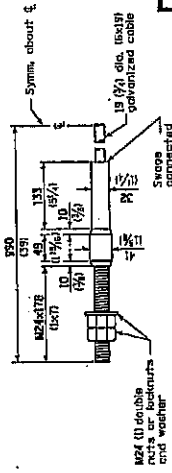

**CABLE ASSEMBLY**  
 168,000 kg (400,000 lbs.) min. breaking strength  
 lighter to full tension.

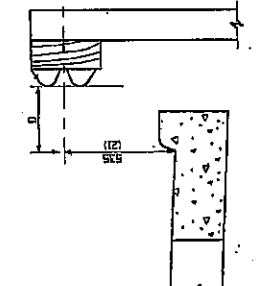

**GUARDRAIL PLACED BEHIND CURB**  
 100 = 0 desirable to 300 (12) maximum

Note: If it is necessary for a to be less than 300 (12) and in cases where the curb is not to be cut or cut off, use of the curb shall be used in front of and in advance of the guardrail.

V	R	L
0 - 480	610	Steel Post: Wood Post
0 - 180	520	0 - 250
0 - 180	520	0 - 250
0 - 400	420	0 - 150
300 - 113	300 - 0	200
0 - 113	112 - 0	0 - 100

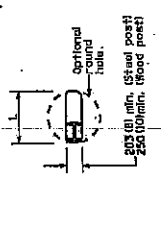

**PLAN**

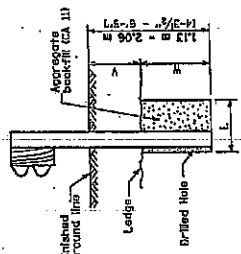

**ELEVATION**

Note: This is top of rock ledge or hard stop fill.

**FOOTING FOR POST WHEN IMPERVIOUS MATERIAL IS ENCOUNTERED**

**STEEL PLATE BEAM GUARDRAIL**

This detail is applicable to the guardrail system used prior to January 1, 2007. For details on the Midwest Guardrail System, see Standard E3000.

## ILLINOIS DEPARTMENT OF LABOR

### PREVAILING WAGES FOR VARIOUS COUNTIES EFFECTIVE MAY 2011

The Prevailing rates of wages are included in the Contract proposals which are subject to Check Sheet #5 of the Supplemental Specifications and Recurring Special Provisions. The rates have been ascertained and certified by the Illinois Department of Labor for the locality in which the work is to be performed and for each craft or type of work or mechanic needed to execute the work of the Contract. As required by Prevailing Wage Act (820 ILCS 130/0.01, et seq.) and Check Sheet #5 of the Contract, not less than the rates of wages ascertained by the Illinois Department of Labor and as revised during the performance of a Contract shall be paid to all laborers, workers and mechanics performing work under the Contract. Post the scale of wages in a prominent and easily accessible place at the site of work.

If the Illinois Department of Labor revises the prevailing rates of wages to be paid as listed in the specification of rates, the contractor shall post the revised rates of wages and shall pay not less than the revised rates of wages. Current wage rate information shall be obtained by visiting the Illinois Department of Labor web site at <http://www.state.il.us/agency/idol/> or by calling 312-793-2814. It is the responsibility of the contractor to review the rates applicable to the work of the contract at regular intervals in order to insure the timely payment of current rates. Provision of this information to the contractor by means of the Illinois Department of Labor web site satisfies the notification of revisions by the Department to the contractor pursuant to the Act, and the contractor agrees that no additional notice is required. The contractor shall notify each of its subcontractors of the revised rates of wages.

# Alexander County Prevailing Wage for May 2011

Trade Name	RG	TYP	C	Base	FRMAN	*M-F>8	OSA	OSH	H/W	Pensn	Vac	Trng
=====	==	===	=	=====	=====	=====	===	===	=====	=====	=====	=====
ASBESTOS ABT-GEN		ALL		24.400	24.850	1.5	1.5	2.0	5.550	9.450	0.000	0.900
ASBESTOS ABT-MEC		BLD		28.710	29.710	1.5	1.5	2.0	6.400	2.500	0.000	0.000
BOILERMAKER		BLD		31.500	34.000	1.5	1.5	2.0	6.820	11.43	1.500	0.350
BRICK MASON		BLD		27.220	28.720	1.5	1.5	2.0	7.950	6.690	0.000	0.430
CARPENTER		BLD		30.490	31.990	1.5	1.5	2.0	6.050	5.750	0.000	0.350
CARPENTER		HWY		30.440	31.940	1.5	1.5	2.0	6.050	5.750	0.000	0.350
CEMENT MASON		BLD		26.750	28.250	1.5	1.5	2.0	5.900	4.800	0.000	0.300
CEMENT MASON		HWY		26.350	27.350	1.5	1.5	2.0	5.900	4.350	0.000	0.300
CERAMIC TILE FNSHER		BLD		25.720	0.000	1.5	1.5	2.0	7.950	6.690	0.000	0.430
ELECTRICIAN		ALL		36.830	39.080	1.5	1.5	2.0	5.350	8.470	0.000	0.730
ELECTRONIC SYS TECH		BLD		29.530	31.280	1.5	1.5	2.0	5.250	3.840	0.000	0.250
FLOOR LAYER		BLD		28.930	29.680	1.5	1.5	2.0	6.050	5.750	0.000	0.350
GLAZIER		BLD		26.330	27.580	1.5	1.5	2.0	4.850	5.200	0.000	0.300
HT/FROST INSULATOR		BLD		36.260	37.260	1.5	1.5	2.0	7.150	10.46	0.000	0.500
IRON WORKER		ALL		26.740	28.740	1.5	1.5	2.0	5.760	9.590	0.000	0.500
LABORER		BLD		24.400	24.850	1.5	1.5	2.0	5.550	9.450	0.000	0.800
LABORER		HWY		24.400	24.850	1.5	1.5	2.0	5.550	9.450	0.000	0.800
LABORER		O&C		17.740	18.190	1.5	1.5	2.0	5.450	8.450	0.000	0.800
MACHINIST		BLD		43.160	45.160	1.5	1.5	2.0	7.640	8.700	0.000	0.000
MARBLE FINISHERS		BLD		25.720	0.000	1.5	1.5	2.0	7.950	6.690	0.000	0.430
MARBLE MASON		BLD		27.220	28.720	1.5	1.5	2.0	7.950	6.690	0.000	0.430
MILLWRIGHT		BLD		30.490	31.990	1.5	1.5	2.0	6.050	5.750	0.000	0.350
MILLWRIGHT		HWY		30.440	31.940	1.5	1.5	2.0	6.050	5.750	0.000	0.350
OE RIVER 1		RIV 1		32.100	33.100	1.5	1.5	2.0	6.500	8.300	0.000	1.350
OE RIVER 2		RIV 2		28.750	33.100	1.5	1.5	2.0	6.500	8.300	0.000	1.350
OPERATING ENGINEER		ALL 1		32.100	33.100	1.5	1.5	2.0	6.500	8.300	0.000	1.350
OPERATING ENGINEER		ALL 2		30.200	33.100	1.5	1.5	2.0	6.500	8.300	0.000	1.350
OPERATING ENGINEER		ALL 3		24.150	33.100	1.5	1.5	2.0	6.500	8.300	0.000	1.350
OPERATING ENGINEER		ALL 4		21.400	27.800	1.5	1.5	2.0	5.650	6.100	0.000	1.100
OPERATING ENGINEER		O&C 1		24.080	25.080	1.5	1.5	2.0	6.500	8.300	0.000	1.350
OPERATING ENGINEER		O&C 2		22.650	25.080	1.5	1.5	2.0	6.500	8.300	0.000	1.350
OPERATING ENGINEER		O&C 3		18.120	25.080	1.5	1.5	2.0	6.500	8.300	0.000	1.350
OPERATING ENGINEER		O&C 4		16.050	21.100	1.5	1.5	2.0	5.700	6.100	0.000	1.100
PAINTER		BLD		26.260	27.760	1.5	1.5	2.0	6.130	6.950	0.000	0.450
PAINTER		HWY		30.560	32.060	1.5	1.5	2.0	6.130	6.950	0.000	0.450
PAINTER OVER 30FT		BLD		27.260	28.760	1.5	1.5	2.0	6.130	6.950	0.000	0.450
PAINTER PWR EQMT		BLD		27.260	28.760	1.5	1.5	2.0	6.130	6.950	0.000	0.450
PAINTER PWR EQMT		HWY		31.560	33.060	1.5	1.5	2.0	6.130	6.950	0.000	0.450
PILEDRIVER		BLD		30.490	31.990	1.5	1.5	2.0	6.050	5.750	0.000	0.350
PILEDRIVER		HWY		30.440	31.940	1.5	1.5	2.0	6.050	5.750	0.000	0.350
PIPEFITTER		BLD		38.050	41.850	1.5	2.0	2.0	7.600	5.500	0.000	1.100
PLASTERER		BLD		26.750	28.250	1.5	1.5	2.0	5.900	4.800	0.000	0.300
PLUMBER		BLD		38.050	41.850	1.5	2.0	2.0	7.600	5.500	0.000	1.100
ROOFER		BLD		22.250	23.250	1.5	1.5	2.0	7.900	3.800	0.000	0.000
SHEETMETAL WORKER		ALL		31.390	32.890	1.5	1.5	2.0	6.430	6.490	1.890	0.360
SPRINKLER FITTER		BLD		36.140	38.890	1.5	1.5	2.0	8.100	8.200	0.000	0.350
STONE MASON		BLD		27.220	28.720	1.5	1.5	2.0	7.950	6.690	0.000	0.430
TERRAZZO FINISHER		BLD		25.720	0.000	1.5	1.5	2.0	7.950	6.690	0.000	0.430
TERRAZZO MASON		BLD		27.220	28.720	1.5	1.5	2.0	7.950	6.690	0.000	0.430
TRUCK DRIVER		ALL 1		28.430	0.000	1.5	1.5	2.0	9.100	5.500	0.000	0.250
TRUCK DRIVER		ALL 2		28.850	0.000	1.5	1.5	2.0	9.050	5.500	0.000	0.250
TRUCK DRIVER		ALL 3		29.050	0.000	1.5	1.5	2.0	9.050	5.500	0.000	0.250
TRUCK DRIVER		ALL 4		29.320	0.000	1.5	1.5	2.0	9.050	5.500	0.000	0.250
TRUCK DRIVER		ALL 5		30.100	0.000	1.5	1.5	2.0	9.050	5.500	0.000	0.250
TRUCK DRIVER		O&C 1		22.750	0.000	1.5	1.5	2.0	2.920	6.700	0.000	0.250
TRUCK DRIVER		O&C 2		19.150	0.000	1.5	1.5	2.0	2.920	6.700	0.000	0.250
TRUCK DRIVER		O&C 3		19.650	0.000	1.5	1.5	2.0	2.920	6.700	0.000	0.250
TUCKPOINTER		BLD		27.220	28.720	1.5	1.5	2.0	7.950	6.690	0.000	0.430

Legend :

M-F>8 (Overtime is required for any hour greater than 8 worked each day, Monday through Friday.)

OSA (Overtime is required for every hour worked on Saturday)

OSH (Overtime is required for every hour worked on Sunday and Holidays)

H/W (Health & Welfare Insurance)

Pensn (Pension)

Vac (Vacation)

Trng (Training)

## Explanations

### ALEXANDER COUNTY

The following list is considered as those days for which holiday rates of wages for work performed apply: New Years Day, Memorial Day, Fourth of July, Labor Day, Thanksgiving Day, Christmas Day and Veterans Day in some classifications/counties. Generally, any of these holidays which fall on a Sunday is celebrated on the following Monday. This then makes work performed on that Monday payable at the appropriate overtime rate for holiday pay. Common practice in a given local may alter certain days of celebration. If in doubt, please check with IDOL.

Oil and chip resealing (O&C) means the application of road oils and liquid asphalt to coat an existing road surface, followed by application of aggregate chips or gravel to coated surface, and subsequent rolling of material to seal the surface.

### EXPLANATION OF CLASSES

ASBESTOS - GENERAL - removal of asbestos material/mold and hazardous materials from any place in a building, including mechanical systems where those mechanical systems are to be removed. This includes the removal of asbestos materials/mold and hazardous materials from ductwork or pipes in a building when the building is to be demolished at the time or at some close future date.

ASBESTOS - MECHANICAL - removal of asbestos material from mechanical systems, such as pipes, ducts, and boilers, where the mechanical systems are to remain.

### LABORER - OIL AND CHIP RESEALING ONLY

Hook and unhook chip box from aggregate truck; distribute material within chip box; perform flagging work related to oil and chip resealing; hand spray oil fluids; handle traffic control, including setting-up and maintaining barricades, drums, cones, delineators, signs and other such items, as well as laying-out and applying or removing temporary roadway markings used to control traffic in job site related to oil and chip resealing; and perform clean-up related to oil and chip resealing.



#### CERAMIC TILE FINISHER, MARBLE FINISHER, TERRAZZO FINISHER

Assisting, helping or supporting the tile, marble and terrazzo mechanic by performing their historic and traditional work assignments required to complete the proper installation of the work covered by said crafts. The term "Ceramic" is used for naming the classification only, and is in no a limitation of the product handled. Ceramic takes into consideration most hard tiles.

#### ELECTRONIC SYSTEMS TECHNICIAN

Installation, service and maintenance of low-voltage systems which utilizes the transmission and/or transference of voice, sound, vision, or digital for commercial, education, security and entertainment purposes for the following: TV monitoring and surveillance, background/foreground music, intercom and telephone interconnect, field programming, inventory control systems, microwave transmission, multi-media, multiplex, radio page, school, intercom and sound burglar alarms and low voltage master clock systems.

Excluded from this classification are energy management systems, life safety systems, supervisory controls and data acquisition systems not intrinsic with the above listed systems, fire alarm systems, nurse call systems and raceways exceeding fifteen feet in length.

#### TRUCK DRIVER - BUILDING, HEAVY AND HIGHWAY CONSTRUCTION

Class 1. Drivers on 2 axle trucks hauling less than 9 ton. Air compressor and welding machines and brooms, including those pulled by separate units, truck driver helpers, warehouse employees, mechanic helpers, greasers and tiremen, pickup trucks when hauling materials, tools, or workers to and from and on-the-job site, and fork lifts up to 6,000 lb. capacity.

Class 2. Two or three axle trucks hauling more than 9 ton but hauling less than 16 ton. A-frame winch trucks, hydrolift trucks, vector trucks or similar equipment when used for transportation purposes. Fork lifts over 6,000 lb. capacity, winch trucks, four axle combination units, and ticket writers.

Class 3. Two, three or four axle trucks hauling 16 ton or more. Drivers on water pulls, articulated dump trucks, mechanics and working forepersons, and dispatchers. Five axle or more combination units.

Class 4. Low Boy and Oil Distributors.

Class 5. Drivers who require special protective clothing while employed on hazardous waste work.

#### TRUCK DRIVER - O & C - (Oil and Chip Resealing ONLY)

It involves driving of contractor or subcontractor owned, leased, or hired pickup, dump, service, or oil distributor trucks. Includes transporting materials and equipment (including, but not limited to oils, aggregate supplies, parts, machinery and tools) to or from the job site; distributing oil or liquid asphalt and aggregate; stock piling material; and maintaining trucks at job site related to oil and chip resealing.

Class 1. Distributors, liquid asphalt hauling and hauling of asphalt rubber-tired rollers.

Class 2. Stockpiling.

Class 3. Tandem hauling to job site.

#### OPERATING ENGINEERS - BUILDING, HEAVY AND HIGHWAY CONSTRUCTION

Class 1. APSCO or Equal Spreading Machine, Backhoe, Backfiller, Boom or Winch Cat, Bituminous Mixplane Machine, Blacksmith, Bituminous Surfacing Machine, Bull-Dozer, Crane, Shovel, Dragline, Truck Crane, Pile Driver, Concrete Breaker, Concrete or Pumpcrete Pumps, Dinky or Standard Locomotives, Well or Caisson Drills, Elevating Grader, Fork Lifts, Flexplane, Gradeall, Hi-Lift Hoists, Guy-Derricks, Hysters, Mechanic Motor Patrol, Mixers-21 cu. ft. or over, Push Cats, Pulls and Scrapers, Two Well Point Pumps, Pulverizer or Tiller, PugMill, Rubber-Tired Farm Type Tractor with Bulldozer/Blade/Auger or hi-lift over 1/2 yd., Jersey Spreader, Tract-Air used with Drill or Hi-Lift, Trenching or Ditching Machines, Wood Chipper w/Tractor, Self-Propelled Roller w/Blade, Equipment Greaser, Self-Propelled Bump Grinder on Concrete pavement, Boat Operator, Skid-Loaders, Tuggers, Lazer Screed, and Self-Propelled Chip Spreader (when others run conveyors).

Class 2. Any type tractor pulling any type roller or disc, Two Air Compressors (220 cu. ft. capacity or over), Two AirTract Drills, Air-Track Drill w/Compressor, Automatic Bins or Scales w/Compressor or Generator, Pipeline Boring Machine, Bulk Cement Plant w/Separate Compressor, Power Operated Bull Float, Hydra-Lift w/Single Motor, Straw Mulcher Blower w/Spout, Self-Propelled Roller/Compactor, Back-End man on Bituminous Surfacing Machine, oiler on milling machine.

Class 3. Air Compressor w/Valve driving piling, Boom or Winch Type Truck, Two Conveyors, Self-Propelled Concrete Saw, Form Grader, Truck Crane Oiler, Self-Propelled Vibrator, Rubber Tired Farm Type Tractor w/Blade/Bulldozer/Auger/hi-lift - 1/2 yd. or less, Elevator Operator, Man Lift (scissor lift) when lifting materials.

Class 4. Air-Track Drill (one), Belt Drag Machine, Power Broom, Mechanical Plasterer Applicator, Trac-Air, Air Compressor (220 cu. ft. or over) One, Air Compressor (under 220 cu. ft) four, Automatic Bin, Bulk Cement Plant w/Built-in Compressor running off same motor or electric motor, Fireman or Switchman, Self-Propelled Form Tamper, Light Plants (4), Welding Machines (4), Pumps (4), or Combination of four (4) Pumps, Light Plants, Welding Machines, Air-Compressors (under 220 cu. ft.), Mudjacks or Wood Chipper, Mixers - less than 21 cu. ft. Mortar Mixer w/Skip or Pump, Pipeline Tract Jack. One Operating Engineer may operate and maintain any combination of the following pieces of equipment, not to exceed four (4) which shall be within a reasonable distance, such combination may include any equipment in this classification: (Compressors, Light Plants, Generators, Welding Machines, Pumps or Conveyors), One Well- Point Pump, Two Motor Driven Heaters, One Air Compressor (under 220 cu. ft.), One Engine-Driven Conveyor, One Motor Driven Heater, One Light Plant, One Pump, One Welding Machine, One Ulmac or Equal Spreader, Oilers, and one Generator 10 kw or greater.

OPERATING ENGINEER - O & C (Oil and Chip Resealing ONLY). Includes the operation of all motorized heavy equipment used in oil and chip rsealing, including but not limited to operating self-propelled chip spreaders, and all types of rollers (both hard and rubber tired); and other duties pertaining to the operation or maintenance of heavy equipment related to oil and chip resealing.

Class 1. See Class 1 above for types of equipment operated.

Class 2. See Class 2 above for types of equipment operated.

Class 3. See Class 3 above for types of equipment operated.

Class 4. See Class 4 above for types of equipment operated.

OPERATING ENGINEER RIVER WORK 1 - operate the following machines when working on River Work and Levee Work on the Mississippi and Ohio Rivers, Lakes and Tributaries: Crane, Shovel, Drageline, Scrapers, Dredge, Derrick, Pile-Driver, Push Boat, all power boat operators, Mechanic, Engineman on Dredge, Leverman on Dredge, All Bituminous Spreader machines, Backhoe, Backfiller, Boom, or Winch Cat, Bituminous Mixplane Machine, Blacksmith, Bituminous Surfacing Machine, Bulldozer, Truck Cranes, Hydraulic Truck Mounted Boom/Crane, Concrete Finishing Machine, or Spreader Machine, Concrete Breaker, Concrete or Pumpcrete Machines, Concrete Plant Operator, All Off Road Material Hauling Equipment, Dinky or Standard Locomotives, Well Drill, Elevating Grader, Fork-Lifts, Flexplane, Gradeall, Hi-Lift, Power Handblade Tugger type Hoist, Hoist Two Drum (or over one), Gyderrick, Hyster, Motor Patrol, Mixers - 21 Cu. Ft. or over, Push Cat, Pulls, & Scrapers, Pumps-Two Well Points, Equipment Greaser, P & H Pulverizer or Pulverizer equal to Pugmill, Pugmill, Rubber-Tired farm type tractor w/Bulldozer/Blade/Auger or Hi-Lift over ½ yard, Skimmer Scoops, Seaman Tiller, Jersey Spreader, Tract-Air used with Drill or Hi-Lift, Trenching or Ditching Machine, Wood Chipper w/Tractor, self-propelled roller w/Blade, Concrete Pumps and Small Equipment Operators.

OPERATING ENGINEER RIVER 2 - when working on River Work and Levee Work on the Mississippi and Ohio Rivers, Lakes and Tributaries shall be employed as the Oiler or Fireman on Crane, Dragline, Shovel, Dredge, Truck Crane, Pile Driver, Gradeall, Dinky or Standard Locomotive, Guy Derrick, Trenching Machine or Ditching Machine 80 H.P. and over, All Terrain (cherry-picker) with over 40 ton Lifting Capacity, Deck Oiler and Deckhands.

Other Classifications of Work:

For definitions of classifications not otherwise set out, the Department generally has on file such definitions which are available. If a task to be performed is not subject to one of the classifications of pay set out, the Department will upon being contacted state which neighboring county has such a classification and provide such rate, such rate being deemed to exist by reference in this document. If no neighboring county rate applies to the task, the Department shall undertake a special determination, such special determination being then deemed to have existed under this determination. If a project requires these, or any classification not listed, please contact IDOL at 217-782-1710 for wage rates or clarifications.

#### LANDSCAPING

Landscaping work falls under the existing classifications for laborer, operating engineer and truck driver. The work performed by landscape plantsman and landscape laborer is covered by the existing classification of laborer. The work performed by landscape operators (regardless of equipment used or its size) is covered by the classifications of operating engineer. The work performed by landscape truck drivers (regardless of size of truck driven) is covered by the classifications of truck driver.

# Franklin County Prevailing Wage for May 2011

Trade Name	RG	TYP	C	Base	FRMAN	*M-F>8	OSA	OSH	H/W	Pensn	Vac	Trng
=====	==	===	=	=====	=====	=====	===	===	=====	=====	=====	=====
ASBESTOS ABT-GEN		ALL		24.400	24.850	1.5	1.5	2.0	5.550	9.450	0.000	0.900
ASBESTOS ABT-MEC		BLD		20.800	0.000	2.0	2.0	2.0	5.500	4.200	0.000	0.000
BOILERMAKER		BLD		31.500	34.000	1.5	1.5	2.0	6.820	11.43	1.500	0.350
BRICK MASON		BLD		27.220	28.720	1.5	1.5	2.0	7.950	6.690	0.000	0.430
CARPENTER		BLD		30.490	31.990	1.5	1.5	2.0	6.050	5.750	0.000	0.350
CARPENTER		HWY		30.440	31.940	1.5	1.5	2.0	6.050	5.750	0.000	0.350
CEMENT MASON		BLD		26.750	28.250	1.5	1.5	2.0	5.900	4.800	0.000	0.300
CEMENT MASON		HWY		26.350	27.350	1.5	1.5	2.0	5.900	4.350	0.000	0.300
CERAMIC TILE FNSHER		BLD		25.720	0.000	1.5	1.5	2.0	7.950	6.690	0.000	0.430
ELECTRICIAN		ALL		36.830	39.080	1.5	1.5	2.0	5.350	8.470	0.000	0.730
ELECTRONIC SYS TECH		BLD		29.530	31.280	1.5	1.5	2.0	5.250	3.840	0.000	0.250
FLOOR LAYER		BLD		28.930	29.680	1.5	1.5	2.0	6.050	5.750	0.000	0.350
GLAZIER		BLD		26.330	27.580	1.5	1.5	2.0	4.850	5.200	0.000	0.300
HT/FROST INSULATOR		BLD		28.920	29.920	1.5	1.5	2.0	4.800	8.160	0.000	0.280
IRON WORKER		ALL		27.020	28.270	1.5	1.5	2.0	5.760	9.600	0.000	0.345
LABORER		BLD		24.400	24.850	1.5	1.5	2.0	5.550	9.450	0.000	0.800
LABORER		HWY		24.400	24.850	1.5	1.5	2.0	5.550	9.450	0.000	0.800
LABORER		O&C		17.740	18.190	1.5	1.5	2.0	5.450	8.450	0.000	0.800
MACHINIST		BLD		43.160	45.160	1.5	1.5	2.0	7.640	8.700	0.000	0.000
MARBLE FINISHERS		BLD		25.720	0.000	1.5	1.5	2.0	7.950	6.690	0.000	0.430
MARBLE MASON		BLD		27.220	28.720	1.5	1.5	2.0	7.950	6.690	0.000	0.430
MILLWRIGHT		BLD		30.490	31.990	1.5	1.5	2.0	6.050	5.750	0.000	0.350
MILLWRIGHT		HWY		30.440	31.940	1.5	1.5	2.0	6.050	5.750	0.000	0.350
OE RIVER 1		RIV 1		32.100	33.100	1.5	1.5	2.0	6.500	8.300	0.000	1.350
OE RIVER 2		RIV 2		28.750	33.100	1.5	1.5	2.0	6.500	8.300	0.000	1.350
OPERATING ENGINEER		ALL 1		32.100	33.100	1.5	1.5	2.0	6.500	8.300	0.000	1.350
OPERATING ENGINEER		ALL 2		30.200	33.100	1.5	1.5	2.0	6.500	8.300	0.000	1.350
OPERATING ENGINEER		ALL 3		24.150	33.100	1.5	1.5	2.0	6.500	8.300	0.000	1.350
OPERATING ENGINEER		ALL 4		21.400	27.800	1.5	1.5	2.0	5.650	6.100	0.000	1.100
OPERATING ENGINEER		O&C 1		24.080	25.080	1.5	1.5	2.0	6.500	8.300	0.000	1.350
OPERATING ENGINEER		O&C 2		22.650	25.080	1.5	1.5	2.0	6.500	8.300	0.000	1.350
OPERATING ENGINEER		O&C 3		18.120	25.080	1.5	1.5	2.0	6.500	8.300	0.000	1.350
OPERATING ENGINEER		O&C 4		16.050	21.100	1.5	1.5	2.0	5.650	6.100	0.000	1.100
PAINTER		BLD		26.260	27.760	1.5	1.5	2.0	6.130	6.950	0.000	0.450
PAINTER		HWY		30.560	32.060	1.5	1.5	2.0	6.130	6.950	0.000	0.450
PAINTER OVER 30FT		BLD		27.260	28.760	1.5	1.5	2.0	6.130	6.950	0.000	0.450
PAINTER PWR EQMT		BLD		27.260	28.760	1.5	1.5	2.0	6.130	6.950	0.000	0.450
PAINTER PWR EQMT		HWY		31.560	33.060	1.5	1.5	2.0	6.130	6.950	0.000	0.450
PILEDRIVER		BLD		30.490	31.990	1.5	1.5	2.0	6.050	5.750	0.000	0.350
PILEDRIVER		HWY		30.440	31.940	1.5	1.5	2.0	6.050	5.750	0.000	0.350
PIPEFITTER		BLD		32.250	35.470	1.5	1.5	2.0	8.250	8.850	0.000	1.200
PLASTERER		BLD		26.750	28.250	1.5	1.5	2.0	5.900	4.800	0.000	0.300
PLUMBER		BLD		32.250	35.470	1.5	1.5	2.0	8.250	8.850	0.000	1.200
ROOFER		BLD		22.250	23.250	1.5	1.5	2.0	7.900	3.800	0.000	0.000
SHEETMETAL WORKER		ALL		31.390	32.890	1.5	1.5	2.0	6.430	6.490	1.890	0.360
SPRINKLER FITTER		BLD		36.140	38.890	1.5	1.5	2.0	8.100	8.200	0.000	0.350
STONE MASON		BLD		27.220	28.720	1.5	1.5	2.0	7.950	6.690	0.000	0.430
TERRAZZO FINISHER		BLD		25.720	0.000	1.5	1.5	2.0	7.950	6.690	0.000	0.430
TERRAZZO MASON		BLD		28.500	28.800	1.5	1.5	2.0	6.400	5.700	0.000	0.430
TRUCK DRIVER		ALL 1		28.430	0.000	1.5	1.5	2.0	9.050	5.500	0.000	0.250
TRUCK DRIVER		ALL 2		28.850	0.000	1.5	1.5	2.0	9.050	5.500	0.000	0.250
TRUCK DRIVER		ALL 3		29.050	0.000	1.5	1.5	2.0	9.050	5.500	0.000	0.250
TRUCK DRIVER		ALL 4		29.320	0.000	1.5	1.5	2.0	9.050	5.500	0.000	0.250
TRUCK DRIVER		ALL 5		30.100	0.000	1.5	1.5	2.0	9.050	5.500	0.000	0.250
TRUCK DRIVER		O&C 1		22.750	0.000	1.5	1.5	2.0	2.920	6.700	0.000	0.250
TRUCK DRIVER		O&C 2		19.150	0.000	1.5	1.5	2.0	2.920	6.700	0.000	0.250
TRUCK DRIVER		O&C 3		19.650	0.000	1.5	1.5	2.0	2.920	6.700	0.000	0.250
TUCKPOINTER		BLD		27.220	28.720	1.5	1.5	2.0	7.950	6.690	0.000	0.430

Legend :

M-F>8 (Overtime is required for any hour greater than 8 worked each day, Monday through Friday.)

OSA (Overtime is required for every hour worked on Saturday)

OSH (Overtime is required for every hour worked on Sunday and Holidays)

H/W (Health & Welfare Insurance)

Pensn (Pension)

Vac (Vacation)

Trng (Training)

## Explanations

### FRANKLIN COUNTY

The following list is considered as those days for which holiday rates of wages for work performed apply: New Years Day, Memorial Day, Fourth of July, Labor Day, Thanksgiving Day, Christmas Day and Veterans Day in some classifications/counties. Generally, any of these holidays which fall on a Sunday is celebrated on the following Monday. This then makes work performed on that Monday payable at the appropriate overtime rate for holiday pay. Common practice in a given local may alter certain days of celebration. If in doubt, please check with IDOL.

Oil and Chip Resealing (O&C) means the application of road oils and liquid asphalt to coat an existing road surface, followed by application of aggregate chips or gravel to coated surface, and subsequent rolling of material to seal the surface.

### EXPLANATION OF CLASSES

ASBESTOS - GENERAL - removal of asbestos material/mold and hazardous materials from any place in a building, including mechanical systems where those mechanical systems are to be removed. This includes the removal of asbestos materials/mold and hazardous materials from ductwork or pipes in a building when the building is to be demolished at the time or at some close future date.

ASBESTOS - MECHANICAL - removal of asbestos material from mechanical systems, such as pipes, ducts, and boilers, where the mechanical systems are to remain.

### CERAMIC TILE FINISHER, MARBLE FINISHER, TERRAZZO FINISHER

Assisting, helping or supporting the tile, marble and terrazzo mechanic by performing their historic and traditional work assignments required to complete the proper installation of the work covered by said crafts. The term "Ceramic" is used for naming the classification only, and is in no a limitation of the product handled. Ceramic takes into consideration most hard tiles.

### LABORER - OIL AND CHIP RESEALING ONLY

Hook and unhook chip box from aggregate truck; distribute material within chip box; perform flagging work related to oil and chip resealing; hand spray oil fluids; handle traffic control, including setting-up and maintaining barricades, drums, cones, delineators, signs and other such items, as well as laying-out and applying or removing temporary roadway markings used to control traffic in job site related to oil and chip resealing; and perform clean-up related to oil and chip resealing.

#### ELECTRONIC SYSTEMS TECHNICIAN

Installation, service and maintenance of low-voltage systems which utilizes the transmission and/or transference of voice, sound, vision, or digital for commercial, education, security and entertainment purposes for the following: TV monitoring and surveillance, background/foreground music, intercom and telephone interconnect, field programming, inventory control systems, microwave transmission, multi-media, multiplex, radio page, school, intercom and sound burglar alarms and low voltage master clock systems.

Excluded from this classification are energy management systems, life safety systems, supervisory controls and data acquisition systems not intrinsic with the above listed systems, fire alarm systems, nurse call systems and raceways exceeding fifteen feet in length.

#### TRUCK DRIVER - BUILDING, HEAVY AND HIGHWAY CONSTRUCTION

Class 1. Drivers on 2 axle trucks hauling less than 9 ton. Air compressor and welding machines and brooms, including those pulled by separate units, truck driver helpers, warehouse employees, mechanic helpers, greasers and tiremen, pickup trucks when hauling materials, tools, or workers to and from and on-the-job site, and fork lifts up to 6,000 lb. capacity.

Class 2. Two or three axle trucks hauling more than 9 ton but hauling less than 16 ton. A-frame winch trucks, hydrolift trucks, vector trucks or similar equipment when used for transportation purposes. Fork lifts over 6,000 lb. capacity, winch trucks, four axle combination units, and ticket writers.

Class 3. Two, three or four axle trucks hauling 16 ton or more. Drivers on water pulls, articulated dump trucks, mechanics and working forepersons, and dispatchers. Five axle or more combination units.

Class 4. Low Boy and Oil Distributors.

Class 5. Drivers who require special protective clothing while employed on hazardous waste work.

#### TRUCK DRIVER - O & C - (Oil and Chip Resealing)

It involves driving of contractor or subcontractor owned, leased, or hired pickup, dump, service, or oil distributor trucks. Includes transporting materials and equipment (including, but not limited to oils, aggregate supplies, parts, machinery and tools) to or from the job site; distributing oil or liquid asphalt and aggregate; stock piling material; and maintaining trucks at job site related to oil and chip resealing.

Class 1. Distributors, liquid asphalt hauling and hauling of asphalt rubber-tired rollers.

Class 2. Stockpiling.

Class 3. Tandem hauling to job site.

OPERATING ENGINEERS - BUILDING, HEAVY AND HIGHWAY CONSTRUCTION

Class 1. APSCO or Equal Spreading Machine, Backhoe, Backfiller, Boom or Winch Cat, Bituminous Mixplane Machine, Blacksmith, Bituminous Surfacing Machine, Bull-Dozer, Crane, Shovel, Dragline, Truck Crane, Pile Driver, Concrete Breaker, Concrete or Pumpcrete Pumps, Dinky or Standard Locomotives, Well or Caisson Drills, Elevating Grader, Fork Lifts, Flexplane, Gradeall, Hi-Lift Hoists, Guy-Derricks, Hysters, Mechanic Motor Patrol, Mixers-21 cu. ft. or over, Push Cats, Pulls and Scrapers, Two Well Point Pumps, Pulverizer or Tiller, PugMill, Rubber-Tired Farm Type Tractor with Bulldozer/Blade/Auger or hi-lift over 1/2 yd., Jersey Spreader, Tract-Air used with Drill or Hi-Lift, Trenching or Ditching Machines, Wood Chipper w/Tractor, Self-Propelled Roller w/Blade, Equipment Greaser, Self-Propelled Bump Grinder on Concrete pavement, Boat Operator, Skid-Loaders, Tuggers, Lazer Screed, and Self-Propelled Chip Spreader (when others run conveyors).

Class 2. Any type tractor pulling any type roller or disc, Two Air Compressors (220 cu. ft. capacity or over), Two AirTract Drills, Air-Track Drill w/Compressor, Automatic Bins or Scales w/Compressor or Generator, Pipeline Boring Machine, Bulk Cement Plant w/Separate Compressor, Power Operated Bull Float, Hydra-Lift w/Single Motor, Straw Mulcher Blower w/Spout, Self-Propelled Roller/Compactor, Back-End man on Bituminous Surfacing Machine, oiler on milling machine.

Class 3. Air Compressor w/Valve driving piling, Boom or Winch Type Truck, Two Conveyors, Self-Propelled Concrete Saw, Form Grader, Truck Crane Oiler, Self-Propelled Vibrator, Rubber Tired Farm Type Tractor w/Blade/Bulldozer/Auger/hi-lift - 1/2 yd. or less, Elevator Operator, Man Lift (scissor lift) when lifting materials.

Class 4. Air-Track Drill (one), Belt Drag Machine, Power Broom, Mechanical Plasterer Applicator, Trac-Air, Air Compressor (220 cu. ft. or over) One, Air Compressor (under 220 cu. ft) four, Automatic Bin, Bulk Cement Plant w/Built-in Compressor running off same motor or electric motor, Fireman or Switchman, Self-Propelled Form Tamper, Light Plants (4), Welding Machines (4), Pumps (4), or Combination of four (4) Pumps, Light Plants, Welding Machines, Air-Compressors (under 220 cu. ft.), Mudjacks or Wood Chipper, Mixers - less than 21 cu. ft. Mortar Mixer w/Skip or Pump, Pipeline Tract Jack. One Operating Engineer may operate and maintain any combination of the following pieces of equipment, not to exceed four (4) which shall be within a reasonable distance, such combination may include any equipment in this classification: (Compressors, Light Plants, Generators, Welding Machines, Pumps or Conveyors), One Well- Point Pump, Two Motor Driven Heaters, One Air Compressor (under 220 cu. ft.), One Engine-Driven Conveyor, One Motor Driven Heater, One Light Plant, One Pump, One Welding Machine, One Ulmac or Equal Spreader, Oilers, and one Generator 10 kw or greater.

OPERATING ENGINEER - O & C (Oil and Chip Resealing ONLY.)

Includes the operation of all motorized heavy equipment used in oil and chip rsealing, including but not limited to operating self-propelled chip spreaders, and all types of rollers (both hard and rubber tired); and other duties pertaining to the operation or maintenance of heavy equipment related to oil and chip resealing.

Class 1. See Class 1 above for types of equipment operated.

Class 2. See Class 2 above for types of equipment operated.

Class 3. See Class 3 above for types of equipment operated.

Class 4. See Class 4 above for types of equipment operated.

OPERATING ENGINEER RIVER WORK 1 - operate the following machines when working on River Work and Levee Work on the Mississippi and Ohio Rivers, Lakes and Tributaries: Crane, Shovel, Drageline, Scrapers, Dredge, Derrick, Pile-Driver, Push Boat, all power boat operators, Mechanic, Engineman on Dredge, Leverman on Dredge, All Bituminous Spreader machines, Backhoe, Backfiller, Boom, or Winch Cat, Bituminous Mixplane Machine, Blacksmith, Bituminous Surfacing Machine, Bulldozer, Truck Cranes, Hydraulic Truck Mounted Boom/Crane, Concrete Finishing Machine, or Spreader Machine, Concrete Breaker, Concrete or Pumpcrete Machines, Concrete Plant Operator, All Off Road Material Hauling Equipment, Dinky or Standard Locomotives, Well Drill, Elevating Grader, Fork-Lifts, Flexplane, Gradeall, Hi-Lift, Power Handblade Tugger type Hoist, Hoist Two Drum (or over one), Gyderrick, Hyster, Motor Patrol, Mixers - 21 Cu. Ft. or over, Push Cat, Pulls, & Scrapers, Pumps-Two Well Points, Equipment Greaser, P & H Pulverizer or Pulverizer equal to Pugmill, Pugmill, Rubber-Tired farm type tractor w/Bulldozer/Blade/Auger or Hi-Lift over ½ yard, Skimmer Scoops, Seaman Tiller, Jersey Spreader, Tract-Air used with Drill or Hi-Lift, Trenching or Ditching Machine, Wood Chipper w/Tractor, self-propelled roller w/Blade, Concrete Pumps and Small Equipment Operators.

OPERATING ENGINEER RIVER 2 - when working on River Work and Levee Work on the Mississippi and Ohio Rivers, Lakes and Tributaries shall be employed as the Oiler or Fireman on Crane, Dragline, Shovel, Dredge, Truck Crane, Pile Driver, Gradeall, Dinky or Standard Locomotive, Guy Derrick, Trenching Machine or Ditching Machine 80 H.P. and over, All Terrain (cherry-picker) with over 40 ton Lifting Capacity, Deck Oiler and Deckhands.

#### Other Classifications of Work:

For definitions of classifications not otherwise set out, the Department generally has on file such definitions which are available. If a task to be performed is not subject to one of the classifications of pay set out, the Department will upon being contacted state which neighboring county has such a classification and provide such rate, such rate being deemed to exist by reference in this document. If no neighboring county rate applies to the task, the Department shall undertake a special determination, such special determination being then deemed to have existed under this determination. If a project requires these, or any classification not listed, please contact IDOL at 217-782-1710 for wage rates or clarifications.

#### LANDSCAPING

Landscaping work falls under the existing classifications for laborer, operating engineer and truck driver. The work performed by landscape plantsman and landscape laborer is covered by the existing classification of laborer. The work performed by landscape operators (regardless of equipment used or its size) is covered by the classifications of operating engineer. The work performed by landscape truck drivers (regardless of size of truck driven) is covered by the classifications of truck driver.



# Gallatin County Prevailing Wage for May 2011

Trade Name	RG	TYP	C	Base	FRMAN	*M-F>8	OSA	OSH	H/W	Pensn	Vac	Trng
=====	==	===	=	=====	=====	=====	===	===	=====	=====	=====	=====
ASBESTOS ABT-GEN		ALL		24.400	24.850	1.5	1.5	2.0	5.550	9.450	0.000	0.900
ASBESTOS ABT-MEC		BLD		20.800	0.000	2.0	2.0	2.0	5.500	4.200	0.000	0.000
BOILERMAKER		BLD		31.500	34.000	1.5	1.5	2.0	6.820	11.43	1.500	0.350
BRICK MASON		BLD		27.220	28.720	1.5	1.5	2.0	7.950	6.690	0.000	0.430
CARPENTER		BLD		30.490	31.990	1.5	1.5	2.0	6.050	5.750	0.000	0.350
CARPENTER		HWY		30.440	31.940	1.5	1.5	2.0	6.050	5.750	0.000	0.350
CEMENT MASON		BLD		26.750	28.250	1.5	1.5	2.0	5.900	4.800	0.000	0.300
CEMENT MASON		HWY		26.350	27.350	1.5	1.5	2.0	5.900	4.350	0.000	0.300
CERAMIC TILE FNSHER		BLD		25.720	0.000	1.5	1.5	2.0	7.950	6.690	0.000	0.430
ELECTRICIAN		ALL		36.830	39.080	1.5	1.5	2.0	5.350	8.470	0.000	0.730
ELECTRONIC SYS TECH		BLD		29.530	31.280	1.5	1.5	2.0	5.250	3.840	0.000	0.250
FLOOR LAYER		BLD		28.930	29.680	1.5	1.5	2.0	6.050	5.750	0.000	0.350
GLAZIER		BLD		26.330	27.580	1.5	1.5	2.0	4.850	5.200	0.000	0.300
HT/FROST INSULATOR		BLD		28.920	29.920	1.5	1.5	2.0	4.800	8.160	0.000	0.280
IRON WORKER		ALL		27.020	28.270	1.5	1.5	2.0	5.760	9.600	0.000	0.345
LABORER		BLD		24.400	24.850	1.5	1.5	2.0	5.550	9.450	0.000	0.800
LABORER		HWY		24.400	24.850	1.5	1.5	2.0	5.550	9.450	0.000	0.800
LABORER		O&C		17.740	18.190	1.5	1.5	2.0	5.450	8.450	0.000	0.800
MACHINIST		BLD		43.160	45.160	1.5	1.5	2.0	7.640	8.700	0.000	0.000
MARBLE FINISHERS		BLD		25.720	0.000	1.5	1.5	2.0	7.950	6.690	0.000	0.430
MARBLE MASON		BLD		27.220	28.720	1.5	1.5	2.0	7.950	6.690	0.000	0.430
MILLWRIGHT		BLD		30.490	31.990	1.5	1.5	2.0	6.050	5.750	0.000	0.350
MILLWRIGHT		HWY		30.440	31.940	1.5	1.5	2.0	6.050	5.750	0.000	0.350
OE RIVER 1		RIV 1		32.100	33.100	1.5	1.5	2.0	6.500	8.300	0.000	1.350
OE RIVER 2		RIV 2		28.750	33.100	1.5	1.5	2.0	6.500	8.300	0.000	1.350
OPERATING ENGINEER		ALL 1		32.100	33.100	1.5	1.5	2.0	6.500	8.300	0.000	1.350
OPERATING ENGINEER		ALL 2		30.200	33.100	1.5	1.5	2.0	6.500	8.300	0.000	1.350
OPERATING ENGINEER		ALL 3		24.150	33.100	1.5	1.5	2.0	6.500	8.300	0.000	1.350
OPERATING ENGINEER		ALL 4		21.400	27.800	1.5	1.5	2.0	5.650	6.100	0.000	1.100
OPERATING ENGINEER		O&C 1		24.080	25.080	1.5	1.5	2.0	6.500	8.300	0.000	1.350
OPERATING ENGINEER		O&C 2		22.650	25.080	1.5	1.5	2.0	6.500	8.300	0.000	1.350
OPERATING ENGINEER		O&C 3		18.120	25.080	1.5	1.5	2.0	6.500	8.300	0.000	1.350
OPERATING ENGINEER		O&C 4		16.050	21.100	1.5	1.5	2.0	5.650	6.100	0.000	1.100
PAINTER		BLD		26.260	27.760	1.5	1.5	2.0	6.130	6.950	0.000	0.450
PAINTER		HWY		30.560	32.060	1.5	1.5	2.0	6.130	6.950	0.000	0.450
PAINTER OVER 30FT		BLD		27.260	28.760	1.5	1.5	2.0	6.130	6.950	0.000	0.450
PAINTER PWR EQMT		BLD		27.260	28.760	1.5	1.5	2.0	6.130	6.950	0.000	0.450
PAINTER PWR EQMT		HWY		31.560	33.060	1.5	1.5	2.0	6.130	6.950	0.000	0.450
PILEDRIVER		BLD		30.490	31.990	1.5	1.5	2.0	6.050	5.750	0.000	0.350
PILEDRIVER		HWY		30.440	31.940	1.5	1.5	2.0	6.050	5.750	0.000	0.350
PIPEFITTER		BLD		32.250	35.470	1.5	1.5	2.0	8.250	8.850	0.000	1.200
PLASTERER		BLD		26.750	28.250	1.5	1.5	2.0	5.900	4.800	0.000	0.300
PLUMBER		BLD		32.250	35.470	1.5	1.5	2.0	8.250	8.850	0.000	1.200
ROOFER		BLD		26.340	28.340	1.5	1.5	2.0	6.280	4.750	0.000	0.360
SHEETMETAL WORKER		ALL		31.390	32.890	1.5	1.5	2.0	6.430	6.490	1.890	0.360
SPRINKLER FITTER		BLD		36.140	38.890	1.5	1.5	2.0	8.100	8.200	0.000	0.350
STONE MASON		BLD		27.220	28.720	1.5	1.5	2.0	7.950	6.690	0.000	0.430
TERRAZZO FINISHER		BLD		25.720	0.000	1.5	1.5	2.0	7.950	6.690	0.000	0.430
TRUCK DRIVER		ALL 1		28.430	0.000	1.5	1.5	2.0	9.050	5.500	0.000	0.250
TRUCK DRIVER		ALL 2		28.850	0.000	1.5	1.5	2.0	9.050	5.500	0.000	0.250
TRUCK DRIVER		ALL 3		29.050	0.000	1.5	1.5	2.0	9.050	5.500	0.000	0.250
TRUCK DRIVER		ALL 4		29.320	0.000	1.5	1.5	2.0	9.050	5.500	0.000	0.250
TRUCK DRIVER		ALL 5		30.100	0.000	1.5	1.5	2.0	9.050	5.500	0.000	0.250
TRUCK DRIVER		O&C 1		22.750	0.000	1.5	1.5	2.0	2.920	6.700	0.000	0.250
TRUCK DRIVER		O&C 2		19.150	0.000	1.5	1.5	2.0	2.920	6.700	0.000	0.250
TRUCK DRIVER		O&C 3		19.650	0.000	1.5	1.5	2.0	2.920	6.700	0.000	0.250
TUCKPOINTER		BLD		27.220	28.720	1.5	1.5	2.0	7.950	6.690	0.000	0.430

Legend :

M-F>8 (Overtime is required for any hour greater than 8 worked each day, Monday through Friday.)

OSA (Overtime is required for every hour worked on Saturday)

OSH (Overtime is required for every hour worked on Sunday and Holidays)

H/W (Health & Welfare Insurance)

Pensn (Pension)

Vac (Vacation)

Trng (Training)

## Explanations

### GALLATIN COUNTY

The following list is considered as those days for which holiday rates of wages for work performed apply: New Years Day, Memorial Day, Fourth of July, Labor Day, Thanksgiving Day, Christmas Day and Veterans Day in some classifications/counties. Generally, any of these holidays which fall on a Sunday is celebrated on the following Monday. This then makes work performed on that Monday payable at the appropriate overtime rate for holiday pay. Common practice in a given local may alter certain days of celebration. If in doubt, please check with IDOL.

Oil and chip resealing (O&C) means the application of road oils and liquid asphalt to coat an existing road surface, followed by application of aggregate chips or gravel to coated surface, and subsequent rolling of material to seal the surface.

### EXPLANATION OF CLASSES

ASBESTOS - GENERAL - removal of asbestos material/mold and hazardous materials from any place in a building, including mechanical systems where those mechanical systems are to be removed. This includes the removal of asbestos materials/mold and hazardous materials from ductwork or pipes in a building when the building is to be demolished at the time or at some close future date.

ASBESTOS - MECHANICAL - removal of asbestos material from mechanical systems, such as pipes, ducts, and boilers, where the mechanical systems are to remain.

### LABORER - OIL AND CHIP RESEALING ONLY

Hook and unhook chip box from aggregate truck; distribute material within chip box; perform flagging work related to oil and chip resealing; hand spray oil fluids; handle traffic control, including setting-up and maintaining barricades, drums, cones, delineators, signs and other such items, as well as laying-out and applying or removing temporary roadway markings used to control traffic in job site related to oil and chip resealing; and perform clean-up related to oil and chip resealing.

CERAMIC TILE FINISHER, MARBLE FINISHER, TERRAZZO FINISHER

Assisting, helping or supporting the tile, marble and terrazzo mechanic by performing their historic and traditional work assignments required to complete the proper installation of the work covered by said crafts. The term "Ceramic" is used for naming the classification only, and is in no a limitation of the product handled. Ceramic takes into consideration most hard tiles.

ELECTRONIC SYSTEMS TECHNICIAN

Installation, service and maintenance of low-voltage systems which utilizes the transmission and/or transference of voice, sound, vision, or digital for commercial, education, security and entertainment purposes for the following: TV monitoring and surveillance, background/foreground music, intercom and telephone interconnect, field programming, inventory control systems, microwave transmission, multi-media, multiplex, radio page, school, intercom and sound burglar alarms and low voltage master clock systems.

Excluded from this classification are energy management systems, life safety systems, supervisory controls and data acquisition systems not intrinsic with the above listed systems, fire alarm systems, nurse call systems and raceways exceeding fifteen feet in length.

TRUCK DRIVER - BUILDING, HEAVY AND HIGHWAY CONSTRUCTION

Class 1. Drivers on 2 axle trucks hauling less than 9 ton. Air compressor and welding machines and brooms, including those pulled by separate units, truck driver helpers, warehouse employees, mechanic helpers, greasers and tiremen, pickup trucks when hauling materials, tools, or workers to and from and on-the-job site, and fork lifts up to 6,000 lb. capacity.

Class 2. Two or three axle trucks hauling more than 9 ton but hauling less than 16 ton. A-frame winch trucks, hydrolift trucks, vector trucks or similar equipment when used for transportation purposes. Fork lifts over 6,000 lb. capacity, winch trucks, four axle combination units, and ticket writers.

Class 3. Two, three or four axle trucks hauling 16 ton or more. Drivers on water pulls, articulated dump trucks, mechanics and working forepersons, and dispatchers. Five axle or more combination units.

Class 4. Low Boy and Oil Distributors.

Class 5. Drivers who require special protective clothing while employed on hazardous waste work.

TRUCK DRIVER - O & C (Oil and Chip Resealing ONLY)

It involves driving of contractor or subcontractor owned, leased, or hired pickup, dump, service, or oil distributor trucks. Includes transporting materials and equipment (including, but not limited to oils, aggregate supplies, parts, machinery and tools) to or from the job site; distributing oil or liquid asphalt and aggregate; stock piling material; and maintaining trucks at job site related to oil and chip resealing.

Class 1. Distributors, liquid asphalt hauling and hauling of asphalt rubber-tired rollers.

Class 2. Stockpiling.

Class 3. Tandem hauling to job site.

OPERATING ENGINEERS - BUILDING, HEAVY AND HIGHWAY CONSTRUCTION

Class 1. APSCO or Equal Spreading Machine, Backhoe, Backfiller, Boom or Winch Cat, Bituminous Mixplane Machine, Blacksmith, Bituminous Surfacing Machine, Bull-Dozer, Crane, Shovel, Dragline, Truck Crane, Pile Driver, Concrete Breaker, Concrete or Pumpcrete Pumps, Dinky or Standard Locomotives, Well or Caisson Drills, Elevating Grader, Fork Lifts, Flexplane, Gradeall, Hi-Lift Hoists, Guy-Derricks, Hysters, Mechanic Motor Patrol, Mixers-21 cu. ft. or over, Push Cats, Pulls and Scrapers, Two Well Point Pumps, Pulverizer or Tiller, PugMill, Rubber-Tired Farm Type Tractor with Bulldozer/Blade/Auger or hi-lift over 1/2 yd., Jersey Spreader, Tract-Air used with Drill or Hi-Lift, Trenching or Ditching Machines, Wood Chipper w/Tractor, Self-Propelled Roller w/Blade, Equipment Greaser, Self-Propelled Bump Grinder on Concrete pavement, Boat Operator, Skid-Loaders, Tuggers, Lazer Screed, and Self-Propelled Chip Spreader (when others run conveyors).

Class 2. Any type tractor pulling any type roller or disc, Two Air Compressors (220 cu. ft. capacity or over), Two AirTract Drills, Air-Track Drill w/Compressor, Automatic Bins or Scales w/Compressor or Generator, Pipeline Boring Machine, Bulk Cement Plant w/Separate Compressor, Power Operated Bull Float, Hydra-Lift w/Single Motor, Straw Mulcher Blower w/Spout, Self-Propelled Roller/Compactor, Back-End man on Bituminous Surfacing Machine, oiler on milling machine.

Class 3. Air Compressor w/Valve driving piling, Boom or Winch Type Truck, Two Conveyors, Self-Propelled Concrete Saw, Form Grader, Truck Crane Oiler, Self-Propelled Vibrator, Rubber Tired Farm Type Tractor w/Blade/Bulldozer/Auger/hi-lift - 1/2 yd. or less, Elevator Operator, Man Lift (scissor lift) when lifting materials.

Class 4. Air-Track Drill (one), Belt Drag Machine, Power Broom, Mechanical Plasterer Applicator, Trac-Air, Air Compressor (220 cu. ft. or over) One, Air Compressor (under 220 cu. ft) four, Automatic Bin, Bulk Cement Plant w/Built-in Compressor running off same motor or electric motor, Fireman or Switchman, Self-Propelled Form Tamper, Light Plants (4), Welding Machines (4), Pumps (4), or Combination of four (4) Pumps, Light Plants, Welding Machines, Air-Compressors (under 220 cu. ft.), Mudjacks or Wood Chipper, Mixers - less than 21 cu. ft. Mortar Mixer w/Skip or Pump, Pipeline Tract Jack. One Operating Engineer may operate and maintain any combination of the following pieces of equipment, not to exceed four (4) which shall be within a reasonable distance, such combination may include any equipment in this classification: (Compressors, Light Plants, Generators, Welding Machines, Pumps or Conveyors), One Well- Point Pump, Two Motor Driven Heaters, One Air Compressor (under 220 cu. ft.), One Engine-Driven Conveyor, One Motor Driven Heater, One Light Plant, One Pump, One Welding Machine, One Ulmac or Equal Spreader, Oilers, and one Generator 10 kw or greater.

OPERATING ENGINEER - O & C (Oil and Chip Resealing ONLY). Includes the operation of all motorized heavy equipment used in oil and chip rsealing, including but not limited to operating self-propelled chip spreaders, and all types of rollers (both hard and rubber tired); and other duties pertaining to the operation or maintenance of heavy equipment relatd to oil and chip resealing.

Class 1. See Class 1 above for types of equipment operated.

Class 2. See Class 2 above for types of equipment operated.

Class 3. See Class 3 above for types of equipment operated.

Class 4. See Class 4 above for types of equipment operated.

OPERATING ENGINEER RIVER WORK 1 - operate the following machines when working on River Work and Levee Work on the Mississippi and Ohio Rivers, Lakes and Tributaries: Crane, Shovel, Drageline, Scrapers, Dredge, Derrick, Pile-Driver, Push Boat, all power boat operators, Mechanic, Engineman on Dredge, Leverman on Dredge, All Bituminous Spreader machines, Backhoe, Backfiller, Boom, or Winch Cat, Bituminous Mixplane Machine, Blacksmith, Bituminous Surfacing Machine, Bulldozer, Truck Cranes, Hydraulic Truck Mounted Boom/Crane, Concrete Finishing Machine, or Spreader Machine, Concrete Breaker, Concrete or Pumpcrete Machines, Concrete Plant Operator, All Off Road Material Hauling Equipment, Dinky or Standard Locomotives, Well Drill, Elevating Grader, Fork-Lifts, Flexplane, Gradeall, Hi-Lift, Power Handblade Tugger type Hoist, Hoist Two Drum (or over one), Gyderrick, Hyster, Motor Patrol, Mixers - 21 Cu. Ft. or over, Push Cat, Pulls, & Scrapers, Pumps-Two Well Points, Equipment Greaser, P & H Pulverizer or Pulverizer equal to Pugmill, Pugmill, Rubber-Tired farm type tractor w/Bulldozer/Blade/Auger or Hi-Lift over ½ yard, Skimmer Scoops, Seaman Tiller, Jersey Spreader, Tract-Air used with Drill or Hi-Lift, Trenching or Ditching Machine, Wood Chipper w/Tractor, self-propelled roller w/Blade, Concrete Pumps and Small Equipment Operators.

OPERATING ENGINEER RIVER 2 - when working on River Work and Levee Work on the Mississippi and Ohio Rivers, Lakes and Tributaries shall be employed as the Oiler or Fireman on Crane, Dragline, Shovel, Dredge, Truck Crane, Pile Driver, Gradeall, Dinky or Standard Locomotive, Guy Derrick, Trenching Machine or Ditching Machine 80 H.P. and over, All Terrain (cherry-picker) with over 40 ton Lifting Capacity, Deck Oiler and Deckhands.

Other Classifications of Work:

For definitions of classifications not otherwise set out, the Department generally has on file such definitions which are available. If a task to be performed is not subject to one of the classifications of pay set out, the Department will upon being contacted state which neighboring county has such a classification and provide such rate, such rate being deemed to exist by reference in this document. If no neighboring county rate applies to the task, the Department shall undertake a special determination, such special determination being then deemed to have existed under this determination. If a project requires these, or any classification not listed, please contact IDOL at 217-782-1710 for wage rates or clarifications.

#### LANDSCAPING

Landscaping work falls under the existing classifications for laborer, operating engineer and truck driver. The work performed by landscape plantsman and landscape laborer is covered by the existing classification of laborer. The work performed by landscape operators (regardless of equipment used or its size) is covered by the classifications of operating engineer. The work performed by landscape truck drivers (regardless of size of truck driven) is covered by the classifications of truck driver.

# Hamilton County Prevailing Wage for May 2011

Trade Name	RG	TYP	C	Base	FRMAN	*M-F>8	OSA	OSH	H/W	Pensn	Vac	Trng
=====	==	===	=	=====	=====	=====	===	===	=====	=====	=====	=====
ASBESTOS ABT-GEN		ALL		24.400	24.850	1.5	1.5	2.0	5.550	9.450	0.000	0.900
ASBESTOS ABT-MEC		BLD		20.800	0.000	2.0	2.0	2.0	5.500	4.200	0.000	0.000
BOILERMAKER		BLD		31.500	34.000	1.5	1.5	2.0	6.820	11.43	1.500	0.350
BRICK MASON		BLD		27.220	28.720	1.5	1.5	2.0	7.950	6.690	0.000	0.430
CARPENTER		BLD		30.490	31.990	1.5	1.5	2.0	6.050	5.750	0.000	0.350
CARPENTER		HWY		30.440	32.190	1.5	1.5	2.0	6.050	5.750	0.000	0.350
CEMENT MASON		BLD		26.750	28.250	1.5	1.5	2.0	5.900	4.800	0.000	0.300
CEMENT MASON		HWY		25.580	27.080	1.5	1.5	2.0	5.900	5.000	0.000	0.300
CERAMIC TILE FNSHER		BLD		25.720	0.000	1.5	1.5	2.0	7.950	6.690	0.000	0.430
ELECTRICIAN		ALL		36.830	39.080	1.5	1.5	2.0	5.350	8.470	0.000	0.730
ELECTRONIC SYS TECH		BLD		29.530	31.280	1.5	1.5	2.0	5.250	3.840	0.000	0.250
FLOOR LAYER		BLD		28.930	29.680	1.5	1.5	2.0	6.050	5.750	0.000	0.350
GLAZIER		BLD		26.330	27.580	1.5	1.5	2.0	4.850	5.200	0.000	0.300
HT/FROST INSULATOR		BLD		28.920	29.920	1.5	1.5	2.0	4.800	8.160	0.000	0.280
IRON WORKER		ALL		27.020	28.270	1.5	1.5	2.0	5.760	9.600	0.000	0.345
LABORER		BLD		24.400	24.850	1.5	1.5	2.0	5.550	9.450	0.000	0.800
LABORER		HWY		24.400	24.850	1.5	1.5	2.0	5.550	9.450	0.000	0.800
LABORER		O&C		17.740	18.190	1.5	1.5	2.0	5.450	8.450	0.000	0.800
MACHINIST		BLD		43.160	45.160	1.5	1.5	2.0	7.640	8.700	0.000	0.000
MARBLE FINISHERS		BLD		25.720	0.000	1.5	1.5	2.0	7.950	6.690	0.000	0.430
MARBLE MASON		BLD		27.220	28.720	1.5	1.5	2.0	7.950	6.690	0.000	0.430
MILLWRIGHT		BLD		30.490	31.990	1.5	1.5	2.0	6.050	5.750	0.000	0.350
MILLWRIGHT		HWY		30.940	32.690	1.5	1.5	2.0	6.050	5.750	0.000	0.350
OE RIVER 1		RIV 1		32.100	33.100	1.5	1.5	2.0	6.500	8.300	0.000	1.350
OE RIVER 2		RIV 2		28.750	33.100	1.5	1.5	2.0	6.500	8.300	0.000	1.350
OPERATING ENGINEER		ALL 1		32.100	33.100	1.5	1.5	2.0	6.500	8.300	0.000	1.350
OPERATING ENGINEER		ALL 2		30.200	33.100	1.5	1.5	2.0	6.500	8.300	0.000	1.350
OPERATING ENGINEER		ALL 3		24.150	33.100	1.5	1.5	2.0	6.500	8.300	0.000	1.350
OPERATING ENGINEER		ALL 4		21.400	27.800	1.5	1.5	2.0	5.650	6.100	0.000	1.100
OPERATING ENGINEER		O&C 1		24.080	25.080	1.5	1.5	2.0	6.500	8.300	0.000	1.350
OPERATING ENGINEER		O&C 2		22.650	25.080	1.5	1.5	2.0	6.500	8.300	0.000	1.350
OPERATING ENGINEER		O&C 3		18.120	25.080	1.5	1.5	2.0	6.500	8.300	0.000	1.350
OPERATING ENGINEER		O&C 4		16.050	21.100	1.5	1.5	2.0	5.650	6.100	0.000	1.100
PAINTER		ALL		23.020	23.520	1.5	1.5	2.0	4.950	6.800	0.000	0.430
PAINTER OVER 30FT		ALL		26.120	26.620	1.5	1.5	2.0	4.950	6.800	0.000	0.430
PAINTER PWR EQMT		ALL		26.120	26.620	1.5	1.5	2.0	4.950	6.800	0.000	0.430
PILEDRIVER		BLD		30.490	31.990	1.5	1.5	2.0	6.050	5.750	0.000	0.350
PILEDRIVER		HWY		30.940	32.690	1.5	1.5	2.0	6.050	5.750	0.000	0.350
PIPEFITTER		BLD		32.250	35.470	1.5	1.5	2.0	8.250	8.850	0.000	1.200
PLASTERER		BLD		26.750	28.250	1.5	1.5	2.0	5.900	4.800	0.000	0.300
PLUMBER		BLD		32.250	35.470	1.5	1.5	2.0	8.250	8.850	0.000	1.200
ROOFER		BLD		22.250	23.250	1.5	1.5	2.0	7.900	3.800	0.000	0.000
SHEETMETAL WORKER		ALL		31.390	32.890	1.5	1.5	2.0	6.430	6.490	1.890	0.360
SPRINKLER FITTER		BLD		36.140	38.890	1.5	1.5	2.0	8.100	8.200	0.000	0.350
STONE MASON		BLD		27.220	28.720	1.5	1.5	2.0	7.950	6.690	0.000	0.430
TERRAZZO FINISHER		BLD		25.720	0.000	1.5	1.5	2.0	7.950	6.690	0.000	0.430
TERRAZZO MASON		BLD		28.500	28.800	1.5	1.5	2.0	6.400	5.700	0.000	0.430
TRUCK DRIVER		ALL 1		28.430	0.000	1.5	1.5	2.0	9.050	5.500	0.000	0.250
TRUCK DRIVER		ALL 2		28.850	0.000	1.5	1.5	2.0	9.050	5.500	0.000	0.250
TRUCK DRIVER		ALL 3		29.050	0.000	1.5	1.5	2.0	9.050	5.500	0.000	0.250
TRUCK DRIVER		ALL 4		29.320	0.000	1.5	1.5	2.0	9.050	5.500	0.000	0.250
TRUCK DRIVER		ALL 5		30.100	0.000	1.5	1.5	2.0	9.050	5.500	0.000	0.250
TRUCK DRIVER		O&C 1		22.750	0.000	1.5	1.5	2.0	2.920	6.700	0.000	0.250
TRUCK DRIVER		O&C 2		19.150	0.000	1.5	1.5	2.0	2.920	6.700	0.000	0.250
TRUCK DRIVER		O&C 3		19.650	0.000	1.5	1.5	2.0	2.920	6.700	0.000	0.250
TUCKPOINTER		BLD		27.220	28.720	1.5	1.5	2.0	7.950	6.690	0.000	0.430

Legend:

M-F>8 (Overtime is required for any hour greater than 8 worked each day, Monday through Friday.)

OSA (Overtime is required for every hour worked on Saturday)

OSH (Overtime is required for every hour worked on Sunday and Holidays)

H/W (Health & Welfare Insurance)

Pensn (Pension)

Vac (Vacation)

Trng (Training)

## Explanations

### HAMILTON COUNTY

The following list is considered as those days for which holiday rates of wages for work performed apply: New Years Day, Memorial Day, Fourth of July, Labor Day, Thanksgiving Day, Christmas Day and Veterans Day in some classifications/counties. Generally, any of these holidays which fall on a Sunday is celebrated on the following Monday. This then makes work performed on that Monday payable at the appropriate overtime rate for holiday pay. Common practice in a given local may alter certain days of celebration. If in doubt, please check with IDOL.

Oil and chip resealing (O&C) means the application of road oils and liquid asphalt to coat an existing road surface, followed by application of aggregate chips or gravel to coated surface, and subsequent rolling of material to seal the surface.

### EXPLANATION OF CLASSES

ASBESTOS - GENERAL - removal of asbestos material/mold and hazardous materials from any place in a building, including mechanical systems where those mechanical systems are to be removed. This includes the removal of asbestos materials/mold and hazardous materials from ductwork or pipes in a building when the building is to be demolished at the time or at some close future date.

ASBESTOS - MECHANICAL - removal of asbestos material from mechanical systems, such as pipes, ducts, and boilers, where the mechanical systems are to remain.

### CERAMIC TILE FINISHER, MARBLE FINISHER, TERRAZZO FINISHER

Assisting, helping or supporting the tile, marble and terrazzo mechanic by performing their historic and traditional work assignments required to complete the proper installation of the work covered by said crafts. The term "Ceramic" is used for naming the classification only, and is in no a limitation of the product handled. Ceramic takes into consideration most hard tiles.

### LABORER - OIL AND CHIP RESEALING ONLY

Hook and unhook chip box from aggregate truck; distribute material

within chip box; perform flagging work related to oil and chip resealing; hand spray oil fluids; handle traffic control, including setting-up and maintaining barricades, drums, cones, delineators, signs and other such items, as well as laying-out and applying or removing temporary roadway markings used to control traffic in job site related to oil and chip resealing; and perform clean-up related to oil and chip resealing.

#### ELECTRONIC SYSTEMS TECHNICIAN

Installation, service and maintenance of low-voltage systems which utilizes the transmission and/or transference of voice, sound, vision, or digital for commercial, education, security and entertainment purposes for the following: TV monitoring and surveillance, background/foreground music, intercom and telephone interconnect, field programming, inventory control systems, microwave transmission, multi-media, multiplex, radio page, school, intercom and sound burglar alarms and low voltage master clock systems.

Excluded from this classification are energy management systems, life safety systems, supervisory controls and data acquisition systems not intrinsic with the above listed systems, fire alarm systems, nurse call systems and raceways exceeding fifteen feet in length.

#### TRUCK DRIVER - BUILDING, HEAVY AND HIGHWAY CONSTRUCTION

Class 1. Drivers on 2 axle trucks hauling less than 9 ton. Air compressor and welding machines and brooms, including those pulled by separate units, truck driver helpers, warehouse employees, mechanic helpers, greasers and tiremen, pickup trucks when hauling materials, tools, or workers to and from and on-the-job site, and fork lifts up to 6,000 lb. capacity.

Class 2. Two or three axle trucks hauling more than 9 ton but hauling less than 16 ton. A-frame winch trucks, hydrolift trucks, vector trucks or similar equipment when used for transportation purposes. Fork lifts over 6,000 lb. capacity, winch trucks, four axle combination units, and ticket writers.

Class 3. Two, three or four axle trucks hauling 16 ton or more. Drivers on water pulls, articulated dump trucks, mechanics and working forepersons, and dispatchers. Five axle or more combination units.

Class 4. Low Boy and Oil Distributors.

Class 5. Drivers who require special protective clothing while employed on hazardous waste work.

#### TRUCK DRIVER - O & C (Oil and Chip Resealing ONLY)

It involves driving of contractor or subcontractor owned, leased, or hired pickup, dump, service, or oil distributor trucks. Includes transporting materials and equipment (including, but not limited to oils, aggregate supplies, parts, machinery and tools) to or from the job site; distributing oil or liquid asphalt and aggregate; stock piling material; and maintaining trucks at job site related to oil and chip resealing.

Class 1. Distributors, liquid asphalt hauling and hauling of asphalt rubber-tired rollers.

Class 2. Stockpiling.

Class 3. Tandem hauling to job site.



OPERATING ENGINEERS - BUILDING, HEAVY AND HIGHWAY CONSTRUCTION

Class 1. APSCO or Equal Spreading Machine, Backhoe, Backfiller, Boom or Winch Cat, Bituminous Mixplane Machine, Blacksmith, Bituminous Surfacing Machine, Bull-Dozer, Crane, Shovel, Dragline, Truck Crane, Pile Driver, Concrete Breaker, Concrete or Pumpcrete Pumps, Dinky or Standard Locomotives, Well or Caisson Drills, Elevating Grader, Fork Lifts, Flexplane, Gradeall, Hi-Lift Hoists, Guy-Derricks, Hysters, Mechanic Motor Patrol, Mixers-21 cu. ft. or over, Push Cats, Pulls and Scrapers, Two Well Point Pumps, Pulverizer or Tiller, PugMill, Rubber-Tired Farm Type Tractor with Bulldozer/Blade/Auger or hi-lift over 1/2 yd., Jersey Spreader, Tract-Air used with Drill or Hi-Lift, Trenching or Ditching Machines, Wood Chipper w/Tractor, Self-Propelled Roller w/Blade, Equipment Greaser, Self-Propelled Bump Grinder on Concrete pavement, Boat Operator, Skid-Loaders, Tuggers, Lazer Screed, and Self-Propelled Chip Spreader (when others run conveyors).

Class 2. Any type tractor pulling any type roller or disc, Two Air Compressors (220 cu. ft. capacity or over), Two AirTract Drills, Air-Track Drill w/Compressor, Automatic Bins or Scales w/Compressor or Generator, Pipeline Boring Machine, Bulk Cement Plant w/Separate Compressor, Power Operated Bull Float, Hydra-Lift w/Single Motor, Straw Mulcher Blower w/Spout, Self-Propelled Roller/Compactor, Back-End man on Bituminous Surfacing Machine, oiler on milling machine.

Class 3. Air Compressor w/Valve driving piling, Boom or Winch Type Truck, Two Conveyors, Self-Propelled Concrete Saw, Form Grader, Truck Crane Oiler, Self-Propelled Vibrator, Rubber Tired Farm Type Tractor w/Blade/Bulldozer/Auger/hi-lift - 1/2 yd. or less, Elevator Operator, Man Lift (scissor lift) when lifting materials.

Class 4. Air-Track Drill (one), Belt Drag Machine, Power Broom, Mechanical Plasterer Applicator, Trac-Air, Air Compressor (220 cu. ft. or over) One, Air Compressor (under 220 cu. ft) four, Automatic Bin, Bulk Cement Plant w/Built-in Compressor running off same motor or electric motor, Fireman or Switchman, Self-Propelled Form Tamper, Light Plants (4), Welding Machines (4), Pumps (4), or Combination of four (4) Pumps, Light Plants, Welding Machines, Air-Compressors (under 220 cu. ft.), Mudjacks or Wood Chipper, Mixers - less than 21 cu. ft. Mortar Mixer w/Skip or Pump, Pipeline Tract Jack. One Operating Engineer may operate and maintain any combination of the following pieces of equipment, not to exceed four (4) which shall be within a reasonable distance, such combination may include any equipment in this classification: (Compressors, Light Plants, Generators, Welding Machines, Pumps or Conveyors), One Well- Point Pump, Two Motor Driven Heaters, One Air Compressor (under 220 cu. ft.), One Engine-Driven Conveyor, One Motor Driven Heater, One Light Plant, One Pump, One Welding Machine, One Ulmac or Equal Spreader, Oilers, and one Generator 10 kw or greater.

OPERATING ENGINEER - O & C (Oil and Chip Resealing ONLY). Includes the operation of all motorized heavy equipment used in oil and chip rsealing, including but not limited to operating self-propelled chip spreaders, and all types of rollers (both hard and rubber tired); and other duties pertaining to the operation or maintenance of heavy equipment relatd to oil and chip resealing.

Class 1. See Class 1 above for types of equipment operated.

Class 2. See Class 2 above for types of equipment operated.

Class 3. See Class 3 above for types of equipment operated.

Class 4. See Class 4 above for types of equipment operated.

OPERATING ENGINEER RIVER WORK 1 - operate the following machines when working on River Work and Levee Work on the Mississippi and Ohio Rivers, Lakes and Tributaries: Crane, Shovel, Drageline, Scrapers, Dredge, Derrick, Pile-Driver, Push Boat, all power boat operators, Mechanic, Engineman on Dredge, Leverman on Dredge, All Bituminous Spreader machines, Backhoe, Backfiller, Boom, or Winch Cat, Bituminous Mixplane Machine, Blacksmith, Bituminous Surfacing Machine, Bulldozer, Truck Cranes, Hydraulic Truck Mounted Boom/Crane, Concrete Finishing Machine, or Spreader Machine, Concrete Breaker, Concrete or Pumpcrete Machines, Concrete Plant Operator, All Off Road Material Hauling Equipment, Dinky or Standard Locomotives, Well Drill, Elevating Grader, Fork-Lifts, Flexplane, Gradeall, Hi-Lift, Power Handblade Tugger type Hoist, Hoist Two Drum (or over one), Gyderrick, Hyster, Motor Patrol, Mixers - 21 Cu. Ft. or over, Push Cat, Pulls, & Scrapers, Pumps-Two Well Points, Equipment Greaser, P & H Pulverizer or Pulverizer equal to Pugmill, Pugmill, Rubber-Tired farm type tractor w/Bulldozer/Blade/Auger or Hi-Lift over ½ yard, Skimmer Scoops, Seaman Tiller, Jersey Spreader, Tract-Air used with Drill or Hi-Lift, Trenching or Ditching Machine, Wood Chipper w/Tractor, self-propelled roller w/Blade, Concrete Pumps and Small Equipment Operators.

OPERATING ENGINEER RIVER 2 - when working on River Work and Levee Work on the Mississippi and Ohio Rivers, Lakes and Tributaries shall be employed as the Oiler or Fireman on Crane, Dragline, Shovel, Dredge, Truck Crane, Pile Driver, Gradeall, Dinky or Standard Locomotive, Guy Derrick, Trenching Machine or Ditching Machine 80 H.P. and over, All Terrain (cherry-picker) with over 40 ton Lifting Capacity, Deck Oiler and Deckhands.

#### Other Classifications of Work:

For definitions of classifications not otherwise set out, the Department generally has on file such definitions which are available. If a task to be performed is not subject to one of the classifications of pay set out, the Department will upon being contacted state which neighboring county has such a classification and provide such rate, such rate being deemed to exist by reference in this document. If no neighboring county rate applies to the task, the Department shall undertake a special determination, such special determination being then deemed to have existed under this determination. If a project requires these, or any classification not listed, please contact IDOL at 217-782-1710 for wage rates or clarifications.

#### LANDSCAPING

Landscaping work falls under the existing classifications for laborer, operating engineer and truck driver. The work performed by landscape plantsman and landscape laborer is covered by the existing classification of laborer. The work performed by landscape operators (regardless of equipment used or its size) is covered by the classifications of operating engineer. The work performed by landscape truck drivers (regardless of size of truck driven) is covered by the classifications of truck driver.

# Hardin County Prevailing Wage for May 2011

Trade Name	RG	TYP	C	Base	FRMAN	*M-F>8	OSA	OSH	H/W	Pensn	Vac	Trng
=====	==	===	=	=====	=====	=====	===	===	=====	=====	=====	=====
ASBESTOS ABT-GEN		ALL		24.400	24.850	1.5	1.5	2.0	5.550	9.450	0.000	0.900
ASBESTOS ABT-MEC		BLD		20.800	0.000	2.0	2.0	2.0	5.500	4.200	0.000	0.000
BOILERMAKER		BLD		31.500	34.000	1.5	1.5	2.0	6.820	11.43	1.500	0.350
BRICK MASON		BLD		27.220	28.720	1.5	1.5	2.0	7.950	6.690	0.000	0.430
CARPENTER		BLD		30.490	31.990	1.5	1.5	2.0	6.050	5.750	0.000	0.350
CARPENTER		HWY		30.440	31.940	1.5	1.5	2.0	6.050	5.750	0.000	0.350
CEMENT MASON		BLD		26.750	28.250	1.5	1.5	2.0	5.900	4.800	0.000	0.300
CEMENT MASON		HWY		26.350	27.350	1.5	1.5	2.0	5.900	4.350	0.000	0.300
CERAMIC TILE FNSHER		BLD		25.720	0.000	1.5	1.5	2.0	7.950	6.690	0.000	0.430
ELECTRICIAN		ALL		36.830	39.080	1.5	1.5	2.0	5.350	8.470	0.000	0.730
ELECTRONIC SYS TECH		BLD		29.530	31.280	1.5	1.5	2.0	5.250	3.840	0.000	0.250
FLOOR LAYER		BLD		28.930	29.680	1.5	1.5	2.0	6.050	5.750	0.000	0.350
GLAZIER		BLD		26.330	27.580	1.5	1.5	2.0	4.850	5.200	0.000	0.300
HT/FROST INSULATOR		BLD		28.920	29.920	1.5	1.5	2.0	4.800	8.160	0.000	0.280
IRON WORKER		ALL		26.740	28.740	1.5	1.5	2.0	5.760	9.590	0.000	0.500
LABORER		BLD		24.400	24.850	1.5	1.5	2.0	5.550	9.450	0.000	0.800
LABORER		HWY		24.400	24.850	1.5	1.5	2.0	5.550	9.450	0.000	0.800
LABORER		O&C		17.740	18.190	1.5	1.5	2.0	5.450	8.450	0.000	0.800
MACHINIST		BLD		43.160	45.160	1.5	1.5	2.0	7.640	8.700	0.000	0.000
MARBLE FINISHERS		BLD		25.720	0.000	1.5	1.5	2.0	7.950	6.690	0.000	0.430
MARBLE MASON		BLD		27.220	28.720	1.5	1.5	2.0	7.950	6.690	0.000	0.430
MILLWRIGHT		BLD		30.490	31.990	1.5	1.5	2.0	6.050	5.750	0.000	0.350
MILLWRIGHT		HWY		30.440	31.940	1.5	1.5	2.0	6.050	5.750	0.000	0.350
OE RIVER 1		RIV 1		32.100	33.100	1.5	1.5	2.0	6.500	8.300	0.000	1.350
OE RIVER 2		RIV 2		28.750	33.100	1.5	1.5	2.0	6.500	8.300	0.000	1.350
OPERATING ENGINEER		ALL 1		32.100	33.100	1.5	1.5	2.0	6.500	8.300	0.000	1.350
OPERATING ENGINEER		ALL 2		30.200	33.100	1.5	1.5	2.0	6.500	8.300	0.000	1.350
OPERATING ENGINEER		ALL 3		24.150	33.100	1.5	1.5	2.0	6.500	8.300	0.000	1.350
OPERATING ENGINEER		ALL 4		21.400	27.800	1.5	1.5	2.0	5.650	6.100	0.000	1.100
OPERATING ENGINEER		O&C 1		24.080	25.080	1.5	1.5	2.0	6.500	8.300	0.000	1.350
OPERATING ENGINEER		O&C 2		22.650	25.080	1.5	1.5	2.0	6.500	8.300	0.000	1.350
OPERATING ENGINEER		O&C 3		18.120	25.080	1.5	1.5	2.0	6.500	8.300	0.000	1.350
OPERATING ENGINEER		O&C 4		16.050	21.100	1.5	1.5	2.0	5.650	6.100	0.000	1.100
PAINTER		BLD		26.260	27.760	1.5	1.5	2.0	6.130	6.950	0.000	0.450
PAINTER		HWY		30.560	32.060	1.5	1.5	2.0	6.130	6.950	0.000	0.450
PAINTER OVER 30FT		BLD		27.260	28.760	1.5	1.5	2.0	6.130	6.950	0.000	0.450
PAINTER PWR EQMT		BLD		27.260	28.760	1.5	1.5	2.0	6.130	6.950	0.000	0.450
PAINTER PWR EQMT		HWY		31.560	33.060	1.5	1.5	2.0	6.130	6.950	0.000	0.450
PILEDRIVER		BLD		30.490	31.990	1.5	1.5	2.0	6.050	5.750	0.000	0.350
PILEDRIVER		HWY		30.440	31.940	1.5	1.5	2.0	6.050	5.750	0.000	0.350
PIPEFITTER		BLD		38.050	41.850	1.5	2.0	2.0	7.600	5.500	0.000	1.100
PLASTERER		BLD		26.750	28.250	1.5	1.5	2.0	5.900	4.800	0.000	0.300
PLUMBER		BLD		38.050	41.850	1.5	2.0	2.0	7.600	5.500	0.000	1.100
ROOFER		BLD		26.340	28.340	1.5	1.5	2.0	6.280	4.750	0.000	0.360
SHEETMETAL WORKER		ALL		31.390	32.890	1.5	1.5	2.0	6.430	6.490	1.890	0.360
SPRINKLER FITTER		BLD		36.140	38.890	1.5	1.5	2.0	8.100	8.200	0.000	0.350
STONE MASON		BLD		27.220	28.720	1.5	1.5	2.0	7.950	6.690	0.000	0.430
TERRAZZO FINISHER		BLD		25.720	0.000	1.5	1.5	2.0	7.950	6.690	0.000	0.430
TRUCK DRIVER		ALL 1		28.430	0.000	1.5	1.5	2.0	9.050	5.500	0.000	0.250
TRUCK DRIVER		ALL 2		28.850	0.000	1.5	1.5	2.0	9.050	5.500	0.000	0.250
TRUCK DRIVER		ALL 3		29.050	0.000	1.5	1.5	2.0	9.050	5.500	0.000	0.250
TRUCK DRIVER		ALL 4		29.320	0.000	1.5	1.5	2.0	9.050	5.500	0.000	0.250
TRUCK DRIVER		ALL 5		30.100	0.000	1.5	1.5	2.0	9.050	5.500	0.000	0.250
TRUCK DRIVER		O&C 1		22.750	0.000	1.5	1.5	2.0	2.920	6.700	0.000	0.250
TRUCK DRIVER		O&C 2		19.150	0.000	1.5	1.5	2.0	2.920	6.700	0.000	0.250
TRUCK DRIVER		O&C 3		19.650	0.000	1.5	1.5	2.0	2.920	6.700	0.000	0.250
TUCKPOINTER		BLD		27.220	28.720	1.5	1.5	2.0	7.950	6.690	0.000	0.430

## Legend:

M-F>8 (Overtime is required for any hour greater than 8 worked each day, Monday through Friday.)

OSA (Overtime is required for every hour worked on Saturday)

OSH (Overtime is required for every hour worked on Sunday and Holidays)

H/W (Health & Welfare Insurance)

Pensn (Pension)

Vac (Vacation)

Trng (Training)

# Explanations

## HARDIN COUNTY

The following list is considered as those days for which holiday rates of wages for work performed apply: New Years Day, Memorial Day, Fourth of July, Labor Day, Thanksgiving Day, Christmas Day and Veterans Day in some classifications/counties. Generally, any of these holidays which fall on a Sunday is celebrated on the following Monday. This then makes work performed on that Monday payable at the appropriate overtime rate for holiday pay. Common practice in a given local may alter certain days of celebration. If in doubt, please check with IDOL.

Oil and chip resealing (O&C) means the application of road oils and liquid asphalt to coat an existing road surface, followed by application of aggregate chips or gravel to coated surface, and subsequent rolling of material to seal the surface.

## EXPLANATION OF CLASSES

ASBESTOS - GENERAL - removal of asbestos material/mold and hazardous materials from any place in a building, including mechanical systems where those mechanical systems are to be removed. This includes the removal of asbestos materials/mold and hazardous materials from ductwork or pipes in a building when the building is to be demolished at the time or at some close future date.

ASBESTOS - MECHANICAL - removal of asbestos material from mechanical systems, such as pipes, ducts, and boilers, where the mechanical systems are to remain.

## LABORER - OIL AND CHIP RESEALING ONLY

Hook and unhook chip box from aggregate truck; distribute material within chip box; perform flagging work related to oil and chip resealing; hand spray oil fluids; handle traffic control, including setting-up and maintaining barricades, drums, cones, delineators, signs and other such items, as well as laying-out and applying or removing temporary roadway markings used to control traffic in job site related to oil and chip resealing; and perform clean-up related to oil and chip resealing.

CERAMIC TILE FINISHER, MARBLE FINISHER, TERRAZZO FINISHER

Assisting, helping or supporting the tile, marble and terrazzo mechanic by performing their historic and traditional work assignments required to complete the proper installation of the work covered by said crafts. The term "Ceramic" is used for naming the classification only, and is in no a limitation of the product handled. Ceramic takes into consideration most hard tiles.

ELECTRONIC SYSTEMS TECHNICIAN

Installation, service and maintenance of low-voltage systems which utilizes the transmission and/or transference of voice, sound, vision, or digital for commercial, education, security and entertainment purposes for the following: TV monitoring and surveillance, background/foreground music, intercom and telephone interconnect, field programming, inventory control systems, microwave transmission, multi-media, multiplex, radio page, school, intercom and sound burglar alarms and low voltage master clock systems.

Excluded from this classification are energy management systems, life safety systems, supervisory controls and data acquisition systems not intrinsic with the above listed systems, fire alarm systems, nurse call systems and raceways exceeding fifteen feet in length.

TRUCK DRIVER - BUILDING, HEAVY AND HIGHWAY CONSTRUCTION

Class 1. Drivers on 2 axle trucks hauling less than 9 ton. Air compressor and welding machines and brooms, including those pulled by separate units, truck driver helpers, warehouse employees, mechanic helpers, greasers and tiremen, pickup trucks when hauling materials, tools, or workers to and from and on-the-job site, and fork lifts up to 6,000 lb. capacity.

Class 2. Two or three axle trucks hauling more than 9 ton but hauling less than 16 ton. A-frame winch trucks, hydrolift trucks, vector trucks or similar equipment when used for transportation purposes. Fork lifts over 6,000 lb. capacity, winch trucks, four axle combination units, and ticket writers.

Class 3. Two, three or four axle trucks hauling 16 ton or more. Drivers on water pulls, articulated dump trucks, mechanics and working forepersons, and dispatchers. Five axle or more combination units.

Class 4. Low Boy and Oil Distributors.

Class 5. Drivers who require special protective clothing while employed on hazardous waste work.

TRUCK DRIVER - O & C (Oil and Chip Resealing ONLY)

It involves driving of contractor or subcontractor owned, leased, or hired pickup, dump, service, or oil distributor trucks. Includes transporting materials and equipment (including, but not limited to oils, aggregate supplies, parts, machinery and tools) to or from the job site; distributing oil or liquid asphalt and aggregate; stock piling material; and maintaining trucks at job site related to oil and chip resealing.

Class 1. Distributors, liquid asphalt hauling and hauling of asphalt rubber-tired rollers.

Class 2. Stockpiling.

Class 3. Tandem hauling to job site.

OPERATING ENGINEERS - BUILDING, HEAVY AND HIGHWAY CONSTRUCTION

Class 1. APSCO or Equal Spreading Machine, Backhoe, Backfiller, Boom or Winch Cat, Bituminous Mixplane Machine, Blacksmith, Bituminous Surfacing Machine, Bull-Dozer, Crane, Shovel, Dragline, Truck Crane, Pile Driver, Concrete Breaker, Concrete or Pumpcrete Pumps, Dinky or Standard Locomotives, Well or Caisson Drills, Elevating Grader, Fork Lifts, Flexplane, Gradeall, Hi-Lift Hoists, Guy-Derricks, Hysters, Mechanic Motor Patrol, Mixers-21 cu. ft. or over, Push Cats, Pulls and Scrapers, Two Well Point Pumps, Pulverizer or Tiller, PugMill, Rubber-Tired Farm Type Tractor with Bulldozer/Blade/Auger or hi-lift over 1/2 yd., Jersey Spreader, Tract-Air used with Drill or Hi-Lift, Trenching or Ditching Machines, Wood Chipper w/Tractor, Self-Propelled Roller w/Blade, Equipment Greaser, Self-Propelled Bump Grinder on Concrete pavement, Boat Operator, Skid-Loaders, Tuggers, Lazer Screed, and Self-Propelled Chip Spreader (when others run conveyors).

Class 2. Any type tractor pulling any type roller or disc, Two Air Compressors (220 cu. ft. capacity or over), Two AirTract Drills, Air-Track Drill w/Compressor, Automatic Bins or Scales w/Compressor or Generator, Pipeline Boring Machine, Bulk Cement Plant w/Separate Compressor, Power Operated Bull Float, Hydra-Lift w/Single Motor, Straw Mulcher Blower w/Spout, Self-Propelled Roller/Compactor, Back-End man on Bituminous Surfacing Machine, oiler on milling machine.

Class 3. Air Compressor w/Valve driving piling, Boom or Winch Type Truck, Two Conveyors, Self-Propelled Concrete Saw, Form Grader, Truck Crane Oiler, Self-Propelled Vibrator, Rubber Tired Farm Type Tractor w/Blade/Bulldozer/Auger/hi-lift - 1/2 yd. or less, Elevator Operator, Man Lift (scissor lift) when lifting materials.

Class 4. Air-Track Drill (one), Belt Drag Machine, Power Broom, Mechanical Plasterer Applicator, Trac-Air, Air Compressor (220 cu. ft. or over) One, Air Compressor (under 220 cu. ft) four, Automatic Bin, Bulk Cement Plant w/Built-in Compressor running off same motor or electric motor, Fireman or Switchman, Self-Propelled Form Tamper, Light Plants (4), Welding Machines (4), Pumps (4), or Combination of four (4) Pumps, Light Plants, Welding Machines, Air-Compressors (under 220 cu. ft.), Mudjacks or Wood Chipper, Mixers - less than 21 cu. ft. Mortar Mixer w/Skip or Pump, Pipeline Tract Jack. One Operating Engineer may operate and maintain any combination of the following pieces of equipment, not to exceed four (4) which shall be within a reasonable distance, such combination may include any equipment in this classification: (Compressors, Light Plants, Generators, Welding Machines, Pumps or Conveyors), One Well- Point Pump, Two Motor Driven Heaters, One Air Compressor (under 220 cu. ft.), One Engine-Driven Conveyor, One Motor Driven Heater, One Light Plant, One Pump, One Welding Machine, One Ulmac or Equal Spreader, Oilers, and one Generator 10 kw or greater.

OPERATING ENGINEER - O & C (Oil and Chip Resealing ONLY). Includes the operation of all motorized heavy equipment used in oil and chip rsealing, including but not limited to operating self-propelled chip spreaders, and all types of rollers (both hard and rubber tired); and other duties pertaining to the operation or maintenance of heavy equipment relatd to oil and chip resealing.

Class 1. See Class 1 above for types of equipment operated.

Class 2. See Class 2 above for types of equipment operated.

Class 3. See Class 3 above for types of equipment operated.

Class 4. See Class 4 above for types of equipment operated.

OPERATING ENGINEER RIVER WORK 1 - operate the following machines when working on River Work and Levee Work on the Mississippi and Ohio Rivers, Lakes and Tributaries: Crane, Shovel, Drageline, Scrapers, Dredge, Derrick, Pile-Driver, Push Boat, all power boat operators, Mechanic, Engineman on Dredge, Leverman on Dredge, All Bituminous Spreader machines, Backhoe, Backfiller, Boom, or Winch Cat, Bituminous Mixplane Machine, Blacksmith, Bituminous Surfacing Machine, Bulldozer, Truck Cranes, Hydraulic Truck Mounted Boom/Crane, Concrete Finishing Machine, or Spreader Machine, Concrete Breaker, Concrete or Pumpcrete Machines, Concrete Plant Operator, All Off Road Material Hauling Equipment, Dinky or Standard Locomotives, Well Drill, Elevating Grader, Fork-Lifts, Flexplane, Gradeall, Hi-Lift, Power Handblade Tugger type Hoist, Hoist Two Drum (or over one), Gyderrick, Hyster, Motor Patrol, Mixers - 21 Cu. Ft. or over, Push Cat, Pulls, & Scrapers, Pumps-Two Well Points, Equipment Greaser, P & H Pulverizer or Pulverizer equal to Pugmill, Pugmill, Rubber-Tired farm type tractor w/Bulldozer/Blade/Auger or Hi-Lift over ½ yard, Skimmer Scoops, Seaman Tiller, Jersey Spreader, Tract-Air used with Drill or Hi-Lift, Trenching or Ditching Machine, Wood Chipper w/Tractor, self-propelled roller w/Blade, Concrete Pumps and Small Equipment Operators.

OPERATING ENGINEER RIVER 2 - when working on River Work and Levee Work on the Mississippi and Ohio Rivers, Lakes and Tributaries shall be employed as the Oiler or Fireman on Crane, Dragline, Shovel, Dredge, Truck Crane, Pile Driver, Gradeall, Dinky or Standard Locomotive, Guy Derrick, Trenching Machine or Ditching Machine 80 H.P. and over, All Terrain (cherry-picker) with over 40 ton Lifting Capacity, Deck Oiler and Deckhands.

#### Other Classifications of Work:

For definitions of classifications not otherwise set out, the Department generally has on file such definitions which are available. If a task to be performed is not subject to one of the classifications of pay set out, the Department will upon being contacted state which neighboring county has such a classification and provide such rate, such rate being deemed to exist by reference in this document. If no neighboring county rate applies to the task, the Department shall undertake a special determination, such special determination being then deemed to have existed under this determination. If a project requires these, or any classification not listed, please contact IDOL at 217-782-1710 for wage rates or clarifications.

#### LANDSCAPING

Landscaping work falls under the existing classifications for laborer, operating engineer and truck driver. The work performed by landscape plantsman and landscape laborer is covered by the existing classification of laborer. The work performed by landscape operators (regardless of equipment used or its size) is covered by the classifications of operating engineer. The work performed by landscape truck drivers (regardless of size of truck driven) is covered by the classifications of truck driver.

# Jackson County Prevailing Wage for May 2011

Trade Name	RG	TYP	C	Base	FRMAN	*M-F>8	OSA	OSH	H/W	Pensn	Vac	Trng
=====	==	===	=	=====	=====	=====	===	===	=====	=====	=====	=====
ASBESTOS ABT-GEN		ALL		24.400	24.850	1.5	1.5	2.0	5.550	9.450	0.000	0.900
ASBESTOS ABT-MEC		BLD		28.710	29.710	1.5	1.5	2.0	6.400	2.500	0.000	0.000
BOILERMAKER		BLD		31.500	34.000	1.5	1.5	2.0	6.820	11.43	1.500	0.350
BRICK MASON		BLD		27.220	28.720	1.5	1.5	2.0	7.950	6.690	0.000	0.430
CARPENTER		BLD		30.490	31.990	1.5	1.5	2.0	6.050	5.750	0.000	0.350
CARPENTER		HWY		30.440	31.940	1.5	1.5	2.0	6.050	5.750	0.000	0.350
CEMENT MASON		BLD		26.750	28.250	1.5	1.5	2.0	5.900	4.800	0.000	0.300
CEMENT MASON		HWY		26.350	27.350	1.5	1.5	2.0	5.900	4.350	0.000	0.300
CERAMIC TILE FNSHER		BLD		25.720	0.000	1.5	1.5	2.0	7.950	6.690	0.000	0.430
ELECTRICIAN		ALL		36.830	39.080	1.5	1.5	2.0	5.350	8.470	0.000	0.730
ELECTRONIC SYS TECH		BLD		29.530	31.280	1.5	1.5	2.0	5.250	3.840	0.000	0.250
FLOOR LAYER		BLD		28.930	29.680	1.5	1.5	2.0	6.050	5.750	0.000	0.350
GLAZIER		BLD		31.680	0.000	2.0	2.0	2.0	9.020	10.30	2.540	0.310
HT/FROST INSULATOR		BLD		36.260	37.260	1.5	1.5	2.0	7.150	10.46	0.000	0.500
IRON WORKER		ALL		26.740	28.740	1.5	1.5	2.0	5.760	9.590	0.000	0.500
LABORER		BLD		24.400	24.850	1.5	1.5	2.0	5.550	9.450	0.000	0.800
LABORER		HWY		24.400	24.850	1.5	1.5	2.0	5.550	9.450	0.000	0.800
LABORER		O&C		17.740	18.190	1.5	1.5	2.0	5.450	8.450	0.000	0.800
MACHINIST		BLD		43.160	45.160	1.5	1.5	2.0	7.640	8.700	0.000	0.000
MARBLE FINISHERS		BLD		25.720	0.000	1.5	1.5	2.0	7.950	6.690	0.000	0.430
MARBLE MASON		BLD		27.220	28.720	1.5	1.5	2.0	7.950	6.690	0.000	0.430
MILLWRIGHT		BLD		30.490	31.990	1.5	1.5	2.0	6.050	5.750	0.000	0.350
MILLWRIGHT		HWY		30.440	31.940	1.5	1.5	2.0	6.050	5.750	0.000	0.350
OE RIVER 1		RIV 1		32.100	33.100	1.5	1.5	2.0	6.500	8.300	0.000	1.350
OE RIVER 2		RIV 2		28.750	33.100	1.5	1.5	2.0	6.500	8.300	0.000	1.350
OPERATING ENGINEER		ALL 1		32.100	33.100	1.5	1.5	2.0	6.500	8.300	0.000	1.350
OPERATING ENGINEER		ALL 2		30.200	33.100	1.5	1.5	2.0	6.500	8.300	0.000	1.350
OPERATING ENGINEER		ALL 3		24.150	33.100	1.5	1.5	2.0	6.500	8.300	0.000	1.350
OPERATING ENGINEER		ALL 4		21.400	27.800	1.5	1.5	2.0	5.650	6.100	0.000	1.100
OPERATING ENGINEER		O&C 1		24.080	25.080	1.5	1.5	2.0	6.500	8.300	0.000	1.350
OPERATING ENGINEER		O&C 2		22.650	25.080	1.5	1.5	2.0	6.500	8.300	0.000	1.350
OPERATING ENGINEER		O&C 3		18.120	25.080	1.5	1.5	2.0	6.500	8.300	0.000	1.350
OPERATING ENGINEER		O&C 4		16.050	21.100	1.5	1.5	2.0	5.650	6.100	0.000	1.100
PAINTER		BLD		26.260	27.760	1.5	1.5	2.0	6.130	6.950	0.000	0.450
PAINTER		HWY		30.560	32.060	1.5	1.5	2.0	6.130	6.950	0.000	0.450
PAINTER OVER 30FT		BLD		27.260	28.760	1.5	1.5	2.0	6.130	6.950	0.000	0.450
PAINTER PWR EQMT		BLD		27.260	28.760	1.5	1.5	2.0	6.130	6.950	0.000	0.450
PAINTER PWR EQMT		HWY		31.560	33.060	1.5	1.5	2.0	6.130	6.950	0.000	0.450
PILEDRIVER		BLD		30.490	31.990	1.5	1.5	2.0	6.050	5.750	0.000	0.350
PILEDRIVER		HWY		30.440	31.940	1.5	1.5	2.0	6.050	5.750	0.000	0.350
PIPEFITTER		BLD		38.050	41.850	1.5	2.0	2.0	7.600	5.500	0.000	1.100
PLASTERER		BLD		26.750	28.250	1.5	1.5	2.0	5.900	4.800	0.000	0.300
PLUMBER		BLD		38.050	41.850	1.5	2.0	2.0	7.600	5.500	0.000	1.100
ROOFER		BLD		22.250	23.250	1.5	1.5	2.0	7.900	3.800	0.000	0.000
SHEETMETAL WORKER		ALL		31.390	32.890	1.5	1.5	2.0	6.430	6.490	1.890	0.360
SPRINKLER FITTER		BLD		36.140	38.890	1.5	1.5	2.0	8.100	8.200	0.000	0.350
STONE MASON		BLD		27.220	28.720	1.5	1.5	2.0	7.950	6.690	0.000	0.430
TERRAZZO FINISHER		BLD		25.720	0.000	1.5	1.5	2.0	7.950	6.690	0.000	0.430
TERRAZZO MASON		BLD		28.500	28.800	1.5	1.5	2.0	6.400	5.700	0.000	0.430
TRUCK DRIVER		ALL 1		28.430	0.000	1.5	1.5	2.0	9.050	5.500	0.000	0.250
TRUCK DRIVER		ALL 2		28.850	0.000	1.5	1.5	2.0	9.050	5.500	0.000	0.250
TRUCK DRIVER		ALL 3		29.050	0.000	1.5	1.5	2.0	9.050	5.500	0.000	0.250
TRUCK DRIVER		ALL 4		29.320	0.000	1.5	1.5	2.0	9.050	5.500	0.000	0.250
TRUCK DRIVER		ALL 5		30.100	0.000	1.5	1.5	2.0	9.050	5.500	0.000	0.250
TRUCK DRIVER		O&C 1		22.750	0.000	1.5	1.5	2.0	2.920	6.700	0.000	0.250
TRUCK DRIVER		O&C 2		19.150	0.000	1.5	1.5	2.0	2.920	6.700	0.000	0.250
TRUCK DRIVER		O&C 3		19.650	0.000	1.5	1.5	2.0	2.920	6.700	0.000	0.250
TUCKPOINTER		BLD		27.220	28.720	1.5	1.5	2.0	7.950	6.690	0.000	0.430



Legend :

M-F>8 (Overtime is required for any hour greater than 8 worked each day, Monday through Friday.)

OSA (Overtime is required for every hour worked on Saturday)

OSH (Overtime is required for every hour worked on Sunday and Holidays)

H/W (Health & Welfare Insurance)

Pensn (Pension)

Vac (Vacation)

Trng (Training)

## Explanations

### JACKSON COUNTY

The following list is considered as those days for which holiday rates of wages for work performed apply: New Years Day, Memorial Day, Fourth of July, Labor Day, Thanksgiving Day, Christmas Day and Veterans Day in some classifications/counties. Generally, any of these holidays which fall on a Sunday is celebrated on the following Monday. This then makes work performed on that Monday payable at the appropriate overtime rate for holiday pay. Common practice in a given local may alter certain days of celebration. If in doubt, please check with IDOL.

Oil and chip resealing (O&C) means the application of road oils and liquid asphalt to coat an existing road surface, followed by application of aggregate chips or gravel to coated surface, and subsequent rolling of material to seal the surface.

### EXPLANATION OF CLASSES

ASBESTOS - GENERAL - removal of asbestos material/mold and hazardous materials from any place in a building, including mechanical systems where those mechanical systems are to be removed. This includes the removal of asbestos materials/mold and hazardous materials from ductwork or pipes in a building when the building is to be demolished at the time or at some close future date.

ASBESTOS - MECHANICAL - removal of asbestos material from mechanical systems, such as pipes, ducts, and boilers, where the mechanical systems are to remain.

### LABORER - OIL AND CHIP RESEALING

Hook and unhook chip box from aggregate truck; distribute material within chip box; perform flagging work related to oil and chip resealing; hand spray oil fluids; handle traffic control, including setting-up and maintaining barricades, drums, cones, delineators, signs and other such items, as well as laying-out and applying or removing temporary roadway markings used to control traffic in job site related to oil and chip resealing; and perform clean-up related

to oil and chip resealing.

#### CERAMIC TILE FINISHER, MARBLE FINISHER, TERRAZZO FINISHER

Assisting, helping or supporting the tile, marble and terrazzo mechanic by performing their historic and traditional work assignments required to complete the proper installation of the work covered by said crafts. The term "Ceramic" is used for naming the classification only, and is in no a limitation of the product handled. Ceramic takes into consideration most hard tiles.

#### ELECTRONIC SYSTEMS TECHNICIAN

Installation, service and maintenance of low-voltage systems which utilizes the transmission and/or transference of voice, sound, vision, or digital for commercial, education, security and entertainment purposes for the following: TV monitoring and surveillance, background/foreground music, intercom and telephone interconnect, field programming, inventory control systems, microwave transmission, multi-media, multiplex, radio page, school, intercom and sound burglar alarms and low voltage master clock systems.

Excluded from this classification are energy management systems, life safety systems, supervisory controls and data acquisition systems not intrinsic with the above listed systems, fire alarm systems, nurse call systems and raceways exceeding fifteen feet in length.

#### TRUCK DRIVER - BUILDING, HEAVY AND HIGHWAY CONSTRUCTION

Class 1. Drivers on 2 axle trucks hauling less than 9 ton. Air compressor and welding machines and brooms, including those pulled by separate units, truck driver helpers, warehouse employees, mechanic helpers, greasers and tiremen, pickup trucks when hauling materials, tools, or workers to and from and on-the-job site, and fork lifts up to 6,000 lb. capacity.

Class 2. Two or three axle trucks hauling more than 9 ton but hauling less than 16 ton. A-frame winch trucks, hydrolift trucks, vector trucks or similar equipment when used for transportation purposes. Fork lifts over 6,000 lb. capacity, winch trucks, four axle combination units, and ticket writers.

Class 3. Two, three or four axle trucks hauling 16 ton or more. Drivers on water pulls, articulated dump trucks, mechanics and working forepersons, and dispatchers. Five axle or more combination units.

Class 4. Low Boy and Oil Distributors.

Class 5. Drivers who require special protective clothing while employed on hazardous waste work.

#### TRUCK DRIVER - O & C (Oil and Chip Resealing ONLY)

It involves driving of contractor or subcontractor owned, leased, or hired pickup, dump, service, or oil distributor trucks. Includes transporting materials and equipment (including, but not limited to oils, aggregate supplies, parts, machinery and tools) to or from the job site; distributing oil or liquid asphalt and aggregate; stock piling material; and maintaining trucks at job site related to oil and chip resealing.

Class 1. Distributors, liquid asphalt hauling and hauling of asphalt rubber-tired rollers.

Class 2. Stockpiling.

Class 3. Tandem hauling to job site.

OPERATING ENGINEERS - BUILDING, HEAVY AND HIGHWAY CONSTRUCTION

Class 1. APSCO or Equal Spreading Machine, Backhoe, Backfiller, Boom or Winch Cat, Bituminous Mixplane Machine, Blacksmith, Bituminous Surfacing Machine, Bull-Dozer, Crane, Shovel, Dragline, Truck Crane, Pile Driver, Concrete Breaker, Concrete or Pumpcrete Pumps, Dinky or Standard Locomotives, Well or Caisson Drills, Elevating Grader, Fork Lifts, Flexplane, Gradeall, Hi-Lift Hoists, Guy-Derricks, Hysters, Mechanic Motor Patrol, Mixers-21 cu. ft. or over, Push Cats, Pulls and Scrapers, Two Well Point Pumps, Pulverizer or Tiller, PugMill, Rubber-Tired Farm Type Tractor with Bulldozer/Blade/Auger or hi-lift over 1/2 yd., Jersey Spreader, Tract-Air used with Drill or Hi-Lift, Trenching or Ditching Machines, Wood Chipper w/Tractor, Self-Propelled Roller w/Blade, Equipment Greaser, Self-Propelled Bump Grinder on Concrete pavement, Boat Operator, Skid-Loaders, Tuggers, Lazer Screed, and Self-Propelled Chip Spreader (when others run conveyors).

Class 2. Any type tractor pulling any type roller or disc, Two Air Compressors (220 cu. ft. capacity or over), Two Air Tract Drills, Air-Track Drill w/Compressor, Automatic Bins or Scales w/Compressor or Generator, Pipeline Boring Machine, Bulk Cement Plant w/Separate Compressor, Power Operated Bull Float, Hydra-Lift w/Single Motor, Straw Mulcher Blower w/Spout, Self-Propelled Roller/Compactor, Back-End man on Bituminous Surfacing Machine, oiler on milling machine.

Class 3. Air Compressor w/Valve driving piling, Boom or Winch Type Truck, Two Conveyors, Self-Propelled Concrete Saw, Form Grader, Truck Crane Oiler, Self-Propelled Vibrator, Rubber Tired Farm Type Tractor w/Blade/Bulldozer/Auger/hi-lift - 1/2 yd. or less, Elevator Operator, Man Lift (scissor lift) when lifting materials.

Class 4. Air-Track Drill (one), Belt Drag Machine, Power Broom, Mechanical Plasterer Applicator, Trac-Air, Air Compressor (220 cu. ft. or over) One, Air Compressor (under 220 cu. ft) four, Automatic Bin, Bulk Cement Plant w/Built-in Compressor running off same motor or electric motor, Fireman or Switchman, Self-Propelled Form Tamper, Light Plants (4), Welding Machines (4), Pumps (4), or Combination of four (4) Pumps, Light Plants, Welding Machines, Air-Compressors (under 220 cu. ft.), Mudjacks or Wood Chipper, Mixers - less than 21 cu. ft. Mortar Mixer w/Skip or Pump, Pipeline Tract Jack. One Operating Engineer may operate and maintain any combination of the following pieces of equipment, not to exceed four (4) which shall be within a reasonable distance, such combination may include any equipment in this classification: (Compressors, Light Plants, Generators, Welding Machines, Pumps or Conveyors), One Well- Point Pump, Two Motor Driven Heaters, One Air Compressor (under 220 cu. ft.), One Engine-Driven Conveyor, One Motor Driven Heater, One Light Plant, One Pump, One Welding Machine, One Ulmac or Equal Spreader, Oilers, and one Generator 10 kw or greater.

OPERATING ENGINEER - O & C (Oil and Chip Resealing ONLY). Includes the operation of all motorized heavy equipment used in oil and chip rsealing, including but not limited to operating self-propelled chip spreaders, and all types of rollers (both hard and rubber tired); and other duties pertaining to the operation or maintenance of heavy equipment relatd to oil and chip resealing.

Class 1. See Class 1 above for types of equipment operated.

Class 2. See Class 2 above for types of equipment operated.

Class 3. See Class 3 above for types of equipment operated.

Class 4. See Class 4 above for types of equipment operated.

OPERATING ENGINEER RIVER WORK 1 - operate the following machines when working on River Work and Levee Work on the Mississippi and Ohio Rivers, Lakes and Tributaries: Crane, Shovel, Drageline, Scrapers, Dredge, Derrick, Pile-Driver, Push Boat, all power boat operators, Mechanic, Engineman on Dredge, Leverman on Dredge, All Bituminous Spreader machines, Backhoe, Backfiller, Boom, or Winch Cat, Bituminous Mixplane Machine, Blacksmith, Bituminous Surfacing Machine, Bulldozer, Truck Cranes, Hydraulic Truck Mounted Boom/Crane, Concrete Finishing Machine, or Spreader Machine, Concrete Breaker, Concrete or Pumpcrete Machines, Concrete Plant Operator, All Off Road Material Hauling Equipment, Dinky or Standard Locomotives, Well Drill, Elevating Grader, Fork-Lifts, Flexplane, Gradeall, Hi-Lift, Power Handblade Tugger type Hoist, Hoist Two Drum (or over one), Gyderrick, Hyster, Motor Patrol, Mixers - 21 Cu. Ft. or over, Push Cat, Pulls, & Scrapers, Pumps-Two Well Points, Equipment Greaser, P & H Pulverizer or Pulverizer equal to Pugmill, Pugmill, Rubber-Tired farm type tractor w/Bulldozer/Blade/Auger or Hi-Lift over ½ yard, Skimmer Scoops, Seaman Tiller, Jersey Spreader, Tract-Air used with Drill or Hi-Lift, Trenching or Ditching Machine, Wood Chipper w/Tractor, self-propelled roller w/Blade, Concrete Pumps and Small Equipment Operators.

OPERATING ENGINEER RIVER 2 - when working on River Work and Levee Work on the Mississippi and Ohio Rivers, Lakes and Tributaries shall be employed as the Oiler or Fireman on Crane, Dragline, Shovel, Dredge, Truck Crane, Pile Driver, Gradeall, Dinky or Standard Locomotive, Guy Derrick, Trenching Machine or Ditching Machine 80 H.P. and over, All Terrain (cherry-picker) with over 40 ton Lifting Capacity, Deck Oiler and Deckhands.

Other Classifications of Work:

For definitions of classifications not otherwise set out, the Department generally has on file such definitions which are available. If a task to be performed is not subject to one of the classifications of pay set out, the Department will upon being contacted state which neighboring county has such a classification and provide such rate, such rate being deemed to exist by reference in this document. If no neighboring county rate applies to the task, the Department shall undertake a special determination, such special determination being then deemed to have existed under this determination. If a project requires these, or any classification not listed, please contact IDOL at 217-782-1710 for wage rates or clarifications.

#### LANDSCAPING

Landscaping work falls under the existing classifications for laborer, operating engineer and truck driver. The work performed by landscape plantsman and landscape laborer is covered by the existing classification of laborer. The work performed by landscape operators (regardless of equipment used or its size) is covered by the classifications of operating engineer. The work performed by landscape truck drivers (regardless of size of truck driven) is covered by the classifications of truck driver.

# Jefferson County Prevailing Wage for May 2011

Trade Name	RG	TYP	C	Base	FRMAN	*M-F>8	OSA	OSH	H/W	Pensn	Vac	Trng
=====	==	===	=	=====	=====	=====	===	===	=====	=====	=====	=====
ASBESTOS ABT-GEN		ALL		24.400	24.850	1.5	1.5	2.0	5.550	9.450	0.000	0.900
ASBESTOS ABT-MEC		BLD		28.710	29.710	1.5	1.5	2.0	6.400	2.500	0.000	0.000
BOILERMAKER		BLD		31.500	34.000	1.5	1.5	2.0	6.820	11.43	1.500	0.350
BRICK MASON		BLD		27.220	28.720	1.5	1.5	2.0	7.950	6.690	0.000	0.430
CARPENTER		BLD		30.490	31.990	1.5	1.5	2.0	6.050	5.750	0.000	0.350
CARPENTER		HWY		30.440	32.190	1.5	1.5	2.0	6.050	5.750	0.000	0.350
CEMENT MASON		BLD		26.750	28.250	1.5	1.5	2.0	5.900	4.800	0.000	0.300
CEMENT MASON		HWY		25.580	27.080	1.5	1.5	2.0	5.900	5.000	0.000	0.300
CERAMIC TILE FNSHER		BLD		25.720	0.000	1.5	1.5	2.0	7.950	6.690	0.000	0.430
ELECTRICIAN		ALL		36.830	39.080	1.5	1.5	2.0	5.350	8.470	0.000	0.730
ELECTRONIC SYS TECH		BLD		29.530	31.280	1.5	1.5	2.0	5.250	3.840	0.000	0.250
FLOOR LAYER		BLD		28.930	29.680	1.5	1.5	2.0	6.050	5.750	0.000	0.350
GLAZIER		BLD		26.330	27.580	1.5	1.5	2.0	4.850	5.200	0.000	0.300
HT/FROST INSULATOR		BLD		36.260	37.260	1.5	1.5	2.0	7.150	10.46	0.000	0.500
IRON WORKER		ALL		30.350	32.350	1.5	1.5	2.0	6.360	11.85	0.000	0.420
LABORER		BLD		24.400	24.850	1.5	1.5	2.0	5.550	9.450	0.000	0.800
LABORER		HWY		24.400	24.850	1.5	1.5	2.0	5.550	9.450	0.000	0.800
MACHINIST		BLD		43.160	45.160	1.5	1.5	2.0	7.640	8.700	0.000	0.000
MARBLE FINISHERS		BLD		25.720	0.000	1.5	1.5	2.0	7.950	6.690	0.000	0.430
MARBLE MASON		BLD		27.220	28.720	1.5	1.5	2.0	7.950	6.690	0.000	0.430
MILLWRIGHT		BLD		30.490	31.990	1.5	1.5	2.0	6.050	5.750	0.000	0.350
MILLWRIGHT		HWY		30.940	32.690	1.5	1.5	2.0	6.050	5.750	0.000	0.350
OPERATING ENGINEER		BLD	1	32.000	35.000	1.5	1.5	2.0	8.050	15.50	0.000	1.000
OPERATING ENGINEER		BLD	2	30.870	35.000	1.5	1.5	2.0	8.050	15.50	0.000	1.000
OPERATING ENGINEER		BLD	3	26.390	35.000	1.5	1.5	2.0	8.050	15.50	0.000	1.000
OPERATING ENGINEER		BLD	4	26.450	35.000	1.5	1.5	2.0	8.050	15.50	0.000	1.000
OPERATING ENGINEER		BLD	5	26.120	35.000	1.5	1.5	2.0	8.050	15.50	0.000	1.000
OPERATING ENGINEER		BLD	6	32.550	35.000	1.5	1.5	2.0	8.050	15.50	0.000	1.000
OPERATING ENGINEER		BLD	7	32.850	35.000	1.5	1.5	2.0	8.050	15.50	0.000	1.000
OPERATING ENGINEER		BLD	8	33.130	35.000	1.5	1.5	2.0	8.050	15.50	0.000	1.000
OPERATING ENGINEER		BLD	9	34.000	35.000	1.5	1.5	2.0	8.050	15.50	0.000	1.000
OPERATING ENGINEER		HWY	1	30.500	33.500	1.5	1.5	2.0	8.050	15.50	0.000	1.000
OPERATING ENGINEER		HWY	2	29.370	33.500	1.5	1.5	2.0	8.050	15.50	0.000	1.000
OPERATING ENGINEER		HWY	3	24.890	33.500	1.5	1.5	2.0	8.050	15.50	0.000	1.000
OPERATING ENGINEER		HWY	4	24.950	33.500	1.5	1.5	2.0	8.050	15.50	0.000	1.000
OPERATING ENGINEER		HWY	5	24.620	33.500	1.5	1.5	2.0	8.050	15.50	0.000	1.000
OPERATING ENGINEER		HWY	6	31.050	33.500	1.5	1.5	2.0	8.050	15.50	0.000	1.000
OPERATING ENGINEER		HWY	7	31.350	33.500	1.5	1.5	2.0	8.050	15.50	0.000	1.000
OPERATING ENGINEER		HWY	8	31.630	33.500	1.5	1.5	2.0	8.050	15.50	0.000	1.000
OPERATING ENGINEER		HWY	9	32.500	33.500	1.5	1.5	2.0	8.050	15.50	0.000	1.000
PAINTER		ALL		23.020	23.520	1.5	1.5	2.0	4.950	6.800	0.000	0.430
PAINTER OVER 30FT		ALL		26.120	26.620	1.5	1.5	2.0	4.950	6.800	0.000	0.430
PAINTER PWR EQMT		ALL		26.120	26.620	1.5	1.5	2.0	4.950	6.800	0.000	0.430
PILEDRIVER		BLD		30.490	31.990	1.5	1.5	2.0	6.050	5.750	0.000	0.350
PILEDRIVER		HWY		30.940	32.690	1.5	1.5	2.0	6.050	5.750	0.000	0.350
PIPEFITTER		BLD		32.250	35.470	1.5	1.5	2.0	8.250	8.850	0.000	1.200
PLASTERER		BLD		26.750	28.250	1.5	1.5	2.0	5.900	4.800	0.000	0.300
PLUMBER		BLD		32.250	35.470	1.5	1.5	2.0	8.250	8.850	0.000	1.200
ROOFER		BLD		22.250	23.250	1.5	1.5	2.0	7.900	3.800	0.000	0.000
SHEETMETAL WORKER		ALL		31.390	32.890	1.5	1.5	2.0	6.430	6.490	1.890	0.360
SPRINKLER FITTER		BLD		36.140	38.890	1.5	1.5	2.0	8.100	8.200	0.000	0.350
STONE MASON		BLD		27.220	28.720	1.5	1.5	2.0	7.950	6.690	0.000	0.430
TERRAZZO FINISHER		BLD		25.720	0.000	1.5	1.5	2.0	7.950	6.690	0.000	0.430
TERRAZZO MASON		BLD		28.500	28.800	1.5	1.5	2.0	6.400	5.700	0.000	0.430
TRUCK DRIVER		ALL	1	29.600	0.000	1.5	1.5	2.0	9.050	4.500	0.000	0.250
TRUCK DRIVER		ALL	2	30.020	0.000	1.5	1.5	2.0	9.050	4.500	0.000	0.250
TRUCK DRIVER		ALL	3	30.230	0.000	1.5	1.5	2.0	9.050	4.500	0.000	0.250
TRUCK DRIVER		ALL	4	30.490	0.000	1.5	1.5	2.0	9.050	4.500	0.000	0.250

TRUCK DRIVER	ALL	5	31.280	0.000	1.5	1.5	2.0	9.050	4.500	0.000	0.250
TRUCK DRIVER	O&C	1	23.680	0.000	1.5	1.5	2.0	9.050	4.500	0.000	0.250
TRUCK DRIVER	O&C	2	24.020	0.000	1.5	1.5	2.0	9.050	4.500	0.000	0.250
TRUCK DRIVER	O&C	3	24.180	0.000	1.5	1.5	2.0	9.050	4.500	0.000	0.250
TRUCK DRIVER	O&C	4	24.390	0.000	1.5	1.5	2.0	9.050	4.500	0.000	0.250
TRUCK DRIVER	O&C	5	25.020	0.000	1.5	1.5	2.0	9.050	4.500	0.000	0.250
TUCK POINTER	BLD		27.220	28.720	1.5	1.5	2.0	7.950	6.690	0.000	0.430

Legend:

M-F>8 (Overtime is required for any hour greater than 8 worked each day, Monday through Friday.)

OSA (Overtime is required for every hour worked on Saturday)

OSH (Overtime is required for every hour worked on Sunday and Holidays)

H/W (Health & Welfare Insurance)

Pensn (Pension)

Vac (Vacation)

Trng (Training)

## Explanations

### JEFFERSON COUNTY

The following list is considered as those days for which holiday rates of wages for work performed apply: New Years Day, Memorial Day, Fourth of July, Labor Day, Thanksgiving Day, Christmas Day and Veterans Day in some classifications/counties. Generally, any of these holidays which fall on a Sunday is celebrated on the following Monday. This then makes work performed on that Monday payable at the appropriate overtime rate for holiday pay. Common practice in a given local may alter certain days of celebration. If in doubt, please check with IDOL.

Oil and chip resealing (O&C) means the application of road oils and liquid asphalt to coat an existing road surface, followed by application of aggregate chips or gravel to coated surface, and subsequent rolling of material to seal the surface.

### EXPLANATION OF CLASSES

ASBESTOS - GENERAL - removal of asbestos material/mold and hazardous materials from any place in a building, including mechanical systems where those mechanical systems are to be removed. This includes the removal of asbestos materials/mold and hazardous materials from ductwork or pipes in a building when the building is to be demolished at the time or at some close future date.

ASBESTOS - MECHANICAL - removal of asbestos material from mechanical systems, such as pipes, ducts, and boilers, where the mechanical systems are to remain.

### CERAMIC TILE FINISHER, MARBLE FINISHER, TERRAZZO FINISHER

Assisting, helping or supporting the tile, marble and terrazzo

mechanic by performing their historic and traditional work assignments required to complete the proper installation of the work covered by said crafts. The term "Ceramic" is used for naming the classification only, and is in no a limitation of the product handled. Ceramic takes into consideration most hard tiles.

#### ELECTRONIC SYSTEMS TECHNICIAN

Installation, service and maintenance of low-voltage systems which utilizes the transmission and/or transference of voice, sound, vision, or digital for commercial, education, security and entertainment purposes for the following: TV monitoring and surveillance, background/foreground music, intercom and telephone interconnect, field programming, inventory control systems, microwave transmission, multi-media, multiplex, radio page, school, intercom and sound burglar alarms and low voltage master clock systems.

Excluded from this classification are energy management systems, life safety systems, supervisory controls and data acquisition systems not intrinsic with the above listed systems, fire alarm systems, nurse call systems and raceways exceeding fifteen feet in length.

#### OPERATING ENGINEER - BUILDING

GROUP I. Cranes, Dragline, Shovels, Skimmer Scoops, Clamshells or Derrick Boats, Pile Drivers, Crane-Type Backhoes, Asphalt Plant Operators, Concrete Plant Operators, Dredges, Asphalt Spreading Machines, All Locomotives, Cable Ways or Tower Machines, Hoists, Hydraulic Backhoes, Ditching Machines or Backfiller, Cherrypickers, Overhead Cranes, Roller - Steam or Gas, Concrete Pavers, Excavators, Concrete Breakers, Concrete Pumps, Bulk Cement Plants, Cement Pumps, Derrick-Type Drills, Boat Operators, Motor Graders or Pushcats, Scoops or Tournapulls, Bulldozers, Endloaders or Fork Lifts, Power Blade or Elevating Graders, Winch Cats, Boom or Winch Trucks or Boom Tractors, Pipe Wrapping or Painting Machines, Asphalt Plant Engineer, Journeyman Lubricating Engineer, Drills (other than Derrick Type), Mud Jacks, or Well Drilling Machines, Boring Machines or Track Jacks, Mixers, Conveyors (Two), Air Compressors (Two), Water Pumps regardless of size (Two), Welding Machines (Two), Siphons or Jets (Two), Winch Heads or Apparatuses (Two), Light Plants (Two), All Tractors regardless of size (straight tractor only), Fireman on Stationary Boilers, Automatic Elevators, Form Grading Machines, Finishing Machines, Power Sub-Grader or Ribbon Machines, Longitudinal Floats, Distributor Operators on Trucks, Winch Heads or Apparatuses (One), Mobil Track air and heaters (two to five), Heavy Equipment Greaser, Relief Operator, Assistant Master Mechanic and Heavy Duty Mechanic, self-propelled concrete saws of all types and sizes with their attachments, gob-hoppers, excavators all sizes, the repair and greasing of all diesel hammers, the operation and set-up of bidwells, water blasters of all sizes and their clutches, hydraulic jacks where used for hoisting, operation of log skidders, iceolators used on and off of pipeline, condor cranes, bow boats, survey boats, bobcats and all their attachments, skid steer loaders and all their attachments, creter cranes, batch plants, operator (all sizes), self propelled roto mills, operation of conveyor systems of any size and any configuration, operation, repair and service of all vibratory hammers, all power pacs and their controls regardless of location, curtains or brush burning machines, stump cutter machines, Nail launchers when mounted on a machine or self-propelled, operation of con-cover machines, and all Operators except those listed below).

GROUP II. Assistant Operators.

GROUP III. Air Compressors (One), Water Pumps, regardless of Size (One), Waterblasters (one), Welding Machine (One), Mixers (One Bag), Conveyor (One), Siphon or Jet (One), Light Plant (One), Heater (One), Immobile Track Air (One), and Self Propelled Walk-Behind Rollers.

GROUP IV. Asphalt Spreader Oilers, Fireman on Whirlies and Heavy Equipment Oilers, Truck Cranes, Dredges, Monigans, Large Cranes - (Over 65-ton rated capacity) Concrete Plant Oiler, Blacktop Plant Oiler, and Creter Crane Oiler (when required).

GROUP V. Oiler.

GROUP VI. Operators on equipment with Booms, including jibs, 100 feet and over, and less than 150 feet long.

GROUP VII. Operators on equipment with Booms, including jibs, 150 feet and over, and less than 200 feet long.

GROUP VIII. Operators on Equipment with Booms, including jibs, 200 feet and over; Tower Cranes; and Whirlie Cranes.

GROUP IX. Master Mechanic

OPERATING ENGINEERS - Highway

GROUP I. Cranes, Dragline, Shovels, Skimmer Scoops, Clamshells or Derrick Boats, Pile Drivers, Crane-Type Backhoes, Asphalt Plant Operators, Concrete Plant Operators, Dredges, Asphalt Spreading Machines, All Locomotives, Cable Ways or Tower Machines, Hoists, Hydraulic Backhoes, Ditching Machines or Backfiller, Cherrypickers, Overhead Cranes, Roller - Steam or Gas, Concrete Pavers, Excavators, Concrete Breakers, Concrete Pumps, Bulk Cement Plants, Cement Pumps, Derrick-Type Drills, Boat Operators, Motor Graders or Pushcats, Scoops or Tournapulls, Bulldozers, Endloaders or Fork Lifts, Power Blade or Elevating Graders, Winch Cats, Boom or Winch Trucks or Boom Tractors, Pipe Wrapping or Painting Machines, Asphalt Plant Engineer, Journeyman Lubricating Engineer, Drills (other than Derrick Type), Mud Jacks, Well Drilling Machines, Boring Machines, Track Jacks, Mixers, Conveyors (Two), Air Compressors (Two), Water Pumps regardless of size (Two), Welding Machines (Two), Siphons or Jets (Two), Winch Heads or Apparatuses (Two), Light Plants (Two), All Tractors regardless of size (straight tractor only), Fireman on Stationary Boilers, Automatic Elevators, Form Grading Machines, Finishing Machines, Power Sub-Grader or Ribbon Machines, Longitudinal Floats, Distributor Operators on Trucks, Winch Heads or Apparatuses (One), Mobil Track air and heaters (two to five), Heavy Equipment Greaser, Relief Operator, Assistant Master Mechanic and Heavy Duty Mechanic, self-propelled concrete saws of all types and sizes with their attachments, gob-hoppers, excavators all sizes, the repair and greasing of all diesel hammers, the operation and set-up of bidwells, water blasters of all sizes and their clutches, hydraulic jacks where used for hoisting, operation of log skidders, iceolators used on and off of pipeline, condor cranes, bow boats, survey boats, bobcats and all their attachments, skid steer loaders and all their attachments, creter cranes, batch plants, operator (all sizes), self propelled roto mills, operation of conveyor systems of any size and any configuration, operation, repair and service of all vibratory hammers, all power pacs and their controls regardless of location, curtains or brush burning machines, stump cutter machines, Nail launchers when mounted on a machine or self-propelled, operation of con-cover machines, and all Operators (except those listed below).

GROUP II. Assistant Operators.



GROUP III. Air Compressors (One), Water Pumps, regardless of Size (One), Waterblasters (one), Welding Machine (One), Mixers (One Bag), Conveyor (One), Siphon or Jet (One), Light Plant (One), Heater (One), Immobile Track Air (One), and Self Propelled Walk-Behind Rollers.

GROUP IV. Asphalt Spreader Oilers, Fireman on Whirlies and Heavy Equipment Oilers, Truck Cranes, Dredges, Monigans, Large Cranes - (Over 65-ton rated capacity) Concrete Plant Oiler, Blacktop Plant Oiler, and Creter Crane Oiler (when required).

GROUP V. Oiler.

GROUP VI. Operators on equipment with Booms, including jibs, 100 feet and over, and less than 150 feet long.

GROUP VII. Operators on equipment with Booms, including jibs, 150 feet and over, and less than 200 feet long.

GROUP VIII. Operators on Equipment with Booms, including jibs, 200 feet and over; Tower Cranes; and Whirlie Cranes.

GROUP IX. Mechanic

#### TRUCK DRIVER - BUILDING, HEAVY AND HIGHWAY CONSTRUCTION

Class 1. Drivers on 2 axle trucks hauling less than 9 ton. Air compressor and welding machines and brooms, including those pulled by separate units, truck driver helpers, warehouse employees, mechanic helpers, greasers and tiremen, pickup trucks when hauling materials, tools, or workers to and from and on-the-job site, and fork lifts up to 6,000 lb. capacity.

Class 2. Two or three axle trucks hauling more than 9 ton but hauling less than 16 ton. A-frame winch trucks, hydrolift trucks, vactor trucks or similar equipment when used for transportation purposes. Fork lifts over 6,000 lb. capacity, winch trucks, four axle combination units, and ticket writers.

Class 3. Two, three or four axle trucks hauling 16 ton or more. Drivers on water pulls, articulated dump trucks, mechanics and working forepersons, and dispatchers. Five axle or more combination units.

Class 4. Low Boy and Oil Distributors.

Class 5. Drivers who require special protective clothing while employed on hazardous waste work.

#### TRUCK DRIVER - OIL AND CHIP RESEALING ONLY.

This shall encompass laborers, workers and mechanics who drive contractor or subcontractor owned, leased, or hired pickup, dump, service, or oil distributor trucks. The work includes transporting materials and equipment (including but not limited to, oils, aggregate supplies, parts, machinery and tools) to or from the job site; distributing oil or liquid asphalt and aggregate; stock piling material when in connection with the actual oil and chip contract. The Truck Driver (Oil & Chip Resealing) wage classification does not include supplier delivered materials.

Other Classifications of Work:

For definitions of classifications not otherwise set out, the Department generally has on file such definitions which are available. If a task to be performed is not subject to one of the classification of pay set out, the Department will upon being contacted state which neighboring county has such a classification and provide such rate, such rate being deemed to exist by reference in this document. If no neighboring county rate applies to the task, the Department shall undertake a special determination, such special determination being then deemed to have existed under this determination. If a project requires these, or any classification not listed, please contact IDOL at 217-782-1710 for wage rates or clarifications.

#### LANDSCAPING

Landscaping work falls under the existing classifications for laborer, operating engineer and truck driver. The work performed by landscape plantsman and landscape laborer is covered by the existing classification of laborer. The work performed by landscape operators (regardless of equipment used or its size) is covered by the classifications of operating engineer. The work performed by landscape truck drivers (regardless of size of truck driven) is covered by the classifications of truck driver.

# Johnson County Prevailing Wage for May 2011

Trade Name	RG	TYP	C	Base	FRMAN	*M-F>8	OSA	OSH	H/W	Pensn	Vac	Trng
=====	==	===	=	=====	=====	=====	===	===	=====	=====	=====	=====
ASBESTOS ABT-GEN		ALL		24.400	24.850	1.5	1.5	2.0	5.550	9.450	0.000	0.900
ASBESTOS ABT-MEC		BLD		20.800	0.000	2.0	2.0	2.0	5.500	4.200	0.000	0.000
BOILERMAKER		BLD		31.500	34.000	1.5	1.5	2.0	6.820	11.43	1.500	0.350
BRICK MASON		BLD		27.220	28.720	1.5	1.5	2.0	7.950	6.690	0.000	0.430
CARPENTER		BLD		30.490	31.990	1.5	1.5	2.0	6.050	5.750	0.000	0.350
CARPENTER		HWY		30.440	31.940	1.5	1.5	2.0	6.050	5.750	0.000	0.350
CEMENT MASON		BLD		26.750	28.250	1.5	1.5	2.0	5.900	4.800	0.000	0.300
CEMENT MASON		HWY		26.350	27.350	1.5	1.5	2.0	5.900	4.350	0.000	0.300
CERAMIC TILE FNSHER		BLD		25.720	0.000	1.5	1.5	2.0	7.950	6.690	0.000	0.430
ELECTRICIAN		ALL		36.830	39.080	1.5	1.5	2.0	5.350	8.470	0.000	0.730
ELECTRONIC SYS TECH		BLD		29.530	31.280	1.5	1.5	2.0	5.250	3.840	0.000	0.250
FLOOR LAYER		BLD		28.930	29.680	1.5	1.5	2.0	6.050	5.750	0.000	0.350
GLAZIER		BLD		26.330	27.580	1.5	1.5	2.0	4.850	5.200	0.000	0.300
HT/FROST INSULATOR		BLD		28.920	29.920	1.5	1.5	2.0	4.800	8.160	0.000	0.280
IRON WORKER		ALL		26.740	28.740	1.5	1.5	2.0	5.760	9.590	0.000	0.500
LABORER		BLD		24.400	24.850	1.5	1.5	2.0	5.550	9.450	0.000	0.800
LABORER		HWY		24.400	24.850	1.5	1.5	2.0	5.550	9.450	0.000	0.800
LABORER		O&C		17.740	18.190	1.5	1.5	2.0	5.450	8.450	0.000	0.800
MACHINIST		BLD		43.160	45.160	1.5	1.5	2.0	7.640	8.700	0.000	0.000
MARBLE FINISHERS		BLD		25.720	0.000	1.5	1.5	2.0	7.950	6.690	0.000	0.430
MARBLE MASON		BLD		27.220	28.720	1.5	1.5	2.0	7.950	6.690	0.000	0.430
MILLWRIGHT		BLD		30.490	31.990	1.5	1.5	2.0	6.050	5.750	0.000	0.350
MILLWRIGHT		HWY		30.440	31.940	1.5	1.5	2.0	6.050	5.750	0.000	0.350
OE RIVER 1		RIV 1		32.100	33.100	1.5	1.5	2.0	6.500	8.300	0.000	1.350
OE RIVER 2		RIV 2		28.750	33.100	1.5	1.5	2.0	6.500	8.300	0.000	1.350
OPERATING ENGINEER		ALL 1		32.100	33.100	1.5	1.5	2.0	6.500	8.300	0.000	1.350
OPERATING ENGINEER		ALL 2		30.200	33.100	1.5	1.5	2.0	6.500	8.300	0.000	1.350
OPERATING ENGINEER		ALL 3		24.150	33.100	1.5	1.5	2.0	6.500	8.300	0.000	1.350
OPERATING ENGINEER		ALL 4		21.400	27.800	1.5	1.5	2.0	5.650	6.100	0.000	1.100
OPERATING ENGINEER		O&C 1		24.080	25.080	1.5	1.5	2.0	6.500	8.300	0.000	1.350
OPERATING ENGINEER		O&C 2		22.650	25.080	1.5	1.5	2.0	6.500	8.300	0.000	1.350
OPERATING ENGINEER		O&C 3		18.120	25.080	1.5	1.5	2.0	6.500	8.300	0.000	1.350
OPERATING ENGINEER		O&C 4		16.050	21.100	1.5	1.5	2.0	5.650	6.100	0.000	1.100
PAINTER		BLD		26.260	27.760	1.5	1.5	2.0	6.130	6.950	0.000	0.450
PAINTER		HWY		30.560	32.060	1.5	1.5	2.0	6.130	6.950	0.000	0.450
PAINTER OVER 30FT		BLD		27.260	28.760	1.5	1.5	2.0	6.130	6.950	0.000	0.450
PAINTER PWR EQMT		BLD		27.260	28.760	1.5	1.5	2.0	6.130	6.950	0.000	0.450
PAINTER PWR EQMT		HWY		31.560	33.060	1.5	1.5	2.0	6.130	6.950	0.000	0.450
PILEDRIVER		BLD		30.490	31.990	1.5	1.5	2.0	6.050	5.750	0.000	0.350
PILEDRIVER		HWY		30.440	31.940	1.5	1.5	2.0	6.050	5.750	0.000	0.350
PIPEFITTER		BLD		38.050	41.850	1.5	2.0	2.0	7.600	5.500	0.000	1.100
PLASTERER		BLD		26.750	28.250	1.5	1.5	2.0	5.900	4.800	0.000	0.300
PLUMBER		BLD		38.050	41.850	1.5	2.0	2.0	7.600	5.500	0.000	1.100
ROOFER		BLD		22.250	23.250	1.5	1.5	2.0	7.900	3.800	0.000	0.000
SHEETMETAL WORKER		ALL		31.390	32.890	1.5	1.5	2.0	6.430	6.490	1.890	0.360
SPRINKLER FITTER		BLD		36.140	38.890	1.5	1.5	2.0	8.100	8.200	0.000	0.350
STONE MASON		BLD		27.220	28.720	1.5	1.5	2.0	7.950	6.690	0.000	0.430
TERRAZZO FINISHER		BLD		25.720	0.000	1.5	1.5	2.0	7.950	6.690	0.000	0.430
TERRAZZO MASON		BLD		28.500	28.800	1.5	1.5	2.0	6.400	5.700	0.000	0.430
TRUCK DRIVER		ALL 1		28.430	0.000	1.5	1.5	2.0	9.050	5.500	0.000	0.250
TRUCK DRIVER		ALL 2		28.850	0.000	1.5	1.5	2.0	9.050	5.500	0.000	0.250
TRUCK DRIVER		ALL 3		29.050	0.000	1.5	1.5	2.0	9.050	5.500	0.000	0.250
TRUCK DRIVER		ALL 4		29.320	0.000	1.5	1.5	2.0	9.050	5.500	0.000	0.250
TRUCK DRIVER		ALL 5		30.100	0.000	1.5	1.5	2.0	9.050	5.500	0.000	0.250
TRUCK DRIVER		O&C 1		22.750	0.000	1.5	1.5	2.0	2.920	6.700	0.000	0.250
TRUCK DRIVER		O&C 2		19.150	0.000	1.5	1.5	2.0	2.920	6.700	0.000	0.250
TRUCK DRIVER		O&C 3		19.650	0.000	1.5	1.5	2.0	2.920	6.700	0.000	0.250
TUCKPOINTER		BLD		27.220	28.720	1.5	1.5	2.0	7.950	6.690	0.000	0.430

Legend :

M-F>8 (Overtime is required for any hour greater than 8 worked each day, Monday through Friday.)

OSA (Overtime is required for every hour worked on Saturday)

OSH (Overtime is required for every hour worked on Sunday and Holidays)

H/W (Health & Welfare Insurance)

Pensn (Pension)

Vac (Vacation)

Trng (Training)

## Explanations

### JOHNSON COUNTY

The following list is considered as those days for which holiday rates of wages for work performed apply: New Years Day, Memorial Day, Fourth of July, Labor Day, Thanksgiving Day, Christmas Day and Veterans Day in some classifications/counties. Generally, any of these holidays which fall on a Sunday is celebrated on the following Monday. This then makes work performed on that Monday payable at the appropriate overtime rate for holiday pay. Common practice in a given local may alter certain days of celebration. If in doubt, please check with IDOL.

Oil and chip resealing (O&C) means the application of road oils and liquid asphalt to coat an existing road surface, followed by application of aggregate chips or gravel to coated surface, and subsequent rolling of material to seal the surface.

### EXPLANATION OF CLASSES

ASBESTOS - GENERAL - removal of asbestos material/mold and hazardous materials from any place in a building, including mechanical systems where those mechanical systems are to be removed. This includes the removal of asbestos materials/mold and hazardous materials from ductwork or pipes in a building when the building is to be demolished at the time or at some close future date.

ASBESTOS - MECHANICAL - removal of asbestos material from mechanical systems, such as pipes, ducts, and boilers, where the mechanical systems are to remain.

### LABORER - OIL AND CHIP RESEALING ONLY

Hook and unhook chip box from aggregate truck; distribute material within chip box; perform flagging work related to oil and chip resealing; hand spray oil fluids; handle traffic control, including setting-up and maintaining barricades, drums, cones, delineators, signs and other such items, as well as laying-out and applying or removing temporary roadway markings used to control traffic in job site related to oil and chip resealing; and perform clean-up related to oil and chip resealing.

CERAMIC TILE FINISHER, MARBLE FINISHER, TERRAZZO FINISHER

Assisting, helping or supporting the tile, marble and terrazzo mechanic by performing their historic and traditional work assignments required to complete the proper installation of the work covered by said crafts. The term "Ceramic" is used for naming the classification only, and is in no a limitation of the product handled. Ceramic takes into consideration most hard tiles.

ELECTRONIC SYSTEMS TECHNICIAN

Installation, service and maintenance of low-voltage systems which utilizes the transmission and/or transference of voice, sound, vision, or digital for commercial, education, security and entertainment purposes for the following: TV monitoring and surveillance, background/foreground music, intercom and telephone interconnect, field programming, inventory control systems, microwave transmission, multi-media, multiplex, radio page, school, intercom and sound burglar alarms and low voltage master clock systems.

Excluded from this classification are energy management systems, life safety systems, supervisory controls and data acquisition systems not intrinsic with the above listed systems, fire alarm systems, nurse call systems and raceways exceeding fifteen feet in length.

TRUCK DRIVER - BUILDING, HEAVY AND HIGHWAY CONSTRUCTION

Class 1. Drivers on 2 axle trucks hauling less than 9 ton. Air compressor and welding machines and brooms, including those pulled by separate units, truck driver helpers, warehouse employees, mechanic helpers, greasers and tiremen, pickup trucks when hauling materials, tools, or workers to and from and on-the-job site, and fork lifts up to 6,000 lb. capacity.

Class 2. Two or three axle trucks hauling more than 9 ton but hauling less than 16 ton. A-frame winch trucks, hydrolift trucks, vector trucks or similar equipment when used for transportation purposes. Fork lifts over 6,000 lb. capacity, winch trucks, four axle combination units, and ticket writers.

Class 3. Two, three or four axle trucks hauling 16 ton or more. Drivers on water pulls, articulated dump trucks, mechanics and working forepersons, and dispatchers. Five axle or more combination units.

Class 4. Low Boy and Oil Distributors.

Class 5. Drivers who require special protective clothing while employed on hazardous waste work.

TRUCK DRIVER - O & C (Oil and Chip Resealing ONLY)

It involves driving of contractor or subcontractor owned, leased, or hired pickup, dump, service, or oil distributor trucks. Includes transporting materials and equipment (including, but not limited to oils, aggregate supplies, parts, machinery and tools) to or from the job site; distributing oil or liquid asphalt and aggregate; stock piling material; and maintaining trucks at job site related to oil and chip resealing.

Class 1. Distributors, liquid asphalt hauling and hauling of asphalt rubber-tired rollers.

Class 2. Stockpiling.

Class 3. Tandem hauling to job site.

OPERATING ENGINEERS - BUILDING, HEAVY AND HIGHWAY CONSTRUCTION

Class 1. APSCO or Equal Spreading Machine, Backhoe, Backfiller, Boom or Winch Cat, Bituminous Mixplane Machine, Blacksmith, Bituminous Surfacing Machine, Bull-Dozer, Crane, Shovel, Dragline, Truck Crane, Pile Driver, Concrete Breaker, Concrete or Pumpcrete Pumps, Dinky or Standard Locomotives, Well or Caisson Drills, Elevating Grader, Fork Lifts, Flexplane, Gradeall, Hi-Lift Hoists, Guy-Derricks, Hysters, Mechanic Motor Patrol, Mixers-21 cu. ft. or over, Push Cats, Pulls and Scrapers, Two Well Point Pumps, Pulverizer or Tiller, PugMill, Rubber-Tired Farm Type Tractor with Bulldozer/Blade/Auger or hi-lift over 1/2 yd., Jersey Spreader, Tract-Air used with Drill or Hi-Lift, Trenching or Ditching Machines, Wood Chipper w/Tractor, Self-Propelled Roller w/Blade, Equipment Greaser, Self-Propelled Bump Grinder on Concrete pavement, Boat Operator, Skid-Loaders, Tuggers, Lazer Screed, and Self-Propelled Chip Spreader (when others run conveyors).

Class 2. Any type tractor pulling any type roller or disc, Two Air Compressors (220 cu. ft. capacity or over), Two AirTract Drills, Air-Track Drill w/Compressor, Automatic Bins or Scales w/Compressor or Generator, Pipeline Boring Machine, Bulk Cement Plant w/Separate Compressor, Power Operated Bull Float, Hydra-Lift w/Single Motor, Straw Mulcher Blower w/Spout, Self-Propelled Roller/Compactor, Back-End man on Bituminous Surfacing Machine, oiler on milling machine.

Class 3. Air Compressor w/Valve driving piling, Boom or Winch Type Truck, Two Conveyors, Self-Propelled Concrete Saw, Form Grader, Truck Crane Oiler, Self-Propelled Vibrator, Rubber Tired Farm Type Tractor w/Blade/Bulldozer/Auger/hi-lift - 1/2 yd. or less, Elevator Operator, Man Lift (scissor lift) when lifting materials.

Class 4. Air-Track Drill (one), Belt Drag Machine, Power Broom, Mechanical Plasterer Applicator, Trac-Air, Air Compressor (220 cu. ft. or over) One, Air Compressor (under 220 cu. ft) four, Automatic Bin, Bulk Cement Plant w/Built-in Compressor running off same motor or electric motor, Fireman or Switchman, Self-Propelled Form Tamper, Light Plants (4), Welding Machines (4), Pumps (4), or Combination of four (4) Pumps, Light Plants, Welding Machines, Air-Compressors (under 220 cu. ft.), Mudjacks or Wood Chipper, Mixers - less than 21 cu. ft. Mortar Mixer w/Skip or Pump, Pipeline Tract Jack. One Operating Engineer may operate and maintain any combination of the following pieces of equipment, not to exceed four (4) which shall be within a reasonable distance, such combination may include any equipment in this classification: (Compressors, Light Plants, Generators, Welding Machines, Pumps or Conveyors), One Well- Point Pump, Two Motor Driven Heaters, One Air Compressor (under 220 cu. ft.), One Engine-Driven Conveyor, One Motor Driven Heater, One Light Plant, One Pump, One Welding Machine, One Ulmac or Equal Spreader, Oilers, and one Generator 10 kw or greater.

OPERATING ENGINEER - O & C (Oil and Chip Resealing ONLY). Includes the operation of all motorized heavy equipment used in oil and chip rsealing, including but not limited to operating self-propelled chip spreaders, and all types of rollers (both hard and rubber tired); and other duties pertaining to the operation or maintenance of heavy equipment related to oil and chip resealing.

Class 1. See Class 1 above for types of equipment operated.

Class 2. See Class 2 above for types of equipment operated.

Class 3. See Class 3 above for types of equipment operated.

Class 4. See Class 4 above for types of equipment operated.

OPERATING ENGINEER RIVER WORK 1 - operate the following machines when working on River Work and Levee Work on the Mississippi and Ohio Rivers, Lakes and Tributaries: Crane, Shovel, Drageline, Scrapers, Dredge, Derrick, Pile-Driver, Push Boat, all power boat operators, Mechanic, Engineman on Dredge, Leverman on Dredge, All Bituminous Spreader machines, Backhoe, Backfiller, Boom, or Winch Cat, Bituminous Mixplane Machine, Blacksmith, Bituminous Surfacing Machine, Bulldozer, Truck Cranes, Hydraulic Truck Mounted Boom/Crane, Concrete Finishing Machine, or Spreader Machine, Concrete Breaker, Concrete or Pumpcrete Machines, Concrete Plant Operator, All Off Road Material Hauling Equipment, Dinky or Standard Locomotives, Well Drill, Elevating Grader, Fork-Lifts, Flexplane, Gradeall, Hi-Lift, Power Handblade Tugger type Hoist, Hoist Two Drum (or over one), Gyderrick, Hyster, Motor Patrol, Mixers - 21 Cu. Ft. or over, Push Cat, Pulls, & Scrapers, Pumps-Two Well Points, Equipment Greaser, P & H Pulverizer or Pulverizer equal to Pugmill, Pugmill, Rubber-Tired farm type tractor w/Bulldozer/Blade/Auger or Hi-Lift over ½ yard, Skimmer Scoops, Seaman Tiller, Jersey Spreader, Tract-Air used with Drill or Hi-Lift, Trenching or Ditching Machine, Wood Chipper w/Tractor, self-propelled roller w/Blade, Concrete Pumps and Small Equipment Operators.

OPERATING ENGINEER RIVER 2 - when working on River Work and Levee Work on the Mississippi and Ohio Rivers, Lakes and Tributaries shall be employed as the Oiler or Fireman on Crane, Dragline, Shovel, Dredge, Truck Crane, Pile Driver, Gradeall, Dinky or Standard Locomotive, Guy Derrick, Trenching Machine or Ditching Machine 80 H.P. and over, All Terrain (cherry-picker) with over 40 ton Lifting Capacity, Deck Oiler and Deckhands.

#### Other Classifications of Work:

For definitions of classifications not otherwise set out, the Department generally has on file such definitions which are available. If a task to be performed is not subject to one of the classifications of pay set out, the Department will upon being contacted state which neighboring county has such a classification and provide such rate, such rate being deemed to exist by reference in this document. If no neighboring county rate applies to the task, the Department shall undertake a special determination, such special determination being then deemed to have existed under this determination. If a project requires these, or any classification not listed, please contact IDOL at 217-782-1710 for wage rates or clarifications.

#### LANDSCAPING

Landscaping work falls under the existing classifications for laborer, operating engineer and truck driver. The work performed by landscape plantsman and landscape laborer is covered by the existing classification of laborer. The work performed by landscape operators (regardless of equipment used or its size) is covered by the classifications of operating engineer. The work performed by landscape truck drivers (regardless of size of truck driven) is covered by the classifications of truck driver.

# Massac County Prevailing Wage for May 2011

Trade Name	RG	TYP	C	Base	FRMAN	*M-F>8	OSA	OSH	H/W	Pensn	Vac	Trng
=====	==	===	=	=====	=====	=====	===	===	=====	=====	=====	=====
ASBESTOS ABT-GEN		ALL		24.400	24.850	1.5	1.5	2.0	5.550	9.450	0.000	0.900
ASBESTOS ABT-MEC		BLD		20.800	0.000	2.0	2.0	2.0	5.500	4.200	0.000	0.000
BOILERMAKER		BLD		31.500	34.000	1.5	1.5	2.0	6.820	11.43	1.500	0.350
BRICK MASON		BLD		27.220	28.720	1.5	1.5	2.0	7.950	6.690	0.000	0.430
CARPENTER		BLD		30.490	31.990	1.5	1.5	2.0	6.050	5.750	0.000	0.350
CARPENTER		HWY		30.440	31.940	1.5	1.5	2.0	6.050	5.750	0.000	0.350
CEMENT MASON		BLD		26.750	28.250	1.5	1.5	2.0	5.900	4.800	0.000	0.300
CEMENT MASON		HWY		26.350	27.350	1.5	1.5	2.0	5.900	4.350	0.000	0.300
CERAMIC TILE FNSHER		BLD		25.720	0.000	1.5	1.5	2.0	7.950	6.690	0.000	0.430
ELECTRICIAN		ALL		36.830	39.080	1.5	1.5	2.0	5.350	8.470	0.000	0.730
ELECTRONIC SYS TECH		BLD		29.530	31.280	1.5	1.5	2.0	5.250	3.840	0.000	0.250
FLOOR LAYER		BLD		28.930	29.680	1.5	1.5	2.0	6.050	5.750	0.000	0.350
GLAZIER		BLD		26.330	27.580	1.5	1.5	2.0	4.850	5.200	0.000	0.300
HT/FROST INSULATOR		BLD		28.920	29.920	1.5	1.5	2.0	4.800	8.160	0.000	0.280
IRON WORKER		ALL		26.740	28.740	1.5	1.5	2.0	5.760	9.590	0.000	0.500
LABORER		BLD		24.400	24.850	1.5	1.5	2.0	5.550	9.450	0.000	0.800
LABORER		HWY		24.400	24.850	1.5	1.5	2.0	5.550	9.450	0.000	0.800
LABORER		O&C		17.740	18.190	1.5	1.5	2.0	5.450	8.450	0.000	0.800
MACHINIST		BLD		43.160	45.160	1.5	1.5	2.0	7.640	8.700	0.000	0.000
MARBLE FINISHERS		BLD		25.720	0.000	1.5	1.5	2.0	7.950	6.690	0.000	0.430
MARBLE MASON		BLD		27.220	28.720	1.5	1.5	2.0	7.950	6.690	0.000	0.430
MILLWRIGHT		BLD		30.490	31.990	1.5	1.5	2.0	6.050	5.750	0.000	0.350
MILLWRIGHT		HWY		30.440	31.940	1.5	1.5	2.0	6.050	5.750	0.000	0.350
OE RIVER 1		RIV 1		32.100	33.100	1.5	1.5	2.0	6.500	8.300	0.000	1.350
OE RIVER 2		RIV 2		28.750	33.100	1.5	1.5	2.0	6.500	8.300	0.000	1.350
OPERATING ENGINEER		ALL 1		32.100	33.100	1.5	1.5	2.0	6.500	8.300	0.000	1.350
OPERATING ENGINEER		ALL 2		30.200	33.100	1.5	1.5	2.0	6.500	8.300	0.000	1.350
OPERATING ENGINEER		ALL 3		24.150	33.100	1.5	1.5	2.0	6.500	8.300	0.000	1.350
OPERATING ENGINEER		ALL 4		21.400	27.800	1.5	1.5	2.0	5.650	6.100	0.000	1.100
OPERATING ENGINEER		O&C 1		24.080	25.080	1.5	1.5	2.0	6.500	8.300	0.000	1.350
OPERATING ENGINEER		O&C 2		22.650	25.080	1.5	1.5	2.0	6.500	8.300	0.000	1.350
OPERATING ENGINEER		O&C 3		18.120	25.080	1.5	1.5	2.0	6.500	8.300	0.000	1.350
OPERATING ENGINEER		O&C 4		16.050	21.100	1.5	1.5	2.0	5.650	6.100	0.000	1.100
PAINTER		BLD		18.500	19.500	1.5	1.5	2.0	6.500	4.500	0.000	0.050
PAINTER		HWY		24.750	25.750	1.5	1.5	2.0	6.500	4.500	0.000	0.050
PAINTER OVER 30FT		BLD		21.000	22.000	1.5	1.5	2.0	6.500	4.500	0.000	0.050
PAINTER OVER 30FT		HWY		24.250	25.250	1.5	1.5	2.0	5.250	2.750	0.000	0.000
PAINTER PWR EQMT		BLD		18.500	19.500	1.5	1.5	2.0	6.500	4.500	0.000	0.050
PAINTER PWR EQMT		HWY		25.750	26.750	1.5	1.5	2.0	6.500	4.500	0.000	0.050
PILEDRIIVER		BLD		30.490	31.990	1.5	1.5	2.0	6.050	5.750	0.000	0.350
PILEDRIIVER		HWY		30.440	31.940	1.5	1.5	2.0	6.050	5.750	0.000	0.350
PIPEFITTER		BLD		38.050	41.850	1.5	2.0	2.0	7.600	5.500	0.000	1.100
PLASTERER		BLD		26.750	28.250	1.5	1.5	2.0	5.900	4.800	0.000	0.300
PLUMBER		BLD		38.050	41.850	1.5	2.0	2.0	7.600	5.500	0.000	1.100
ROOFER		BLD		26.340	28.340	1.5	1.5	2.0	6.280	4.750	0.000	0.360
SHEETMETAL WORKER		ALL		31.390	32.890	1.5	1.5	2.0	6.430	6.490	1.890	0.360
SPRINKLER FITTER		BLD		36.140	38.890	1.5	1.5	2.0	8.100	8.200	0.000	0.350
STONE MASON		BLD		27.220	28.720	1.5	1.5	2.0	7.950	6.690	0.000	0.430
TERRAZZO FINISHER		BLD		25.720	0.000	1.5	1.5	2.0	7.950	6.690	0.000	0.430
TRUCK DRIVER		ALL 1		28.430	0.000	1.5	1.5	2.0	9.050	5.500	0.000	0.250
TRUCK DRIVER		ALL 2		28.850	0.000	1.5	1.5	2.0	9.050	5.500	0.000	0.250
TRUCK DRIVER		ALL 3		29.050	0.000	1.5	1.5	2.0	9.050	5.500	0.000	0.250
TRUCK DRIVER		ALL 4		29.320	0.000	1.5	1.5	2.0	9.050	5.500	0.000	0.250
TRUCK DRIVER		ALL 5		30.100	0.000	1.5	1.5	2.0	9.050	5.500	0.000	0.250
TRUCK DRIVER		O&C 1		22.750	0.000	1.5	1.5	2.0	2.920	6.700	0.000	0.250
TRUCK DRIVER		O&C 2		19.150	0.000	1.5	1.5	2.0	2.920	6.700	0.000	0.250
TRUCK DRIVER		O&C 3		19.650	0.000	1.5	1.5	2.0	2.920	6.700	0.000	0.250
TUCKPOINTER		BLD		27.220	28.720	1.5	1.5	2.0	7.950	6.690	0.000	0.430



Legend :

M-F>8 (Overtime is required for any hour greater than 8 worked each day, Monday through Friday.)

OSA (Overtime is required for every hour worked on Saturday)

OSH (Overtime is required for every hour worked on Sunday and Holidays)

H/W (Health & Welfare Insurance)

Pensn (Pension)

Vac (Vacation)

Trng (Training)

## Explanations

### MASSAC COUNTY

The following list is considered as those days for which holiday rates of wages for work performed apply: New Years Day, Memorial Day, Fourth of July, Labor Day, Thanksgiving Day, Christmas Day and Veterans Day in some classifications/counties. Generally, any of these holidays which fall on a Sunday is celebrated on the following Monday. This then makes work performed on that Monday payable at the appropriate overtime rate for holiday pay. Common practice in a given local may alter certain days of celebration. If in doubt, please check with IDOL.

Oil and chip resealing (O&C) means the application of road oils and liquid asphalt to coat an existing road surface, followed by application of aggregate chips or gravel to coated surface, and subsequent rolling of material to seal the surface.

### EXPLANATION OF CLASSES

ASBESTOS - GENERAL - removal of asbestos material/mold and hazardous materials from any place in a building, including mechanical systems where those mechanical systems are to be removed. This includes the removal of asbestos materials/mold and hazardous materials from ductwork or pipes in a building when the building is to be demolished at the time or at some close future date.

ASBESTOS - MECHANICAL - removal of asbestos material from mechanical systems, such as pipes, ducts, and boilers, where the mechanical systems are to remain.

### LABORER - OIL AND CHIP RESEALING ONLY

Hook and unhook chip box from aggregate truck; distribute material within chip box; perform flagging work related to oil and chip resealing; hand spray oil fluids; handle traffic control, including setting-up and maintaining barricades, drums, cones, delineators, signs and other such items, as well as laying-out and applying or removing temporary roadway markings used to control traffic in job site related to oil and chip resealing; and perform clean-up related

to oil and chip resealing.

#### CERAMIC TILE FINISHER, MARBLE FINISHER, TERRAZZO FINISHER

Assisting, helping or supporting the tile, marble and terrazzo mechanic by performing their historic and traditional work assignments required to complete the proper installation of the work covered by said crafts. The term "Ceramic" is used for naming the classification only, and is in no a limitation of the product handled. Ceramic takes into consideration most hard tiles.

#### ELECTRONIC SYSTEMS TECHNICIAN

Installation, service and maintenance of low-voltage systems which utilizes the transmission and/or transference of voice, sound, vision, or digital for commercial, education, security and entertainment purposes for the following: TV monitoring and surveillance, background/foreground music, intercom and telephone interconnect, field programming, inventory control systems, microwave transmission, multi-media, multiplex, radio page, school, intercom and sound burglar alarms and low voltage master clock systems.

Excluded from this classification are energy management systems, life safety systems, supervisory controls and data acquisition systems not intrinsic with the above listed systems, fire alarm systems, nurse call systems and raceways exceeding fifteen feet in length.

#### TRUCK DRIVER - BUILDING, HEAVY AND HIGHWAY CONSTRUCTION

Class 1. Drivers on 2 axle trucks hauling less than 9 ton. Air compressor and welding machines and brooms, including those pulled by separate units, truck driver helpers, warehouse employees, mechanic helpers, greasers and tiremen, pickup trucks when hauling materials, tools, or workers to and from and on-the-job site, and fork lifts up to 6,000 lb. capacity.

Class 2. Two or three axle trucks hauling more than 9 ton but hauling less than 16 ton. A-frame winch trucks, hydrolift trucks, vector trucks or similar equipment when used for transportation purposes. Fork lifts over 6,000 lb. capacity, winch trucks, four axle combination units, and ticket writers.

Class 3. Two, three or four axle trucks hauling 16 ton or more. Drivers on water pulls, articulated dump trucks, mechanics and working forepersons, and dispatchers. Five axle or more combination units.

Class 4. Low Boy and Oil Distributors.

Class 5. Drivers who require special protective clothing while employed on hazardous waste work.

#### TRUCK DRIVER - O & C (Oil and Chip Resealing ONLY)

It involves driving of contractor or subcontractor owned, leased, or hired pickup, dump, service, or oil distributor trucks. Includes transporting materials and equipment (including, but not limited to oils, aggregate supplies, parts, machinery and tools) to or from the job site; distributing oil or liquid asphalt and aggregate; stock piling material; and maintaining trucks at job site related to oil and chip resealing.

Class 1. Distributors, liquid asphalt hauling and hauling of asphalt rubber-tired rollers.

Class 2. Stockpiling.

Class 3. Tandem hauling to job site.

OPERATING ENGINEERS - BUILDING, HEAVY AND HIGHWAY CONSTRUCTION

Class 1. APSCO or Equal Spreading Machine, Backhoe, Backfiller, Boom or Winch Cat, Bituminous Mixplane Machine, Blacksmith, Bituminous Surfacing Machine, Bull-Dozer, Crane, Shovel, Dragline, Truck Crane, Pile Driver, Concrete Breaker, Concrete or Pumpcrete Pumps, Dinky or Standard Locomotives, Well or Caisson Drills, Elevating Grader, Fork Lifts, Flexplane, Gradeall, Hi-Lift Hoists, Guy-Derricks, Hysters, Mechanic Motor Patrol, Mixers-21 cu. ft. or over, Push Cats, Pulls and Scrapers, Two Well Point Pumps, Pulverizer or Tiller, PugMill, Rubber-Tired Farm Type Tractor with Bulldozer/Blade/Auger or hi-lift over 1/2 yd., Jersey Spreader, Tract-Air used with Drill or Hi-Lift, Trenching or Ditching Machines, Wood Chipper w/Tractor, Self-Propelled Roller w/Blade, Equipment Greaser, Self-Propelled Bump Grinder on Concrete pavement, Boat Operator, Skid-Loaders, Tuggers, Lazer Screed, and Self-Propelled Chip Spreader (when others run conveyors).

Class 2. Any type tractor pulling any type roller or disc, Two Air Compressors (220 cu. ft. capacity or over), Two AirTract Drills, Air-Track Drill w/Compressor, Automatic Bins or Scales w/Compressor or Generator, Pipeline Boring Machine, Bulk Cement Plant w/Separate Compressor, Power Operated Bull Float, Hydra-Lift w/Single Motor, Straw Mulcher Blower w/Spout, Self-Propelled Roller/Compactor, Back-End man on Bituminous Surfacing Machine, oiler on milling machine.

Class 3. Air Compressor w/Valve driving piling, Boom or Winch Type Truck, Two Conveyors, Self-Propelled Concrete Saw, Form Grader, Truck Crane Oiler, Self-Propelled Vibrator, Rubber Tired Farm Type Tractor w/Blade/Bulldozer/Auger/hi-lift - 1/2 yd. or less, Elevator Operator, Man Lift (scissor lift) when lifting materials.

Class 4. Air-Track Drill (one), Belt Drag Machine, Power Broom, Mechanical Plasterer Applicator, Trac-Air, Air Compressor (220 cu. ft. or over) One, Air Compressor (under 220 cu. ft) four, Automatic Bin, Bulk Cement Plant w/Built-in Compressor running off same motor or electric motor, Fireman or Switchman, Self-Propelled Form Tamper, Light Plants (4), Welding Machines (4), Pumps (4), or Combination of four (4) Pumps, Light Plants, Welding Machines, Air-Compressors (under 220 cu. ft.), Mudjacks or Wood Chipper, Mixers - less than 21 cu. ft. Mortar Mixer w/Skip or Pump, Pipeline Tract Jack. One Operating Engineer may operate and maintain any combination of the following pieces of equipment, not to exceed four (4) which shall be within a reasonable distance, such combination may include any equipment in this classification: (Compressors, Light Plants, Generators, Welding Machines, Pumps or Conveyors), One Well- Point Pump, Two Motor Driven Heaters, One Air Compressor (under 220 cu. ft.), One Engine-Driven Conveyor, One Motor Driven Heater, One Light Plant, One Pump, One Welding Machine, One Ulmac or Equal Spreader, Oilers, and one Generator 10 kw or greater.

OPERATING ENGINEER - O & C (Oil and Chip Resealing ONLY). Includes the operation of all motorized heavy equipment used in oil and chip rsealing, including but not limited to operating self-propelled chip spreaders, and all types of rollers (both hard and rubber tired); and other duties pertaining to the operation or maintenance of heavy equipment related to oil and chip resealing.

Class 1. See Class 1 above for types of equipment operated.

Class 2. See Class 2 above for types of equipment operated.

Class 3. See Class 3 above for types of equipment operated.

Class 4. See Class 4 above for types of equipment operated.

OPERATING ENGINEER RIVER WORK 1 - operate the following machines when working on River Work and Levee Work on the Mississippi and Ohio Rivers, Lakes and Tributaries: Crane, Shovel, Drageline, Scrapers, Dredge, Derrick, Pile-Driver, Push Boat, all power boat operators, Mechanic, Engineman on Dredge, Leverman on Dredge, All Bituminous Spreader machines, Backhoe, Backfiller, Boom, or Winch Cat, Bituminous Mixplane Machine, Blacksmith, Bituminous Surfacing Machine, Bulldozer, Truck Cranes, Hydraulic Truck Mounted Boom/Crane, Concrete Finishing Machine, or Spreader Machine, Concrete Breaker, Concrete or Pumpcrete Machines, Concrete Plant Operator, All Off Road Material Hauling Equipment, Dinky or Standard Locomotives, Well Drill, Elevating Grader, Fork-Lifts, Flexplane, Gradeall, Hi-Lift, Power Handblade Tugger type Hoist, Hoist Two Drum (or over one), Gyderrick, Hyster, Motor Patrol, Mixers - 21 Cu. Ft. or over, Push Cat, Pulls, & Scrapers, Pumps-Two Well Points, Equipment Greaser, P & H Pulverizer or Pulverizer equal to Pugmill, Pugmill, Rubber-Tired farm type tractor w/Bulldozer/Blade/Auger or Hi-Lift over ½ yard, Skimmer Scoops, Seaman Tiller, Jersey Spreader, Tract-Air used with Drill or Hi-Lift, Trenching or Ditching Machine, Wood Chipper w/Tractor, self-propelled roller w/Blade, Concrete Pumps and Small Equipment Operators.

OPERATING ENGINEER RIVER 2 - when working on River Work and Levee Work on the Mississippi and Ohio Rivers, Lakes and Tributaries shall be employed as the Oiler or Fireman on Crane, Dragline, Shovel, Dredge, Truck Crane, Pile Driver, Gradeall, Dinky or Standard Locomotive, Guy Derrick, Trenching Machine or Ditching Machine 80 H.P. and over, All Terrain (cherry-picker) with over 40 ton Lifting Capacity, Deck Oiler and Deckhands.

Other Classifications of Work:

For definitions of classifications not otherwise set out, the Department generally has on file such definitions which are available. If a task to be performed is not subject to one of the classifications of pay set out, the Department will upon being contacted state which neighboring county has such a classification and provide such rate, such rate being deemed to exist by reference in this document. If no neighboring county rate applies to the task, the Department shall undertake a special determination, such special determination being then deemed to have existed under this determination. If a project requires these, or any classification not listed, please contact IDOL at 217-782-1710 for wage rates or clarifications.

#### LANDSCAPING

Landscaping work falls under the existing classifications for laborer, operating engineer and truck driver. The work performed by landscape plantsman and landscape laborer is covered by the existing classification of laborer. The work performed by landscape operators (regardless of equipment used or its size) is covered by the classifications of operating engineer. The work performed by landscape truck drivers (regardless of size of truck driven) is covered by the classifications of truck driver.

# Perry County Prevailing Wage for May 2011

Trade Name	RG	TYP	C	Base	FRMAN	*M-F>8	OSA	OSH	H/W	Pensn	Vac	Trng
=====	==	===	=	=====	=====	=====	===	===	=====	=====	=====	=====
ASBESTOS ABT-GEN		ALL		24.400	24.850	1.5	1.5	2.0	5.550	9.450	0.000	0.900
ASBESTOS ABT-MEC		BLD		28.710	29.710	1.5	1.5	2.0	6.400	2.500	0.000	0.000
BOILERMAKER		BLD		31.500	34.000	1.5	1.5	2.0	6.820	11.43	1.500	0.350
BRICK MASON		BLD		27.220	28.720	1.5	1.5	2.0	7.950	6.690	0.000	0.430
CARPENTER		BLD		30.490	31.990	1.5	1.5	2.0	6.050	5.750	0.000	0.350
CARPENTER		HWY		30.440	31.940	1.5	1.5	2.0	6.050	5.750	0.000	0.350
CEMENT MASON		BLD		26.750	28.250	1.5	1.5	2.0	5.900	4.800	0.000	0.300
CEMENT MASON		HWY		26.350	27.350	1.5	1.5	2.0	5.900	4.350	0.000	0.300
CERAMIC TILE FNSHER		BLD		25.720	0.000	1.5	1.5	2.0	7.950	6.690	0.000	0.430
ELECTRICIAN		ALL		36.830	39.080	1.5	1.5	2.0	5.350	8.470	0.000	0.730
ELECTRONIC SYS TECH		BLD		29.530	31.280	1.5	1.5	2.0	5.250	3.840	0.000	0.250
ELEVATOR CONSTRUCTOR		BLD		42.195	47.470	2.0	2.0	2.0	10.53	10.71	2.530	0.000
FLOOR LAYER		BLD		28.930	29.680	1.5	1.5	2.0	6.050	5.750	0.000	0.350
GLAZIER		BLD		31.680	0.000	2.0	2.0	2.0	9.020	10.30	2.540	0.310
HT/FROST INSULATOR		BLD		36.260	37.260	1.5	1.5	2.0	7.150	10.46	0.000	0.500
IRON WORKER		ALL		30.350	32.350	1.5	1.5	2.0	6.360	11.85	0.000	0.420
LABORER		BLD		24.400	24.850	1.5	1.5	2.0	5.550	9.450	0.000	0.800
LABORER		HWY		24.400	24.850	1.5	1.5	2.0	5.550	9.450	0.000	0.800
LABORER		O&C		17.740	18.190	1.5	1.5	2.0	5.450	8.450	0.000	0.800
MACHINIST		BLD		43.160	45.160	1.5	1.5	2.0	7.640	8.700	0.000	0.000
MARBLE FINISHERS		BLD		25.720	0.000	1.5	1.5	2.0	7.950	6.690	0.000	0.430
MARBLE MASON		BLD		27.220	28.720	1.5	1.5	2.0	7.950	6.690	0.000	0.430
MILLWRIGHT		BLD		30.490	31.990	1.5	1.5	2.0	6.050	5.750	0.000	0.350
MILLWRIGHT		HWY		30.440	31.940	1.5	1.5	2.0	6.050	5.750	0.000	0.350
OPERATING ENGINEER		BLD 1		32.000	35.000	1.5	1.5	2.0	8.050	15.50	0.000	1.000
OPERATING ENGINEER		BLD 2		30.870	35.000	1.5	1.5	2.0	8.050	15.50	0.000	1.000
OPERATING ENGINEER		BLD 3		26.390	35.000	1.5	1.5	2.0	8.050	15.50	0.000	1.000
OPERATING ENGINEER		BLD 4		26.450	35.000	1.5	1.5	2.0	8.050	15.50	0.000	1.000
OPERATING ENGINEER		BLD 5		26.120	35.000	1.5	1.5	2.0	8.050	15.50	0.000	1.000
OPERATING ENGINEER		BLD 6		32.550	35.000	1.5	1.5	2.0	8.050	15.50	0.000	1.000
OPERATING ENGINEER		BLD 7		32.850	35.000	1.5	1.5	2.0	8.050	15.50	0.000	1.000
OPERATING ENGINEER		BLD 8		33.130	35.000	1.5	1.5	2.0	8.050	15.50	0.000	1.000
OPERATING ENGINEER		BLD 9		34.000	35.000	1.5	1.5	2.0	8.050	15.50	0.000	1.000
OPERATING ENGINEER		HWY 1		30.500	33.500	1.5	1.5	2.0	8.050	15.50	0.000	1.000
OPERATING ENGINEER		HWY 2		29.370	33.500	1.5	1.5	2.0	8.050	15.50	0.000	1.000
OPERATING ENGINEER		HWY 3		24.890	33.500	1.5	1.5	2.0	8.050	15.50	0.000	1.000
OPERATING ENGINEER		HWY 4		24.950	33.500	1.5	1.5	2.0	8.050	15.50	0.000	1.000
OPERATING ENGINEER		HWY 5		24.620	33.500	1.5	1.5	2.0	8.050	15.50	0.000	1.000
OPERATING ENGINEER		HWY 6		31.050	33.500	1.5	1.5	2.0	8.050	15.50	0.000	1.000
OPERATING ENGINEER		HWY 7		31.350	33.500	1.5	1.5	2.0	8.050	15.50	0.000	1.000
OPERATING ENGINEER		HWY 8		31.630	33.500	1.5	1.5	2.0	8.050	15.50	0.000	1.000
OPERATING ENGINEER		HWY 9		32.500	33.500	1.5	1.5	2.0	8.050	15.50	0.000	1.000
OPERATING ENGINEER		O&C 1		24.080	25.080	1.5	1.5	2.0	6.500	8.300	0.000	1.350
OPERATING ENGINEER		O&C 2		22.650	25.080	1.5	1.5	2.0	6.500	8.300	0.000	1.350
OPERATING ENGINEER		O&C 3		18.120	25.080	1.5	1.5	2.0	6.500	8.300	0.000	1.350
OPERATING ENGINEER		O&C 4		16.050	21.100	1.5	1.5	2.0	5.650	6.100	0.000	1.100
PAINTER		BLD		26.260	27.760	1.5	1.5	2.0	6.130	6.950	0.000	0.450
PAINTER		HWY		30.560	32.060	1.5	1.5	2.0	6.130	6.950	0.000	0.450
PAINTER OVER 30FT		BLD		27.260	28.760	1.5	1.5	2.0	6.130	6.950	0.000	0.450
PAINTER PWR EQMT		BLD		27.260	28.760	1.5	1.5	2.0	6.130	6.950	0.000	0.450
PAINTER PWR EQMT		HWY		31.560	33.060	1.5	1.5	2.0	6.130	6.950	0.000	0.450
PILEDRIVER		BLD		30.490	31.990	1.5	1.5	2.0	6.050	5.750	0.000	0.350
PILEDRIVER		HWY		30.440	31.940	1.5	1.5	2.0	6.050	5.750	0.000	0.350
PIPEFITTER		BLD		38.050	41.850	1.5	2.0	2.0	7.600	5.500	0.000	1.100
PLASTERER		BLD		26.750	28.250	1.5	1.5	2.0	5.900	4.800	0.000	0.300
PLUMBER		BLD		38.050	41.850	1.5	2.0	2.0	7.600	5.500	0.000	1.100
ROOFER		BLD		22.250	23.250	1.5	1.5	2.0	7.900	3.800	0.000	0.000
SHEETMETAL WORKER		ALL		31.390	32.890	1.5	1.5	2.0	6.430	6.490	1.890	0.360

SPRINKLER FITTER	BLD	36.140	38.890	1.5	1.5	2.0	8.100	8.200	0.000	0.350
STONE MASON	BLD	27.220	28.720	1.5	1.5	2.0	7.950	6.690	0.000	0.430
TERRAZZO FINISHER	BLD	25.720	0.000	1.5	1.5	2.0	7.950	6.690	0.000	0.430
TERRAZZO MASON	BLD	27.220	28.720	1.5	1.5	2.0	7.950	6.690	0.000	0.430
TRUCK DRIVER	ALL 1	28.430	0.000	1.5	1.5	2.0	9.050	5.500	0.000	0.250
TRUCK DRIVER	ALL 2	28.850	0.000	1.5	1.5	2.0	9.050	5.500	0.000	0.250
TRUCK DRIVER	ALL 3	29.050	0.000	1.5	1.5	2.0	9.050	5.500	0.000	0.250
TRUCK DRIVER	ALL 4	29.320	0.000	1.5	1.5	2.0	9.050	5.500	0.000	0.250
TRUCK DRIVER	ALL 5	30.100	0.000	1.5	1.5	2.0	9.050	5.500	0.000	0.250
TRUCK DRIVER	O&C 1	22.750	0.000	1.5	1.5	2.0	2.920	6.700	0.000	0.250
TRUCK DRIVER	O&C 2	19.150	0.000	1.5	1.5	2.0	2.920	6.700	0.000	0.250
TRUCK DRIVER	O&C 3	19.650	0.000	1.5	1.5	2.0	2.920	6.700	0.000	0.250
TUCKPOINTER	BLD	27.220	28.720	1.5	1.5	2.0	7.950	6.690	0.000	0.430

Legend:

M-F>8 (Overtime is required for any hour greater than 8 worked each day, Monday through Friday.)

OSA (Overtime is required for every hour worked on Saturday)

OSH (Overtime is required for every hour worked on Sunday and Holidays)

H/W (Health & Welfare Insurance)

Pensn (Pension)

Vac (Vacation)

Trng (Training)

## Explanations

### PERRY COUNTY

The following list is considered as those days for which holiday rates of wages for work performed apply: New Years Day, Memorial Day, Fourth of July, Labor Day, Thanksgiving Day, Christmas Day and Veterans Day in some classifications/counties. Generally, any of these holidays which fall on a Sunday is celebrated on the following Monday. This then makes work performed on that Monday payable at the appropriate overtime rate for holiday pay. Common practice in a given local may alter certain days of celebration. If in doubt, please check with IDOL.

OIL AND CHIP RESEALING means the application of road oils and liquid asphalt to coat an existing road surface, followed by application of aggregate chips or gravel to coated surface, and subsequent rolling of material to seal the surface.

### EXPLANATION OF CLASSES

ASBESTOS - GENERAL - removal of asbestos material/mold and hazardous materials from any place in a building, including mechanical systems where those mechanical systems are to be removed. This includes the removal of asbestos materials/mold and hazardous materials from ductwork or pipes in a building when the building is to be demolished at the time or at some close future date.

ASBESTOS - MECHANICAL - removal of asbestos material from mechanical

systems, such as pipes, ducts, and boilers, where the mechanical systems are to remain.

#### LABORER - OIL AND CHIP RESEALING ONLY

Hook and unhook chip box from aggregate truck; distribute material within chip box; perform flagging work related to oil and chip resealing; hand spray oil fluids; handle traffic control, including setting-up and maintaining barricades, drums, cones, delineators, signs and other such items, as well as laying-out and applying or removing temporary roadway markings used to control traffic in job site related to oil and chip resealing; and perform clean-up related to oil and chip resealing.

#### CERAMIC TILE FINISHER, MARBLE FINISHER, TERRAZZO FINISHER

Assisting, helping or supporting the tile, marble and terrazzo mechanic by performing their historic and traditional work assignments required to complete the proper installation of the work covered by said crafts. The term "Ceramic" is used for naming the classification only, and is in no a limitation of the product handled. Ceramic takes into consideration most hard tiles.

#### ELECTRONIC SYSTEMS TECHNICIAN

Installation, service and maintenance of low-voltage systems which utilizes the transmission and/or transference of voice, sound, vision, or digital for commercial, education, security and entertainment purposes for the following: TV monitoring and surveillance, background/foreground music, intercom and telephone interconnect, field programming, inventory control systems, microwave transmission, multi-media, multiplex, radio page, school, intercom and sound burglar alarms and low voltage master clock systems.

Excluded from this classification are energy management systems, life safety systems, supervisory controls and data acquisition systems not intrinsic with the above listed systems, fire alarm systems, nurse call systems and raceways exceeding fifteen feet in length.

#### OPERATING ENGINEER - BUILDING

GROUP I. Cranes, Dragline, Shovels, Skimmer Scoops, Clamshells or Derrick Boats, Pile Drivers, Crane-Type Backhoes, Asphalt Plant Operators, Concrete Plant Operators, Dredges, Asphalt Spreading Machines, All Locomotives, Cable Ways or Tower Machines, Hoists, Hydraulic Backhoes, Ditching Machines or Backfiller, Cherrypickers, Overhead Cranes, Roller - Steam or Gas, Concrete Pavers, Excavators, Concrete Breakers, Concrete Pumps, Bulk Cement Plants, Cement Pumps, Derrick-Type Drills, Boat Operators, Motor Graders or Pushcats, Scoops or Tournapulls, Bulldozers, Endloaders or Fork Lifts, Power Blade or Elevating Graders, Winch Cats, Boom or Winch Trucks or Boom Tractors, Pipe Wrapping or Painting Machines, Asphalt Plant Engineer, Journeyman Lubricating Engineer, Drills (other than Derrick Type), Mud Jacks, or Well Drilling Machines, Boring Machines or Track Jacks, Mixers, Conveyors (Two), Air Compressors (Two), Water Pumps regardless of size (Two), Welding Machines (Two), Siphons or Jets (Two), Winch Heads or Apparatuses (Two), Light Plants (Two), All Tractors regardless of size (straight tractor only), Fireman on Stationary Boilers, Automatic Elevators, Form Grading Machines, Finishing Machines, Power Sub-Grader or Ribbon Machines, Longitudinal Floats, Distributor Operators on Trucks, Winch Heads or Apparatuses (One), Mobil Track air and heaters (two to five), Heavy Equipment Greaser, Relief Operator, Assistant Master Mechanic and Heavy Duty Mechanic, self-propelled concrete saws

of all types and sizes with their attachments, gob-hoppers, excavators all sizes, the repair and greasing of all diesel hammers, the operation and set-up of bidwells, water blasters of all sizes and their clutches, hydraulic jacks where used for hoisting, operation of log skidders, iceolators used on and off of pipeline, condor cranes, bow boats, survey boats, bobcats and all their attachments, skid steer loaders and all their attachments, creter cranes, batch plants, operator (all sizes), self propelled roto mills, operation of conveyor systems of any size and any configuration, operation, repair and service of all vibratory hammers, all power pacs and their controls regardless of location, curtains or brush burning machines, stump cutter machines, Nail launchers when mounted on a machine or self-propelled, operation of con-cover machines, and all Operators except those listed below).

GROUP II. Assistant Operators.

GROUP III. Air Compressors (One), Water Pumps, regardless of Size (One), Waterblasters (one), Welding Machine (One), Mixers (One Bag), Conveyor (One), Siphon or Jet (One), Light Plant (One), Heater (One), Immobile Track Air (One), and Self Propelled Walk-Behind Rollers.

GROUP IV. Asphalt Spreader Oilers, Fireman on Whirlies and Heavy Equipment Oilers, Truck Cranes, Dredges, Monigans, Large Cranes - (Over 65-ton rated capacity) Concrete Plant Oiler, Blacktop Plant Oiler, and Creter Crane Oiler (when required).

GROUP V. Oiler.

GROUP VI. Operators on equipment with Booms, including jibs, 100 feet and over, and less than 150 feet long.

GROUP VII. Operators on equipment with Booms, including jibs, 150 feet and over, and less than 200 feet long.

GROUP VIII. Operators on Equipment with Booms, including jibs, 200 feet and over; Tower Cranes; and Whirlie Cranes.

GROUP IX. Master Mechanic

OPERATING ENGINEERS - Highway

GROUP I. Cranes, Dragline, Shovels, Skimmer Scoops, Clamshells or Derrick Boats, Pile Drivers, Crane-Type Backhoes, Asphalt Plant Operators, Concrete Plant Operators, Dredges, Asphalt Spreading Machines, All Locomotives, Cable Ways or Tower Machines, Hoists, Hydraulic Backhoes, Ditching Machines or Backfiller, Cherrypickers, Overhead Cranes, Roller - Steam or Gas, Concrete Pavers, Excavators, Concrete Breakers, Concrete Pumps, Bulk Cement Plants, Cement Pumps, Derrick-Type Drills, Boat Operators, Motor Graders or Pushcats, Scoops or Tournapulls, Bulldozers, Endloaders or Fork Lifts, Power Blade or Elevating Graders, Winch Cats, Boom or Winch Trucks or Boom Tractors, Pipe Wrapping or Painting Machines, Asphalt Plant Engineer, Journeyman Lubricating Engineer, Drills (other than Derrick Type), Mud Jacks, Well Drilling Machines, Boring Machines, Track Jacks, Mixers, Conveyors (Two), Air Compressors (Two), Water Pumps regardless of size (Two), Welding Machines (Two), Siphons or Jets (Two), Winch Heads or Apparatuses (Two), Light Plants (Two), All Tractors regardless of size (straight tractor only), Fireman on Stationary Boilers, Automatic Elevators, Form Grading Machines, Finishing Machines, Power Sub-Grader or Ribbon Machines, Longitudinal Floats, Distributor Operators on Trucks, Winch Heads or Apparatuses (One), Mobil Track air and heaters (two to five), Heavy Equipment Greaser, Relief Operator, Assistant



Master Mechanic and Heavy Duty Mechanic, self-propelled concrete saws of all types and sizes with their attachments, gob-hoppers, excavators all sizes, the repair and greasing of all diesel hammers, the operation and set-up of bidwells, water blasters of all sizes and their clutches, hydraulic jacks where used for hoisting, operation of log skidders, iceolators used on and off of pipeline, condor cranes, bow boats, survey boats, bobcats and all their attachments, skid steer loaders and all their attachments, creter cranes, batch plants, operator (all sizes), self propelled roto mills, operation of conveyor systems of any size and any configuration, operation, repair and service of all vibratory hammers, all power pacs and their controls regardless of location, curtains or brush burning machines, stump cutter machines, Nail launchers when mounted on a machine or self-propelled, operation of con-cover machines, and all Operators (except those listed below).

GROUP II. Assistant Operators.

GROUP III. Air Compressors (One), Water Pumps, regardless of Size (One), Waterblasters (one), Welding Machine (One), Mixers (One Bag), Conveyor (One), Siphon or Jet (One), Light Plant (One), Heater (One), Immobile Track Air (One), and Self Propelled Walk-Behind Rollers.

GROUP IV. Asphalt Spreader Oilers, Fireman on Whirlies and Heavy Equipment Oilers, Truck Cranes, Dredges, Monigans, Large Cranes - (Over 65-ton rated capacity) Concrete Plant Oiler, Blacktop Plant Oiler, and Creter Crane Oiler (when required).

GROUP V. Oiler.

GROUP VI. Operators on equipment with Booms, including jibs, 100 feet and over, and less than 150 feet long.

GROUP VII. Operators on equipment with Booms, including jibs, 150 feet and over, and less than 200 feet long.

GROUP VIII. Operators on Equipment with Booms, including jibs, 200 feet and over; Tower Cranes; and Whirlie Cranes.

GROUP IX. Mechanic

TRUCK DRIVER - BUILDING, HEAVY AND HIGHWAY CONSTRUCTION

Class 1. Drivers on 2 axle trucks hauling less than 9 ton. Air compressor and welding machines and brooms, including those pulled by separate units, truck driver helpers, warehouse employees, mechanic helpers, greasers and tiremen, pickup trucks when hauling materials, tools, or workers to and from and on-the-job site, and fork lifts up to 6,000 lb. capacity.

Class 2. Two or three axle trucks hauling more than 9 ton but hauling less than 16 ton. A-frame winch trucks, hydrolift trucks, vactor trucks or similar equipment when used for transportation purposes. Fork lifts over 6,000 lb. capacity, winch trucks, four axle combination units, and ticket writers.

Class 3. Two, three or four axle trucks hauling 16 ton or more. Drivers on water pulls, articulated dump trucks, mechanics and working forepersons, and dispatchers. Five axle or more combination units.

Class 4. Low Boy and Oil Distributors.

Class 5. Drivers who require special protective clothing while employed on hazardous waste work.

TRUCK DRIVER - O & C (Oil and Chip Resealing ONLY)

It involves driving of contractor or subcontractor owned, leased, or hired pickup, dump, service, or oil distributor trucks. Includes transporting materials and equipment (including, but not limited to oils, aggregate supplies, parts, machinery and tools) to or from the job site; distributing oil or liquid asphalt and aggregate; stock piling material; and maintaining trucks at job site related to oil and chip resealing.

Class 1. Distributors, liquid asphalt hauling and hauling of asphalt rubber-tired rollers.

Class 2. Stockpiling.

Class 3. Tandem hauling to job site.

OPERATING ENGINEER - O & C (Oil and Chip Resealing ONLY). Includes the operation of all motorized heavy equipment used in oil and chip rsealing, including but not limited to operating self-propelled chip spreaders, and all types of rollers (both hard and rubber tired); and other duties pertaining to the operation or maintenance of heavy equipment related to oil and chip resealing.

Class 1. See Class 1 above for types of equipment operated.

Class 2. See Class 2 above for types of equipment operated.

Class 3. See Class 3 above for types of equipment operated.

Class 4. See Class 4 above for types of equipment operated.

Class 5. See Class 5 above for types of equipment operated.

Other Classifications of Work:

For definitions of classifications not otherwise set out, the Department generally has on file such definitions which are available. If a task to be performed is not subject to one of the classifications of pay set out, the Department will upon being contacted state which neighboring county has such a classification and provide such rate, such rate being deemed to exist by reference in this document. If no neighboring county rate applies to the task, the Department shall undertake a special determination, such special determination being then deemed to have existed under this determination. If a project requires these, or any classification not listed, please contact IDOL at 217-782-1710 for wage rates or clarifications.

LANDSCAPING

Landscaping work falls under the existing classifications for laborer, operating engineer and truck driver. The work performed by landscape plantsman and landscape laborer is covered by the existing classification of laborer. The work performed by landscape operators (regardless of equipment used or its size) is covered by the classifications of operating engineer. The work performed by landscape truck drivers (regardless of size of truck driven) is covered by the classifications of truck driver.

# Pope County Prevailing Wage for May 2011

Trade Name	RG	TYP	C	Base	FRMAN	*M-F>8	OSA	OSH	H/W	Pensn	Vac	Trng
=====	==	===	=	=====	=====	=====	===	===	=====	=====	=====	=====
ASBESTOS ABT-GEN		ALL		24.400	24.850	1.5	1.5	2.0	5.550	9.450	0.000	0.900
ASBESTOS ABT-MEC		BLD		20.800	0.000	2.0	2.0	2.0	5.500	4.200	0.000	0.000
BOILERMAKER		BLD		31.500	34.000	1.5	1.5	2.0	6.820	11.43	1.500	0.350
BRICK MASON		BLD		27.220	28.720	1.5	1.5	2.0	7.950	6.690	0.000	0.430
CARPENTER		BLD		30.490	31.990	1.5	1.5	2.0	6.050	5.750	0.000	0.350
CARPENTER		HWY		30.440	31.940	1.5	1.5	2.0	6.050	5.750	0.000	0.350
CEMENT MASON		BLD		26.750	28.250	1.5	1.5	2.0	5.900	4.800	0.000	0.300
CEMENT MASON		HWY		26.350	27.350	1.5	1.5	2.0	5.900	4.350	0.000	0.300
CERAMIC TILE FNSHER		BLD		25.720	0.000	1.5	1.5	2.0	7.950	6.690	0.000	0.430
ELECTRICIAN		ALL		36.830	39.080	1.5	1.5	2.0	5.350	8.470	0.000	0.730
ELECTRONIC SYS TECH		BLD		29.530	31.280	1.5	1.5	2.0	5.250	3.840	0.000	0.250
FLOOR LAYER		BLD		28.930	29.680	1.5	1.5	2.0	6.050	5.750	0.000	0.350
GLAZIER		BLD		26.330	27.580	1.5	1.5	2.0	4.850	5.200	0.000	0.300
HT/FROST INSULATOR		BLD		28.920	29.920	1.5	1.5	2.0	4.800	8.160	0.000	0.280
IRON WORKER		ALL		26.740	28.740	1.5	1.5	2.0	5.760	9.590	0.000	0.500
LABORER		BLD		24.400	24.850	1.5	1.5	2.0	5.550	9.450	0.000	0.800
LABORER		HWY		24.400	24.850	1.5	1.5	2.0	5.550	9.450	0.000	0.800
LABORER		O&C		17.740	18.190	1.5	1.5	2.0	5.450	8.450	0.000	0.800
MACHINIST		BLD		43.160	45.160	1.5	1.5	2.0	7.640	8.700	0.000	0.000
MARBLE FINISHERS		BLD		25.720	0.000	1.5	1.5	2.0	7.950	6.690	0.000	0.430
MARBLE MASON		BLD		27.220	28.720	1.5	1.5	2.0	7.950	6.690	0.000	0.430
MILLWRIGHT		BLD		30.490	31.990	1.5	1.5	2.0	6.050	5.750	0.000	0.350
MILLWRIGHT		HWY		30.440	31.940	1.5	1.5	2.0	6.050	5.750	0.000	0.350
OE RIVER 1		RIV 1		32.100	33.100	1.5	1.5	2.0	6.500	8.300	0.000	1.350
OE RIVER 2		RIV 2		28.750	33.100	1.5	1.5	2.0	6.500	8.300	0.000	1.350
OPERATING ENGINEER		ALL 1		32.100	33.100	1.5	1.5	2.0	6.500	8.300	0.000	1.350
OPERATING ENGINEER		ALL 2		30.200	33.100	1.5	1.5	2.0	6.500	8.300	0.000	1.350
OPERATING ENGINEER		ALL 3		24.150	33.100	1.5	1.5	2.0	6.500	8.300	0.000	1.350
OPERATING ENGINEER		ALL 4		21.400	27.800	1.5	1.5	2.0	5.650	6.100	0.000	1.100
OPERATING ENGINEER		O&C 1		24.080	25.080	1.5	1.5	2.0	6.500	8.300	0.000	1.350
OPERATING ENGINEER		O&C 2		22.650	25.080	1.5	1.5	2.0	6.500	8.300	0.000	1.350
OPERATING ENGINEER		O&C 3		18.120	25.080	1.5	1.5	2.0	6.500	8.300	0.000	1.350
OPERATING ENGINEER		O&C 4		16.050	21.100	1.5	1.5	2.0	5.650	6.100	0.000	1.100
PAINTER		BLD		26.260	27.760	1.5	1.5	2.0	6.130	6.950	0.000	0.450
PAINTER		HWY		30.560	32.060	1.5	1.5	2.0	6.130	6.950	0.000	0.450
PAINTER OVER 30FT		BLD		27.260	28.760	1.5	1.5	2.0	6.130	6.950	0.000	0.450
PAINTER PWR EQMT		BLD		27.260	28.760	1.5	1.5	2.0	6.130	6.950	0.000	0.450
PAINTER PWR EQMT		HWY		31.560	33.060	1.5	1.5	2.0	6.130	6.950	0.000	0.450
PILEDRIVER		BLD		30.490	31.990	1.5	1.5	2.0	6.050	5.750	0.000	0.350
PILEDRIVER		HWY		30.440	31.940	1.5	1.5	2.0	6.050	5.750	0.000	0.350
PIPEFITTER		BLD		38.050	41.850	1.5	2.0	2.0	7.600	5.500	0.000	1.100
PLASTERER		BLD		26.750	28.250	1.5	1.5	2.0	5.900	4.800	0.000	0.300
PLUMBER		BLD		38.050	41.850	1.5	2.0	2.0	7.600	5.500	0.000	1.100
ROOFER		BLD		22.250	23.250	1.5	1.5	2.0	7.900	3.800	0.000	0.000
SHEETMETAL WORKER		ALL		31.390	32.890	1.5	1.5	2.0	6.430	6.490	1.890	0.360
SPRINKLER FITTER		BLD		36.140	38.890	1.5	1.5	2.0	8.100	8.200	0.000	0.350
STONE MASON		BLD		27.220	28.720	1.5	1.5	2.0	7.950	6.690	0.000	0.430
TERRAZZO FINISHER		BLD		25.720	0.000	1.5	1.5	2.0	7.950	6.690	0.000	0.430
TRUCK DRIVER		ALL 1		28.430	0.000	1.5	1.5	2.0	9.050	5.500	0.000	0.250
TRUCK DRIVER		ALL 2		28.850	0.000	1.5	1.5	2.0	9.050	5.500	0.000	0.250
TRUCK DRIVER		ALL 3		29.050	0.000	1.5	1.5	2.0	9.050	5.500	0.000	0.250
TRUCK DRIVER		ALL 4		29.320	0.000	1.5	1.5	2.0	9.050	5.500	0.000	0.250
TRUCK DRIVER		ALL 5		30.100	0.000	1.5	1.5	2.0	9.050	5.500	0.000	0.250
TRUCK DRIVER		O&C 1		22.750	0.000	1.5	1.5	2.0	2.920	6.700	0.000	0.250
TRUCK DRIVER		O&C 2		19.150	0.000	1.5	1.5	2.0	2.920	6.700	0.000	0.250
TRUCK DRIVER		O&C 3		19.650	0.000	1.5	1.5	2.0	2.920	6.700	0.000	0.250
TUCKPOINTER		BLD		27.220	28.720	1.5	1.5	2.0	7.950	6.690	0.000	0.430

## Legend:

M-F>8 (Overtime is required for any hour greater than 8 worked each day, Monday through Friday.)

OSA (Overtime is required for every hour worked on Saturday)

OSH (Overtime is required for every hour worked on Sunday and Holidays)

H/W (Health & Welfare Insurance)

Pensn (Pension)

Vac (Vacation)

Trng (Training)

# Explanations

## POPE COUNTY

The following list is considered as those days for which holiday rates of wages for work performed apply: New Years Day, Memorial Day, Fourth of July, Labor Day, Thanksgiving Day, Christmas Day and Veterans Day in some classifications/counties. Generally, any of these holidays which fall on a Sunday is celebrated on the following Monday. This then makes work performed on that Monday payable at the appropriate overtime rate for holiday pay. Common practice in a given local may alter certain days of celebration. If in doubt, please check with IDOL.

Oil and chip resealing (O&C) means the application of road oils and liquid asphalt to coat an existing road surface, followed by application of aggregate chips or gravel to coated surface, and subsequent rolling of material to seal the surface.

## EXPLANATION OF CLASSES

ASBESTOS - GENERAL - removal of asbestos material/mold and hazardous materials from any place in a building, including mechanical systems where those mechanical systems are to be removed. This includes the removal of asbestos materials/mold and hazardous materials from ductwork or pipes in a building when the building is to be demolished at the time or at some close future date.

ASBESTOS - MECHANICAL - removal of asbestos material from mechanical systems, such as pipes, ducts, and boilers, where the mechanical systems are to remain.

## LABORER - OIL AND CHIP RESEALING ONLY

Hook and unhook chip box from aggregate truck; distribute material within chip box; perform flagging work related to oil and chip resealing; hand spray oil fluids; handle traffic control, including setting-up and maintaining barricades, drums, cones, delineators, signs and other such items, as well as laying-out and applying or removing temporary roadway markings used to control traffic in job site related to oil and chip resealing; and perform clean-up related to oil and chip resealing.

## CERAMIC TILE FINISHER, MARBLE FINISHER, TERRAZZO FINISHER

Assisting, helping or supporting the tile, marble and terrazzo mechanic by performing their historic and traditional work assignments required to complete the proper installation of the work covered by said crafts. The term "Ceramic" is used for naming the classification only, and is in no a limitation of the product handled. Ceramic takes into consideration most hard tiles.

## ELECTRONIC SYSTEMS TECHNICIAN

Installation, service and maintenance of low-voltage systems which utilizes the transmission and/or transference of voice, sound, vision, or digital for commercial, education, security and entertainment purposes for the following: TV monitoring and surveillance, background/foreground music, intercom and telephone interconnect, field programming, inventory control systems, microwave transmission, multi-media, multiplex, radio page, school, intercom and sound burglar alarms and low voltage master clock systems.

Excluded from this classification are energy management systems, life safety systems, supervisory controls and data acquisition systems not intrinsic with the above listed systems, fire alarm systems, nurse call systems and raceways exceeding fifteen feet in length.

## TRUCK DRIVER - BUILDING, HEAVY AND HIGHWAY CONSTRUCTION

Class 1. Drivers on 2 axle trucks hauling less than 9 ton. Air compressor and welding machines and brooms, including those pulled by separate units, truck driver helpers, warehouse employees, mechanic helpers, greasers and tiremen, pickup trucks when hauling materials, tools, or workers to and from and on-the-job site, and fork lifts up to 6,000 lb. capacity.

Class 2. Two or three axle trucks hauling more than 9 ton but hauling less than 16 ton. A-frame winch trucks, hydrolift trucks, vector trucks or similar equipment when used for transportation purposes. Fork lifts over 6,000 lb. capacity, winch trucks, four axle combination units, and ticket writers.

Class 3. Two, three or four axle trucks hauling 16 ton or more. Drivers on water pulls, articulated dump trucks, mechanics and working forepersons, and dispatchers. Five axle or more combination units.

Class 4. Low Boy and Oil Distributors.

Class 5. Drivers who require special protective clothing while employed on hazardous waste work.

## TRUCK DRIVER - O & C (Oil and Chip Resealing ONLY)

It involves driving of contractor or subcontractor owned, leased, or hired pickup, dump, service, or oil distributor trucks. Includes transporting materials and equipment (including, but not limited to oils, aggregate supplies, parts, machinery and tools) to or from the job site; distributing oil or liquid asphalt and aggregate; stock piling material; and maintaining trucks at job site related to oil and chip resealing.

Class 1. Distributors, liquid asphalt hauling and hauling of asphalt rubber-tired rollers.

Class 2. Stockpiling.

Class 3. Tandem hauling to job site.

OPERATING ENGINEERS - BUILDING, HEAVY AND HIGHWAY CONSTRUCTION

Class 1. APSCO or Equal Spreading Machine, Backhoe, Backfiller, Boom or Winch Cat, Bituminous Mixplane Machine, Blacksmith, Bituminous Surfacing Machine, Bull-Dozer, Crane, Shovel, Dragline, Truck Crane, Pile Driver, Concrete Breaker, Concrete or Pumpcrete Pumps, Dinky or Standard Locomotives, Well or Caisson Drills, Elevating Grader, Fork Lifts, Flexplane, Gradeall, Hi-Lift Hoists, Guy-Derricks, Hysters, Mechanic Motor Patrol, Mixers-21 cu. ft. or over, Push Cats, Pulls and Scrapers, Two Well Point Pumps, Pulverizer or Tiller, PugMill, Rubber-Tired Farm Type Tractor with Bulldozer/Blade/Auger or hi-lift over 1/2 yd., Jersey Spreader, Tract-Air used with Drill or Hi-Lift, Trenching or Ditching Machines, Wood Chipper w/Tractor, Self-Propelled Roller w/Blade, Equipment Greaser, Self-Propelled Bump Grinder on Concrete pavement, Boat Operator, Skid-Loaders, Tuggers, Lazer Screed, and Self-Propelled Chip Spreader (when others run conveyors).

Class 2. Any type tractor pulling any type roller or disc, Two Air Compressors (220 cu. ft. capacity or over), Two AirTract Drills, Air-Track Drill w/Compressor, Automatic Bins or Scales w/Compressor or Generator, Pipeline Boring Machine, Bulk Cement Plant w/Separate Compressor, Power Operated Bull Float, Hydra-Lift w/Single Motor, Straw Mulcher Blower w/Spout, Self-Propelled Roller/Compactor, Back-End man on Bituminous Surfacing Machine, oiler on milling machine.

Class 3. Air Compressor w/Valve driving piling, Boom or Winch Type Truck, Two Conveyors, Self-Propelled Concrete Saw, Form Grader, Truck Crane Oiler, Self-Propelled Vibrator, Rubber Tired Farm Type Tractor w/Blade/Bulldozer/Auger/hi-lift - 1/2 yd. or less, Elevator Operator, Man Lift (scissor lift) when lifting materials.

Class 4. Air-Track Drill (one), Belt Drag Machine, Power Broom, Mechanical Plasterer Applicator, Trac-Air, Air Compressor (220 cu. ft. or over) One, Air Compressor (under 220 cu. ft) four, Automatic Bin, Bulk Cement Plant w/Built-in Compressor running off same motor or electric motor, Fireman or Switchman, Self-Propelled Form Tamper, Light Plants (4), Welding Machines (4), Pumps (4), or Combination of four (4) Pumps, Light Plants, Welding Machines, Air-Compressors (under 220 cu. ft.), Mudjacks or Wood Chipper, Mixers - less than 21 cu. ft. Mortar Mixer w/Skip or Pump, Pipeline Tract Jack. One Operating Engineer may operate and maintain any combination of the following pieces of equipment, not to exceed four (4) which shall be within a reasonable distance, such combination may include any equipment in this classification: (Compressors, Light Plants, Generators, Welding Machines, Pumps or Conveyors), One Well- Point Pump, Two Motor Driven Heaters, One Air Compressor (under 220 cu. ft.), One Engine-Driven Conveyor, One Motor Driven Heater, One Light Plant, One Pump, One Welding Machine, One Ulmac or Equal Spreader, Oilers, and one Generator 10 kw or greater.

OPERATING ENGINEER - O & C (Oil and Chip Resealing ONLY). Includes the operation of all motorized heavy equipment used in oil and chip rsealing, including but not limited to operating self-propelled chip spreaders, and all types of rollers (both hard and rubber tired); and other duties pertaining to the operation or maintenance of heavy equipment related to oil and chip resealing.

Class 1. See Class 1 above for types of equipment operated.

Class 2. See Class 2 above for types of equipment operated.

Class 3. See Class 3 above for types of equipment operated.

Class 4. See Class 4 above for types of equipment operated.

OPERATING ENGINEER RIVER WORK 1 - operate the following machines when working on River Work and Levee Work on the Mississippi and Ohio Rivers, Lakes and Tributaries: Crane, Shovel, Drageline, Scrapers, Dredge, Derrick, Pile-Driver, Push Boat, all power boat operators, Mechanic, Engineman on Dredge, Leverman on Dredge, All Bituminous Spreader machines, Backhoe, Backfiller, Boom, or Winch Cat, Bituminous Mixplane Machine, Blacksmith, Bituminous Surfacing Machine, Bulldozer, Truck Cranes, Hydraulic Truck Mounted Boom/Crane, Concrete Finishing Machine, or Spreader Machine, Concrete Breaker, Concrete or Pumpcrete Machines, Concrete Plant Operator, All Off Road Material Hauling Equipment, Dinky or Standard Locomotives, Well Drill, Elevating Grader, Fork-Lifts, Flexplane, Gradeall, Hi-Lift, Power Handblade Tugger type Hoist, Hoist Two Drum (or over one), Gyderrick, Hyster, Motor Patrol, Mixers - 21 Cu. Ft. or over, Push Cat, Pulls, & Scrapers, Pumps-Two Well Points, Equipment Greaser, P & H Pulverizer or Pulverizer equal to Pugmill, Pugmill, Rubber-Tired farm type tractor w/Bulldozer/Blade/Auger or Hi-Lift over ½ yard, Skimmer Scoops, Seaman Tiller, Jersey Spreader, Tract-Air used with Drill or Hi-Lift, Trenching or Ditching Machine, Wood Chipper w/Tractor, self-propelled roller w/Blade, Concrete Pumps and Small Equipment Operators.

OPERATING ENGINEER RIVER 2 - when working on River Work and Levee Work on the Mississippi and Ohio Rivers, Lakes and Tributaries shall be employed as the Oiler or Fireman on Crane, Dragline, Shovel, Dredge, Truck Crane, Pile Driver, Gradeall, Dinky or Standard Locomotive, Guy Derrick, Trenching Machine or Ditching Machine 80 H.P. and over, All Terrain (cherry-picker) with over 40 ton Lifting Capacity, Deck Oiler and Deckhands.

#### Other Classifications of Work:

For definitions of classifications not otherwise set out, the Department generally has on file such definitions which are available. If a task to be performed is not subject to one of the classifications of pay set out, the Department will upon being contacted state which neighboring county has such a classification and provide such rate, such rate being deemed to exist by reference in this document. If no neighboring county rate applies to the task, the Department shall undertake a special determination, such special determination being then deemed to have existed under this determination. If a project requires these, or any classification not listed, please contact IDOL at 217-782-1710 for wage rates or clarifications.

#### LANDSCAPING

Landscaping work falls under the existing classifications for laborer, operating engineer and truck driver. The work performed by landscape plantsman and landscape laborer is covered by the existing classification of laborer. The work performed by landscape operators (regardless of equipment used or its size) is covered by the classifications of operating engineer. The work performed by landscape truck drivers (regardless of size of truck driven) is covered by the classifications of truck driver.

# Pulaski County Prevailing Wage for May 2011

Trade Name	RG	TYP	C	Base	FRMAN	*M-F>8	OSA	OSH	H/W	Pensn	Vac	Trng
=====	==	===	=	=====	=====	=====	===	===	=====	=====	=====	=====
ASBESTOS ABT-GEN		ALL		24.400	24.850	1.5	1.5	2.0	5.550	9.450	0.000	0.900
ASBESTOS ABT-MEC		BLD		20.800	0.000	2.0	2.0	2.0	5.500	4.200	0.000	0.000
BOILERMAKER		BLD		31.500	34.000	1.5	1.5	2.0	6.820	11.43	1.500	0.350
BRICK MASON		BLD		27.220	28.720	1.5	1.5	2.0	7.950	6.690	0.000	0.430
CARPENTER		BLD		30.490	31.990	1.5	1.5	2.0	6.050	5.750	0.000	0.350
CARPENTER		HWY		30.440	31.940	1.5	1.5	2.0	6.050	5.750	0.000	0.350
CEMENT MASON		BLD		26.750	28.250	1.5	1.5	2.0	5.900	4.800	0.000	0.300
CEMENT MASON		HWY		26.350	27.350	1.5	1.5	2.0	5.900	4.350	0.000	0.300
CERAMIC TILE FNSHER		BLD		25.720	0.000	1.5	1.5	2.0	7.950	6.690	0.000	0.430
ELECTRICIAN		ALL		36.830	39.080	1.5	1.5	2.0	5.350	8.470	0.000	0.730
ELECTRONIC SYS TECH		BLD		29.530	31.280	1.5	1.5	2.0	5.250	3.840	0.000	0.250
FLOOR LAYER		BLD		28.930	29.680	1.5	1.5	2.0	6.050	5.750	0.000	0.350
GLAZIER		BLD		26.330	27.580	1.5	1.5	2.0	4.850	5.200	0.000	0.300
HT/FROST INSULATOR		BLD		28.920	29.920	1.5	1.5	2.0	4.800	8.160	0.000	0.280
IRON WORKER		ALL		26.740	28.740	1.5	1.5	2.0	5.760	9.590	0.000	0.500
LABORER		BLD		24.400	24.850	1.5	1.5	2.0	5.550	9.450	0.000	0.800
LABORER		HWY		24.400	24.850	1.5	1.5	2.0	5.550	9.450	0.000	0.800
LABORER		O&C		17.740	18.190	1.5	1.5	2.0	5.450	8.450	0.000	0.800
MACHINIST		BLD		43.160	45.160	1.5	1.5	2.0	7.640	8.700	0.000	0.000
MARBLE FINISHERS		BLD		25.720	0.000	1.5	1.5	2.0	7.950	6.690	0.000	0.430
MARBLE MASON		BLD		27.220	28.720	1.5	1.5	2.0	7.950	6.690	0.000	0.430
MILLWRIGHT		BLD		30.490	31.990	1.5	1.5	2.0	6.050	5.750	0.000	0.350
MILLWRIGHT		HWY		30.440	31.940	1.5	1.5	2.0	6.050	5.750	0.000	0.350
OE RIVER 1		RIV 1		32.100	33.100	1.5	1.5	2.0	6.500	8.300	0.000	1.350
OE RIVER 2		RIV 2		28.750	33.100	1.5	1.5	2.0	6.500	8.300	0.000	1.350
OPERATING ENGINEER		ALL 1		32.100	33.100	1.5	1.5	2.0	6.500	8.300	0.000	1.350
OPERATING ENGINEER		ALL 2		30.200	33.100	1.5	1.5	2.0	6.500	8.300	0.000	1.350
OPERATING ENGINEER		ALL 3		24.150	33.100	1.5	1.5	2.0	6.500	8.300	0.000	1.350
OPERATING ENGINEER		ALL 4		21.400	27.800	1.5	1.5	2.0	5.650	6.100	0.000	1.100
OPERATING ENGINEER		O&C 1		24.080	25.080	1.5	1.5	2.0	6.500	8.300	0.000	1.350
OPERATING ENGINEER		O&C 2		22.650	25.080	1.5	1.5	2.0	6.500	8.300	0.000	1.350
OPERATING ENGINEER		O&C 3		18.120	25.080	1.5	1.5	2.0	6.500	8.300	0.000	1.350
OPERATING ENGINEER		O&C 4		16.050	21.100	1.5	1.5	2.0	5.650	6.100	0.000	1.100
PAINTER		BLD		26.260	27.760	1.5	1.5	2.0	6.130	6.950	0.000	0.450
PAINTER		HWY		30.560	32.060	1.5	1.5	2.0	6.130	6.950	0.000	0.450
PAINTER OVER 30FT		BLD		27.260	28.760	1.5	1.5	2.0	6.130	6.950	0.000	0.450
PAINTER PWR EQMT		BLD		27.260	28.760	1.5	1.5	2.0	6.130	6.950	0.000	0.450
PAINTER PWR EQMT		HWY		31.560	33.060	1.5	1.5	2.0	6.130	6.950	0.000	0.450
PILEDRIIVER		BLD		30.490	31.990	1.5	1.5	2.0	6.050	5.750	0.000	0.350
PILEDRIIVER		HWY		30.440	31.940	1.5	1.5	2.0	6.050	5.750	0.000	0.350
PIPEFITTER		BLD		38.050	41.850	1.5	2.0	2.0	7.600	5.500	0.000	1.100
PLASTERER		BLD		26.750	28.250	1.5	1.5	2.0	5.900	4.800	0.000	0.300
PLUMBER		BLD		38.050	41.850	1.5	2.0	2.0	7.600	5.500	0.000	1.100
ROOFER		BLD		22.250	23.250	1.5	1.5	2.0	7.900	3.800	0.000	0.000
SHEETMETAL WORKER		ALL		31.390	32.890	1.5	1.5	2.0	6.430	6.490	1.890	0.360
SPRINKLER FITTER		BLD		36.140	38.890	1.5	1.5	2.0	8.100	8.200	0.000	0.350
STONE MASON		BLD		27.220	28.720	1.5	1.5	2.0	7.950	6.690	0.000	0.430
TERRAZZO FINISHER		BLD		25.720	0.000	1.5	1.5	2.0	7.950	6.690	0.000	0.430
TERRAZZO MASON		BLD		27.220	28.720	1.5	1.5	2.0	7.950	6.690	0.000	0.430
TRUCK DRIVER		ALL 1		28.430	0.000	1.5	1.5	2.0	9.050	5.500	0.000	0.250
TRUCK DRIVER		ALL 2		28.850	0.000	1.5	1.5	2.0	9.050	5.500	0.000	0.250
TRUCK DRIVER		ALL 3		29.050	0.000	1.5	1.5	2.0	9.050	5.500	0.000	0.250
TRUCK DRIVER		ALL 4		29.320	0.000	1.5	1.5	2.0	9.050	5.500	0.000	0.250
TRUCK DRIVER		ALL 5		30.100	0.000	1.5	1.5	2.0	9.050	5.500	0.000	0.250
TRUCK DRIVER		O&C 1		22.750	0.000	1.5	1.5	2.0	2.920	6.700	0.000	0.250
TRUCK DRIVER		O&C 2		19.150	0.000	1.5	1.5	2.0	2.920	6.700	0.000	0.250
TRUCK DRIVER		O&C 3		19.650	0.000	1.5	1.5	2.0	2.920	6.700	0.000	0.250
TUCKPOINTER		BLD		27.220	28.720	1.5	1.5	2.0	7.950	6.690	0.000	0.430



Legend :

M-F>8 (Overtime is required for any hour greater than 8 worked each day, Monday through Friday.)

OSA (Overtime is required for every hour worked on Saturday)

OSH (Overtime is required for every hour worked on Sunday and Holidays)

H/W (Health & Welfare Insurance)

Pensn (Pension)

Vac (Vacation)

Trng (Training)

## Explanations

### PULASKI COUNTY

The following list is considered as those days for which holiday rates of wages for work performed apply: New Years Day, Memorial Day, Fourth of July, Labor Day, Thanksgiving Day, Christmas Day and Veterans Day in some classifications/counties. Generally, any of these holidays which fall on a Sunday is celebrated on the following Monday. This then makes work performed on that Monday payable at the appropriate overtime rate for holiday pay. Common practice in a given local may alter certain days of celebration. If in doubt, please check with IDOL.

Oil and chip resealing (O&C) means the application of road oils and liquid asphalt to coat an existing road surface, followed by application of aggregate chips or gravel to coated surface, and subsequent rolling of material to seal the surface.

### EXPLANATION OF CLASSES

ASBESTOS - GENERAL - removal of asbestos material/mold and hazardous materials from any place in a building, including mechanical systems where those mechanical systems are to be removed. This includes the removal of asbestos materials/mold and hazardous materials from ductwork or pipes in a building when the building is to be demolished at the time or at some close future date.

ASBESTOS - MECHANICAL - removal of asbestos material from mechanical systems, such as pipes, ducts, and boilers, where the mechanical systems are to remain.

### LABORER - OIL AND CHIP RESEALING ONLY

Hook and unhook chip box from aggregate truck; distribute material within chip box; perform flagging work related to oil and chip resealing; hand spray oil fluids; handle traffic control, including setting-up and maintaining barricades, drums, cones, delineators, signs and other such items, as well as laying-out and applying or removing temporary roadway markings used to control traffic in job site related to oil and chip resealing; and perform clean-up related

to oil and chip resealing.

#### CERAMIC TILE FINISHER, MARBLE FINISHER, TERRAZZO FINISHER

Assisting, helping or supporting the tile, marble and terrazzo mechanic by performing their historic and traditional work assignments required to complete the proper installation of the work covered by said crafts. The term "Ceramic" is used for naming the classification only, and is in no a limitation of the product handled. Ceramic takes into consideration most hard tiles.

#### ELECTRONIC SYSTEMS TECHNICIAN

Installation, service and maintenance of low-voltage systems which utilizes the transmission and/or transference of voice, sound, vision, or digital for commercial, education, security and entertainment purposes for the following: TV monitoring and surveillance, background/foreground music, intercom and telephone interconnect, field programming, inventory control systems, microwave transmission, multi-media, multiplex, radio page, school, intercom and sound burglar alarms and low voltage master clock systems.

Excluded from this classification are energy management systems, life safety systems, supervisory controls and data acquisition systems not intrinsic with the above listed systems, fire alarm systems, nurse call systems and raceways exceeding fifteen feet in length.

#### TRUCK DRIVER - BUILDING, HEAVY AND HIGHWAY CONSTRUCTION

Class 1. Drivers on 2 axle trucks hauling less than 9 ton. Air compressor and welding machines and brooms, including those pulled by separate units, truck driver helpers, warehouse employees, mechanic helpers, greasers and tiremen, pickup trucks when hauling materials, tools, or workers to and from and on-the-job site, and fork lifts up to 6,000 lb. capacity.

Class 2. Two or three axle trucks hauling more than 9 ton but hauling less than 16 ton. A-frame winch trucks, hydrolift trucks, vector trucks or similar equipment when used for transportation purposes. Fork lifts over 6,000 lb. capacity, winch trucks, four axle combination units, and ticket writers.

Class 3. Two, three or four axle trucks hauling 16 ton or more. Drivers on water pulls, articulated dump trucks, mechanics and working forepersons, and dispatchers. Five axle or more combination units.

Class 4. Low Boy and Oil Distributors.

Class 5. Drivers who require special protective clothing while employed on hazardous waste work.

#### TRUCK DRIVER - O & C (Oil and Chip Resealing ONLY)

It involves driving of contractor or subcontractor owned, leased, or hired pickup, dump, service, or oil distributor trucks. Includes transporting materials and equipment (including, but not limited to oils, aggregate supplies, parts, machinery and tools) to or from the job site; distributing oil or liquid asphalt and aggregate; stock piling material; and maintaining trucks at job site related to oil and chip resealing.

Class 1. Distributors, liquid asphalt hauling and hauling of asphalt rubber-tired rollers.

Class 2. Stockpiling.

Class 3. Tandem hauling to job site.

OPERATING ENGINEERS - BUILDING, HEAVY AND HIGHWAY CONSTRUCTION

Class 1. APSCO or Equal Spreading Machine, Backhoe, Backfiller, Boom or Winch Cat, Bituminous Mixplane Machine, Blacksmith, Bituminous Surfacing Machine, Bull-Dozer, Crane, Shovel, Dragline, Truck Crane, Pile Driver, Concrete Breaker, Concrete or Pumpcrete Pumps, Dinky or Standard Locomotives, Well or Caisson Drills, Elevating Grader, Fork Lifts, Flexplane, Gradeall, Hi-Lift Hoists, Guy-Derricks, Hysters, Mechanic Motor Patrol, Mixers-21 cu. ft. or over, Push Cats, Pulls and Scrapers, Two Well Point Pumps, Pulverizer or Tiller, PugMill, Rubber-Tired Farm Type Tractor with Bulldozer/Blade/Auger or hi-lift over 1/2 yd., Jersey Spreader, Tract-Air used with Drill or Hi-Lift, Trenching or Ditching Machines, Wood Chipper w/Tractor, Self-Propelled Roller w/Blade, Equipment Greaser, Self-Propelled Bump Grinder on Concrete pavement, Boat Operator, Skid-Loaders, Tuggers, Lazer Screed, and Self-Propelled Chip Spreader (when others run conveyors).

Class 2. Any type tractor pulling any type roller or disc, Two Air Compressors (220 cu. ft. capacity or over), Two AirTract Drills, Air-Track Drill w/Compressor, Automatic Bins or Scales w/Compressor or Generator, Pipeline Boring Machine, Bulk Cement Plant w/Separate Compressor, Power Operated Bull Float, Hydra-Lift w/Single Motor, Straw Mulcher Blower w/Spout, Self-Propelled Roller/Compactor, Back-End man on Bituminous Surfacing Machine, oiler on milling machine.

Class 3. Air Compressor w/Valve driving piling, Boom or Winch Type Truck, Two Conveyors, Self-Propelled Concrete Saw, Form Grader, Truck Crane Oiler, Self-Propelled Vibrator, Rubber Tired Farm Type Tractor w/Blade/Bulldozer/Auger/hi-lift - 1/2 yd. or less, Elevator Operator, Man Lift (scissor lift) when lifting materials.

Class 4. Air-Track Drill (one), Belt Drag Machine, Power Broom, Mechanical Plasterer Applicator, Trac-Air, Air Compressor (220 cu. ft. or over) One, Air Compressor (under 220 cu. ft) four, Automatic Bin, Bulk Cement Plant w/Built-in Compressor running off same motor or electric motor, Fireman or Switchman, Self-Propelled Form Tamper, Light Plants (4), Welding Machines (4), Pumps (4), or Combination of four (4) Pumps, Light Plants, Welding Machines, Air-Compressors (under 220 cu. ft.), Mudjacks or Wood Chipper, Mixers - less than 21 cu. ft. Mortar Mixer w/Skip or Pump, Pipeline Tract Jack. One Operating Engineer may operate and maintain any combination of the following pieces of equipment, not to exceed four (4) which shall be within a reasonable distance, such combination may include any equipment in this classification: (Compressors, Light Plants, Generators, Welding Machines, Pumps or Conveyors), One Well- Point Pump, Two Motor Driven Heaters, One Air Compressor (under 220 cu. ft.), One Engine-Driven Conveyor, One Motor Driven Heater, One Light Plant, One Pump, One Welding Machine, One Ulmac or Equal Spreader, Oilers, and one Generator 10 kw or greater.

OPERATING ENGINEER - O & C (Oil and Chip Resealing ONLY). Includes the operation of all motorized heavy equipment used in oil and chip rsealing, including but not limited to operating self-propelled chip spreaders, and all types of rollers (both hard and rubber tired); and other duties pertaining to the operation or maintenance of heavy equipment related to oil and chip resealing.

Class 1. See Class 1 above for types of equipment operated.

Class 2. See Class 2 above for types of equipment operated.

Class 3. See Class 3 above for types of equipment operated.

Class 4. See Class 4 above for types of equipment operated.

OPERATING ENGINEER RIVER WORK 1 - operate the following machines when working on River Work and Levee Work on the Mississippi and Ohio Rivers, Lakes and Tributaries: Crane, Shovel, Drageline, Scrapers, Dredge, Derrick, Pile-Driver, Push Boat, all power boat operators, Mechanic, Engineman on Dredge, Leverman on Dredge, All Bituminous Spreader machines, Backhoe, Backfiller, Boom, or Winch Cat, Bituminous Mixplane Machine, Blacksmith, Bituminous Surfacing Machine, Bulldozer, Truck Cranes, Hydraulic Truck Mounted Boom/Crane, Concrete Finishing Machine, or Spreader Machine, Concrete Breaker, Concrete or Pumpcrete Machines, Concrete Plant Operator, All Off Road Material Hauling Equipment, Dinky or Standard Locomotives, Well Drill, Elevating Grader, Fork-Lifts, Flexplane, Gradeall, Hi-Lift, Power Handblade Tugger type Hoist, Hoist Two Drum (or over one), Gyderrick, Hyster, Motor Patrol, Mixers - 21 Cu. Ft. or over, Push Cat, Pulls, & Scrapers, Pumps-Two Well Points, Equipment Greaser, P & H Pulverizer or Pulverizer equal to Pugmill, Pugmill, Rubber-Tired farm type tractor w/Bulldozer/Blade/Auger or Hi-Lift over ½ yard, Skimmer Scoops, Seaman Tiller, Jersey Spreader, Tract-Air used with Drill or Hi-Lift, Trenching or Ditching Machine, Wood Chipper w/Tractor, self-propelled roller w/Blade, Concrete Pumps and Small Equipment Operators.

OPERATING ENGINEER RIVER 2 - when working on River Work and Levee Work on the Mississippi and Ohio Rivers, Lakes and Tributaries shall be employed as the Oiler or Fireman on Crane, Dragline, Shovel, Dredge, Truck Crane, Pile Driver, Gradeall, Dinky or Standard Locomotive, Guy Derrick, Trenching Machine or Ditching Machine 80 H.P. and over, All Terrain (cherry-picker) with over 40 ton Lifting Capacity, Deck Oiler and Deckhands.

Other Classifications of Work:

For definitions of classifications not otherwise set out, the Department generally has on file such definitions which are available. If a task to be performed is not subject to one of the classifications of pay set out, the Department will upon being contacted state which neighboring county has such a classification and provide such rate, such rate being deemed to exist by reference in this document. If no neighboring county rate applies to the task, the Department shall undertake a special determination, such special determination being then deemed to have existed under this determination. If a project requires these, or any classification not listed, please contact IDOL at 217-782-1710 for wage rates or clarifications.

#### LANDSCAPING

Landscaping work falls under the existing classifications for laborer, operating engineer and truck driver. The work performed by landscape plantsman and landscape laborer is covered by the existing classification of laborer. The work performed by landscape operators (regardless of equipment used or its size) is covered by the classifications of operating engineer. The work performed by landscape truck drivers (regardless of size of truck driven) is covered by the classifications of truck driver.

# Saline County Prevailing Wage for May 2011

Trade Name	RG	TYP	C	Base	FRMAN	*M-F>8	OSA	OSH	H/W	Pensn	Vac	Trng
=====	==	===	=	=====	=====	=====	===	===	=====	=====	=====	=====
ASBESTOS ABT-GEN		ALL		24.400	24.850	1.5	1.5	2.0	5.550	9.450	0.000	0.900
ASBESTOS ABT-MEC		BLD		20.800	0.000	2.0	2.0	2.0	5.500	4.200	0.000	0.000
BOILERMAKER		BLD		31.500	34.000	1.5	1.5	2.0	6.820	11.43	1.500	0.350
BRICK MASON		BLD		27.220	28.720	1.5	1.5	2.0	7.950	6.690	0.000	0.430
CARPENTER		BLD		30.490	31.990	1.5	1.5	2.0	6.050	5.750	0.000	0.350
CARPENTER		HWY		30.440	31.940	1.5	1.5	2.0	6.050	5.750	0.000	0.350
CEMENT MASON		BLD		26.750	28.250	1.5	1.5	2.0	5.900	4.800	0.000	0.300
CEMENT MASON		HWY		26.350	27.350	1.5	1.5	2.0	5.900	4.350	0.000	0.300
CERAMIC TILE FNSHER		BLD		25.720	0.000	1.5	1.5	2.0	7.950	6.690	0.000	0.430
ELECTRICIAN		ALL		36.830	39.080	1.5	1.5	2.0	5.350	8.470	0.000	0.730
ELECTRONIC SYS TECH		BLD		29.530	31.280	1.5	1.5	2.0	5.250	3.840	0.000	0.250
FLOOR LAYER		BLD		28.930	29.680	1.5	1.5	2.0	6.050	5.750	0.000	0.350
GLAZIER		BLD		26.330	27.580	1.5	1.5	2.0	4.850	5.200	0.000	0.300
HT/FROST INSULATOR		BLD		28.920	29.920	1.5	1.5	2.0	4.800	8.160	0.000	0.280
IRON WORKER		ALL		27.020	28.270	1.5	1.5	2.0	5.760	9.600	0.000	0.345
LABORER		BLD		24.400	24.850	1.5	1.5	2.0	5.550	9.450	0.000	0.800
LABORER		HWY		24.400	24.850	1.5	1.5	2.0	5.550	9.450	0.000	0.800
LABORER		O&C		17.740	18.190	1.5	1.5	2.0	5.450	8.450	0.000	0.800
MACHINIST		BLD		43.160	45.160	1.5	1.5	2.0	7.640	8.700	0.000	0.000
MARBLE FINISHERS		BLD		25.720	0.000	1.5	1.5	2.0	7.950	6.690	0.000	0.430
MARBLE MASON		BLD		27.220	28.720	1.5	1.5	2.0	7.950	6.690	0.000	0.430
MILLWRIGHT		BLD		30.490	31.990	1.5	1.5	2.0	6.050	5.750	0.000	0.350
MILLWRIGHT		HWY		30.440	31.940	1.5	1.5	2.0	6.050	5.750	0.000	0.350
OE RIVER 1		RIV 1		32.100	33.100	1.5	1.5	2.0	6.500	8.300	0.000	1.350
OE RIVER 2		RIV 2		28.750	33.100	1.5	1.5	2.0	6.500	8.300	0.000	1.350
OPERATING ENGINEER		ALL 1		32.100	33.100	1.5	1.5	2.0	6.500	8.300	0.000	1.350
OPERATING ENGINEER		ALL 2		30.200	33.100	1.5	1.5	2.0	6.500	8.300	0.000	1.350
OPERATING ENGINEER		ALL 3		24.150	33.100	1.5	1.5	2.0	6.500	8.300	0.000	1.350
OPERATING ENGINEER		ALL 4		21.400	27.800	1.5	1.5	2.0	5.650	6.100	0.000	1.100
OPERATING ENGINEER		O&C 1		24.080	25.080	1.5	1.5	2.0	6.500	8.300	0.000	1.350
OPERATING ENGINEER		O&C 2		22.650	25.080	1.5	1.5	2.0	6.500	8.300	0.000	1.350
OPERATING ENGINEER		O&C 3		18.120	25.080	1.5	1.5	2.0	6.500	8.300	0.000	1.350
OPERATING ENGINEER		O&C 4		16.050	21.100	1.5	1.5	2.0	5.650	6.100	0.000	1.100
PAINTER		BLD		26.260	27.760	1.5	1.5	2.0	6.130	6.950	0.000	0.450
PAINTER		HWY		30.560	32.060	1.5	1.5	2.0	6.130	6.950	0.000	0.450
PAINTER OVER 30FT		BLD		27.260	28.760	1.5	1.5	2.0	6.130	6.950	0.000	0.450
PAINTER PWR EQMT		BLD		27.260	28.760	1.5	1.5	2.0	6.130	6.950	0.000	0.450
PAINTER PWR EQMT		HWY		31.560	33.060	1.5	1.5	2.0	6.130	6.950	0.000	0.450
PILEDRIVER		BLD		30.490	31.990	1.5	1.5	2.0	6.050	5.750	0.000	0.350
PILEDRIVER		HWY		30.440	31.940	1.5	1.5	2.0	6.050	5.750	0.000	0.350
PIPEFITTER		BLD		32.250	35.470	1.5	1.5	2.0	8.250	8.850	0.000	1.200
PLASTERER		BLD		26.750	28.250	1.5	1.5	2.0	5.900	4.800	0.000	0.300
PLUMBER		BLD		32.250	35.470	1.5	1.5	2.0	8.250	8.850	0.000	1.200
ROOFER		BLD		22.250	23.250	1.5	1.5	2.0	7.900	3.800	0.000	0.000
SHEETMETAL WORKER		ALL		31.390	32.890	1.5	1.5	2.0	6.430	6.490	1.890	0.360
SPRINKLER FITTER		BLD		36.140	38.890	1.5	1.5	2.0	8.100	8.200	0.000	0.350
STONE MASON		BLD		27.220	28.720	1.5	1.5	2.0	7.950	6.690	0.000	0.430
TERRAZZO FINISHER		BLD		25.720	0.000	1.5	1.5	2.0	7.950	6.690	0.000	0.430
TERRAZZO MASON		BLD		28.500	28.800	1.5	1.5	2.0	6.400	5.700	0.000	0.430
TRUCK DRIVER		ALL 1		28.430	0.000	1.5	1.5	2.0	9.050	5.500	0.000	0.250
TRUCK DRIVER		ALL 2		28.850	0.000	1.5	1.5	2.0	9.050	5.500	0.000	0.250
TRUCK DRIVER		ALL 3		29.050	0.000	1.5	1.5	2.0	9.050	5.500	0.000	0.250
TRUCK DRIVER		ALL 4		29.320	0.000	1.5	1.5	2.0	9.050	5.500	0.000	0.250
TRUCK DRIVER		ALL 5		30.100	0.000	1.5	1.5	2.0	9.050	5.500	0.000	0.250
TRUCK DRIVER		O&C 1		22.750	0.000	1.5	1.5	2.0	2.920	6.700	0.000	0.250
TRUCK DRIVER		O&C 2		19.150	0.000	1.5	1.5	2.0	2.920	6.700	0.000	0.250
TRUCK DRIVER		O&C 3		19.650	0.000	1.5	1.5	2.0	2.920	6.700	0.000	0.250
TUCKPONTER		BLD		27.220	28.720	1.5	1.5	2.0	7.950	6.690	0.000	0.430

Legend :

M-F>8 (Overtime is required for any hour greater than 8 worked each day, Monday through Friday.)

OSA (Overtime is required for every hour worked on Saturday)

OSH (Overtime is required for every hour worked on Sunday and Holidays)

H/W (Health & Welfare Insurance)

Pensn (Pension)

Vac (Vacation)

Trng (Training)

## Explanations

### SALINE COUNTY

The following list is considered as those days for which holiday rates of wages for work performed apply: New Years Day, Memorial Day, Fourth of July, Labor Day, Thanksgiving Day, Christmas Day and Veterans Day in some classifications/counties. Generally, any of these holidays which fall on a Sunday is celebrated on the following Monday. This then makes work performed on that Monday payable at the appropriate overtime rate for holiday pay. Common practice in a given local may alter certain days of celebration. If in doubt, please check with IDOL.

Oil and chip resealing (O&C) means the application of road oils and liquid asphalt to coat an existing road surface, followed by application of aggregate chips or gravel to coated surface, and subsequent rolling of material to seal the surface.

### EXPLANATION OF CLASSES

ASBESTOS - GENERAL - removal of asbestos material/mold and hazardous materials from any place in a building, including mechanical systems where those mechanical systems are to be removed. This includes the removal of asbestos materials/mold and hazardous materials from ductwork or pipes in a building when the building is to be demolished at the time or at some close future date.

ASBESTOS - MECHANICAL - removal of asbestos material from mechanical systems, such as pipes, ducts, and boilers, where the mechanical systems are to remain.

### LABORER - OIL AND CHIP RESEALING ONLY

Hook and unhook chip box from aggregate truck; distribute material within chip box; perform flagging work related to oil and chip resealing; hand spray oil fluids; handle traffic control, including setting-up and maintaining barricades, drums, cones, delineators, signs and other such items, as well as laying-out and applying or removing temporary roadway markings used to control traffic in job site related to oil and chip resealing; and perform clean-up related

to oil and chip resealing.

#### CERAMIC TILE FINISHER, MARBLE FINISHER, TERRAZZO FINISHER

Assisting, helping or supporting the tile, marble and terrazzo mechanic by performing their historic and traditional work assignments required to complete the proper installation of the work covered by said crafts. The term "Ceramic" is used for naming the classification only, and is in no a limitation of the product handled. Ceramic takes into consideration most hard tiles.

#### ELECTRONIC SYSTEMS TECHNICIAN

Installation, service and maintenance of low-voltage systems which utilizes the transmission and/or transference of voice, sound, vision, or digital for commercial, education, security and entertainment purposes for the following: TV monitoring and surveillance, background/foreground music, intercom and telephone interconnect, field programming, inventory control systems, microwave transmission, multi-media, multiplex, radio page, school, intercom and sound burglar alarms and low voltage master clock systems.

Excluded from this classification are energy management systems, life safety systems, supervisory controls and data acquisition systems not intrinsic with the above listed systems, fire alarm systems, nurse call systems and raceways exceeding fifteen feet in length.

#### TRUCK DRIVER - BUILDING, HEAVY AND HIGHWAY CONSTRUCTION

Class 1. Drivers on 2 axle trucks hauling less than 9 ton. Air compressor and welding machines and brooms, including those pulled by separate units, truck driver helpers, warehouse employees, mechanic helpers, greasers and tiremen, pickup trucks when hauling materials, tools, or workers to and from and on-the-job site, and fork lifts up to 6,000 lb. capacity.

Class 2. Two or three axle trucks hauling more than 9 ton but hauling less than 16 ton. A-frame winch trucks, hydrolift trucks, vector trucks or similar equipment when used for transportation purposes. Fork lifts over 6,000 lb. capacity, winch trucks, four axle combination units, and ticket writers.

Class 3. Two, three or four axle trucks hauling 16 ton or more. Drivers on water pulls, articulated dump trucks, mechanics and working forepersons, and dispatchers. Five axle or more combination units.

Class 4. Low Boy and Oil Distributors.

Class 5. Drivers who require special protective clothing while employed on hazardous waste work.

#### TRUCK DRIVER - O & C (Oil and Chip Resealing ONLY)

It involves driving of contractor or subcontractor owned, leased, or hired pickup, dump, service, or oil distributor trucks. Includes transporting materials and equipment (including, but not limited to oils, aggregate supplies, parts, machinery and tools) to or from the job site; distributing oil or liquid asphalt and aggregate; stock piling material; and maintaining trucks at job site related to oil and chip resealing.

Class 1. Distributors, liquid asphalt hauling and hauling of asphalt rubber-tired rollers.

Class 2. Stockpiling.

Class 3. Tandem hauling to job site.

OPERATING ENGINEERS - BUILDING, HEAVY AND HIGHWAY CONSTRUCTION

Class 1. APSCO or Equal Spreading Machine, Backhoe, Backfiller, Boom or Winch Cat, Bituminous Mixplane Machine, Blacksmith, Bituminous Surfacing Machine, Bull-Dozer, Crane, Shovel, Dragline, Truck Crane, Pile Driver, Concrete Breaker, Concrete or Pumpcrete Pumps, Dinky or Standard Locomotives, Well or Caisson Drills, Elevating Grader, Fork Lifts, Flexplane, Gradeall, Hi-Lift Hoists, Guy-Derricks, Hysters, Mechanic Motor Patrol, Mixers-21 cu. ft. or over, Push Cats, Pulls and Scrapers, Two Well Point Pumps, Pulverizer or Tiller, PugMill, Rubber-Tired Farm Type Tractor with Bulldozer/Blade/Auger or hi-lift over 1/2 yd., Jersey Spreader, Tract-Air used with Drill or Hi-Lift, Trenching or Ditching Machines, Wood Chipper w/Tractor, Self-Propelled Roller w/Blade, Equipment Greaser, Self-Propelled Bump Grinder on Concrete pavement, Boat Operator, Skid-Loaders, Tuggers, Lazer Screed, and Self-Propelled Chip Spreader (when others run conveyors).

Class 2. Any type tractor pulling any type roller or disc, Two Air Compressors (220 cu. ft. capacity or over), Two AirTract Drills, Air-Track Drill w/Compressor, Automatic Bins or Scales w/Compressor or Generator, Pipeline Boring Machine, Bulk Cement Plant w/Separate Compressor, Power Operated Bull Float, Hydra-Lift w/Single Motor, Straw Mulcher Blower w/Spout, Self-Propelled Roller/Compactor, Back-End man on Bituminous Surfacing Machine, oiler on milling machine.

Class 3. Air Compressor w/Valve driving piling, Boom or Winch Type Truck, Two Conveyors, Self-Propelled Concrete Saw, Form Grader, Truck Crane Oiler, Self-Propelled Vibrator, Rubber Tired Farm Type Tractor w/Blade/Bulldozer/Auger/hi-lift - 1/2 yd. or less, Elevator Operator, Man Lift (scissor lift) when lifting materials.

Class 4. Air-Track Drill (one), Belt Drag Machine, Power Broom, Mechanical Plasterer Applicator, Trac-Air, Air Compressor (220 cu. ft. or over) One, Air Compressor (under 220 cu. ft) four, Automatic Bin, Bulk Cement Plant w/Built-in Compressor running off same motor or electric motor, Fireman or Switchman, Self-Propelled Form Tamper, Light Plants (4), Welding Machines (4), Pumps (4), or Combination of four (4) Pumps, Light Plants, Welding Machines, Air-Compressors (under 220 cu. ft.), Mudjacks or Wood Chipper, Mixers - less than 21 cu. ft. Mortar Mixer w/Skip or Pump, Pipeline Tract Jack. One Operating Engineer may operate and maintain any combination of the following pieces of equipment, not to exceed four (4) which shall be within a reasonable distance, such combination may include any equipment in this classification: (Compressors, Light Plants, Generators, Welding Machines, Pumps or Conveyors), One Well- Point Pump, Two Motor Driven Heaters, One Air Compressor (under 220 cu. ft.), One Engine-Driven Conveyor, One Motor Driven Heater, One Light Plant, One Pump, One Welding Machine, One Ulmac or Equal Spreader, Oilers, and one Generator 10 kw or greater.

OPERATING ENGINEER - O & C (Oil and Chip Resealing ONLY). Includes the operation of all motorized heavy equipment used in oil and chip rsealing, including but not limited to operating self-propelled chip spreaders, and all types of rollers (both hard and rubber tired); and other duties pertaining to the operation or maintenance of heavy equipment relatd to oil and chip resealing.

Class 1. See Class 1 above for types of equipment operated.



Class 2. See Class 2 above for types of equipment operated.

Class 3. See Class 3 above for types of equipment operated.

Class 4. See Class 4 above for types of equipment operated.

OPERATING ENGINEER RIVER WORK 1 - operate the following machines when working on River Work and Levee Work on the Mississippi and Ohio Rivers, Lakes and Tributaries: Crane, Shovel, Drageline, Scrapers, Dredge, Derrick, Pile-Driver, Push Boat, all power boat operators, Mechanic, Engineman on Dredge, Leverman on Dredge, All Bituminous Spreader machines, Backhoe, Backfiller, Boom, or Winch Cat, Bituminous Mixplane Machine, Blacksmith, Bituminous Surfacing Machine, Bulldozer, Truck Cranes, Hydraulic Truck Mounted Boom/Crane, Concrete Finishing Machine, or Spreader Machine, Concrete Breaker, Concrete or Pumpcrete Machines, Concrete Plant Operator, All Off Road Material Hauling Equipment, Dinky or Standard Locomotives, Well Drill, Elevating Grader, Fork-Lifts, Flexplane, Gradeall, Hi-Lift, Power Handblade Tugger type Hoist, Hoist Two Drum (or over one), Gyderrick, Hyster, Motor Patrol, Mixers - 21 Cu. Ft. or over, Push Cat, Pulls, & Scrapers, Pumps-Two Well Points, Equipment Greaser, P & H Pulverizer or Pulverizer equal to Pugmill, Pugmill, Rubber-Tired farm type tractor w/Bulldozer/Blade/Auger or Hi-Lift over ½ yard, Skimmer Scoops, Seaman Tiller, Jersey Spreader, Tract-Air used with Drill or Hi-Lift, Trenching or Ditching Machine, Wood Chipper w/Tractor, self-propelled roller w/Blade, Concrete Pumps and Small Equipment Operators.

OPERATING ENGINEER RIVER 2 - when working on River Work and Levee Work on the Mississippi and Ohio Rivers, Lakes and Tributaries shall be employed as the Oiler or Fireman on Crane, Dragline, Shovel, Dredge, Truck Crane, Pile Driver, Gradeall, Dinky or Standard Locomotive, Guy Derrick, Trenching Machine or Ditching Machine 80 H.P. and over, All Terrain (cherry-picker) with over 40 ton Lifting Capacity, Deck Oiler and Deckhands.

Other Classifications of Work:

For definitions of classifications not otherwise set out, the Department generally has on file such definitions which are available. If a task to be performed is not subject to one of the classifications of pay set out, the Department will upon being contacted state which neighboring county has such a classification and provide such rate, such rate being deemed to exist by reference in this document. If no neighboring county rate applies to the task, the Department shall undertake a special determination, such special determination being then deemed to have existed under this determination. If a project requires these, or any classification not listed, please contact IDOL at 217-782-1710 for wage rates or clarifications.

#### LANDSCAPING

Landscaping work falls under the existing classifications for laborer, operating engineer and truck driver. The work performed by landscape plantsman and landscape laborer is covered by the existing classification of laborer. The work performed by landscape operators (regardless of equipment used or its size) is covered by the classifications of operating engineer. The work performed by landscape truck drivers (regardless of size of truck driven) is covered by the classifications of truck driver.

# Union County Prevailing Wage for May 2011

Trade Name	RG	TYP	C	Base	FRMAN	*M-F>8	OSA	OSH	H/W	Pensn	Vac	Trng
=====	==	===	=	=====	=====	=====	===	===	=====	=====	=====	=====
ASBESTOS ABT-GEN		ALL		24.400	24.850	1.5	1.5	2.0	5.550	9.450	0.000	0.900
ASBESTOS ABT-MEC		BLD		28.710	29.710	1.5	1.5	2.0	6.400	2.500	0.000	0.000
BOILERMAKER		BLD		31.500	34.000	1.5	1.5	2.0	6.820	11.43	1.500	0.350
BRICK MASON		BLD		27.220	28.720	1.5	1.5	2.0	7.950	6.690	0.000	0.430
CARPENTER		BLD		30.490	31.990	1.5	1.5	2.0	6.050	5.750	0.000	0.350
CARPENTER		HWY		30.440	31.940	1.5	1.5	2.0	6.050	5.750	0.000	0.350
CEMENT MASON		BLD		26.750	28.250	1.5	1.5	2.0	5.900	4.800	0.000	0.300
CEMENT MASON		HWY		26.350	27.350	1.5	1.5	2.0	5.900	4.350	0.000	0.300
CERAMIC TILE FNSHER		BLD		25.720	0.000	1.5	1.5	2.0	7.950	6.690	0.000	0.430
ELECTRICIAN		ALL		36.830	39.080	1.5	1.5	2.0	5.350	8.470	0.000	0.730
ELECTRONIC SYS TECH		BLD		29.530	31.280	1.5	1.5	2.0	5.250	3.840	0.000	0.250
FLOOR LAYER		BLD		28.930	29.680	1.5	1.5	2.0	6.050	5.750	0.000	0.350
GLAZIER		BLD		26.330	27.580	1.5	1.5	2.0	4.850	5.200	0.000	0.300
HT/FROST INSULATOR		BLD		36.260	37.260	1.5	1.5	2.0	7.150	10.46	0.000	0.500
IRON WORKER		ALL		26.740	28.740	1.5	1.5	2.0	5.760	9.590	0.000	0.500
LABORER		BLD		24.400	24.850	1.5	1.5	2.0	5.550	9.450	0.000	0.800
LABORER		HWY		24.400	24.850	1.5	1.5	2.0	5.550	9.450	0.000	0.800
LABORER		O&C		17.740	18.190	1.5	1.5	2.0	5.450	8.450	0.000	0.800
MACHINIST		BLD		43.160	45.160	1.5	1.5	2.0	7.640	8.700	0.000	0.000
MARBLE FINISHERS		BLD		25.720	0.000	1.5	1.5	2.0	7.950	6.690	0.000	0.430
MARBLE MASON		BLD		27.220	28.720	1.5	1.5	2.0	7.950	6.690	0.000	0.430
MILLWRIGHT		BLD		30.490	31.990	1.5	1.5	2.0	6.050	5.750	0.000	0.350
MILLWRIGHT		HWY		30.440	31.940	1.5	1.5	2.0	6.050	5.750	0.000	0.350
OE RIVER 1		RIV	1	32.100	33.100	1.5	1.5	2.0	6.500	8.300	0.000	1.350
OE RIVER 2		RIV	2	28.750	33.100	1.5	1.5	2.0	6.500	8.300	0.000	1.350
OPERATING ENGINEER		ALL	1	32.100	33.100	1.5	1.5	2.0	6.500	8.300	0.000	1.350
OPERATING ENGINEER		ALL	2	30.200	33.100	1.5	1.5	2.0	6.500	8.300	0.000	1.350
OPERATING ENGINEER		ALL	3	24.150	33.100	1.5	1.5	2.0	6.500	8.300	0.000	1.350
OPERATING ENGINEER		ALL	4	21.400	27.800	1.5	1.5	2.0	5.650	6.100	0.000	1.100
OPERATING ENGINEER		O&C	1	24.080	25.080	1.5	1.5	2.0	6.500	8.300	0.000	1.350
OPERATING ENGINEER		O&C	2	22.650	25.080	1.5	1.5	2.0	6.500	8.300	0.000	1.350
OPERATING ENGINEER		O&C	3	18.120	25.080	1.5	1.5	2.0	6.500	8.300	0.000	1.350
OPERATING ENGINEER		O&C	4	16.050	21.100	1.5	1.5	2.0	5.650	6.100	0.000	1.100
PAINTER		BLD		26.260	27.760	1.5	1.5	2.0	6.130	6.950	0.000	0.450
PAINTER		HWY		30.560	32.060	1.5	1.5	2.0	6.130	6.950	0.000	0.450
PAINTER OVER 30FT		BLD		27.260	28.760	1.5	1.5	2.0	6.130	6.950	0.000	0.450
PAINTER PWR EQMT		BLD		27.260	28.760	1.5	1.5	2.0	6.130	6.950	0.000	0.450
PAINTER PWR EQMT		HWY		31.560	33.060	1.5	1.5	2.0	6.130	6.950	0.000	0.450
PILEDRIVER		BLD		30.490	31.990	1.5	1.5	2.0	6.050	5.750	0.000	0.350
PILEDRIVER		HWY		30.440	31.940	1.5	1.5	2.0	6.050	5.750	0.000	0.350
PIPEFITTER		BLD		38.050	41.850	1.5	2.0	2.0	7.600	5.500	0.000	1.100
PLASTERER		BLD		26.750	28.250	1.5	1.5	2.0	5.900	4.800	0.000	0.300
PLUMBER		BLD		38.050	41.850	1.5	2.0	2.0	7.600	5.500	0.000	1.100
ROOFER		BLD		22.250	23.250	1.5	1.5	2.0	7.900	3.800	0.000	0.000
SHEETMETAL WORKER		ALL		31.390	32.890	1.5	1.5	2.0	6.430	6.490	1.890	0.360
SPRINKLER FITTER		BLD		36.140	38.890	1.5	1.5	2.0	8.100	8.200	0.000	0.350
STONE MASON		BLD		27.220	28.720	1.5	1.5	2.0	7.950	6.690	0.000	0.430
TERRAZZO FINISHER		BLD		25.720	0.000	1.5	1.5	2.0	7.950	6.690	0.000	0.430
TERRAZZO MASON		BLD		28.500	28.800	1.5	1.5	2.0	6.400	5.700	0.000	0.430
TRUCK DRIVER		ALL	1	28.430	0.000	1.5	1.5	2.0	9.050	5.500	0.000	0.250
TRUCK DRIVER		ALL	2	28.850	0.000	1.5	1.5	2.0	9.050	5.500	0.000	0.250
TRUCK DRIVER		ALL	3	29.050	0.000	1.5	1.5	2.0	9.050	5.500	0.000	0.250
TRUCK DRIVER		ALL	4	29.320	0.000	1.5	1.5	2.0	9.050	5.500	0.000	0.250
TRUCK DRIVER		ALL	5	30.100	0.000	1.5	1.5	2.0	9.050	5.500	0.000	0.250
TRUCK DRIVER		O&C	1	22.750	0.000	1.5	1.5	2.0	2.920	6.700	0.000	0.250
TRUCK DRIVER		O&C	2	19.150	0.000	1.5	1.5	2.0	2.920	6.700	0.000	0.250
TRUCK DRIVER		O&C	3	19.650	0.000	1.5	1.5	2.0	2.920	6.700	0.000	0.250
TUCKPOINTER		BLD		27.220	28.720	1.5	1.5	2.0	7.950	6.690	0.000	0.430

Legend :

M-F>8 (Overtime is required for any hour greater than 8 worked each day, Monday through Friday.)

OSA (Overtime is required for every hour worked on Saturday)

OSH (Overtime is required for every hour worked on Sunday and Holidays)

H/W (Health & Welfare Insurance)

Pensn (Pension)

Vac (Vacation)

Trng (Training)

## Explanations

### UNION COUNTY

The following list is considered as those days for which holiday rates of wages for work performed apply: New Years Day, Memorial Day, Fourth of July, Labor Day, Thanksgiving Day, Christmas Day and Veterans Day in some classifications/counties. Generally, any of these holidays which fall on a Sunday is celebrated on the following Monday. This then makes work performed on that Monday payable at the appropriate overtime rate for holiday pay. Common practice in a given local may alter certain days of celebration. If in doubt, please check with IDOL.

Oil and chip resealing (O&C) means the application of road oils and liquid asphalt to coat an existing road surface, followed by application of aggregate chips or gravel to coated surface, and subsequent rolling of material to seal the surface.

### EXPLANATION OF CLASSES

ASBESTOS - GENERAL - removal of asbestos material/mold and hazardous materials from any place in a building, including mechanical systems where those mechanical systems are to be removed. This includes the removal of asbestos materials/mold and hazardous materials from ductwork or pipes in a building when the building is to be demolished at the time or at some close future date.

ASBESTOS - MECHANICAL - removal of asbestos material from mechanical systems, such as pipes, ducts, and boilers, where the mechanical systems are to remain.

### LABORER - OIL AND CHIP RESEALING ONLY

Hook and unhook chip box from aggregate truck; distribute material within chip box; perform flagging work related to oil and chip resealing; hand spray oil fluids; handle traffic control, including setting-up and maintaining barricades, drums, cones, delineators, signs and other such items, as well as laying-out and applying or removing temporary roadway markings used to control traffic in job site related to oil and chip resealing; and perform clean-up related to oil and chip resealing.

CERAMIC TILE FINISHER, MARBLE FINISHER, TERRAZZO FINISHER

Assisting, helping or supporting the tile, marble and terrazzo mechanic by performing their historic and traditional work assignments required to complete the proper installation of the work covered by said crafts. The term "Ceramic" is used for naming the classification only, and is in no a limitation of the product handled. Ceramic takes into consideration most hard tiles.

ELECTRONIC SYSTEMS TECHNICIAN

Installation, service and maintenance of low-voltage systems which utilizes the transmission and/or transference of voice, sound, vision, or digital for commercial, education, security and entertainment purposes for the following: TV monitoring and surveillance, background/foreground music, intercom and telephone interconnect, field programming, inventory control systems, microwave transmission, multi-media, multiplex, radio page, school, intercom and sound burglar alarms and low voltage master clock systems.

Excluded from this classification are energy management systems, life safety systems, supervisory controls and data acquisition systems not intrinsic with the above listed systems, fire alarm systems, nurse call systems and raceways exceeding fifteen feet in length.

TRUCK DRIVER - BUILDING, HEAVY AND HIGHWAY CONSTRUCTION

Class 1. Drivers on 2 axle trucks hauling less than 9 ton. Air compressor and welding machines and brooms, including those pulled by separate units, truck driver helpers, warehouse employees, mechanic helpers, greasers and tiremen, pickup trucks when hauling materials, tools, or workers to and from and on-the-job site, and fork lifts up to 6,000 lb. capacity.

Class 2. Two or three axle trucks hauling more than 9 ton but hauling less than 16 ton. A-frame winch trucks, hydrolift trucks, vector trucks or similar equipment when used for transportation purposes. Fork lifts over 6,000 lb. capacity, winch trucks, four axle combination units, and ticket writers.

Class 3. Two, three or four axle trucks hauling 16 ton or more. Drivers on water pulls, articulated dump trucks, mechanics and working forepersons, and dispatchers. Five axle or more combination units.

Class 4. Low Boy and Oil Distributors.

Class 5. Drivers who require special protective clothing while employed on hazardous waste work.

TRUCK DRIVER - O & C (Oil and Chip Resealing ONLY)

It involves driving of contractor or subcontractor owned, leased, or hired pickup, dump, service, or oil distributor trucks. Includes transporting materials and equipment (including, but not limited to oils, aggregate supplies, parts, machinery and tools) to or from the job site; distributing oil or liquid asphalt and aggregate; stock piling material; and maintaining trucks at job site related to oil and chip resealing.

Class 1. Distributors, liquid asphalt hauling and hauling of asphalt rubber-tired rollers.

Class 2. Stockpiling.

Class 3. Tandem hauling to job site.

OPERATING ENGINEERS - BUILDING, HEAVY AND HIGHWAY CONSTRUCTION

Class 1. APSCO or Equal Spreading Machine, Backhoe, Backfiller, Boom or Winch Cat, Bituminous Mixplane Machine, Blacksmith, Bituminous Surfacing Machine, Bull-Dozer, Crane, Shovel, Dragline, Truck Crane, Pile Driver, Concrete Breaker, Concrete or Pumpcrete Pumps, Dinky or Standard Locomotives, Well or Caisson Drills, Elevating Grader, Fork Lifts, Flexplane, Gradeall, Hi-Lift Hoists, Guy-Derricks, Hysters, Mechanic Motor Patrol, Mixers-21 cu. ft. or over, Push Cats, Pulls and Scrapers, Two Well Point Pumps, Pulverizer or Tiller, PugMill, Rubber-Tired Farm Type Tractor with Bulldozer/Blade/Auger or hi-lift over 1/2 yd., Jersey Spreader, Tract-Air used with Drill or Hi-Lift, Trenching or Ditching Machines, Wood Chipper w/Tractor, Self-Propelled Roller w/Blade, Equipment Greaser, Self-Propelled Bump Grinder on Concrete pavement, Boat Operator, Skid-Loaders, Tuggers, Lazer Screed, and Self-Propelled Chip Spreader (when others run conveyors).

Class 2. Any type tractor pulling any type roller or disc, Two Air Compressors (220 cu. ft. capacity or over), Two AirTract Drills, Air-Track Drill w/Compressor, Automatic Bins or Scales w/Compressor or Generator, Pipeline Boring Machine, Bulk Cement Plant w/Separate Compressor, Power Operated Bull Float, Hydra-Lift w/Single Motor, Straw Mulcher Blower w/Spout, Self-Propelled Roller/Compactor, Back-End man on Bituminous Surfacing Machine, oiler on milling machine.

Class 3. Air Compressor w/Valve driving piling, Boom or Winch Type Truck, Two Conveyors, Self-Propelled Concrete Saw, Form Grader, Truck Crane Oiler, Self-Propelled Vibrator, Rubber Tired Farm Type Tractor w/Blade/Bulldozer/Auger/hi-lift - 1/2 yd. or less, Elevator Operator, Man Lift (scissor lift) when lifting materials.

Class 4. Air-Track Drill (one), Belt Drag Machine, Power Broom, Mechanical Plasterer Applicator, Trac-Air, Air Compressor (220 cu. ft. or over) One, Air Compressor (under 220 cu. ft) four, Automatic Bin, Bulk Cement Plant w/Built-in Compressor running off same motor or electric motor, Fireman or Switchman, Self-Propelled Form Tamper, Light Plants (4), Welding Machines (4), Pumps (4), or Combination of four (4) Pumps, Light Plants, Welding Machines, Air-Compressors (under 220 cu. ft.), Mudjacks or Wood Chipper, Mixers - less than 21 cu. ft. Mortar Mixer w/Skip or Pump, Pipeline Tract Jack. One Operating Engineer may operate and maintain any combination of the following pieces of equipment, not to exceed four (4) which shall be within a reasonable distance, such combination may include any equipment in this classification: (Compressors, Light Plants, Generators, Welding Machines, Pumps or Conveyors), One Well- Point Pump, Two Motor Driven Heaters, One Air Compressor (under 220 cu. ft.), One Engine-Driven Conveyor, One Motor Driven Heater, One Light Plant, One Pump, One Welding Machine, One Ulmac or Equal Spreader, Oilers, and one Generator 10 kw or greater.

OPERATING ENGINEER - O & C (Oil and Chip Resealing ONLY). Includes the operation of all motorized heavy equipment used in oil and chip rsealing, including but not limited to operating self-propelled chip spreaders, and all types of rollers (both hard and rubber tired); and other duties pertaining to the operation or maintenance of heavy equipment relatd to oil and chip resealing.

Class 1. See Class 1 above for types of equipment operated.

Class 2. See Class 2 above for types of equipment operated.

Class 3. See Class 3 above for types of equipment operated.

Class 4. See Class 4 above for types of equipment operated.

OPERATING ENGINEER RIVER WORK 1 - operate the following machines when working on River Work and Levee Work on the Mississippi and Ohio Rivers, Lakes and Tributaries: Crane, Shovel, Drageline, Scrapers, Dredge, Derrick, Pile-Driver, Push Boat, all power boat operators, Mechanic, Engineman on Dredge, Leverman on Dredge, All Bituminous Spreader machines, Backhoe, Backfiller, Boom, or Winch Cat, Bituminous Mixplane Machine, Blacksmith, Bituminous Surfacing Machine, Bulldozer, Truck Cranes, Hydraulic Truck Mounted Boom/Crane, Concrete Finishing Machine, or Spreader Machine, Concrete Breaker, Concrete or Pumpcrete Machines, Concrete Plant Operator, All Off Road Material Hauling Equipment, Dinky or Standard Locomotives, Well Drill, Elevating Grader, Fork-Lifts, Flexplane, Gradeall, Hi-Lift, Power Handblade Tugger type Hoist, Hoist Two Drum (or over one), Gyderrick, Hyster, Motor Patrol, Mixers - 21 Cu. Ft. or over, Push Cat, Pulls, & Scrapers, Pumps-Two Well Points, Equipment Greaser, P & H Pulverizer or Pulverizer equal to Pugmill, Pugmill, Rubber-Tired farm type tractor w/Bulldozer/Blade/Auger or Hi-Lift over ½ yard, Skimmer Scoops, Seaman Tiller, Jersey Spreader, Tract-Air used with Drill or Hi-Lift, Trenching or Ditching Machine, Wood Chipper w/Tractor, self-propelled roller w/Blade, Concrete Pumps and Small Equipment Operators.

OPERATING ENGINEER RIVER 2 - when working on River Work and Levee Work on the Mississippi and Ohio Rivers, Lakes and Tributaries shall be employed as the Oiler or Fireman on Crane, Dragline, Shovel, Dredge, Truck Crane, Pile Driver, Gradeall, Dinky or Standard Locomotive, Guy Derrick, Trenching Machine or Ditching Machine 80 H.P. and over, All Terrain (cherry-picker) with over 40 ton Lifting Capacity, Deck Oiler and Deckhands.

Other Classifications of Work:

For definitions of classifications not otherwise set out, the Department generally has on file such definitions which are available. If a task to be performed is not subject to one of the classifications of pay set out, the Department will upon being contacted state which neighboring county has such a classification and provide such rate, such rate being deemed to exist by reference in this document. If no neighboring county rate applies to the task, the Department shall undertake a special determination, such special determination being then deemed to have existed under this determination. If a project requires these, or any classification not listed, please contact IDOL at 217-782-1710 for wage rates or clarifications.

#### LANDSCAPING

Landscaping work falls under the existing classifications for laborer, operating engineer and truck driver. The work performed by landscape plantsman and landscape laborer is covered by the existing classification of laborer. The work performed by landscape operators (regardless of equipment used or its size) is covered by the classifications of operating engineer. The work performed by landscape truck drivers (regardless of size of truck driven) is covered by the classifications of truck driver.

# White County Prevailing Wage for May 2011

Trade Name	RG	TYP	C	Base	FRMAN	*M-F>8	OSA	OSH	H/W	Pensn	Vac	Trng
=====	==	===	=	=====	=====	=====	===	===	=====	=====	=====	=====
ASBESTOS ABT-GEN		ALL		24.400	24.850	1.5	1.5	2.0	5.550	9.450	0.000	0.900
ASBESTOS ABT-MEC		BLD		20.800	0.000	2.0	2.0	2.0	5.500	4.200	0.000	0.000
BOILERMAKER		BLD		31.500	34.000	1.5	1.5	2.0	6.820	11.43	1.500	0.350
BRICK MASON		BLD		27.220	28.720	1.5	1.5	2.0	7.950	6.690	0.000	0.430
CARPENTER		BLD		30.490	31.990	1.5	1.5	2.0	6.050	5.750	0.000	0.350
CARPENTER		HWY		30.440	32.190	1.5	1.5	2.0	6.050	5.750	0.000	0.350
CEMENT MASON		BLD		26.750	28.250	1.5	1.5	2.0	5.900	4.800	0.000	0.300
CEMENT MASON		HWY		25.580	27.080	1.5	1.5	2.0	5.900	5.000	0.000	0.300
CERAMIC TILE FNSHER		BLD		25.720	0.000	1.5	1.5	2.0	7.950	6.690	0.000	0.430
ELECTRICIAN		ALL		36.830	39.080	1.5	1.5	2.0	5.350	8.470	0.000	0.730
ELECTRONIC SYS TECH		BLD		29.530	31.280	1.5	1.5	2.0	5.250	3.840	0.000	0.250
FLOOR LAYER		BLD		28.930	29.680	1.5	1.5	2.0	6.050	5.750	0.000	0.350
GLAZIER		BLD		26.330	27.580	1.5	1.5	2.0	4.850	5.200	0.000	0.300
HT/FROST INSULATOR		BLD		28.920	29.920	1.5	1.5	2.0	4.800	8.160	0.000	0.280
IRON WORKER		ALL		27.020	28.270	1.5	1.5	2.0	5.760	9.600	0.000	0.345
LABORER		BLD		24.400	24.850	1.5	1.5	2.0	5.550	9.450	0.000	0.800
LABORER		HWY		24.400	24.850	1.5	1.5	2.0	5.550	9.450	0.000	0.800
MACHINIST		BLD		43.160	45.160	1.5	1.5	2.0	7.640	8.700	0.000	0.000
MARBLE FINISHERS		BLD		25.720	0.000	1.5	1.5	2.0	7.950	6.690	0.000	0.430
MARBLE MASON		BLD		27.220	28.720	1.5	1.5	2.0	7.950	6.690	0.000	0.430
MILLWRIGHT		BLD		30.490	31.990	1.5	1.5	2.0	6.050	5.750	0.000	0.350
MILLWRIGHT		HWY		30.940	32.690	1.5	1.5	2.0	6.050	5.750	0.000	0.350
OE RIVER 1		RIV 1		32.100	33.100	1.5	1.5	2.0	6.500	8.300	0.000	1.350
OE RIVER 2		RIV 2		28.750	33.100	1.5	1.5	2.0	6.500	8.300	0.000	1.350
OPERATING ENGINEER		ALL 1		32.100	33.100	1.5	1.5	2.0	6.500	8.300	0.000	1.350
OPERATING ENGINEER		ALL 2		30.200	33.100	1.5	1.5	2.0	6.500	8.300	0.000	1.350
OPERATING ENGINEER		ALL 3		24.150	33.100	1.5	1.5	2.0	6.500	8.300	0.000	1.350
OPERATING ENGINEER		ALL 4		21.400	27.800	1.5	1.5	2.0	5.650	6.100	0.000	1.100
OPERATING ENGINEER		O&C 1		24.080	25.080	1.5	1.5	2.0	6.500	8.300	0.000	1.350
OPERATING ENGINEER		O&C 2		22.650	25.080	1.5	1.5	2.0	6.500	8.300	0.000	1.350
OPERATING ENGINEER		O&C 3		18.120	25.080	1.5	1.5	2.0	6.500	8.300	0.000	1.350
OPERATING ENGINEER		O&C 4		16.050	21.100	1.5	1.5	2.0	5.650	6.100	0.000	1.100
PAINTER		BLD		24.450	25.450	1.5	1.5	2.0	6.250	5.550	0.000	0.300
PAINTER		HWY		25.600	26.600	1.5	1.5	2.0	6.250	5.550	0.000	0.300
PAINTER OVER 30FT		BLD		25.200	26.200	1.5	1.5	2.0	6.250	5.550	0.000	0.300
PAINTER PWR EQMT		BLD		25.450	26.450	1.5	1.5	2.0	6.250	5.550	0.000	0.300
PAINTER PWR EQMT		HWY		26.600	27.600	1.5	1.5	2.0	6.250	5.550	0.000	0.300
PILEDRIVER		BLD		30.490	31.990	1.5	1.5	2.0	6.050	5.750	0.000	0.350
PILEDRIVER		HWY		30.940	32.690	1.5	1.5	2.0	6.050	5.750	0.000	0.350
PIPEFITTER		BLD		32.270	34.210	1.5	1.5	2.0	5.850	8.310	0.000	0.700
PLASTERER		BLD		26.750	28.250	1.5	1.5	2.0	5.900	4.800	0.000	0.300
PLUMBER		BLD		32.270	34.210	1.5	1.5	2.0	5.850	8.310	0.000	0.700
ROOFER		BLD		26.340	28.340	1.5	1.5	2.0	6.280	4.750	0.000	0.360
SHEETMETAL WORKER		ALL		31.390	32.890	1.5	1.5	2.0	6.430	6.490	1.890	0.360
SPRINKLER FITTER		BLD		36.140	38.890	1.5	1.5	2.0	8.100	8.200	0.000	0.350
STONE MASON		BLD		27.220	28.720	1.5	1.5	2.0	7.950	6.690	0.000	0.430
TERRAZZO FINISHER		BLD		25.720	0.000	1.5	1.5	2.0	7.950	6.690	0.000	0.430
TRUCK DRIVER		ALL 1		28.430	0.000	1.5	1.5	2.0	9.050	5.500	0.000	0.250
TRUCK DRIVER		ALL 2		28.850	0.000	1.5	1.5	2.0	9.050	5.500	0.000	0.250
TRUCK DRIVER		ALL 3		29.050	0.000	1.5	1.5	2.0	9.050	5.500	0.000	0.250
TRUCK DRIVER		ALL 4		29.320	0.000	1.5	1.5	2.0	9.050	5.500	0.000	0.250
TRUCK DRIVER		ALL 5		30.100	0.000	1.5	1.5	2.0	9.050	5.500	0.000	0.250
TUCKPOINTER		BLD		27.220	28.720	1.5	1.5	2.0	7.950	6.690	0.000	0.430

Legend:

M-F>8 (Overtime is required for any hour greater than 8 worked each day, Monday through Friday.)

OSA (Overtime is required for every hour worked on Saturday)

OSH (Overtime is required for every hour worked on Sunday and Holidays)

H/W (Health & Welfare Insurance)

Pensn (Pension)

Vac (Vacation)

Trng (Training)

## Explanations

### WHITE COUNTY

The following list is considered as those days for which holiday rates of wages for work performed apply: New Years Day, Memorial Day, Fourth of July, Labor Day, Thanksgiving Day, Christmas Day and Veterans Day in some classifications/counties. Generally, any of these holidays which fall on a Sunday is celebrated on the following Monday. This then makes work performed on that Monday payable at the appropriate overtime rate for holiday pay. Common practice in a given local may alter certain days of celebration. If in doubt, please check with IDOL.

### EXPLANATION OF CLASSES

ASBESTOS - GENERAL - removal of asbestos material/mold and hazardous materials from any place in a building, including mechanical systems where those mechanical systems are to be removed. This includes the removal of asbestos materials/mold and hazardous materials from ductwork or pipes in a building when the building is to be demolished at the time or at some close future date.

ASBESTOS - MECHANICAL - removal of asbestos material from mechanical systems, such as pipes, ducts, and boilers, where the mechanical systems are to remain.

### CERAMIC TILE FINISHER, MARBLE FINISHER, TERRAZZO FINISHER

Assisting, helping or supporting the tile, marble and terrazzo mechanic by performing their historic and traditional work assignments required to complete the proper installation of the work covered by said crafts. The term "Ceramic" is used for naming the classification only, and is in no a limitation of the product handled. Ceramic takes into consideration most hard tiles.

### ELECTRONIC SYSTEMS TECHNICIAN

Installation, service and maintenance of low-voltage systems which utilizes the transmission and/or transference of voice, sound, vision, or digital for commercial, education, security and entertainment purposes for the following: TV monitoring and surveillance, background/foreground music, intercom and telephone interconnect, field programming, inventory control systems, microwave transmission, multi-media, multiplex, radio page, school, intercom and sound burglar alarms and low voltage master clock systems.



Excluded from this classification are energy management systems, life safety systems, supervisory controls and data acquisition systems not intrinsic with the above listed systems, fire alarm systems, nurse call systems and raceways exceeding fifteen feet in length.

#### TRUCK DRIVER - BUILDING, HEAVY AND HIGHWAY CONSTRUCTION

Class 1. Drivers on 2 axle trucks hauling less than 9 ton. Air compressor and welding machines and brooms, including those pulled by separate units, truck driver helpers, warehouse employees, mechanic helpers, greasers and tiremen, pickup trucks when hauling materials, tools, or workers to and from and on-the-job site, and fork lifts up to 6,000 lb. capacity.

Class 2. Two or three axle trucks hauling more than 9 ton but hauling less than 16 ton. A-frame winch trucks, hydrolift trucks, vactor trucks or similar equipment when used for transportation purposes. Fork lifts over 6,000 lb. capacity, winch trucks, four axle combination units, and ticket writers.

Class 3. Two, three or four axle trucks hauling 16 ton or more. Drivers on water pulls, articulated dump trucks, mechanics and working forepersons, and dispatchers. Five axle or more combination units.

Class 4. Low Boy and Oil Distributors.

Class 5. Drivers who require special protective clothing while employed on hazardous waste work.

#### OPERATING ENGINEERS - BUILDING, HEAVY AND HIGHWAY CONSTRUCTION

Class 1. APSCO or Equal Spreading Machine, Backhoe, Backfiller, Boom or Winch Cat, Bituminous Mixplane Machine, Blacksmith, Bituminous Surfacing Machine, Bull-Dozer, Crane, Shovel, Dragline, Truck Crane, Pile Driver, Concrete Breaker, Concrete or Pumpcrete Pumps, Dinky or Standard Locomotives, Well or Caisson Drills, Elevating Grader, Fork Lifts, Flexplane, Gradeall, Hi-Lift Hoists, Guy-Derricks, Hysters, Mechanic Motor Patrol, Mixers-21 cu. ft. or over, Push Cats, Pulls and Scrapers, Two Well Point Pumps, Pulverizer or Tiller, PugMill, Rubber-Tired Farm Type Tractor with Bulldozer/Blade/Auger or hi-lift over 1/2 yd., Jersey Spreader, Tract-Air used with Drill or Hi-Lift, Trenching or Ditching Machines, Wood Chipper w/Tractor, Self-Propelled Roller w/Blade, Equipment Greaser, Self-Propelled Bump Grinder on Concrete pavement, Boat Operator, Skid-Loaders, Tuggers, Lazer Screed, and Self-Propelled Chip Spreader (when others run conveyors).

Class 2. Any type tractor pulling any type roller or disc, Two Air Compressors (220 cu. ft. capacity or over), Two AirTract Drills, Air-Track Drill w/Compressor, Automatic Bins or Scales w/Compressor or Generator, Pipeline Boring Machine, Bulk Cement Plant w/Separate Compressor, Power Operated Bull Float, Hydra-Lift w/Single Motor, Straw Mulcher Blower w/Spout, Self-Propelled Roller/Compactor, Back-End man on Bituminous Surfacing Machine, oiler on milling machine.

Class 3. Air Compressor w/Valve driving piling, Boom or Winch Type Truck, Two Conveyors, Self-Propelled Concrete Saw, Form Grader, Truck Crane Oiler, Self-Propelled Vibrator, Rubber Tired Farm Type Tractor w/Blade/Bulldozer/Auger/hi-lift - 1/2 yd. or less, Elevator Operator, Man Lift (scissor lift) when lifting materials.

Class 4. Air-Track Drill (one), Belt Drag Machine, Power Broom, Mechanical Plasterer Applicator, Trac-Air, Air Compressor (220 cu. ft. or over) One, Air Compressor (under 220 cu. ft) four, Automatic Bin, Bulk Cement Plant w/Built-in Compressor running off same motor or

electric motor, Fireman or Switchman, Self-Propelled Form Tamper, Light Plants (4), Welding Machines (4), Pumps (4), or Combination of four (4) Pumps, Light Plants, Welding Machines, Air-Compressors (under 220 cu. ft.), Mudjacks or Wood Chipper, Mixers - less than 21 cu. ft. Mortar Mixer w/Skip or Pump, Pipeline Tract Jack. One Operating Engineer may operate and maintain any combination of the following pieces of equipment, not to exceed four (4) which shall be within a reasonable distance, such combination may include any equipment in this classification: (Compressors, Light Plants, Generators, Welding Machines, Pumps or Conveyors), One Well- Point Pump, Two Motor Driven Heaters, One Air Compressor (under 220 cu. ft.), One Engine-Driven Conveyor, One Motor Driven Heater, One Light Plant, One Pump, One Welding Machine, One Ulmac or Equal Spreader, Oilers, and one Generator 10 kw or greater.

OPERATING ENGINEER RIVER WORK 1 - operate the following machines when working on River Work and Levee Work on the Mississippi and Ohio Rivers, Lakes and Tributaries: Crane, Shovel, Drageline, Scrapers, Dredge, Derrick, Pile-Driver, Push Boat, all power boat operators, Mechanic, Engineman on Dredge, Leverman on Dredge, All Bituminous Spreader machines, Backhoe, Backfiller, Boom, or Winch Cat, Bituminous Mixplane Machine, Blacksmith, Bituminous Surfacing Machine, Bulldozer, Truck Cranes, Hydraulic Truck Mounted Boom/Crane, Concrete Finishing Machine, or Spreader Machine, Concrete Breaker, Concrete or Pumpcrete Machines, Concrete Plant Operator, All Off Road Material Hauling Equipment, Dinky or Standard Locomotives, Well Drill, Elevating Grader, Fork-Lifts, Flexplane, Gradeall, Hi-Lift, Power Handblade Tugger type Hoist, Hoist Two Drum (or over one), Gyderrick, Hyster, Motor Patrol, Mixers - 21 Cu. Ft. or over, Push Cat, Pulls, & Scrapers, Pumps-Two Well Points, Equipment Greaser, P & H Pulverizer or Pulverizer equal to Pugmill, Pugmill, Rubber-Tired farm type tractor w/Bulldozer/Blade/Auger or Hi-Lift over ½ yard, Skimmer Scoops, Seaman Tiller, Jersey Spreader, Tract-Air used with Drill or Hi-Lift, Trenching or Ditching Machine, Wood Chipper w/Tractor, self-propelled roller w/Blade, Concrete Pumps and Small Equipment Operators.

OPERATING ENGINEER RIVER 2 - when working on River Work and Levee Work on the Mississippi and Ohio Rivers, Lakes and Tributaries shall be employed as the Oiler or Fireman on Crane, Dragline, Shovel, Dredge, Truck Crane, Pile Driver, Gradeall, Dinky or Standard Locomotive, Guy Derrick, Trenching Machine or Ditching Machine 80 H.P. and over, All Terrain (cherry-picker) with over 40 ton Lifting Capacity, Deck Oiler and Deckhands.

#### Other Classifications of Work:

For definitions of classifications not otherwise set out, the Department generally has on file such definitions which are available. If a task to be performed is not subject to one of the classifications of pay set out, the Department will upon being contacted state which neighboring county has such a classification and provide such rate, such rate being deemed to exist by reference in this document. If no neighboring county rate applies to the task, the Department shall undertake a special determination, such special determination being then deemed to have existed under this determination. If a project requires these, or any classification not listed, please contact IDOL at 217-782-1710 for wage rates or clarifications.

#### LANDSCAPING

Landscaping work falls under the existing classifications for laborer, operating engineer and truck driver. The work performed by landscape plantsman and landscape laborer is covered by the existing classification of laborer. The work performed by landscape operators (regardless of equipment used or its size) is covered by the classifications of operating engineer. The work performed by landscape truck drivers (regardless of size of truck driven) is covered by the classifications of truck driver.

# Williamson County Prevailing Wage for May 2011

Trade Name	RG	TYP	C	Base	FRMAN	*M-F>8	OSA	OSH	H/W	Pensn	Vac	Trng
=====	==	===	=	=====	=====	=====	===	===	=====	=====	=====	=====
ASBESTOS ABT-GEN		ALL		24.400	24.850	1.5	1.5	2.0	5.550	9.450	0.000	0.900
ASBESTOS ABT-MEC		BLD		20.800	0.000	2.0	2.0	2.0	5.500	4.200	0.000	0.000
BOILERMAKER		BLD		31.500	34.000	1.5	1.5	2.0	6.820	11.43	1.500	0.350
BRICK MASON		BLD		27.220	28.720	1.5	1.5	2.0	7.950	6.690	0.000	0.430
CARPENTER		BLD		30.490	31.990	1.5	1.5	2.0	6.050	5.750	0.000	0.350
CARPENTER		HWY		30.440	31.940	1.5	1.5	2.0	6.050	5.750	0.000	0.350
CEMENT MASON		BLD		26.750	28.250	1.5	1.5	2.0	5.900	4.800	0.000	0.300
CEMENT MASON		HWY		26.350	27.350	1.5	1.5	2.0	5.900	4.350	0.000	0.300
CERAMIC TILE FNSHER		BLD		25.720	0.000	1.5	1.5	2.0	7.950	6.690	0.000	0.430
ELECTRICIAN		ALL		36.830	39.080	1.5	1.5	2.0	5.350	8.470	0.000	0.730
ELECTRONIC SYS TECH		BLD		29.530	31.280	1.5	1.5	2.0	5.250	3.840	0.000	0.250
FLOOR LAYER		BLD		28.930	29.680	1.5	1.5	2.0	6.050	5.750	0.000	0.350
GLAZIER		BLD		26.330	27.580	1.5	1.5	2.0	4.850	5.200	0.000	0.300
HT/FROST INSULATOR		BLD		28.920	29.920	1.5	1.5	2.0	4.800	8.160	0.000	0.280
IRON WORKER		ALL		26.740	28.740	1.5	1.5	2.0	5.760	9.590	0.000	0.500
LABORER		BLD		24.400	24.850	1.5	1.5	2.0	5.550	9.450	0.000	0.800
LABORER		HWY		24.400	24.850	1.5	1.5	2.0	5.550	9.450	0.000	0.800
LABORER		O&C		17.740	18.190	1.5	1.5	2.0	5.450	8.450	0.000	0.800
MACHINIST		BLD		43.160	45.160	1.5	1.5	2.0	7.640	8.700	0.000	0.000
MARBLE FINISHERS		BLD		25.720	0.000	1.5	1.5	2.0	7.950	6.690	0.000	0.430
MARBLE MASON		BLD		27.220	28.720	1.5	1.5	2.0	7.950	6.690	0.000	0.430
MILLWRIGHT		BLD		30.490	31.990	1.5	1.5	2.0	6.050	5.750	0.000	0.350
MILLWRIGHT		HWY		30.440	31.940	1.5	1.5	2.0	6.050	5.750	0.000	0.350
OE RIVER 1		RIV	1	32.100	33.100	1.5	1.5	2.0	6.500	8.300	0.000	1.350
OE RIVER 2		RIV	2	28.750	33.100	1.5	1.5	2.0	6.500	8.300	0.000	1.350
OPERATING ENGINEER		ALL	1	32.100	33.100	1.5	1.5	2.0	6.500	8.300	0.000	1.350
OPERATING ENGINEER		ALL	2	30.200	33.100	1.5	1.5	2.0	6.500	8.300	0.000	1.350
OPERATING ENGINEER		ALL	3	24.150	33.100	1.5	1.5	2.0	6.500	8.300	0.000	1.350
OPERATING ENGINEER		ALL	4	21.400	27.800	1.5	1.5	2.0	5.650	6.100	0.000	1.100
OPERATING ENGINEER		O&C	1	24.080	25.080	1.5	1.5	2.0	6.500	8.300	0.000	1.350
OPERATING ENGINEER		O&C	2	22.650	25.080	1.5	1.5	2.0	6.500	8.300	0.000	1.350
OPERATING ENGINEER		O&C	3	18.120	25.080	1.5	1.5	2.0	6.500	8.300	0.000	1.350
OPERATING ENGINEER		O&C	4	16.050	21.100	1.5	1.5	2.0	5.650	6.100	0.000	1.100
PAINTER		BLD		26.260	27.760	1.5	1.5	2.0	6.130	6.950	0.000	0.450
PAINTER		HWY		30.560	32.060	1.5	1.5	2.0	6.130	6.950	0.000	0.450
PAINTER OVER 30FT		BLD		27.260	28.760	1.5	1.5	2.0	6.130	6.950	0.000	0.450
PAINTER PWR EQMT		BLD		27.260	28.760	1.5	1.5	2.0	6.130	6.950	0.000	0.450
PAINTER PWR EQMT		HWY		31.560	33.060	1.5	1.5	2.0	6.130	6.950	0.000	0.450
PILEDRIVER		BLD		30.490	31.990	1.5	1.5	2.0	6.050	5.750	0.000	0.350
PILEDRIVER		HWY		30.440	31.940	1.5	1.5	2.0	6.050	5.750	0.000	0.350
PIPEFITTER		BLD		32.250	35.470	1.5	1.5	2.0	8.250	8.850	0.000	1.200
PLASTERER		BLD		26.750	28.250	1.5	1.5	2.0	5.900	4.800	0.000	0.300
PLUMBER		BLD		32.250	35.470	1.5	1.5	2.0	8.250	8.850	0.000	1.200
ROOFER		BLD		22.250	23.250	1.5	1.5	2.0	7.900	3.800	0.000	0.000
SHEETMETAL WORKER		ALL		31.390	32.890	1.5	1.5	2.0	6.430	6.490	1.890	0.360
SPRINKLER FITTER		BLD		36.140	38.890	1.5	1.5	2.0	8.100	8.200	0.000	0.350
STONE MASON		BLD		27.220	28.720	1.5	1.5	2.0	7.950	6.690	0.000	0.430
TERRAZZO FINISHER		BLD		25.720	0.000	1.5	1.5	2.0	7.950	6.690	0.000	0.430
TERRAZZO MASON		BLD		28.500	28.800	1.5	1.5	2.0	6.400	5.700	0.000	0.430
TRUCK DRIVER		ALL	1	28.430	0.000	1.5	1.5	2.0	9.050	5.500	0.000	0.250
TRUCK DRIVER		ALL	2	28.850	0.000	1.5	1.5	2.0	9.050	5.500	0.000	0.250
TRUCK DRIVER		ALL	3	29.050	0.000	1.5	1.5	2.0	9.050	5.500	0.000	0.250
TRUCK DRIVER		ALL	4	29.320	0.000	1.5	1.5	2.0	9.050	5.500	0.000	0.250
TRUCK DRIVER		ALL	5	30.100	0.000	1.5	1.5	2.0	9.050	5.500	0.000	0.250
TRUCK DRIVER		O&C	1	22.750	0.000	1.5	1.5	2.0	2.920	6.700	0.000	0.250
TRUCK DRIVER		O&C	2	19.150	0.000	1.5	1.5	2.0	2.920	6.700	0.000	0.250
TRUCK DRIVER		O&C	3	19.650	0.000	1.5	1.5	2.0	2.920	6.700	0.000	0.250
TUCKPOINTS		BLD		27.220	28.720	1.5	1.5	2.0	7.950	6.690	0.000	0.430

Legend :

M-F>8 (Overtime is required for any hour greater than 8 worked each day, Monday through Friday.

OSA (Overtime is required for every hour worked on Saturday)

OSH (Overtime is required for every hour worked on Sunday and Holidays)

H/W (Health & Welfare Insurance)

Pensn (Pension)

Vac (Vacation)

Trng (Training)

## Explanations

### WILLIAMSON COUNTY

The following list is considered as those days for which holiday rates of wages for work performed apply: New Years Day, Memorial Day, Fourth of July, Labor Day, Thanksgiving Day, Christmas Day and Veterans Day in some classifications/counties. Generally, any of these holidays which fall on a Sunday is celebrated on the following Monday. This then makes work performed on that Monday payable at the appropriate overtime rate for holiday pay. Common practice in a given local may alter certain days of celebration. If in doubt, please check with IDOL.

Oil and chip resealing (O&C) means the application of road oils and liquid asphalt to coat an existing road surface, followed by application of aggregate chips or gravel to coated surface, and subsequent rolling of material to seal the surface.

### EXPLANATION OF CLASSES

ASBESTOS - GENERAL - removal of asbestos material/mold and hazardous materials from any place in a building, including mechanical systems where those mechanical systems are to be removed. This includes the removal of asbestos materials/mold and hazardous materials from ductwork or pipes in a building when the building is to be demolished at the time or at some close future date.

ASBESTOS - MECHANICAL - removal of asbestos material from mechanical systems, such as pipes, ducts, and boilers, where the mechanical systems are to remain.

### LABORER - OIL AND CHIP RESEALING ONLY

Hook and unhook chip box from aggregate truck; distribute material within chip box; perform flagging work related to oil and chip resealing; hand spray oil fluids; handle traffic control, including setting-up and maintaining barricades, drums, cones, delineators, signs and other such items, as well as laying-out and applying or removing temporary roadway markings used to control traffic in job

site related to oil and chip resealing; and perform clean-up related to oil and chip resealing.

#### CERAMIC TILE FINISHER, MARBLE FINISHER, TERRAZZO FINISHER

Assisting, helping or supporting the tile, marble and terrazzo mechanic by performing their historic and traditional work assignments required to complete the proper installation of the work covered by said crafts. The term "Ceramic" is used for naming the classification only, and is in no a limitation of the product handled. Ceramic takes into consideration most hard tiles.

#### ELECTRONIC SYSTEMS TECHNICIAN

Installation, service and maintenance of low-voltage systems which utilizes the transmission and/or transference of voice, sound, vision, or digital for commercial, education, security and entertainment purposes for the following: TV monitoring and surveillance, background/foreground music, intercom and telephone interconnect, field programming, inventory control systems, microwave transmission, multi-media, multiplex, radio page, school, intercom and sound burglar alarms and low voltage master clock systems.

Excluded from this classification are energy management systems, life safety systems, supervisory controls and data acquisition systems not intrinsic with the above listed systems, fire alarm systems, nurse call systems and raceways exceeding fifteen feet in length.

#### TRUCK DRIVER - BUILDING, HEAVY AND HIGHWAY CONSTRUCTION

Class 1. Drivers on 2 axle trucks hauling less than 9 ton. Air compressor and welding machines and brooms, including those pulled by separate units, truck driver helpers, warehouse employees, mechanic helpers, greasers and tiremen, pickup trucks when hauling materials, tools, or workers to and from and on-the-job site, and fork lifts up to 6,000 lb. capacity.

Class 2. Two or three axle trucks hauling more than 9 ton but hauling less than 16 ton. A-frame winch trucks, hydrolift trucks, vector trucks or similar equipment when used for transportation purposes. Fork lifts over 6,000 lb. capacity, winch trucks, four axle combination units, and ticket writers.

Class 3. Two, three or four axle trucks hauling 16 ton or more. Drivers on water pulls, articulated dump trucks, mechanics and working forepersons, and dispatchers. Five axle or more combination units.

Class 4. Low Boy and Oil Distributors.

Class 5. Drivers who require special protective clothing while employed on hazardous waste work.

#### TRUCK DRIVER - O & C (Oil and Chip Resealing ONLY)

It involves driving of contractor or subcontractor owned, leased, or hired pickup, dump, service, or oil distributor trucks. Includes transporting materials and equipment (including, but not limited to oils, aggregate supplies, parts, machinery and tools) to or from the job site; distributing oil or liquid asphalt and aggregate; stock piling material; and maintaining trucks at job site related to oil and chip resealing.

Class 1. Distributors, liquid asphalt hauling and hauling of asphalt rubber-tired rollers.

Class 2. Stockpiling.

Class 3. Tandem hauling to job site.

#### OPERATING ENGINEERS - BUILDING, HEAVY AND HIGHWAY CONSTRUCTION

Class 1. APSCO or Equal Spreading Machine, Backhoe, Backfiller, Boom or Winch Cat, Bituminous Mixplane Machine, Blacksmith, Bituminous Surfacing Machine, Bull-Dozer, Crane, Shovel, Dragline, Truck Crane, Pile Driver, Concrete Breaker, Concrete or Pumpcrete Pumps, Dinky or Standard Locomotives, Well or Caisson Drills, Elevating Grader, Fork Lifts, Flexplane, Gradeall, Hi-Lift Hoists, Guy-Derricks, Hysters, Mechanic Motor Patrol, Mixers-21 cu. ft. or over, Push Cats, Pulls and Scrapers, Two Well Point Pumps, Pulverizer or Tiller, PugMill, Rubber-Tired Farm Type Tractor with Bulldozer/Blade/Auger or hi-lift over 1/2 yd., Jersey Spreader, Tract-Air used with Drill or Hi-Lift, Trenching or Ditching Machines, Wood Chipper w/Tractor, Self-Propelled Roller w/Blade, Equipment Greaser, Self-Propelled Bump Grinder on Concrete pavement, Boat Operator, Skid-Loaders, Tuggers, Lazer Screed, and Self-Propelled Chip Spreader (when others run conveyors).

Class 2. Any type tractor pulling any type roller or disc, Two Air Compressors (220 cu. ft. capacity or over), Two AirTract Drills, Air-Track Drill w/Compressor, Automatic Bins or Scales w/Compressor or Generator, Pipeline Boring Machine, Bulk Cement Plant w/Separate Compressor, Power Operated Bull Float, Hydra-Lift w/Single Motor, Straw Mulcher Blower w/Spout, Self-Propelled Roller/Compactor, Back-End man on Bituminous Surfacing Machine, oiler on milling machine.

Class 3. Air Compressor w/Valve driving piling, Boom or Winch Type Truck, Two Conveyors, Self-Propelled Concrete Saw, Form Grader, Truck Crane Oiler, Self-Propelled Vibrator, Rubber Tired Farm Type Tractor w/Blade/Bulldozer/Auger/hi-lift - 1/2 yd. or less, Elevator Operator, Man Lift (scissor lift) when lifting materials.

Class 4. Air-Track Drill (one), Belt Drag Machine, Power Broom, Mechanical Plasterer Applicator, Trac-Air, Air Compressor (220 cu. ft. or over) One, Air Compressor (under 220 cu. ft) four, Automatic Bin, Bulk Cement Plant w/Built-in Compressor running off same motor or electric motor, Fireman or Switchman, Self-Propelled Form Tamper, Light Plants (4), Welding Machines (4), Pumps (4), or Combination of four (4) Pumps, Light Plants, Welding Machines, Air-Compressors (under 220 cu. ft.), Mudjacks or Wood Chipper, Mixers - less than 21 cu. ft. Mortar Mixer w/Skip or Pump, Pipeline Tract Jack. One Operating Engineer may operate and maintain any combination of the following pieces of equipment, not to exceed four (4) which shall be within a reasonable distance, such combination may include any equipment in this classification: (Compressors, Light Plants, Generators, Welding Machines, Pumps or Conveyors), One Well- Point Pump, Two Motor Driven Heaters, One Air Compressor (under 220 cu. ft.), One Engine-Driven Conveyor, One Motor Driven Heater, One Light Plant, One Pump, One Welding Machine, One Ulmac or Equal Spreader, Oilers, and one Generator 10 kw or greater.

OPERATING ENGINEER - O & C (Oil and Chip Resealing ONLY). Includes the operation of all motorized heavy equipment used in oil and chip rsealing, including but not limited to operating self-propelled chip spreaders, and all types of rollers (both hard and rubber tired); and other duties pertaining to the operation or maintenance of heavy equipment related to oil and chip resealing.

Class 1. See Class 1 above for types of equipment operated.

Class 2. See Class 2 above for types of equipment operated.  
Class 3. See Class 3 above for types of equipment operated.  
Class 4. See Class 4 above for types of equipment operated.

OPERATING ENGINEER RIVER WORK 1 - operate the following machines when working on River Work and Levee Work on the Mississippi and Ohio Rivers, Lakes and Tributaries: Crane, Shovel, Drageline, Scrapers, Dredge, Derrick, Pile-Driver, Push Boat, all power boat operators, Mechanic, Engineman on Dredge, Leverman on Dredge, All Bituminous Spreader machines, Backhoe, Backfiller, Boom, or Winch Cat, Bituminous Mixplane Machine, Blacksmith, Bituminous Surfacing Machine, Bulldozer, Truck Cranes, Hydraulic Truck Mounted Boom/Crane, Concrete Finishing Machine, or Spreader Machine, Concrete Breaker, Concrete or Pumpcrete Machines, Concrete Plant Operator, All Off Road Material Hauling Equipment, Dinky or Standard Locomotives, Well Drill, Elevating Grader, Fork-Lifts, Flexplane, Gradeall, Hi-Lift, Power Handblade Tugger type Hoist, Hoist Two Drum (or over one), Gyderrick, Hyster, Motor Patrol, Mixers - 21 Cu. Ft. or over, Push Cat, Pulls, & Scrapers, Pumps-Two Well Points, Equipment Greaser, P & H Pulverizer or Pulverizer equal to Pugmill, Pugmill, Rubber-Tired farm type tractor w/Bulldozer/Blade/Auger or Hi-Lift over ½ yard, Skimmer Scoops, Seaman Tiller, Jersey Spreader, Tract-Air used with Drill or Hi-Lift, Trenching or Ditching Machine, Wood Chipper w/Tractor, self-propelled roller w/Blade, Concrete Pumps and Small Equipment Operators.

OPERATING ENGINEER RIVER 2 - when working on River Work and Levee Work on the Mississippi and Ohio Rivers, Lakes and Tributaries shall be employed as the Oiler or Fireman on Crane, Dragline, Shovel, Dredge, Truck Crane, Pile Driver, Gradeall, Dinky or Standard Locomotive, Guy Derrick, Trenching Machine or Ditching Machine 80 H.P. and over, All Terrain (cherry-picker) with over 40 ton Lifting Capacity, Deck Oiler and Deckhands.

#### Other Classifications of Work:

For definitions of classifications not otherwise set out, the Department generally has on file such definitions which are available. If a task to be performed is not subject to one of the classifications of pay set out, the Department will upon being contacted state which neighboring county has such a classification and provide such rate, such rate being deemed to exist by reference in this document. If no neighboring county rate applies to the task, the Department shall undertake a special determination, such special determination being then deemed to have existed under this determination. If a project requires these, or any classification not listed, please contact IDOL at 217-782-1710 for wage rates or clarifications.

#### LANDSCAPING

Landscaping work falls under the existing classifications for laborer, operating engineer and truck driver. The work performed by landscape plantsman and landscape laborer is covered by the existing classification of laborer. The work performed by landscape operators (regardless of equipment used or its size) is covered by the classifications of operating engineer. The work performed by landscape truck drivers (regardless of size of truck driven) is covered by the classifications of truck driver.