

STATE OF ILLINOIS  
DEPARTMENT OF TRANSPORTATION

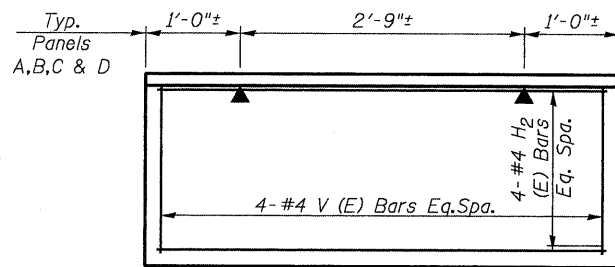

PANEL A REINFORCEMENT

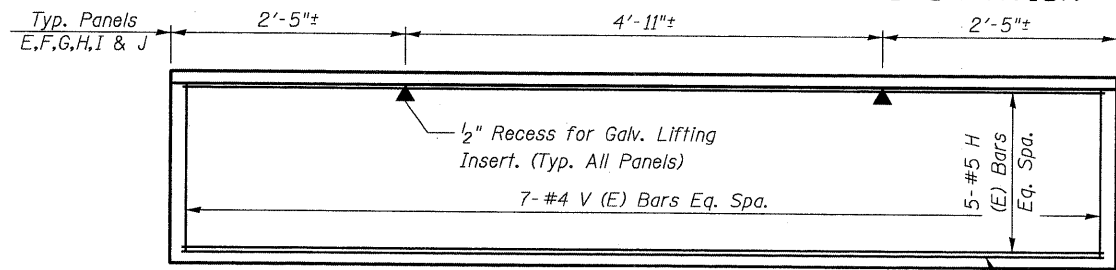

PANEL E REINFORCEMENT

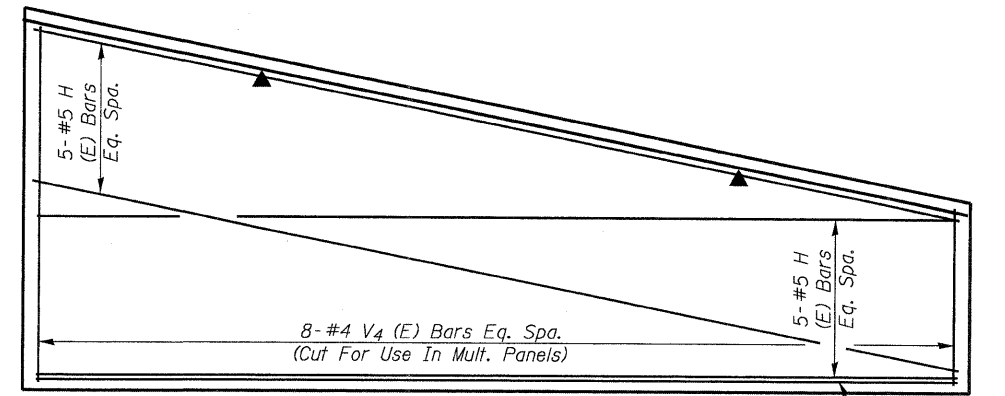

PANEL J REINFORCEMENT

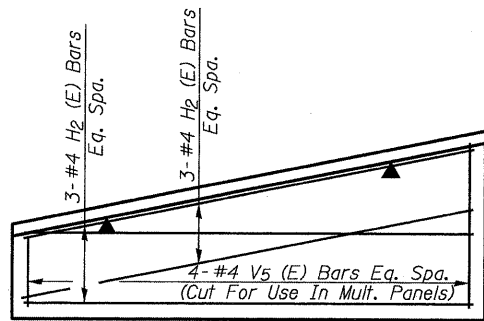

PANEL B REINFORCEMENT

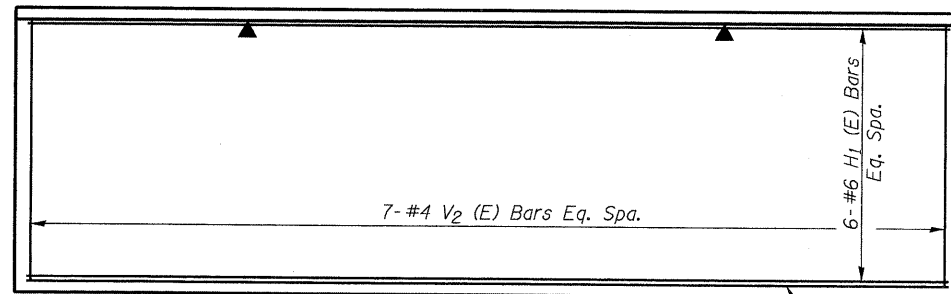

PANEL F REINFORCEMENT

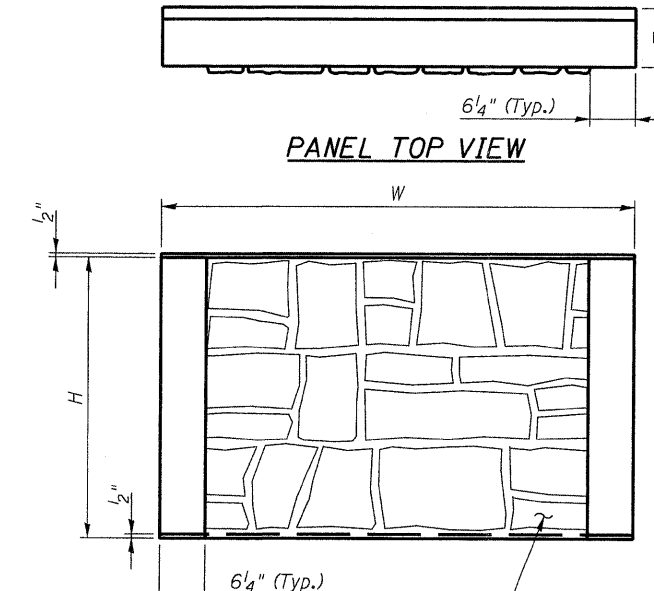

PANEL TOP VIEW

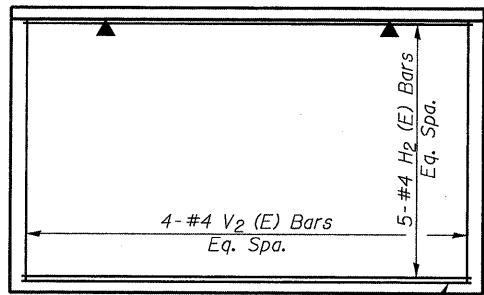

PANEL C REINFORCEMENT

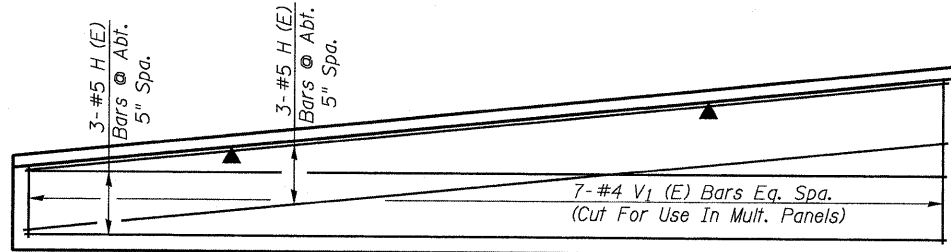

PANEL G REINFORCEMENT

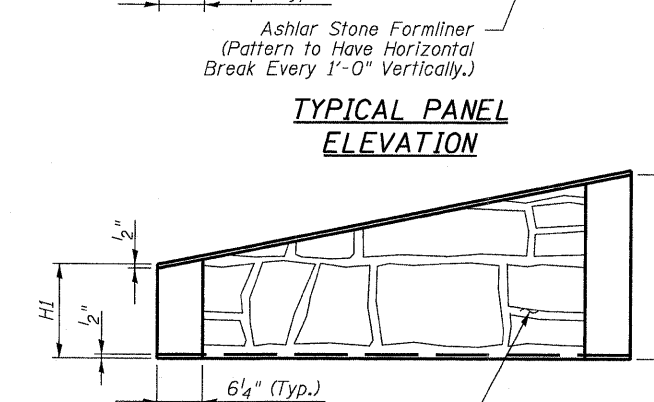

TYPICAL PANEL ELEVATION

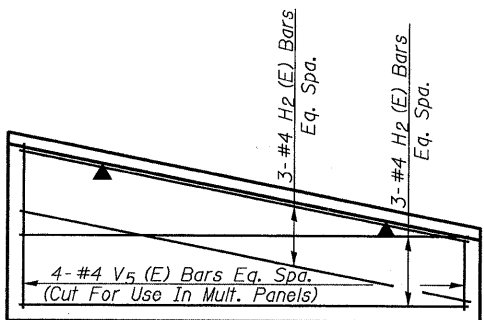

PANEL D REINFORCEMENT

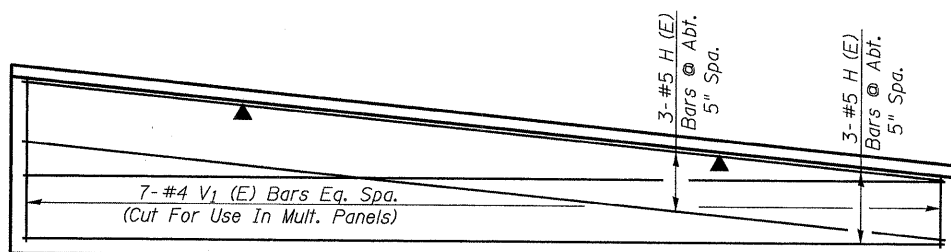

PANEL H REINFORCEMENT

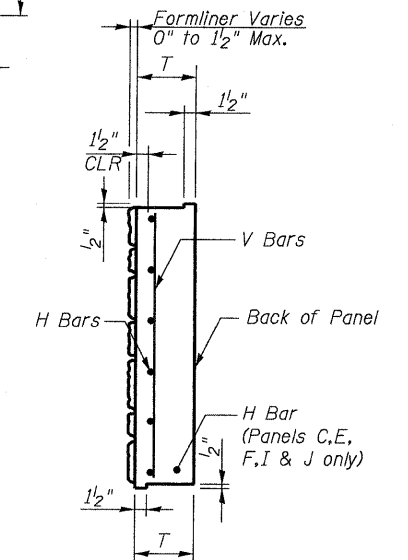

PANEL END VIEW

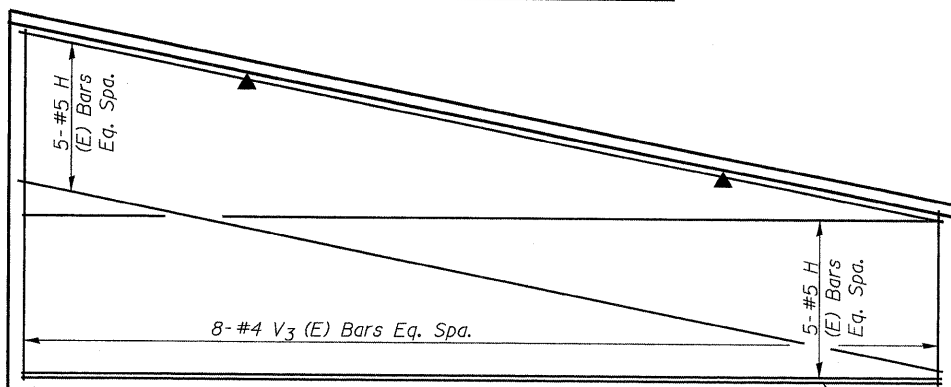

PANEL I REINFORCEMENT

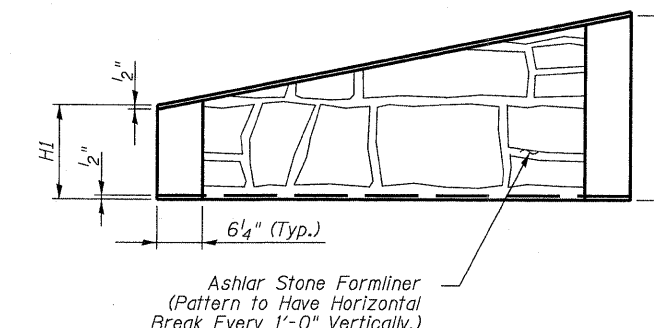

SLOPED PANEL ELEVATION

(Left end low shown.  
Right end low opp. hand.)  
(Left end low shown.  
Right end low opp. hand.)

PANEL DETAILS  
STRUCTURE NO. 071-7005

PANEL DIMENSIONS TABLE

PANEL	H	H1	H2	W	T
A	1'-11 <sup>3</sup> / <sub>4</sub> "	-	-	4'-9"	9 <sup>1</sup> / <sub>4</sub> "
B	-	11 <sup>3</sup> / <sub>4</sub> "	1'-11 <sup>3</sup> / <sub>4</sub> "	4'-9"	9 <sup>1</sup> / <sub>4</sub> "
C	2'-11 <sup>3</sup> / <sub>4</sub> "	-	-	4'-9"	9 <sup>1</sup> / <sub>4</sub> "
D	-	1'-11 <sup>3</sup> / <sub>4</sub> "	11 <sup>3</sup> / <sub>4</sub> "	4'-9"	9 <sup>1</sup> / <sub>4</sub> "
E	1'-11 <sup>3</sup> / <sub>4</sub> "	-	-	9'-9"	9 <sup>1</sup> / <sub>4</sub> "
F	2'-11 <sup>3</sup> / <sub>4</sub> "	-	-	9'-9"	9 <sup>1</sup> / <sub>4</sub> "
G	-	11 <sup>3</sup> / <sub>4</sub> "	1'-11 <sup>3</sup> / <sub>4</sub> "	9'-9"	9 <sup>1</sup> / <sub>4</sub> "
H	-	1'-11 <sup>3</sup> / <sub>4</sub> "	11 <sup>3</sup> / <sub>4</sub> "	9'-9"	9 <sup>1</sup> / <sub>4</sub> "
I	-	3'-11 <sup>3</sup> / <sub>4</sub> "	1'-11 <sup>3</sup> / <sub>4</sub> "	9'-9"	9 <sup>1</sup> / <sub>4</sub> "
J	-	4'-11 <sup>3</sup> / <sub>4</sub> "	1'-11 <sup>3</sup> / <sub>4</sub> "	9'-9"	9 <sup>1</sup> / <sub>4</sub> "

DESIGNED CTH
CHECKED DFM
DRAWN CTH
CHECKED DFM

SHEET NO. 11 18 SHEETS	F.A.P. RTE. 742	SECTION 37R-4	COUNTY OGLE	TOTAL SHEETS 867	SHEET NO. 246
	CONTRACT NO. 64E17 FED. ROAD DIST. NO. 7 ILLINOIS FED. AID PROJECT				