

FABRIC BEARING PAD
(Interior - 16 Req'd.)

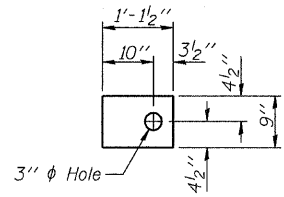

FABRIC BEARING PAD
(Exterior - 4 Req'd.)

FIXED

Note: Omit holes when using expansion bearings.

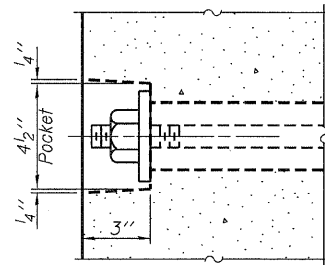

SECTION A-A

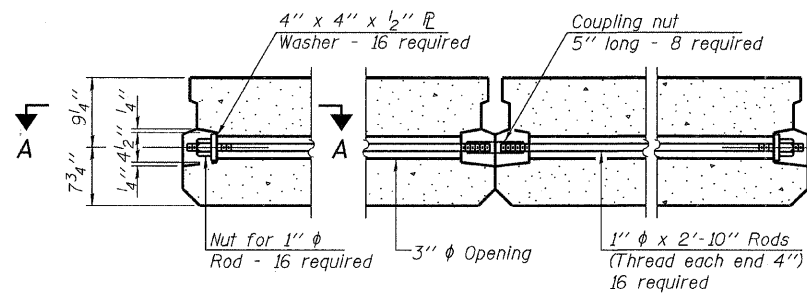

TYPICAL TRANSVERSE TIE ASSEMBLY

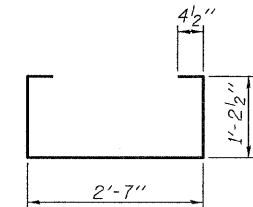

BAR S(E)

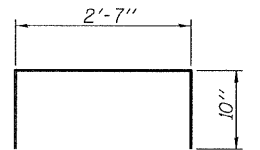

BAR S1(E)

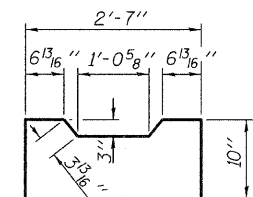

BAR S2(E)

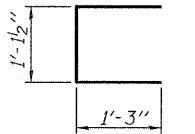

BAR U(E)

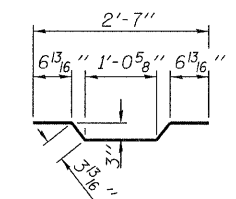

BAR U1(E)

BAR A1(E)

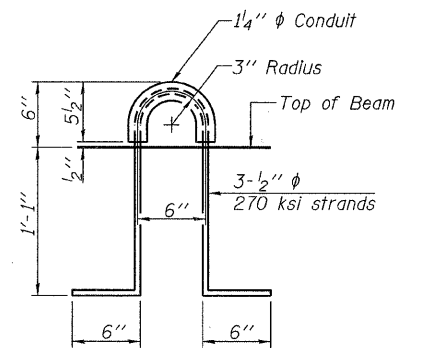

LIFTING LOOP DETAIL

BILL OF MATERIAL

Precast Prestressed Conc. Deck Bms. (17" depth)	Sq. Ft.	1,080
---	---------	-------

SUPERSTRUCTURE
17" X 36" PPC DECK BEAM DETAILS
STRUCTURE NO. 027-3438

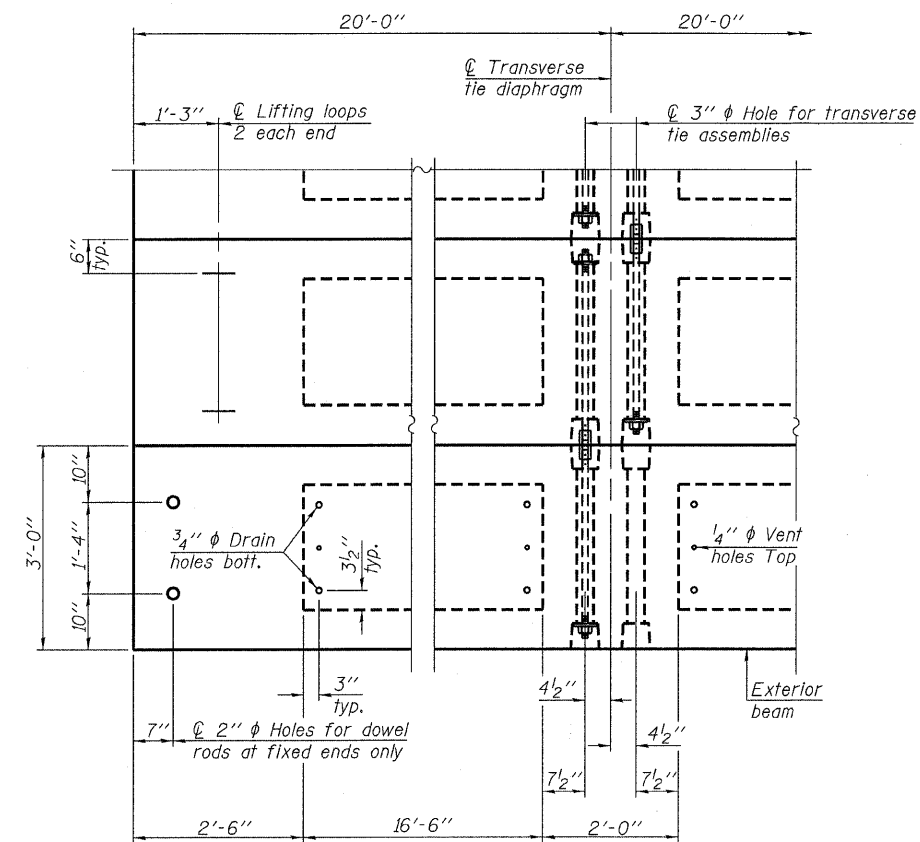

PLAN VIEW

Note: Connect beams in pairs with the transverse tie configuration shown.

NOTES

- Prestressing steel shall be uncoated high strength, low relaxation 7-wire strand, Grade 270. The nominal diameter shall be 1/2" and the nominal cross-sectional area shall be 0.153 sq. in.
- The 1" rods in the transverse tie assembly shall be tightened to a snug fit and the threads set. Pockets on exterior faces of bridge shall be filled with grout after transverse tie assembly is in place.
- Reinforcement bars shall conform to ASTM A 706, Grade 60. (See Special Provisions).
- Two 1/8" fabric adjusting shims of the dimensions of the exterior bearing pad shall be provided for each bearing pad location.
- A minimum 2 1/2" diameter lifting pin shall be used to engage the lifting loops during handling.
- Corrosion Inhibitor, per Article 1020.05(b)(12) and 1021.06 of the Standard Specifications, shall be used in the concrete for precast prestressed concrete deck beams.
- Compressive strength of prestressed concrete, f'c, shall be 6000 psi.
- Compressive strength of prestressed concrete at release, f'ci, shall be 5000 psi.

DESIGNED - A.S.L.
CHECKED - M.G.B.
DRAWN - D.T.M.
CHECKED - D.A.B.

PD-1736-0D 5-16-08

HAMPTON, LENZINI & RENWICK, INC.
CIVIL & STRUCTURAL ENGINEERS
LAND SURVEYORS
HLR
3085 STEVENSON DRIVE, SUITE 201
SPRINGFIELD, ILLINOIS 62703
(217) 546-3400
PROJECT NUMBER: 07-0432.130 DATE: 03/31/09

F.A.S.	SECTION	COUNTY	TOTAL SHEETS	SHEET NO.
340	09-00106-00-BR	FORD	32	16
CONTRACT NO. 87411				
FED. ROAD DIST. NO. ILLINOIS FED. AID PROJECT				