

CONTRACT: 78040
 ROUTE: F.A.I. 57
 SECTION: (02-1B-1)P-1
 COUNTY: ALEXANDER, IL; MISSISSIPPI, MO
 SHEET 26 OF 67
 FOR INFORMATION ONLY

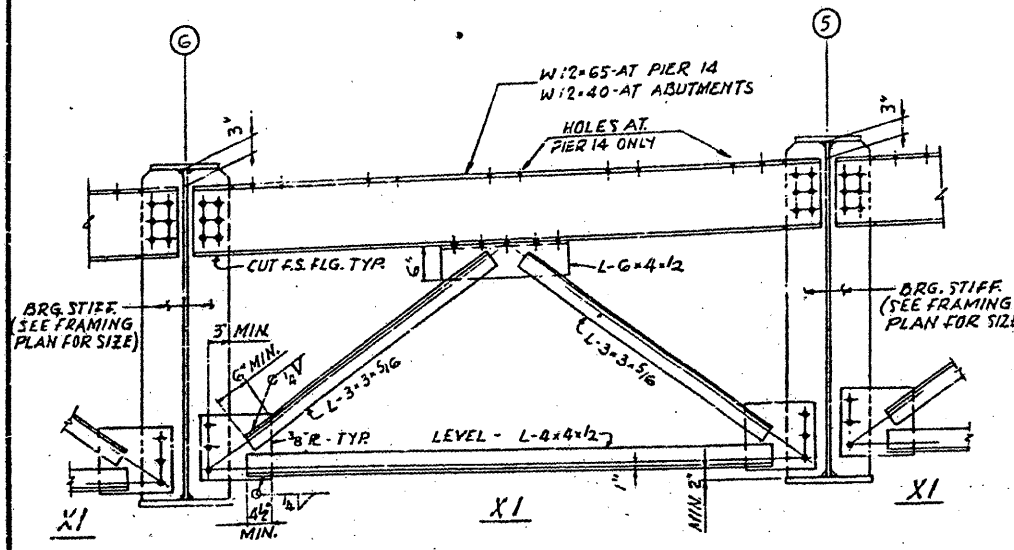

CROSSFRAME X1 (AT ABUTMENT & PIER)
 SCALE: 3/4" = 1'-0"

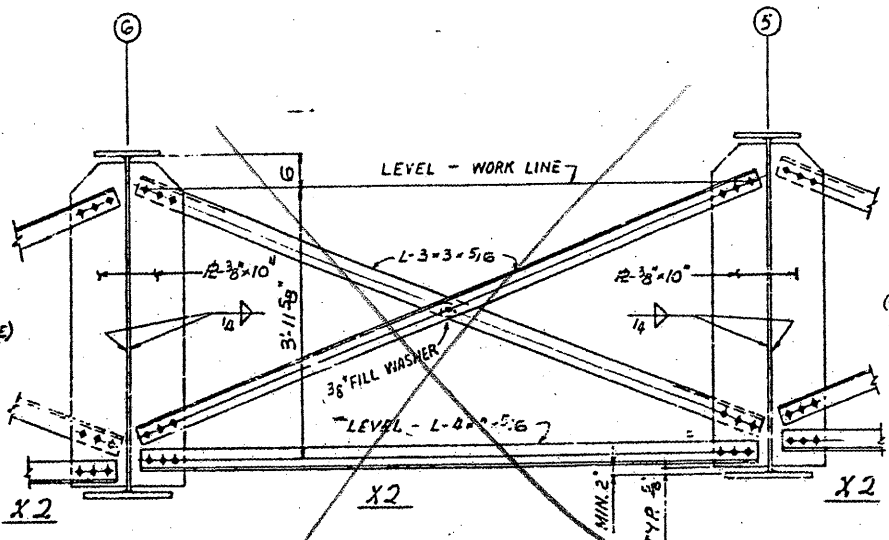

INTERMEDIATE CROSSFRAME X2
 SCALE: 3/4" = 1'-0"

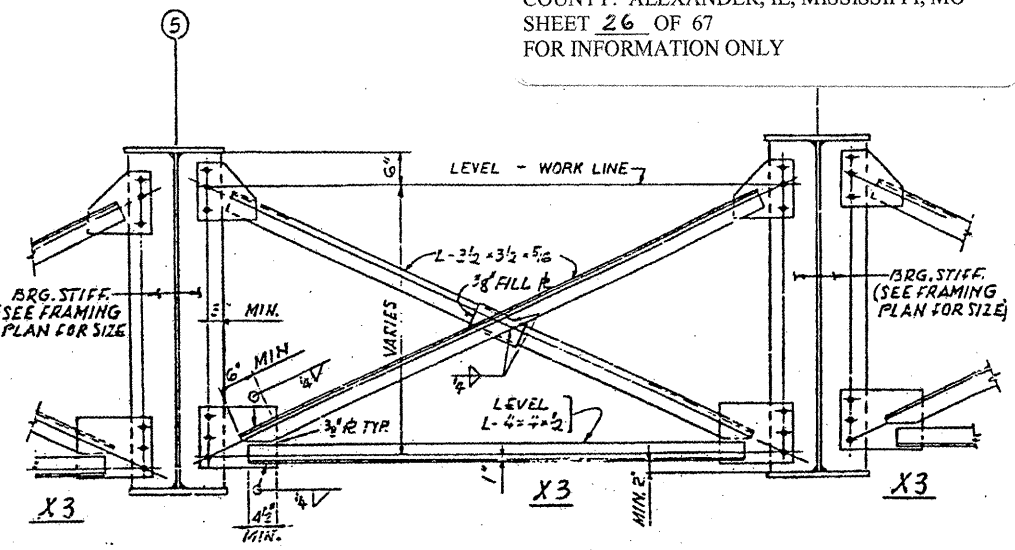

CROSSFRAME X3 (AT PIER)
 SCALE: 3/4" = 1'-0"

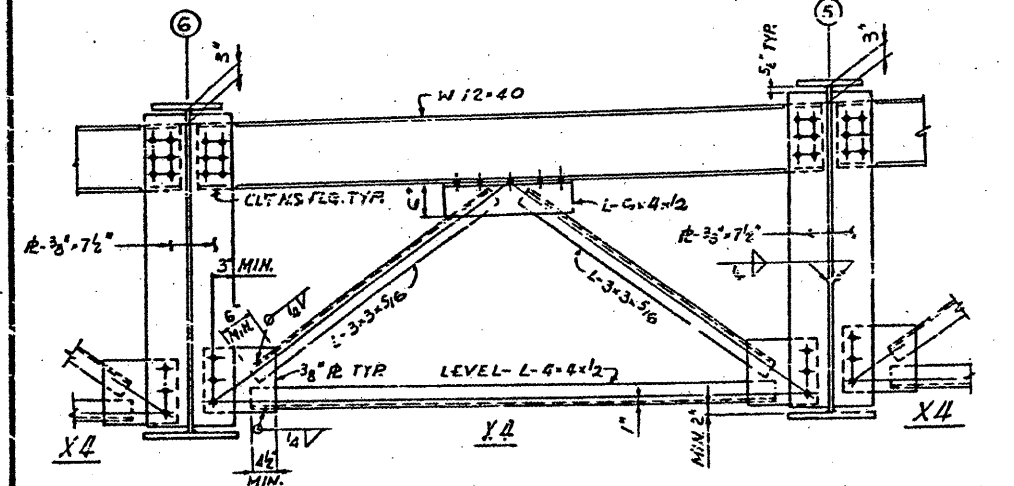

CROSSFRAME X4 (AT LINK)
 SCALE: 3/4" = 1'-0"

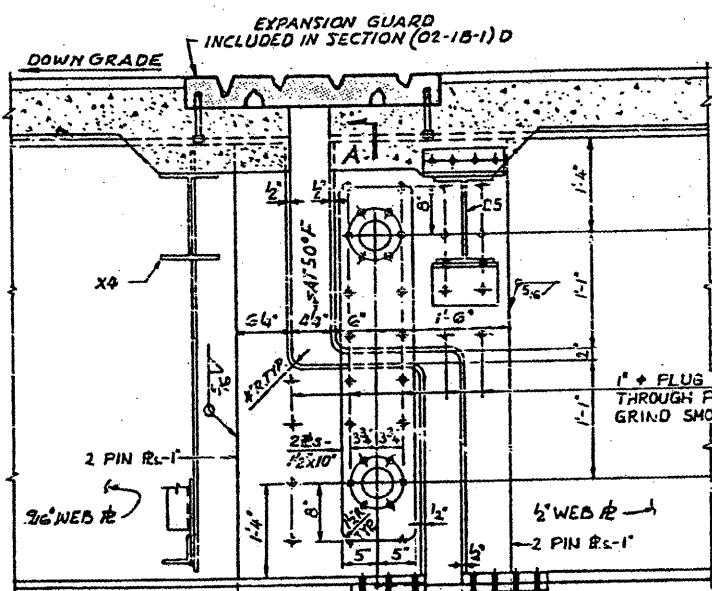

LINK DETAILS - SPAN 4

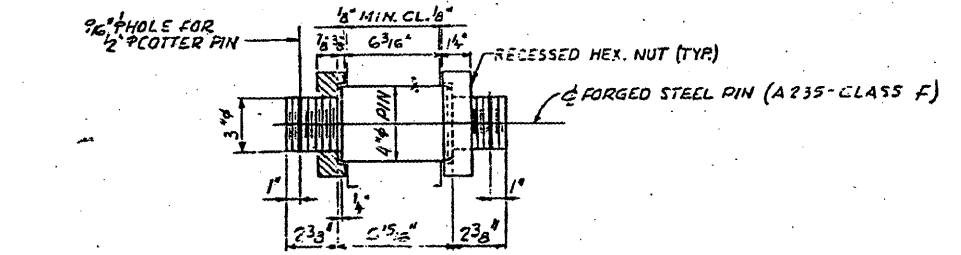

PIN DETAIL
 NUTS SHALL BE SHUDDERED UP FINGER TIGHT AGAINST SHOULDERS OF PIN. TOTAL NO. OF PINS REQUIRED = 14

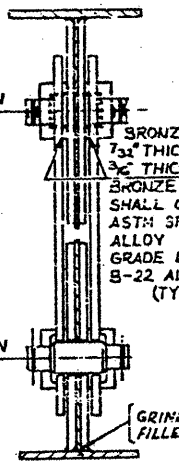

SECTION A-A

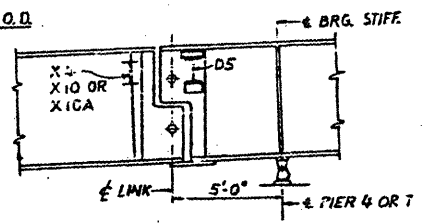

LINK SETTING ELEVATION
 LINK IN SPAN 4 SHOWN. LINK IN SPAN 7 SIMILAR

NOTES: ALL FASTENERS SHALL BE 3/4" ASTM A 325 HIGH STRENGTH BOLTS UNLESS NOTED.

BRIDGE NO. 1
 STRUCTURE NO. 002-0022
 FOR INFORMATION ONLY

GIRDER CROSSFRAMES AND LINK DETAILS
 F. A. I. RTE. 57 OVER THE MISSISSIPPI RIVER
 PROJECT 1-57-9 (510)
 SECTION (02-1B-1) D
 ALEXANDER COUNTY, ILLINOIS
 MISSISSIPPI COUNTY, MISSOURI
 STA. 1141 + 84.75 TO STA. 1182 + 75.55

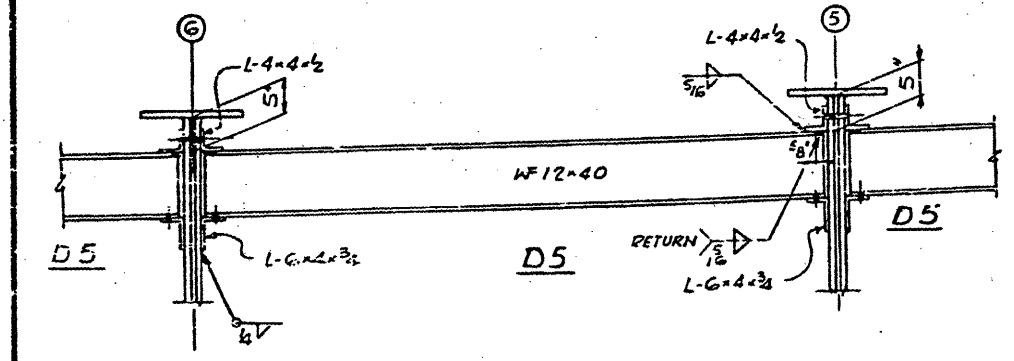

DIAPHRAGM D5 (AT LINK)
 SCALE: 3/4" = 1'-0"