

POSITION OF HANDHOLE AND POLE NUMBER FOR SINGLE MAST ARM POLES MOUNTED ON BRIDGE PARAPET OR BARRIER WALL

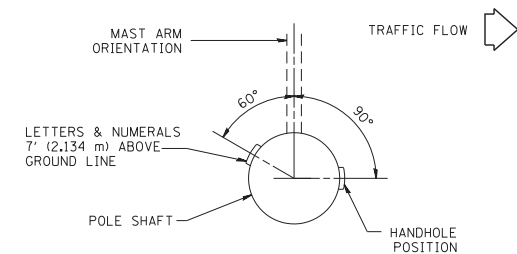

POSITION OF HANDHOLE AND POLE NUMBER FOR SINGLE MAST ARM POLES

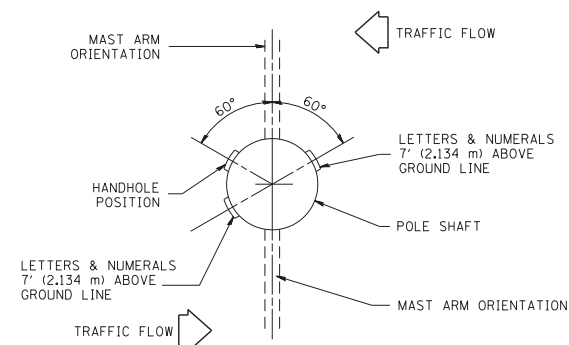

POSITION OF HANDHOLE AND POLE NUMBER FOR TWIN MAST ARM POLES

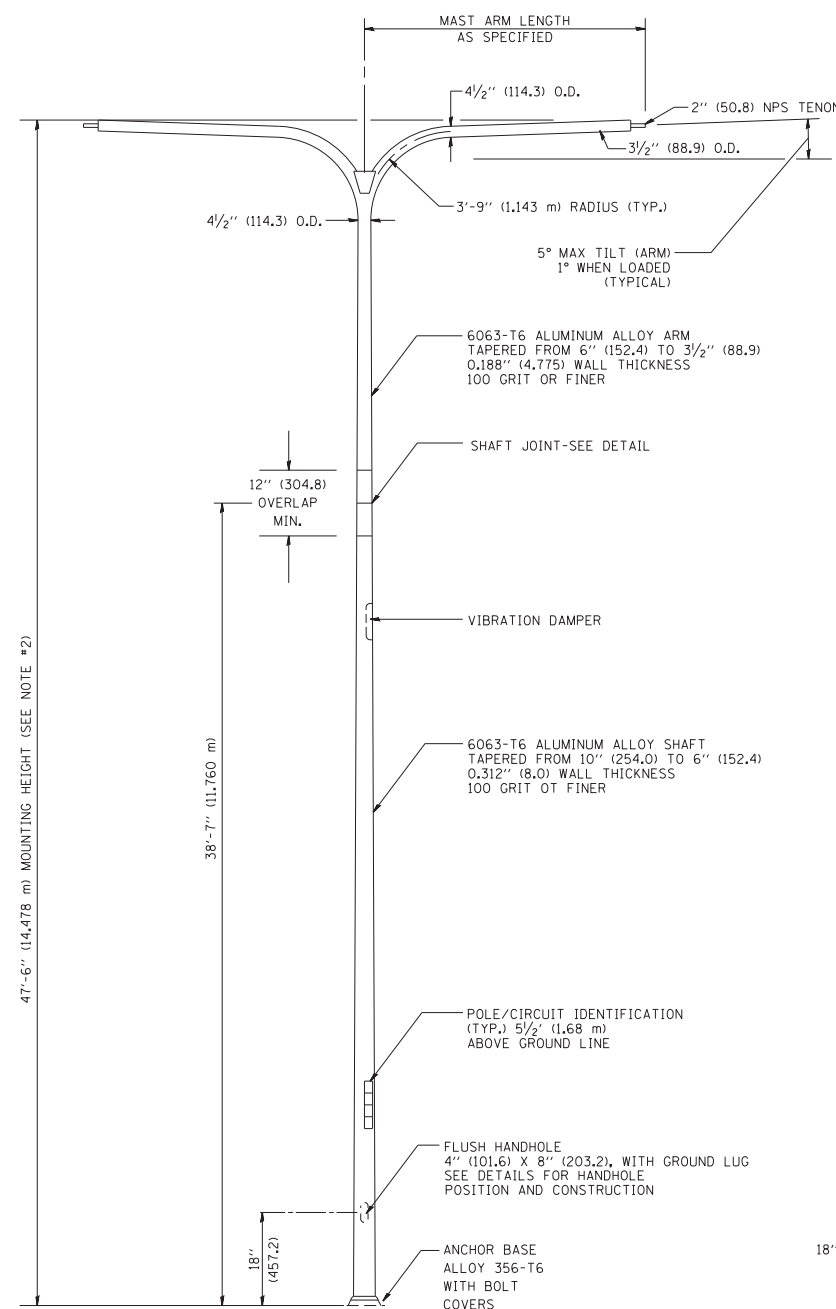

TWIN ARM POLE

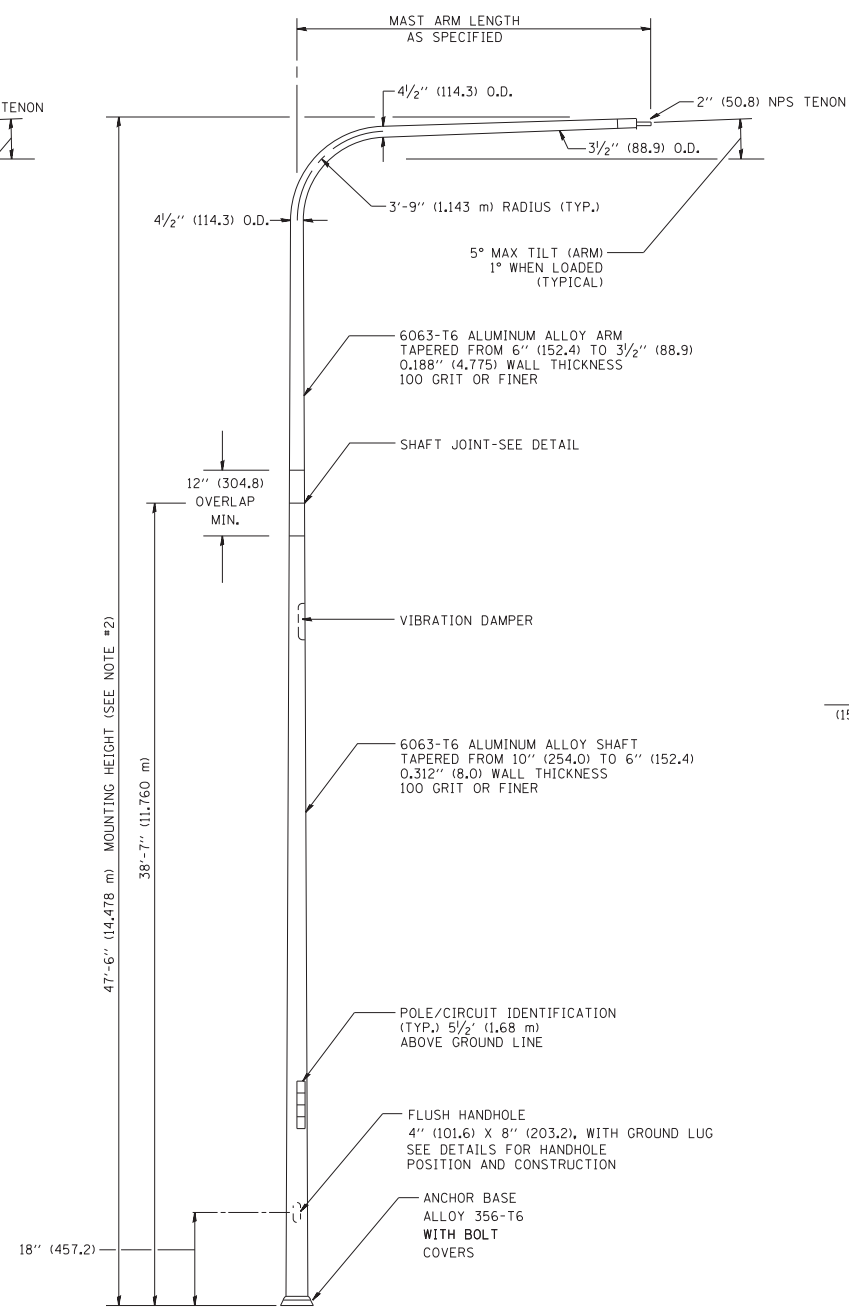

SINGLE ARM POLE

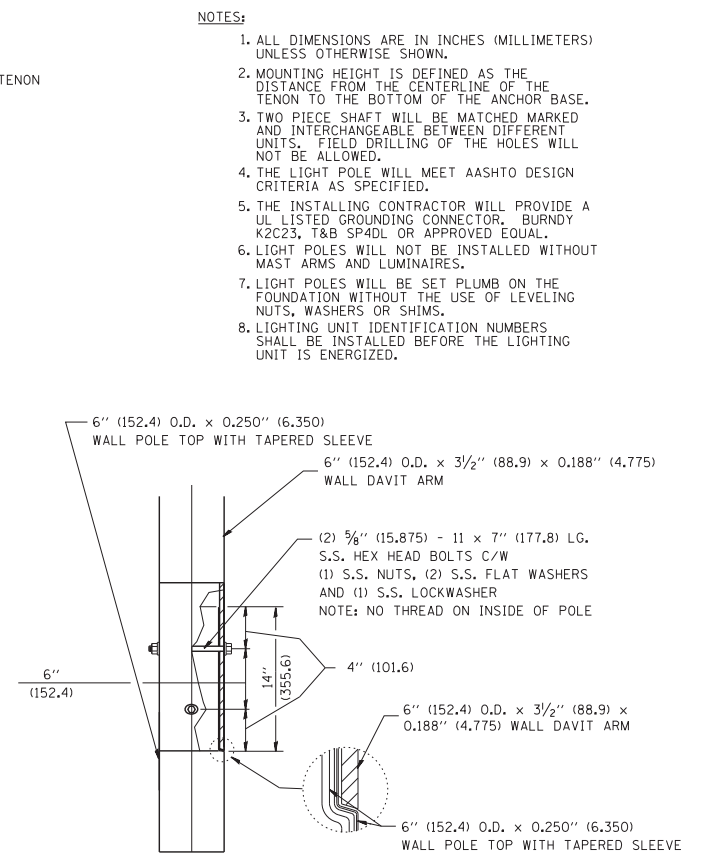

DAVIT ARM CONNECTION
[14" (355.6) OVERLAP SHOWN]

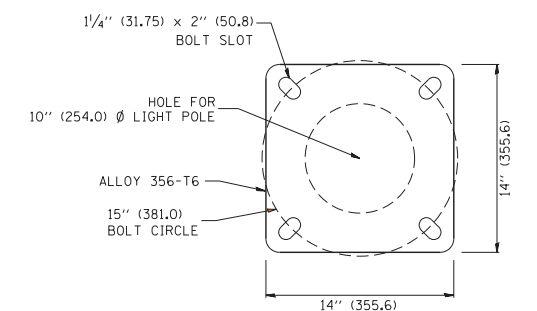

LIGHT POLE BASE PLATE DETAIL
(FOR POLE MOUNTED ON 15 INCH (381.0) BOLT CIRCLE FOUNDATION)

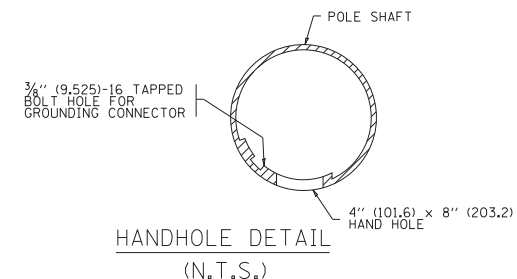

HANDHOLE DETAIL
(N.T.S.)

- NOTES:
- ALL DIMENSIONS ARE IN INCHES (MILLIMETERS) UNLESS OTHERWISE SHOWN.
 - MOUNTING HEIGHT IS DEFINED AS THE DISTANCE FROM THE CENTERLINE OF THE TENON TO THE BOTTOM OF THE ANCHOR BASE.
 - TWO PIECE SHAFT WILL BE MATCHED MARKED AND INTERCHANGEABLE BETWEEN DIFFERENT UNITS. FIELD DRILLING OF THE HOLES WILL NOT BE ALLOWED.
 - THE LIGHT POLE WILL MEET AASHTO DESIGN CRITERIA AS SPECIFIED.
 - THE INSTALLING CONTRACTOR WILL PROVIDE A UL LISTED GROUNDING CONNECTOR, BURNDY K2C23, T&B SP4DL OR APPROVED EQUAL.
 - LIGHT POLES WILL NOT BE INSTALLED WITHOUT MAST ARMS AND LUMINAIRES.
 - LIGHT POLES WILL BE SET PLUMB ON THE FOUNDATION WITHOUT THE USE OF LEVELING NUTS, WASHERS OR SHIMS.
 - LIGHTING UNIT IDENTIFICATION NUMBERS SHALL BE INSTALLED BEFORE THE LIGHTING UNIT IS ENERGIZED.

FILE NAME =	USER NAME = lveys	DESIGNED -	REVISED - D. DREW 05-07-92
ct:\pw_work\pwidot\veys\0108315\be410.dgn		DRAWN - LEY	REVISED - R. TOMSONS 09-06-00
	PLOT SCALE = 50.0000' / in.	CHECKED -	REVISED - R. TOMSONS 09-02-03
	PLOT DATE = 4/4/2013	DATE -	REVISED - R. TOMSONS 01-18-13

STATE OF ILLINOIS
DEPARTMENT OF TRANSPORTATION

DAVIT LIGHT POLE			
47'-6" (14.478 m) MOUNTING HEIGHT			
SCALE: NONE	SHEET NO. 1 OF 1 SHEETS	STA.	TO STA.

F.A.P. RTE.	SECTION	COUNTY	TOTAL SHEETS	SHEET NO.
345	106-S-N-1	KANE	167	131
BE-410		CONTRACT NO. 60T10		
FED. ROAD DIST. NO. 1 ILLINOIS FED. AID PROJECT				