

CONSTRUCTION PLANS

REHABILITATE RUNWAY 1-19

KEWANEE AIRPORT AUTHORITY
KEWANEE MUNICIPAL AIRPORT (EZI)
KEWANEE, HENRY COUNTY, ILLINOIS

SBG PROJECT NO. 3-17-SBGP-TBD
IDA PROJECT NO. EZI-4673

JUNE 8, 2018

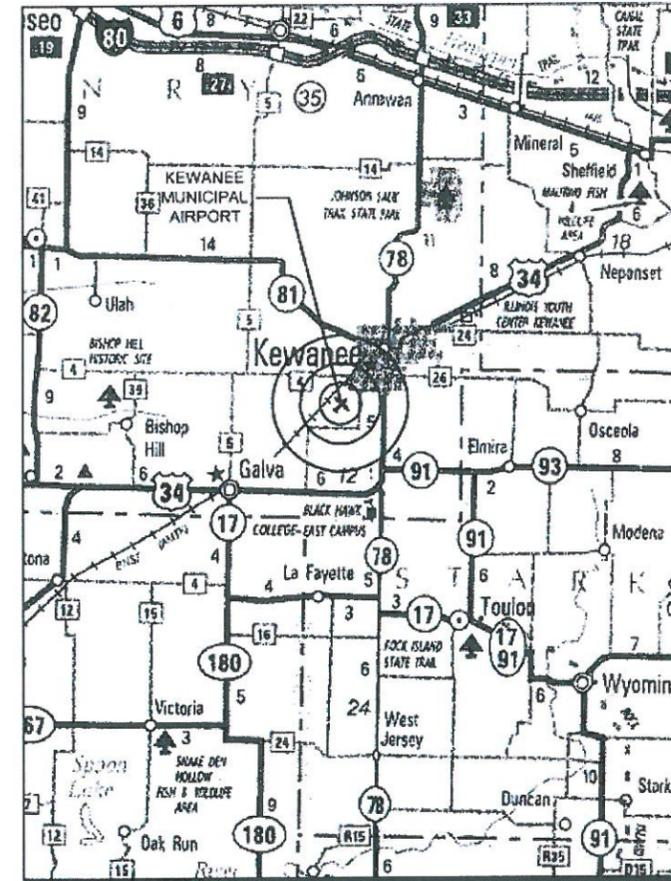

VICINITY MAP

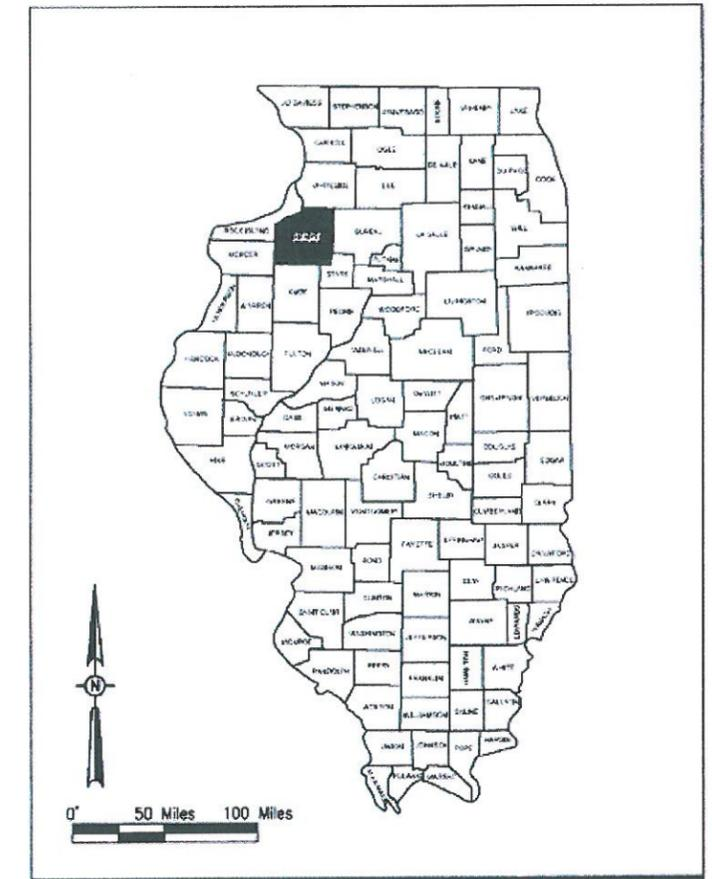

LOCATION MAP

NOTICE TO CONTRACTORS AND BIDDERS

THESE CONSTRUCTION PLANS RELY UPON THE SPECIAL PROVISIONS AND THE SPECIFICATIONS TO PROVIDE FOR A COMPLETE DESCRIPTION OF THE WORK AND CONSTRUCTION REQUIREMENTS. THE PLANS SHALL ONLY BE USED IN COMBINATION WITH ALL CONTRACT DOCUMENTS.

No.	Issue/Description	Sheets Changed	Date	By

Exp
11/30/19

Lindsay Hausman

Lindsay D. Hausman, P.E.
Project Engineer

8 JUNE 2018
Date

HANSON
HANSON PROFESSIONAL SERVICES INC.
1525 S. Sixth St.
Springfield, Illinois 62703
Telephones: 217.788.2450
Fax: 217.788.2503

Robert A. Waller

Robert A. Waller, P.E.
Project Manager

8 JUNE 2018
Date

KEWANEE MUNICIPAL AIRPORT
3769 Midland Road
Kewanee, Illinois 61443
Telephone: 309.853.8222

Ross Carbiener

Ross Carbiener/Diane Carbiener
Airport Manager

8 JUNE 2018
Date

GENERAL NOTES

PROJECT DESCRIPTION

THIS PROJECT IS TO REHABILITATE RUNWAY 1-19 AT KEWANEE MUNICIPAL AIRPORT INCLUDING, AMONG OTHER INCIDENTAL WORK, THE FOLLOWING ITEMS:

- PLACEMENT OF TEMPORARY SOIL EROSION CONTROL MEASURES.
- MILLING OF EXISTING PAVEMENTS.
- CRACK REPAIR OF EXISTING PAVEMENTS.
- INSTALLATION OF CRACK CONTROL FABRIC.
- PLACEMENT OF BITUMINOUS OVERLAY.
- PLACEMENT OF PAVEMENT MARKINGS.
- TOPSOILING, SEEDING AND MULCHING IN ALL DISTURBED AREAS, INCLUDING ALONG NEW PAVEMENT EDGES.

PROTECTION OF EXISTING AIRPORT FACILITIES

THE CONTRACTOR IS TO BE RESPONSIBLE FOR THE PROTECTION OF EXISTING UNDERGROUND AND OVERHEAD UTILITIES AND LIGHTING EQUIPMENT; DRIVEWAY AND ROAD PAVEMENT AND SHOULDERS; RUNWAY, TAXIWAY AND APRON PAVEMENTS AND SHOULDERS; RUNWAY, TAXIWAY AND AIRPORT LIGHTING EQUIPMENT; AND SEEDED AND TURFED AREAS THAT ARE UTILIZED IN OR AFFECTED BY THE CONTRACTOR'S ACTIVITIES. ITEMS DAMAGED BY THE CONTRACTOR ARE TO BE REPAIRED AT CONTRACTOR'S EXPENSE AND TO THE SATISFACTION OF AIRPORT MANAGER AND THE OWNER'S REPRESENTATIVE.

IN ADDITION, WHEN CONDITIONS DICTATE OR AS DETERMINED BY THE AIRPORT MANAGER OR THE OWNER'S REPRESENTATIVE, THE CONTRACTOR SHALL BE REQUIRED TO USE A PICK-UP TYPE SWEEPER IN ALL ACTIVE CONSTRUCTION AIRFIELD PAVEMENT AREAS. THE CONTRACTOR WILL BE REQUIRED TO HAVE A SWEEPER AVAILABLE FOR USE AT ALL TIMES. THE COST OF SWEEPING SHALL BE CONSIDERED INCIDENTAL TO THE CONTRACT.

CONTRACTOR'S ACCESS AND TEMPORARY FACILITIES

CONTRACTOR'S ACCESS TO THE PROJECT WHEN ON AIRPORT PROPERTY IS SHOWN ON SHEET 3. CONTRACTOR'S ACCESS TO THE AIRPORT ITSELF IS TO BE PROVIDED BY PUBLIC RIGHTS-OF-WAY. THE CONTRACTOR IS TO SECURE ALL NECESSARY PERMITS FOR THE USE OF ANY PUBLIC RIGHTS-OF-WAY AND IS TO MAINTAIN TRAFFIC ON THESE PUBLIC ROADS AT ALL TIMES, WITH THE COSTS OF PERMITTING, CLEANING AND REPAIRING OF PAVEMENT DAMAGED BY CONTRACTOR'S ACTIVITIES INCIDENTAL TO THE CONTRACT. USE OF AND REPAIRS TO ANY PUBLIC FACILITIES ARE TO BE COMPLETED TO THE SATISFACTION OF THE FACILITY'S OWNER.

THE CONTRACTOR IS TO PROVIDE TEMPORARY CONSTRUCTION ROADS WITHIN THE CONSTRUCTION LIMIT LINES AS MAY BE REQUIRED BY HIS ACTIVITIES. HEAVY VEHICLES SHALL NOT CROSS EXISTING PAVEMENT SURFACES EXCEPT AS APPROVED BY THE AIRPORT MANAGER AND THE OWNER'S REPRESENTATIVE. ANY DAMAGE TO PAVEMENTS THAT MAY OCCUR BY THE CONTRACTOR'S ACTIVITIES SHALL BE REPAIRED AT THE CONTRACTOR'S EXPENSE AND TO THE SATISFACTION OF THE AIRPORT MANAGER AND THE OWNER'S REPRESENTATIVE. FOR HAUL ROUTES MADE BY THE CONTRACTOR THROUGH GRASSED AREAS, CONTRACTOR SHALL GRADE, LEVEL, TOPSOIL, SEED AND MULCH AT THE END OF THE PROJECT, COST INCIDENTAL TO THE CONTRACT.

THE CONTRACTOR IS TO PROVIDE AN EQUIPMENT STORAGE AND PARKING AREA AT THE LOCATIONS SHOWN ON SHEET 3. IT IS THE CONTRACTOR'S RESPONSIBILITY TO MAINTAIN THE ACCESS ROADS AND THE STORAGE AREA DURING CONSTRUCTION AND TO RESTORE THE AREAS AT PROJECT COMPLETION TO CONDITIONS SUITABLE TO THE AIRPORT MANAGER AND THE OWNER'S REPRESENTATIVE. AT THE AIRPORT MANAGER'S DISCRETION, THE TEMPORARY FACILITIES MAY REMAIN, BUT THEY MUST BE LEFT IN CONDITIONS SUITABLE TO THE AIRPORT MANAGER. THE COST OF PROVIDING, MAINTAINING AND RESTORING THE TEMPORARY FACILITIES IS INCIDENTAL TO THE CONTRACT.

RESPONSIBILITY FOR EXISTING UTILITIES

THE LOCATION, SIZE AND/OR TYPE OF MATERIAL OF EXISTING UNDERGROUND OR OVERHEAD UTILITIES AS MAY BE INDICATED ON THESE CONSTRUCTION PLANS IS NOT REPRESENTED AS BEING ACCURATE, SUFFICIENT OR COMPLETE. NEITHER THE OWNER NOR THE PROJECT ENGINEER HAVE INDEPENDENTLY VERIFIED THIS INFORMATION AND NEITHER ASSUMES ANY RESPONSIBILITY WHATSOEVER IN RESPECT TO THE ACCURACY, SUFFICIENCY OR COMPLETENESS OF THE INFORMATION AND GIVE NO EXPRESSED OR IMPLIED GUARANTEE THAT ANY CONDITIONS INDICATED ARE REPRESENTATIVE OF ACTUAL CONDITIONS TO BE ENCOUNTERED.

IT SHALL BE THE CONTRACTOR'S RESPONSIBILITY TO DETERMINE THE ACTUAL LOCATION OF ALL SUCH FACILITIES, INCLUDING SERVICE CONNECTIONS TO UNDERGROUND UTILITIES. PRIOR TO CONSTRUCTION, THE CONTRACTOR SHALL NOTIFY ALL UTILITY COMPANIES AND AGENCIES OF HIS CONSTRUCTION PLANS AND SHALL OBTAIN FROM EACH PARTY DETAILED INFORMATION AND ASSISTANCE RELATIVE TO THE LOCATION OF ALL UTILITIES AND THE WORKING SCHEDULE OF ANY REMOVALS OR ADJUSTMENTS REQUIRED OF THE UTILITY. THE CONTRACTOR SHALL CONTACT J.U.L.I.E. (PHONE 800-892-0123) TO ASSIST IN THE ABOVE.

THE CONTRACTOR SHALL PROTECT ANY FACILITIES TO THE SATISFACTION OF THE UTILITY OR OWNING-AGENCY WITH THE COST OF ANY REQUIRED PROTECTION TO BE INCIDENTAL TO THE CONTRACT. IN THE EVENT A UTILITY LINE OR SERVICE IS UNEXPECTEDLY ENCOUNTERED DURING CONSTRUCTION, THE CONTRACTOR SHALL IMMEDIATELY NOTIFY THE OWNER'S REPRESENTATIVE AND THE UTILITY COMPANY OR AGENCY OF JURISDICTION. ANY SUCH UTILITIES DISTURBED BY THE CONTRACTOR'S OPERATIONS SHALL BE RESTORED TO SERVICE AT ONCE.

EXISTING BENCHMARKS

PROJECT BENCHMARKS ARE AS FOLLOWS:

"KEWPORT" NGS MONUMENT N 1,652,431.74
E 2,352,728.14
ELEV. 854.2

"KEWPORT AZ MK" NGS MONUMNT N 1,652,491.68
E 2,349,792.88
ELEV. 850.6



PROJECT IS LOCATED IN NORTHWEST 1/4 OF SECTION 17, WETHERSFIELD TOWNSHIP, HENRY COUNTY

NOTES

1. VERTICAL COORDINATES ARE IN NGVD 29. HORIZONTAL COORDINATES ARE IN STATE PLANE NAD 83 ILLINOIS WEST.
2. STATIONS, OFFSETS AND ELEVATIONS SHOWN ARE IN FEET.
3. THE APPROACH END OF RUNWAY 1 IS STATION 55+00.
4. THE AIRPORT REFERENCE CODE FOR RUNWAY 9-27 IS B-II. RUNWAY 9 HAS A NON-PRECISION APPROACH WITH VISIBILITY MINIMUM OF 1 MILE WHILE RUNWAY 27 HAS A VISUAL APPROACH.
5. THE AIRPORT REFERENCE CODE FOR RUNWAY 1-19 IS B-I. RUNWAY 1 HAS A NON-PRECISION APPROACH WITH VISIBILITY MINIMUM OF 1 MILE WHILE RUNWAY 19 HAS A VISUAL APPROACH.

RUNWAY END COORDINATES

DESCRIPTION	LATITUDE	LONGITUDE	RUNWAY STATION	RUNWAY ELEVATION
RUNWAY 9 END	41°12'14.7602" N	89°58'25.7181" W	218+00	853.7
RUNWAY 27 END	41°12'13.9076" N	89°57'26.8606" W	263+00	856.3
RUNWAY 1 END	41°12'09.3902" N	89°57'45.1290" W	55+00	855.2
RUNWAY 19 END	41°12'40.3903" N	89°57'36.8856" W	87+00	837.5

OBJECT INFORMATION									
ITEM NO.	DESCRIPTION	MOBILITY	GROUND ELEVATION	OBJECT ELEVATION	LATITUDE	LONGITUDE	RUNWAY 9-27 STATION	RUNWAY 9-27 OFFSET	RUNWAY 9-27 EXIST EL.
1	CONSTRUCTION EQUIPMENT	MOVING	854.6	874.6	41° 12' 12.1652" N	89° 57' 43.3235" W	250+44.85	200.00	857.3
2	CONSTRUCTION EQUIPMENT	MOVING	854.6	874.6	41° 12' 16.1032" N	89° 57' 42.2739" W	251+17.41	200.00	857.5
3	BARRICADES	STATIONARY	850.8	859.0	41° 12' 16.0363" N	89° 57' 37.2744" W	232+74.37	200.00	853.8
4	BARRICADES	STATIONARY	855.2	863.4	41° 12' 12.5010" N	89° 58' 06.4824" W	254+99.60	200.00	858.2



Offices Nationwide
www.hanson-inc.com

Hanson Professional Services Inc.
1525 S. 6th Street
Springfield, IL 62568
phone: 217-788-2450
fax: 217-788-2503

Illinois Licensed
Professional Service Corporation
#184-001084



KEWANEE MUNICIPAL AIRPORT
3769 Midland Road
Kewanee, Illinois 61443
Telephone: 309.853.8222

REHABILITATE RUNWAY 1-19

IDA No: EZI-4673
SBGP No: 3-17-SBGP-TBD

Contract No.: KE016

NO.	DATE	DESCRIPTION		
		LAY	DWN	REV

ISSUE: JUNE 8, 2018
PROJECT NO: 18A0008
CAD FILE: 04-GENEALNOTES.DWG
LAYOUT BY: LDH 2/26/18
DRAWN BY: LDH 2/26/18
REVIEWED BY: KMS 4/30/18

© Copyright Hanson Professional Services Inc. 2013

SHEET TITLE

SITE & SAFETY PLAN NOTES

CONSTRUCTION AND SAFETY NOTES

SAFETY IS REQUIRED

CONSTRUCTION OF THE PROJECT SHALL BE PERFORMED BY THE CONTRACTOR IN ACCORDANCE WITH THE GUIDELINES SPECIFIED IN FAA ADVISORY CIRCULAR 150/5320-2 (CURRENT ISSUE) AND THE AIRPORT RULES AND REGULATIONS. ANY CONTRACTOR ACTIVITIES REQUIRED FOR PROJECT SAFETY SHALL BE PROVIDED BY THE CONTRACTOR AND BE INCIDENTAL TO THE CONTRACT.

SEQUENCE OF CONSTRUCTION

TO MINIMIZE DISRUPTIONS OF AIRPORT OPERATIONS, CONSTRUCTION OPERATIONS MUST BE CONTROLLED THROUGHOUT THE PROJECT'S DURATION, AND WORK MUST BE COMPLETED EXPEDITIOUSLY. A CONSTRUCTION PHASING PLAN DETAILING THE SEQUENCING OF THE CONTRACTOR'S WORK THROUGHOUT THE PROJECT IS INCLUDED IN THE PLANS. THE CONTRACTOR SHALL PROVIDE HIS WRITTEN ACCEPTANCE OF THE PROJECT CONSTRUCTION PHASING PLAN AT THE PRE-CONSTRUCTION CONFERENCE. ANY AND ALL CHANGES TO THE CONSTRUCTION PHASING PLAN THAT MAY BE REQUESTED BY THE CONTRACTOR MUST BE APPROVED BY THE PROJECT ENGINEER AND THE AIRPORT OWNER. IT SHALL BE THE CONTRACTOR'S RESPONSIBILITY TO PROVIDE SUFFICIENT ADVANCE NOTICE OF ANY PROPOSED PHASING CHANGE TO PERMIT CONSIDERATION AND APPROVAL BY THE PROJECT ENGINEER AND THE AIRPORT OWNER. THE CONTRACTOR SHALL NOT BE ENTITLED TO ANY EXTRA COMPENSATION, NOR EXTENSION TO THE CONTRACT TIME, BECAUSE OF A PHASING CHANGE REQUEST NOR FOR ANY TIME NECESSARY IN RECEIVING THE REQUIRED APPROVALS. THE CONTRACTOR SHALL EXPEDITE WORK AT THOSE STAGES WHERE ACTIVE TAXIWAYS, HANGAR ACCESS, APRONS, ROADWAYS OR PARKING LOTS MUST BE CLOSED, TO MINIMIZE THE LENGTH OF TIME THAT AIRPORT OPERATIONS ARE RESTRICTED.

AT THE PRE-CONSTRUCTION CONFERENCE, THE CONTRACTOR SHALL PROVIDE A CONTRACTOR COORDINATION PLAN THAT COORDINATES HIS WORK WITH THE WORK OF HIS SUBCONTRACTORS AND THE WORK OF OTHER CONTRACTORS OF OTHER ON-GOING AIRPORT PROJECTS.

RUNWAY CLOSURE

RUNWAY 1-19 WILL BE CLOSED FOR THE DURATION OF THE PROJECT. TO MINIMIZE DISRUPTION TO AIRCRAFT OPERATIONS ASSOCIATED WITH THE RUNWAY CLOSURE, CONSTRUCTION WORK MUST BE COMPLETED EXPEDITIOUSLY. RUNWAY CLOSINGS SHALL ONLY BE PERMITTED BY PRIOR AUTHORIZATION OF THE RESIDENT ENGINEER AND THE AIRPORT OWNER.

THE CONTRACTOR WILL PROVIDE, INSTALL, MAINTAIN AND REMOVE RUNWAY CLOSURE MARKERS AS DETAILED ON THIS SHEET AND IN THE SPECIAL PROVISIONS. IT WILL BE THE CONTRACTOR'S RESPONSIBILITY TO INSTALL, RELOCATE AND MAINTAIN RUNWAY CLOSURE MARKERS AT THE LOCATIONS SHOWN IN THE PLAN, AND AS DIRECTED BY THE RESIDENT ENGINEER AND AIRPORT OWNER. THE COST OF PLACING AND RELOCATING THESE ITEMS, AND THEIR OPERATION AND MAINTENANCE, IS TO BE PAID UNDER ITEM AR150530 TRAFFIC MAINTENANCE.

THE AIRPORT OWNER WILL DE-ENERGIZE AIRPORT/RUNWAY NAVAIDS, AND AIRFIELD LIGHTING POWER AND CONTROL CIRCUITS WHEN THE RUNWAY IS CLOSED.

TEMPORARY BARRICADES

THE CONTRACTOR SHALL FURNISH BARRICADES FOR ANY AIRFIELD OR ROADWAY PAVEMENT TO BE CLOSED BY HIS WORK. IT WILL BE THE CONTRACTOR'S RESPONSIBILITY TO FURNISH, PLACE AND MAINTAIN BARRICADES AS SHOWN IN DETAIL B, THIS SHEET, AND AS DIRECTED BY THE RESIDENT ENGINEER AND AIRPORT DIRECTOR. THE COST OF THESE ITEMS, AND THEIR MAINTENANCE, IS TO BE PAID FOR UNDER AR150530 TRAFFIC MAINTENANCE. ANY WORK THAT REQUIRES PORTIONS OF AN ACTIVE RUNWAY, TAXIWAY OR APRON TO BE CLOSED MUST BE COMPLETED EXPEDITIOUSLY TO MINIMIZE DISRUPTION TO AIRCRAFT OPERATIONS.

VEHICULAR TRAFFIC CONTROL

THE CONTRACTOR SHALL ERECT AND MAINTAIN, AT NO COST TO THE CONTRACT, DIRECTIONAL AND INFORMATIONAL SIGNS FOR THE CONTRACTOR'S ACCESS ROUTES AT THE EXISTING CONSTRUCTION ENTRANCES AND FOR THE CONTRACTOR'S ROUTE WITHIN THE AIRPORT OPERATIONS AREA, AS NOTED ON THE PLANS OR AS DIRECTED BY THE RESIDENT ENGINEER. WHERE CONTRACTOR EQUIPMENT IS OPERATING WITHIN ACTIVE AIRCRAFT OPERATIONS AREAS, RADIO-EQUIPPED FLAGGERS SHALL BE FURNISHED BY THE CONTRACTOR. CONTINUOUS PAVEMENT SWEEPING SHALL BE FURNISHED TO REMOVE DEBRIS FROM ACTIVE AIRCRAFT MOVEMENT PATHS. THE COST OF TRAFFIC CONTROL/FLAGGERS AND PAVEMENT SWEEPING SHALL BE PAID UNDER ITEM AR150530 TRAFFIC MAINTENANCE.

AIRFIELD OPERATIONAL SAFETY DURING CONSTRUCTION

THE CONTRACTOR SHALL NOT HAVE ACCESS TO ANY PART OF THE ACTIVE AIRFIELD (RUNWAYS, TAXIWAYS OR APRONS) FOR ANY EQUIPMENT OR PERSONNEL WITHOUT THE APPROVAL OF THE RESIDENT ENGINEER AND THE AIRPORT OWNER. ACTIVITIES WITHIN THE AIRPORT OPERATIONS AREA (AOA) ARE SUBJECT TO FEDERAL ACCESS CONTROL. BECAUSE OF THE HIGH REQUIREMENTS FOR AIRPORT SECURITY AND SAFETY, THE FOLLOWING REQUIREMENTS MUST BE ADHERED TO:

- ALL EMPLOYEES OF THE CONTRACTOR SHALL PARK THEIR PERSONAL VEHICLES IN THE DESIGNATED EQUIPMENT PARKING AND STORAGE AREA. EACH PERSON OR VEHICLE ENTERING THE CONTRACTOR AREA SHALL DO SO IN ACCORDANCE WITH THE POLICIES AND PROCEDURES OF THE AIRPORT OWNER. THE CONTRACTOR WILL TRANSPORT THE WORKERS FROM THE PARKING AREAS TO THE WORK AREA. ONLY CONTRACTOR VEHICLES WILL BE ALLOWED OUTSIDE OF THE PROPOSED EQUIPMENT STORAGE AND PARKING AREAS.
- SHOULD ANY CONTRACTOR PERSONNEL BE IDENTIFIED AS NONCOMPLIANT WITH ANY VEHICLE DRIVING SAFETY REQUIREMENTS IN THIS PROJECT SAFETY PLAN OR IN THE AIRPORT VEHICLE OPERATIONS REGULATIONS, SUCH DRIVERS SHALL BE PENALIZED BY RESCISSION OF THEIR ON-AIRPORT DRIVING PRIVILEGES, AND THEIR ACCESS TO THE CONSTRUCTION LIMIT AREA WHEN OPERATING VEHICLES SHALL BE REVOKED.
- THE CONTRACTOR WILL BE REQUIRED TO BE IN CONTACT WITH AIRPORT OPERATIONS. THIS WILL KEEP THE CONTRACTOR IN CONTACT WITH AIRPORT PERSONNEL AND ENABLE THE AIRPORT PERSONNEL TO IMMEDIATELY CONTACT THE CONTRACTOR IN CASE OF AN AERONAUTICAL EMERGENCY THAT WOULD REQUIRE ACTION BY THE CONTRACTOR AND/OR HIS PERSONNEL.

THE CONTRACTOR SHALL REMAIN WITHIN THE CONSTRUCTION LIMITS LINE SHOWN IN THE PLANS. WHEN OUTSIDE THESE LIMITS, ALL CONTRACTOR ACTIVITIES SHALL REMAIN MORE THAN 250 FEET FROM THE CENTERLINE AND 300 FEET FROM THE END OF ACTIVE RUNWAY 9-27, AND 200 FEET FROM THE CENTERLINE AND 240 FEET FROM THE END OF ACTIVE RUNWAY 1-19. FOR WORK NEAR TAXIWAYS AND APRONS, THE CONTRACTOR'S PERSONNEL AND EQUIPMENT MUST REMAIN AT LEAST 44.5 FEET FROM CENTERLINE OF ACTIVE CATEGORY I TAXIWAYS, 65.5 FEET FROM ACTIVE CATEGORY II TAXIWAYS, AND TEN (10) FEET FROM ACTIVE APRONS. WHEN CONSTRUCTION OPERATIONS MUST BE CONDUCTED WITHIN THESE SEPARATIONS, THE PAVEMENT MUST BE CLOSED TO AIRCRAFT ACTIVITY BY THE CONTRACTOR BY PROVIDING TEMPORARY BARRICADES AS SHOWN IN THE PLANS, AND IN THE CASE OF RUNWAY PAVEMENTS, CLOSED RUNWAY MARKERS. WHEN HAUL VEHICLES ARE PERMITTED TO CROSS ACTIVE AIRFIELD PAVEMENTS, THE CONTRACTOR WILL PROVIDE POSITIVE CONTROL OF CONSTRUCTION VEHICLES USING RADIO-EQUIPPED FLAGGERS. CONTRACTOR SHALL ESTABLISH AND MAINTAIN RADIO CONTACT WITH KEWANEE AIRPORT UNICOM (122.8 MHz). ALL CONTRACTOR'S EQUIPMENT USED IN ACTIVE AIRPORT OPERATIONS AREAS SHALL BE EQUIPPED WITH A FAA-STANDARD FLAG, AS REFERENCED IN FAA AC 150/5370-2, CURRENT ISSUE. AIRCRAFT SHALL HAVE THE RIGHT-OF-WAY.

NO CLOSURE OF ANY RUNWAY WILL BE PERMITTED FOR THIS PROJECT, EXCEPT AS SHOWN IN THE PHASING PLANS.

THE CONTRACTOR SHALL KEEP ALL OF HIS EQUIPMENT AND PERSONNEL AT LEAST 15 FEET FROM THE EDGE OF ANY ACTIVE ROADWAY OR AUTO PARKING PAVEMENT. WHEN HIS ACTIVITIES REQUIRE WORKING WITHIN 15 FEET OF THE ROAD/PAVEMENT EDGE, THE CONTRACTOR SHALL PROVIDE FOR TRAFFIC CONTROL IN ACCORDANCE WITH IDOT SPECIFICATIONS (HIGHWAY STANDARDS).

OPEN TRENCHES, EXCAVATIONS AND STOCKPILED MATERIAL AT THE CONSTRUCTION SITE SHALL BE DELINEATED WITH THE USE OF BARRICADES DURING HOURS OF RESTRICTED VISIBILITY AND/OR DARKNESS. NO OPEN TRENCHES SHALL BE ALLOWED WITHIN THE RUNWAY SAFETY AREA (RSA) OR THE TAXIWAY SAFETY AREA (TSA) WHEN THE RUNWAY OR TAXIWAY IS OPEN TO AIR TRAFFIC (INCLUDING OVERNIGHT). THE RSA IS DEFINED AS 75 FEET FROM THE CENTERLINE AND 300 FEET FROM THE END OF RUNWAY 9-27, AND 60 FEET FROM THE CENTERLINE AND 240 FEET FROM THE END OF RUNWAY 1-19. THE TSA IS MEASURED AT 24.5 FEET FROM THE CATEGORY I TAXIWAY CENTERLINE, AND 39.5 FEET FROM THE CATEGORY II TAXIWAY CENTERLINE, AND 59 FEET FROM THE CATEGORY III TAXIWAY CENTERLINE. NO VERTICAL DROP OF GREATER THAN 3-INCHES IN HEIGHT FROM PAVEMENT EDGE TO EARTH GRADE OR EARTH GRADE TO EARTH GRADE WITHIN THE RSA OR TSA WILL BE PERMITTED WHEN THE RUNWAY OR TAXIWAY IS OPEN TO AIR TRAFFIC. THE CONTRACTOR WILL HAVE STEEL PLATES ON-SITE TO ALLOW FOR THE RAPID COVERING OF TRENCHES OR EARTH DROPS IN THE EVENT OF UNEXPECTED WORK STOPPAGES FOR WEATHER OR AIRPORT EMERGENCIES.

WHEN NOT IN USE AND DURING NONWORKING HOURS, CONTRACTOR'S EQUIPMENT SHALL BE PARKED WITHIN THE CONTRACTOR'S EQUIPMENT STORAGE AND PARKING AREAS. THE EQUIPMENT STORAGE AND PARKING AREAS ARE TO BE LOCATED AS SHOWN ON THE PHASING PLAN. THE CONTRACTOR WILL BE RESPONSIBLE FOR MAINTAINING THE CONSTRUCTION ENTRANCES IN GOOD CONDITION. THE COST OF MAINTAINING THE CONSTRUCTION ENTRANCE AND CONTRACTOR AREAS IS TO BE INCIDENTAL TO THE CONTRACT. THE CONTRACTOR SHALL PROTECT ALL EXISTING PAVEMENT EDGES FROM DAMAGE FROM CONSTRUCTION EQUIPMENT AND HAUL VEHICLES.

AT NO TIME SHALL THE CONTRACTOR CONDUCT ANY ACTIVITIES OR OPERATE OR PARK EQUIPMENT SO AS TO OBSTRUCT ACTIVE PART 77 AIRPORT IMAGINARY SURFACES OR THE RUNWAY PROTECTION ZONES (RPZ) AS DELINEATED IN THE PLANS. CONTRACTOR'S EQUIPMENT SHALL EXTEND NO HIGHER THAN 20 FEET. CRANES SHALL NOT BE USED DURING INSTRUMENT WEATHER CONDITIONS OR AT NIGHT. CRANES SHALL BE LOWERED WHEN NOT IN USE.

BEFORE REOPENING TEMPORARILY CLOSED PAVEMENTS, THE CONTRACTOR SHALL INSPECT AND CLEAN, AS NECESSARY, THE PAVEMENT TO ASSURE THAT NO MATERIALS OR OBJECTS THAT MAY DAMAGE AIRCRAFT OR VEHICLES REMAIN. ANY REQUIRED CLEANING SHALL BE TO THE SATISFACTION OF THE RESIDENT ENGINEER AND AIRPORT OWNER AND IS INCIDENTAL TO THE CONTRACT.

ALL WORK SHALL BE COMPLETED IN ACCORDANCE WITH THE APPROVED PROJECT SAFETY PLAN, ISSUED BY THE ILLINOIS DIVISION OF AERONAUTICS.

FAILURE TO USE THESE PRESCRIBED PROCEDURES OR ADHERE TO THE SAFETY REQUIREMENTS WILL RESULT IN THE SUSPENSION OF WORK.

NOTIFICATIONS BY CONTRACTOR

THE CONTRACTOR MUST NOTIFY THE RESIDENT ENGINEER AND THE AIRPORT OWNER 3 DAYS IN ADVANCE OF ANY REQUIRED PARTIAL OR COMPLETE CLOSING OF ANY RUNWAY, TAXIWAY OR APRON. THE DATE, TIME AND SCHEDULED DURATION OF THE CLOSING MUST BE APPROVED BY THE RESIDENT ENGINEER AND THE AIRPORT OWNER. THE CONTRACTOR SHALL NOTIFY THE RESIDENT ENGINEER AND AIRPORT OWNER 3 DAYS IN ADVANCE OF THE CONTRACTOR'S CLOSING OF OTHER ACTIVE ROADWAYS, AIRFIELD OR ROADWAY LIGHTING CIRCUITS, OR OTHER AIRPORT FACILITIES.

CONTRACTOR'S USE OF SITE

CONTRACTOR'S ACCESS TO THE PROJECT WHEN ON AIRPORT PROPERTY IS SHOWN IN THE PLANS. CONTRACTOR'S ACCESS TO THE AIRPORT ITSELF IS TO BE PROVIDED BY PUBLIC RIGHTS-OF-WAY. THE CONTRACTOR IS TO SECURE ALL NECESSARY PERMITS FOR THE USE OF ANY PUBLIC RIGHTS-OF-WAY AND IS TO MAINTAIN TRAFFIC ON THESE PUBLIC ROADS AT ALL TIMES, WITH THE COSTS OF PERMITTING, CLEANING AND REPAIRING OF PAVEMENT DAMAGED BY CONTRACTOR'S ACTIVITIES INCIDENTAL TO THE CONTRACT. USE OF AND REPAIRS TO ANY PUBLIC FACILITIES ARE TO BE COMPLETED TO THE SATISFACTION OF THE FACILITY'S OWNER.

THE CONTRACTOR IS TO PROVIDE TEMPORARY CONSTRUCTION ROADS WITHIN THE CONSTRUCTION LIMIT LINES AS MAY BE REQUIRED BY HIS ACTIVITIES. HEAVY VEHICLES SHALL NOT CROSS EXISTING PAVEMENT SURFACES EXCEPT AS APPROVED BY THE AIRPORT OWNER AND THE RESIDENT ENGINEER. ANY DAMAGE TO PAVEMENTS THAT MAY OCCUR BY THE CONTRACTOR'S ACTIVITIES SHALL BE REPAIRED AT THE CONTRACTOR'S EXPENSE AND TO THE SATISFACTION OF THE AIRPORT OWNER AND THE RESIDENT ENGINEER. FOR HAUL ROUTES MADE BY CONTRACTOR THROUGH GRASSED AREAS, CONTRACTOR SHALL GRADE, LEVEL, TOPSOIL, SEED AND MULCH AT THE END OF THE PROJECT, COST INCIDENTAL TO THE CONTRACT.

THE CONTRACTOR IS TO PROVIDE AN EQUIPMENT STORAGE AND PARKING AREA AT THE LOCATIONS SHOWN IN THE PLANS. IT IS THE CONTRACTOR'S RESPONSIBILITY TO MAINTAIN THE ACCESS ROADS AND THE STORAGE AREA DURING CONSTRUCTION AND TO RESTORE THE AREAS AT PROJECT COMPLETION TO CONDITIONS SUITABLE TO THE AIRPORT OWNER AND THE RESIDENT ENGINEER. AT THE AIRPORT OWNER'S DISCRETION, THE TEMPORARY FACILITIES MAY REMAIN, BUT THEY MUST BE LEFT IN CONDITIONS SUITABLE TO THE AIRPORT OWNER. THE COST OF PROVIDING, MAINTAINING AND RESTORING THE TEMPORARY FACILITIES IS INCIDENTAL TO THE CONTRACT.

UTILITY OUTAGES AND SHUTDOWNS

THE CONTRACTOR SHALL PROVIDE 3 DAYS PRIOR NOTICE OF ANY OUTAGES OR SHUTDOWNS TO THE OWNER AND THE AGENCY OWNING THE AFFECTED UTILITY. THE CONTRACTOR SHALL PROVIDE ANY TEMPORARY CONNECTIONS OR OTHER MEASURES AS MAY BE REQUIRED TO MAINTAIN SERVICE AS MAY BE REQUIRED BY THE OWNING AGENCY AT NO COST TO THE OWNER.

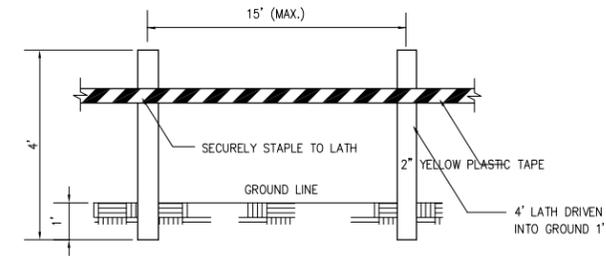

MATERIALS ARE TO BE APPROVED BY ENGINEER PRIOR TO INSTALLATION. COST OF MATERIALS, INSTALLATION, RELOCATION AND MAINTENANCE OF LATHING AND WARNING TAPE IS TO BE INCIDENTAL TO THE CONTRACT.

**DETAIL A
LATHING AND WARNING TAPE**

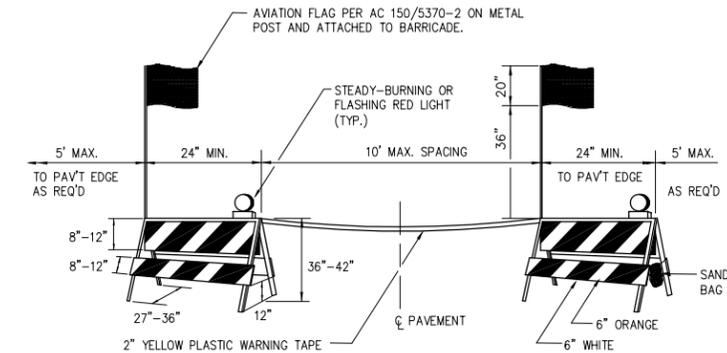

BARRICADES ARE TO BE OF IDOT TYPE II. A STEADY-BURNING OR FLASHING RED LIGHT FACING PASSING TRAFFIC IS TO BE MOUNTED ABOVE THE TOP OF EACH BARRICADE FRAME. THE BARRICADE IS TO BE STABILIZED FROM WIND BY SANDBAGS PLACED ON THE FRAME OR OTHER METHODS APPROVED BY THE RESIDENT ENGINEER. NO PART OF THE REFLECTORIZED PORTION OF THE BARRICADE IS TO BE OBSTRUCTED IN ANY MANNER. COST OF FURNISHING, INSTALLING, RELOCATING, MAINTAINING AND REMOVING BARRICADES IS TO BE PAID FOR UNDER ITEM AR150530 TRAFFIC MAINTENANCE.

**DETAIL B
STANDARD PAVEMENT BARRICADES**

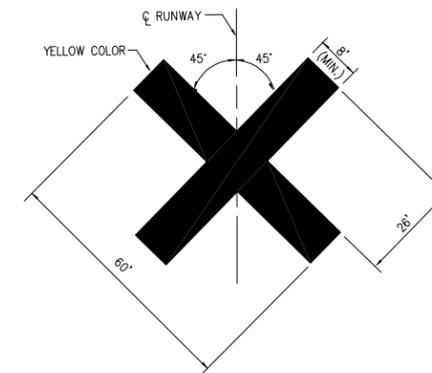

NOTES

- VINYL MARKERS SHALL BE FURNISHED BY THE CONTRACTOR. THE CONTRACTOR SHALL FURNISH ALL LABOR AND MATERIALS FOR INSTALLING, RELOCATING AND MAINTAINING THE MARKERS, WHOSE COST SHALL BE INCIDENTAL TO THE CONTRACT.
- CONTRACTOR SHALL LOCATE THE MARKERS ON TOP OF THE RUNWAY NUMERALS DURING CLOSURE OF THE RUNWAY.
- MARKERS TO BE SECURED BY CONTRACTOR AS RECOMMENDED BY THE MANUFACTURER.

**DETAIL C
RUNWAY CLOSURE MARKERS**

DETAILS SHOWN ARE NOT TO SCALE

**REHABILITATE RUNWAY
1-19**

IDA No: EZI-4673
SBGP No: 3-17-SBGP-TBD

Contract No.: KE016

NO.	DATE	DESCRIPTION		
		LAY	DWN	REV

ISSUE: JUNE 8, 2018
PROJECT NO: 18A0008
CAD FILE: 05-SAFETYNOTES.DWG
LAYOUT BY: LDH 2/26/18
DRAWN BY: LDH 2/26/18
REVIEWED BY: KMS 4/30/18
© Copyright Hanson Professional Services Inc. 2013
SHEET TITLE

**CONSTRUCTION
SAFETY NOTES
AND DETAILS**

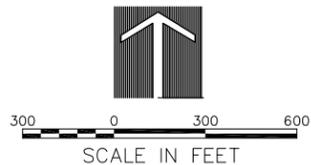

Alignment	Description	Station	Project Coordinates	
			Northing	Easting
Existing Runway 1-19	Beginning of Alignment	50+00	1651557.7440	2352656.8509
	End of Alignment	92+00	1655677.3853	2353474.4817

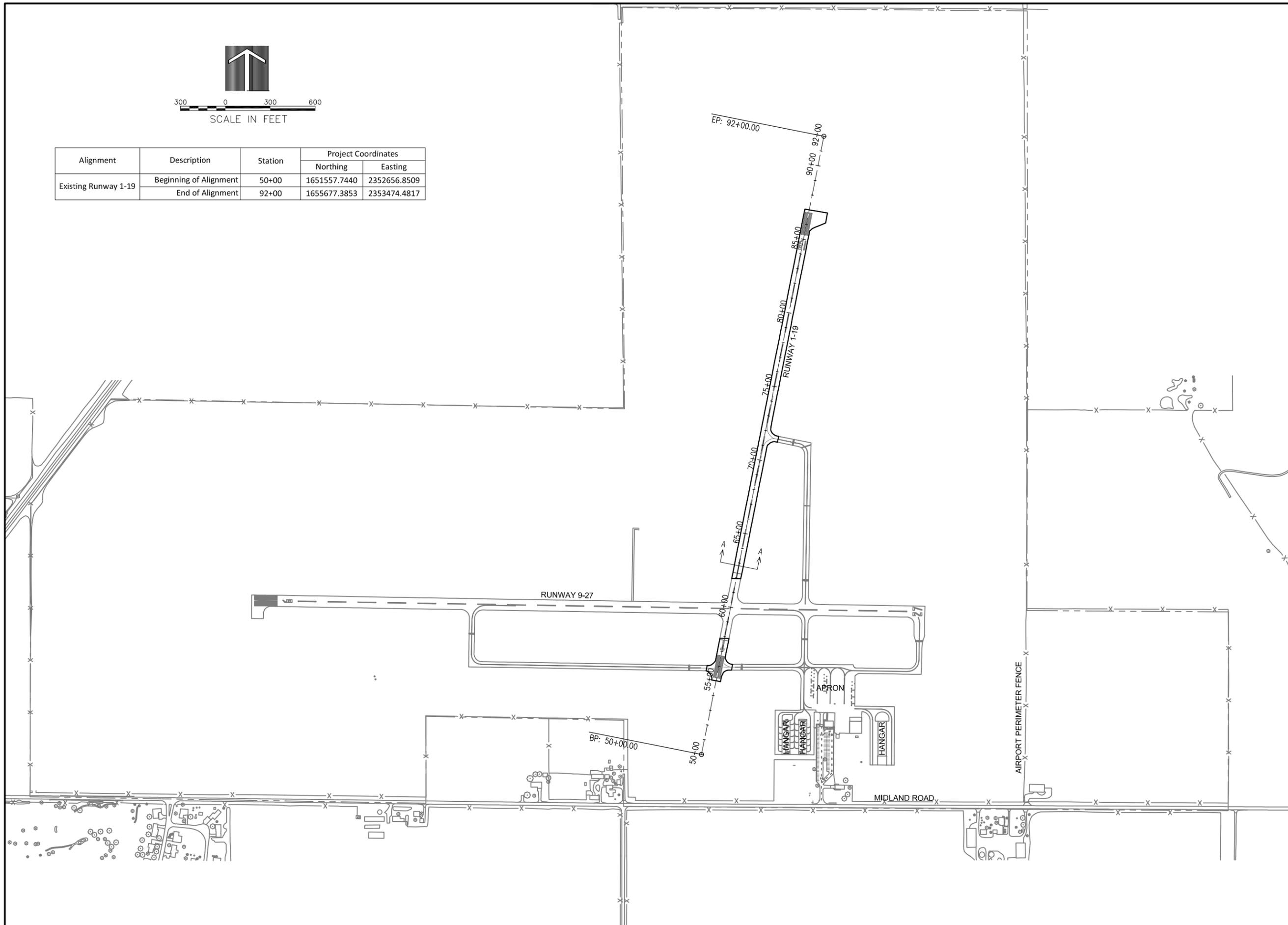

REHABILITATE RUNWAY 1-19

IDA No: EZI-4673
SBGP No: 3-17-SBGP-TBD

Contract No.: KE016

NO.	DATE	DESCRIPTION		
		LAY	DWN	REV

ISSUE: JUNE 8, 2018
PROJECT NO: 18A0008
CAD FILE: 08-ALIGN.DWG
LAYOUT BY: LDH 2/26/18
DRAWN BY: LDH 2/26/18
REVIEWED BY: KMS 4/30/18

© Copyright Hanson Professional Services Inc. 2013
SHEET TITLE

ALIGNMENT DATA TABLE

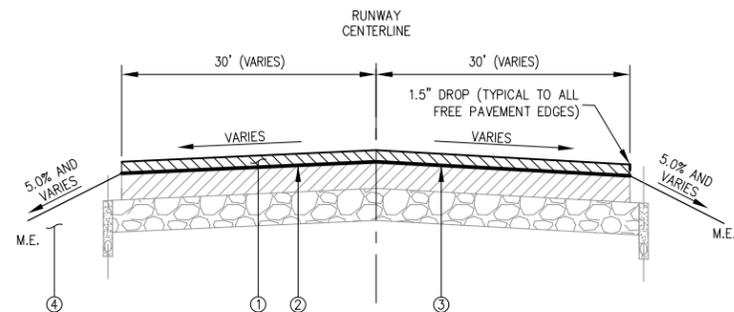

TYPICAL SECTION A-A - RUNWAY 1-19

(SECTION SHOWN LOOKING NORTH)

- ① PROPOSED 2.5 INCH NOMINAL DEPTH MILLING AND 2.5 INCH BITUMINOUS SURFACE COURSE, ITEM AR401650 AND AR401614
- ② PROPOSED BITUMINOUS TACK COAT, ITEM AR603510
- ③ PROPOSED CRACK CONTROL FABRIC, ITEM AR201670
- ④ PROPOSED 4 INCH TOPSOIL, ITEM AR905510

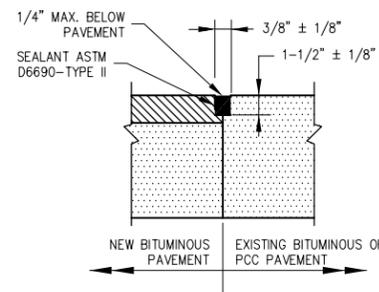

NOTE:
ALL BITUMINOUS/BITUMINOUS JOINT SEALING TO BE PAID UNDER SAW AND SEAL BITUMINOUS JOINTS, ITEM AR401660.

BITUMINOUS/BITUMINOUS SEAL

REHABILITATE RUNWAY 1-19

IDA No: EZI-4673
SBGP No: 3-17-SBGP-TBD

Contract No.: KE016

NO.	DATE	DESCRIPTION		
		LAY	DWN	REV

ISSUE: JUNE 8, 2018
PROJECT NO: 18A0008
CAD FILE: 09-TYP.DWG
LAYOUT BY: LDH 2/26/18
DRAWN BY: LDH 2/26/18
REVIEWED BY: KMS 4/30/18

© Copyright Hanson Professional Services Inc. 2013
SHEET TITLE

TYPICAL SECTION AND PAVEMENT DETAILS

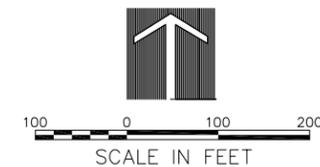

CONTRACTOR'S CERTIFICATION STATEMENT

THIS CERTIFICATION STATEMENT IS A PART OF THE STORM WATER POLLUTION PREVENTION PLAN FOR THE PROJECT DESCRIBED BELOW IN ACCORDANCE WITH NPDES PERMIT NO. ILR10 ISSUED BY THE ILLINOIS ENVIRONMENTAL PROTECTION AGENCY.

PROJECT INFORMATION:

AIRPORT: _____ PROJECT: _____

PROJECT NO: _____ COUNTY: _____

CONTRACT NUMBER: _____

I CERTIFY UNDER PENALTY OF LAW THAT I UNDERSTAND THE TERMS AND CONDITIONS OF THE GENERAL NATIONAL POLLUTION DISCHARGE ELIMINATION SYSTEM (NPDES) PERMIT (ILR10) THAT AUTHORIZES THE STORM WATER DISCHARGES ASSOCIATED WITH INDUSTRIAL ACTIVITY FROM THE CONSTRUCTION SITE IDENTIFIED AS PART OF THIS CERTIFICATION.

SIGNATURE: _____ DATE: _____

PRINTED NAME: _____ TITLE: _____

NAME OF FIRM: _____

STREET ADDRESS: _____

CITY, STATE, ZIP: _____

PHONE NUMBER: _____

THE INFORMATION WITHIN THIS BOX SHALL BE COMPLETED BY THE CONTRACTOR AFTER THE AWARD OF THE CONTRACT TO OBTAIN THE REQUIRED NPDES PERMIT FROM IEPA. COMPLETION OF THIS IS A CONTRACT REQUIREMENT.

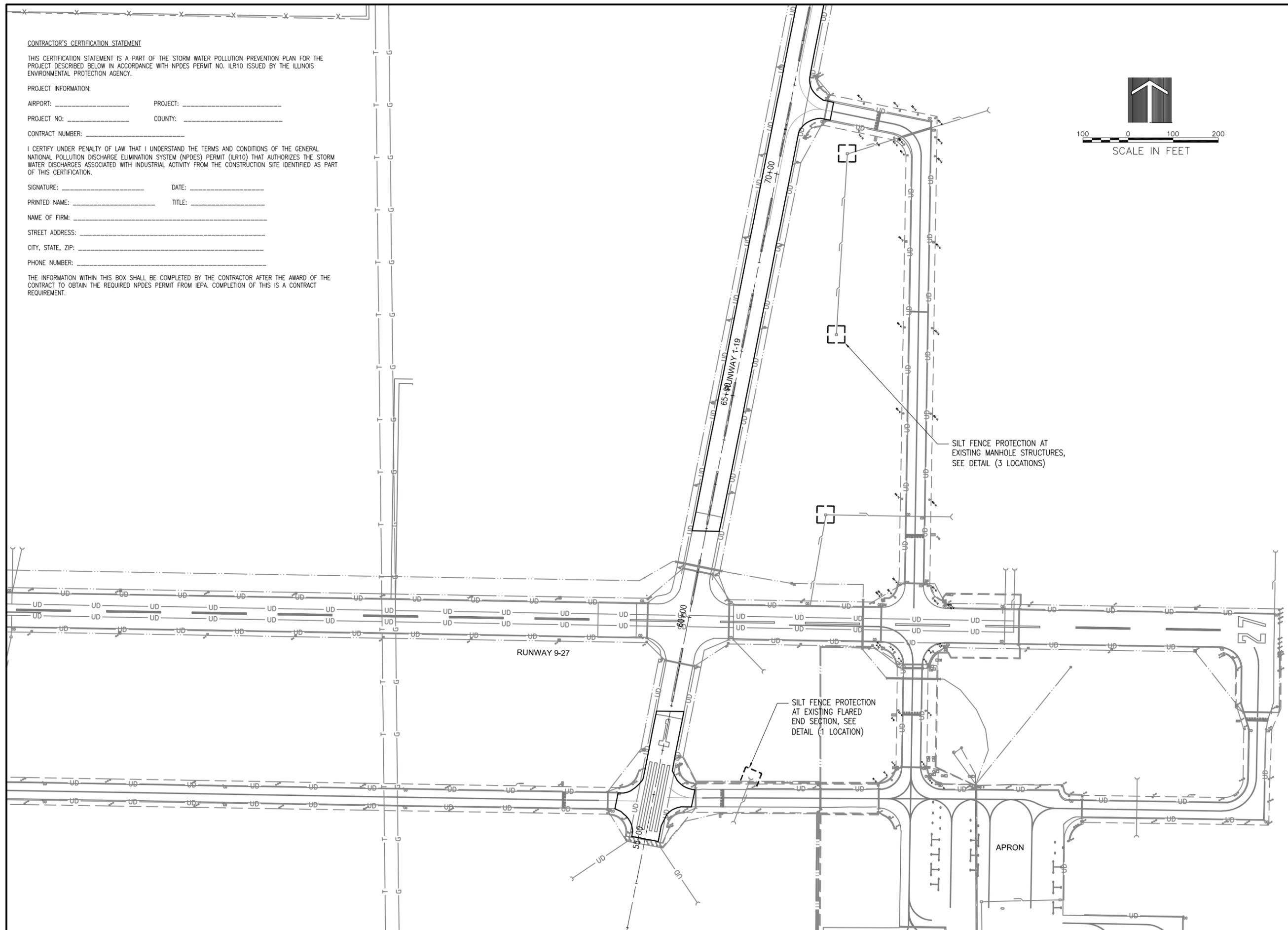

SILT FENCE PROTECTION AT EXISTING MANHOLE STRUCTURES, SEE DETAIL (3 LOCATIONS)

SILT FENCE PROTECTION AT EXISTING FLARED END SECTION, SEE DETAIL (1 LOCATION)

REHABILITATE RUNWAY 1-19

IDA No: EZI-4673
SBGP No: 3-17-SBGP-TBD

Contract No.: KE016

NO.	DATE	DESCRIPTION		
		LAY	DWN	REV

ISSUE: JUNE 8, 2018
PROJECT NO: 18A0008
CAD FILE: 10-SWPP.DWG
LAYOUT BY: LDH 2/26/18
DRAWN BY: LDH 2/26/18
REVIEWED BY: KMS 4/30/18

© Copyright Hanson Professional Services Inc. 2013
SHEET TITLE

STORMWATER POLLUTION PREVENTION PLAN

SEDIMENTATION AND EROSION CONTROL NOTES:

- A. SEDIMENT CONTROL MEASURES SHALL BE INSTALLED PRIOR TO THE COMMENCEMENT OF HYDROLOGIC DISTURBANCE OF UPLAND AREAS.
- B. FOR THOSE DEVELOPMENTS THAT REQUIRE A DESIGNATED EROSION CONTROL INSPECTOR (DECI), INSPECTIONS AND DOCUMENTATION SHALL BE PERFORMED, AT A MINIMUM:
 - UPON COMPLETION OF SEDIMENT AND RUNOFF CONTROL MEASURES (INCLUDING PERIMETER CONTROLS AND DIVERSIONS), PRIOR TO PROCEEDING WITH ANY OTHER EARTH DISTURBANCE OR GRADING.
 - AFTER EVERY SEVEN (7) CALENDAR DAYS OR STORM EVENT WITH GREATER THAN 0.5 INCH OF RAINFALL OR LIQUID EQUIVALENT PRECIPITATION.
- C. SOIL DISTURBANCE SHALL BE CONDUCTED IN SUCH A MANNER AS TO MINIMIZE EROSION. IF STRIPPING, CLEARING, GRADING, OR LANDSCAPING ARE TO BE DONE IN PHASES, THE PERMITTEE SHALL PLAN FOR APPROPRIATE SOIL EROSION AND SEDIMENT CONTROL MEASURES.
- D. A STABILIZED MAT OF CRUSHED STONE MEETING IDOT GRADATION CA-01 UNDERLAIN WITH FILTER FABRIC AND IN ACCORDANCE WITH THE ILLINOIS URBAN MANUAL, OR OTHER APPROPRIATE MEASURE(S) AS APPROVED BY THE ENFORCEMENT OFFICER, SHALL BE INSTALLED AT ANY POINT WHERE TRAFFIC WILL BE ENTERING OR LEAVING A CONSTRUCTION SITE. SEDIMENT OR SOIL REACHING AN IMPROVED PUBLIC RIGHT OF WAY, STREET, ALLEY OR PARKING AREA SHALL BE REMOVED BY SCRAPING OR STREET CLEANING AS ACCUMULATIONS WARRANT AND TRANSPORTED TO A CONTROLLED SEDIMENT DISPOSAL AREA.
- E. TEMPORARY DIVERSIONS SHALL BE CONSTRUCTED AS NECESSARY TO DIRECT ALL RUNOFF FROM HYDROLOGICALLY DISTURBED AREAS TO AN APPROPRIATE SEDIMENT TRAP OR BASIN.
- F. DISTURBED AREAS SHALL BE STABILIZED WITH TEMPORARY OR PERMANENT MEASURES WITHIN SEVEN (7) CALENDAR DAYS FOLLOWING THE END OF ACTIVE HYDROLOGIC DISTURBANCE OR REDISTURBANCE.
- G. ALL STOCKPILES SHALL HAVE APPROPRIATE MEASURES TO PREVENT EROSION. STOCKPILES SHALL NOT BE PLACED IN FLOOD PRONE AREAS OR WETLANDS AND DESIGNATED BUFFERS.
- H. SLOPES STEEPER THAN 3H:1V SHALL BE STABILIZED WITH APPROPRIATE MEASURES AS APPROVED BY THE ENFORCEMENT OFFICER.
- I. APPROPRIATE EROSION CONTROL BLANKET SHALL BE INSTALLED ON ALL INTERIOR DETENTION BASIN SIDE SLOPES BETWEEN THE NORMAL WATER LEVEL AND HIGH WATER LEVEL.
- J. STORM SEWERS THAT ARE OR WILL BE FUNCTIONING DURING CONSTRUCTION SHALL BE PROTECTED BY AN APPROPRIATE SEDIMENT CONTROL MEASURE.
- K. IF DEWATERING SERVICES ARE USED, ADJOINING PROPERTIES AND DISCHARGE LOCATIONS SHALL BE PROTECTED FROM EROSION AND SEDIMENTATION. DISCHARGES SHALL BE ROUTED THROUGH AN APPROVED ANIONIC POLYMER DEWATERING SYSTEM OR A SIMILAR MEASURE AS APPROVED BY THE ENFORCEMENT OFFICER. DEWATERING SYSTEMS SHOULD BE INSPECTED DAILY DURING OPERATIONAL PERIODS. THE ENFORCEMENT OFFICER, OR APPROVED REPRESENTATIVE, MUST BE PRESENT AT THE COMMENCEMENT OF DEWATERING ACTIVITIES.
- L. IF INSTALLED SOIL EROSION AND SEDIMENT CONTROL MEASURES DO NOT MINIMIZE SEDIMENT LEAVING THE DEVELOPMENT SITE, ADDITIONAL MEASURES SUCH AS ANIONIC POLYMERS OR FILTRATION SYSTEMS MAY BE REQUIRED BY THE ENFORCEMENT OFFICER.
- M. ALL TEMPORARY AND PERMANENT EROSION CONTROL MEASURES MUST BE MAINTAINED AND REPAIRED AS NEEDED. THE PROPERTY OWNER SHALL BE ULTIMATELY RESPONSIBLE FOR MAINTENANCE AND REPAIR.
- N. ALL TEMPORARY SEDIMENT CONTROL MEASURES SHALL BE REMOVED WITHIN 30 DAYS AFTER FINAL SITE STABILIZATION IS ACHIEVED OR AFTER THE TEMPORARY MEASURES ARE NO LONGER NEEDED.
- O. THE EROSION CONTROL MEASURES INDICATED ON THE PLANS ARE THE MINIMUM REQUIREMENTS. ADDITIONAL MEASURES MAY BE REQUIRED, AS DIRECTED BY THE ENGINEER, ENFORCEMENT OFFICER, OR OTHER GOVERNING AGENCY.

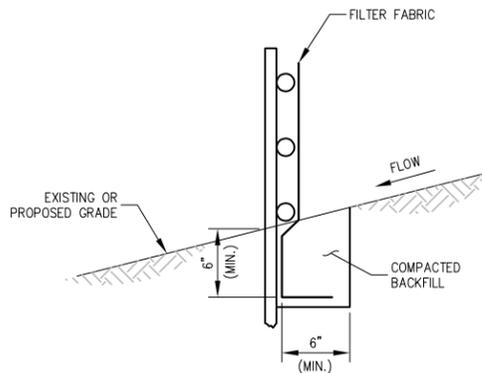

FABRIC ANCHOR DETAIL

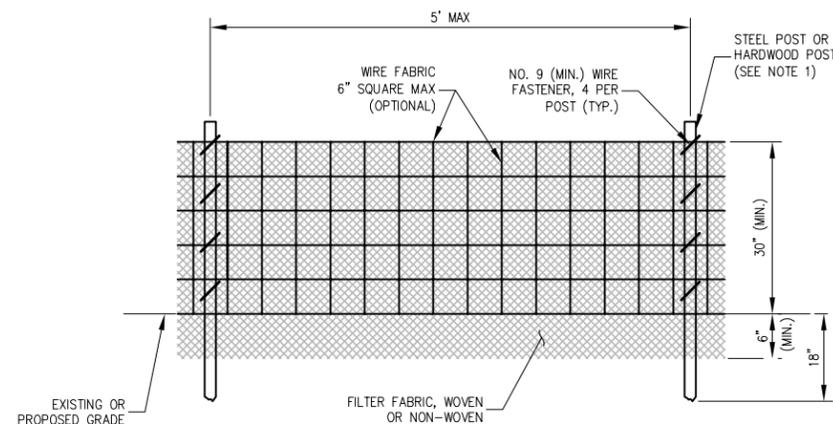

ELEVATION

NOTES:

1. FENCE POST SHALL BE EITHER STEEL "T" LINE POST OR HARDWOOD POST WITH A MINIMUM SECTIONAL AREA OF 2.0 SQUARE INCHES. A CARPENTER'S (NOMINAL) 2"x2" POST WILL MEET SPECIFICATIONS.
2. TOP AND BOTTOM WIRE OF WIRE FABRIC SHALL BE MINIMUM GAGE NO. 9. INTERMEDIATE WIRES OF THE WIRE FABRIC SHALL BE MINIMUM GAGE NO. 11.
3. WIRE FABRIC SHALL BE SECURELY FASTENED TO FENCE POSTS WITH NO. 9 GAGE WIRE MINIMUM. FOUR (4) FASTENERS PER POST REQUIRED.
4. FILTER FABRIC SHALL BE SECURELY FASTENED TO WIRE FABRIC AND POSTS WITH TIES OR STAPLES SPACED AT 12" APART AT THE TOP, MIDDLE AND BOTTOM.
5. WHEN TWO SECTIONS OF FILTER FABRIC MEET, THEY SHALL BE OVERLAPPED BY 6" AND FOLDED AND ATTACHED TO THE WIRE FABRIC AT A POST.
6. FILTER FABRIC SHALL BE IN ACCORDANCE WITH SPECIAL PROVISIONS WITH APPARENT OPENING SIZE (AOS) OF AT LEAST 40 FOR NONWOVEN AND WOVEN. **THE FABRIC MUST MEET THE APPLICABLE STANDARDS OF AASHTO 288-00 (Article IV, Section B.1.1.1, AS AMENDED), OR EQUIVALENT.**
7. A MAXIMUM OF 5 FEET IS USED FOR POST-TO-POST SPACING.
8. SOIL DISTURBANCE SHALL BE CONDUCTED IN SUCH A MANNER AS TO MINIMIZE EROSION. SOIL STABILIZATION MEASURES SHALL CONSIDER THE TIME OF YEAR, SITE CONDITIONS AND THE USE OF TEMPORARY OR PERMANENT MEASURES.
9. ALL STORM SEWERS THAT ARE OR WILL BE FUNCTIONING DURING CONSTRUCTION SHALL BE PROTECTED BY AN APPROPRIATE SEDIMENT CONTROL MEASURE.
10. SILT FENCE SHALL BE INSTALLED PRIOR TO ANY GRADING WORK IN THE AREA TO BE PROTECTED. PERIODIC INSPECTION SHALL BE PERFORMED AND REQUIRED MAINTENANCE SHALL BE PROVIDED AFTER EACH RAIN EVENT.
11. MAINTENANCE SHALL BE PERFORMED AS NEEDED AND MATERIAL REMOVED AND REPLACED WHEN BULGES DEVELOP IN THE SILT FENCE.
12. IF DEWATERING SERVICES ARE USED, ADJOINING PROPERTIES AND DISCHARGE LOCATIONS SHALL BE PROTECTED FROM EROSION. DISCHARGES SHALL BE ROUTED THROUGH AN EFFECTIVE SEDIMENT CONTROL MEASURE (E.G. SEDIMENT TRAP, SEDIMENT BASIN, OR OTHER APPROPRIATE MEASURE).
13. FENCE POSTS SHALL BE REMOVED WHEN DIRECTED AT PROJECT END.
14. THE EROSION CONTROL MEASURES INDICATED ON THE PLANS ARE THE MINIMUM REQUIREMENTS. ADDITIONAL MEASURES MAY BE REQUIRED, AS DIRECTED BY THE ENGINEER OR GOVERNING AGENCY.

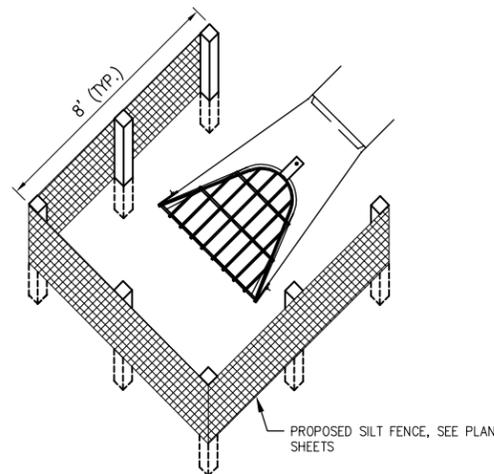

SILT FENCE PLACEMENT AT FLARED END SECTIONS (FES)

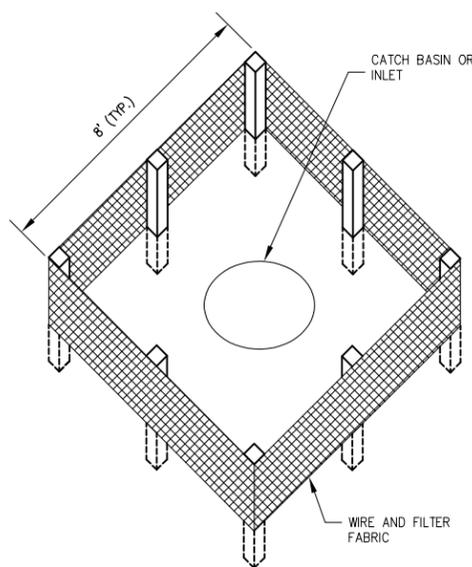

SILT FENCE AT MANHOLES IN PERVIOUS AREAS

NOTES:

1. FILTER FABRIC SHALL BE EMBEDDED 8" INTO THE SOIL.
2. INSPECTION SHALL BE FREQUENT AND REPAIR/REPLACEMENT SHALL BE MADE PROMPTLY AS NEEDED.
3. SILT FENCE SHALL BE REMOVED WHEN IT HAS SERVED ITS USEFULNESS AT THE DIRECTION OF THE AIRPORT REPRESENTATIVE OR OWNER SO AS NOT TO BLOCK OR IMPEDE STORM FLOW OR DRAINAGE. CONTRACTOR SHALL PLACE SEED AND MULCH PER LANDSCAPING PLAN. COST OF REMOVAL SHALL BE INCLUDED IN THE CONTRACT UNIT PRICE FOR SILT FENCE.
4. AREAS DISTURBED OUTSIDE OF CONSTRUCTION LIMITS DURING PLACEMENT OF INLET PROTECTION TO BE RE-GRADED, SEEDED AND MULCHED, COST INCIDENTAL TO SILT FENCE.
5. FENCE AND POSTS SHALL BE REMOVED WHEN DIRECTED AT PROJECT END.
6. PAID UNDER AR156510 SILT FENCE.

STORM WATER POLLUTION PREVENTION NOTES

GENERAL

THE CONTRACTOR SHALL IMPLEMENT ALL PROVISIONS OF THE CONTRACT DOCUMENTS TO ASSURE THAT STORM WATER POLLUTION PREVENTION ITEMS ARE CONSTRUCTED AND MAINTAINED IN A TIMELY MANNER. SEDIMENTATION MUST NOT BE TRANSPORTED OFF THE CONSTRUCTION SITE. PERMANENT DRAINAGE FEATURES AND VEGETATIVE MEASURES SHALL BE PROVIDED AS SOON AS POSSIBLE.

THE MAINTENANCE OF ALL STORM WATER POLLUTION PREVENTION MEASURES IS INCIDENTAL TO THE ASSOCIATED ITEM.

POLLUTION PREVENTION MEASURES

THE CONTRACTOR SHALL BE REQUIRED TO IMPLEMENT AND MAINTAIN STORM WATER POLLUTION PREVENTION PRACTICES AND MEASURES PRIOR TO THE STRIPPING OF EXISTING VEGETATION WHEREVER POSSIBLE AND AS SOON AS CONSTRUCTION PERMITS IN OTHER AREAS. POLLUTION CONTROL MEASURES SHALL BE IN ACCORDANCE WITH THE CONTRACT DOCUMENTS, INCLUDING THESE CONSTRUCTION PLANS, AND WITH STANDARDS AND SPECIFICATIONS FOR SOIL EROSION AND SEDIMENT CONTROL, ILLINOIS ENVIRONMENTAL PROTECTION AGENCY, CURRENT ISSUE. THE CONTRACTOR SHALL ADJUST HIS OPERATIONS AND IMPLEMENT POLLUTION CONTROL MEASURES SO THAT NO RUNOFF FROM STRIPPED AREAS WILL LEAVE THE CONSTRUCTION SITE OTHER THAN THROUGH SEDIMENT TRAPS OR OTHER SUITABLE CONTROL MEASURES.

POLLUTION CONTROL ITEMS SHALL BE PROVIDED AS NOTED ON THE STORM WATER POLLUTION PREVENTION PLAN AND IN THE STORM WATER POLLUTION PREVENTION DETAILS AND AS DIRECTED BY THE ENGINEER. THE LIMITS OF SUCH MEASURES SHALL BE STAKED BY THE CONTRACTOR PRIOR TO THE COMMENCEMENT OF CONSTRUCTION. SUCH LIMITS MAY BE ADJUSTED BY THE ENGINEER TO ACCOUNT FOR ACTUAL SITE CONDITIONS EXPERIENCED DURING CONSTRUCTION. ADDITIONAL COMPENSATION FOR MEASURES EXCEEDING THE PLAN QUANTITIES WILL BE PAID FOR AT THE CONTRACT UNIT PRICE FOR EACH ITEM.

THE CONTRACTOR IS TO MAINTAIN AND ADJUST, REPAIR OR REPLACE ALL POLLUTION PREVENTION MEASURES AS REQUIRED OR AS DIRECTED BY THE ENGINEER UNTIL PERMANENT VEGETATION HAS BEEN ESTABLISHED. MAINTENANCE OF POLLUTION CONTROL MEASURES IS TO BE PROVIDED AT NO ADDITIONAL COST TO THE CONTRACT.

ADDITIONAL STORMWATER POLLUTION PREVENTION MEASURES ARE EXISTING ON SITE LOCATED AT DRAINAGE FACILITIES AND ALONG THE PROPERTY LINE.

REHABILITATE RUNWAY 1-19

IDA No: EZI-4673
SBGP No: 3-17-SBGP-TBD

Contract No.: KE016

NO.	DATE	DESCRIPTION		
		LAY	DWN	REV

ISSUE: JUNE 8, 2018
PROJECT NO: 18A0008
CAD FILE: 11-SWPPP DET.DWG
LAYOUT BY: LDH 2/26/18
DRAWN BY: LDH 2/26/18
REVIEWED BY: KMS 4/30/18
© Copyright Hanson Professional Services Inc. 2013
SHEET TITLE

SWPPP DETAILS

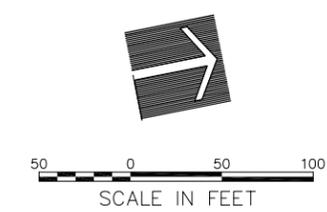

FOR NOTES AND LEGEND, SEE SHEET 12.

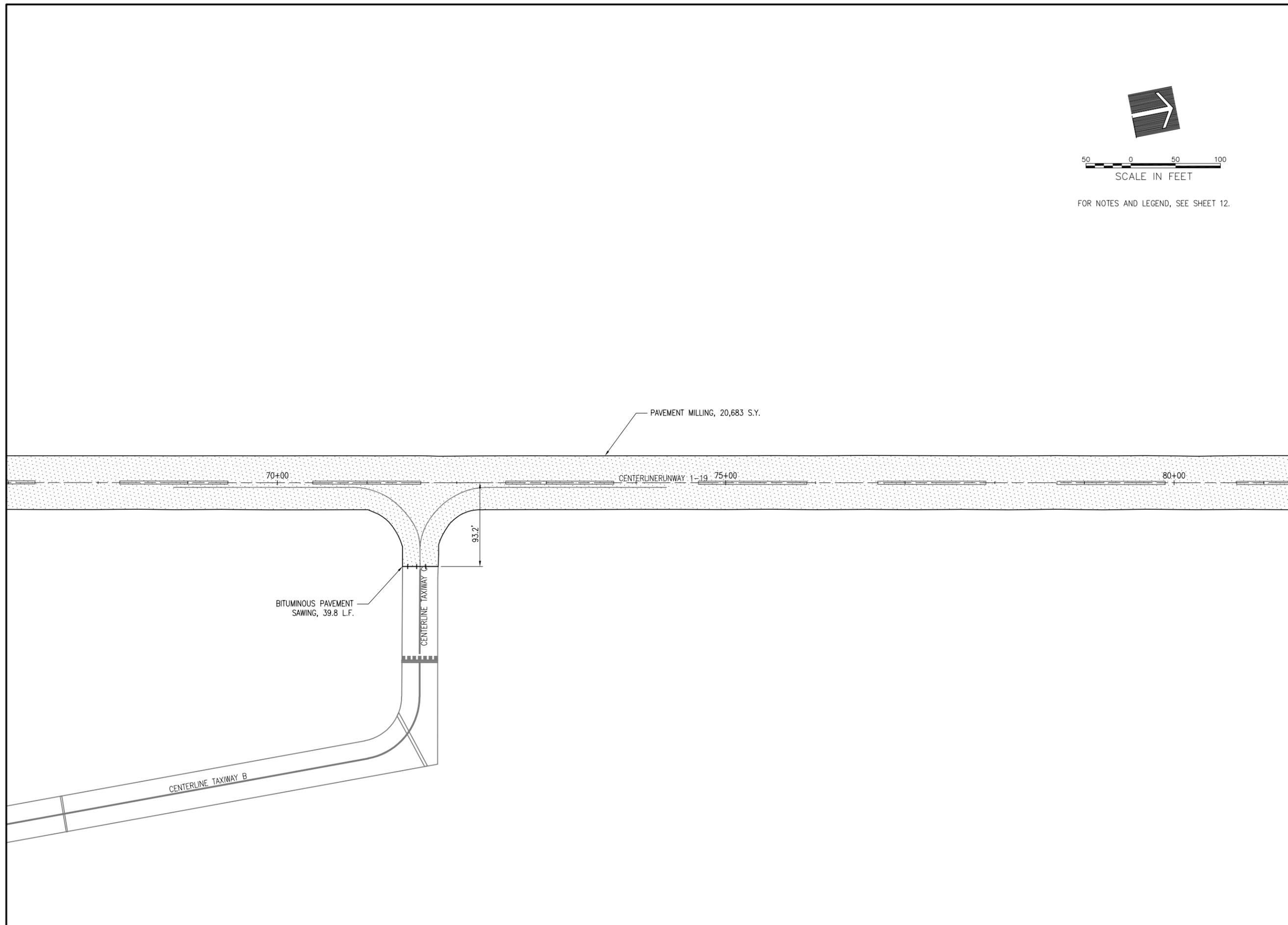

REHABILITATE RUNWAY 1-19

IDA No: EZI-4673
SBGP No: 3-17-SBGP-TBD

Contract No.: KE016

NO.	DATE	DESCRIPTION		
		LAY	DWN	REV

ISSUE: JUNE 8, 2018
PROJECT NO: 18A0008
CAD FILE: 13-REMOVAL.DWG
LAYOUT BY: LDH 2/26/18
DRAWN BY: LDH 2/26/18
REVIEWED BY: KMS 4/30/18

© Copyright Hanson Professional Services Inc. 2013
SHEET TITLE

REMOVAL PLAN 2

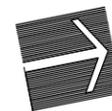

FOR NOTES AND LEGEND, SEE SHEET 12.

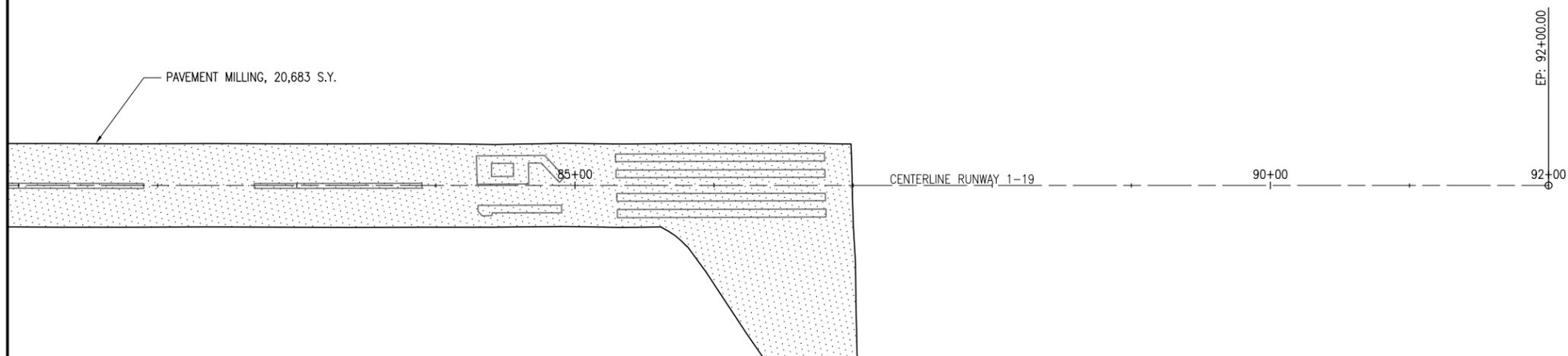

REHABILITATE RUNWAY 1-19

IDA No: EZI-4673
SBGP No: 3-17-SBGP-TBD

Contract No.: KE016

NO.	DATE	DESCRIPTION		
		LAY	DWN	REV

ISSUE: JUNE 8, 2018
PROJECT NO: 18A0008
CAD FILE: 14-REMOVAL.DWG
LAYOUT BY: LDH 2/26/18
DRAWN BY: LDH 2/26/18
REVIEWED BY: KMS 4/30/18

© Copyright Hanson Professional Services Inc. 2013
SHEET TITLE

REMOVAL PLAN 3

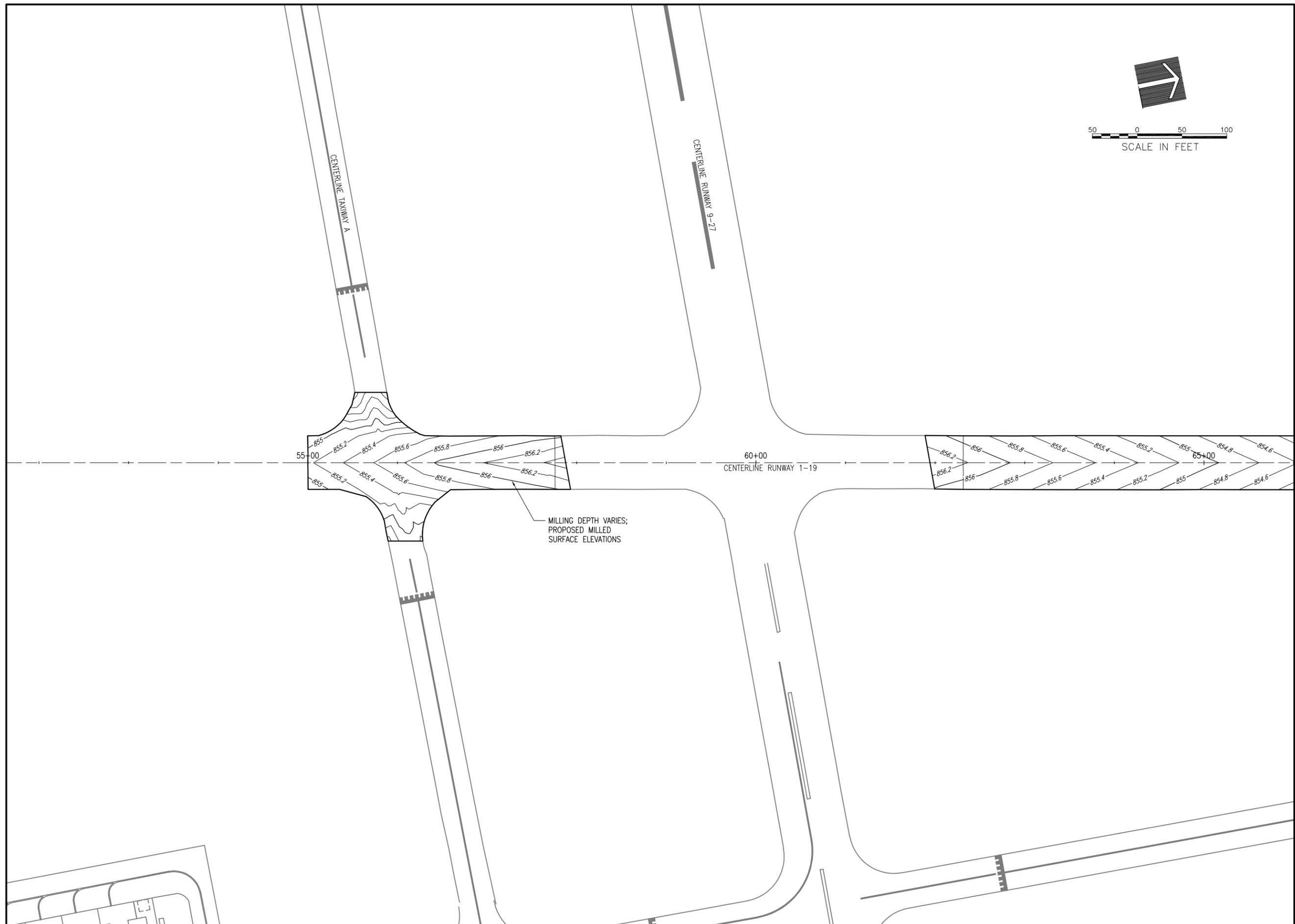
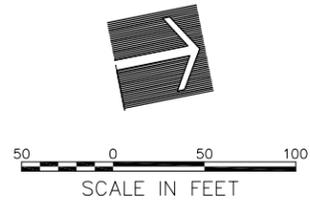

REHABILITATE RUNWAY 1-19

IDA No: EZI-4673
SBGP No: 3-17-SBGP-TBD

Contract No.: KE016

NO.	DATE	DESCRIPTION		
		LAY	DWN	REV

ISSUE: JUNE 8, 2018
PROJECT NO: 18A0008
CAD FILE: 15-GRADE.DWG
LAYOUT BY: LDH 4/24/18
DRAWN BY: LDH 4/24/18
REVIEWED BY: KMS 4/30/18

© Copyright Hanson Professional Services Inc. 2013
SHEET TITLE

MILLING GRADING PLAN 1

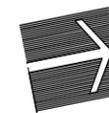

FOR NOTES AND LEGEND, SEE SHEET 15.

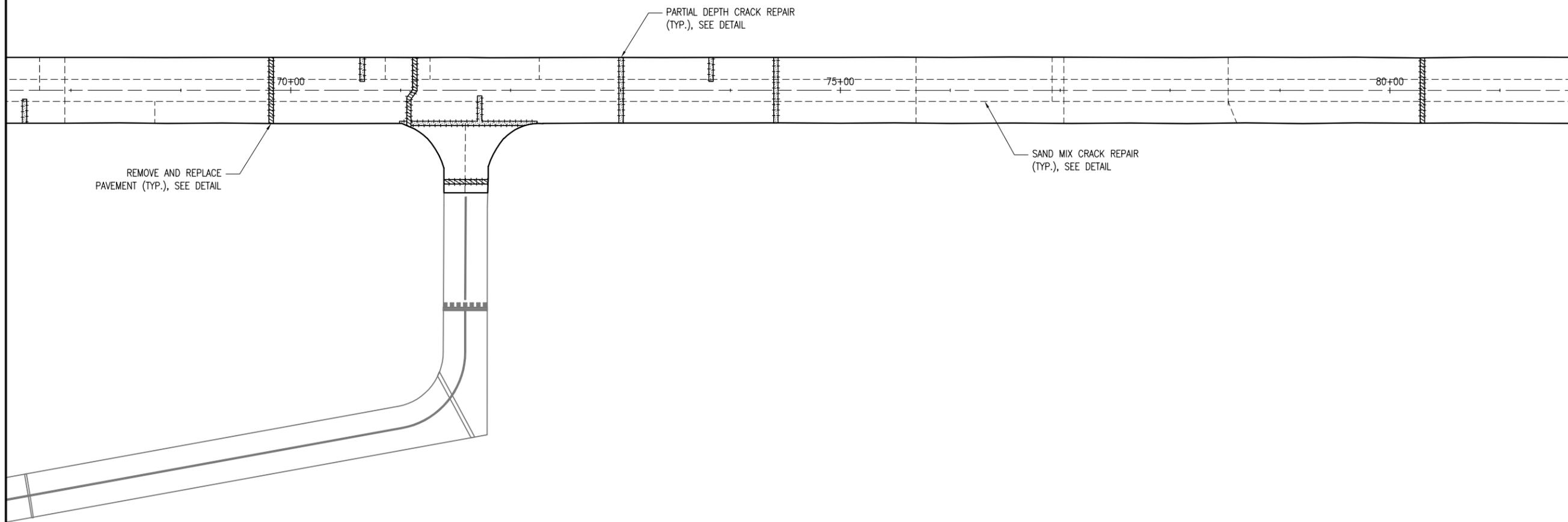

**REHABILITATE RUNWAY
1-19**

IDA No: EZI-4673
SBGP No: 3-17-SBGP-TBD

Contract No.: KE016

NO.	DATE	DESCRIPTION		
		LAY	DWN	REV

ISSUE: JUNE 8, 2018
PROJECT NO: 18A0008
CAD FILE: 19-CRACK.DWG
LAYOUT BY: LDH 2/27/18
DRAWN BY: LDH 2/27/18
REVIEWED BY: KMS 4/30/18

© Copyright Hanson Professional Services Inc. 2013
SHEET TITLE

**CRACK REPAIR
PLAN 2**

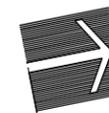

FOR NOTES AND LEGEND, SEE SHEET 15.

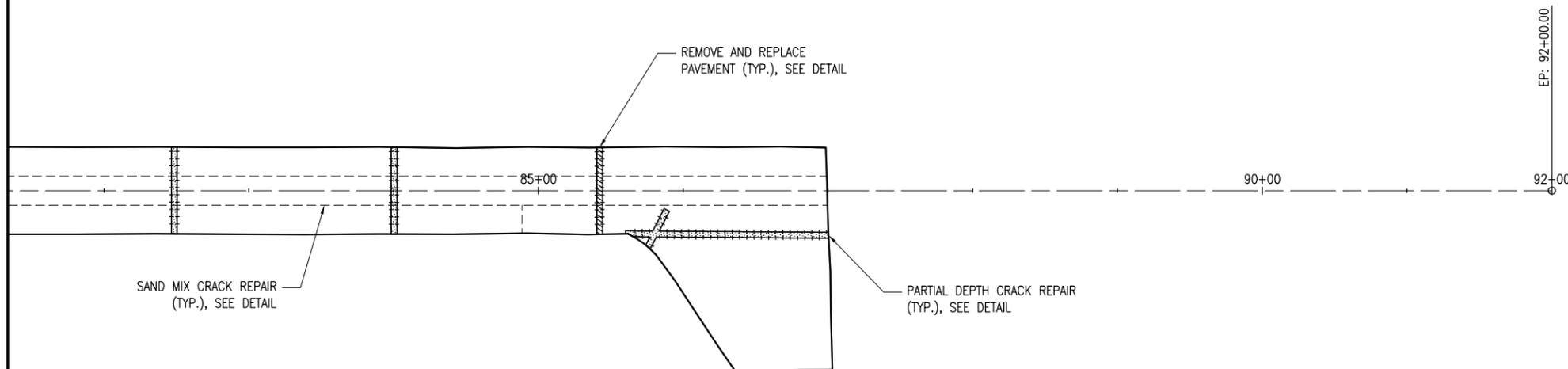

REHABILITATE RUNWAY 1-19

IDA No: EZI-4673
SBGP No: 3-17-SBGP-TBD

Contract No.: KE016

NO.	DATE	DESCRIPTION		
		LAY	DWN	REV

ISSUE: JUNE 8, 2018
PROJECT NO: 18A0008
CAD FILE: 20-CRACK.DWG
LAYOUT BY: LDH 2/27/18
DRAWN BY: LDH 2/27/18
REVIEWED BY: KMS 4/30/18

© Copyright Hanson Professional Services Inc. 2013
SHEET TITLE

CRACK REPAIR PLAN 3

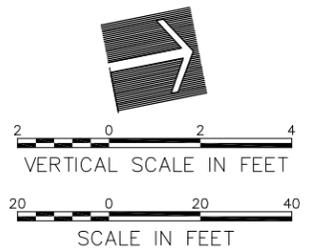
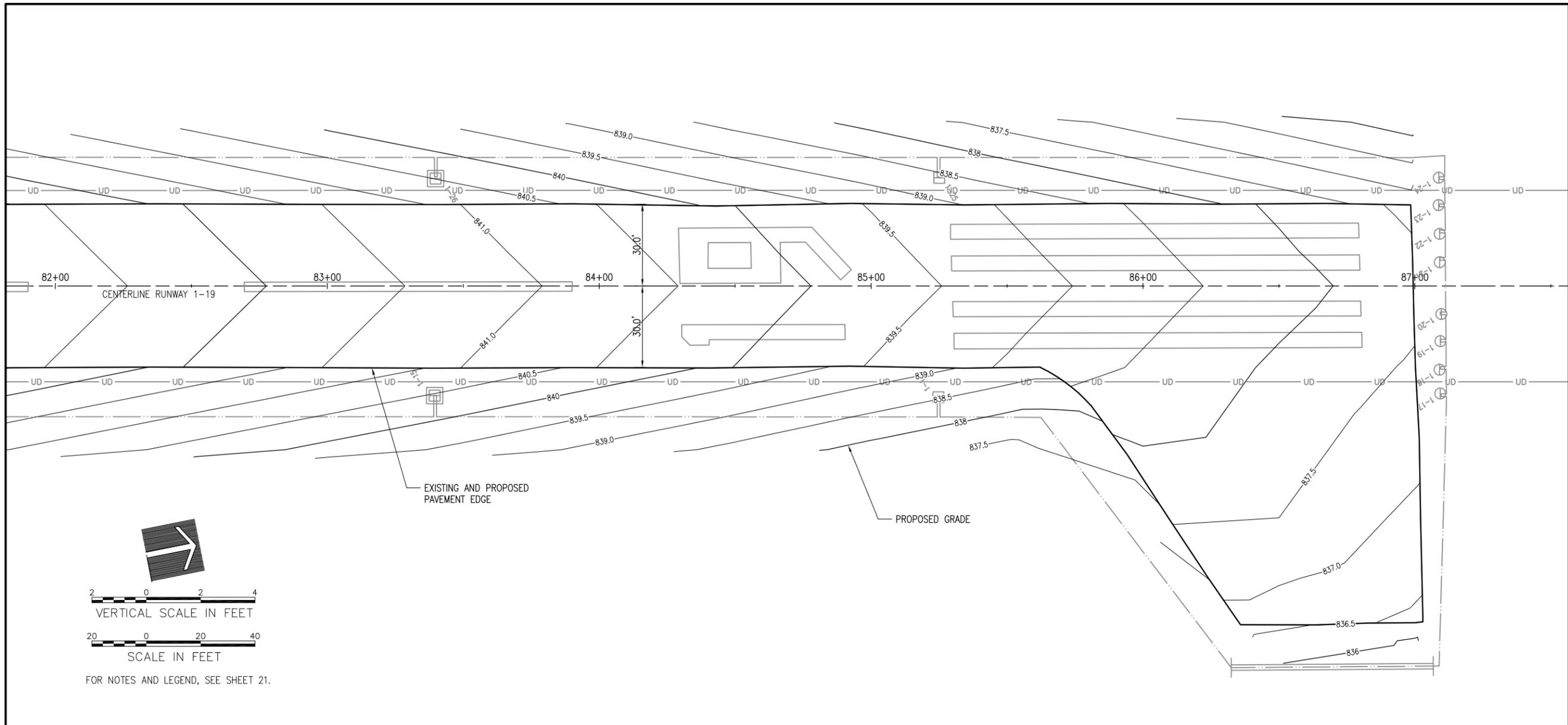

FOR NOTES AND LEGEND, SEE SHEET 21.

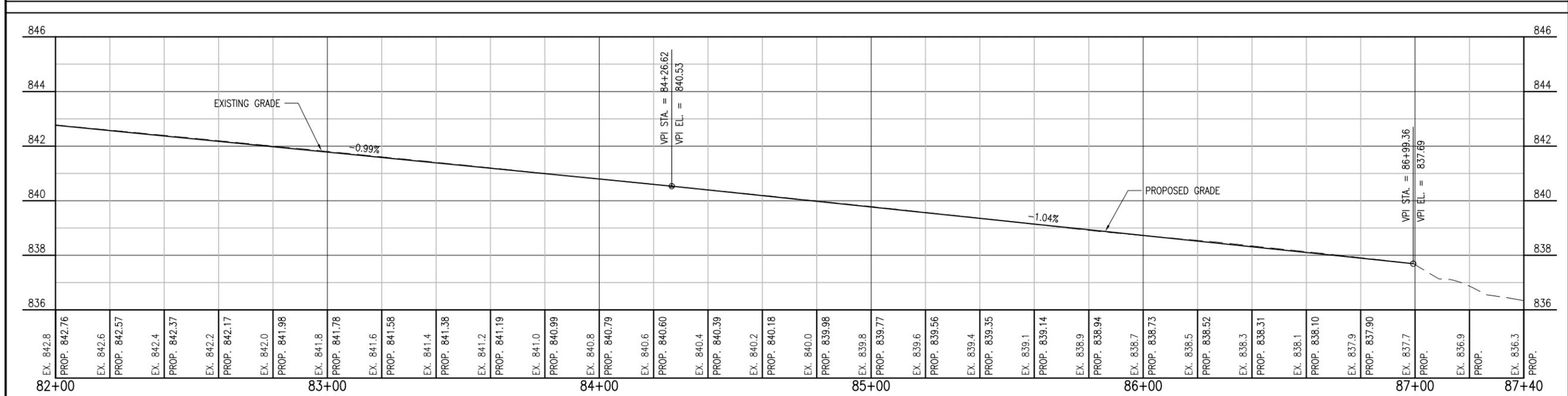

REHABILITATE RUNWAY 1-19

IDA No: EZI-4673
SBGP No: 3-17-SBGP-TBD

Contract No.: KE016

NO.	DATE	DESCRIPTION		
		LAY	DWN	REV

ISSUE: JUNE 8, 2018
PROJECT NO: 18A0008
CAD FILE: 26-P&P - (6).DWG
LAYOUT BY: LDH 4/4/18
DRAWN BY: LDH 4/4/18
REVIEWED BY: KMS 4/30/18
© Copyright Hanson Professional Services Inc. 2013
SHEET TITLE

PLAN & PROFILE
RUNWAY 1-19
STA. 82+00 - 87+40



REHABILITATE RUNWAY
1-19

IDA No: EZI-4673
SBGP No: 3-17-SBGP-TBD

Contract No.: KE016

NO.	DATE	DESCRIPTION		
		LAY	DWN	REV

ISSUE: JUNE 8, 2018
PROJECT NO: 18A0008
CAD FILE: 27-SECTIONS.DWG
LAYOUT BY: LDH 4/4/18
DRAWN BY: LDH 4/4/18
REVIEWED BY: KMS 4/30/18

© Copyright Hanson Professional Services Inc. 2013

SHEET TITLE

CROSS SECTIONS
STA. 55+00 THRU
STA. 57+50

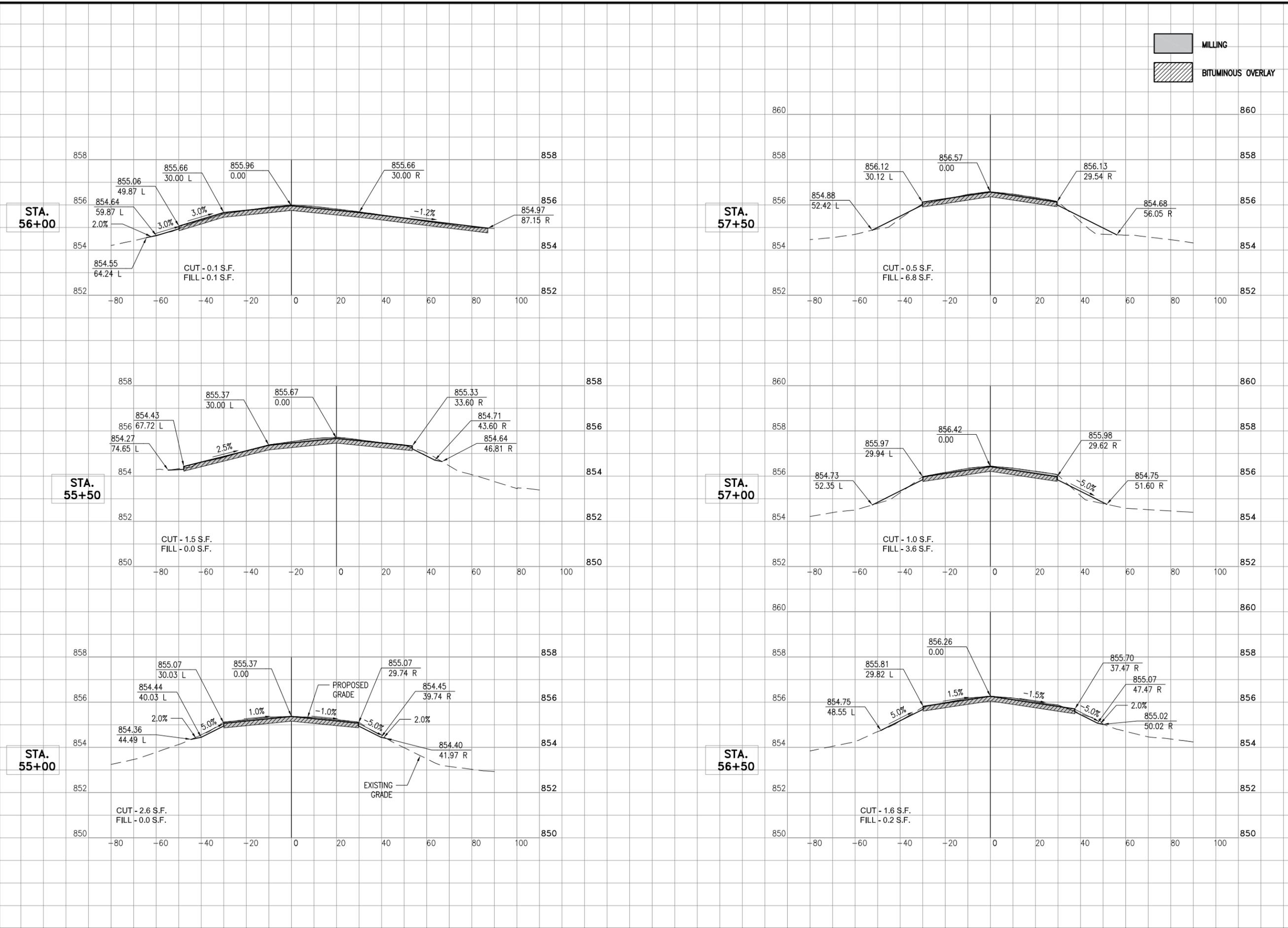



MILLING
 BITUMINOUS OVERLAY

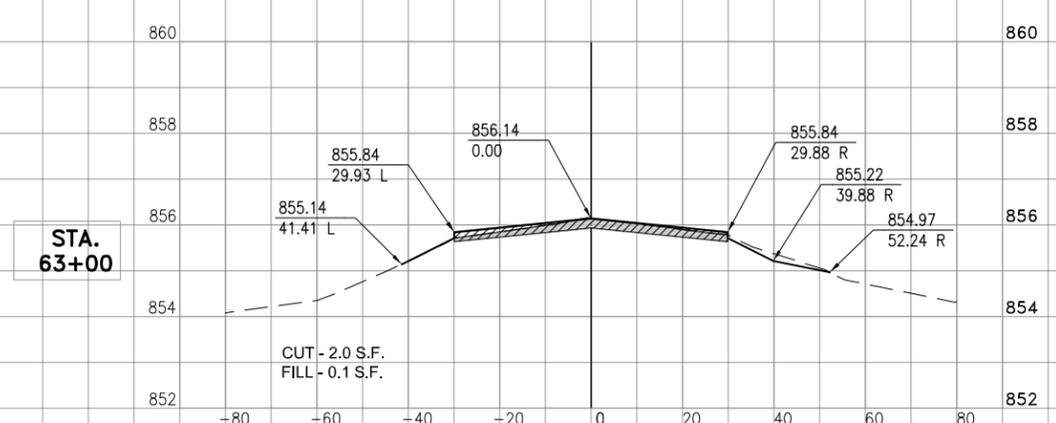
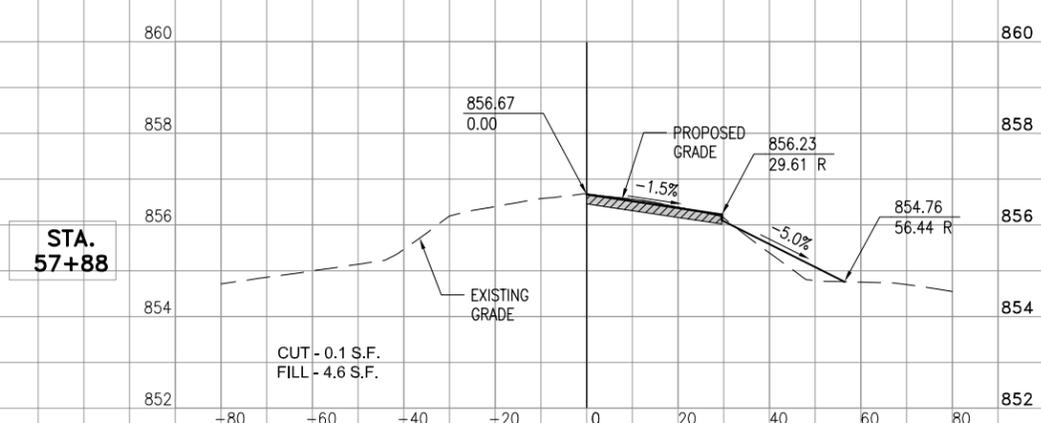
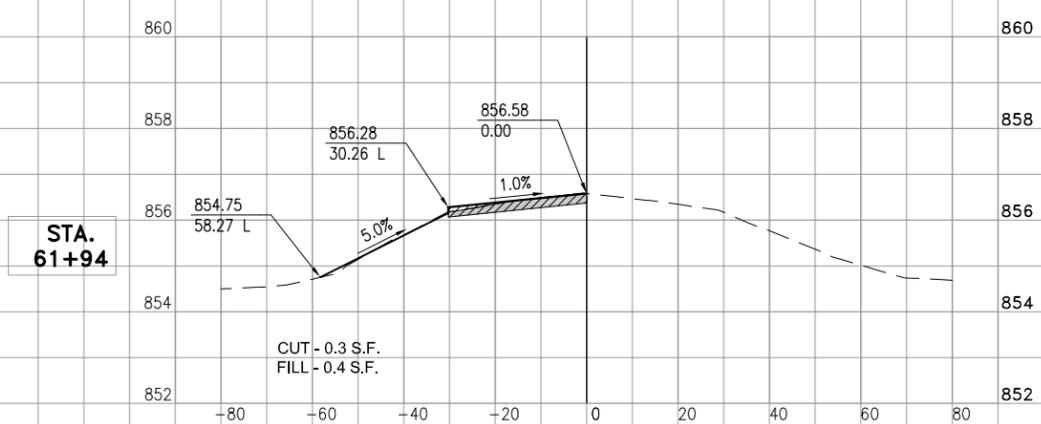
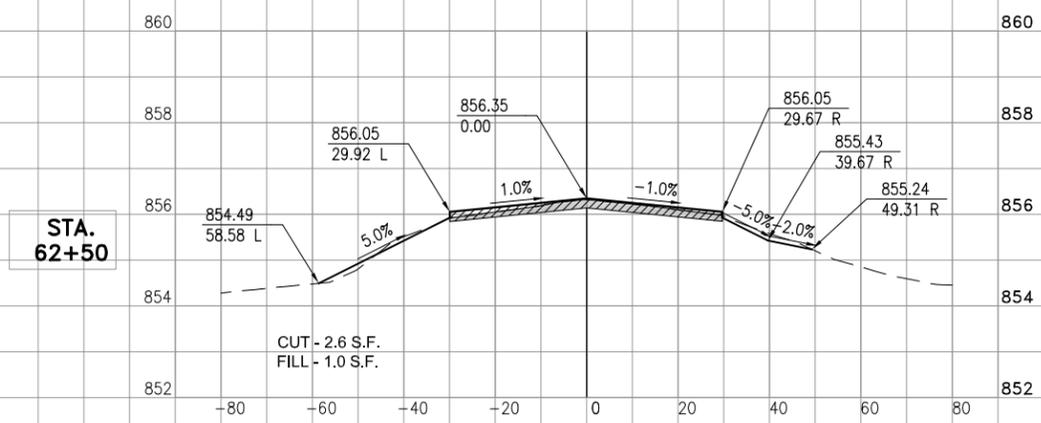

REHABILITATE RUNWAY
1-19

IDA No: EZI-4673
SBGP No: 3-17-SBGP-TBD

Contract No.: KE016

NO.	DATE	DESCRIPTION		
		LAY	DWN	REV

ISSUE: JUNE 8, 2018
PROJECT NO: 18A0008
CAD FILE: 28-SECTIONS.DWG
LAYOUT BY: LDH 4/4/18
DRAWN BY: LDH 4/4/18
REVIEWED BY: KMS 4/30/18
SHEET TITLE

CROSS SECTIONS
STA. 57+88 THRU
STA. 63+00



REHABILITATE RUNWAY
1-19

IDA No: EZI-4673
SBGP No: 3-17-SBGP-TBD

Contract No.: KE016

NO.	DATE	DESCRIPTION		
		LAY	DWN	REV

ISSUE: JUNE 8, 2018
PROJECT NO: 18A0008
CAD FILE: 29-SECTIONS.DWG
LAYOUT BY: LDH 4/4/18
DRAWN BY: LDH 4/4/18
REVIEWED BY: KMS 4/30/18

© Copyright Hanson Professional Services Inc. 2013
SHEET TITLE

CROSS SECTIONS
STA. 63+50 THRU
STA. 66+00

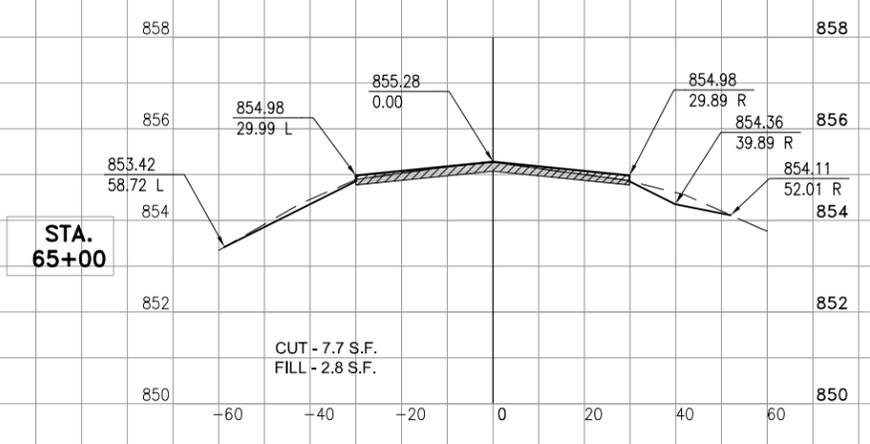
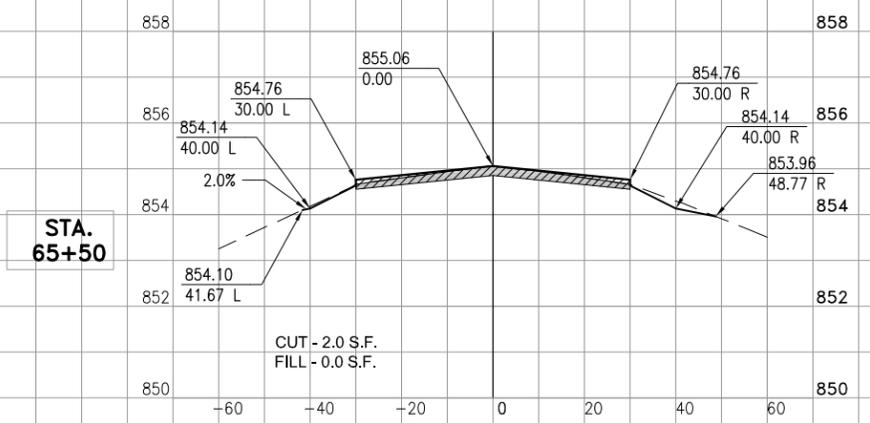
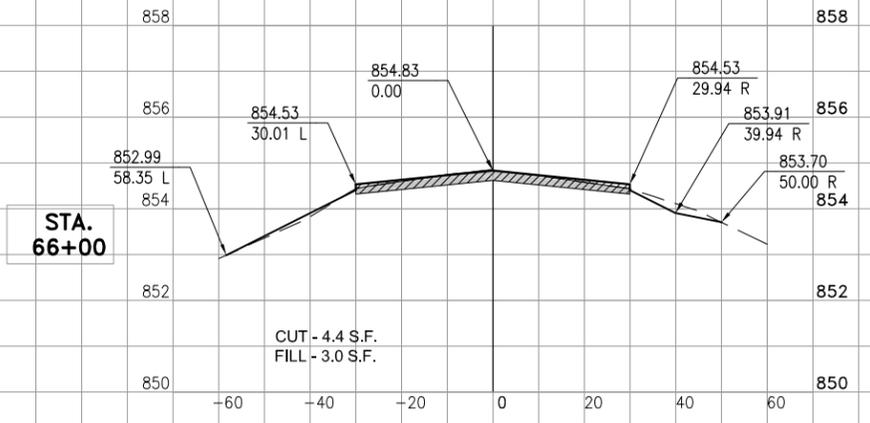
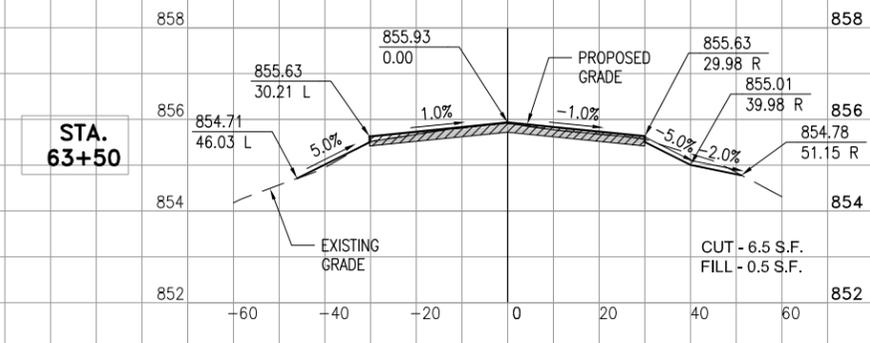
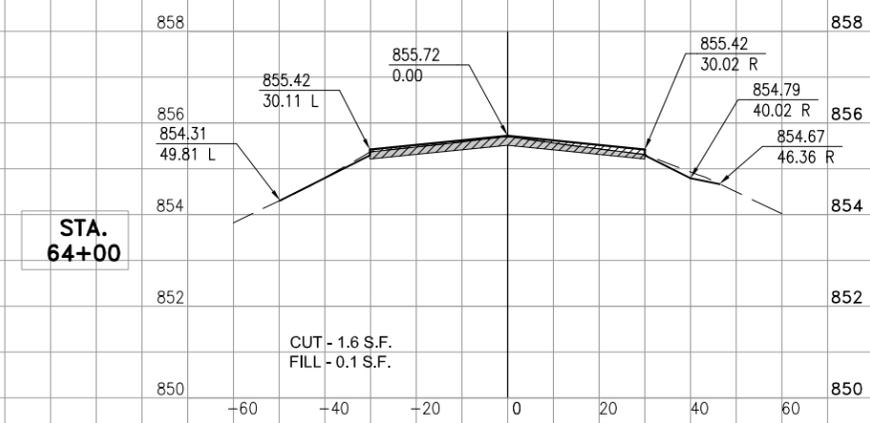
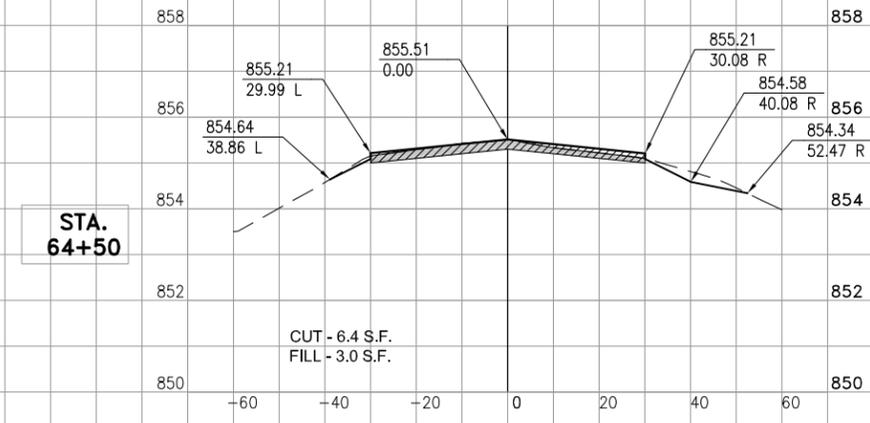

MILLING
BITUMINOUS OVERLAY



MILLING
 BITUMINOUS OVERLAY

REHABILITATE RUNWAY
1-19

IDA No: EZI-4673
SBGP No: 3-17-SBGP-TBD

Contract No.: KE016

NO.	DATE	DESCRIPTION		
		LAY	DWN	REV

ISSUE: JUNE 8, 2018
PROJECT NO: 18A0008
CAD FILE: 30-SECTIONS.DWG
LAYOUT BY: LDH 4/4/18
DRAWN BY: LDH 4/4/18
REVIEWED BY: KMS 4/30/18

© Copyright Hanson Professional Services Inc. 2013
SHEET TITLE

CROSS SECTIONS
STA. 66+50 THRU
STA. 69+00

STA. 67+50

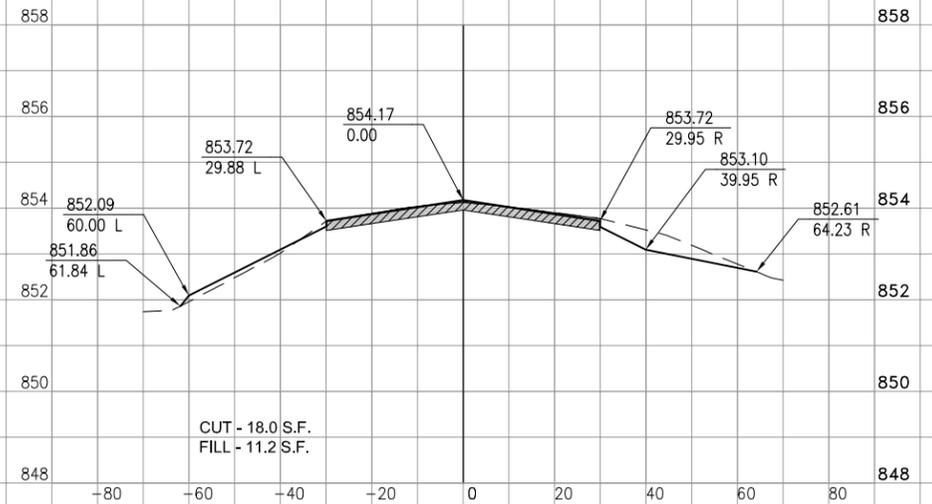

STA. 69+00

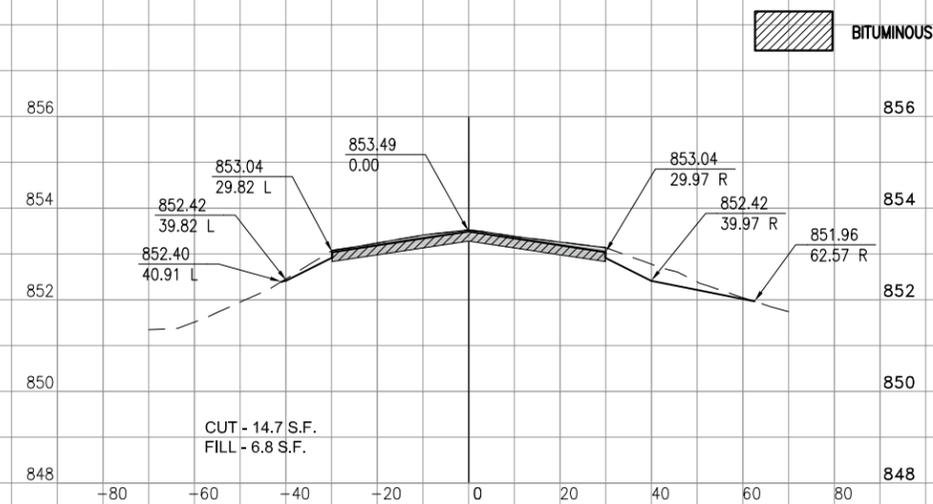

STA. 67+00

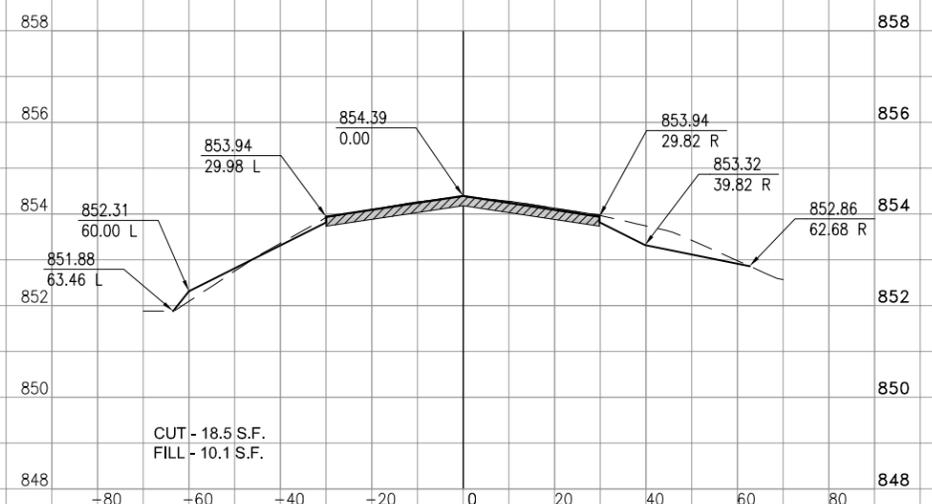

STA. 68+50

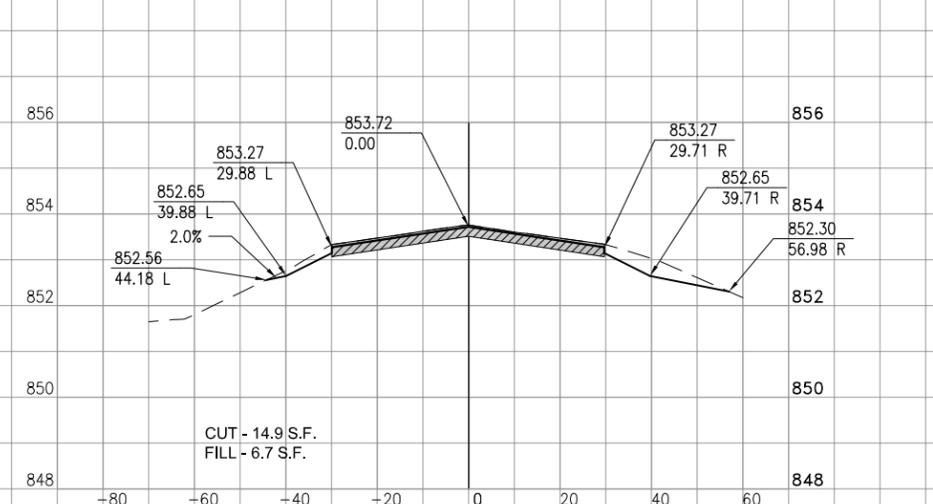

STA. 66+50

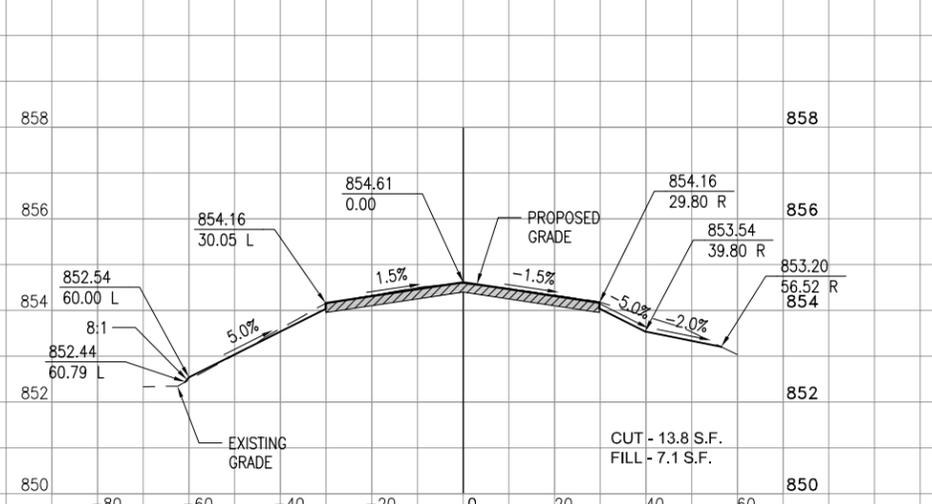

STA. 68+00

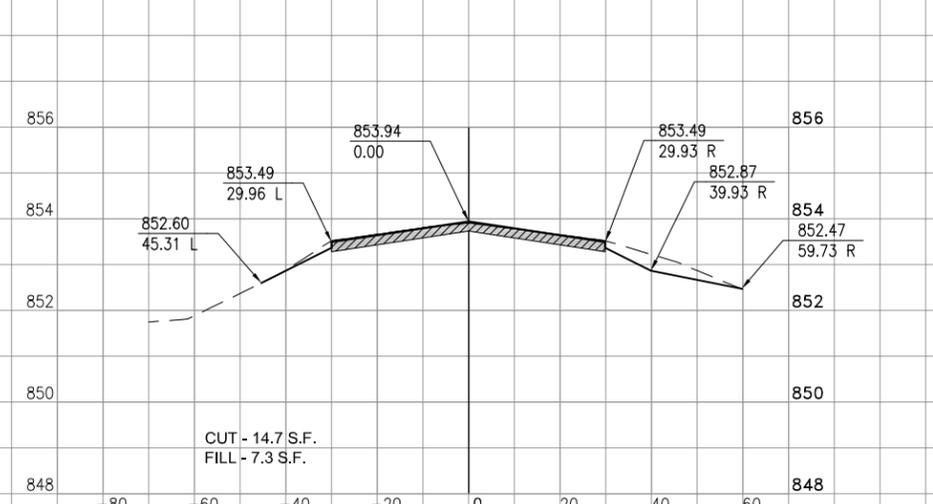



MILLING
 BITUMINOUS OVERLAY

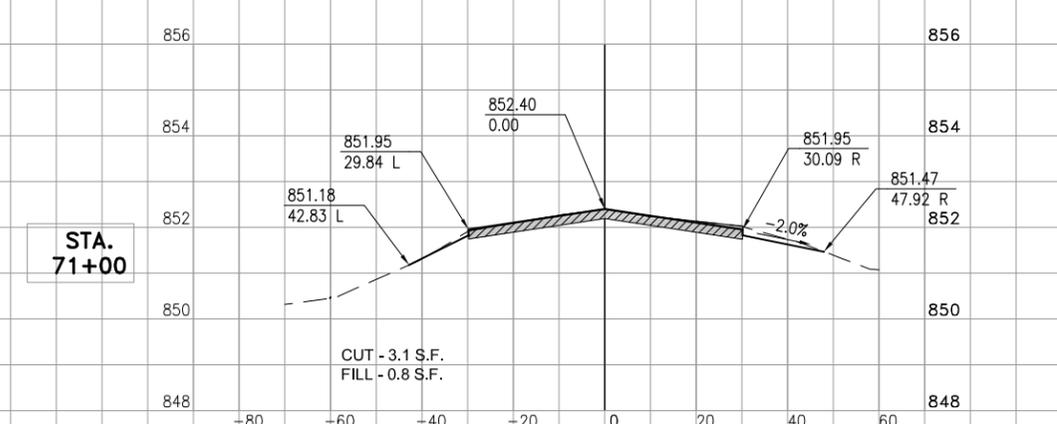
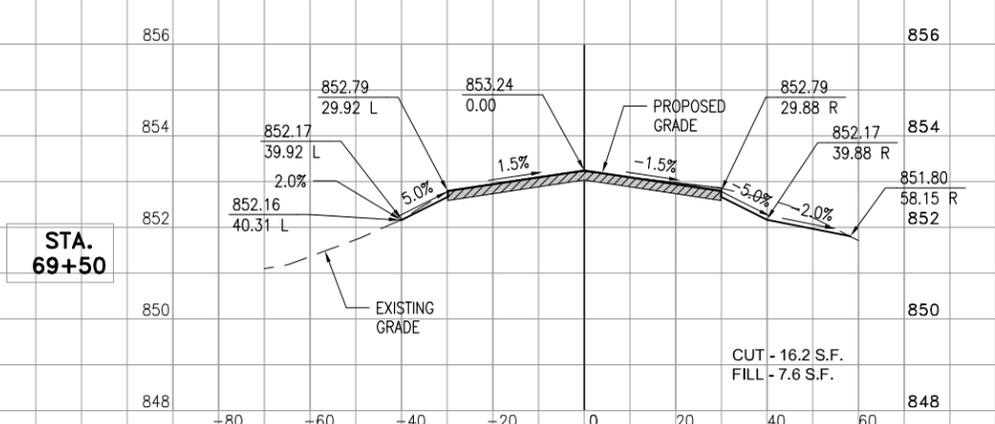
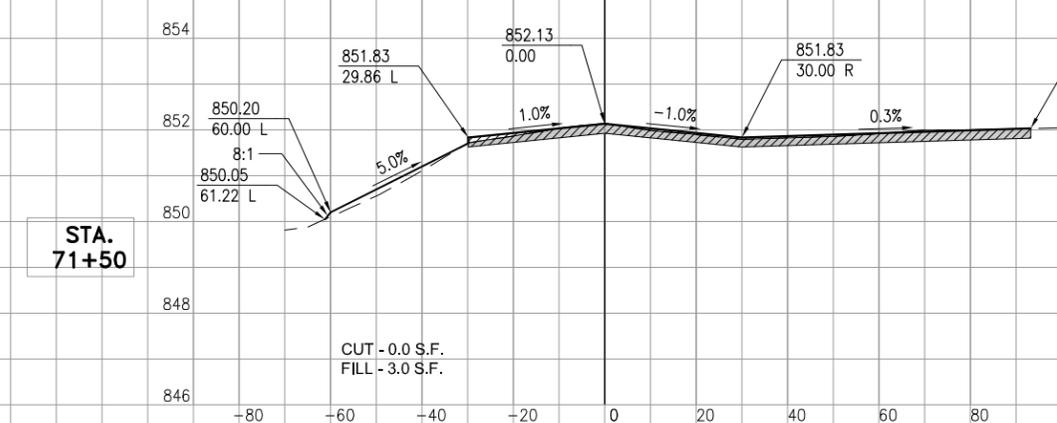
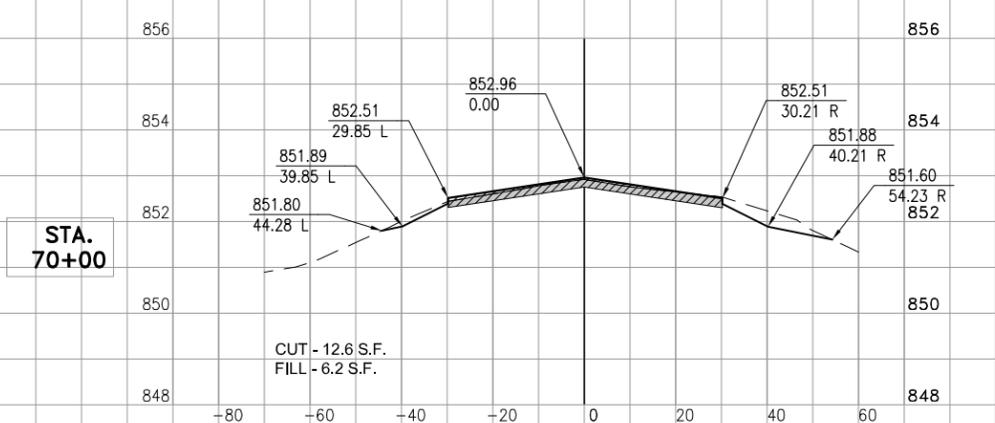
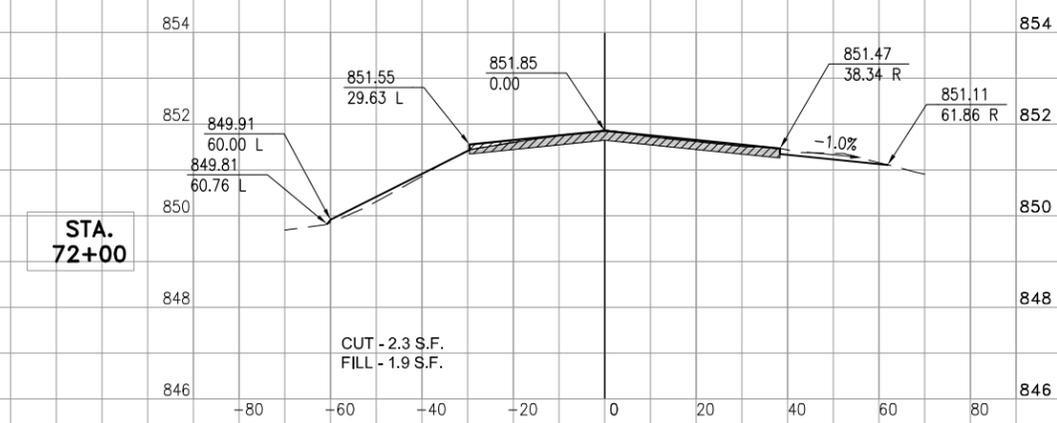
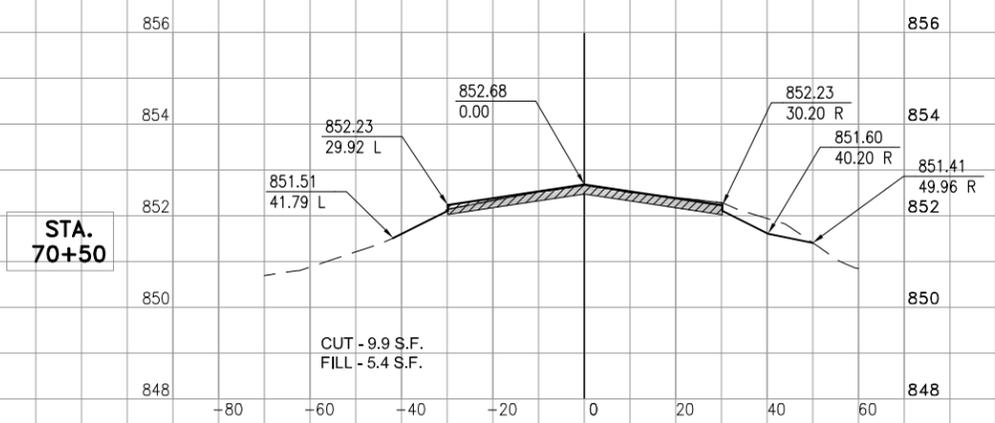

**REHABILITATE RUNWAY
1-19**

IDA No: EZI-4673
SBGP No: 3-17-SBGP-TBD

Contract No.: KE016

NO.	DATE	DESCRIPTION		
		LAY	DWN	REV

ISSUE: JUNE 8, 2018
PROJECT NO: 18A008
CAD FILE: 31-SECTIONS.DWG
LAYOUT BY: LDH 4/4/18
DRAWN BY: LDH 4/4/18
REVIEWED BY: KMS 4/30/18
© Copyright Hanson Professional Services Inc. 2013
SHEET TITLE

**CROSS SECTIONS
STA. 69+50 THRU
STA. 72+00**



MILLING
 BITUMINOUS OVERLAY

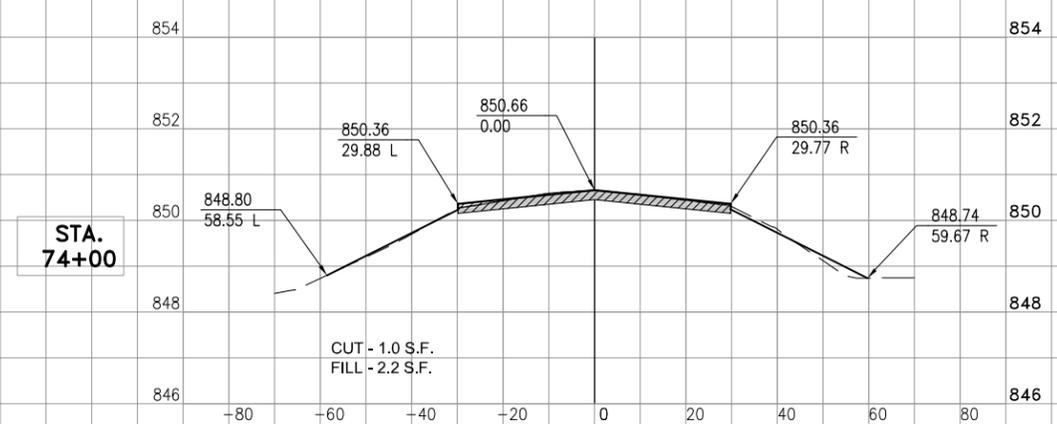
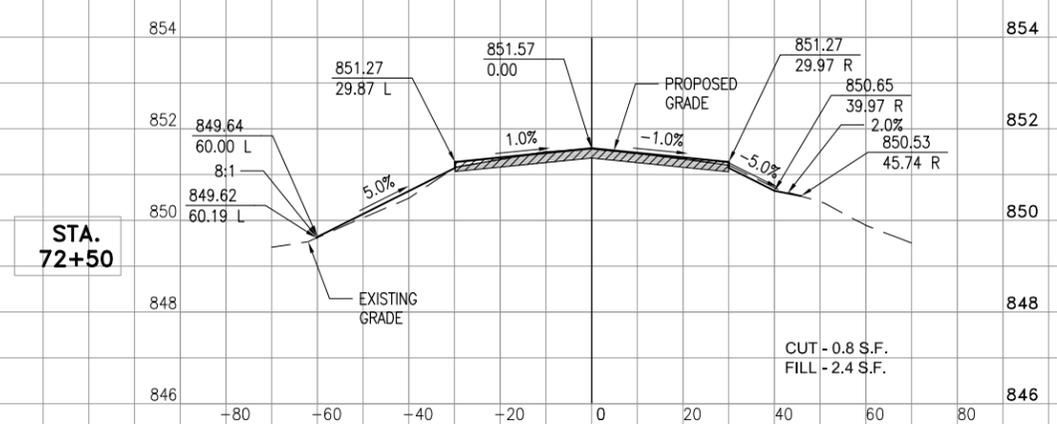
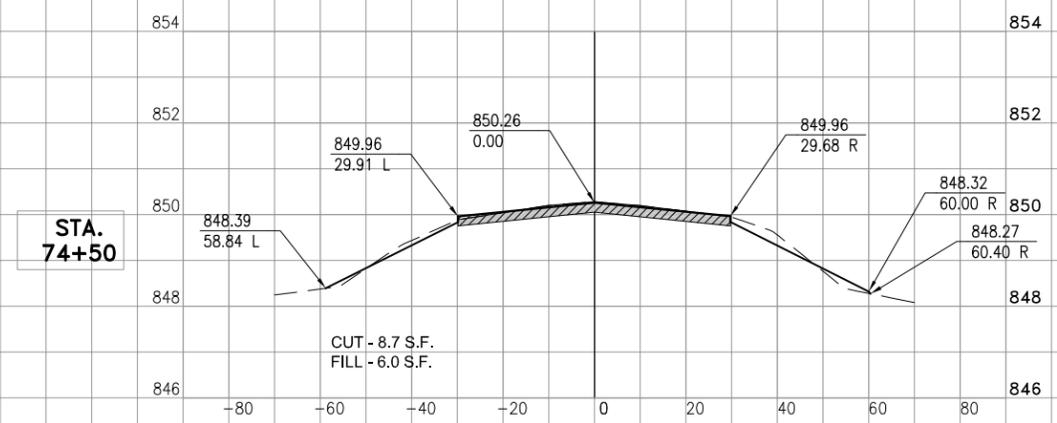
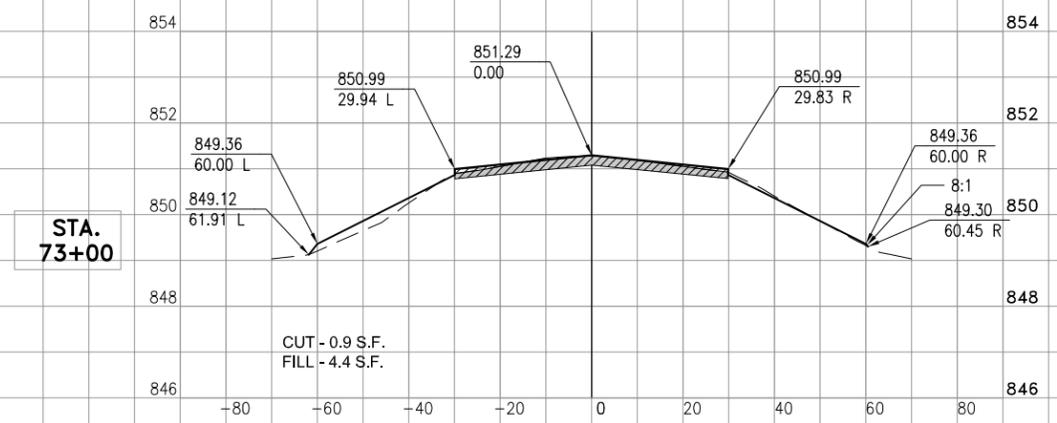
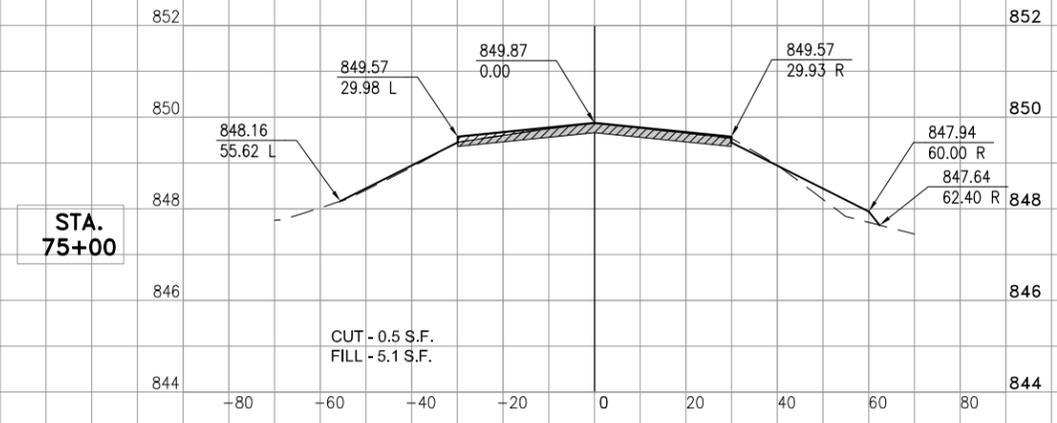
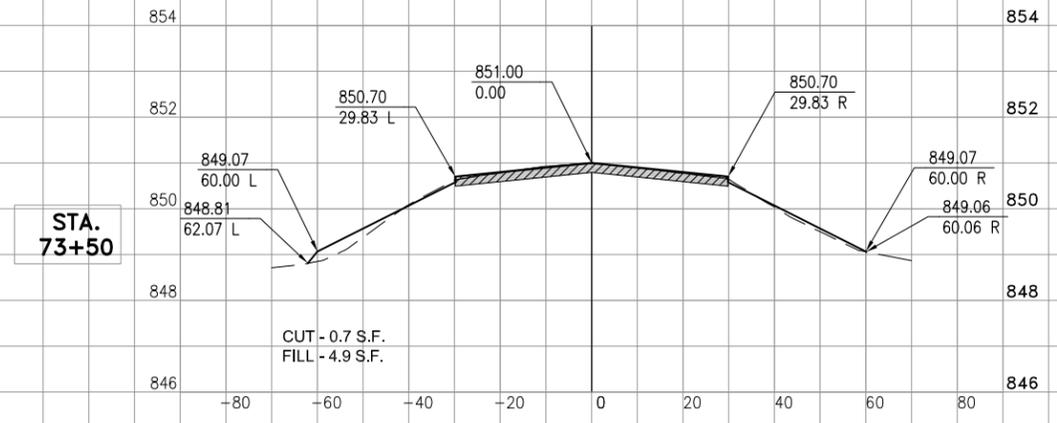

REHABILITATE RUNWAY
1-19

IDA No: EZI-4673
SBGP No: 3-17-SBGP-TBD

Contract No.: KE016

NO.	DATE	DESCRIPTION		
		LAY	DWN	REV

ISSUE: JUNE 8, 2018
PROJECT NO: 18A0008
CAD FILE: 32-SECTIONS.DWG
LAYOUT BY: LDH 4/4/18
DRAWN BY: LDH 4/4/18
REVIEWED BY: KMS 4/30/18
SHEET TITLE

CROSS SECTIONS
STA. 72+50 THRU
STA. 75+00

MILLING
 BITUMINOUS OVERLAY

REHABILITATE RUNWAY
1-19

IDA No: EZI-4673
SBGP No: 3-17-SBGP-TBD

Contract No.: KE016

NO.	DATE	DESCRIPTION		
		LAY	DWN	REV

ISSUE: JUNE 8, 2018
PROJECT NO: 18A0008
CAD FILE: 33-SECTIONS.DWG
LAYOUT BY: LDH 4/4/18
DRAWN BY: LDH 4/4/18
REVIEWED BY: KMS 4/30/18

© Copyright Hanson Professional Services Inc. 2013
SHEET TITLE

CROSS SECTIONS
STA. 75+50 THRU
STA. 78+00

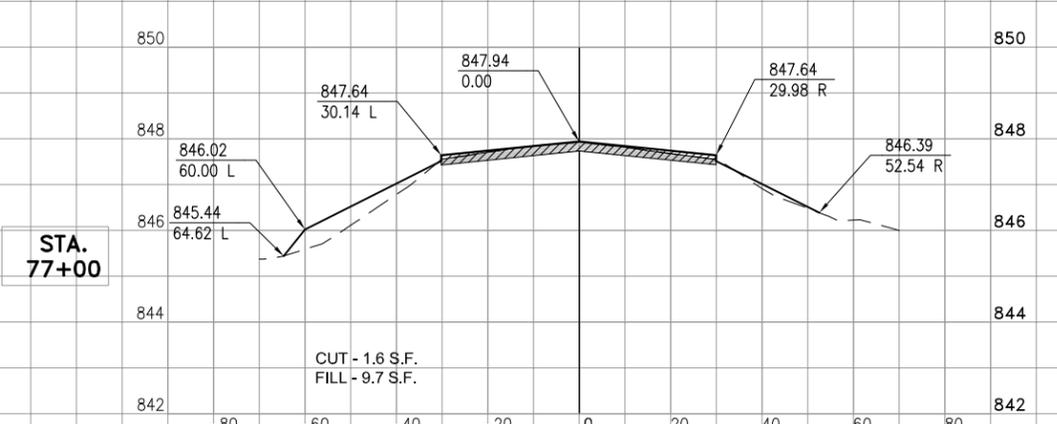
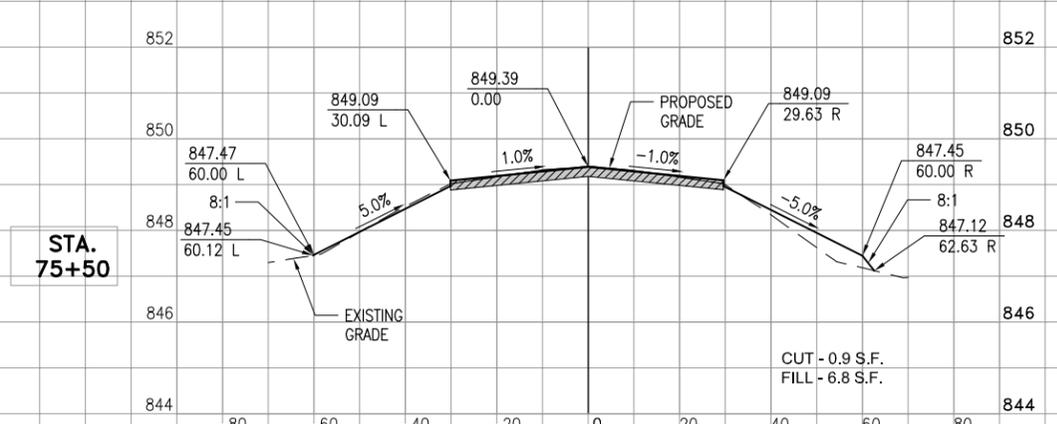
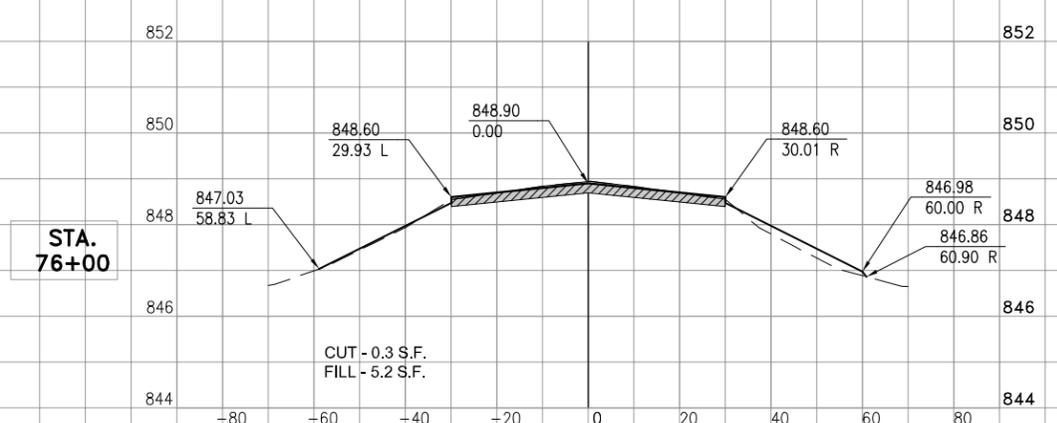
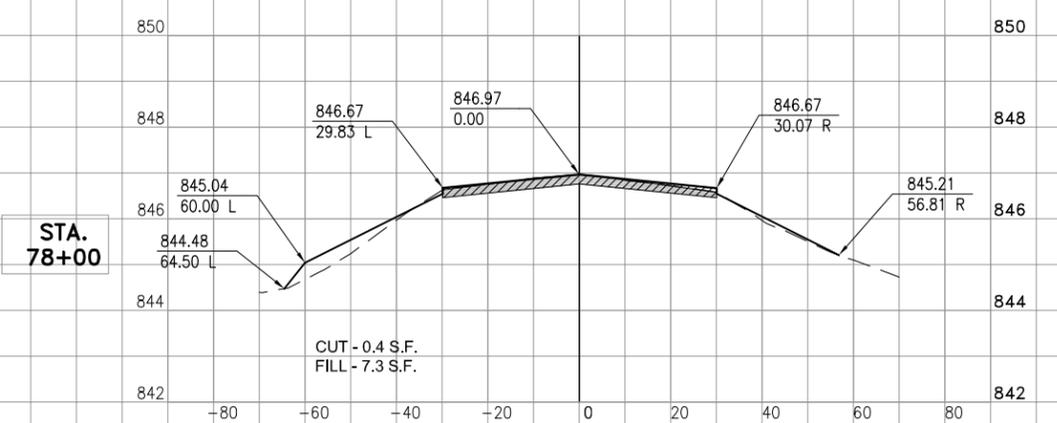
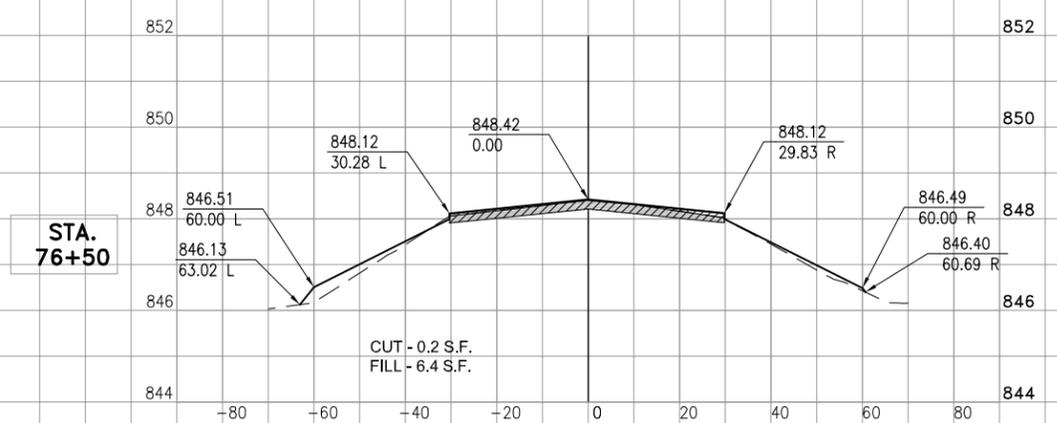



MILLING
 BITUMINOUS OVERLAY

REHABILITATE RUNWAY 1-19

IDA No: EZI-4673
SBGP No: 3-17-SBGP-TBD

Contract No.: KE016

NO.	DATE	DESCRIPTION		
		LAY	DWN	REV

ISSUE: JUNE 8, 2018
PROJECT NO: 18A0008
CAD FILE: 34-SECTIONS.DWG
LAYOUT BY: LDH 4/4/18
DRAWN BY: LDH 4/4/18
REVIEWED BY: KMS 4/30/18
© Copyright Hanson Professional Services Inc. 2013
SHEET TITLE

**CROSS SECTIONS
STA. 78+50 THRU
STA. 81+00**

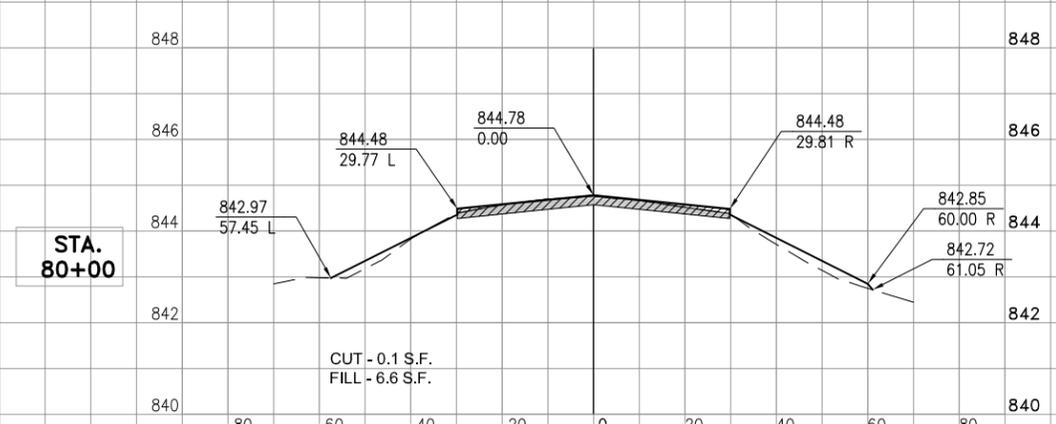
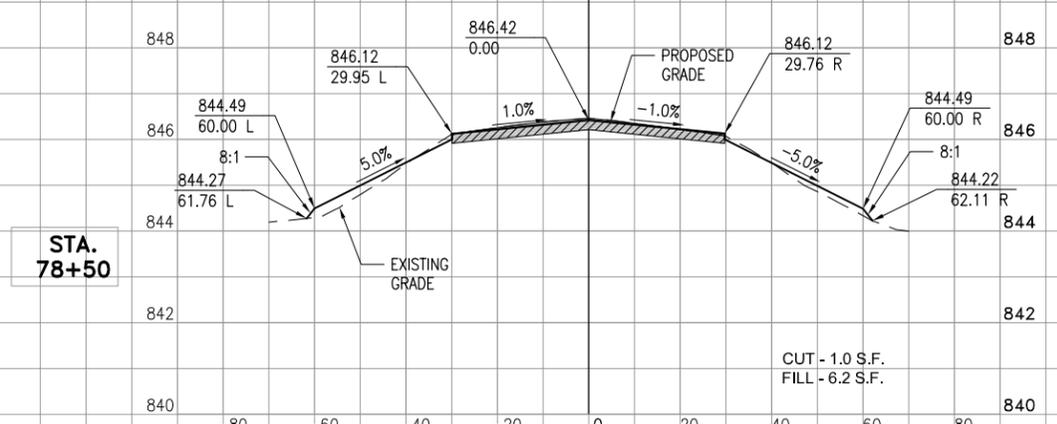
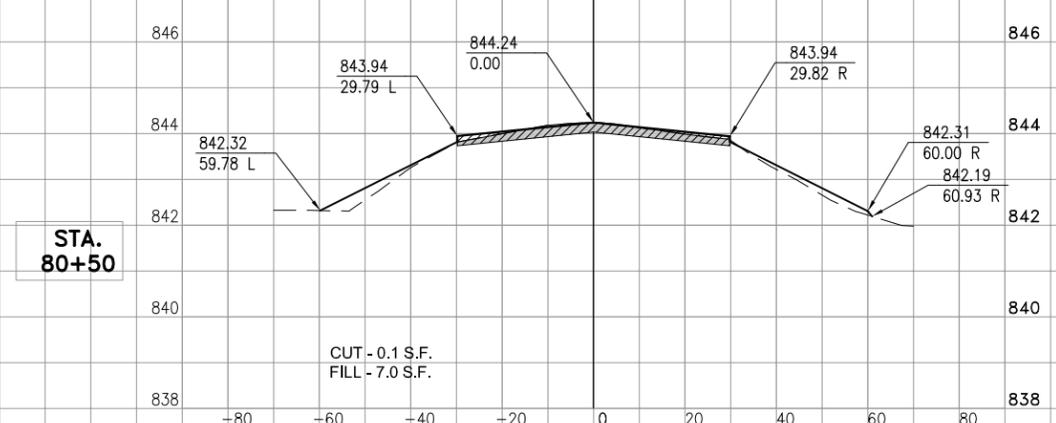
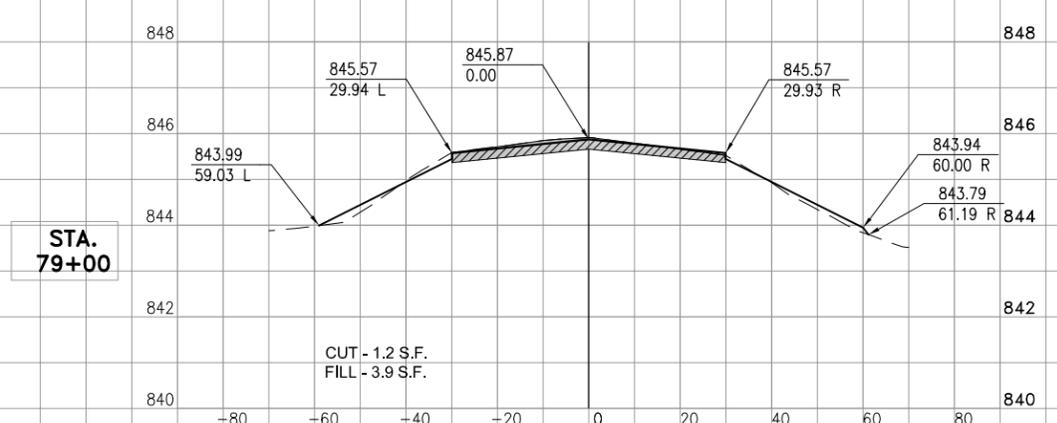
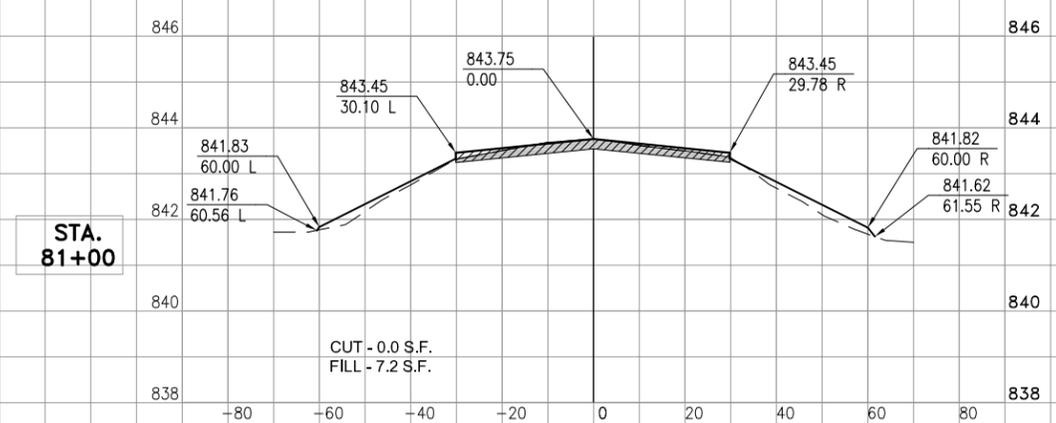
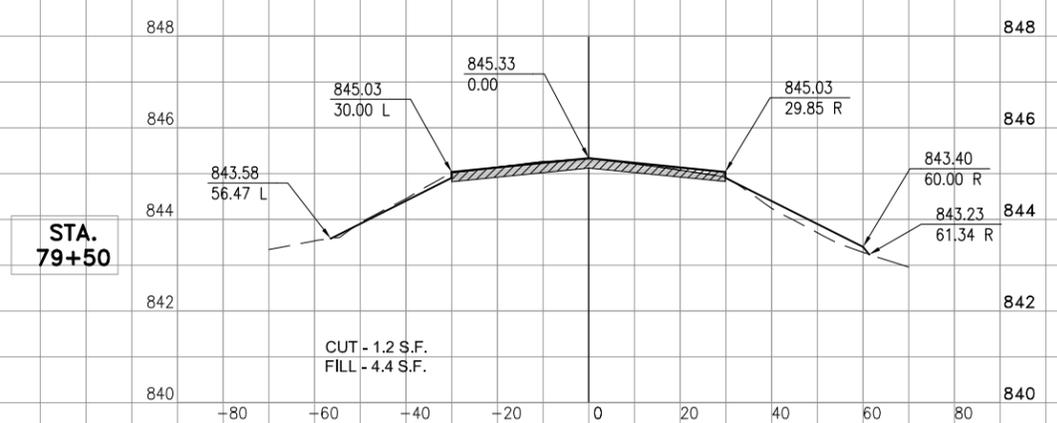



MILLING
 BITUMINOUS OVERLAY

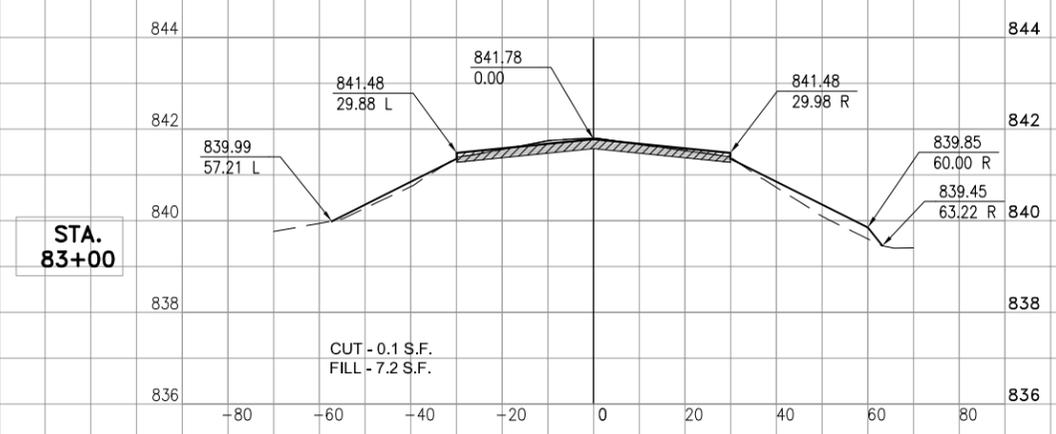
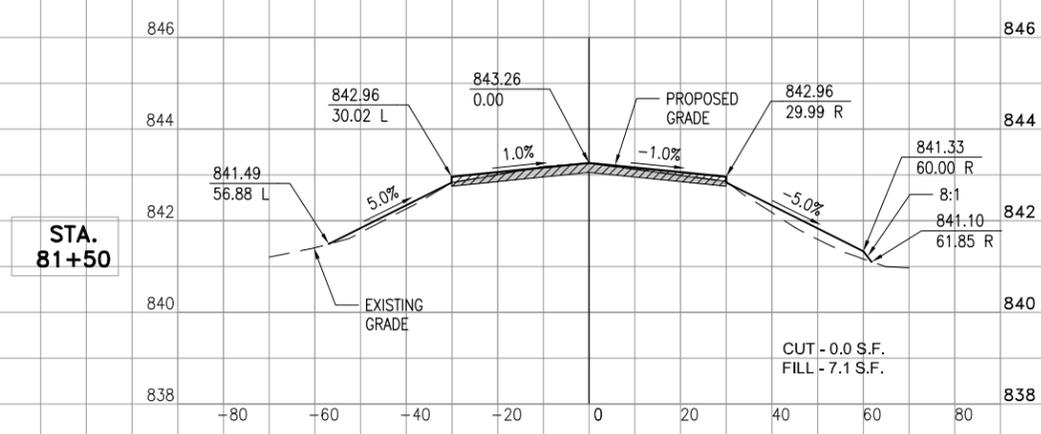
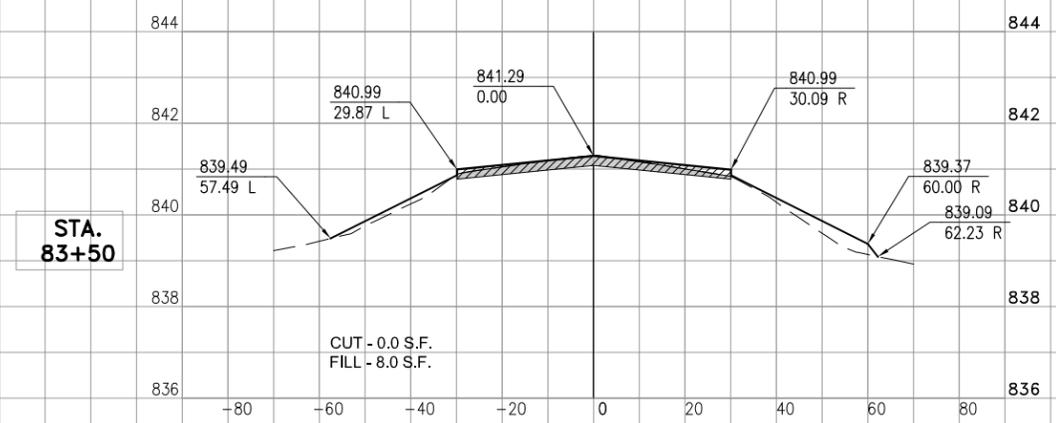
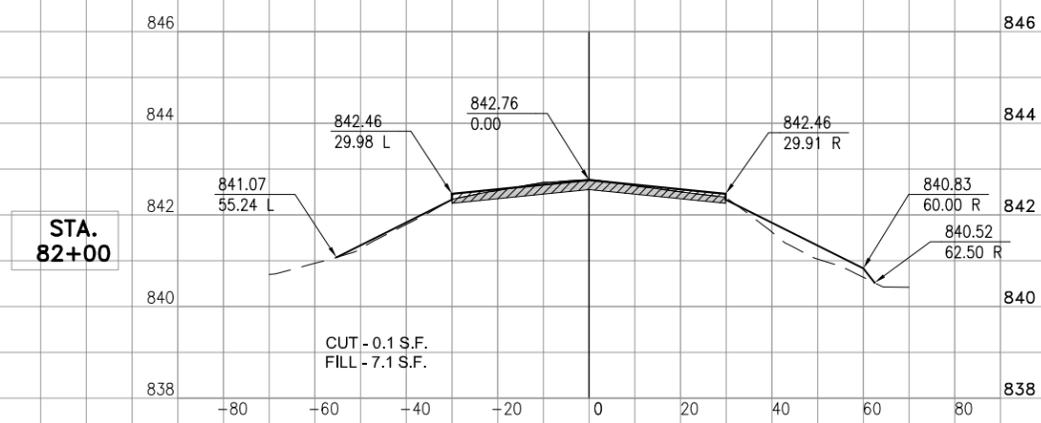
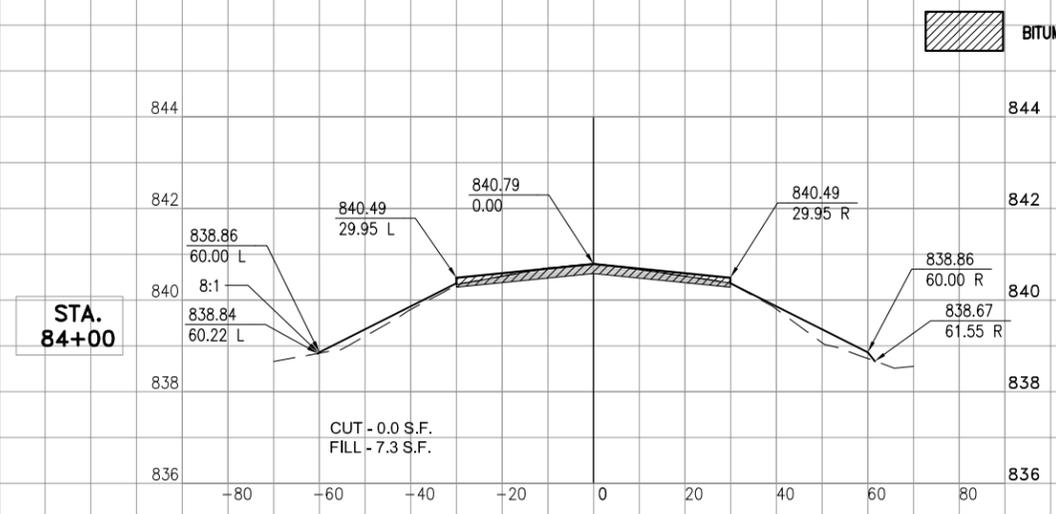
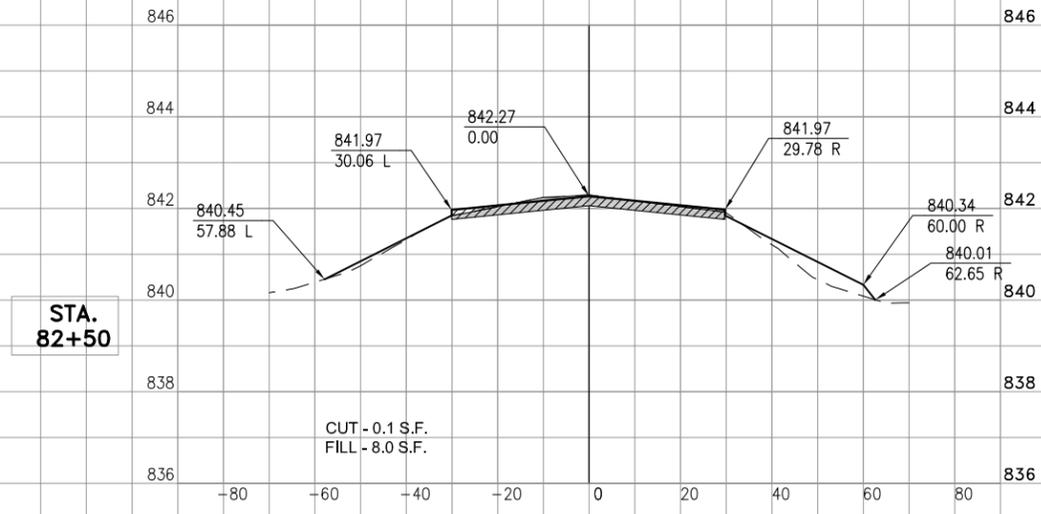

REHABILITATE RUNWAY
1-19

IDA No: EZI-4673
SBGP No: 3-17-SBGP-TBD

Contract No.: KE016

NO.	DATE	DESCRIPTION		
		LAY	DWN	REV

ISSUE: JUNE 8, 2018
PROJECT NO: 18A0008
CAD FILE: 35-SECTIONS.DWG
LAYOUT BY: LDH 4/4/18
DRAWN BY: LDH 4/4/18
REVIEWED BY: KMS 4/30/18
SHEET TITLE

CROSS SECTIONS
STA. 81+50 THRU
STA. 84+00

MILLING
 BITUMINOUS OVERLAY

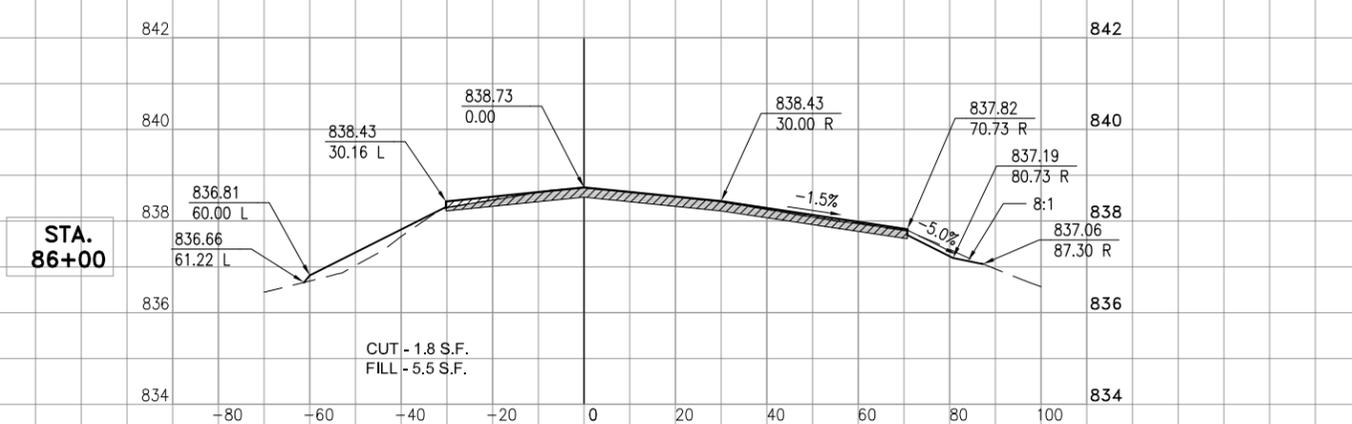
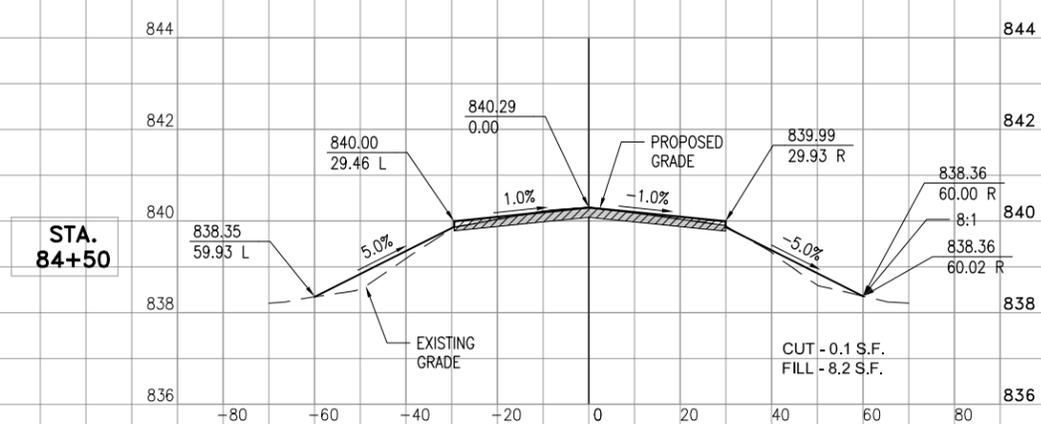
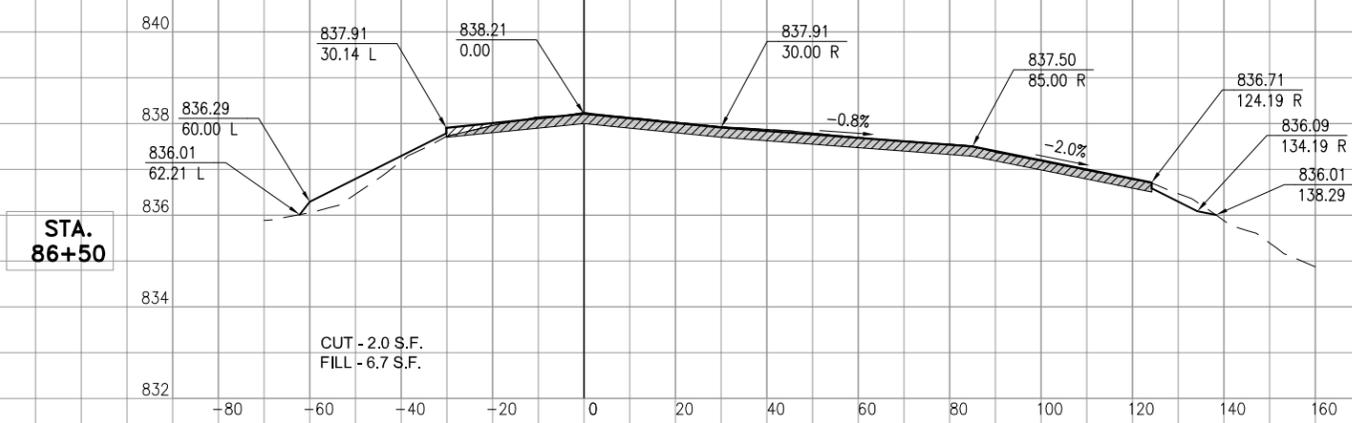
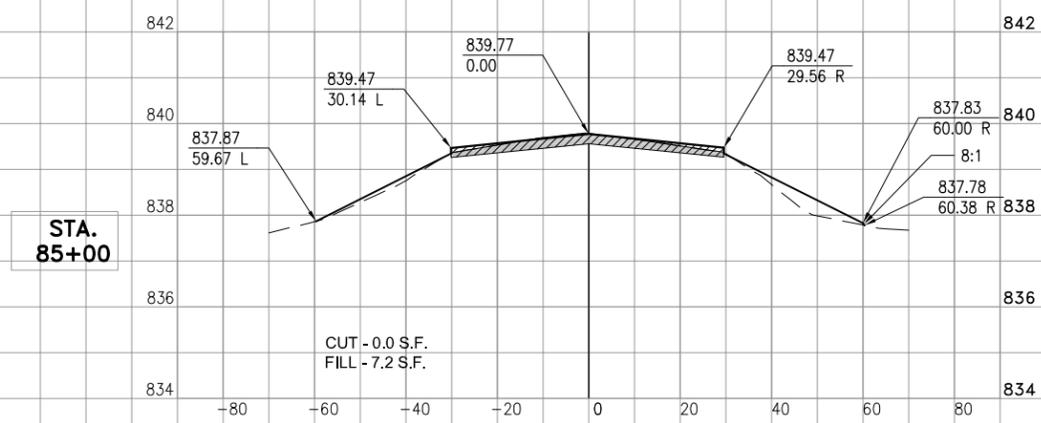
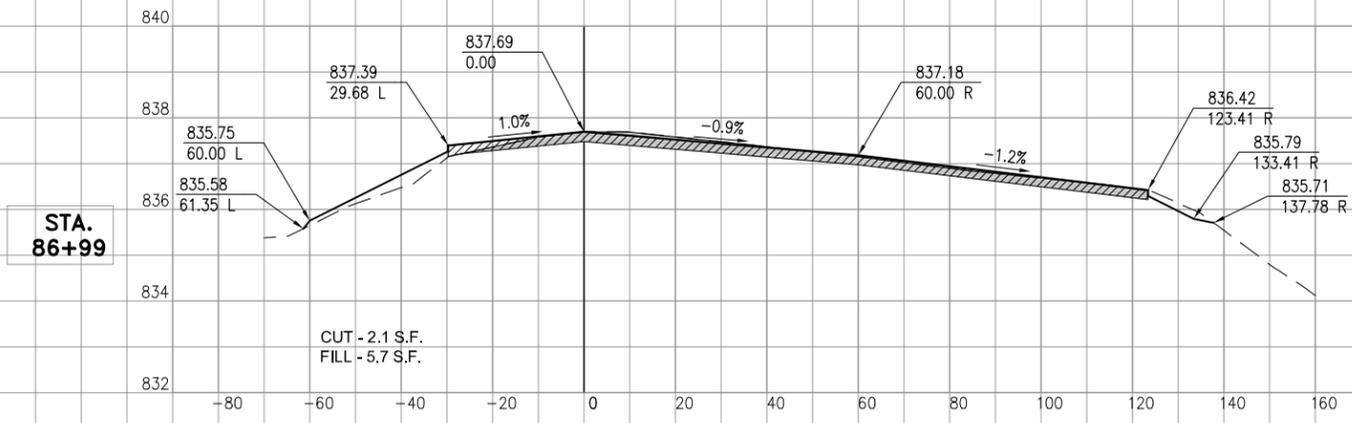
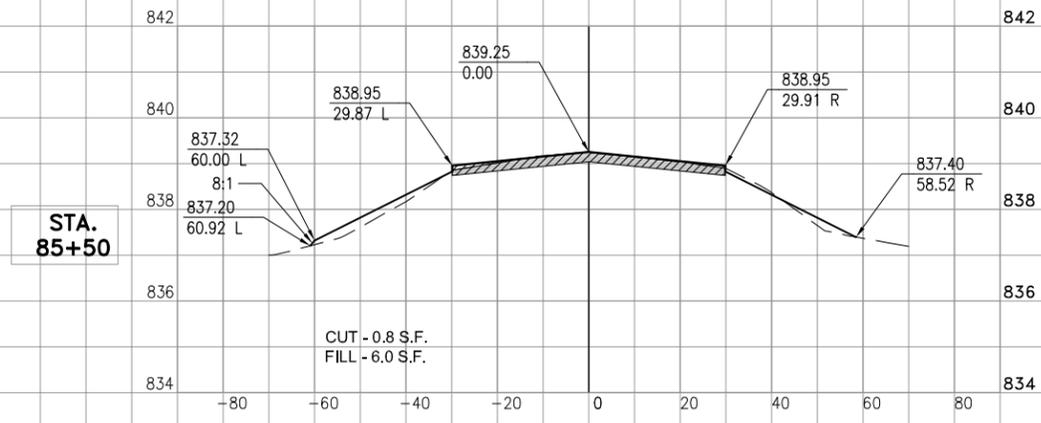

REHABILITATE RUNWAY
1-19

IDA No: EZI-4673
SBGP No: 3-17-SBGP-TBD

Contract No.: KE016

NO.	DATE	DESCRIPTION		
		LAY	DWN	REV

ISSUE: JUNE 8, 2018
PROJECT NO: 18A0008
CAD FILE: 36-SECTIONS.DWG
LAYOUT BY: LDH 4/4/18
DRAWN BY: LDH 4/4/18
REVIEWED BY: KMS 4/30/18
SHEET TITLE

CROSS SECTIONS
STA. 84+50 THRU
STA. 86+99



NOTES:

1. GLASS SPHERES SHALL BE USED FOR ALL WHITE AND YELLOW MARKINGS. GLASS SPHERES NOT REQUIRED FOR BLACK MARKING.
2. WATERBORNE MARKING SHALL BE USED ON BITUMINOUS PAVEMENT.
3. BLACK BORDER REQUIRED AROUND ALL PAVEMENT MARKINGS.

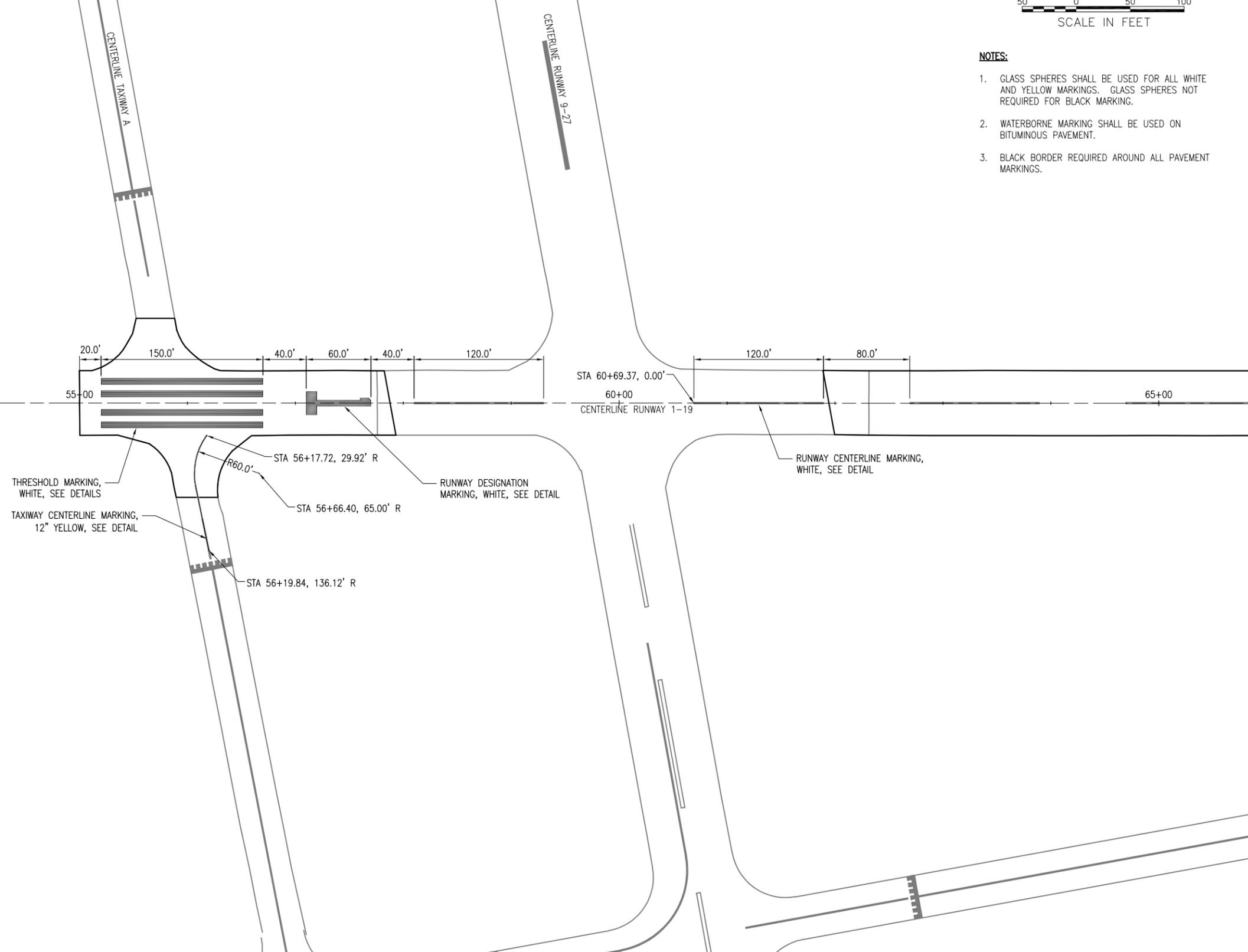

REHABILITATE RUNWAY 1-19

IDA No: EZI-4673
SBGP No: 3-17-SBGP-TBD

Contract No.: KE016

NO.	DATE	DESCRIPTION		
		LAY	DWN	REV

ISSUE: JUNE 8, 2018
PROJECT NO: 18A0008
CAD FILE: 37-MARKING.DWG
LAYOUT BY: LDH 4/5/18
DRAWN BY: LDH 4/5/18
REVIEWED BY: KMS 4/30/18

© Copyright Hanson Professional Services Inc. 2013
SHEET TITLE

MARKING PLAN 1

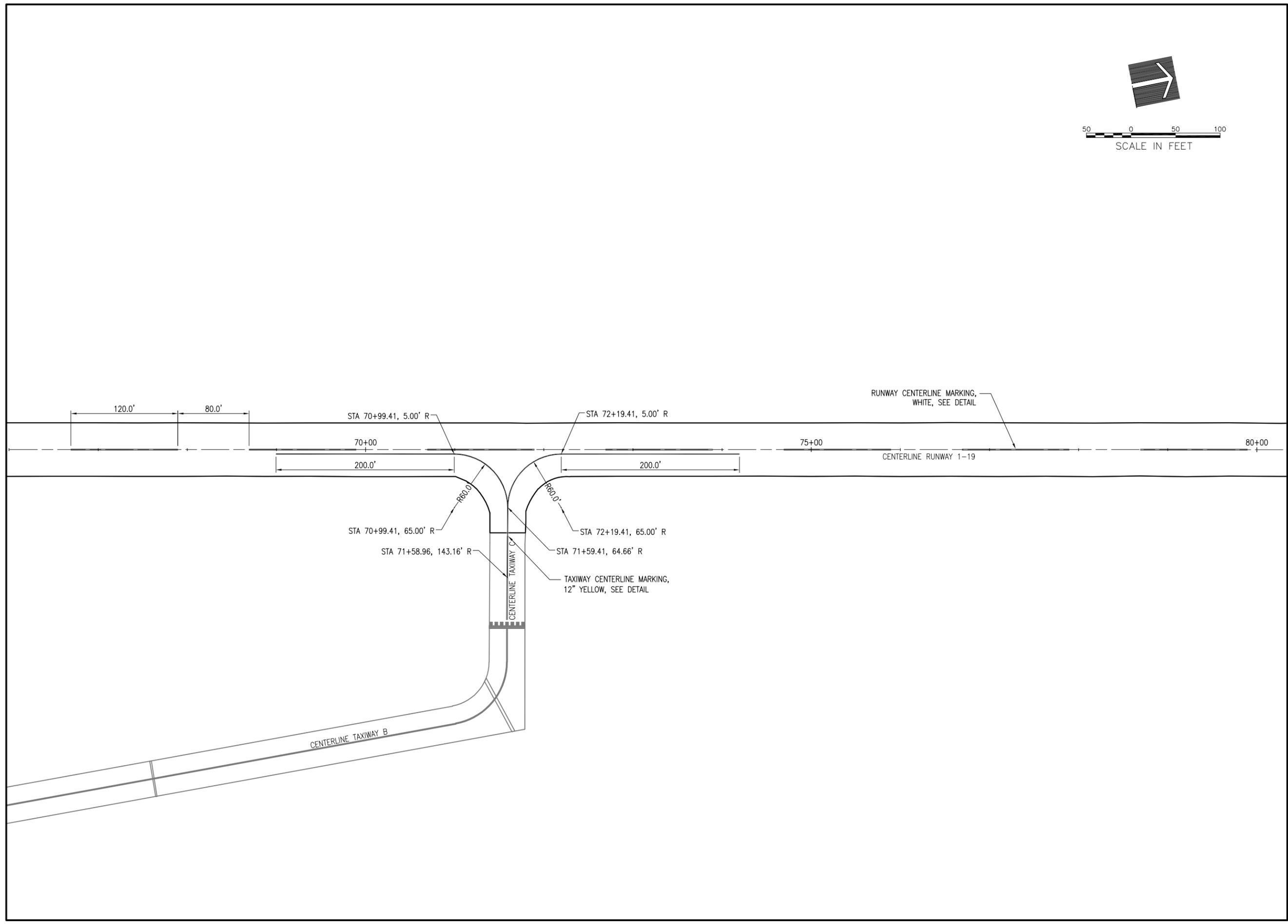
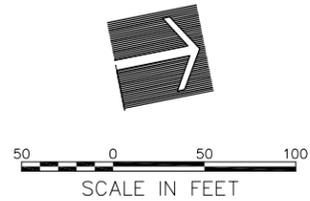

REHABILITATE RUNWAY 1-19

IDA No: EZI-4673
SBGP No: 3-17-SBGP-TBD

Contract No.: KE016

NO.	DATE	DESCRIPTION		
		LAY	DWN	REV

ISSUE: JUNE 8, 2018
PROJECT NO: 18A0008
CAD FILE: 38-MARKING.DWG
LAYOUT BY: LDH 4/5/18
DRAWN BY: LDH 4/5/18
REVIEWED BY: KMS 4/30/18
© Copyright Hanson Professional Services Inc. 2013
SHEET TITLE

MARKING PLAN 2

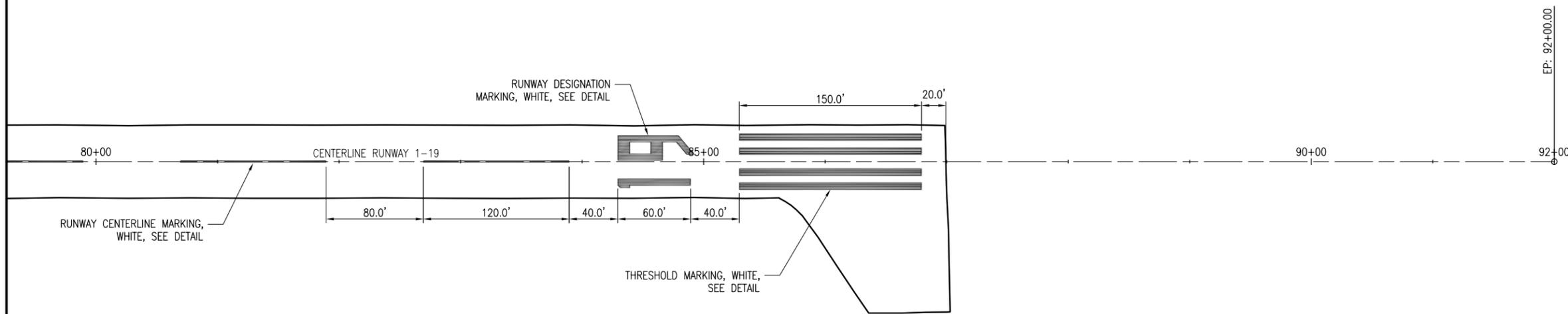
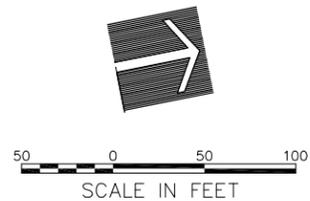

REHABILITATE RUNWAY 1-19

IDA No: EZI-4673
SBGP No: 3-17-SBGP-TBD

Contract No.: KE016

NO.	DATE	DESCRIPTION		
		LAY	DWN	REV

ISSUE: JUNE 8, 2018
PROJECT NO: 18A0008
CAD FILE: 39-MARKING.DWG
LAYOUT BY: LDH 4/5/18
DRAWN BY: LDH 4/5/18
REVIEWED BY: KMS 4/30/18

© Copyright Hanson Professional Services Inc. 2013
SHEET TITLE

MARKING PLAN 3

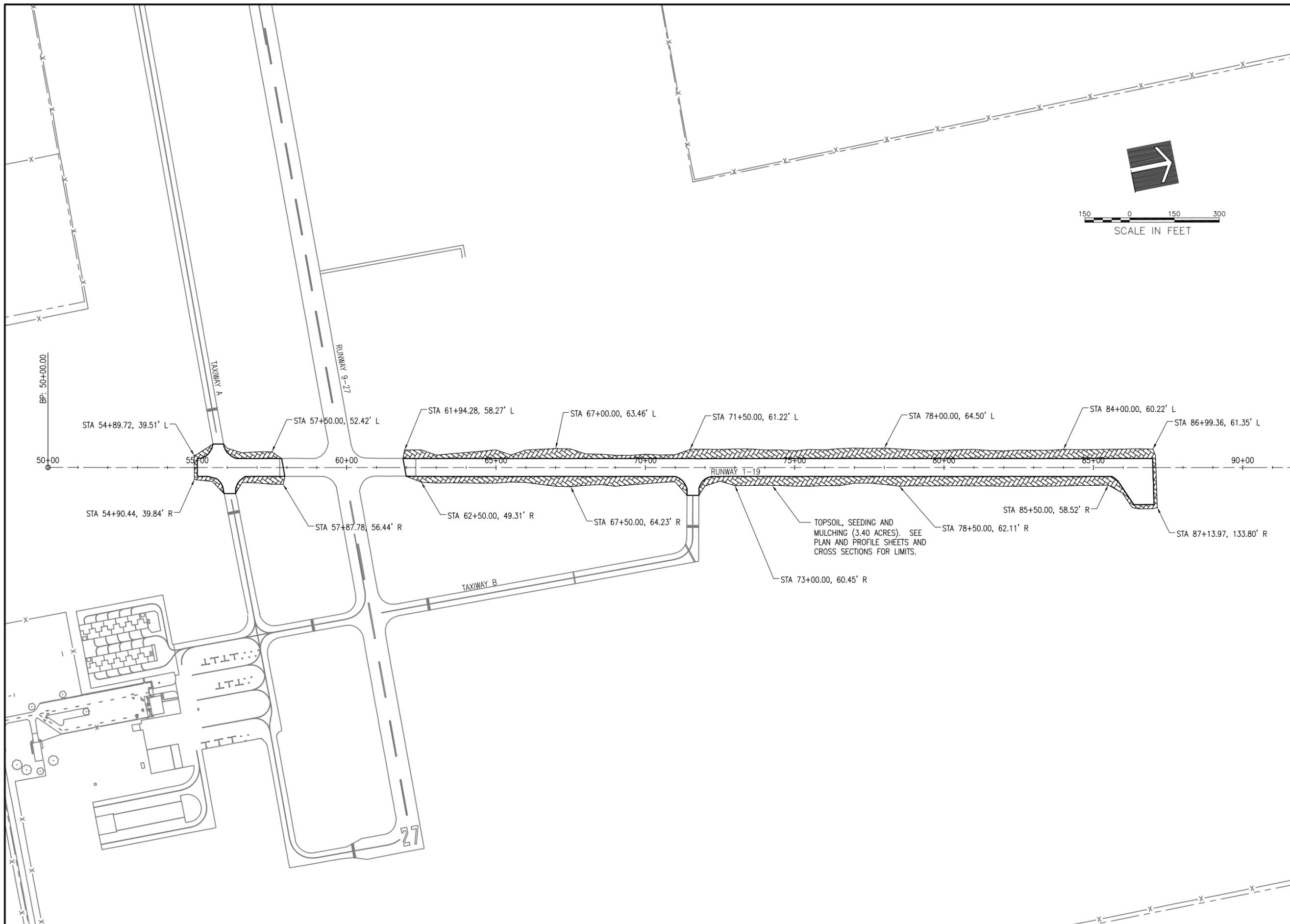
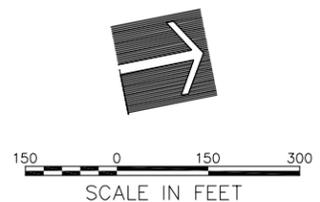

REHABILITATE RUNWAY 1-19

IDA No: EZI-4673
SBGP No: 3-17-SBGP-TBD

Contract No.: KE016

NO.	DATE	DESCRIPTION		
		LAY	DWN	REV

ISSUE: JUNE 8, 2018
PROJECT NO: 18A0008
CAD FILE: 41-LANDSCAPING.DWG
LAYOUT BY: LDH 4/25/18
DRAWN BY: LDH 4/25/18
REVIEWED BY: KMS 4/30/18
© Copyright Hanson Professional Services Inc. 2013
SHEET TITLE

LANDSCAPING PLAN