

F.A. RTE.	SECTION	COUNTY	TOTAL SHEETS	SHEET NO.
		COOK	17	1

STATE OF ILLINOIS  
DEPARTMENT OF TRANSPORTATION  
DIVISION OF HIGHWAYS  
**IDOT /IHPA STATEWIDE  
PULLMAN STATE HISTORICAL SITE**

**PARK ROAD AND PATHWAY IMPROVEMENTS 2006  
COOK COUNTY  
JOB NO. C-30-012-06  
SECTION: PULLMAN HISTORIC SITE**

**INDEX OF SHEETS**

- 1 COVER SHEET
- 2 TYPICAL SECTIONS, GATE DETAILS & LEGEND
- 3 SURVEY TIES, BENCHMARKS & GENERAL NOTES
- 4-5 SUMMARY AND SCHEDULE OF QUANTITIES
- 6 REMOVAL PLAN
- 7-8 PROPOSED PLAN
- 9-10 PROPOSED STAKING LAYOUT PLAN
- 11 PROPOSED WATER MAIN PLAN
- 12 LAWN PLANTING PLAN
- 13-14 LANDSCAPING PLANS
- 15 LANDSCAPING DETAILS
- 16-17 LANDSCAPING NOTES

**STATE STANDARDS**

- 000001-04
- 280001-02
- 424001-04
- 701606-04
- 701801-03
- 702001-06



PROJECT ENGINEER: LANCE KIDD (217) 785-2933

R. 14 E.

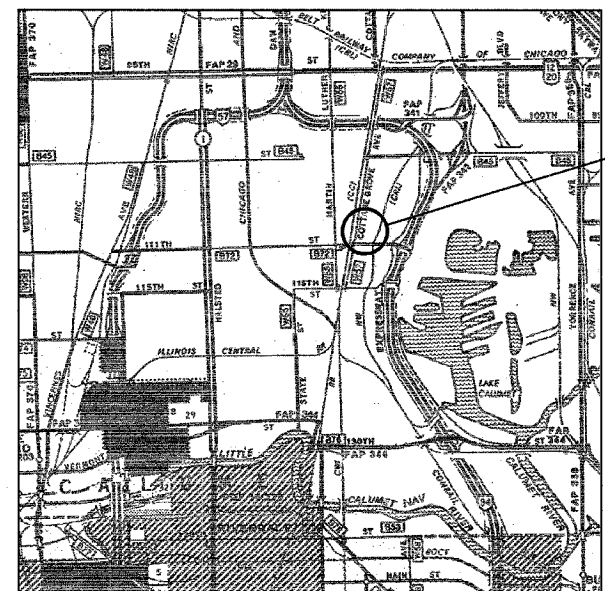

PULLMAN STATE HISTORICAL SITE

T. 37 N.

**LOCATION MAP**

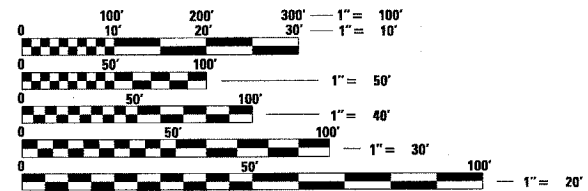
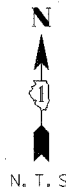

FULL SIZE PLANS HAVE BEEN PREPARED USING STANDARD ENGINEERING SCALES. REDUCED SIZED PLANS WILL NOT CONFORM TO STANDARD SCALES. IN MAKING MEASUREMENTS ON REDUCED PLANS, THE ABOVE SCALES MAY BE USED.

J.U.L.I.E.  
JOINT UTILITY LOCATION INFORMATION FOR EXCAVATION  
1-800-892-0123

**CONTRACT NO. 44917**



*Philip Malone 3/1/06*  
SIGNATURE

EXPIRATION DATE NOV. 30, 2007

STATE OF ILLINOIS  
DEPARTMENT OF TRANSPORTATION  
DIVISION OF HIGHWAYS

SUBMITTED 05/25/2006  
Steve D'Amico - IHPA - Historical Sites  
DEPUTY DIRECTOR OF HIGHWAYS, REGION ENGINEER

Mike Hines  
ENGINEER OF DESIGN AND ENVIRONMENT

May 12, 2006  
Milton R. Sees, P.E.  
DIRECTOR OF HIGHWAYS, CHIEF ENGINEER

**PRINTED BY THE AUTHORITY  
OF THE STATE OF ILLINOIS**

F.A. RTE.	SECTION	COUNTY	TOTAL SHEETS	SHEET NO.
		COOK	17	2
STA.		TO STA.		
FED. ROAD DIST. NO.	ILLINOIS	FED. AID PROJECT		
CONTRACT NO. 44917				

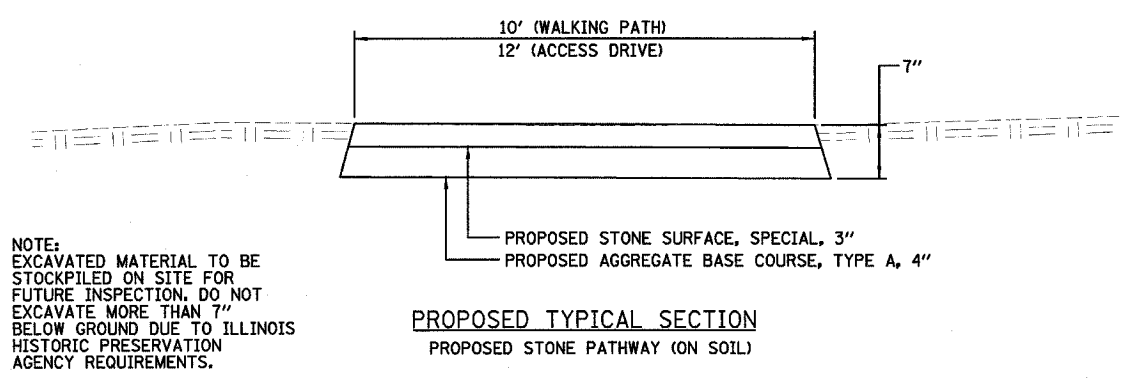

NOTE:  
EXCAVATED MATERIAL TO BE STOCKPILED ON SITE FOR FUTURE INSPECTION. DO NOT EXCAVATE MORE THAN 7" BELOW GROUND DUE TO ILLINOIS HISTORIC PRESERVATION AGENCY REQUIREMENTS.

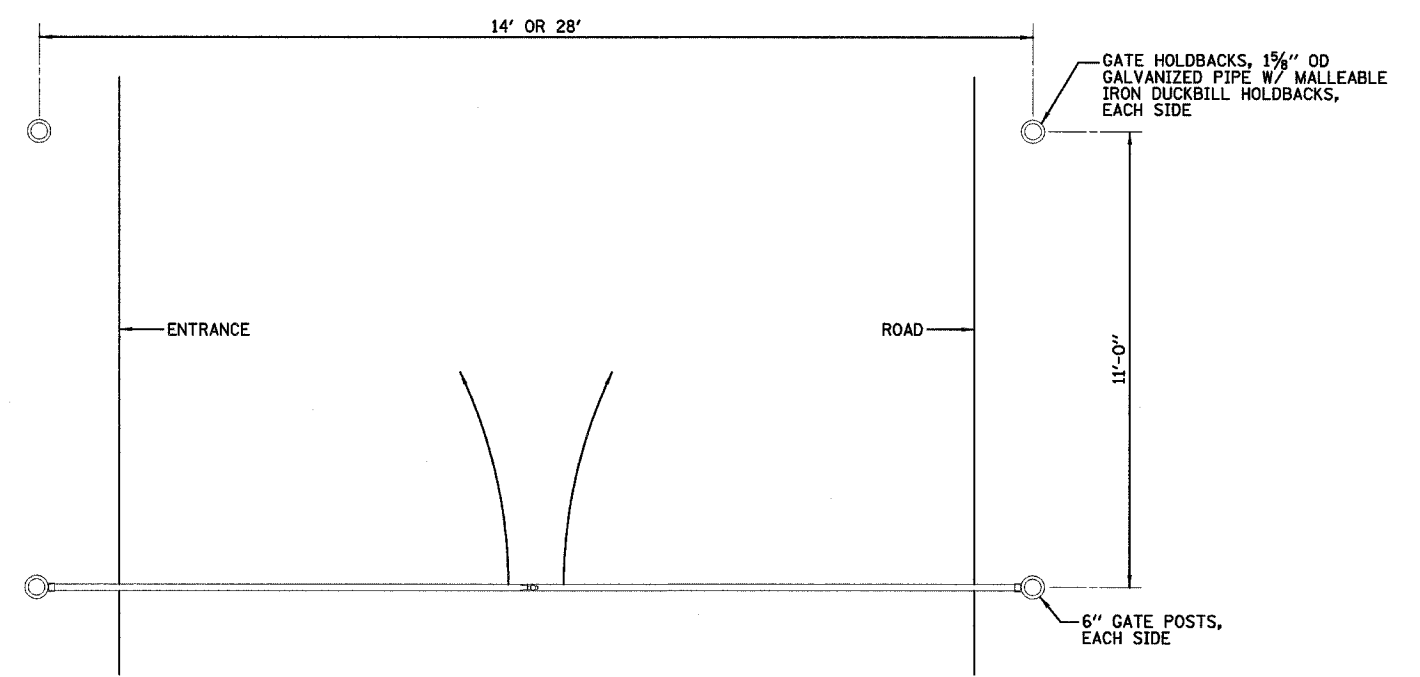
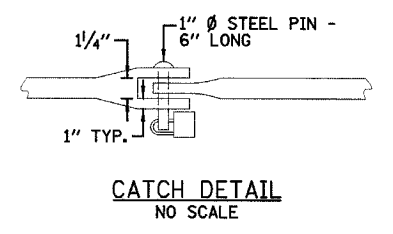
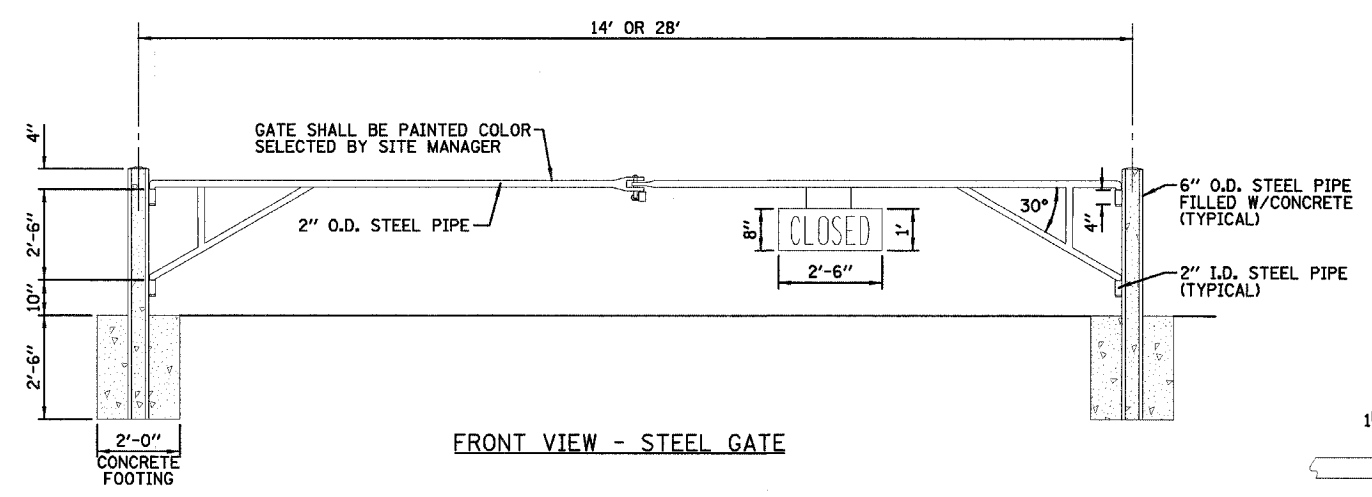
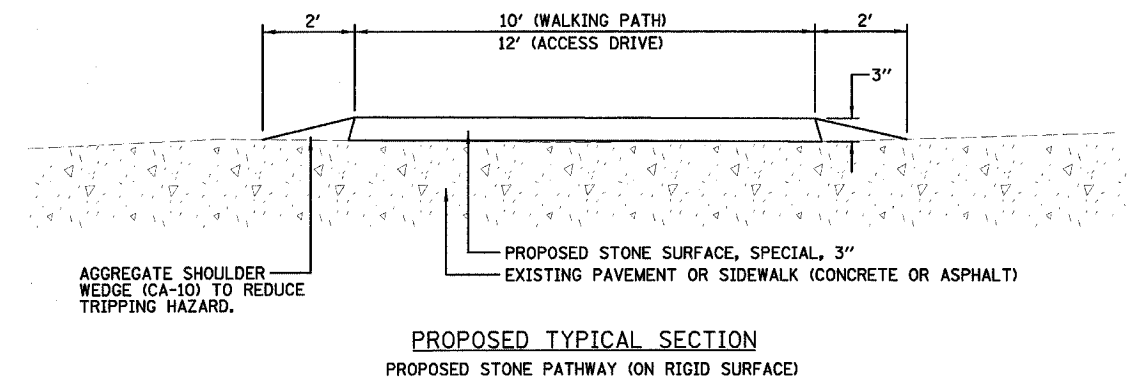

**TOP VIEW - STEEL GATE**

**METAL GATE**  
NO SCALE

REVISIONS	
NAME	DATE

ILLINOIS DEPARTMENT OF TRANSPORTATION  
TYPICAL SECTIONS, GATE DETAILS  
AND LEGEND  
IDOT / IHPA  
PULLMAN STATE HISTORIC SITE

SCALE: VERT. HORIZ.  
DATE: 11/08/05

DRAWN BY: DJM  
CHECKED BY: PJM

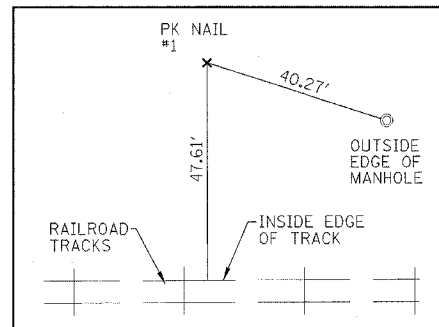

**CONTROL PT #1**  
(PK NAIL)  
N10000.020  
E10000.001  
ELEV=97.17

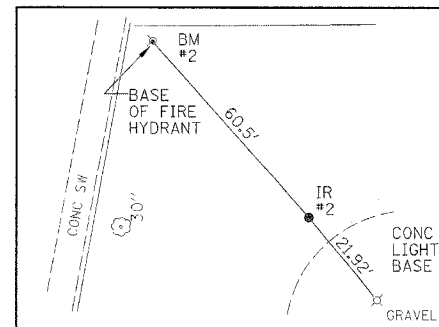

**CONTROL PT #2**  
(IRON ROD)  
N10752.413  
E10020.798  
ELEV=97.11

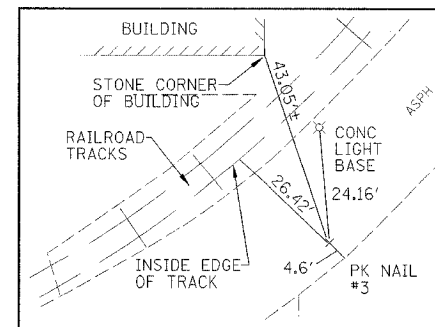

**CONTROL PT #3**  
(PK NAIL)  
N9989.810  
E10421.806  
ELEV=97.54

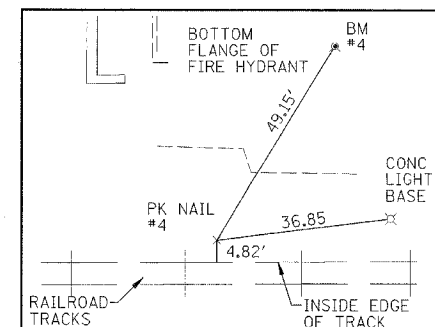

**CONTROL PT #4**  
(PK NAIL)  
N10248.978  
E10165.146  
ELEV=97.15

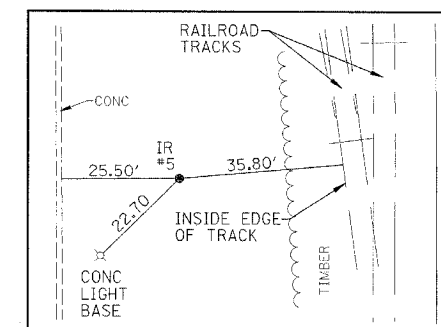

**CONTROL PT #5**  
(IRON ROD)  
N10271.111  
E10439.198  
ELEV=97.30

BENCHMARK LOCATIONS		
NUMBER	DESCRIPTION	ELEVATION
①	TOP FIRE HYDRANT NE CORNER OF E. 111TH ST & S. COTTAGE GROVE AVE	ASSUMED 100.00
②	TOP FIRE HYDRANT NW CORNER OF SITE (INSIDE FENCE)	99.80
③	TOP FIRE HYDRANT E SIDE NORTH BUILDING 150± S OF NE CORNER OF BUILDING	100.34
④	TOP FIRE HYDRANT 60'± E OF SE CORNER OF NORTH BUILDING	100.25

**GENERAL NOTES**

- 1.) THE CONTRACTOR SHALL COMPLY WITH ALL APPLICABLE AND GENERAL CONDITIONS FOR BOTH THE ILLINOIS DEPARTMENT OF TRANSPORTATION (IDOT) AND THE CITY OF CHICAGO.
- 2.) THE CONTRACTOR SHALL OBTAIN ALL PERMITS NECESSARY TO COMPLETE THE WORK AND SHALL COORDINATE WITH BOTH IDOT AND THE APPROPRIATE DEPARTMENT WITH THE CITY OF CHICAGO.
- 3.) THE CONTRACTOR SHALL NOTIFY THE SITE MANAGER, MR. MIKE WAGENBACH, AT 773-660-2341, FORTY-EIGHT HOURS PRIOR TO MAKING ANY EXCAVATIONS ON THE PROJECT SITE. THE SITE MANAGER DESIRES TO OBSERVE ANY EXCAVATIONS AND DOCUMENT ANY ARTIFACTS UNCOVERED DURING SAME.

BITUMINOUS TABLE			
MIXTURE USE (S):	SURFACE	LEVELING BINDER	BINDER
PG	58-22	58-22	58-22
RAP % (MAX)	15	25	30
DESIGN AIR VOIDS	4.2	4.2	4.2
MIXTURE COMPOSITION (GRADATION MIXTURE)	IL 9.5	IL 9.5	IL 19.0
FRICTION AGGREGATE	MIX C	N/A	N/A
20 YEAR ESAL	N30	N30	N30

APPLICATION RATES	
BITUMINOUS MATERIALS (PRIME COAT) MC-30	0.40 GAL/SY
BITUMINOUS MATERIALS (PRIME COAT) RC-70	0.10 GAL/SY
BITUMINOUS CONCRETE BINDER COURSE	112 LB/IN/SY
BITUMINOUS CONCRETE SURFACE COURSE	112 LB/IN/SY
GRANULAR MATERIALS	2.05 TONS/CY
NITROGEN FERTILIZER NUTRIENT	90 LB/ACRE
PHOSPHERUS FERTILIZER NUTRIENT	90 LB/ACRE
POTASSIUM FERTILIZER NUTRIENT	90 LB/ACRE
MULCH METHOD 1	2 TONS/ACRE

REVISIONS	
NAME	DATE

ILLINOIS DEPARTMENT OF TRANSPORTATION  
SURVEY TIES, BENCHMARKS  
AND GENERAL NOTES  
IDOT / IHPA  
PULLMAN STATE HISTORIC SITE

SCALE: VERT.  
HORIZ.  
DATE: 11/08/05

DRAWN BY: DJM  
CHECKED BY: PJM

SUMMARY OF QUANTITIES

URBAN  
100% STATE  
1081

CODE NO.	ITEM	UNIT	TOTAL
20100110	TREE REMOVAL (6 TO 15 UNITS DIAMETER)	UNIT	20
20100500	TREE REMOVAL, ACRES	ACRE	0.5
20200100	EARTH EXCAVATION	CU YD	995
20200410	EARTH EXCAVATION (SPECIAL)	CU YD	50
20800150	TRENCH BACKFILL	CU YD	100
21101615	TOPSOIL FURNISH AND PLACE, 4"	SQ YD	17,260
25000400	NITROGEN FERTILIZER NUTRIENT	POUND	270
25000500	PHOSPHORUS FERTILIZER NUTRIENT	POUND	270
25000600	POTASSIUM FERTILIZER NUTRIENT	POUND	270
25000900	SEEDING, CLASS 1 (SPECIAL)	ACRE	1.7
25001750	SEEDING, CLASS 4 (SPECIAL)	ACRE	0.9
25001810	SEEDING, CLASS 5 (SPECIAL)	ACRE	0.4
25100110	MULCH, METHOD 1	TON	6.0
28000400	PERIMETER EROSION BARRIER	FOOT	1600
28000500	INLET AND PIPE PROTECTION	EACH	7
35100100	AGGREGATE BASE COURSE, TYPE A	TON	860
40600100	BITUMINOUS MATERIALS (PRIME COAT)	GALLON	80
40600980	BITUMINOUS SURFACE REMOVAL - BUTT JOINT	SQ YD	140
42000300	PORTLAND CEMENT CONCRETE PAVEMENT, 8"	SQ YD	15
42400100	PORTLAND CEMENT CONCRETE SIDEWALK, 4 INCH	SQ FT	175
44000200	DRIVEWAY PAVEMENT REMOVAL	SQ YD	75
44000600	SIDEWALK REMOVAL	SQ FT	1970
44001700	COMBINATION CONCRETE CURB AND GUTTER REMOVAL AND REPLACEMENT	FOOT	25
44200280	PAVEMENT PATCHING TYPE IV	SQ YD	25
48101200	AGGREGATE SHOULDERS TYPE B	TON	40
50102400	CONCRETE REMOVAL	CU YD	5
550A0050	STORM SEWERS, CLASS A, TYPE 1 12"	FOOT	52

SUMMARY OF QUANTITIES

F.A. RTE.	SECTION	COUNTY	TOTAL SHEETS	SHEET NO.
		COOK	17	4
STA.		TO STA.		
FED. ROAD DIST. NO.		ILLINOIS FED. AID PROJECT		
CONTRACT NO. 44917				
URBAN 100% STATE 1081				

CODE NO.	ITEM	UNIT	TOTAL
56103000	DUCTILE IRON WATER MAIN 6"	FOOT	115
56108800	TAPPING VALVES AND SLEEVES 6"	EACH	1
671000100	MOBILIZATION	L SUM	1
70102625	TRAFFIC CONTROL AND PROTECTION, STANDARD 701606	L SUM	1
70102640	TRAFFIC CONTROL AND PROTECTION, STANDARD 701801	L SUM	1
A2003120	TREE, CELTIS OCCIDENTALIS WINDY CITY (WINDY CITY HACKBERRY), 2 1/2" CALIPER, BALLED AND BURLAPPED	EACH	1
B2001167	TREE, CERCIS CANADENSIS (EASTERN REDBUD) 8' HEIGHT, BALLED AND BURLAPPED	EACH	1
B2001768	TREE, CRATAEGUS CRUS GALLI VAR. INERMIS "CRUSADER" (CRUSADER THORNLESS COCKSPUR HAWTHORN) 2" CALIPER, BALLED AND BURLAPPED	EACH	7
A2003920	TREE, FRAXINUS PENNSYLVANICA CIMARRON (CIMARRON <sup>GREEN</sup> ASH), 2 1/2" CALIPER, BALLED AND BURLAPPED	EACH	4
A2005616	TREE, OSTRYA VIRGINIANA ( <sup>AMERICAN HOPHORNBEAM</sup> ), 2" CALIPER, BALLED AND BURLAPPED	EACH	5
C2001049	SHRUB, CARYOPTERIS X CLANDONENSIS "ARTHUR SIMMONDS" (ARTHUR SIMMONDS BLUEBEARD), 1-GALLON	EACH	77
C2001120	SHRUB, CEANOTHUS AMERICANUS (NEW JERSEY TEA), CONTAINER GROWN, 3-GALLON	EACH	43
C2003422	SHRUB, HIBISCUS SYRIACUS "BLUE BIRD" (BLUE BIRD ROSE OF SHARON) 2-1/2' HEIGHT, BALLED AND BURLAPPED	EACH	10
C2004126	SHRUB, KOLKWITZIA AMABILIS "PINK CLOUD" (PINK CLOUD BEAUTY BUSH) 2' HEIGHT, BALLED AND BURLAPPED	EACH	11
C2005226	SHRUB, POTENTILLA FRUITICOSA "PINK BEAUTY", (PINK BEAUTY BUSH CINQUEFOIL), CONTAINER GROWN, 2-GALLON	EACH	100
C2005864	SHRUB, RHUS AROMATICA "GRO-LOW", (GRO-LOW SUMAC), CONTAINER GROWN, 3-GALLON	EACH	201
C2010924	SHRUB, SYRINGA MEYERI PALIBIN (DWARF KOREAN LILAC), 2' HEIGHT, BALLED AND BURLAPPED	EACH	79
C2010726	SHRUB, SYMPHORICARPUS X CHENALTII "HANCOCK", (HANCOCK CORALBERRY), CONTAINER GROWN, 3-GALLON	EACH	52
C2011724	SHRUB, VIBURNUM DENTATUM, (ARROWWOOD VIBURNUM), 2' HEIGHT, BALLED AND BURLAPPED	EACH	20
C2012336	SHRUB, VIBURNUM LANTANA MOHICAN, (MOHICAN WAYFARING TREE VIBURNUM) 3' HEIGHT, BALLED AND BURLAPPED	EACH	21
K0030396	PERENNIAL PLANTS, ACHILLEA X "MOONSHINE", (MOONSHINE YARROW), 1-GALLON	EACH	70
K0030398	PERENNIAL PLANTS, AQUILEGIA CANADENSIS, (AMERICAN COLUMBINE), 1-GALLON	EACH	51

\* SPECIALTY ITEMS

REVISIONS	
NAME	DATE

ILLINOIS DEPARTMENT OF TRANSPORTATION  
SUMMARY AND SCHEDULE OF QUANTITIES  
IDOT / IHPA  
PULLMAN STATE HISTORIC SITE

SCALE: VERT.  
HORIZ.  
DATE: 11/08/05

DRAWN BY: DJM  
CHECKED BY: PJM

SUMMARY OF QUANTITIES

F.A. RTE.	SECTION	COUNTY	TOTAL SHEETS	SHEET NO.
		COOK	17	5
STA.		TO STA.		
FED. ROAD DIST. NO.		ILLINOIS	FED. AID PROJECT	
CONTRACT NO. 44917				

CODE NO.	ITEM	UNIT	TOTAL
XX004486	ASCLEPIAS TUBEROSA, 1-GALLON	EACH	41
XX004490	ECHINACEA PURPUREA 'MAGNUS', 1-GALLON	EACH	25
K0030397	PERENNIAL PLANTS, EUPATORIUM PURPUREUM, (PURPLE JOE PYE WEED), 1-GALLON	EACH	70
K0030399	PERENNIAL PLANTS, PANICUM VIRGATUM "SHENANDOAH", (SHENANDOAH SWITCH GRASS), 1-GALLON	EACH	190
K1004466	PERENNIAL PLANTS, RUDBECKIA SUBTOMENTOSA (SWEET BLACK EYED SUSAN), 1-GALLON	EACH	76
K0030428	PERENNIAL PLANTS, SPOROBOLUS HETEROLEPIS, (PRAIRIE DROPSEED), 1-GALLON	EACH	23
K1005481	SHREDDED BARK MULCH 3"	SO YD	1810
X0323185	DUCTILE IRON WATER MAIN TEE, 6" x 6"	EACH	1
X4066412	BITUMINOUS CONCRETE SURFACE COURSE, SUPERPAVE, MIX "C", N30	TON	70
X4066760	LEVELING BINDER (MACHINE METHOD), SUPERPAVE N30	TON	35
XX003544	DUCTILE IRON WATER MAIN FITTINGS, 6", 90 DEGREE BEND	EACH	1
Z0013798	CONSTRUCTION LAYOUT	L SUM	1
X0325417	GATE, SPECIAL 14'	EACH	1
X0325418	GATE, SPECIAL 28'	EACH	1
XX002982	GATE VALVES 6"	EACH	1
X0325419	BALL VALVES 2"	EACH	1
X0325420	INSTALL FURNISHED SIGNS	EACH	4
X0325421	STONE SURFACE SPECIAL	SQ YD	4800
X0325422	DUCTILE IRON WATER MAIN FITTINGS, 6", 11/4 DEGREE BEND	EACH	1
X0325423	DUCTILE IRON WATER MAIN 6" (SPECIAL)	FOOT	10
X0325424	INLET SPECIAL WITH SPECIAL GRATE	EACH	1
X0325425	REMOVE AND RESET POWER POLE	EACH	1

\* SPECIAL PROVISION

TREE REMOVAL (6 TO 15 UNITS DIAMETER)	
LOCATION	UNIT
NORTH OF ADMINISTRATION BUILDING AT FENCE	20
<b>TOTAL</b>	<b>20</b>

TREE REMOVAL ACRES	
LOCATION	ACRE
NORTH FENCE LINE	0.17
EAST FENCE LINE	0.21
WEST FENCE LINE	0.04
NORTHEAST CORNER ADMINISTRATION BUILDING	0.03
<b>TOTAL</b>	<b>0.45</b>

PERIMETER EROSION BARRIER	
LOCATION	FOOT
SOUTHEAST CORNER OF PROPERTY	342
SOUTH SIDE PROPERTY LINE	308
WEST SIDE PROPERTY LINE	886
NORTH SIDE PROPERTY LINE	64
<b>TOTAL</b>	<b>1,600</b>

INLET AND PIPE PROTECTION	
LOCATION	EACH
WEST SIDE ADMINISTRATION BUILDING	5
EAST SIDE REAR ERECTING SHOPS (EXIST. SS MH)	1
EAST SIDE REAR ERECTING SHOPS (TRANSFER PIT)	1
<b>TOTAL</b>	<b>7</b>

AGGREGATE BASE COURSE, TYPE A	
LOCATION	TON
WALKWAY AREA	860
<b>TOTAL</b>	<b>860</b>

DRIVEWAY PAVEMENT REMOVAL	
LOCATION	SQ YD
SOUTH COTTAGE GROVE (80' SOUTH MAIN ENTRANCE)	32
SOUTH COTTAGE GROVE (MAINTENANCE TO ADMIN. BLDG.)	43
<b>TOTAL</b>	<b>75</b>

SIDEWALK REMOVAL	
LOCATION	SQ FT
SOUTH COTTAGE GROVE AT MAIN ENTRANCE	1,795
WATERMAIN LINE AT COTTAGE GROVE	82
NORTH FACTORY BUILDING	93
<b>TOTAL</b>	<b>1,970</b>

GATE, SPECIAL 14'	
LOCATION	EACH
SERVICE DRIVE - NORTHEAST CORNER ADMINISTRATION BUILDING	1
<b>TOTAL</b>	<b>1</b>

GATE, SPECIAL 28'	
LOCATION	EACH
SERVICE DRIVE AT SOUTH SIDE REAR ERECTING SHOPS	1
<b>TOTAL</b>	<b>1</b>

STONE SURFACE SPECIAL	
LOCATION	SQ YD
WEST OF REAR ERECTING SHOPS	396
EAST OF ADMINISTRATION BUILDING	185
SOUTHEAST REAR ERECTING SHOPS	340
WEST PROPERTY LINE	280
MAIN PATHWAY (EXCAVATED AREA)	3,599
<b>TOTAL</b>	<b>4,800</b>

EARTH WORK TABLE			
LOCATION	EARTH EXCAVATION	EARTH EXCAVATION (SPECIAL)	TOPSOIL FURNISH & PLACE, 4"
	CU YD	CU YD	SQ YD
PATHWAY OTHER THAN CONCRETE	755		
TRANSFER PIT		50	
SOUTHEAST PROPERTY CORNER			980
NORTH OF NORTH FACTORY BUILDING	150		470
WEST OF NORTH FACTORY BUILDING	90		1,090
NEW WATERMAIN			30
<b>TOTAL</b>	<b>995</b>	<b>50</b>	<b>2,570</b>

TRENCH BACKFILL	
LOCATION	SQ YD
TAP IN STREET	30
SIDEWALK AT STREET	16
SIDEWALK AT BUILDING	16
NEW 10' STONE SURFACE	22
INSIDE BUILDING	11
PATHWAY BEHIND RES BUILDING	5
<b>TOTAL</b>	<b>100</b>

PORTLAND CEMENT CONCRETE SIDEWALK, 4 INCH	
LOCATION	SQ FT
6" WATERMAIN AT COTTAGE GROVE	80
6" WATERMAIN AT NORTH FACTORY	95
<b>TOTAL</b>	<b>175</b>

SEEDING TABLE							
LOCATION	SEEDING CLASS 1 (SPECIAL)	SEEDING CLASS 4 (SPECIAL)	SEEDING CLASS 5 (SPECIAL)	NITROGEN FERTILIZER NUTRIENT	PHOSPHORUS FERTILIZER NUTRIENT	POTASSIUM FERTILIZER NUTRIENT	MULCH METHOD 1
SOUTHWEST CORNER OF SITE; NORTH, EAST AND WEST SIDE ADMINISTRATION BUILDING	1.7						
NORTH, SOUTH, EAST AND WEST PROPERTY LINES		0.9					
WEST PROPERTY LINE			0.4				
SEEDING, CLASS 1 (SPECIAL) AREA				153	153	153	3.4
SEEDING, CLASS 4 (SPECIAL) AREA				81	81	81	1.8
SEEDING, CLASS 5 (SPECIAL) AREA				36	36	36	0.8
<b>TOTAL</b>	<b>1.7</b>	<b>0.9</b>	<b>0.4</b>	<b>270</b>	<b>270</b>	<b>270</b>	<b>6.0</b>

REVISIONS	
NAME	DATE

ILLINOIS DEPARTMENT OF TRANSPORTATION  
 SUMMARY AND SCHEDULE OF QUANTITIES  
 IDOT / IHPA  
 PULLMAN STATE HISTORIC SITE

SCALE: VERT. HORIZ.  
 DATE: 11/08/05

DRAWN BY: DJM  
 CHECKED BY: PJM

F.A. RTE.	SECTION	COUNTY	TOTAL SHEETS	SHEET NO.
		COOK	17	6
STA.	TO STA.			
FED. ROAD DIST. NO.	ILLINOIS	FED. AID PROJECT		
CONTRACT NO. 44917				

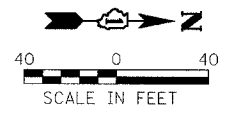
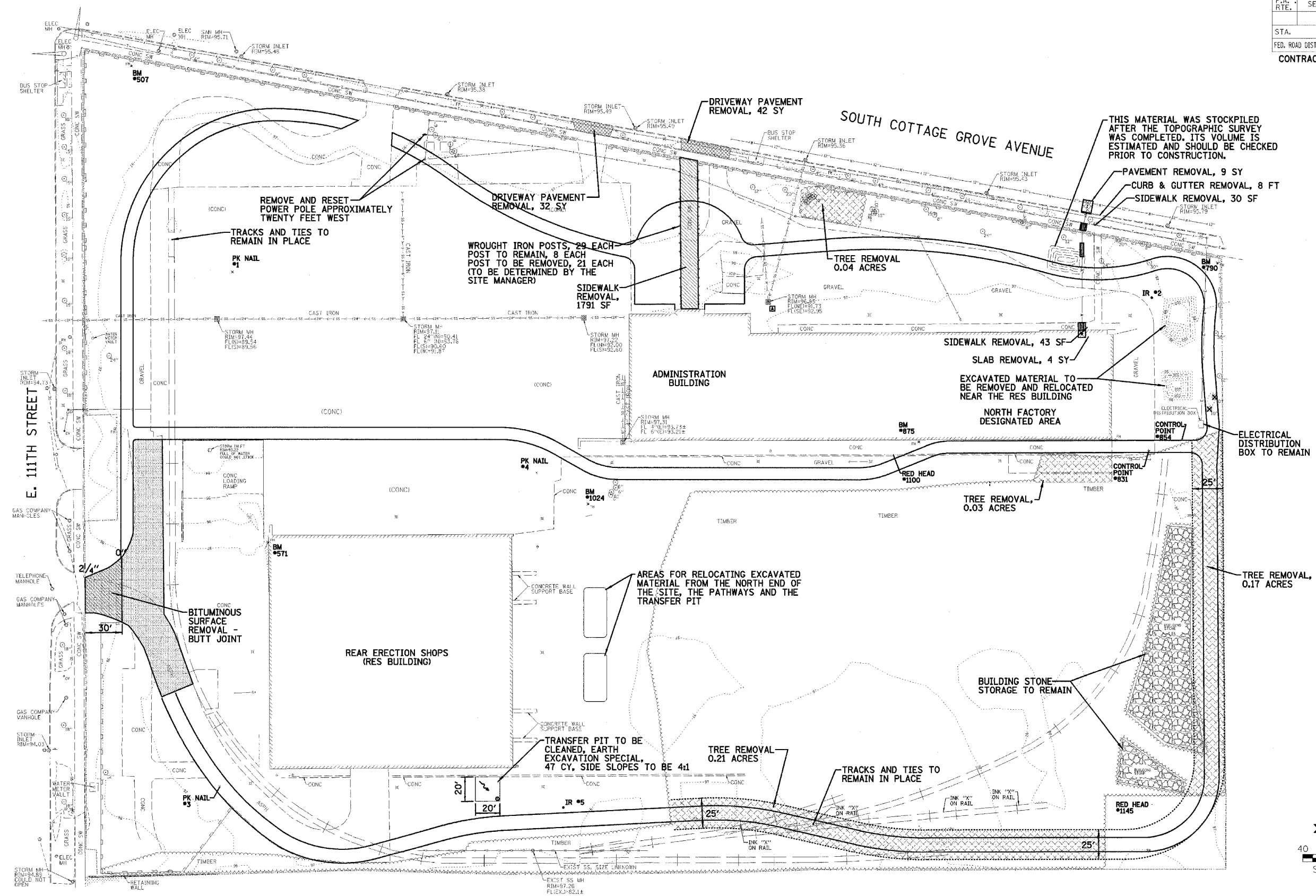

NOTE: ONLY THE AREAS IDENTIFIED HEREIN FOR TREE REMOVAL ACRES WILL BE MEASURED FOR PAYMENT.



REVISIONS	
NAME	DATE

ILLINOIS DEPARTMENT OF TRANSPORTATION  
**REMOVAL PLAN**  
 IDOT / IHPA  
 PULLMAN STATE HISTORIC SITE

SCALE: VERT. \_\_\_\_\_  
 HORIZ. \_\_\_\_\_  
 DATE: 11/08/05

DRAWN BY: DJM  
 CHECKED BY: PJM

F.A. RTE.	SECTION	COUNTY	TOTAL SHEETS	SHEET NO.
		COOK	17	7
STA.		TO STA.		
FED. ROAD DIST. NO.		ILLINOIS FED. AID PROJECT		
CONTRACT NO. 44917				

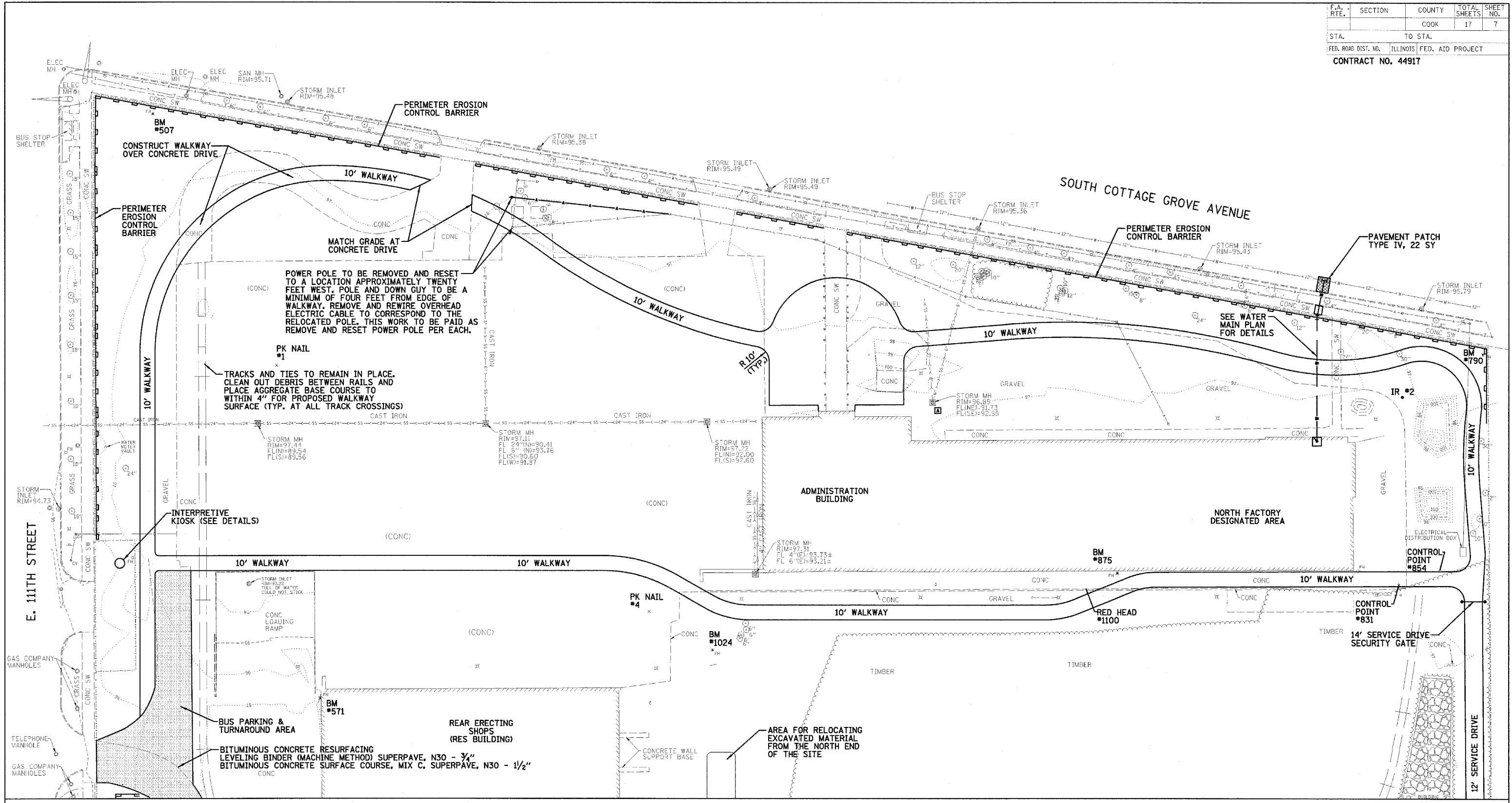

MATCH LINE PLAN SHEET 7

NOTE TO THE CONTRACTOR - THE CONTRACTOR IS ADVISED THAT DURING THE SURFACE PREPARATION AND CONSTRUCTION OF PROJECT ROADWAYS AND WALKS, SUSPECTED ASBESTOS CONTAINING MATERIAL (ACM) MAY BE FOUND, UNCOVERED, AND EXPOSED BELOW GRADE. THE CONTRACTOR IS ADVISED TO CONTAIN THE SUSPECTED ACM IN ACCORDANCE WITH ALL APPLICABLE HEALTH AND SAFETY REQUIREMENTS. IF ACM IS UNCOVERED IT SHALL BE DEALT WITH IN ACCORDANCE WITH THE ASBESTOS ABATEMENT GUIDELINES PUBLISHED BY THE STATE OF ILLINOIS. IF THIS WORK BECOMES NECESSARY, IT SHALL BE PAID FOR UNDER ARTICLE 109.04 OF THE STANDARD SPECIFICATIONS FOR ROAD AND BRIDGE CONSTRUCTION.

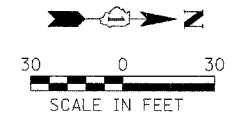

REVISIONS	
NAME	DATE

ILLINOIS DEPARTMENT OF TRANSPORTATION  
**PROPOSED PLAN**  
 IDOT / IHPA  
 PULLMAN STATE HISTORIC SITE

SCALE: VERT. \_\_\_\_\_  
 HORIZ. \_\_\_\_\_  
 DATE: 11/08/05

DRAWN BY: DJM  
 CHECKED BY: PJM





F.A. RTE.	SECTION	COUNTY	TOTAL SHEETS	SHEET NO.
		COOK	17	9
STA.	TO STA.			
FED. ROAD DIST. NO.	ILLINOIS FED. AID PROJECT			
CONTRACT NO. 44917				

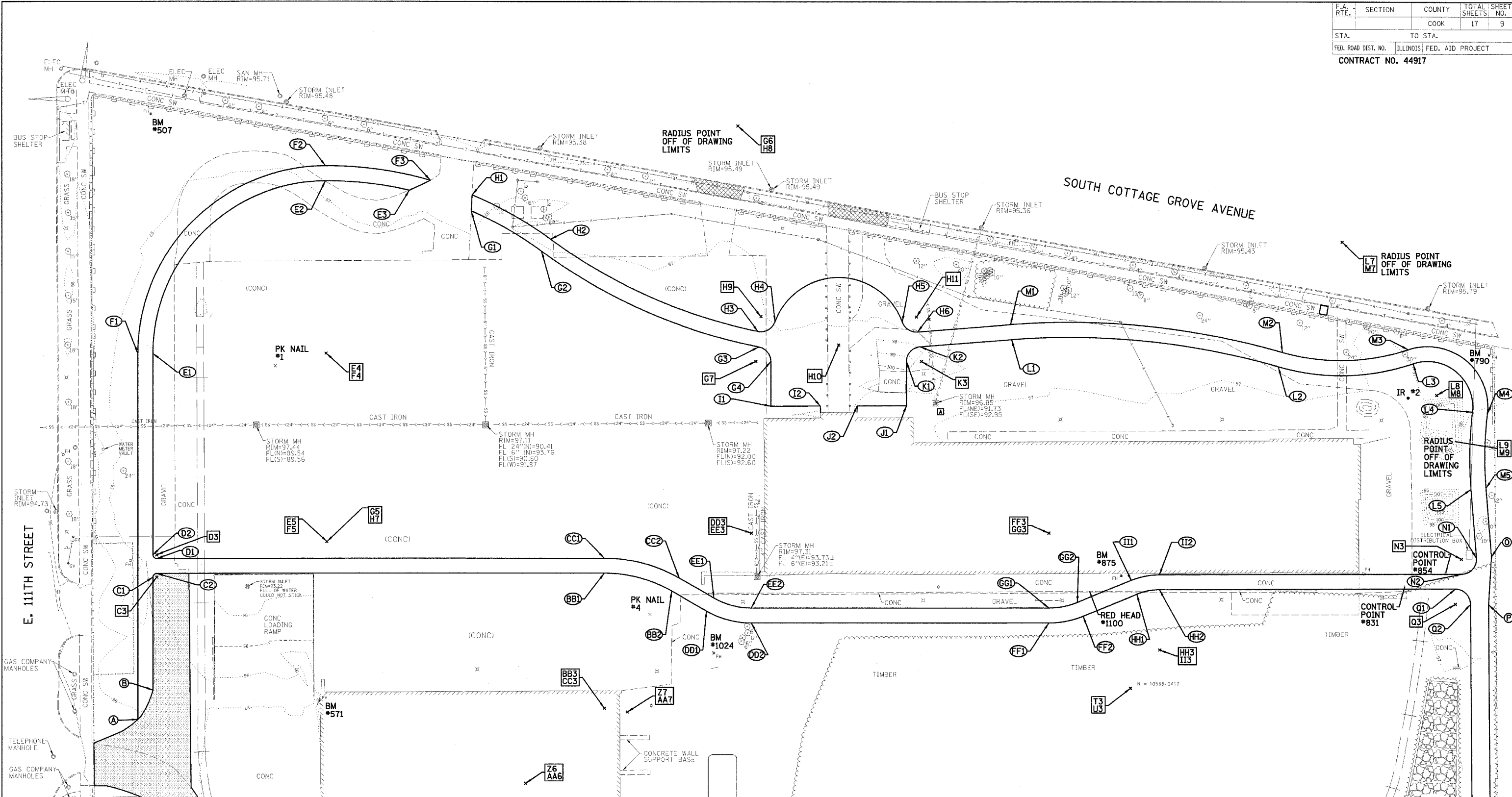

MATCH LINE PLAN SHEET 7

REVISIONS	
NAME	DATE

ILLINOIS DEPARTMENT OF TRANSPORTATION  
 PROPOSED STAKING &  
 LAYOUT PLAN  
 IDOT / IHPA  
 PULLMAN STATE HISTORIC SITE

SCALE: VERT. \_\_\_\_\_  
 HORIZ. \_\_\_\_\_  
 DATE: 11/08/05

DRAWN BY: DJM  
 CHECKED BY: PJM



F.A. RTE.	SECTION	COUNTY	TOTAL SHEETS	SHEET NO.
		COOK	17	11
STA.	TO STA.			
FED. ROAD DIST. NO.	ILLINOIS	FED. AID PROJECT		
CONTRACT NO. 44917				

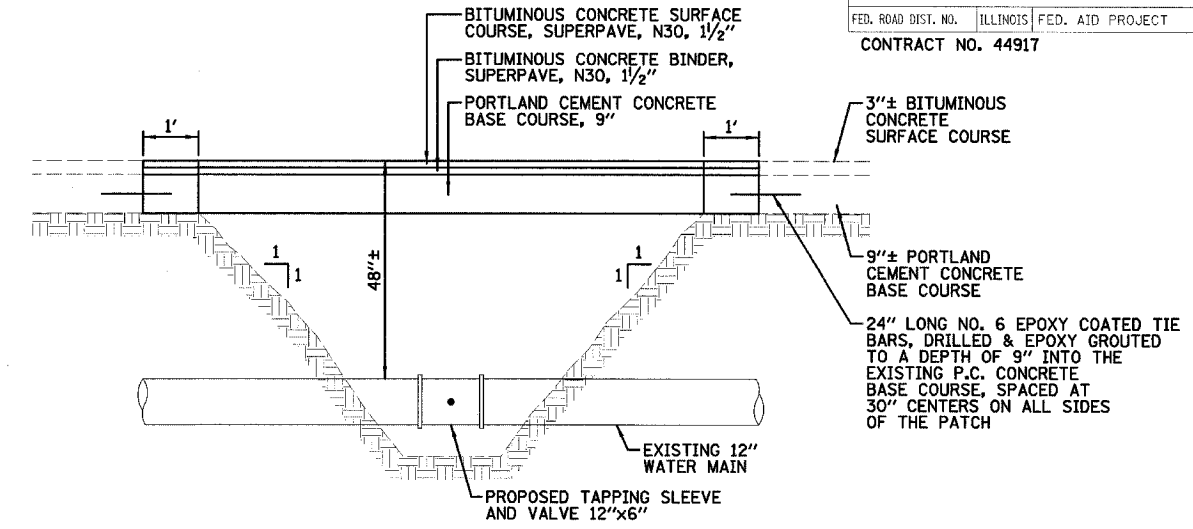
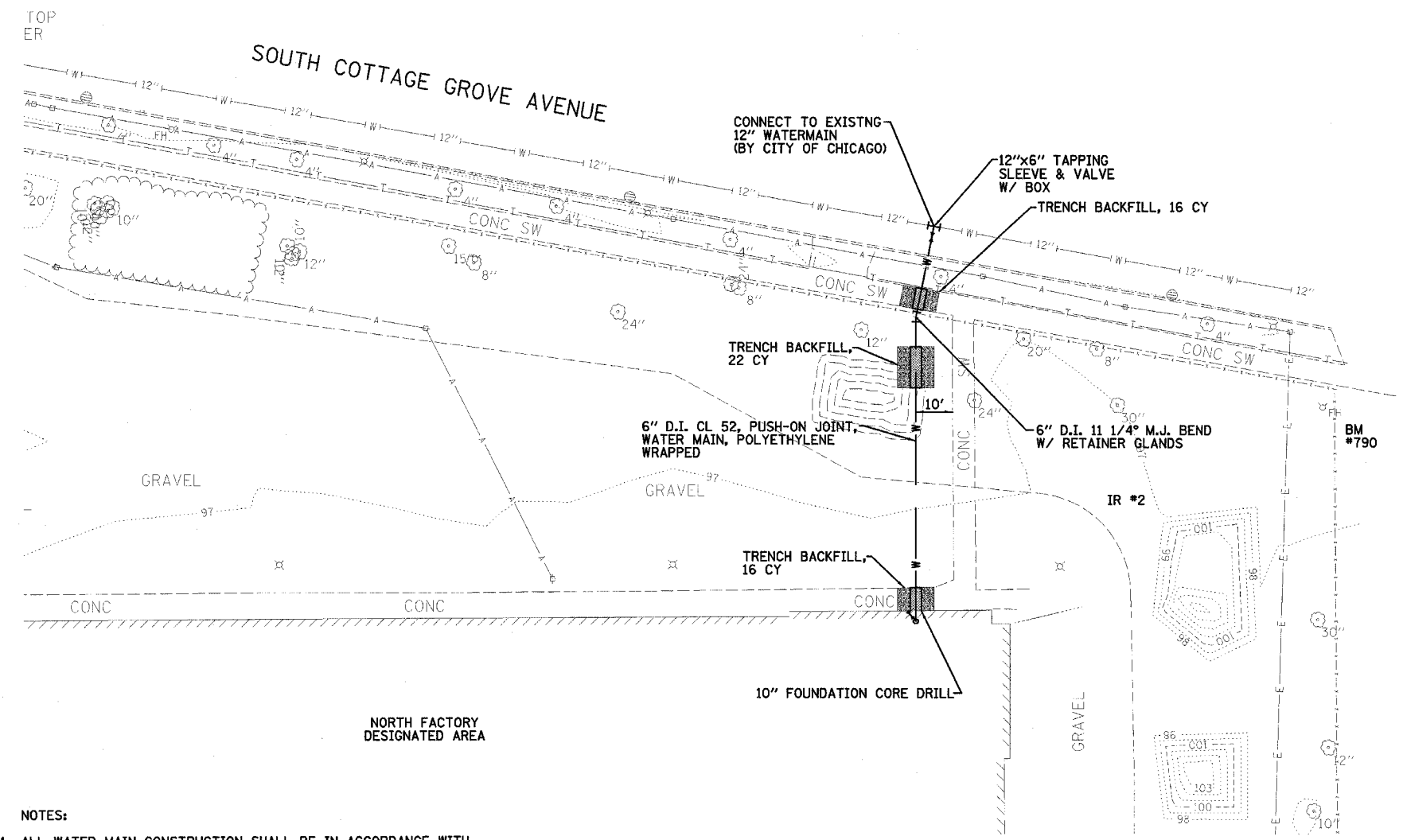

NOTE: PAVEMENT PATCH SHALL BE CONSTRUCTED ONTO A MINIMUM OF ONE FOOT OF UNDISTURBED SOIL. THIS WILL REQUIRE SAW CUTTING THE AREA TWICE. ALL PAVEMENT REMOVAL AND REPLACEMENT SHALL BE PAID AS PAVEMENT PATCH TYPE IV.

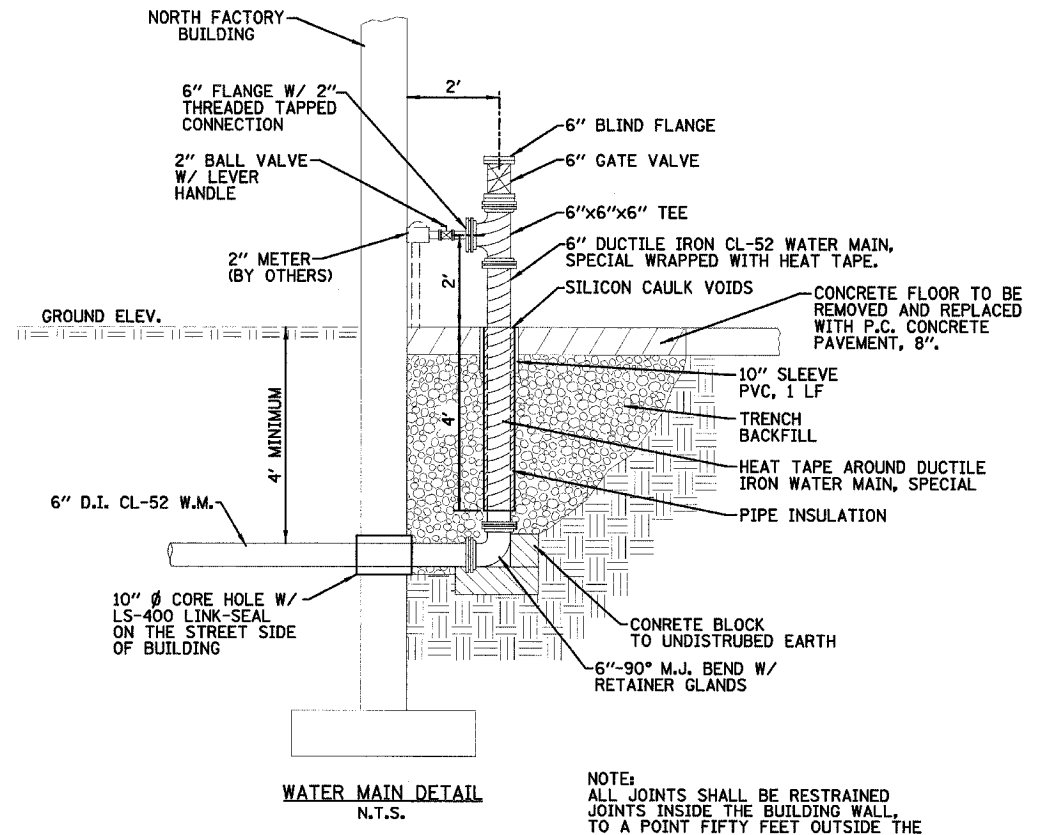

NOTE: ALL JOINTS SHALL BE RESTRAINED JOINTS INSIDE THE BUILDING WALL, TO A POINT FIFTY FEET OUTSIDE THE BUILDING AND AT ALL FITTINGS.

- NOTES:
- ALL WATER MAIN CONSTRUCTION SHALL BE IN ACCORDANCE WITH THE "STANDARD SPECIFICATIONS FOR WATER & SEWER MAIN CONSTRUCTION IN ILLINOIS".
  - ALL INTERIOR PLUMBING SHALL BE IN ACCORDANCE WITH THE CITY OF CHICAGO BUILDING CODE, PLUMBING CODE CHAPTERS.
  - THE CITY OF CHICAGO WATER DEPARTMENT SHALL PERFORM TAPPING OF EXISTING WATER MAIN. THE CONTRACTOR SHALL PROVIDE ALL MATERIALS AND PREPARATION FOR THE TAP.
  - THE CONTRACTOR SHALL OBTAIN CONSTRUCTION PERMIT FROM THE CITY OF CHICAGO, DEPARTMENT OF WATER. THE REQUEST SHALL BE MADE FOR CITY TAPPING.
  - STREET PAVEMENT SHALL BE THREE INCHES OF BITUMINOUS CONCRETE ON A NINE INCH P.C. CONCRETE BASE.
  - SELECT GRANULAR BACKFILL SHALL BE CA-6, CA-7, CA-9, CA-11 OR FA-5, FA-6, FA-10.
  - ALL ROADWAY CONSTRUCTION SHALL BE IN ACCORDANCE WITH IDOT "STANDARD SPECIFICATIONS FOR ROAD & BRIDGE CONSTRUCTION".
  - CORE DRILLING THE FOUNDATION WALL SHALL INCLUDE MATERIAL, EQUIPMENT & LABOR NEEDED TO CUT A CIRCULAR HOLE THROUGH THE EXISTING FOUNDATION. SIZE AS NECESSARY FOR PROPOSED WATER MAIN. GROUT REMAINING VOIDS.
  - THE FLOOR SLEEVE SHALL BE A PVC PIPE SET IN POURED SLAB WITH SILICON CAULKING IN REMAINING VOIDS.
  - HEAT TAPE SHALL BE A SINGLE COMPONENT CONTAINING 2-WIRE CONDUCTIVE CORE CABLE WITH INTERGRATED THERMOSTAT AND PLUG-IN. HEAT TAPE SHALL EMIT 6W/ FT OF OUTPUT AT 120V.
  - THE POWER SOURCE FOR THE HEAT TAPE PLUG-IN SHALL BE BY OTHERS. HEAT TAPE PLUG-IN MUST CONNECT TO A GFI RECEPTACLE AND NOT BE CONNECTED WITH AN EXTENSION CORD.
  - PIPE INSULATION SHALL BE CLOSED CELL POLYETHYLENE FOAM WITH A MINIMUM THICKNESS OF 1/2".
  - THE CONCRETE FLOOR SLAB REPLACED SHALL MATCH EXISTING PROFILES AND THICKNESS AND SHALL BE SMOOTH. THE NEW FLOOR SLAB WILL BE PAID AS P.C. CONCRETE PAVEMENT, 8". THE EXISTING CONCRETE SHALL BE SAW CUT STRAIGHT & NEAT FOR REMOVAL. REMOVAL OF THE EXISTING FLOOR SHALL BE PAID AS CONCRETE REMOVAL.

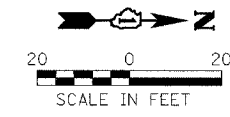

REVISIONS	
NAME	DATE



ILLINOIS DEPARTMENT OF TRANSPORTATION  
 WATER MAIN PLAN  
 IDOT / IHPA  
 PULLMAN STATE HISTORIC SITE

SCALE: VERT.      DRAWN BY: DJM  
 HORIZ.              CHECKED BY: PJM  
 DATE: 11/08/05

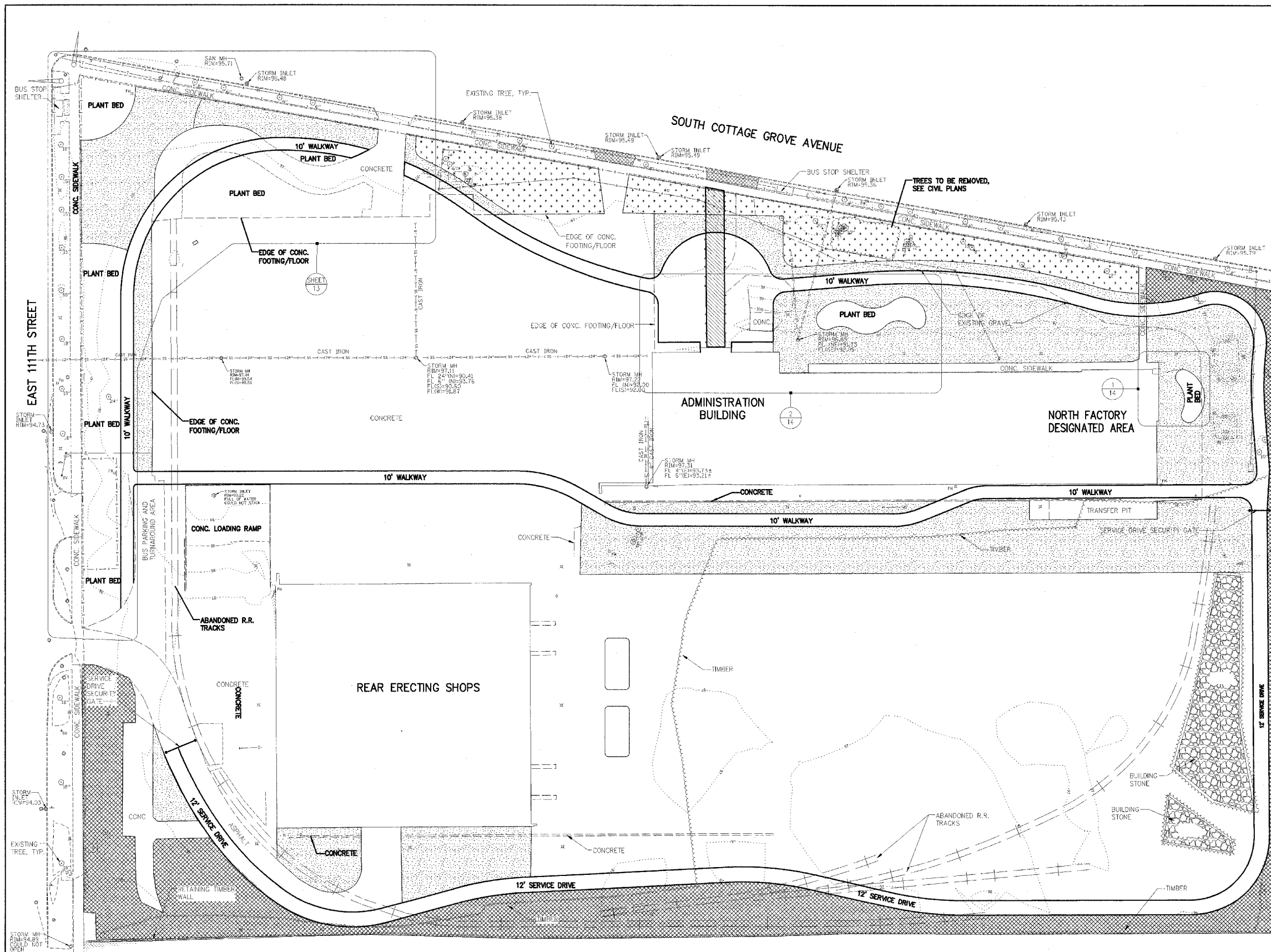
F.A. RTE.	SECTION	COUNTY	TOTAL SHEETS	SHEET NO.
		COOK	17	12
STA.	TO STA.			
FED. ROAD DIST. NO.	ILLINOIS FED. AID PROJECT			
CONTRACT NO. 44917				



**PROPOSED LEGEND**

-  GENERAL LOW-MOW GRASS MIX  
IDOT CLASS 1-SPECIAL (1.7 AC-72,650)
-  LOW PROFILE GRASS/FORB MIX  
IDOT CLASS 5-SPECIAL (0.4 AC)
-  TALL WATERWAY GRASS MIX  
IDOT CLASS 4-SPECIAL (0.9 AC)

REVISIONS	
NAME	DATE

ILLINOIS DEPARTMENT OF TRANSPORTATION  
LAWN PLANTING PLAN  
IDOT / IHPA  
PULLMAN STATE HISTORIC SITE

SCALE: VERT.  
HORIZ.  
DATE: 11/08/05

DRAWN BY: DJM  
CHECKED BY: PJM

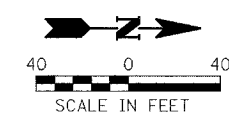





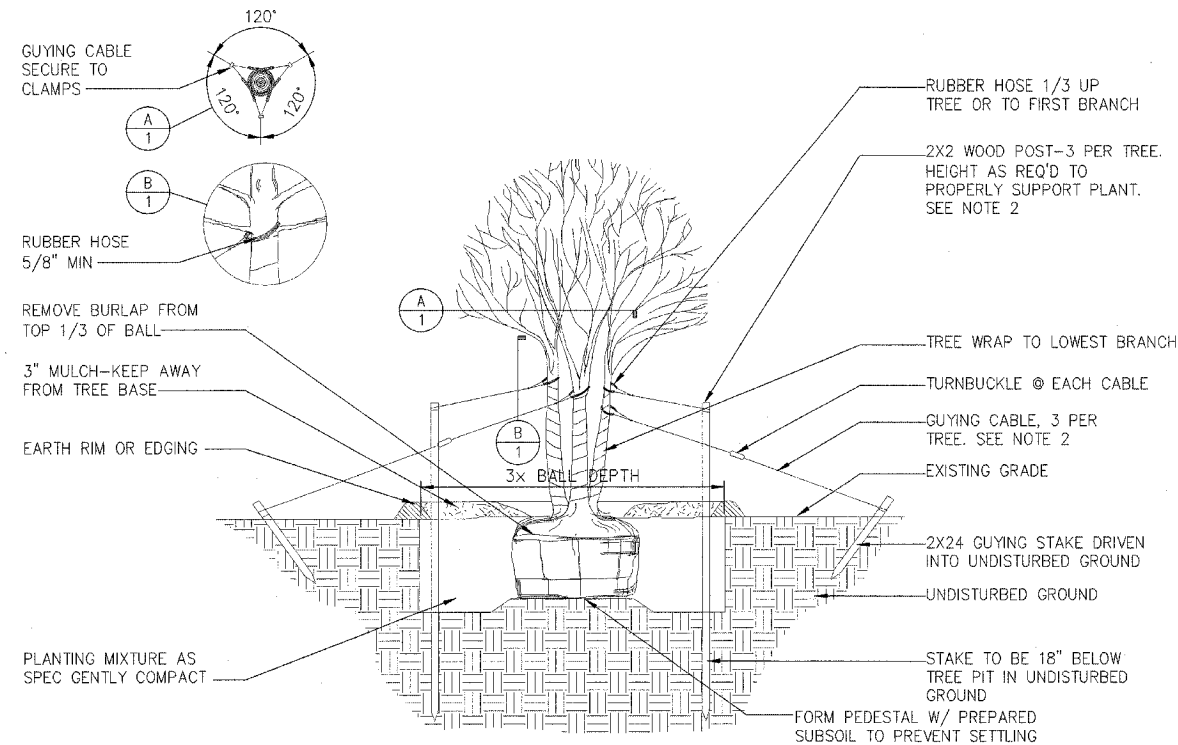

**NOTES:**

1. TREE SHALL BE SET 2" HIGHER THAN DEPTH GROWN AT NURSERY.
2. STAKE TREES UNDER 8' TALL. GUY TREES 8' TALL AND OVER.

**MULTISTEM TREE PLANTING DETAIL**

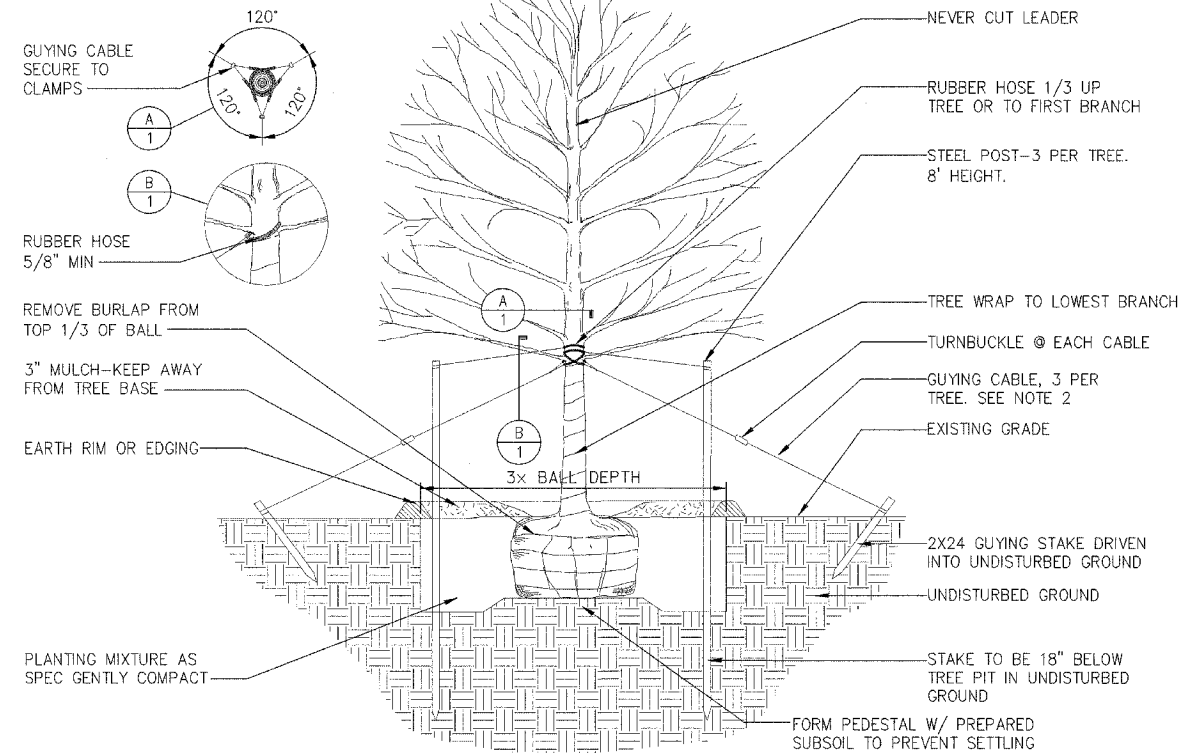

**NOTE:**

1. TREE SHALL BE SET 2" HIGHER THAN DEPTH GROWN AT NURSERY.
2. STAKE TREES UNDER 2" CALIPER OR LESS. GUY TREES OVER 2" CALIPER.

**TREE PLANTING DETAIL**

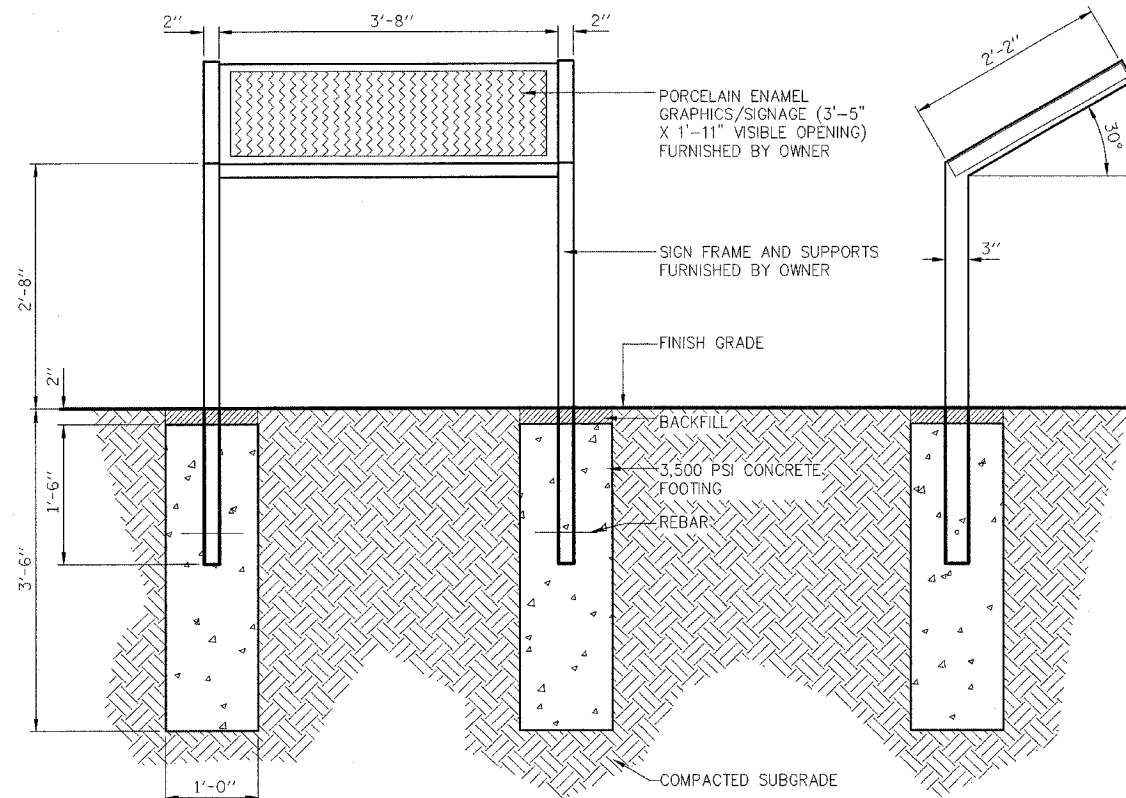

- NOTES:**
1. SIGN FRAME AND SUPPORT MATERIAL IS TO BE ALUMINUM WITH MANUFACTURER'S STANDARD POWDER COAT FINISH.
  2. SIGN GRAPHICS AND FINISH COLOR ARE TO BE COORDINATED WITH THE OWNER.

**INTERPRETIVE SIGN INSTALLATION DETAIL**

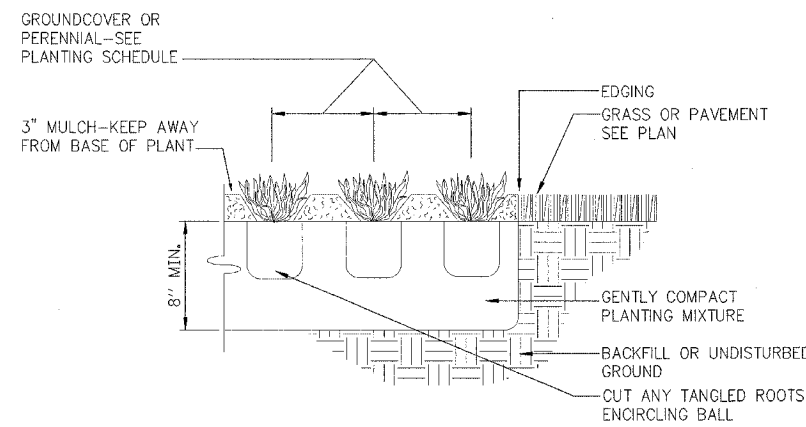

**PERENNIAL PLANTING DETAIL**

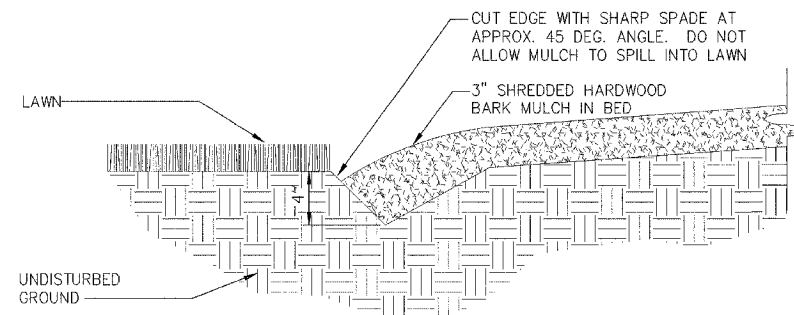

**SPADE EDGING DETAIL**

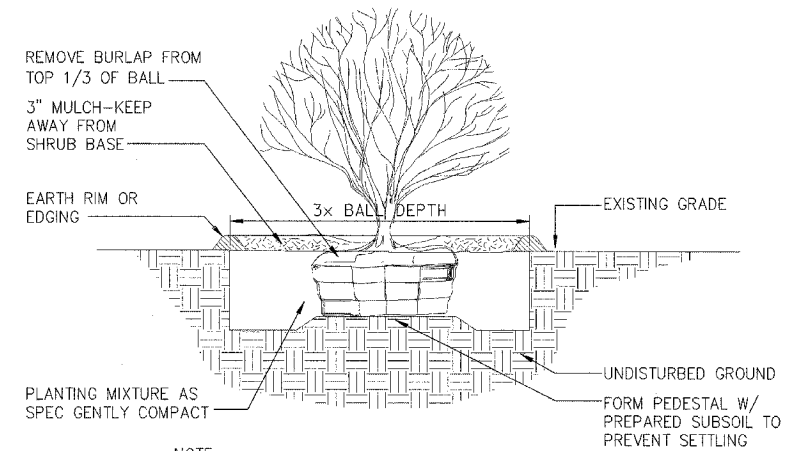

**NOTE:**

1. SHRUB SHALL BE SET 2" HIGHER THAN THE DEPTH GROWN AT NURSERY.

**SHRUB PLANTING DETAIL**

REVISIONS	
NAME	DATE

ILLINOIS DEPARTMENT OF TRANSPORTATION  
**LANDSCAPING DETAILS**  
 IDOT / IHPA  
 PULLMAN STATE HISTORIC SITE

SCALE: VERT.  
 HORIZ.  
 DATE: 11/08/05

DRAWN BY: DJM  
 CHECKED BY: PJM

GENERAL LOW-MIX GRASS MIX (IDOT CLASS 1-SPECIAL)		LBS 1000/ SQ. FT.
SCIENTIFIC NAME	COMMON NAME	
FESTUCA RUBRA 'CHEWINGS'	SR5100 CHEWINGS FESCUE	1.5
FESTUCA OVINA	SHEEPS FESCUE	1.5
FESTUCA LONGIFOLIA 'SR3100'	SR3100 HARD FESCUE	0.5
FESTUCA LONGIFOLIA 'SCALDIS'	SCALDIS HARD FESCUE	0.5
FESTUCA RUBRA	CREEPING RED FESCUE	0.5
FESTUCA RUBRA 'DAWSON'	DAWSON RED FESCUE	0.5
TOTAL		5.0

LOW PROFILE GRASS/FORB MIX (IDOT CLASS 5-SPECIAL)		OZ/AC	MATURE HEIGHT
SCIENTIFIC NAME	COMMON NAME		
NATIVE GRASSES:			
ANDROPOGON SCOPARIUS	LITTLE BLUESTEM	48	2'-3'
BOUTELOUA CURTIPENDULA	SIDE OATS GRAMMA	48	2'-3'
ELYMUS CANADENSIS	CANADIAN WILD RYE	16	2'-5'
KOELERIA CRISTATA	JUNE GRASS	8	2'
SPOROBOLUS HETEROLEPSIS	PRAIRIE DROPSEED	8	20'-3'
NATIVE GRASS TOTAL		128	(8 LBS)
NATIVE FORBS:			
AMORPHA CANESCENS	LEAD PLANT	2	1'-3'
ASCLEPIAS TUBEROSA	BUTTERFLY WEED	3	2'-3'
ASTER AZUREUS	SKY BLUE ASTER	2	1'-3'
ASTER ERICOIDES	HEATH ASTER	2	1'-3'
BAPTISIA AUSTRALIS	BLUE WILD INDIAGO	3	2'-5'
COREOPSIS LANCEOLATA	SAND TICKSEED	2	1'-2'
ECHINACEA PALLIDA	PALE PURPLE CONEFLOWER	6	2'-5'
HELIANTHUS MOLLIS	DOWNY SUNFLOWER	2	2'-4'
LESPEDEZA CAPITATA	ROUND-HEADED BUSH CLOVER	2	2'-4'
LIATRIS ASPERA	ROUGH BLAZING STAR	4	1'-3'
LUPINUS PERENNIS	WILD LUPINE	3	1'-2'
MONARDA FISTULOSA	PRAIRIE BERGAMOT	1	2'-4'
PENSTERMON HIRSUTUS	HAIRY BEARDTONGUE	1	2'-4'
PETALOSTEMUM PURPUREUM	PURPLE PRAIRIE CLOVER	2	1'-3'
RUDBECKIA HIRTA	BLACK-EYED SUSAN	6	1'-3'
SOLIDAGO NEMORALIS	GRAY GOLDENROD	1.5	1'-3'
SOLIDAGO RIGIDA	STIFF GOLDENROD	1	1'-5'
SOLIDAGO SPECIOSA	SHOWY GOLDENROD	1.5	1'-3'
VERBENA STRICTA	HOARY VERAIN	1	3'
VIOLA PEDATA LINEARILLOBA	BIRD'S FOOT VIOLET	1	1'-2'
ZIZIA APTERA	MEADOW PARSNIP	1	1'-2'
NATIVE FORB TOTAL:		48	(3 LBS)
TEMPORARY GRASSES:			
AVENA SATIVA	SEED OATS	384	(24 LBS)
LOLIUM MULTIFLORUM	ANNUAL RYE	80	(5 LBS)

TALL "WATERWAY" GRASS MIX (IDOT CLASS 4-SPECIAL)		OZ/AC	MATURE HEIGHT
SCIENTIFIC NAME	COMMON NAME		
ANDROPOGON GERARDII	BIG BLUESTREAM	32	4'-8'
BROMUS PUBESCENS	WOODLAND BROME	8	2'-4'
CAREX BICKNELLII	COPPER-SHOULDERED OVAL SEDGE	8	1'-3'
ELYMUS CANADENSIS	CANDIAN WILD RYE	16	2'-5'
ELYMUS VIRGINICUS	VIRGINIA WILD RYE	32	2'-4'
HYSTRIX PATULA	BOTTLEBRUSH GRASS	16	3'-5'
PANICUM VIRGATURN	SWITCH GRASS	16	3'-5'
SORGHASTRUM NUTANS	INDIAN GRASS	32	3'-6'
NATIVE GRASS TOTAL		160	(10 LBS)
TEMPORARY GRASSES:			
AVENA SATIVA	SEED OATS	384	(24 LBS)
LOLIUM MULTIFLORUM	ANNUAL RYE	80	(5 LBS)

PLANT SCHEDULE					
QTY.	SYMBOL	SCIENTIFIC NAME	COMMON NAME	SIZE	SPACING
53	AAS	ASTER AZUREUS	SKY BLUE ASTER	1 GAL.	2'
51	ACC	AQUILEGIA CANADENSIS	AMERICAN COLUMBINE	1 GAL.	2'
41	ATB	ASCLEPIAS TUBEROSA	BUTTERFLY WEED	1 GAL.	2'
70	AXM	ACHILLIEA X 'MOONSHINE'	MOONSHINE YARROW	1 GAL.	2.5'
43	CAN	CEANOTHUS AMERICANUS	NEW JERSEY TEA	3 GAL.	3'
77	CCA	CARYOPTERIS X CLANDONENSIS 'ARTHUR SIMMONDS'	ARTHUR SIMMONDS BLUEBEARD	1 GAL.	3'
7	CCC	CRATAEGUS CRUS-GALLI VAR. INERMIS 'CRUSADER'	CRUSADER THORNLESS COCKSPUR HAWTHORN	2" B.B.	---
1	CCE	CELTIS OCCIOENTAILS 'WINDY CITY'	WINDY CITY HACKBERRY	2 1/2" B.B.	---
1	COW	CERCIS CANADENSIS	EASTERN REDBUD	8' B.B.	---
70	EPJ	EUPATORIUM PURPUREUM	PURPLE JOE PYE WEED	1 GAL.	2.5'
25	EPM	ECHINACEA PURPUREA 'MAGNUS'	MAGNUS PURPLE CONEFLOWER	1 GAL.	2.5'
4	FPC	FRANXINUS PENNSYLVANIA 'CIMMAM'	CIMMARON ASH	2 1/2" B.B.	---
10	HSB	HIBISCUS SRIACUS 'BLUE BIRD'	BLUE BIRD ROSE OF SHARON	30" B.B.	---
11	KAP	KOLKOWITZIA AMABILIS 'PINK CLOUD'	PINK CLOUD BEAUTYBUSH	24" B.B.	---
5	OVH	OSTRYA VIRGINIANA	IRONWOOD	2" B.B.	---
100	PFP	POTENTILLA FRUITICOSA 'PINK BEAUTY'	PINK BEAUTY BUSH CINQUEFOIL	2 GAL.	3'
190	PVS	PANICUM VIRGATUM 'SHENANDOAH'	SHENANDOAH SWITCH GRASS	1 GAL.	3'
201	RAG	RHUS AROMATICA 'GRO-LOW'	GRO-LOW SUMAC	3 GAL.	4'
76	RST	RUDBECKIA SUBTOMENTOSA	SWEET BLACK-EYED SUSAN	1 GAL.	2'
52	SCH	SYMPHOROCARPUS X CHENALITII 'HANCOCK'	HANCOCK CORALBERRY	3 GAL.	4'
79	SHP	SYRINGA MEYERI 'PALIBIN'	DWARF KOREAN LILAC	24" B.B.	---
23	SMP	SPOROBOLUS HETEROLEPIS	PRAIRIE DROPSEED	1 GAL.	2.5'
20	VDA	VIBURNUM DENTATUM	ARROWWOOD VIBURNUM	24" B.B.	---
21	VLM	VIBURNUM LANTANA 'MOHICAN'	MOHICAN WAYFARINGTREE VIBURNUM	36" B.B.	---

NATIVE PLANT SOURCE LIST		
COUNTRY ROAD GREENHOUSES INC. 19561 E. TWOMBLY ROCHELLE, IL 61068-9697 (815) 384-3311 FAX: (815) 384-5015 WWW.PRAIRIEPLUGS.COM	LAFAYETTE HOME NURSERY R.R. #1 BOX A LAFAYETTE, IL 61449 (309) 995-3311 FAX: (309) 995-3909	PRAIRIE NURSERY P.O. BOX 306 WESTFIELD, WI 53964 (800) 476-2741 FAX: (608) 296-2741 WWW.PRAIRIENURSERY.COM
GENESIS NURSERY 23200 HURD RD. TAMPICO, IL 61283 (815) 438-2220 FAX: (815) 438-2222	MURN ENVIRONMENTAL, INC. 2707 E. PHILHOWER RD. BELOIT, WI 53511 (608) 362-6449 FAX: (608) 362-6455 WWW.MURN.COM	SPENCE RESTORATION NURSERY P.O. BOX 546 2220 E. FUNSON RD. MUNCIE, IN 47308 (765) 286-7154 FAX: (765) 286-0264
JFNEW NATIVE PLANT NURSERY 128 SUNSET DR. WALKERTON, IN 46574 (574) 586-2412 FAX: (574) 586-2718 WWW.JFNEWNURSURY.COM	POSSIBILTY PLACE NURSERY 7458 W. MONEE-MANHATTEN RD. MONEE, IL 60449 (708) 534-3988 FAX: (708) 534-6272 WWW.POSSIBILITYPLACE.COM	TAYLOR CREEK RESTORATION NURSERIES 17921 SMITH RD. BRODHEAD, WI 53520 (608) 897-8641 FAX: (608) 897-8486
J & J TRANZPLANT AQUATIC NURSERY, LLC P.O. BOX 227 WILD ROSE, WI 54984-0227 FOR ORDERS: 1-800-622-5055 (715) 256-0059 FAX: (715) 256-0039 WWW.TRANZPLANT.COM	PRAIRIE RIDGE NURSERY R.R.2 9378 OVERLAND RD. MT. HOREB, WI 53572-2832 (608) 437-5245	THE NATURAL GARDEN 38W443 HIGHWAY 64 ST. CHARLES, IL 60175 (630) 584-0150 X224 FAX: (630) 584-0185 WWW.THENATURALGARDENINC.COM

REVISIONS	
NAME	DATE

ILLINOIS DEPARTMENT OF TRANSPORTATION  
LANDSCAPING NOTES  
IDOT / IHPA  
PULLMAN STATE HISTORIC SITE

SCALE: VERT.  
HORIZ.  
DATE: 11/08/05

DRAWN BY: DJM  
CHECKED BY: PJM



**GENERAL NOTES**

1. PLANT SUBSTITUTIONS WILL NOT BE ACCEPTABLE UNLESS APPROVED BY THE LANDSCAPE ARCHITECT.
2. THE CONTRACTOR SHALL FAMILIARIZE HIM OR HERSELF WITH THE SCOPE OF WORK, SOIL, LOCATION OF UTILITIES, AND WATER CONDITIONS BEFORE PROCEEDING WITH THE WORK.
3. THE CONTRACTOR SHALL FIELD CHECK AND VERIFY ALL EXISTING CONDITIONS AND REPORT ANY DISCREPANCIES BETWEEN CONSTRUCTION DOCUMENTS AND ACTUAL FIELD CONDITIONS TO THE OWNER'S REPRESENTATIVE BEFORE PROCEEDING WITH WORK.
4. ALL DETAILS AND SECTIONS SHOWN ON THE DRAWINGS ARE INTENDED TO BE TYPICAL AND SHALL BE CONSIDERED TO APPLY TO SIMILAR CONDITIONS ELSEWHERE.
5. PLANT SPACING WILL BE SCALED ON PLAN UNLESS NOTED OTHERWISE.
6. SPREAD PRE-EMERGENCE HERBICIDE AND THREE INCHES OF SHREDDED HARDWOOD MULCH IN ALL PLANTING BEDS.
7. IN ALL LAWN AREAS AND PLANTING BEDS (SEE SHEETS 12,13, 14 AND 15) REMOVE ALL MATERIAL HARMFUL TO PLANT GROWTH INCLUDING BRUSH, DEBRIS, WEEDS, AND STONES OVER 1" DIAMETER. SPREAD 4" OF TOPSOIL AND FINISH GRADE TO DRAIN.
8. FORM PLANTING MIX FOR ALL PLANT BEDS BY SPREADING TWO INCHES OF COMPOST (pH OF 5.5 TO 7) AND THOROUGHLY ROTOTILLING INTO TOP EIGHT INCHES OF TOPSOIL. FOR TREE PITS MIX COMPOST INTO PIT EXCAVATIONS AT A 1:3 RATIO BEFORE BACKFILLING. IF EXCAVATIONS ARE DEEMED TO BE UNSTABLE BY THE ENGINEER, THE BACKFILL SHALL CONSIST OF TOPSOIL APPROVED BY THE ENGINEER.
9. FINISH GRADES IN PLANTING BEDS ARE TO BE SMOOTH AND PROVIDE POSITIVE DRAINAGE PRIOR TO PLANT AND MULCH INSTALLATION.
10. CONTRACTOR IS TO PREVENT DAMAGE TO CURBS AND PAVEMENTS ADJACENT TO CONSTRUCTION.
11. MAINTAIN PLANTINGS AND BEDS BY SPRAYING, WATERING, WEEDING, RESTORING PLANT STAKES, AND GUY SUPPORTS AS REQUIRED TO ESTABLISH HEALTHY PLANTS FOR 60 DAYS FROM SUBSTANTIAL COMPLETION.
12. PROVIDE A ONE YEAR WARRANTY ON ALL PLANTS. WARRANTY INCLUDES REPLACING ANY PLANT WHICH IS 25% OR MORE DEAD, DISEASED, OR DISFIGURED ONCE DURING THE WARRANTY PERIOD.
13. PROVIDE QUALITY, GENUS, SIZE, SPECIES, AND VARIETY OF PLANTS COMPLYING WITH THE APPLICABLE REQUIREMENTS OF ANSI Z60.1, "AMERICAN STANDARD FOR NURSERY STOCK".
14. ALL PLANT BEDS ABUTTING LAWN AREAS ARE TO BE SEPARATED BY SPADE EDGING AS DETAILED ON SHEET 15.
15. IF THERE ARE DISCREPANCIES BETWEEN PLANT QUANTITIES ON THE PLANS AND THE PLANT SCHEDULE, USE THE QUANTITIES FROM THE PLAN.
16. ALL PLANT MATERIAL SHALL BE GROWN FROM A SOURCE WITHIN A 150 MILE RADIUS OF THE SITE. FOR A LIST OF NATIVE PLANT SOURCES, SEE THE SOURCE LIST ON SHEET 16.

**LAWN PLANTING SPECIFICATIONS**

**QUALITY ASSURANCE:**

1. TOPSOIL ANALYSIS: FURNISH SOIL ANALYSIS OF EXISTING ON-SITE IMPORTED TOPSOIL BY A QUALIFIED SOIL-TESTING LABORATORY STATING PERCENTAGES OF ORGANIC MATTER; GRADATION OF SAND, SILT, AND CLAY CONTENT; CATION EXCHANGE CAPACITY; SODIUM ABSORPTION RATIO; DELETERIOUS MATERIAL; PH; AND MINERAL AND PLANT-NUTRIENT CONTENT OF TOPSOIL.
2. INSTALLER QUALIFICATIONS: A QUALIFIED LANDSCAPE INSTALLER WHOSE WORK HAS RESULTED IN SUCCESSFUL LAWN AND NATIVE PRAIRIE ESTABLISHMENT.
3. INSTALLER'S FIELD SUPERVISION: REQUIRE INSTALLER TO MAINTAIN AN EXPERIENCED FULL TIME SUPERVISOR.
  - A. MAINTENANCE PROXIMITY: NO MORE THAN TWO HOURS NORMAL TRAVEL TIME FROM THE CONTRACTOR'S PLACE OF BUSINESS TO THE PROJECT SITE.
  - B. WEATHER LIMITATIONS: PROCEED WITH PLANTING ONLY WHEN EXISTING AND FORECASTED WEATHER CONDITIONS PERMIT.
  - C. INITIAL LAWN AND NATIVE PRAIRIE MAINTENANCE SERVICE: PROVIDE FULL MAINTENANCE BY SKILLED EMPLOYEES OF LANDSCAPE INSTALLER. MAINTAIN AS REQUIRED BELOW. BEGIN MAINTENANCE IMMEDIATELY AFTER EACH AREA IS PLANTED AND CONTINUE UNTIL ACCEPTABLE MEADOW IS ESTABLISHED, BUT FOR NOT LESS THAN 60 DAYS FROM DATE OF SUBSTANTIAL COMPLETION.
  - D. WHEN INITIAL MAINTENANCE PERIOD HAS NOT ELAPSED BEFORE END OF PLANTING SEASON, OR IF LAWN IS NOT FULLY ESTABLISHED, CONTINUE MAINTENANCE DURING NEXT PLANTING SEASON.
4. SUBMITTALS:
  - A. PRODUCT DATA: FOR EACH TYPE OF PRODUCT INDICATED.
  - B. CERTIFICATION OF GRASS SEED: FROM SEED VENDOR FOR EACH GRASS-SEED MONOSTAND OR MIXTURE STATING THE BOTANICAL AND COMMON NAME AND PERCENTAGE BY WEIGHT OF EACH SPECIES AND VARIETY, AND PERCENTAGE OF PURITY, GERMINATION, AND WEED SEED. INCLUDE THE YEAR OF PRODUCTION AND DATE OF PACKAGING.
  - C. QUALIFICATION DATA: FOR LANDSCAPE CONTRACTOR.
  - D. MATERIAL TEST REPORTS: FOR EXISTING AND IMPORTED TOPSOIL.
  - E. PLANTING SCHEDULE: INDICATING ANTICIPATED PLANTING DATES FOR EACH TYPE OF PLANTING.
  - F. MAINTENANCE INSTRUCTIONS: RECOMMENDED PROCEDURES TO BE ESTABLISHED BY OWNER FOR MAINTENANCE OF LAWNS AND NATIVE PRAIRIE DURING A CALENDAR YEAR. SUBMIT BEFORE EXPIRATION OF REQUIRED INITIAL MAINTENANCE PERIODS.
5. SEED: DELIVER SEED IN ORIGINAL SEALED, LABELED, AND UNDAMAGED CONTAINERS. SEED SHALL BE GROWN FROM A SOURCE WITHIN 150 MILE RADIUS OF THE SITE. SEE SHEET 16 FOR NATIVE SEED SOURCES.

**SITE PREPARATION:**

- PRODUCTS:
1. SELECTIVE HERBICIDES: EPA REGISTERED AND APPROVED, NON-PERSISTENT WITH GLYPHOSATE, RECOMMENDED FOR APPLICATION.
    - A. APPLICATION TIME: APRIL TO MAY OR AUGUST TO MID-SEPTEMBER.

2. TOPSOIL: MEETS GUIDLINES SET FORTH IN THE "CALUMET DESIGN GUIDELINES", FEBRUARY, 2004 PAGE 68 INCLUDING, BUT NOT LIMITED TO: PH RANGE OF 5.5 TO 7, 3 TO 10 PERCENT ORGANIC MATERIAL CONTENT; FREE OF STONES 1 INCH OR LARGER IN ANY DIMENSION AND OTHER EXTRANEIOUS MATERIALS HARMFUL TO PLANT GROWTH INCLUDING WEED SEEDS.
  - A. IMPORTED TOPSOIL STOCKPILED ON-SITE IS TO BE COVERED TO PREVENT EROSION AND CONTAMINATION WITH WEEDS.

**EXECUTION:**

1. EXAMINE AREAS TO RECEIVE LAWNS AND PLANT BEDS FOR COMPLIANCE WITH REQUIREMENTS AND OTHER CONDITIONS AFFECTING PERFORMANCE.
2. PROCEED WITH INSTALLATION ONLY AFTER UNSATISFACTORY CONDITIONS HAVE BEEN CORRECTED.
3. PROTECT STRUCTURES, UTILITIES, SIDEWALK, PAVEMENTS, AND OTHER FACILITIES, TREES, SHRUBS, AND PLANTINGS FROM DAMAGE CAUSED BY PLANTING OPERATIONS.
4. MOW EXISTING VEGETATION AS REQUIRED. APPLY SELECTIVE HERBICIDE PER MANUFACTURER'S RECOMMENDATIONS TO AREAS TO RECEIVE LAWN AND PLANT BEDS. DO NOT APPLY HERBICIDE WHEN WIND CONDITIONS COULD RESULT IN DAMAGE TO VEGETATION OUTSIDE AREAS TO BE PLANTED.
5. SIX WEEKS FOLLOWING THE INITIAL APPLICATION, APPLY A SECOND APPLICATION AS REQUIRED. OBTAIN ENGINEER'S APPROVAL OF WEED-CONTROL PRIOR TO CONTINUING SITE PREPARATION OPERATIONS.
6. REMOVE EXISTING VEGETATION, WOODY PLANTS, STUMPS, TURF AND ROCKS OVER TWO INCHES IN DIAMETER IN AREAS TO RECEIVE LAWN AND PLANT BEDS.
7. PROMPTLY REMOVE DEBRIS CREATED BY SITE PREPARTION AND LEGALLY DISPOSE OF OFF-SITE.
8. LOOSEN SUBGRADE TO A DEPTH OF THREE INCHES. SPREAD IMPORTED TOPSOIL TO A DEPTH OF FOUR INCHES.
  - A. DO NOT SPREAD IF TOPSOIL OR SUBGRADE IS FROZEN, MUDDY, OR EXCESSIVELY WET.
9. FINISH GRADING: GRADE PLANTING AREAS TO A SMOOTH, UNIFORM SURFACE PLANE WITH LOOSE, UNIFORMLY FINE TEXTURE. GRADE TO WITHIN PLUS OR MINUS 1/2 INCH OF FINISH ELEVATION. ROLL AND RAKE, REMOVE RIDGES, AND FILL DEPRESSIONS TO MEET FINISH GRADES. LIMIT FINISH GRADING TO AREAS THAT CAN BE PLANTED IN THE IMMEDIATE FUTURE.
  - A. BEFORE PLANTING, RESTORE AREAS IF ERODED OR OTHERWISE DISTURBED AFTER FINISH GRADING.

**NATIVE PRAIRIE AND LOW-MOW GRASS PLANTING:**

**PRODUCTS:**

1. SEED MIXES: SEE TABLES ON SHEET 16 & 17 FOR SPECIES AND RATES OF SEED MIXES.
  - A. NATIVE PRAIRIE PLANTING TIME: MAY 1 TO JUNE 15 OR OCTOBER 1 TO SOIL FREEZE.
  - B. LOW-MOW GRASS PLANTING TIME: APRIL 1 TO MAY 15 OR AUGUST 15 TO SEPTEMBER 30.

2. STRAW MULCH: PROVIDE AIR-DRY, CLEAN, MILDEW- AND SEED-FREE, SALT HAY OR THRESHED STRAW OF WHEAT, RYE, OATS, OR BARLEY.

**EXECUTION:**

1. SOW SEED USING BROADCAST SPREADER AT RATES INDICATED IN DRAWINGS.
  - A. DO NOT USE BROADCAST OR DROP SEED WHEN WIND EXCEEDS 5 MPH.
  - B. AS REQUIRED, USE AGITATOR AND CARRYING AGENTS APPROVED FOR NATIVE PRAIRIE APPLICATIONS TO INSURE GOOD DISTRIBUTION.
2. COVER SEEDS WITH SOIL BY HARROWING OR RAKING AND LIGHTLY COMPACT WITH ROLLER. DO NOT COVER SEED MORE THAN 1/4" DEEP.
3. BREAK STRAW MULCH INTO SMALL PIECES AND SPREAD AT 2 TONS/ ACRE TO A DEPTH NOT EXCEEDING ONE INCH.

**NATIVE PRAIRIE AND LOW-MOW GRASS PLANTING:**

1. MAINTAIN AND ESTABLISH LAWN BY WATERING, WEEDING, REPLANTING, AND OTHER OPERATIONS. REGRADE, AND REPLANT BARE OR ERODED AREAS AND REMULCH.
2. WATERING: PROVIDE AND MAINTAIN TEMPORARY PIPING, HOSES, AND LAWN-WATERING EQUIPMENT TO CONVEY WATER FROM SOURCES AND TO KEEP MEADOW UNIFORMLY MOIST.
  - A. SCHEDULE WATERING TO PREVENT WILTING, PUDDLING, EROSION, AND DISPLACEMENT OF SEED OR MULCH. LAY OUT TEMPORARY WATERING SYSTEM TO AVOID WALKING OVER MUDDY OR NEWLY PLANTED AREAS.
  - B. FOR SIX WEEKS WATER GRASS DAILY, IN THE EARLY MORNING, WITH FINE SPRAY FOR 15 TO 30 MINUTES UNTIL SOIL IS VERY DAMP. AFTER SIX WEEKS, WATERING CAN BE REDUCED TO EVERY 2 TO 5 DAYS DEPENDING ON WEATHER CONDITIONS UNTIL THE END OF THE MAINTENANCE PERIOD.
  - C. CHEMICAL WEED CONTROL MAY BE PROVIDED WITH TRADITIONAL LAWN HERBICIDES PER THE MANUFACTURER'S RECOMMENDATIONS. CHEMICAL WEED CONTROL SHALL ONLY BE PROVIDED FOR SPOT CONTROL. SPRING PLANTING MAY REQUIRE MORE WEED CONTROL THAN FALL.
  - D. SATISFACTORY SEEDED LAWN: AT END OF MAINTENANCE PERIOD, A HEALTHY, UNIFORM, CLOSE STAND OF GRASS HAS BEEN ESTABLISHED, FREE OF WEEDS AND SURFACE IRREGULARITIES, WITH COVERAGE EXCEEDING 90 PERCENT OVER 10 SQ. FT. AND BARE SPOTS NOT EXCEEDING 5 BY 5 INCHES.
  - E. USE SPECIFIED MATERIALS TO REESTABLISH LAWNS THAT DO NOT COMPLY WITH REQUIREMENTS AND CONTINUE MAINTENANCE UNTIL LAWNS ARE SATISFACTORY.
  - F. IF SOWING THE NATIVE PRAIRIE IN THE FALL, INITIAL WATERING SCHEDULE MAY BE REDUCED AS WEATHER CONDITIONS PERMIT.

F.A. RTE.	SECTION	COUNTY	TOTAL SHEETS	SHEET NO.
		COOK	17	17
STA.		TO STA.		
FED. ROAD DIST. NO.	ILLINOIS	FED. AID PROJECT		
CONTRACT NO. 44917				

REVISIONS	
NAME	DATE

ILLINOIS DEPARTMENT OF TRANSPORTATION

LANDSCAPING NOTES

IDOT / IHPA

PULLMAN STATE HISTORIC SITE

SCALE: VERT.      DRAWN BY: DJM  
 HORIZ.              CHECKED BY: PJM  
 DATE: 11/08/05