

FAU	SECTION	COUNTY	TOTAL SHEETS	SHEET NO.
2760	1316RS-1	COOK	22	1

STATE OF ILLINOIS
DEPARTMENT OF TRANSPORTATION
DIVISION OF HIGHWAYS

**PROPOSED
HIGHWAY PLANS**

**FAU2760(SHERMER ROAD)
SECTION 1316RS-1
WILLOW ROAD TO OLD WILLOW ROAD
COOK COUNTY
C-91-245-99**

FOR INDEX OF SHEETS, SEE SHEET NO. 2

THE IMPROVEMENT IS LOCATED IN THE VILLAGE OF GLENVIEW IN COOK COUNTY

AVERAGE DAILY TRAFFIC = 14,600

POSTED SPEED LIMIT = 35 MPH



NOTE: WHEREVER IN THESE PLANS OR 42 LS MENTIONED IT SHALL MEAN FAU 2760.

STATE OF ILLINOIS
DEPARTMENT OF TRANSPORTATION
DIVISION OF HIGHWAYS

SUBMITTED March 21, 20 05

Dina O'Keefe
DEPUTY DIRECTOR OF HIGHWAYS, REGION ENGINEER

May 13, 20 05
Mike Nune
ENGINEER OF DESIGN AND ENVIRONMENT

May 13, 20 05
Victor Modesto
DIRECTOR OF HIGHWAYS, CHIEF ENGINEER

**PRINTED BY THE AUTHORITY
OF THE STATE OF ILLINOIS**

DISTRICT 1 DESIGN PLAN PREPARATION ENGINEER: KEN ENG /R. SHAH (847) 705-4437



IMPROVEMENT ENDS
STATION 44+17

IMPROVEMENT BEGINS
STATION 18+13

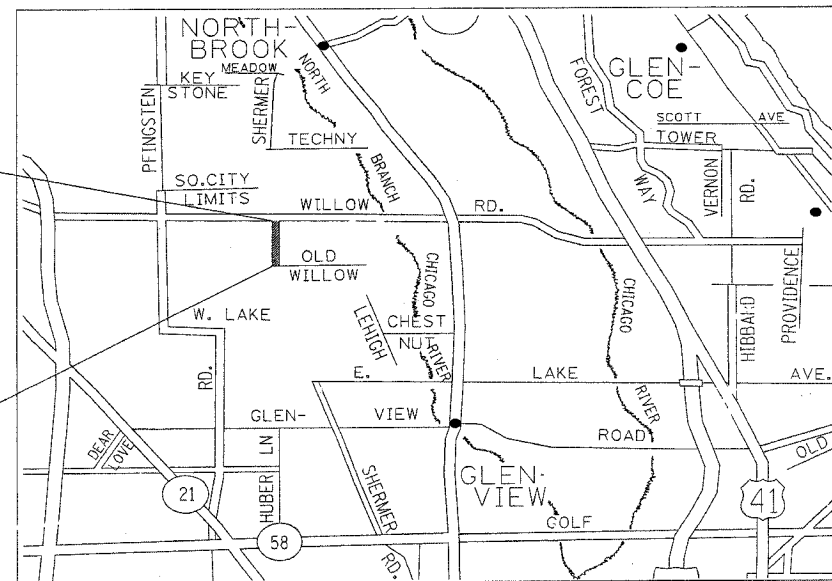

GROSS LENGTH OF IMPROVEMENT = 2,604 LINEAL FEET = 0.500 MILES
NET LENGTH OF IMPROVEMENT = 2,604 LINEAL FEET = 0.500 MILES

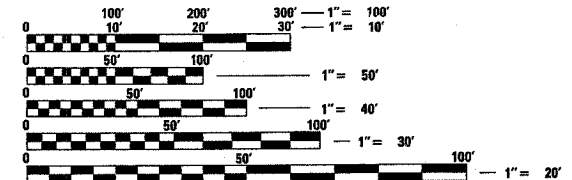

FULL SIZE PLANS HAVE BEEN PREPARED USING STANDARD ENGINEERING SCALES. REDUCED SIZED PLANS WILL NOT CONFORM TO STANDARD SCALES IN MAKING MEASUREMENTS ON REDUCED PLANS, THE ABOVE SCALES MAY BE USED.

J.U.L.I.E.
JOINT UTILITY LOCATION INFORMATION FOR EXCAVATION
1-800-892-0123

CONTRACT NO. 60754

Rev

F.A. RTE.	SECTION	COUNTY	TOTAL SHEETS	SHEET NO.
	1316RS-1	COOK	22	2
FED. ROAD DIST. NO.	ILLINOIS	FED. AID PROJECT		

CONTRACT NO. 60754

INDEX OF SHEETS

SHEET NO.

DESCRIPTION

1	TITLE SHEET
2	INDEX OF SHEETS, STATE STANDARDS, AND GENERAL NOTES
3	SUMMARY OF QUANTITIES
4-8	EXISTING AND PROPOSED TYPICAL SECTIONS
9	ROADWAY AND PAVEMENT MARKING PLANS
10	DETECTOR LOOPS REPLACEMENT PLANS
11	DETAILS FOR FRAMES AND LIDS ADJUSTMENT WITH MILLING
12	PAVEMENT PATCHING FOR BITUMINOUS SURFACED PAVEMENT
13	CURB OR CURB AND GUTTER REMOVAL AND REPLACEMENT
14	BUTT JOINT AND BITUMINOUS TAPER DETAILS
15	METHOD OF FLAGGING
16	TRAFFIC CONTROL AND PROTECTION FOR SIDE ROADS, INTERSECTIONS, AND DRIVEWAYS
17	TYPICAL APPLICATIONS; RAISED REFLECTIVE PAVEMENT MARKERS (SNOW-PLOW RESISTANT)
18	DISTRICT ONE TYPICAL PAVEMENT MARKINGS
19	TRAFFIC CONTROL AND PROTECTION OF TURN BAYS (TO REMIAN OPEN TO TRAFFIC)
20	PAVEMENT MARKING LETTERS AND SYMBOLS FOR TRAFFIC STAGING
21	DISTRICT 1 DETECTOR LOOP INSTALLATION DETAILS FOR ROADWAY RESURFACING
22	TEMPORARY INFORMATION SIGNING

STATE STANDARDS:

000001-04	STANDARD SYMBOLS, ABBREVIATIONS, AND PATTERNS
424001-04	CURB RAMPS ACCESSIBLE TO THE DISABLED
442201-01	CLASS C AND D PATCHES
482011-01	BIT. SHLD STRIPS/SHLDS. WITH RESURFACING OR WIDENING AND RESURFACING PROJECTS
604001-02	FRAME AND LIDS, TYPE 1
606001-02	CONCRETE CURB AND COMBINATION CONCRETE CURB AND GUTTER
701301-02	LANE CLOSURE, 2L, 2W, SHORT TIME OPERATION
701501-03	URBAN LANE CLOSURE, 2L, 2W, UNDIVIDED
701601-04	URBAN LANE CLOSURE MULTILANE, 1-W OR 2-W, WITH NON-TRAVERSABLE MEDIAN, SPEEDS < 45 MPH
701606-04	URBAN LANE CLOSURE MULTILANE 2-W WITH MOUNTABLE MEDIAN
701701-04	URBAN LANE CLOSURE MULTILANE INTERSECTION
702001-05	TRAFFIC CONTROL DEVICES
780001-01	TYPICAL PAVEMENT MARKINGS
886001	DETECTOR LOOP INSTALLATIONS

GENERAL NOTES:

1. BEFORE STARTING ANY EXCAVATION, THE CONTRACTOR SHALL CALL "JULIE" AT 800-892-0123 FOR FIELD LOCATIONS OR BURIED ELECTRIC, TELEPHONE, AND GAS FACILITIES. (48 HOUR NOTIFICATION REQUIRED)
2. THE CONTRACTOR SHALL COORDINATE CONSTRUCTION ACTIVITIES WITH UTILITY COMPANIES AND THE VILLAGES OF PALATINE.
3. THE CONTRACTOR WILL NOT BE ABLE TO SET UP A YARD OR FIELD OFFICE ON STATE PROPERTY WITHOUT THE WRITTEN PERMISSION OF THE DEPARTMENT.
4. ALL BITUMINOUS PAVEMENT PATCHING SHALL BE CLASS D.
5. BUTT JOINTS WILL BE INSTALLED AT THE ENDS OF RESURFACING (WHERE RESURFACING MEETS EXISTING PAVEMENT). IN ACCORDANCE WITH THE "BUTT JOINT AND BITUMINOUS TAPER DETAILS" SHEET INCLUDED IN THE PLANS UNLESS OTHERWISE SPECIFIED.
6. THE RESIDENT ENGINEER SHALL CONTACT MR. WALTER CZARNY, AREA TRAFFIC FIELD ENGINEER, AT (773) 685-8386 A MINIMUM OF 72 HOURS PRIOR TO PLACEMENT OF PERMANENT PAVEMENT MARKINGS.
7. 3 METER (10 FEET) TRANSITION SHALL BE USED TO MATCH PROPOSED CURB AND GUTTER TO EXISTING CURB AND GUTTERS IN THE FIELD, UNLESS OTHERWISE SHOWN. THE TRANSITION SHALL BE PAID FOR AT THE CONTRACT UNIT PRICE FOR THE PROPOSED ITEMS OF WORK SPECIFIED.
8. WHEN MILLED PAVEMENT IS OPEN TO TRAFFIC, THE MAXIMUM GRADE DIFFERENTIAL BETWEEN PASSES OF THE MILLING MACHINE SHALL NOT EXCEED 1/2 INCHES WHERE THE SPEED LIMIT IS 45 MPH OR LESS, AND 1 INCH WHERE THE SPEED LIMIT IS 45 MPH. WITH WRITTEN APPROVAL FROM THE RESIDENT ENGINEER, A MAXIMUM GRADE DIFFERENTIAL OF 3 INCHES MAY BE ALLOWED IF THE EDGE OF THE MILLING IS SLOPED A MINIMUM OF 1:3 (V:H)
9. THE UNIT WEIGHT (CONVERSION FACTOR) QUOTED IS FOR THE ESTIMATING PLAN QUANTITIES ONLY. ACTUAL QUANTITIES TO FULFILL CONTRACT REQUIREMENTS WILL BE DETERMINED BASED ON UNIT WEIGHT OF APPROVED MIX DESIGN, PLAN DIMENSIONS, AND DENSITY LIMITATIONS. MAXIMUM PAYMENT WILL BE COMPUTED BASED ON WEIGHT AVERAGE DENSITIES OF THE IN-PLACE MIXTURE.

REVISIONS	
NAME	DATE

ILLINOIS DEPARTMENT OF TRANSPORTATION
SHERMER ROAD
WILLOW RD. TO OLD WILLOW RD.
INDEX OF SHEETS STATE STANDARDS
AND GENERAL NOTES

SCALE: VERT.
HORIZ.
DATE 4/5/2005
DRAWN BY
CHECKED BY

F.A. RTE.	SECTION	COUNTY	TOTAL SHEETS	SHEET NO.
1316RS-1		COOK	22	3
FED. ROAD DIST. NO. 1	ILLINOIS	HIGHWAY PROJECT		

SUMMARY OF QUANTITIES			CONSTRUCTION TYPE CODE				
CODE NO	ITEM	UNIT	URBAN TOTAL QUANTITIES	1000			
20201006	GRADING AND SHAPING SHOULDERS	UNIT	30	30			
40600200	BITUMINOUS MATERIALS (PRIME COAT)	TON	4	4			
40600300	AGGREGATE (PRIME COAT)	TON	19	19			
40600400	MIXTURE FOR CRACKS, JOINTS, AND FLANGEWAYS	TON	2	2			
40600895	CONSTRUCTING TEST STRIP	EACH	1	1			
40600980	BITUMINOUS SURFACE REMOVAL - BUTT JOINT	SQ YD	75	75			
40601000	BITUMINOUS REPLACEMENT OVER PATCHES	TON	385	385			
44000116	BITUMINOUS REMOVAL OVER PATCHES 4"	SQ YD	1718	1718			
44001700	COMBINATION CONCRETE CURB AND GUTTER REMOVAL AND REPLACEMENT	FOOT	2300	2300			
44201749	CLASS D PATCHES, TYPE I, 9 INCH	SQ YD	105	105			
44201753	CLASS D PATCHES, TYPE II, 9 INCH	SQ YD	282	282			
44201757	CLASS D PATCHES, TYPE III, 9 INCH	SQ YD	59	59			
44201759	CLASS D PATCHES, TYPE IV, 9 INCH	SQ YD	1222	1222			
44300200	STRIP REFLECTIVE CRACK CONTROL TREATMENT	FOOT	5276	5276			
48101200	AGGREGATE SHOULDERS, TYPE B	TON	370	370			
60250200	CATCH BASINS TO BE ADJUSTED	EACH	2	2			
60252800	CATCH BASINS TO BE RECONSTRUCTED	EACH	2	2			
60255500	MANHOLES TO BE ADJUSTED	EACH	2	2			
60260100	INLETS TO BE ADJUSTED	EACH	2	2			
60300310	FRAMES AND LIDS TO BE ADJUSTED (SPECIAL)	EACH	10	10			
67000400	ENGINEER'S FIELD OFFICE, TYPE A	CAL MO	6	6			
67100100	MOBILIZATION	L SUM	1	1			
70102620	TRAFFIC CONTROL AND PROTECTION, STANDARD 701501	L SUM	1	1			
70102625	TRAFFIC CONTROL AND PROTECTION, STANDARD 701606	L SUM	1	1			
70102630	TRAFFIC CONTROL AND PROTECTION, STANDARD 701601	L SUM	1	1			
70102635	TRAFFIC CONTROL AND PROTECTION, STANDARD 701701	L SUM	1	1			
70103815	TRAFFIC CONTROL SURVEILLANCE	CAL DA	20	20			

SUMMARY OF QUANTITIES			CONSTRUCTION TYPE CODE				
CODE NO	ITEM	UNIT	URBAN TOTAL QUANTITIES	1000			CONTRACT NO. 60754
70300100	SHORT-TERM PAVEMENT MARKING	FOOT	983	983			
70300210	TEMPORARY PAVEMENT MARKING - LETTERS AND SYMBOLS	SQ FT	210	210			
70300220	TEMPORARY PAVEMENT MARKING - LINE 4"	FOOT	6545	6545			
70300240	TEMPORARY PAVEMENT MARKING - LINE 6"	FOOT	300	300			
70300260	TEMPORARY PAVEMENT MARKING - LINE 12"	FOOT	140	140			
70300280	TEMPORARY PAVEMENT MARKING - LINE 24"	FOOT	62	62			
70301000	WORK ZONE PAVEMENT MARKING REMOVAL	SQ FT	3038	3038			
*78000100	THERMOPLASTIC PAVEMENT MARKING - LETTERS AND SYMBOLS	SQ FT	36.4	36.4			
*78000200	THERMOPLASTIC PAVEMENT MARKING - LINE 4"	FOOT	6545	6545			
*78000400	THERMOPLASTIC PAVEMENT MARKING - LINE 6"	FOOT	300	300			
*78000600	THERMOPLASTIC PAVEMENT MARKING - LINE 12"	FOOT	140	140			
*78000650	THERMOPLASTIC PAVEMENT MARKING - LINE 24"	FOOT	62	62			
78100100	RAISED REFLECTIVE PAVEMENT MARKER	EACH	100	100			
*88600600	DETECTOR LOOP REPLACEMENT	FOOT	246	246			
X0656100	DRIVEWAY PAVEMENT REMOVAL AND REPLACEMENT	SQ YD	20	20			
X4066426	BITUMINOUS CONCRETE SURFACE COURSE, SUPERPAVE, MIX "D", N70	TON	781	781			
X4066770	LEVELING BINDER (MACHINE METHOD), SUPERPAVE N70	TON	390	390			
X4409410	BITUMINOUS SURFACE REMOVAL 2 1/4"	SQ YD	9222	9222			

* SPECIALTY ITEMS

REVISIONS	
NAME	DATE

ILLINOIS DEPARTMENT OF TRANSPORTATION
SUMMARY OF QUANTITIES
SHERMER ROAD
WILLOW RD. TO OLD WILLOW RD.

PLOT DATE: 4/5/2005

CONTRACT NO. 60754

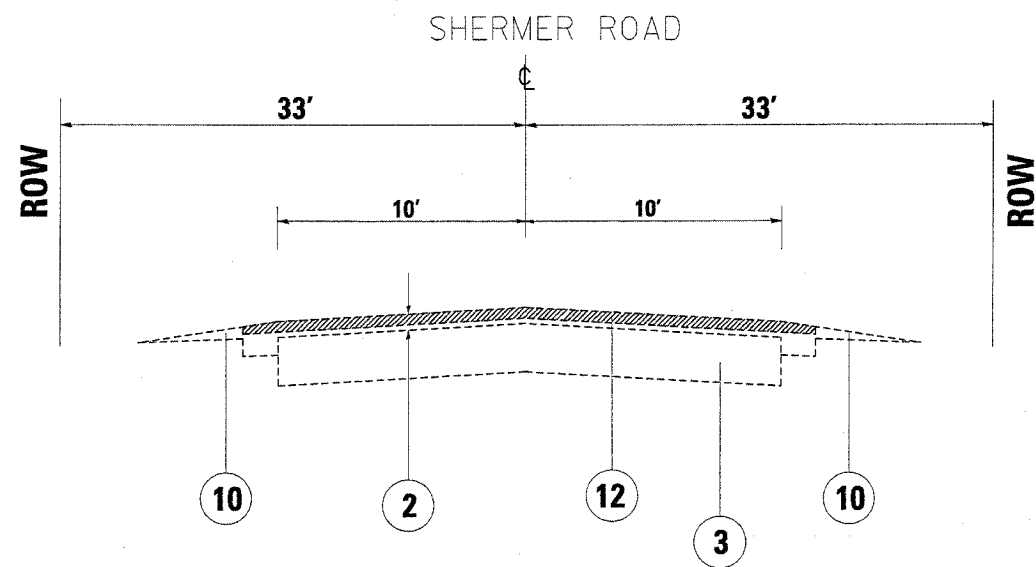

EXISTING TYPICAL CROSS SECTION
STA. 18+13 TO 36+10

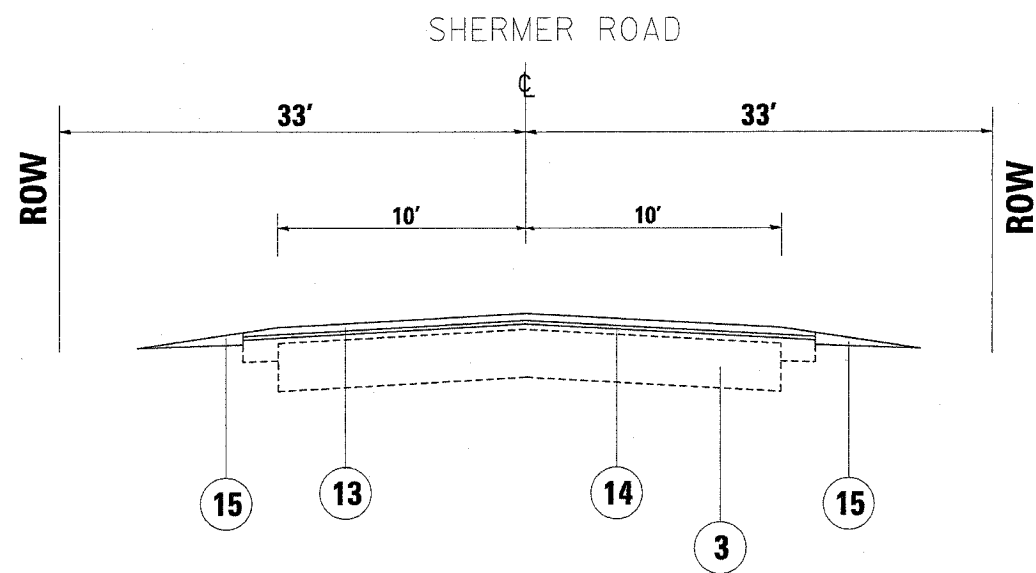

PROPOSED TYPICAL CROSS SECTION
STA. 18+13 TO 36+10

LEGEND

- ① EXISTING COMPACTED EARTH FILL
- ② EXISTING BITUMINOUS CONCRETE OVERLAY, +-3"
- ③ EXISTING P.C.C. PAVEMENT, 9"
- ④ EXISTING SUB-BASE GRANULAR MATERIAL, TYPE A, 6"
- ⑤ EXISTING COMB. CONCRETE CURB & GUTTER, B.6-24
- ⑥ EXISTING COMB. CONCRETE CURB & GUTTER, B-6.12
- ⑦ EXISTING TIE BARS @ 2'-6" CENTERS
- ⑧ EXISTING CONCRETE MEDIAN SURFACE
- ⑨ EXISTING CONCRETE MEDIAN
- ⑩ EXISTING AGGREGATE SHOULDER
- ⑪ EXISTING CONCRETE CURB, TYPE BA
- ⑫ PROP. BITUMINOUS CONCRETE SURFACE REMOVAL, +- 2/4"
- ⑬ PROP. BITUMINOUS CONCRETE SURFACE COURSE, SUPERPAVE, MIX "D", N 70, 1/2"
- ⑭ PROP. POLYMERIZED LEVELING BINDER, (MACHINE METHOD), SUPERPAVE, IL - 4.75, N 50, 3/4"
- ⑮ PROP. AGGREGATE SHOULDERS, TYPE B

MIXTURE TYPE	AC/PG	RAP% MAX	AIR VOIDS (%)
POLYMERIZED LEVELING BINDER (MACHINE METHOD) SUPERPAVE, N50 3/4"	SBS/SBR PG 76-28	0	2.5% @ 50 GYR
BITUMINOUS CONCRETE SURFACE COURSE, SUPERPAVE, MIX D, N70	PG 64-22	10	4% @ 70 GYR
CLASS D PATCHES, 9" BINDER IL. 19MM	PG 64-22	15	4% @ 70 GYR
BITUMINOUS REPLACEMENT OVER PATCHES BINDER IL - 19MM	PG 64-22	15	4% @ 70 GYR

NOTE: THE UNIT WEIGHT USED TO CALCULATE ALL BITUMINOUS SURFACE MIXTURES IS 112 lbs/sydw/in.

REVISIONS	
NAME	DATE

ILLINOIS DEPARTMENT OF TRANSPORTATION
**SHERMER ROAD
WILLOW RD. TO OLD WILLOW RD.**
**EXISTING AND PROPOSED
TYPICAL SECTIONS**

SCALE: VERT.
HORIZ.
DATE 4/6/2005

DRAWN BY
CHECKED BY

F.A. RTE.	SECTION	COUNTY	TOTAL SHEETS	SHEET NO.
	1316RS-1	COOK	22	5
FED. ROAD DIST. NO.	ILLINOIS FED. AID PROJECT			

CONTRACT NO. 60754

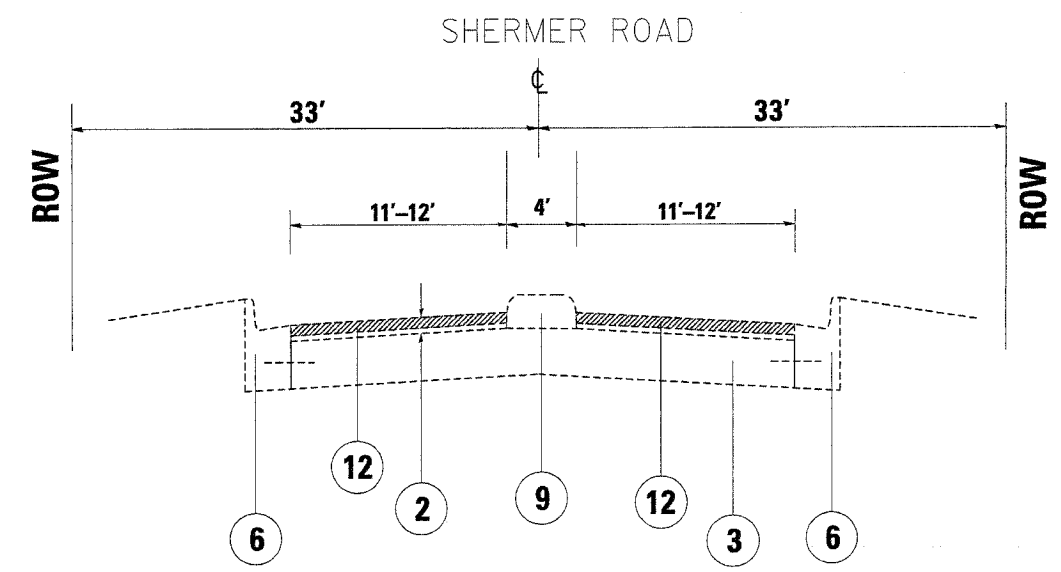

EXISTING TYPICAL CROSS SECTION
STA. 36+10 TO 37+34

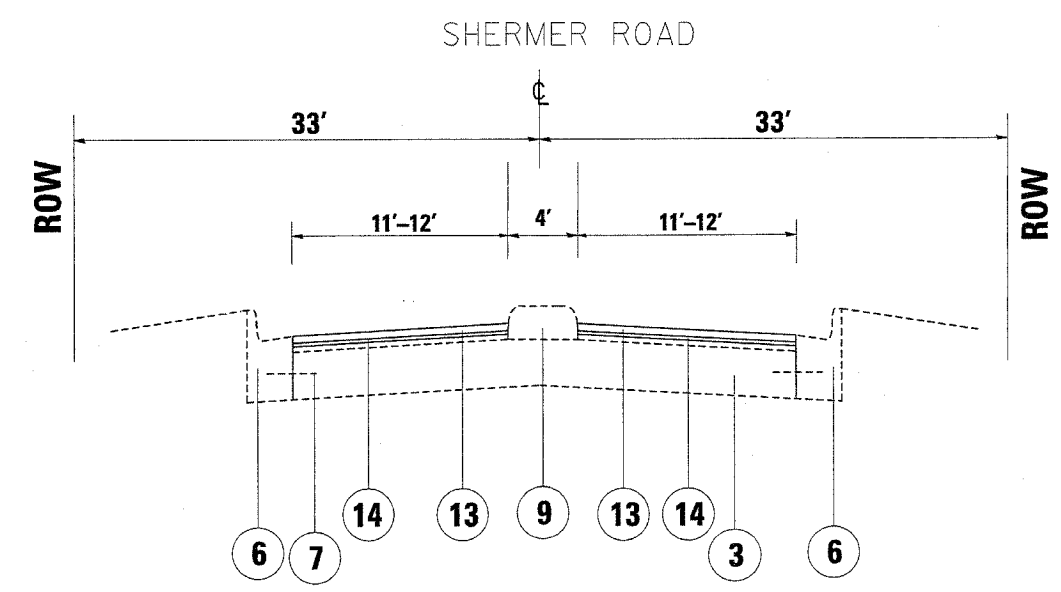

PROPOSED TYPICAL CROSS SECTION
STA. 36+10 TO 37+34

LEGEND

- ① EXISTING COMPACTED EARTH FILL
- ② EXISTING BITUMINOUS CONCRETE OVERLAY, +3"
- ③ EXISTING P.C.C. PAVEMENT, 9"
- ④ EXISTING SUB-BASE GRANULAR MATERIAL, TYPE A, 6"
- ⑤ EXISTING COMB. CONCRETE CURB & GUTTER, B.6-24
- ⑥ EXISTING COMB. CONCRETE CURB & GUTTER, B-6.12
- ⑦ EXISTING TIE BARS @ 2'-6" CENTERS
- ⑧ EXISTING CONCRETE MEDIAN SURFACE
- ⑨ EXISTING CONCRETE MEDIAN
- ⑩ EXISTING AGGREGATE SHOULDER
- ⑪ EXISTING CONCRETE CURB, TYPE BA
- ⑫ PROP. BITUMINOUS CONCRETE SURFACE REMOVAL, +- 2/4"
- ⑬ PROP. BITUMINOUS CONCRETE SURFACE COURSE, SUPERPAVE. MIX "D", N 70, 1 1/2"
- ⑭ PROP. POLYMERIZED LEVELING BINDER, (MACHINE METHOD), SUPERPAVE, IL - 4.75, N 50, 3/4"
- ⑮ PROP. AGGREGATE SHOULDERS, TYPE B

REVISIONS	
NAME	DATE

ILLINOIS DEPARTMENT OF TRANSPORTATION
SHERMER ROAD
WILLOW RD. TO OLD WILLOW RD.
EXISTING AND PROPOSED
TYPICAL SECTIONS

SCALE: VERT. _____
 HORIZ. _____
 DATE 4/6/2005

DRAWN BY _____
 CHECKED BY _____

F.A. RTE.	SECTION	COUNTY	TOTAL SHEETS	SHEET NO.
	1316RS-1	COOK	22	6
FED. ROAD DIST. NO.	ILLINOIS	FED. AID PROJECT		

CONTRACT NO. 60754

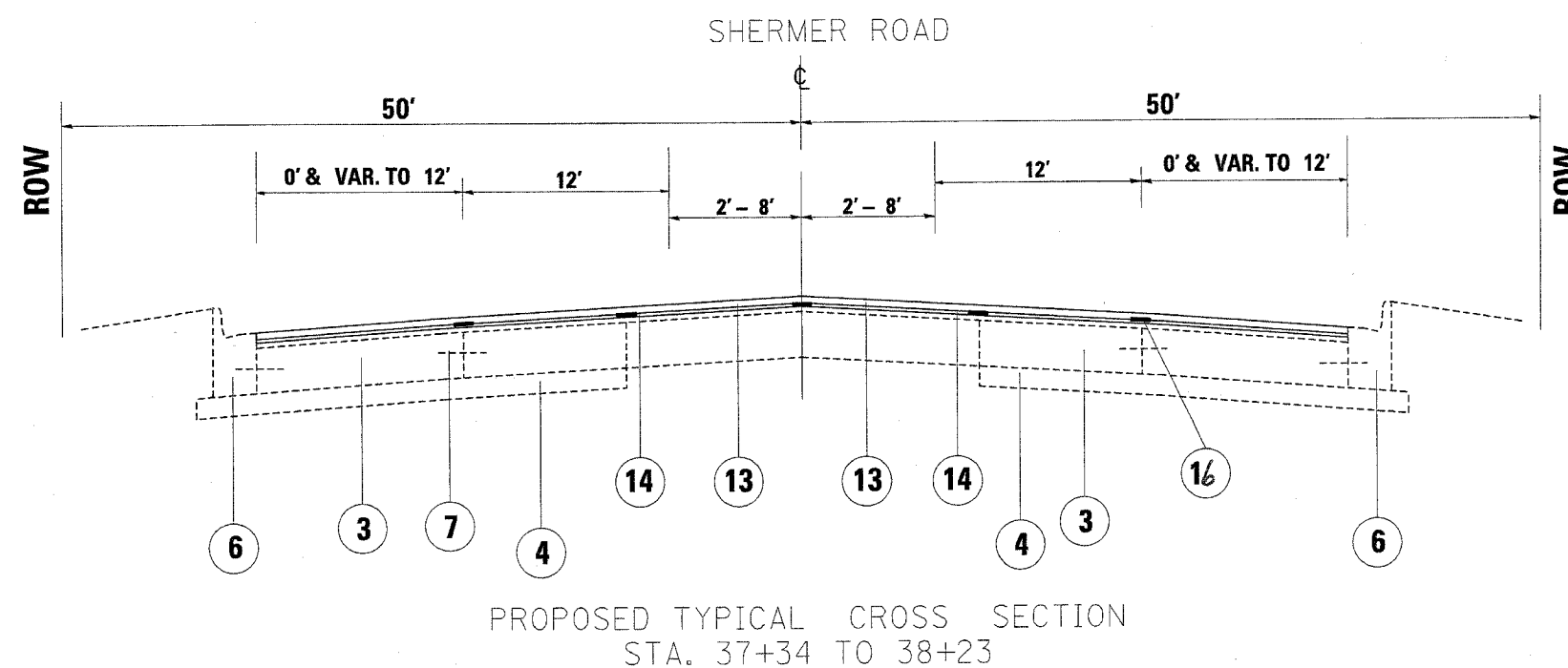
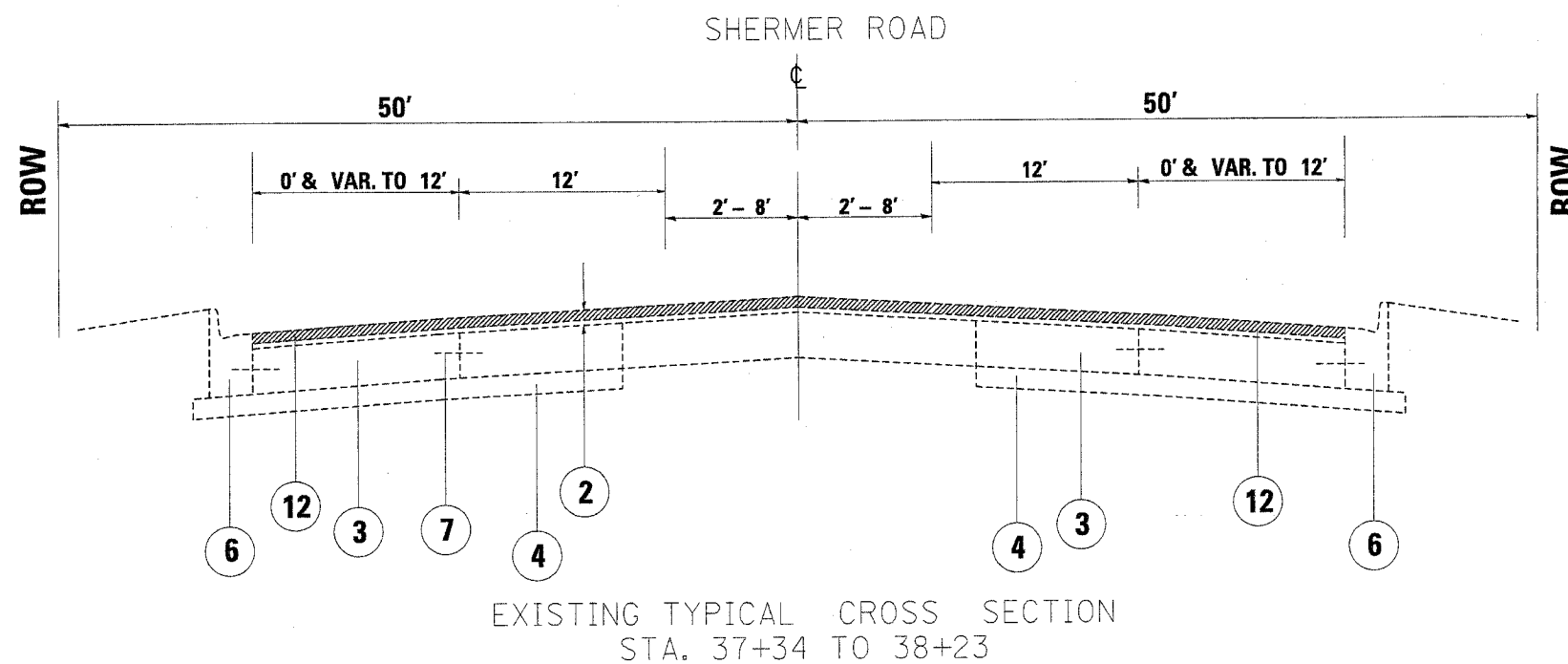

LEGEND

- ① EXISTING COMPACTED EARTH FILL
- ② EXISTING BITUMINOUS CONCRETE OVERLAY, +3"
- ③ EXISTING P.C.C. PAVEMENT, 9"
- ④ EXISTING SUB-BASE GRANULAR MATERIAL, TYPE A, 6"
- ⑤ EXISTING COMB. CONCRETE CURB & GUTTER, B.6-24
- ⑥ EXISTING COMB. CONCRETE CURB & GUTTER, B-6.12
- ⑦ EXISTING TIE BARS @ 2'-6" CENTERS
- ⑧ EXISTING CONCRETE MEDIAN SURFACE
- ⑨ EXISTING CONCRETE MEDIAN
- ⑩ EXISTING AGGREGATE SHOULDER
- ⑪ EXISTING CONCRETE CURB, TYPE BA
- ⑫ PROP. BITUMINOUS CONCRETE SURFACE REMOVAL, +- 2/4"
- ⑬ PROP. BITUMINOUS CONCRETE SURFACE COURSE, SUPERPAVE. MIX "D", N 70, 1 1/2"
- ⑭ PROP. POLYMERIZED LEVELING BINDER, (MACHINE METHOD), SUPERPAVE, IL - 4.75, N 50, 3/4"
- ⑮ PROP. AGGREGATE SHOULDERS, TYPE B
- ⑯ PROP. STRIP REFLECTIVE CRACK CONTROL TREATMENT

REVISIONS	
NAME	DATE

ILLINOIS DEPARTMENT OF TRANSPORTATION
SHERMER ROAD
WILLOW RD. TO OLD WILLOW RD.
EXISTING AND PROPOSED
TYPICAL SECTIONS

SCALE: VERT.
 HORIZ.
 DATE 4/6/2005

DRAWN BY
 CHECKED BY

F.A. RTE.	SECTION	COUNTY	TOTAL SHEETS	SHEET NO.
	1316RS-1	COOK	22	7
STA.		TO STA.		
FED. ROAD DIST. NO. 1		ILLINOIS FED. AID PROJECT		

CONTRACT NO. 60754

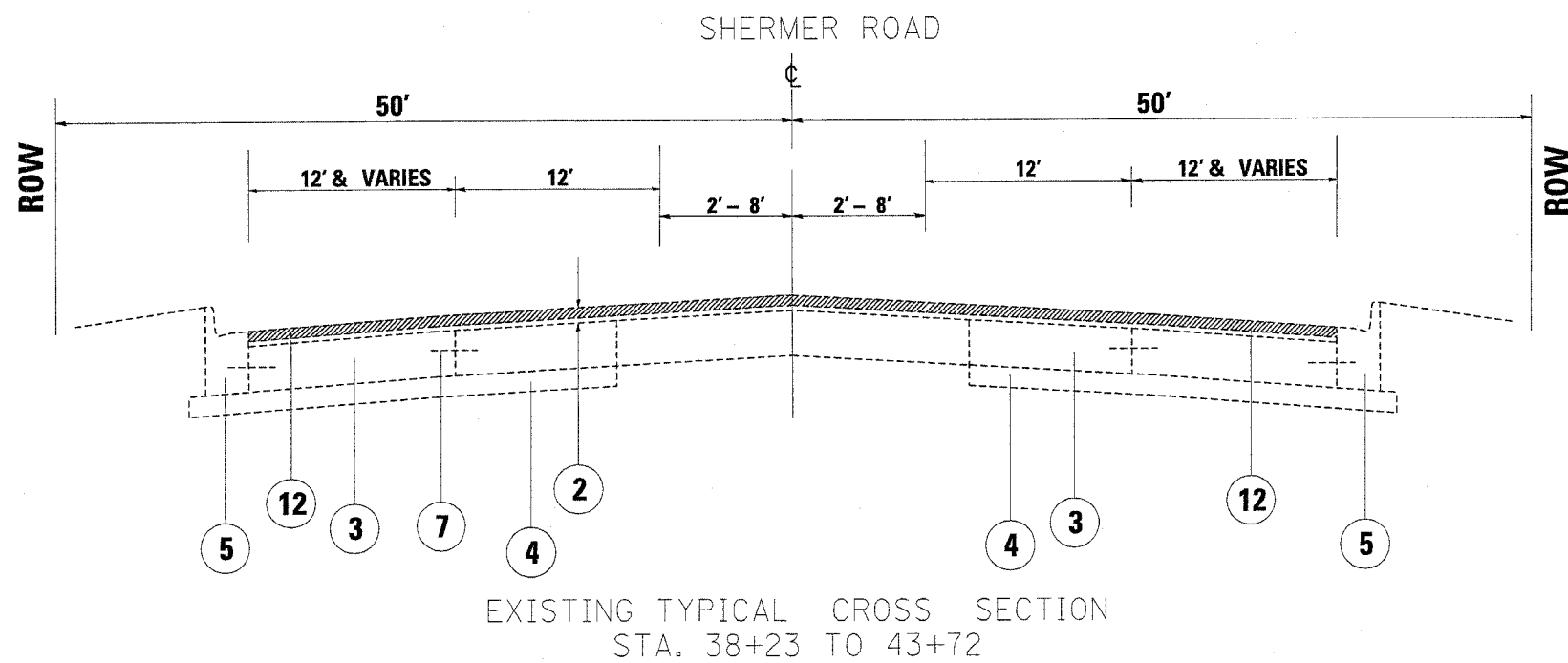

EXISTING TYPICAL CROSS SECTION
STA. 38+23 TO 43+72

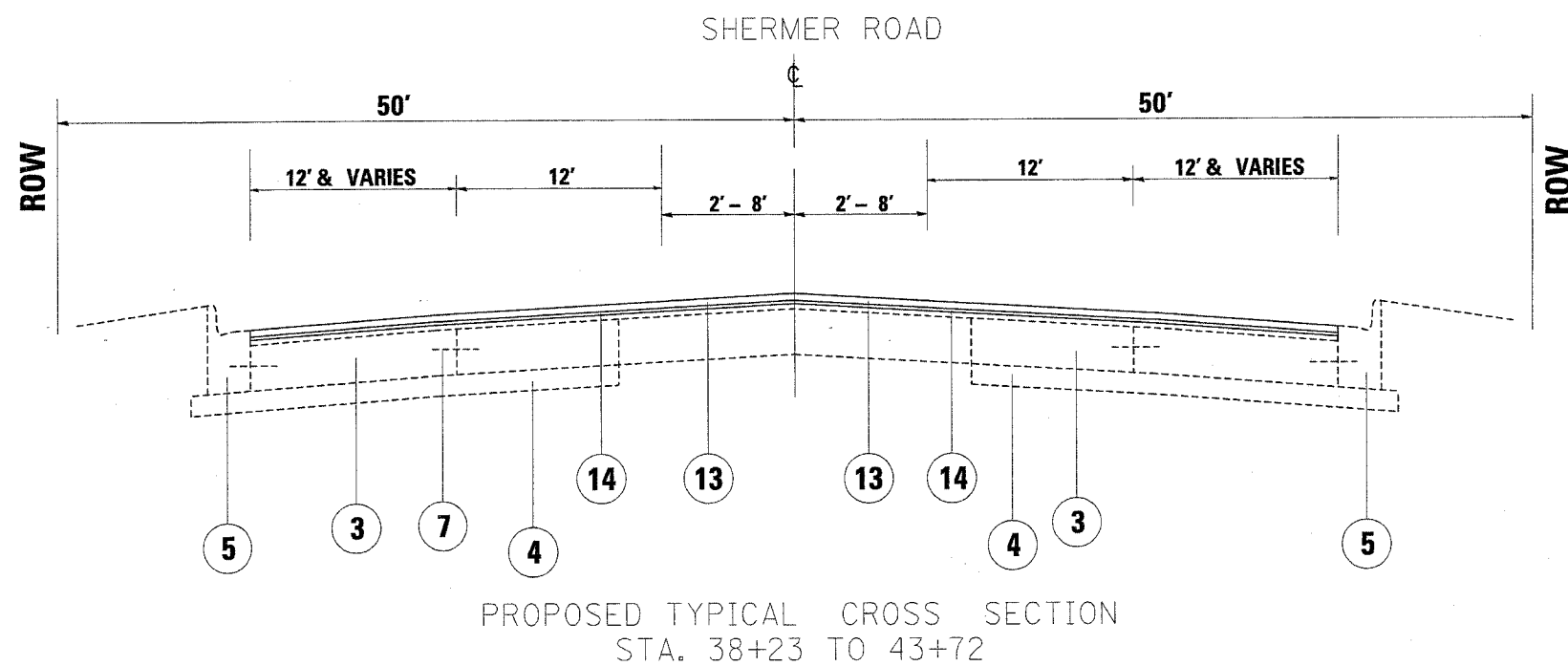

PROPOSED TYPICAL CROSS SECTION
STA. 38+23 TO 43+72

LEGEND

- ① EXISTING COMPACTED EARTH FILL
- ② EXISTING BITUMINOUS CONCRETE OVERLAY, +3"
- ③ EXISTING P.C.C. PAVEMENT, 9"
- ④ EXISTING SUB-BASE GRANULAR MATERIAL, TYPE A, 6"
- ⑤ EXISTING COMB. CONCRETE CURB & GUTTER, B-6-24
- ⑥ EXISTING COMB. CONCRETE CURB & GUTTER, B-6.12
- ⑦ EXISTING TIE BARS @ 2'-6" CENTERS
- ⑧ EXISTING CONCRETE MEDIAN SURFACE
- ⑨ EXISTING CONCRETE MEDIAN
- ⑩ EXISTING AGGREGATE SHOULDER
- ⑪ EXISTING CONCRETE CURB, TYPE BA
- ⑫ PROP. BITUMINOUS CONCRETE SURFACE REMOVAL, +- 2 1/4"
- ⑬ PROP. BITUMINOUS CONCRETE SURFACE COURSE, SUPERPAVE, MIX "D", N 70, 1 1/2"
- ⑭ PROP. POLYMERIZED LEVELING BINDER, (MACHINE METHOD), SUPERPAVE, IL - 4.75, N 50, 3/4"
- ⑮ PROP. AGGREGATE SHOULDERS, TYPE B

REVISIONS	
NAME	DATE

ILLINOIS DEPARTMENT OF TRANSPORTATION
SHERMER ROAD
WILLOW RD. TO OLD WILLOW RD.
EXISTING AND PROPOSED
TYPICAL SECTIONS

SCALE: VERT.
HORIZ.
DATE 4/6/2005

DRAWN BY
CHECKED BY

REF.

REF.

F.A. RTE.	SECTION	COUNTY	TOTAL SHEETS	SHEET NO.
	1316RS-1	COOK	22	8
STA.		TO STA.		
FED. ROAD DIST. NO. 1		ILLINOIS	FED. AID PROJECT	

CONTRACT NO. 60754

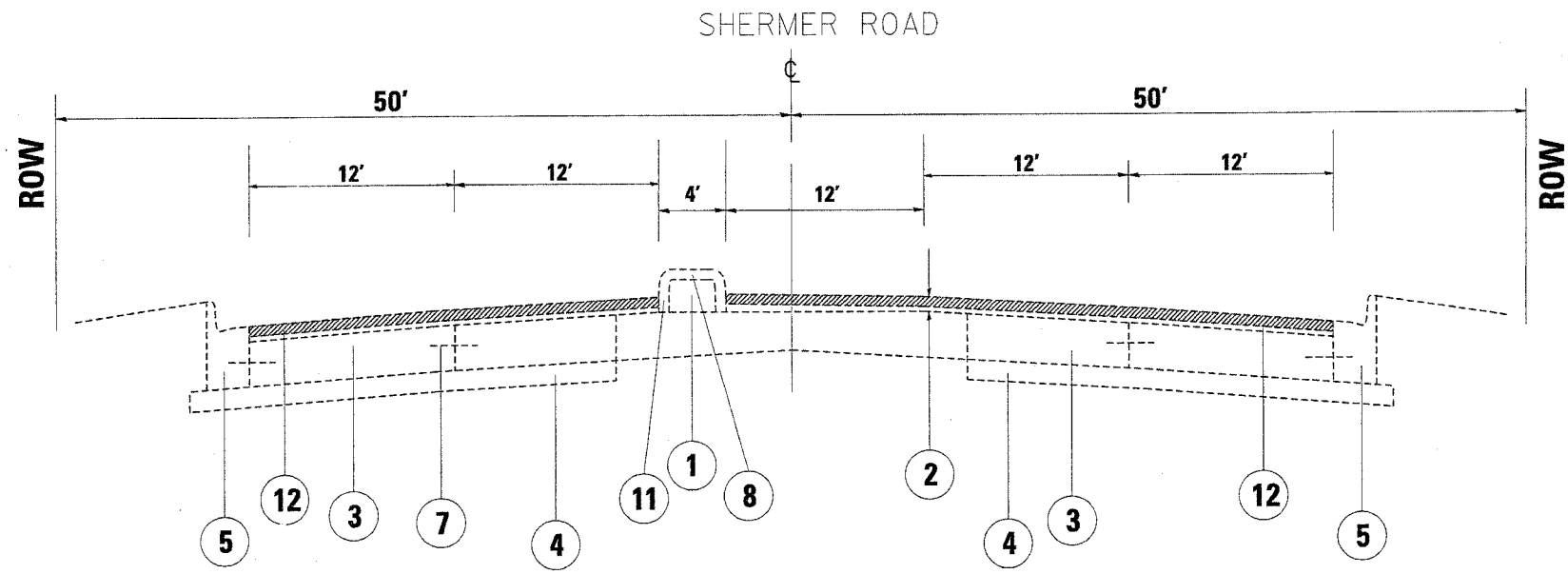

EXISTING TYPICAL CROSS SECTION
STA. 43+72 TO 44+17

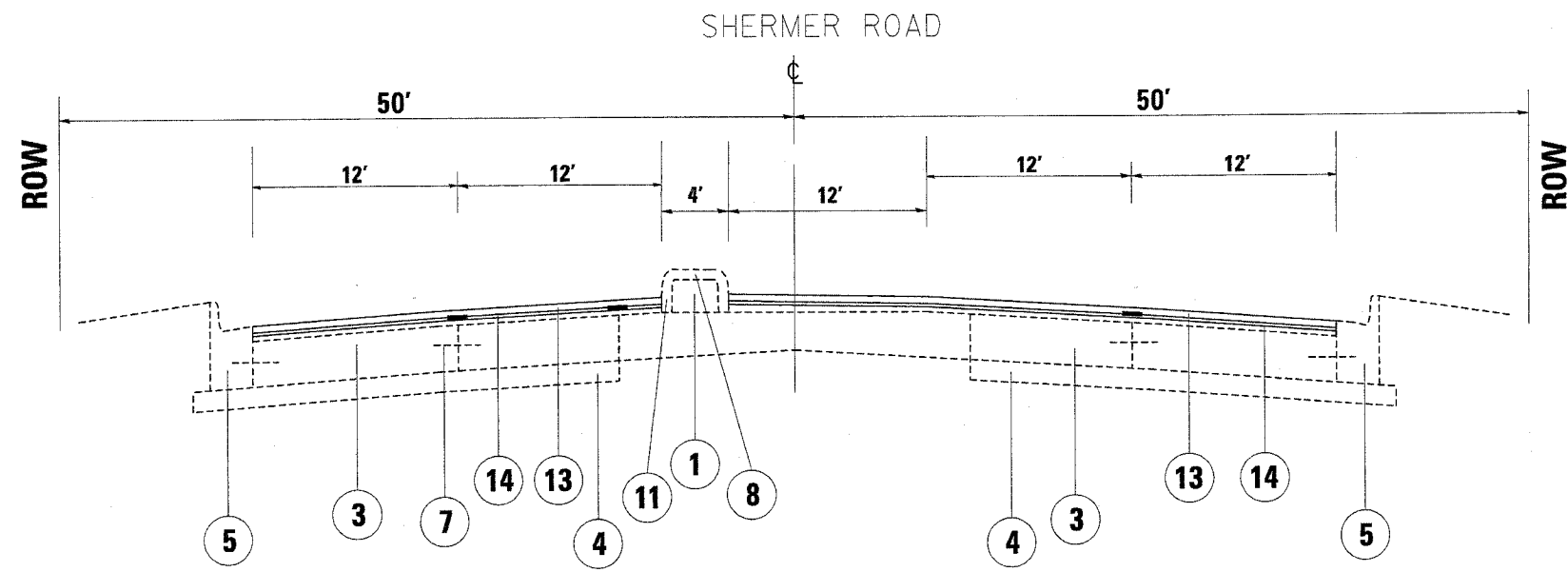

PROPOSED TYPICAL CROSS SECTION
STA. 43+72 TO 44+17

LEGEND

- ① EXISTING COMPACTED EARTH FILL
- ② EXISTING BITUMINOUS CONCRETE OVERLAY, 4-3"
- ③ EXISTING P.C.C. PAVEMENT, 9"
- ④ EXISTING SUB-BASE GRANULAR MATERIAL, TYPE A, 6"
- ⑤ EXISTING COMB. CONCRETE CURB & GUTTER, B.6-24
- ⑥ EXISTING COMB. CONCRETE CURB & GUTTER, B-6.12
- ⑦ EXISTING TIE BARS @ 2'-6" CENTERS
- ⑧ EXISTING CONCRETE MEDIAN SURFACE
- ⑨ EXISTING CONCRETE MEDIAN
- ⑩ EXISTING AGGREGATE SHOULDER
- ⑪ EXISTING CONCRETE CURB, TYPE BA
- ⑫ PROP. BITUMINOUS CONCRETE SURFACE REMOVAL, +- 2/4"
- ⑬ PROP. BITUMINOUS CONCRETE SURFACE COURSE, SUPERPAVE. MIX "D", N 70, 1 1/2"
- ⑭ PROP. POLYMERIZED LEVELING BINDER, (MACHINE METHOD), SUPERPAVE. IL - 4.75, N 50, 3/4"
- ⑮ PROP. AGGREGATE SHOULDERS, TYPE B

REVISIONS	
NAME	DATE

ILLINOIS DEPARTMENT OF TRANSPORTATION
SHERMER ROAD
WILLOW RD. TO OLD WILLOW RD.
EXISTING AND PROPOSED
TYPICAL SECTIONS

VERT. SCALE: DATE 4/6/2005
HORIZ. SCALE: DATE 4/6/2005
DRAWN BY
CHECKED BY

07:54:43 04/06/2005

F.A. RTE.	SECTION	COUNTY	TOTAL SHEETS	SHEET NO.
	1316RS-1	COOK	22	9
FED. ROAD DIST. NO.	ILLINOIS FED. AID PROJECT			

CONTRACT NO. 60754

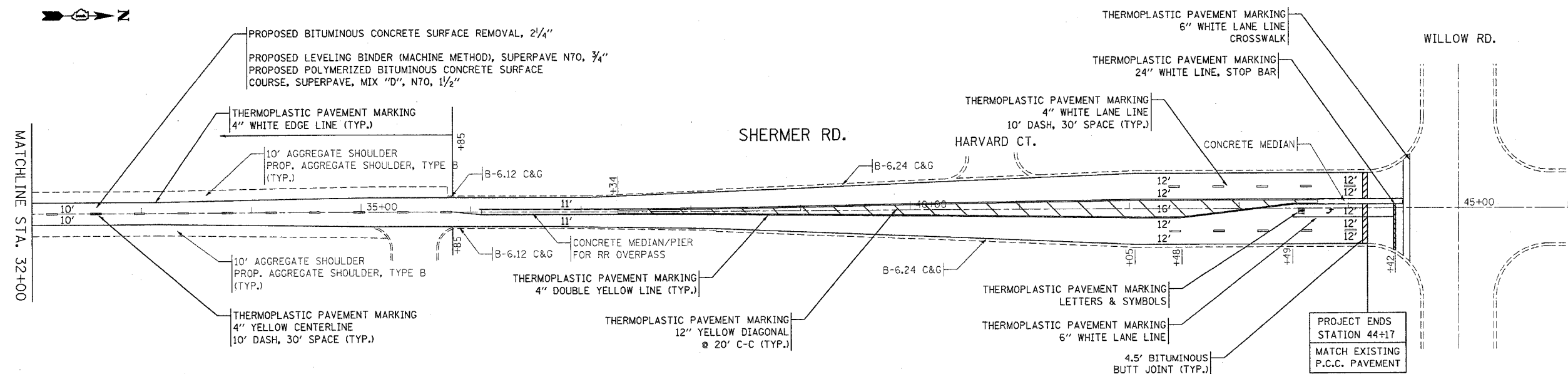
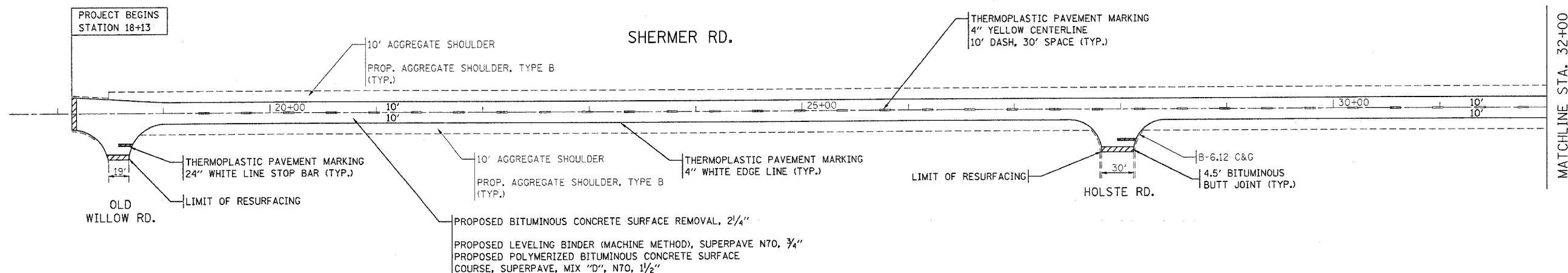

REVISIONS	
NAME	DATE

ILLINOIS DEPARTMENT OF TRANSPORTATION
**SHERMER ROAD
 WILLOW RD. TO OLD WILLOW RD.**
ROADWAY PLAN
 SCALE: VERT. 1" = 50'
 HORIZ. DATE 4/6/2005
 DRAWN BY
 CHECKED BY

RTE.	SECTION	COUNTY	TOTAL SHEETS	SHEET NO.
1316RS-1		COOK	22	10
STA.		TO STA.		
FED. ROAD DIST. NO. 7		PLANNING	FED. AID PROJECT	

60754

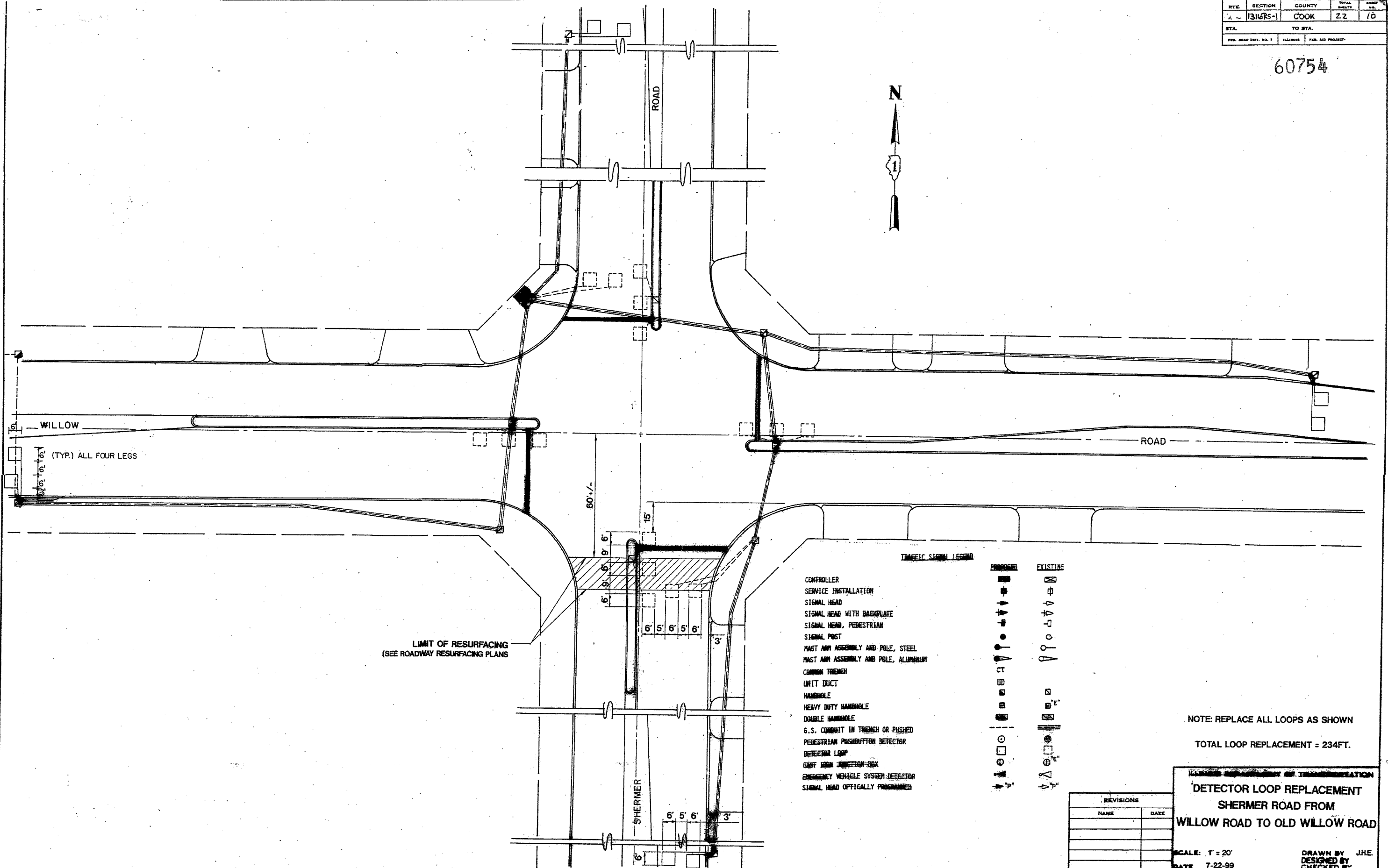

Traffic Signal Legend

PROPOSED	EXISTING
CONTROLLER	
SERVICE INSTALLATION	
SIGNAL HEAD	
SIGNAL HEAD WITH BACKPLATE	
SIGNAL HEAD, PEDESTRIAN	
SIGNAL POST	
PAST AMP ASSEMBLY AND POLE, STEEL	
PAST AMP ASSEMBLY AND POLE, ALUMINUM	
COMMON TRENCH	
UNIT DUCT	
HANDHOLE	
HEAVY DUTY HANDHOLE	
DOUBLE HANDHOLE	
G.S. CONDUIT IN TRENCH OR PUSHED	
PEDESTRIAN PUSHBUTTON DETECTOR	
DETECTOR LOOP	
CAST IRON JUNCTION BOX	
EMERGENCY VEHICLE SYSTEM DETECTOR	
SIGNAL HEAD OPTICALLY PROGRAMMED	

NOTE: REPLACE ALL LOOPS AS SHOWN
TOTAL LOOP REPLACEMENT = 234FT.

ILLINOIS DEPARTMENT OF TRANSPORTATION
DETECTOR LOOP REPLACEMENT
SHERMER ROAD FROM
WILLOW ROAD TO OLD WILLOW ROAD

REVISIONS	
NAME	DATE

SCALE: 1" = 20'
DATE: 7-22-99
DRAWN BY: J.H.E.
DESIGNED BY:
CHECKED BY:

P.L. NO.	SECTION	COUNTY	TOTAL SHEETS	SHEET NO.
	1316RS-1	COOK	22	11
STA.	TO STA.			
FED. ROAD DIST. NO.	ILLINOIS	FED. AID PROJECT		

60754

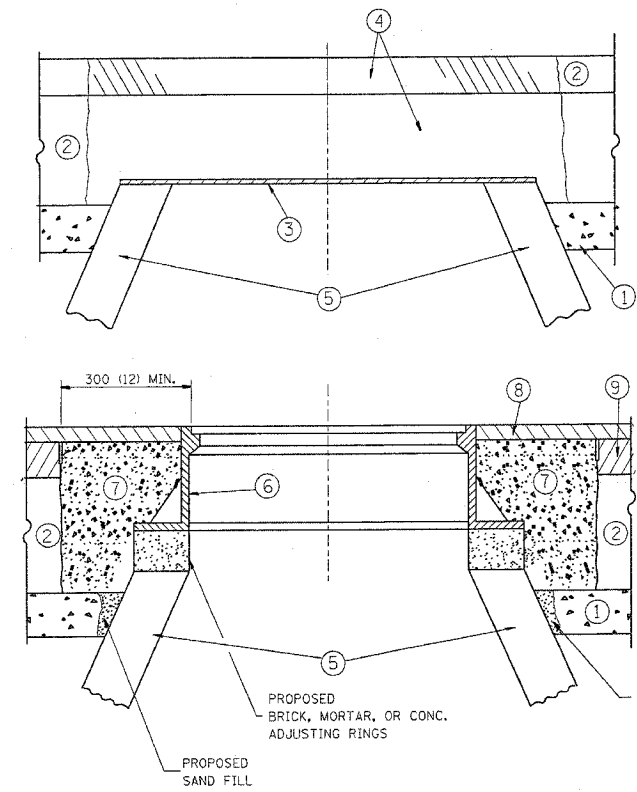

CONSTRUCTION PROCEDURES

- STAGE 1 (BEFORE PAVEMENT MILLING)**
- A) REMOVE A MINIMUM OF 300 (12) OF THE PAVEMENT FROM AROUND THE STRUCTURE.
 - B) REMOVE THE EXISTING FRAME AND LID FROM THE STRUCTURE.
 - C) COVER THE STRUCTURE OPENING WITH A 900 (36) DIAMETER METAL PLATE.
 - D) BACKFILL WITH CRUSHED STONE AND A MINIMUM 40 (1 1/2) THICK BITUMINOUS MATERIAL APPROVED BY THE ENGINEER.
- STAGE 2 (AFTER PAVEMENT MILLING)**
- A) REMOVE THE BITUMINOUS MATERIAL AND CRUSHED STONE.
 - B) INSTALL THE FRAME AND LID; ADJUST THE FRAME TO ITS FINAL SURFACE ELEVATION.
 - C) THE SURROUNDING SPACE SHALL BE FILLED WITH CLASS SI CONCRETE, OR BITUMINOUS CONCRETE SURFACE OR BINDER COURSE MATERIAL TO THE ELEVATION OF THE SURFACE OF THE EXISTING BASE COURSE OR THE BINDER COURSE.

THE PROCEDURE EXPLAINED ABOVE SHALL CONFORM TO THE APPLICABLE PORTIONS OF SECTIONS 353, 406, 602, AND 603 OF THE STANDARD SPECIFICATIONS.

LEGEND

- ① SUB-BASE GRANULAR MATERIAL
- ② EXISTING PAVEMENT
- ③ 900 (36) DIAMETER METAL PLATE
- ④ PROPOSED CRUSHED STONE AND BITUMINOUS MATERIAL
- ⑤ EXISTING STRUCTURE
- ⑥ FRAME AND LID (SEE NOTES)
- ⑦ CLASS SI CONCRETE, BITUMINOUS CONCRETE SURFACE OR BINDER COURSE MATERIAL
- ⑧ PROPOSED BITUMINOUS CONCRETE SURFACE COURSE
- ⑨ PROPOSED BITUMINOUS CONCRETE BINDER COURSE

NOTES:

EXISTING BROKEN FRAMES AND LIDS SHALL BE REMOVED AND DISPOSED OF BY THE CONTRACTOR AND SHALL BE REPLACED AS DIRECTED BY THE ENGINEER. REPLACEMENT FRAMES AND LIDS WILL BE PAID FOR IN ACCORDANCE WITH ARTICLE 109.04 OF THE STANDARD SPECIFICATIONS UNLESS A SEPARATE PAY ITEM HAS BEEN PROVIDED.

IF THE EXISTING LIDS ARE OPEN, THE FRAME WILL BE ADJUSTED TO THE ELEVATION OF THE MILLED PAVEMENT SURFACE PRIOR TO THE MILLING OPERATION. THE FRAME WILL NOT BE REMOVED AND COVERED BY THE METAL PLATE.

CITY OF CHICAGO CASTINGS ARE THE PROPERTY OF THE CITY AND THE CONTRACTOR SHALL NOTIFY THE CITY FOR REMOVAL AND DISPOSITION OF THE CASTINGS.

THE METAL PLATE USED TO COVER THE STRUCTURE SHALL REMAIN THE PROPERTY OF THE CONTRACTOR.

WHEN STRUCTURES ARE TO BE ADJUSTED OR RECONSTRUCTED, THE LOWERING AND RAISING OF THE FRAMES AND LIDS WILL NOT BE PAID FOR SEPARATELY BUT WILL BE INCLUDED IN THE COST OF THE CORRESPONDING PAY ITEM.

LOCATION OF STRUCTURES:

THE CONTRACTOR WILL BE REQUIRED TO KEEP A RECORD OF THE LOCATIONS OF THE BURIED STRUCTURES ACCORDING TO THE STATION AND DISTANCE LEFT OR RIGHT OF THE CENTERLINE OF PAVEMENT. UPON COMPLETION OF THE WORK, THE CONTRACTOR WILL DELIVER THE RECORD TO THE ENGINEER.

BASIS OF PAYMENT: FRAMES AND LIDS TO BE ADJUSTED, SPECIAL EACH
NEW FRAMES AND LIDS, WHEN SPECIFIED, WILL BE PAID FOR SEPARATELY.

DETAILS FOR FRAMES AND LIDS ADJUSTMENT WITH MILLING

ALL DIMENSIONS ARE IN MILLIMETERS (INCHES) UNLESS OTHERWISE SHOWN

ILLINOIS DEPARTMENT OF TRANSPORTATION

DETAILS FOR FRAMES AND LIDS ADJUSTMENT WITH MILLING

REVISIONS	
NAME	DATE
R. SHAH	10/25/94
R. SHAH	01/30/95
R. SHAH	03/10/95
A. ABBAS	03/21/97
R. WIEDEMAN	05/14/04

SCALE: NONE
DATE: 3/18/2005
DRAWN BY
CHECKED BY
BD600-03 (BD-B)
REVISION DATE: 05/17/04

60754

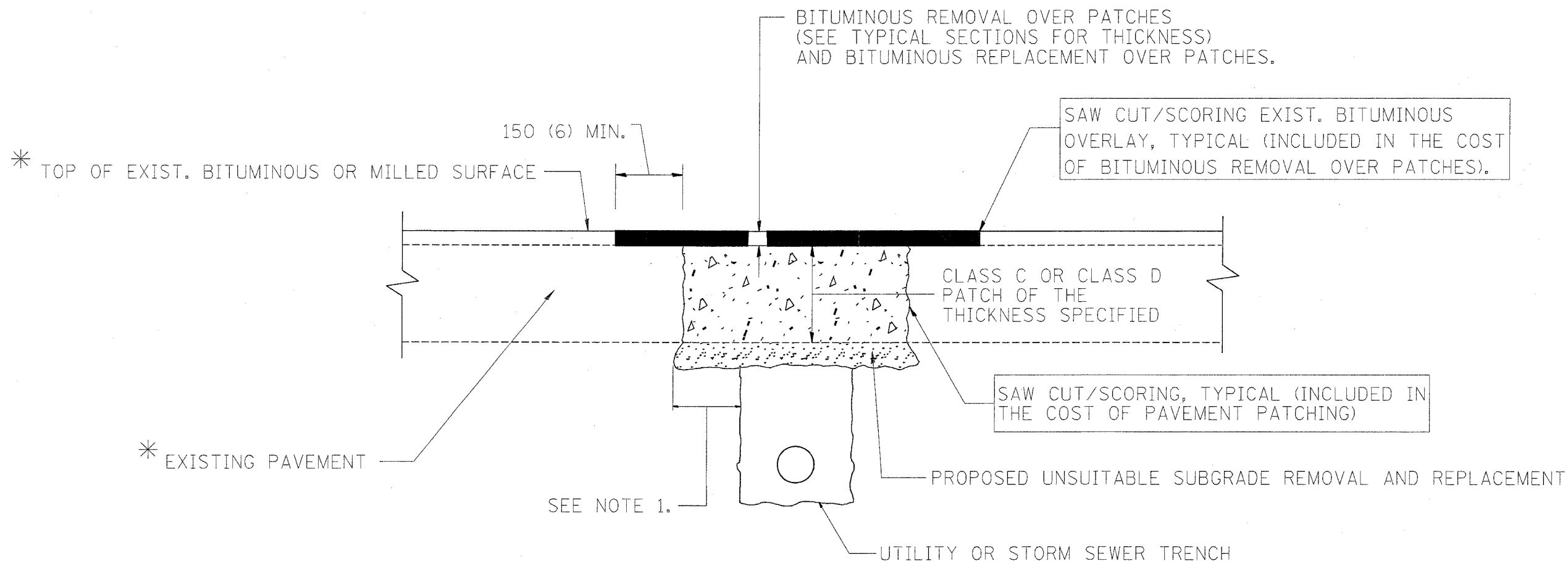

* SEE TYPICAL SECTIONS FOR THICKNESS AND MATERIALS

NOTES:

1. THE WIDTH OF THE FULL DEPTH PATCH OVER A TRENCH SHALL BE 300 (12) WIDER ON EACH SIDE OF THE TRENCH.
2. FOR METHOD OF MEASUREMENT AND BASIS OF PAYMENT, SEE SPECIAL PROVISION "PATCHING WITH BITUMINOUS OVERLAY REMOVAL".

SEQUENCE OF CONSTRUCTION

1. REMOVE THE EXISTING BITUMINOUS MATERIAL OVER THE AREA TO BE PATCHED.
2. REMOVE AND REPLACE FULL DEPTH PATCHES
3. REPLACE BITUMINOUS MATERIAL OVER THE AREA TO BE PATCHED.

ALL DIMENSIONS ARE IN MILLIMETERS (INCHES) UNLESS OTHERWISE SHOWN.

REVISIONS	
NAME	DATE
R. SHAH	10/25/94
R. SHAH	01/14/95
R. SHAH	03/23/95
R. SHAH	04/24/95
A. HOUSEH	03/15/96
A. ABBAS	03/21/97
A. ABBAS	01/20/98
ART ABBAS	04/27/98

ILLINOIS DEPARTMENT OF TRANSPORTATION

PAVEMENT PATCHING FOR BITUMINOUS SURFACED PAVEMENT

SCALE: VERT. HORIZ. DATE 3/18/2005

DRAWN BY CHECKED BY

BD400-04 (BD-22) REVISION DATE: 04/27/98

P.L. REL.	SECTION	COUNTY	TOTAL SHEETS	SHEET NO.
	1316RS-1	COOK	22	13
STA.		TO STA.		FED. AID PROJECT
FED. ROAD DIST. NO.		BLINER	60754	

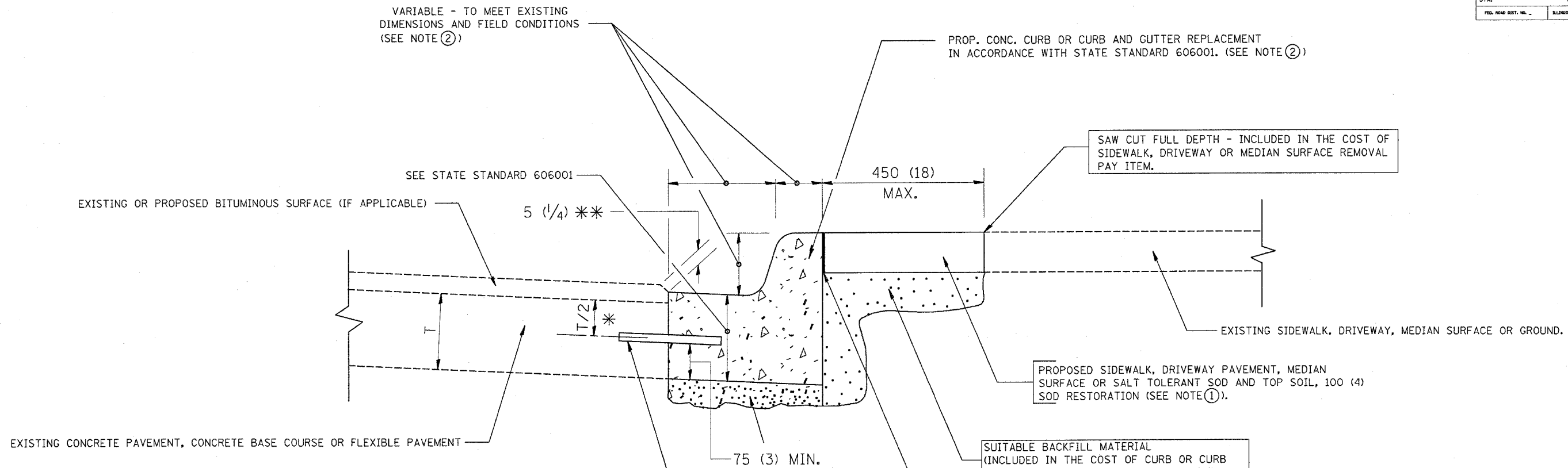

- * 75 (3) MINIMUM FROM TOP AND BOTTOM OF THE CONCRETE PAVEMENT OR BASE COURSE.
- * * IF THE FINAL SURFACE OF THE PAVEMENT IS CONCRETE, THE GUTTER IS TO BE FLUSH WITH THE PAVEMENT.

- NOTE: ① SIDEWALK, DRIVEWAY PAVEMENT OR MEDIAN SURFACE SHALL BE SIMILAR TO THE MATERIAL BEING REMOVED AND WILL BE PAID FOR SEPARATELY.
- SALT TOLERANT SOD AND TOP SOIL, 100 (4) RESTORATION WILL NOT BE PAID FOR SEPARATELY, BUT SHALL BE INCLUDED IN THE COST OF CURB OR CURB AND GUTTER REMOVAL AND REPLACEMENT.
- ② CURB OR CURB AND GUTTER REPLACEMENT SHALL MATCH THE SHAPE OF THE EXISTING CURB OR CURB AND GUTTER UNLESS OTHERWISE SPECIFIED.
- ③ FOR CURB OR CURB AND GUTTER REMOVAL AND REPLACEMENT ADJACENT TO FLEXIBLE PAVEMENT DELETE EPOXY COATED TIE BARS.
- ④ LONGITUDINAL BARS, IF ENCOUNTERED IN THE EXISTING CURB OR CURB AND GUTTER, ARE NOT TO BE REPLACED. CUTTING AND REMOVING LONGITUDINAL BARS SHALL BE INCLUDED IN THE COST OF CURB OR CURB AND GUTTER REMOVAL AND REPLACEMENT.
- ⑤ THE COST OF BITUMINOUS SURFACE REMOVAL IN THE EXISTING GUTTER FLAG SHALL BE INCLUDED IN THE COST OF THE CURB AND GUTTER REMOVAL AND REPLACEMENT.
- ⑥ THE REMOVAL AND REPLACEMENT OF THE EXISTING CURB OR CURB AND GUTTER SHALL BE DONE IN ACCORDANCE WITH THE APPLICABLE PORTIONS OF SECTION 440 AND 606 OF THE STANDARD SPECIFICATIONS.
- ⑦ THE LOCATIONS OF REMOVAL AND REPLACEMENT OF EXISTING CURB OR CURB AND GUTTER SHALL BE DETERMINED BY THE RESIDENT ENGINEER AT THE TIME OF CONSTRUCTION.

BASIS OF PAYMENT:
 THIS WORK WILL BE PAID FOR AT THE CONTRACT UNIT PRICE PER METER (FOOT) FOR "CURB REMOVAL AND REPLACEMENT" OR "COMBINATION CONCRETE CURB AND GUTTER REMOVAL AND REPLACEMENT".

CURB OR CURB AND GUTTER REMOVAL AND REPLACEMENT

REVISIONS	
NAME	DATE
M. DE YONG	05/28/91
A. HOUSEH	03/11/94
R. SHAH	02/24/95
R. SHAH	03/02/95
R. SHAH	08/19/96
R. SHAH	09/12/96
R. SHAH	09/19/96
R. SHAH	10/03/96
A. ABBAS	03/21/97
M. GOMEZ	01/22/01

ALL DIMENSIONS ARE IN MILLIMETERS (INCHES) UNLESS OTHERWISE SHOWN.

ILLINOIS DEPARTMENT OF TRANSPORTATION
**CURB OR
 CURB AND GUTTER
 REMOVAL AND REPLACEMENT**

SCALE: NONE
 DATE: 3/18/2005
 DRAWN BY:
 CHECKED BY:
 BD600-06 (BD-24)
 REVISION DATE: 12/06/88

3/18/2005 03:38:43

3/18/2005
 W:\d1st1st\bd24.dgn
 VI-BD24
 banksl

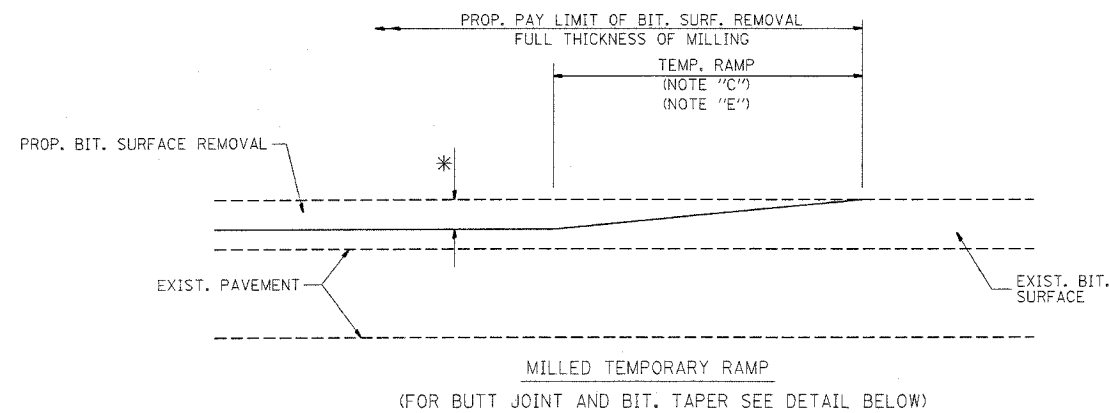

OPTION 1

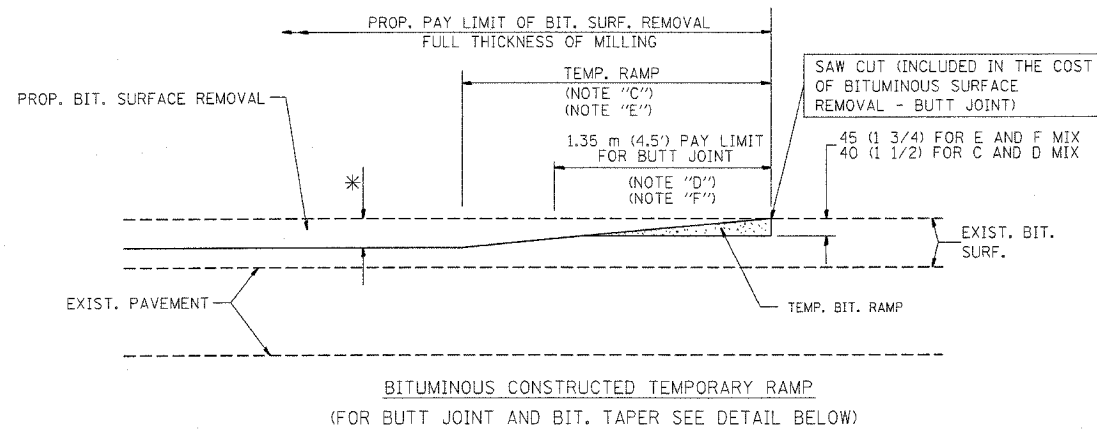

OPTION 2
TYPICAL TEMPORARY RAMP

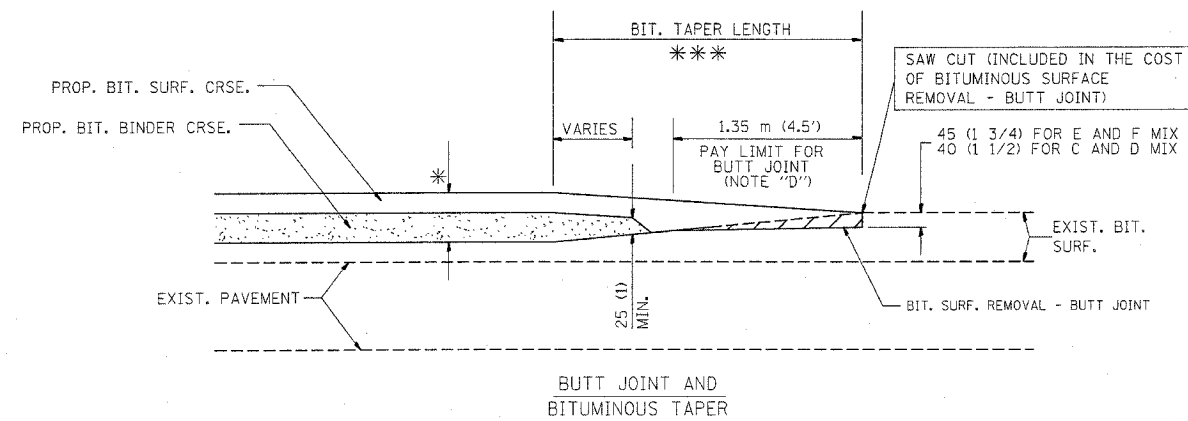

TYPICAL BUTT JOINT AND BITUMINOUS TAPER
FOR MILLING AND RESURFACING

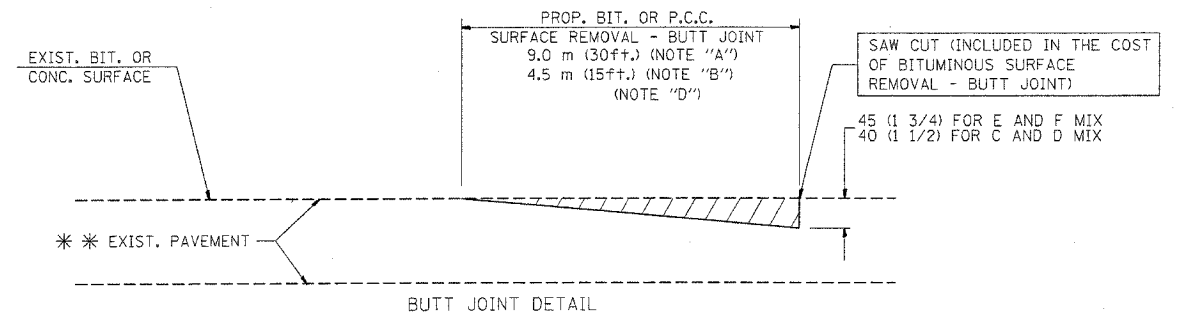

BUTT JOINT DETAIL

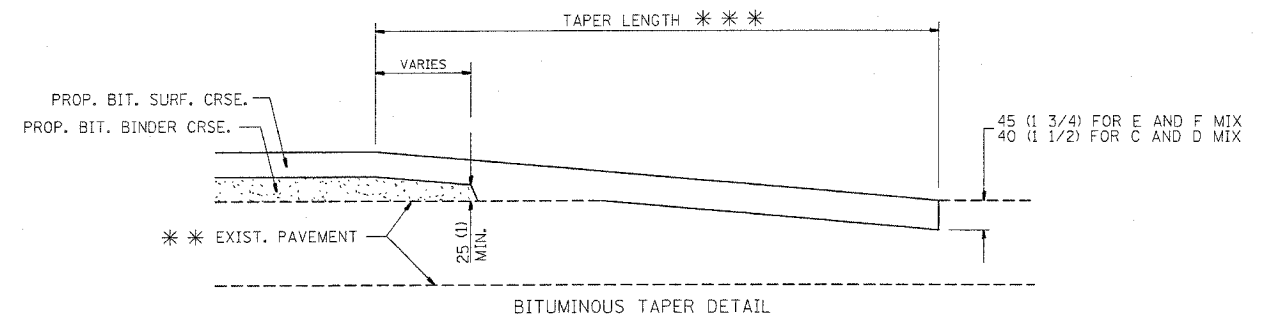

BITUMINOUS TAPER DETAIL

TYPICAL BUTT JOINT AND BITUMINOUS TAPER
FOR RESURFACING ONLY

*** PC CONCRETE, BITUMINOUS OR BITUMINOUS RESURFACED PAVEMENT.

NOTES

- A: MAINLINE ROADWAYS AND MAJOR SIDE ROADS.
 - B: MINOR SIDE ROADS.
 - C: THE TEMP. RAMP SHALL BE CONSTRUCTED IMMEDIATELY UPON REMOVAL OF THE EXISTING BITUMINOUS SURFACE.
 - D: THE BUTT JOINT SHALL BE CONSTRUCTED IMMEDIATELY PRIOR TO PLACING THE PROPOSED BITUMINOUS COURSES.
 - E: TAPER THE TEMP. RAMP AT A RATE OF 900 (3 ft.) PER INCH OF MILLING THICKNESS.
 - F: INSTALLATION AND REMOVAL OF THE 1.35 m (4.5') TEMP. BIT. RAMP WILL BE PAID AS "BITUMINOUS SURFACE REMOVAL - BUTT JOINT".
 - G: SEE ARTICLE 406.18 AND 406.24 OF THE STANDARD SPECIFICATIONS FOR "BITUMINOUS AND PCC SURFACE REMOVAL, BUTT JOINT".
- * SEE TYPICAL SECTIONS FOR MILLING THICKNESS.

*** 6.1 m (20') PER 25 (1) RESURFACING (NOTE "A")
3.0 m (10') PER 25 (1) RESURFACING (NOTE "B")

ALL DIMENSIONS ARE IN MILLIMETERS (INCHES) UNLESS OTHERWISE SHOWN.

BASIS OF PAYMENT:

THE BUTT JOINT WILL BE PAID FOR PER SQUARE METER (SQUARE YARD.) AS "BITUMINOUS SURFACE REMOVAL - BUTT JOINT" OR AS "PORTLAND CEMENT CONCRETE SURFACE REMOVAL - BUTT JOINT".

REVISIONS	
NAME	DATE
M. DE YONG	6-13-90
M. DE YONG	7-3-90
M. DE YONG	3-27-92
R. SHAH	09/09/94
R. SHAH	10/25/94
A. ABBAS	03/21/97
M. GOMEZ	04/06/01

ILLINOIS DEPARTMENT OF TRANSPORTATION

BUTT JOINT AND
BITUMINOUS TAPER
DETAILS

SCALE: NONE
DATE PLOTTED: 3/18/2005

DRAWN BY
CHECKED BY
BD400-05 (VI-B032)
REVISION DATE: 04/06/01

F.A. NO.	SECTION	COUNTY	TOTAL SHEETS	SHEET NO.
	1316RS-1	COOK	22	15
STA.		TO STA.		
FED. ROAD DIST. NO.	ELIMOS	FED. AID PROJECT		

60754

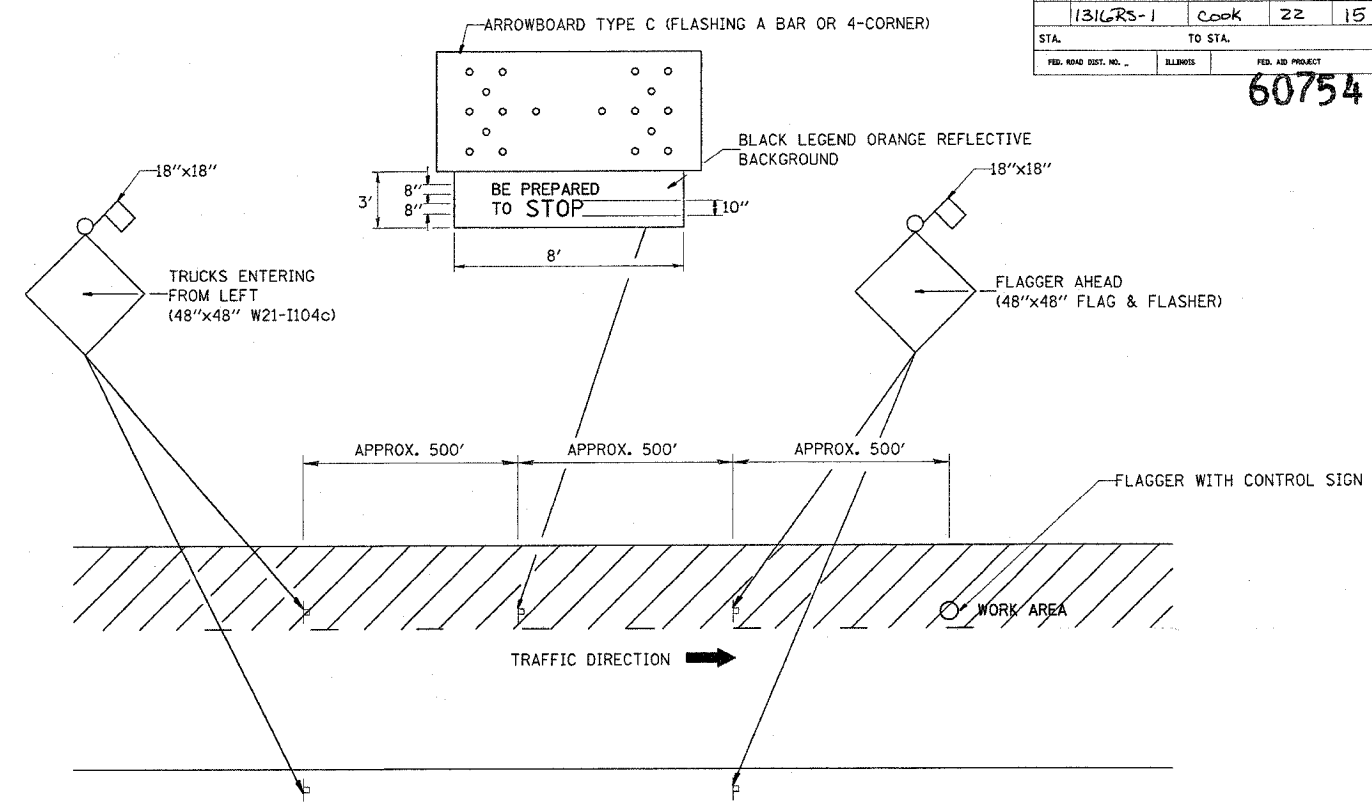

METHOD OF FLAGGING

NOTE:

1. SIGNS SHALL BE MOUNTED AT A MINIMUM CLEARANCE HEIGHT OF 5 FEET
2. ALL SIGNS SHALL BE REMOVED WHEN THE FLAGGING OPERATION CEASES.
3. THIS CASE ALSO APPLIES WHEN THE WORK ZONE IS ON THE RIGHT. UNDER THESE CONDITIONS "TRUCKS ENTERING FROM RIGHT" SIGNS SHALL BE SUBSTITUTED FOR "TRUCKS ENTERING FROM LEFT" SIGNS. ALSO THE ARROWBOARD AND "BE PREPARED TO STOP" SIGNS SHALL BE RELOCATED TO THE RIGHT SIDE OF THE ROAD.
4. WORK ZONE ACCESS POINTS SHOULD BE A MINIMUM OF ONE HALF MILE APART. MEDIAN WORK ZONE ACCESS POINTS SHOULD NOT BE LOCATED OPPOSITE OF EACH OTHER.
5. NIGHTTIME FLAGGING OPERATIONS: THE FLAG STATION SHALL BE LIGHTED WITH ADDITIONAL LIGHTS OTHER THAN STREET LIGHTS. THE FLAGGER CONTROL SIGN AND THE FLAGGER'S VEST SHALL BE REFLECTORIZED. IN ADDITION, THE FLAGGER SHALL HAVE A FLASHLIGHT OR LIGHTED WAND.

REVISIONS	
NAME	DATE
RAY RITCHIE	5/10/00

ILLINOIS DEPARTMENT OF TRANSPORTATION

METHOD OF FLAGGING

SCALE: NOT TO SCALE
DATE 3/21/2005

DRAWN BY C.A.D.
CHECKED BY
BM-14
REVISION DATE: 05/10/00

60754

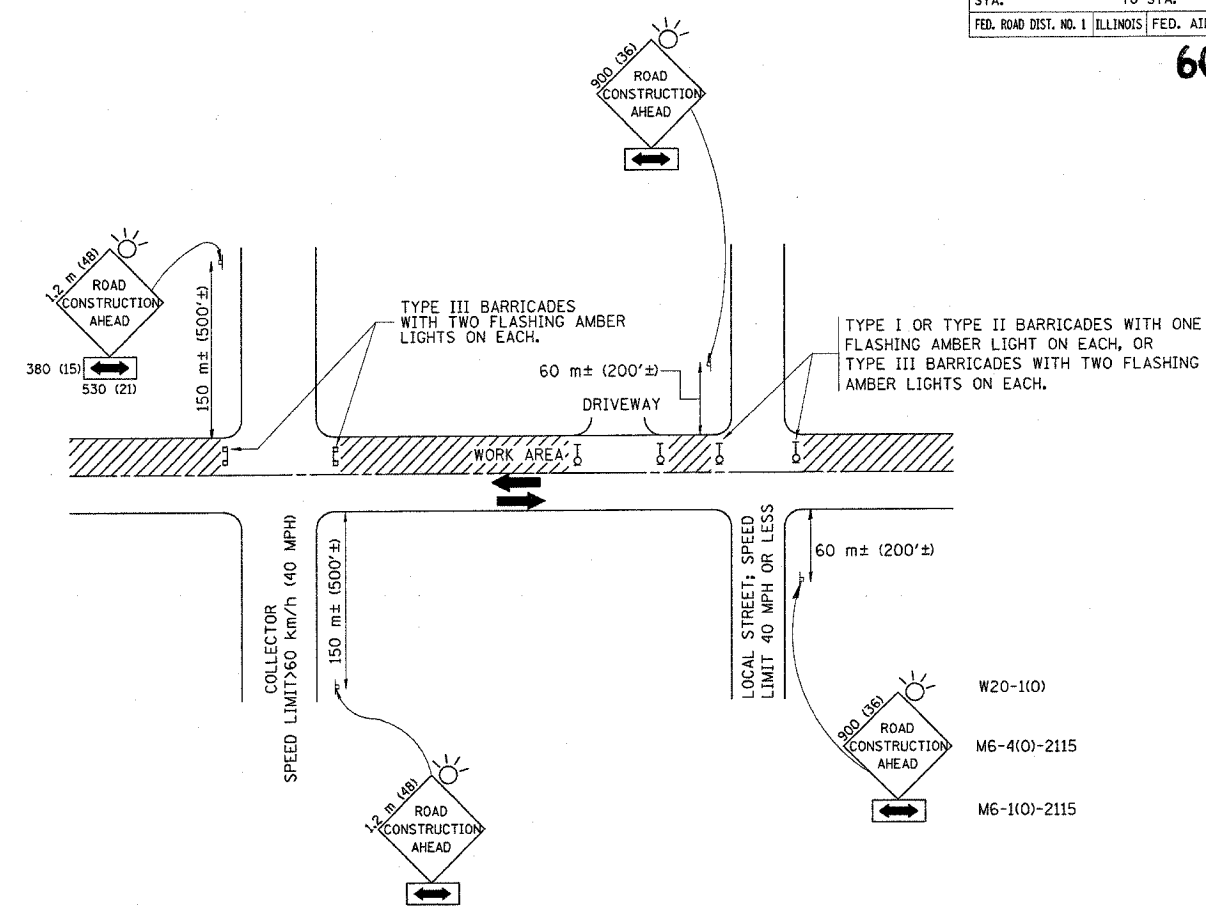

TRAFFIC CONTROL AND PROTECTION FOR SIDE ROADS, INTERSECTIONS, AND DRIVEWAYS

NOTES:

- A. FOR NO LANE RESTRICTION ON THE SIDE ROAD OR DRIVEWAYS
- SIDE ROAD WITH A SPEED LIMIT OF 60 km/h (40 MPH) OR LESS AS SHOWN ON THE DRAWING AND AS DIRECTED BY THE ENGINEER:
 - ONE ROAD CONSTRUCTION AHEAD SIGN 900x900 (36x36) WITH A FLASHER AND FLAG MOUNTED ON IT APPROXIMATELY 60 m (200') IN ADVANCE OF THE MAIN ROUTE.
 - THE CLOSED PORTION OF THE MAIN ROUTE SHALL BE PROTECTED BY BLOCKING WITH TYPE I, TYPE II OR TYPE III BARRICADES, 1/3 OF THE CROSS SECTION OF THE CLOSED PORTION.
 - SIDE ROAD WITH A SPEED LIMIT GREATER THAN 60 km/h (40 MPH) AS SHOWN ON THE DRAWING AND AS DIRECTED BY THE ENGINEER:
 - ONE ROAD CONSTRUCTION AHEAD SIGN 1.2 m x 1.2 m (48x48) WITH A FLASHER MOUNTED ON IT APPROXIMATELY 150 m (500') IN ADVANCE OF THE MAIN ROUTE.
 - THE CLOSED PORTION OF THE MAIN ROUTE SHALL BE PROTECTED BY BLOCKING WITH TYPE III BARRICADES, 1/2 OF THE CROSS SECTION OF THE CLOSED PORTION.
 - WHEN THE SIDE ROAD LIES BETWEEN THE BEGINNING OF THE MAINLINE SIGNING AND THE WORK ZONE, A SINGLE HEADED ARROW (M6-1) SHALL BE USED IN LIEU OF THE DOUBLE HEADED ARROW (M6-4).
- B. FOR A LANE CLOSURE ON A SIDE ROAD OR DRIVEWAY:
- USE APPLICABLE PORTIONS OF THE TYPICAL APPLICATION OF TRAFFIC CONTROL DEVICES (STD. 701501, STD. 701606 OR THE APPROPRIATE STANDARD). THE SPACING OF SIGNS AND BARRICADES SHALL BE ADJUSTED FOR FIELD CONDITIONS AS DIRECTED BY THE ENGINEER. THE DIRECTIONAL ARROW SHALL BE COVERED OR REMOVED WHEN NO LONGER CONSISTENT WITH THE SIDE ROAD LANE CLOSURE.
- C. ADVANCE WARNING SIGNS ARE TO BE OMITTED ON DRIVEWAY UNLESS OTHERWISE NOTED.
- D. THE TRAFFIC CONTROL AND PROTECTION FOR SIDE ROADS, INTERSECTIONS, AND DRIVEWAYS SHALL BE INCIDENTAL TO THE COST OF SPECIFIED TRAFFIC CONTROL STANDARDS OR ITEMS.

REVISIONS	
NAME	DATE
LHA	6/89
T. RAMMACHER	09/08/94
J. OBERLE	10/18/95
A. HOUSEH	03/06/96
A. HOUSEH	10/15/96
T. RAMMACHER	01/06/00

ILLINOIS DEPARTMENT OF TRANSPORTATION
 TRAFFIC CONTROL AND PROTECTION
 FOR
 SIDE ROADS, INTERSECTIONS, AND
 DRIVEWAYS

SCALE: VERT.
 HORIZ.
 DATE 3/18/2005

DRAWN BY
 CHECKED BY
 TC-10

REVISION DATE: 01/06/00

60754

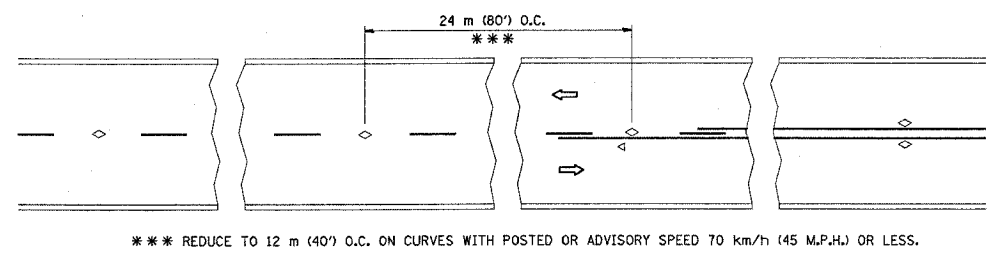

*** REDUCE TO 12 m (40') O.C. ON CURVES WITH POSTED OR ADVISORY SPEED 70 km/h (45 M.P.H.) OR LESS.

TWO-LANE/TWO-WAY

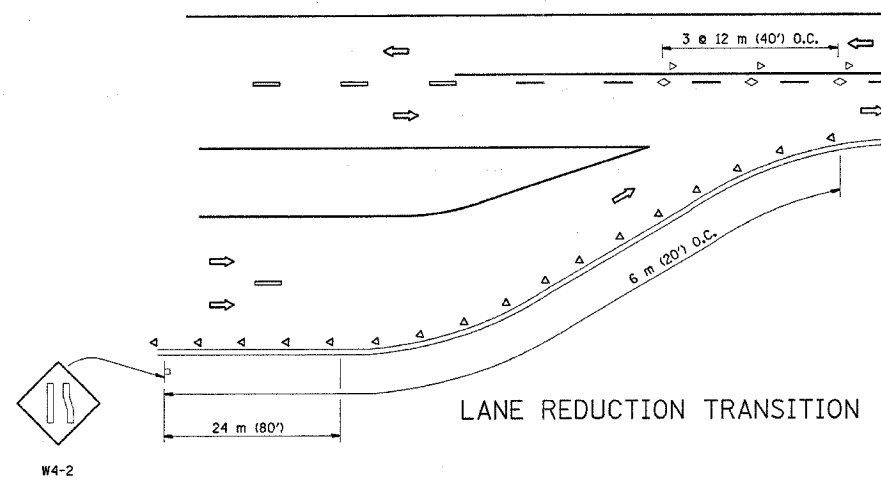

LANE REDUCTION TRANSITION

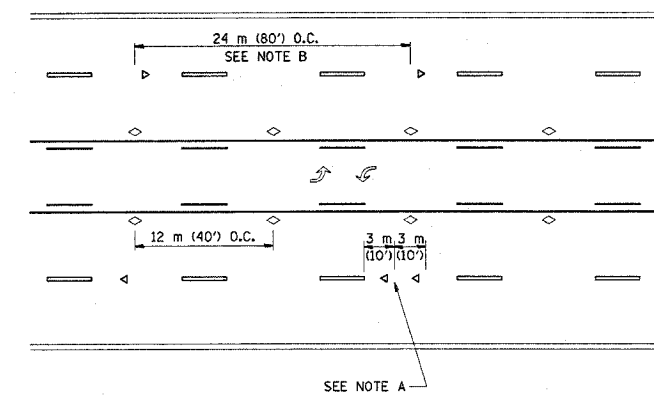

TWO-WAY LEFT TURN

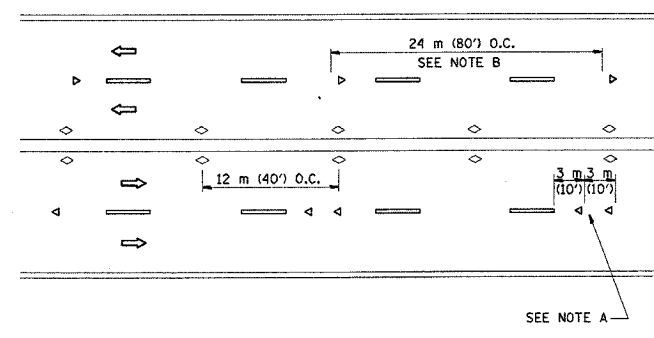

MULTI-LANE/UNDIVIDED

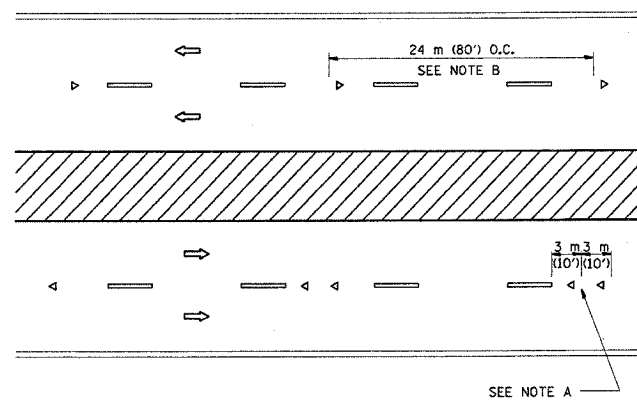

MULTI-LANE/DIVIDED

GENERAL NOTES

1. MARKERS USED WITH DASHED LINES SHALL BE CENTERED IN THE GAP BETWEEN SEGMENTS.
2. MARKERS USED ADJACENT TO SOLID LINES SHALL BE OFFSET 50 TO 75 (2 TO 3) TOWARD TRAFFIC AS SHOWN.
3. MARKERS THROUGH TANGENTS LESS THAN 150 m (500') IN LENGTH BETWEEN CURVES SHALL BE INSTALLED AT THE LESSER OF THE TWO CURVE SPACINGS.

SYMBOLS

- YELLOW STRIPE
- WHITE STRIPE
- ◁ ONE-WAY AMBER MARKER
- ◁ ONE-WAY CRYSTAL MARKER (W/O)
- ◊ TWO-WAY AMBER MARKER

LANE MARKER NOTES

- B. REDUCE TO 12 m (40') O.C. ON CURVES WHERE ADVISORY SPEEDS ARE 20 km/h (10 M.P.H.) LOWER THAN POSTED SPEEDS.
- A. USE DOUBLE LANE LINE MARKERS SPACED AS SHOWN.

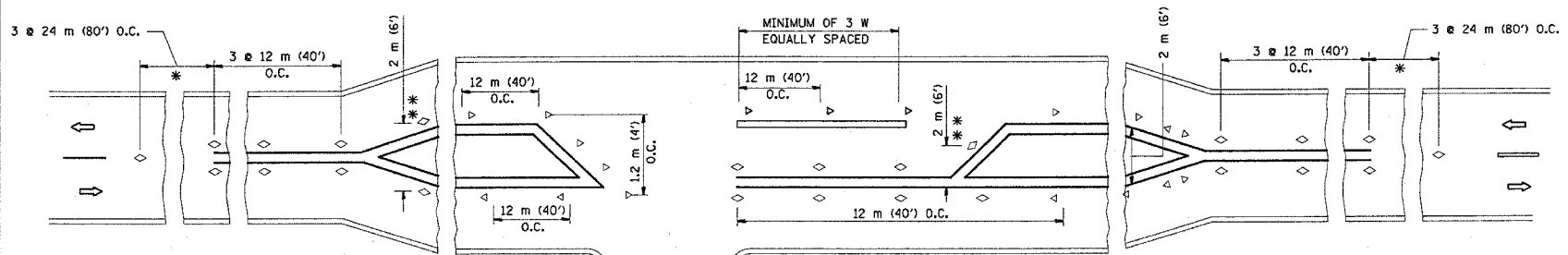

* SEE TWO-LANE/TWO-WAY WHERE MARKERS CONTINUE
 ** WHERE THE MEDIAN WIDTH IS 2 m (6') OR LESS USE TWO-WAY MARKERS.

LEFT TURN

All dimensions are in millimeters (inches) unless otherwise shown.

ILLINOIS DEPARTMENT OF TRANSPORTATION
 TYPICAL APPLICATIONS
 RAISED REFLECTIVE PAVEMENT MARKERS
 (SNOW-PLOW RESISTANT)

REVISIONS	
NAME	DATE
T. RAMMACHER	09-19-94
T. RAMMACHER	03-12-99
T. RAMMACHER	01-06-00

SCALE: NONE
 DATE: 3/18/2005

DRAWN BY CADD
 CHECKED BY
 TC-11

REVISION DATE: 01/06/00

60754

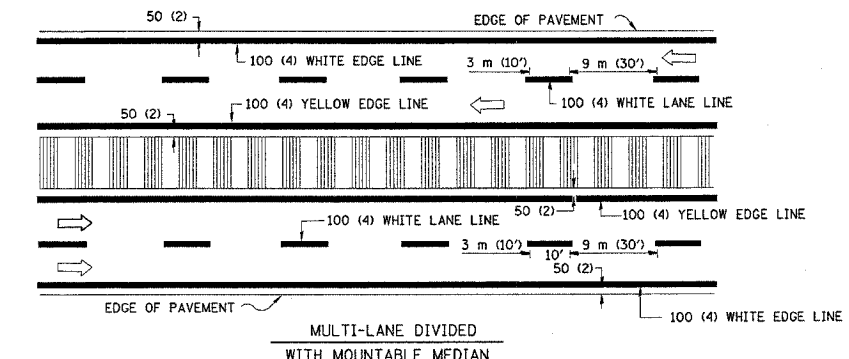
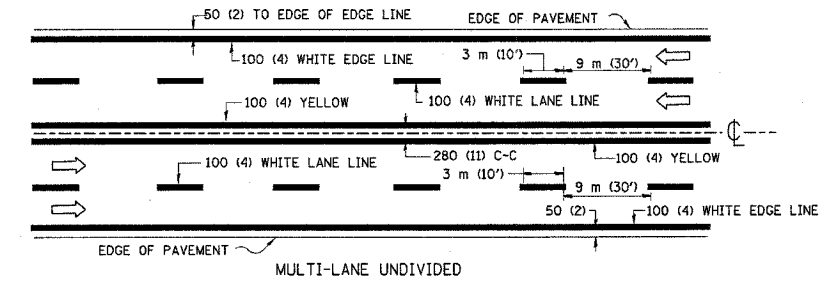
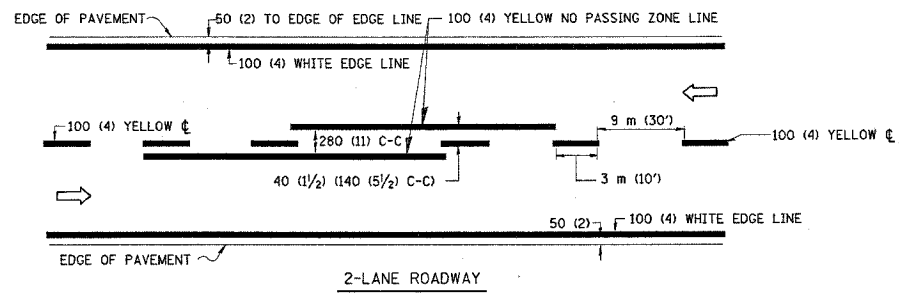

NOTE: MEDIANS WITH BARRIER CURB DO NOT REQUIRE AN EDGE LINE

TYPICAL LANE AND EDGE LINE MARKING

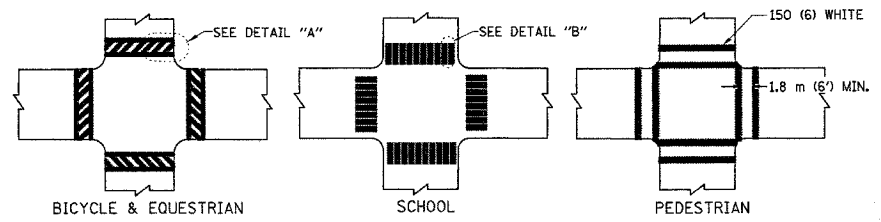

TYPICAL CROSSWALK MARKING

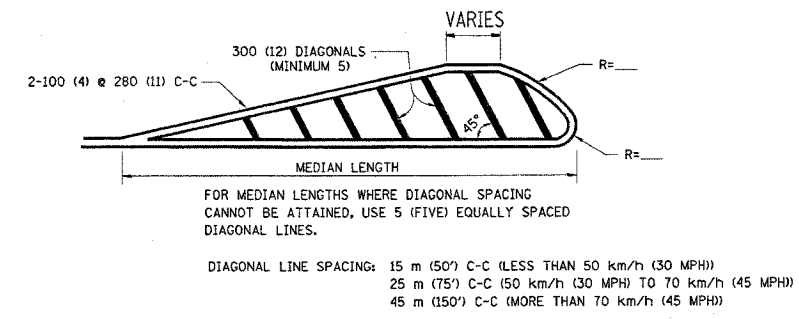
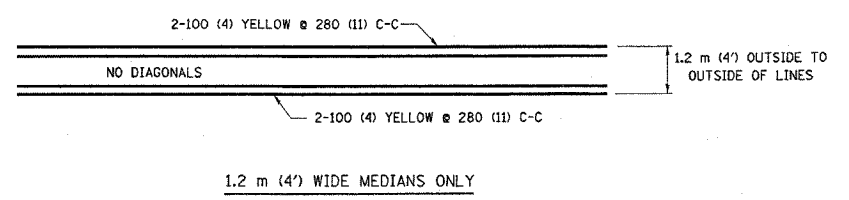

DIAGONAL LINE SPACING: 15 m (50') C-C (LESS THAN 50 km/h (30 MPH))
25 m (75') C-C (50 km/h (30 MPH) TO 70 km/h (45 MPH))
45 m (150') C-C (MORE THAN 70 km/h (45 MPH))

MEDIANS OVER 1.2 m (4') WIDE

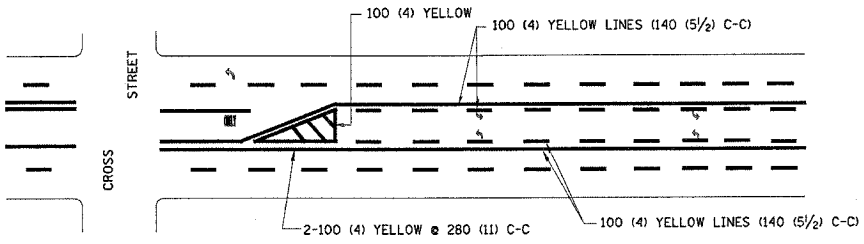

A MINIMUM OF TWO PAIRS OF TURN ARROWS SHALL BE USED, WHITE IN COLOR. ADDITIONAL PAIRS SHALL BE PLACED AT 60 m (200') TO 90 m (300') INTERVALS.

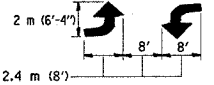

MEDIAN WITH TWO-WAY LEFT TURN LANE

TYPICAL PAINTED MEDIAN MARKING

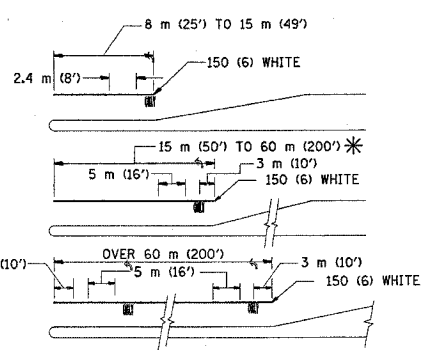

FULL SIZE LETTERS 2.4 m (8') AND ARROWS SHALL BE USED.
* TURN LANES IN EXCESS OF 120 m (400') IN LENGTH MAY HAVE AN ADDITIONAL SET OF ARROW - "ONLY" INSTALLED MIDWAY BETWEEN THE OTHER TWO SETS OF ARROW - "ONLY".

TYPICAL LEFT (OR RIGHT) TURN LANE

TYPICAL TURN LANE MARKING

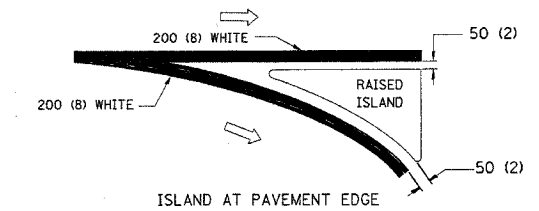
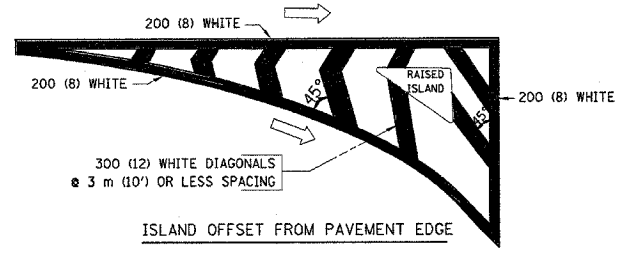

TYPICAL ISLAND MARKING

TYPE OF MARKING	WIDTH OF LINE	PATTERN	COLOR	SPACING / REMARKS
CENTERLINE ON 2 LANE PAVEMENT	100 (4)	SKIP-DASH	YELLOW	3 m (10') LINE WITH 9 m (30') SPACE
CENTERLINE ON MULTI-LANE UNDIVIDED PAVEMENT	2 @ 100 (4)	SOLID	YELLOW	280 (11) C-C
NO PASSING ZONE LINES: FOR ONE DIRECTION FOR BOTH DIRECTIONS	100 (4) 2 @ 100 (4)	SOLID SOLID	YELLOW YELLOW	140 (5/2) C-C FROM SKIP-DASH CENTERLINE 280 (11) C-C OMIT SKIP-DASH CENTERLINE BETWEEN
LANE LINES	100 (4) 125 (5) ON FREEWAYS	SKIP-DASH SKIP-DASH	WHITE WHITE	3 m (10') LINE WITH 9 m (30') SPACE
DOTTED LINES (EXTENSIONS OF CENTER, LANE OR TURN LANE MARKINGS)	SAME AS LINE BEING EXTENDED	SKIP-DASH	SAME AS LINE BEING EXTENDED	600 (2') LINE WITH 1.8 m (6') SPACE
EDGE LINES	100 (4)	SOLID	YELLOW-LEFT WHITE-RIGHT	OUTLINE MOUNTABLE MEDIANS IN YELLOW; EDGE LINES ARE NOT USED NEXT TO BARRIER CURB
TURN LANE MARKINGS	150 (6) LINE; FULL SIZE LETTERS & SYMBOLS (2.4 m (8'))	SOLID	WHITE	SEE TYPICAL TURN LANE MARKING DETAIL
TWO WAY LEFT TURN MARKING	2 @ 100 (4) EACH DIRECTION 2.4 m (8') LEFT ARROW	SKIP-DASH AND SOLID IN PAIRS	YELLOW WHITE	3 m (10') LINE WITH 9 m (30') SPACE FOR SKIP-DASH; 140 (5/2) C-C BETWEEN SOLID LINE AND SKIP-DASH LINE SEE TYPICAL TWO-WAY LEFT TURN MARKING DETAIL
CROSSWALK LINES (PEDESTRIAN) A. DIAGONALS (BIKE & EQUESTRIAN) B. LONGITUDINAL BARS (SCHOOL)	2 @ 150 (6) 300 (12) @ 45° 300 (12) @ 90°	SOLID SOLID SOLID	WHITE WHITE WHITE	NOT LESS THAN 1.8 m (6') APART 600 (2') APART 600 (2') APART SEE TYPICAL CROSSWALK MARKING DETAILS.
STOP LINES	600 (24)	SOLID	WHITE	PLACE 1.2 m (4') IN ADVANCE OF AND PARALLEL TO CROSSWALK, IF PRESENT. OTHERWISE, PLACE AT DESIRED STOPPING POINT, PARALLEL TO CROSSROAD CENTERLINE, WHERE POSSIBLE
PAINTED MEDIANS	2 @ 100 (4) WITH 300 (12) DIAGONALS @ 45° NO DIAGONALS USED FOR 1.2 m (4') WIDE MEDIANS	SOLID	YELLOW: TWO WAY TRAFFIC WHITE: ONE WAY TRAFFIC	280 (11) C-C FOR THE DOUBLE LINE SEE TYPICAL PAINTED MEDIAN MARKING.
GOPE MARKING AND CHANNELIZING LINES	200 (8) WITH 300 (12) DIAGONALS @ 45°	SOLID	WHITE	DIAGONALS: 4.5 m (15') C-C (LESS THAN 50 km/h (30 MPH)) 6 m (20') C-C (50 km/h (30 MPH) TO 70 km/h (45 MPH)) 9 m (30') C-C (OVER 70 km/h (45 MPH))
RAILROAD CROSSING	600 (24) TRANSVERSE LINES; "RR" 15 1.8 m (6') LETTERS; 400 (16) LINE FOR "X"	SOLID	WHITE	SEE STATE STANDARD 780001 AREA OF: "R"=0.33m ² (3.6 SQ. FT.) EACH "X"=5.0 m ² (54.0 SQ. FT.)
SHOULDER DIAGONALS	300 (12) @ 45°	SOLID	WHITE - RIGHT YELLOW - LEFT	15 m (50') C-C (LESS THAN 50 km/h (30 MPH)) 25 m (75') C-C (50 km/h (30 MPH) TO 70 km/h (45 MPH)) 45 m (150') C-C (OVER 70 km/h (45 MPH))

FOR FURTHER DETAILS ON PAVEMENT MARKING REFER TO STANDARD SPECIFICATIONS FOR ROAD AND BRIDGE CONSTRUCTION AND STATE STANDARD 780001.

All dimensions are in millimeters (inches) unless otherwise shown.

ILLINOIS DEPARTMENT OF TRANSPORTATION

DISTRICT ONE
TYPICAL PAVEMENT MARKINGS

REVISIONS	
NAME	DATE
EVERS	03-19-90
T. RAMMACHER	10-27-94
ALEX HOUSEH	10-09-96
ALEX HOUSEH	10-17-96
T. RAMMACHER	01-06-00

SCALE: NONE
DATE 3/18/2005
DRAWN BY CADD
CHECKED BY

TC-13
REVISION DATE: 01/06/00

F.A. NO.	SECTION	COUNTY	TOTAL SHEETS	SHEET NO.
	1342R-1	COOK	22	19
STA.	TO STA.			
FED. ROAD DIST. NO.	ILLINOIS	FED. AID PROJECT		



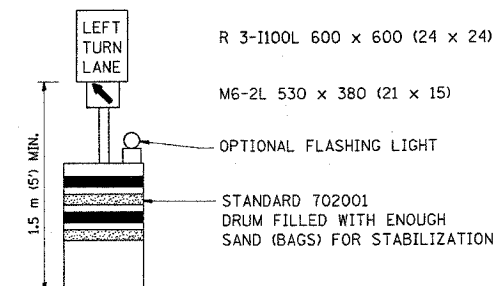
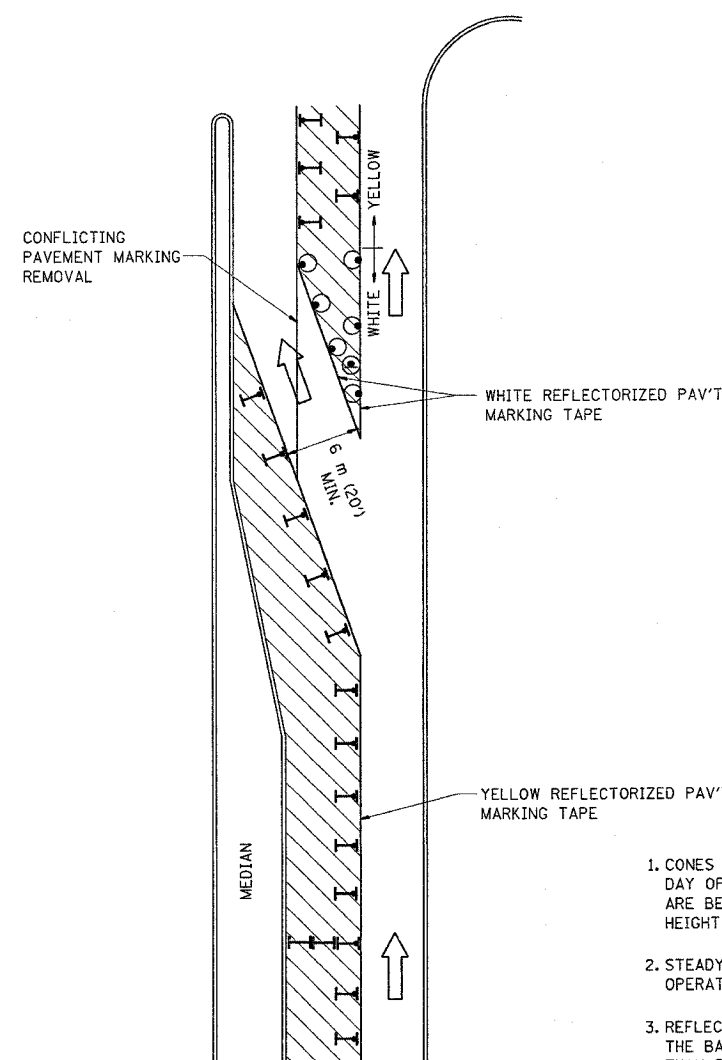



60754

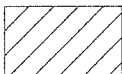

GENERAL NOTES

1. CONES MAY BE SUBSTITUTED FOR BARRICADES OR DRUMS AT HALF THE SPACING DURING DAY OPERATIONS. CONES SHALL BE A MINIMUM OF 710 (28) IN HEIGHT. WHEN CONES ARE BEING USED, THE "LEFT TURN LANE" SIGN MAY BE SKID MOUNTED AT A MINIMUM HEIGHT OF 1.5 m (5').
2. STEADY BURNING LIGHTS WILL NOT BE REQUIRED ON BARRICADES OR DRUMS FOR DAY OPERATIONS. ALL LIGHTS SHALL BE MONODIRECTIONAL.
3. REFLECTORIZED TEMPORARY PAVEMENT MARKING TAPE SHALL BE PLACED THROUGHOUT THE BARRICADED AREA OF EACH TURN BAY WHERE THE CLOSURE TIME IS GREATER THAN FOURTEEN DAYS.
4. THIS APPLICATION ALSO APPLIES WHEN WORK IS BEING PERFORMED IN THE RIGHT LANE(S) AND THE RIGHT TURN BAY IS TO REMAIN OPEN. UNDER THIS CONDITION, "RIGHT TURN LANE" R3-100 600 x 600 (24 x 24) AND M6-2R 530 x 380 (21 x 15) SHALL BE USED.
5. THESE CONTROLS SHALL SUPPLEMENT MAINLINE TRAFFIC CONTROL FOR LANE CLOSURES.
6. LONGITUDINAL DIMENSIONS MAY BE ADJUSTED TO FIT FIELD CONDITIONS.
7. FORM BT 725 IS REQUIRED.
8. TRAFFIC CONTROL AND PROTECTION AT TURN BAYS (TO REMAIN OPEN TO TRAFFIC) SHALL BE INCLUDED IN THE COST SPECIFIED TRAFFIC CONTROL STANDARDS OR ITEMS.

LEGEND

-  WORK AREA
-  LANE OPEN TO TRAFFIC
-  TYPE I OR II BARRICADE WITH STEADY BURN LIGHT
-  DRUM WITH STEADY BURN LIGHT
-  DRUM WITH SIGN (WITH OPTIONAL FLASHING LIGHT) SEE DETAIL
-  TYPE I OR II CHECK BARRICADE WITH FLASHING LIGHT

All dimensions are in millimeters (inches) unless otherwise shown.

ILLINOIS DEPARTMENT OF TRANSPORTATION
**TRAFFIC CONTROL AND PROTECTION
 AT TURN BAYS
 (TO REMAIN OPEN TO TRAFFIC)**

REVISIONS	
NAME	DATE
T. RAMMACHER	09/08/94
A. HOUSEH	11/07/95
A. HOUSEH	10/12/96
T. RAMMACHER	01/06/00

SCALE: NONE
 DATE: 3/18/2005

DRAWN BY
 CHECKED BY LHA
 TC-14

REVISION DATE: 01/06/00

60754

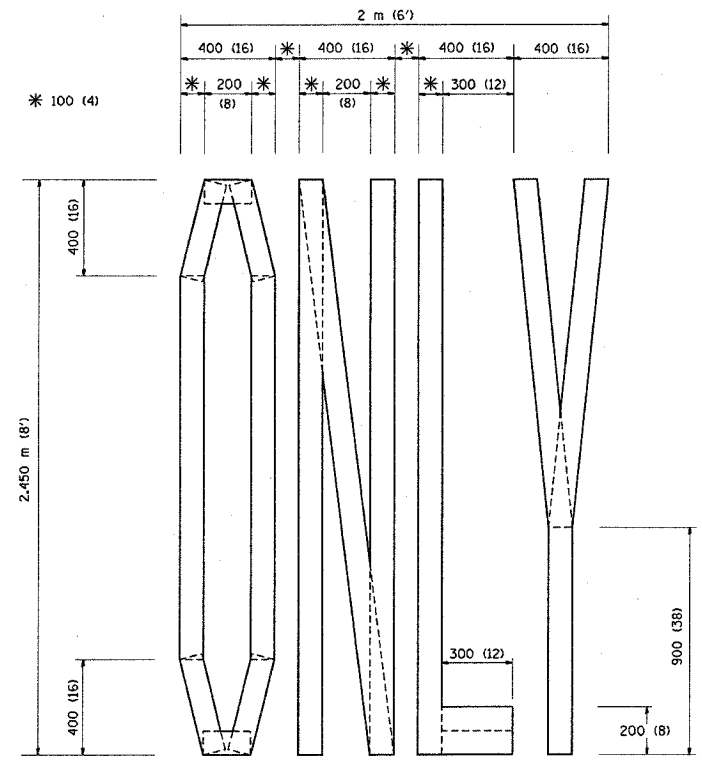

QUANTITY
 100 (4) LINE = 19.7 m (64.1 ft.)
 1.97 sq. m (21.1 sq. ft.)

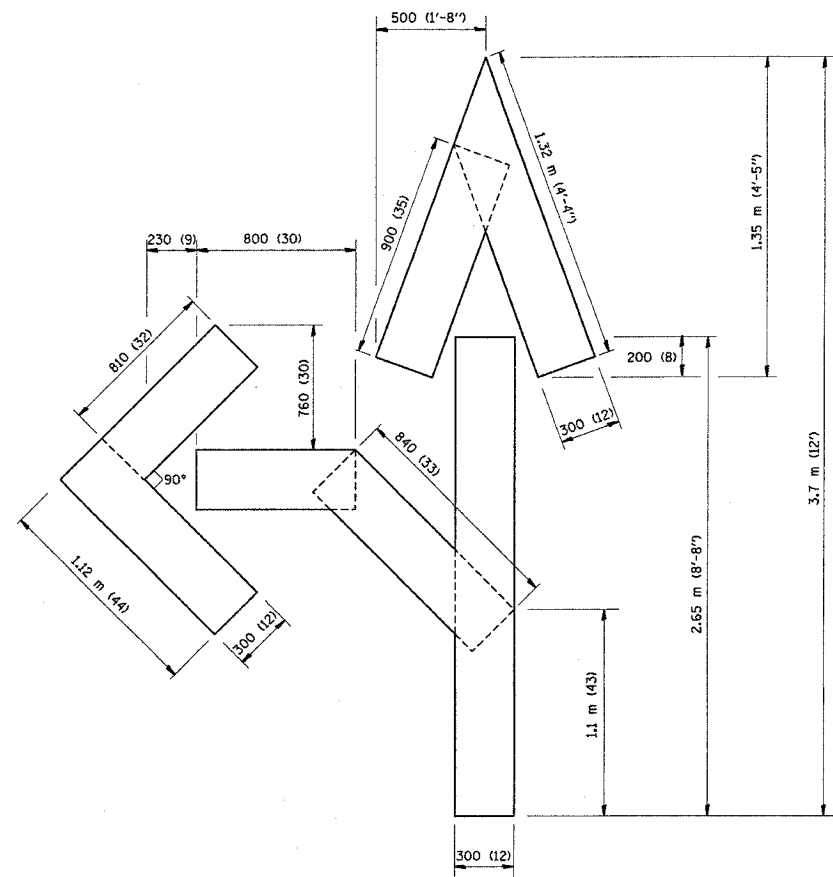

QUANTITY
 100 (4) LINE = 25.3 m (82.5 ft.)
 2.53 sq. m (27.5 sq. ft.)

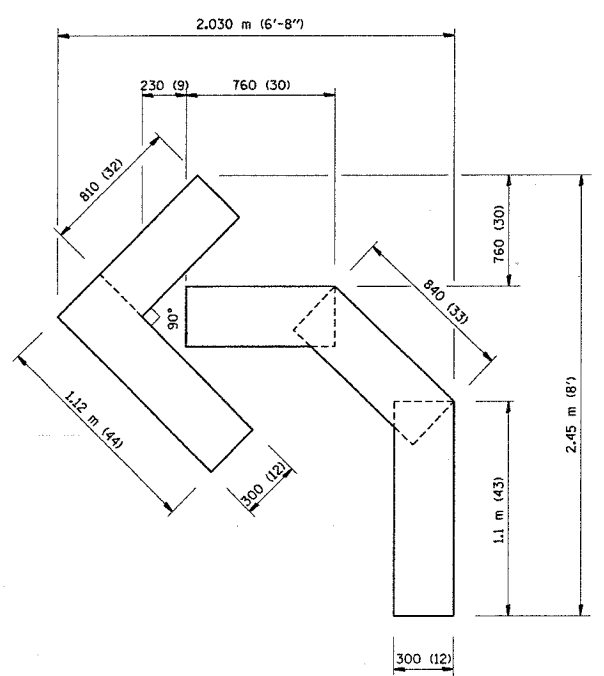

QUANTITY
 100 (4) LINE = 13.9 m (45.5 ft.)
 1.39 sq. m (15.2 sq. ft.)

All dimensions are in millimeters (Inches) unless otherwise shown.

ILLINOIS DEPARTMENT OF TRANSPORTATION

PAVEMENT MARKING
 LETTERS AND SYMBOLS
 FOR TRAFFIC STAGING

REVISIONS		
NAME	DATE	
T. RAMMACHER	09/18/94	
J. OBERLE	06/01/96	
T. RAMMACHER	06/05/96	
T. RAMMACHER	11/04/97	
T. RAMMACHER	03/02/98	
E. GOMEZ	08/28/00	

SCALE: NONE
 DATE 3/18/2005

DRAWN BY CADD
 CHECKED BY TC-16

REVISION DATE: 08/28/00

P.L. NO.	SECTION	COUNTY	TOTAL SHEETS	SHEET NO.
1316RS-1	COOK	22	21	
STA.	TO STA.			
FED. ROAD DIST. NO. 1	BIDDER	FED. AID PROJECT		

60754

LOOPS NEXT TO SHOULDERS

PROVIDE A PAVEMENT REPLACEMENT NOTE WHICH SHOULD EQUAL 3' (900 mm) X WIDTH OF PAVED SHOULDER.

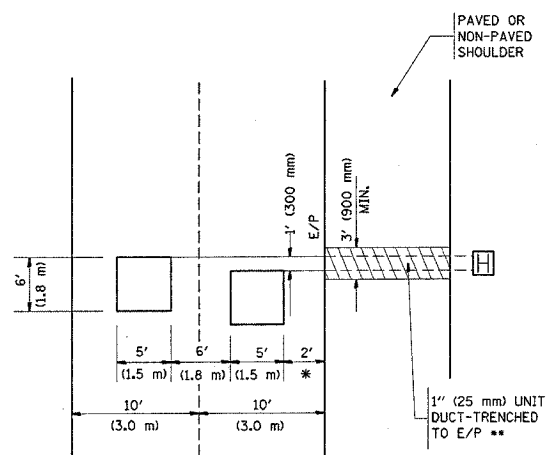

* = (600 mm)

** UNIT DUCT IS TO BE SHOWN ON PLAN SHEETS BUT SHALL NOT BE INCLUDED IN THE PAY ITEMS.

LEFT TURN LANES WITH MEDIANS
VOLUME DENSITY ("FAR OUT" DETECTION)
ON SAME APPROACH
(PROTECTED / PERMITTED LEFT TURN PHASING)

HANDHOLE LOCATION MAY VARY DEPENDING ON GEOMETRICS AND DESIGN OF TRAFFIC SIGNALS. HEAVY-DUTY HANDHOLES TO BE USED WHEN THE MEDIAN IS MOUNTABLE. REFER TO STANDARD 814001 TO ENSURE THAT HANDHOLE FITS IN MEDIAN.

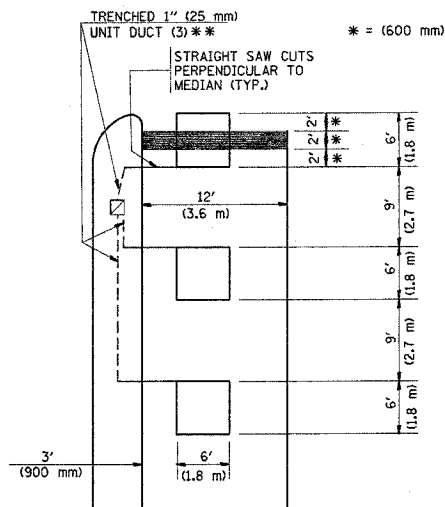

** UNIT DUCT IS TO BE SHOWN ON PLAN SHEETS BUT SHALL NOT BE INCLUDED IN THE PAY ITEMS.

NOTE: DUAL LEFT TURNS NOT SHOWN REFER TO PLAN SHEET FOR DETECTOR LOOP REPLACEMENT

LEFT TURN LANES WITHOUT MEDIANS
VOLUME DENSITY ("FAR OUT" DETECTION)
ON SAME APPROACH
(PROTECTED / PERMITTED LEFT TURN PHASING)

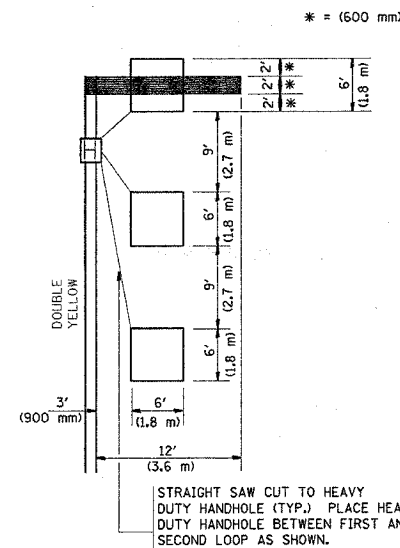

NOTE: DUAL LEFT TURNS NOT SHOWN REFER TO PLAN SHEET FOR DETECTOR LOOP REPLACEMENT

ARTERIAL-VOLUME DENSITY ("FAR OUT" DETECTION)
CROSS STREET-VOLUME DENSITY ("FAR OUT" DETECTION)

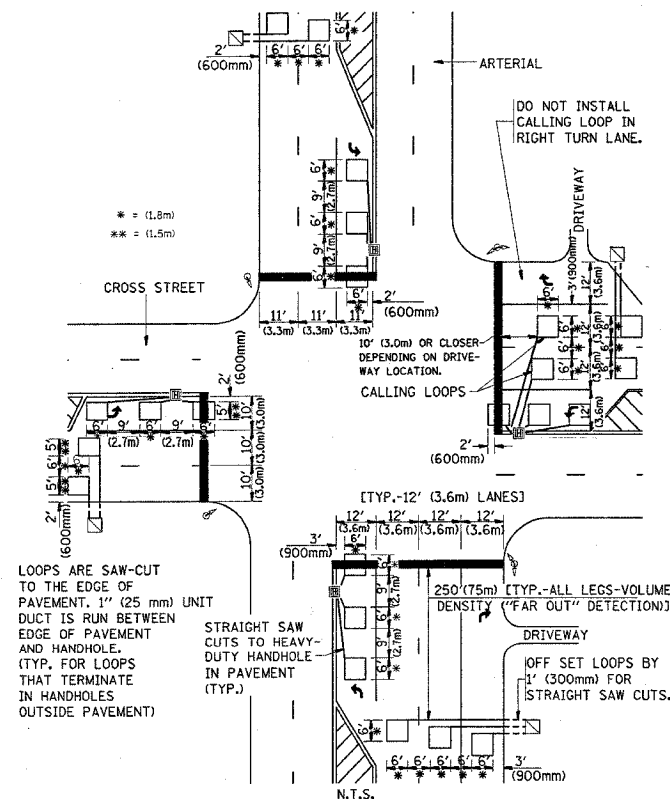

DETAIL 1
N.T.S.

ARTERIAL-VOLUME DENSITY ("FAR OUT" DETECTION)
CROSS STREET-NON VOLUME DENSITY ("UPTIGHT" PRESENCE DETECTION)

OFFSET LOOPS BY 1' (300mm) FOR STRAIGHT SAW CUTS
THIS DIMENSION MAY BE ADJUSTED FOR DRIVEWAY OR OTHER OBSTRUCTIONS. WHEN ADJUSTMENT IS REQUIRED, DETECTORS WILL NORMALLY BE MOVED CLOSER TO THE INTERSECTION.

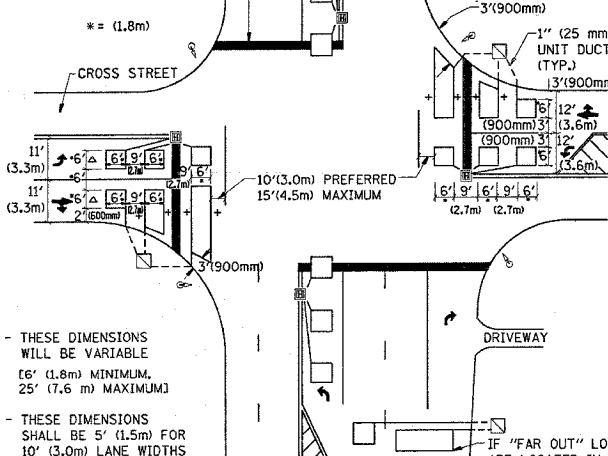

DETAIL 2
N.T.S.

NOTES:

VEHICLES LOOP DETECTORS

- * ALL LEAD IN CABLE SHALL BE TWO CONDUCTOR NO. 14 TWISTED, SHIELDED.
- * EACH DETECTOR LOOP SHALL HAVE ITS OWN SAW CUT FROM THE LOOP TO THE EDGE OF PAVEMENT OR TO A HANDHOLE IN THE PAVEMENT.
- * EACH DETECTOR LOOP SHALL HAVE ITS OWN ONE INCH (25 mm) UNIT DUCT BETWEEN THE EDGE OF PAVEMENT AND THE FIRST HANDHOLE OR JUNCTION BOX. EACH UNIT DUCT RUN SHALL BE SHOWN ON THE PLANS BY THE DESIGNER, BUT SHALL NOT BE PAID FOR SEPARATELY. THIS ITEM IS INCIDENTAL TO THE PAY ITEM FOR DETECTOR LOOPS.
- * ONE DIMENSION OF ALL DETECTOR LOOPS SHALL BE SIX FEET (1.8 m)
- * EACH LANE OF NON-LOCKING, PRESENCE DETECTION AND EACH LANE OF A DOUBLE LEFT TURN LANE REQUIRES A SEPARATE INDUCTIVE LOOP DETECTOR AND LEAD IN CABLE.
- * WHEN NON-LOCKING, PRESENCE DETECTION IS USED, MORE THAN ONE LOOP PER LANE IS REQUIRED BEHIND THE STOP BAR (i.e. 1-1/2, 1-3/4, 2).
- * WHEN SYSTEM LOOPS ARE REQUIRED ON AN APPROACH OF AN INTERSECTION, THE LOOPS USED FOR VOLUME DENSITY AND INTERSECTION TIMING SHALL ALSO BE USED AS SYSTEM DETECTORS. EACH ONE OF THESE TYPE OF LOOPS REQUIRES A SEPARATE TWO CONDUCTOR NO. 14 TWISTED SHIELDED CABLE AND A SEPARATE INDUCTIVE LOOP DETECTOR WHEN NEW CONTROLLERS ARE UTILIZED. THE DESIGNER SHALL LABEL THESE TYPES OF LOOPS AS "INTERSECTION AND SAMPLING (SYSTEM) DETECTORS" ON THE SIGNAL LAYOUT, THE INTERCONNECT PLAN AND THE SYSTEM CABLE PLAN. WHEN AN EXISTING CONTROLLER IS UTILIZED FOR THIS TYPE OF DETECTION, THE PAY ITEM "INDUCTIVE LOOP DETECTOR WITH SYSTEM OUTPUT" SHOULD BE USED.

PLACEMENT OF DETECTORS

THE FOLLOWING FIGURES REPRESENT THE MOST COMMON DETECTOR LOOP LOCATIONS AND SIZES. ADJUSTMENTS WILL BE NECESSARY FOR SPECIFIC GEOMETRIC CONSIDERATIONS.

LOCATIONS AND DIMENSIONS OF DETECTOR LOOPS ARE REQUIRED ON ALL SIGNAL LAYOUT PLAN SHEETS.

"FAR OUT" DETECTION REFERS TO LOCKING, PRESENCE TYPE DETECTION LOCATED IN THRU LANES, RIGHT TURN LANES, AND RIGHT TURN LANE TAPER AREAS (IF APPLICABLE), USUALLY 250' (75 m) IN ADVANCE OF STOP BARS. "UPTIGHT" DETECTION REFERS TO NON-LOCKING PRESENCE TYPE DETECTION LOCATED IN ALL LANES AND 10'-15' (3.0 m-4.5 m) BEHIND THE CROSSING STREET'S EDGE OF PAVEMENT EXTENDED.

NOTE:

ALL DETAILS AND NOTES SHOWN ARE FROM THE I.D.O.T. DISTRICT 1 TRAFFIC SIGNAL DESIGN GUIDELINES DATED JANUARY 1995

THIS DRAWING HAS BEEN PREPARED TO ASSIST THE RESIDENT ENGINEER FOR ALL ROADWAY RESURFACING OR S.M.A.R.T. PROJECTS WHERE THE DIMENSIONS ARE NOT SHOWN ON THE PLANS AND THE FINAL LOCATIONS FOR CROSSWALKS OR STOP BARS ARE NOT DETERMINED.

REVISIONS	
NAME	DATE

ILLINOIS DEPARTMENT OF TRANSPORTATION
DISTRICT 1
DETECTOR LOOP
INSTALLATION DETAILS
FOR ROADWAY RESURFACING

SCALE: NONE
DATE 3/18/2005

DRAWN BY CADD
DESIGNED BY
CHECKED BY R.K.F.
TSOT

REVISION DATE:

F.A. RTE.	SECTION	COUNTY	TOTAL SHEETS	SHEET NO.
	1316RS-1	COOK	22	22
STA.		TO STA.		
FED. ROAD DIST. NO. 1 ILLINOIS FED. AID PROJECT				

60754

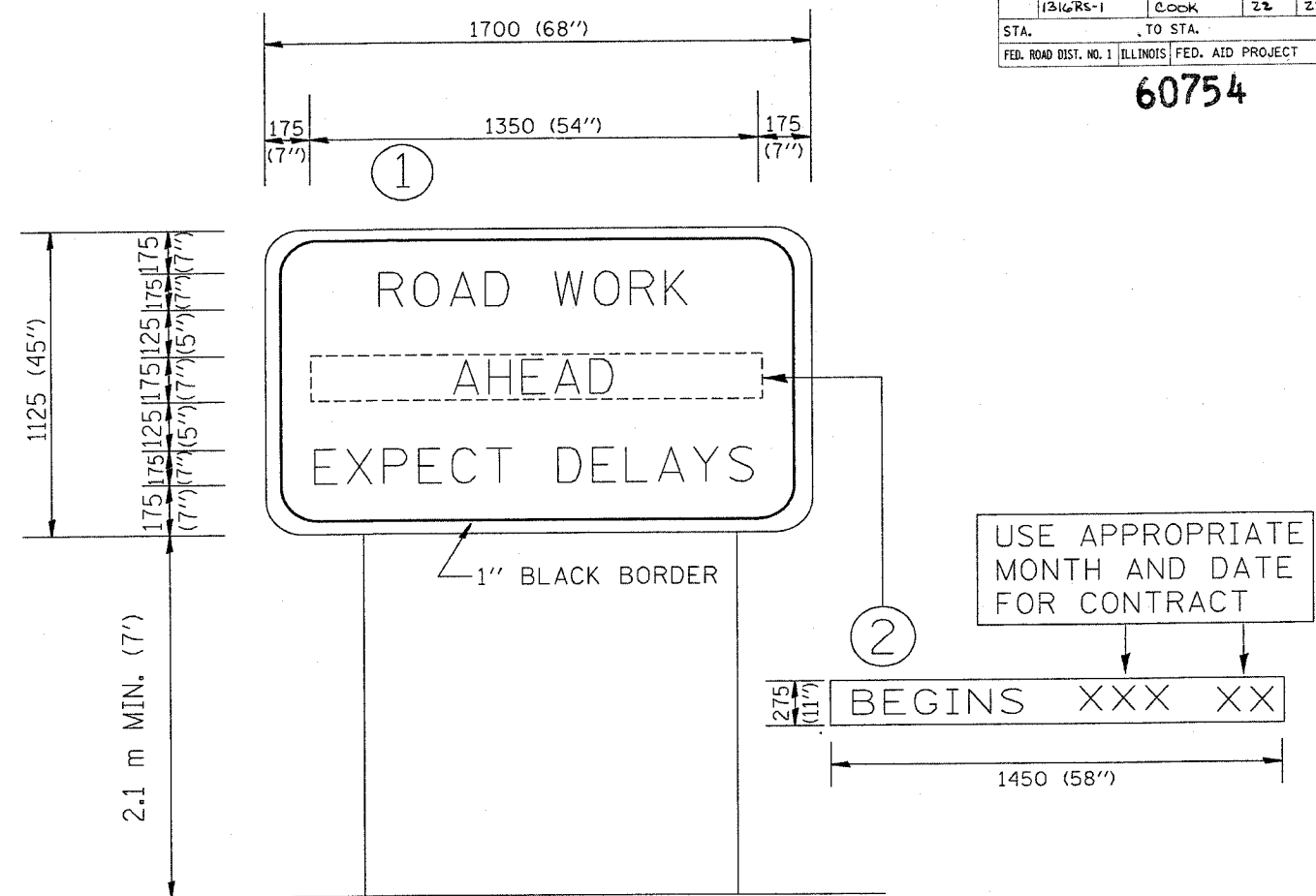

NOTES:

1. USE BLACK LETTERING ON ORANGE BACKGROUND.
2. ERECT SIGNS IN ADVANCE OF THE LOCATION FOR THE "ROAD CONSTRUCTION AHEAD" SIGN AT LOCATIONS AS DIRECTED BY THE ENGINEER.
3. ERECT SIGN ① WITH INSTALLED PANEL ② ONE WEEK PRIOR TO THE START OF CONSTRUCTION.
4. REMOVE PANEL ② SOON AFTER THE START OF CONSTRUCTION.
5. SEE SPECIAL PROVISION FOR "TEMPORARY INFORMATION SIGNING" FOR ADDITIONAL INFORMATION.
6. ONE SIGN ASSEMBLY EQUALS 2.3 SQ. M. (25.70 SQ. FT.)

ALL DIMENSIONS ARE IN MILLIMETERS (INCHES)
UNLESS OTHERWISE SHOWN.

REVISIONS	
NAME	DATE
R. MIRS	9-15-97
R. MIRS	12-11-97
T. RAMMACHER	2-2-99

ILLINOIS DEPARTMENT OF TRANSPORTATION
TEMPORARY INFORMATION SIGNING

SCALE:
DATE 3/18/2005

DRAWN BY: BUR. OF DESIGN
CHECKED BY:

TC22
REVISION DATE: 02/02/99