

F.A.I. RTE.	SECTION	COUNTY	TOTAL SHEETS	SHEET NO.
94	2005-0111	COOK	40	1

FOR INDEX OF SHEETS, SEE SHEET NO. 2

D-91-161-05

IMPROVEMENT IS LOCATED IN THE VILLAGES
 OF GLENCOE, NORTHBROOK, WINNETKA, NORTHFIELD,
 WILMETTE, GLENVIEW, SKOKIE, MORTON GROVE, LINCOLNWOOD
 AND THE CITY OF CHICAGO

STATE OF ILLINOIS
 DEPARTMENT OF TRANSPORTATION
 DIVISION OF HIGHWAYS

**PROPOSED
 HIGHWAY PLANS**

FAI ROUTE: 94-94 (EDENS EXPRESSWAY)
 LAWRENCE AVE TO LAKE-COOK RD
 SECTION: 2005-0111
 SEAL COAT (OUTSIDE SHOULDERS)
 COOK COUNTY
 C-91-161-05

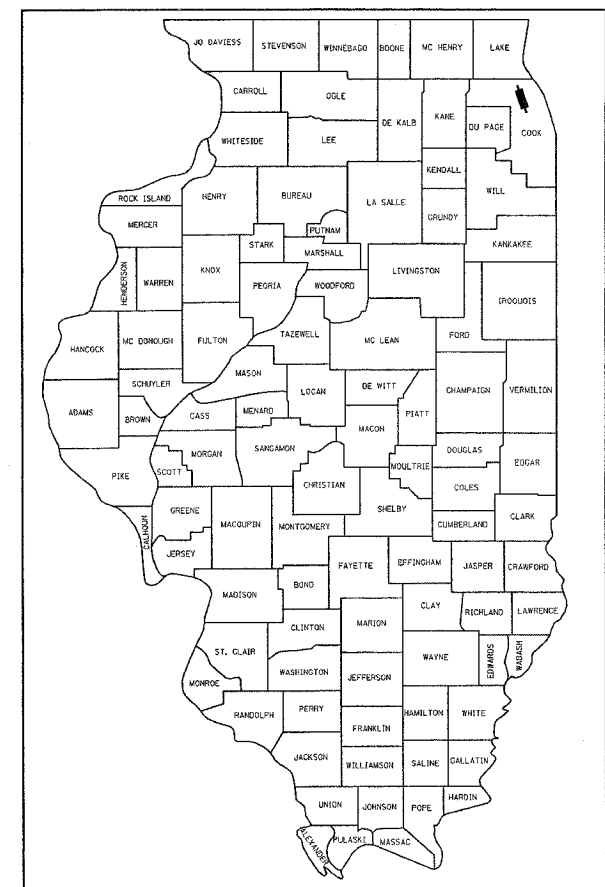

LOCATION OF SECTION INDICATED THUS: - [Symbol] -

DISTRICT ONE - DESIGN AND PLAN PREPERATION ENGINEER - KEN ENG/J.P. CHANG (847) 705-4432

IMPROVEMENT ENDS
STATION 791+00

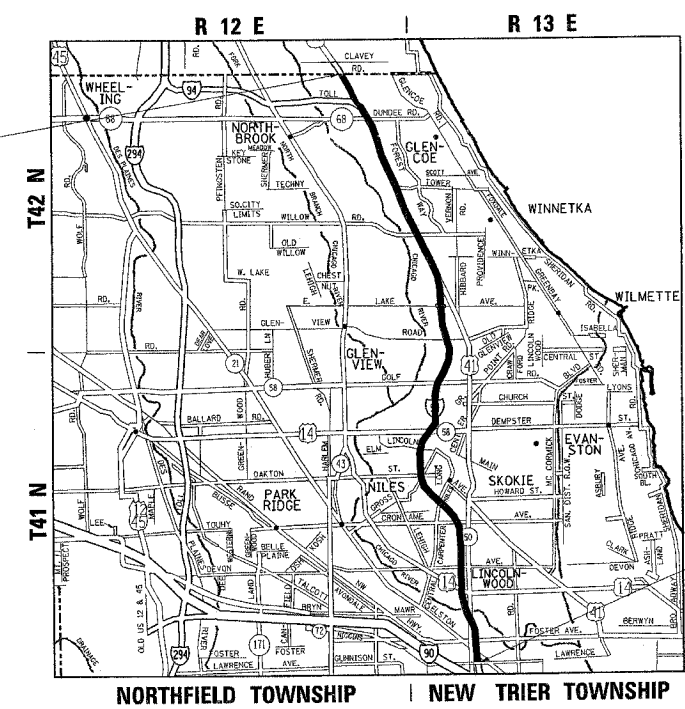

IMPROVEMENT BEGINS
STATION 56+00

TRAFFIC DATA

2003 ADT = 160000
 SPEED LIMIT = 55 MPH

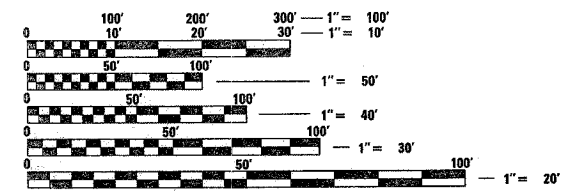

FULL SIZE PLANS HAVE BEEN PREPARED USING STANDARD
 ENGINEERING SCALES. REDUCED SIZED PLANS WILL NOT
 CONFORM TO STANDARD SCALES. IN MAKING MEASUREMENTS
 ON REDUCED PLANS, THE ABOVE SCALES MAY BE USED.

J.U.L.I.E.
 JOINT UTILITY LOCATION INFORMATION FOR EXCAVATION
 1-800-892-0123

CONTRACT NO. 62929

GROSS & NET LENGTH OF IMPROVEMENT = 73500.00 FEET = 13.92 MILES

STATE OF ILLINOIS
 DEPARTMENT OF TRANSPORTATION
 DIVISION OF HIGHWAYS

SUBMITTED June 6, 2005
Dina O'Keefe
 DEPUTY DIRECTOR OF HIGHWAYS, REGION ENGINEER

July 1, 2005
Mike Hine
 ENGINEER OF DESIGN AND ENVIRONMENT

July 1, 2005
Victor Maden
 DIRECTOR OF HIGHWAYS, CHIEF ENGINEER

PRINTED BY THE AUTHORITY
OF THE STATE OF ILLINOIS

F.A.I. RTE.	SECTION	COUNTY	TOTAL SHEETS	SHEET NO.
94	2005-0111	COOK		2
FED. ROAD DIST. NO. 1		ILLINOIS	FED. AID PROJECT	

CONTRACT NO. 62929

INDEX OF SHEETS

SHEET NO.	DESCRIPTION
1	TITLE SHEET
2	INDEX OF SHEETS, STATE STANDARDS, AND GENERAL NOTES
3	SUMMARY OF QUANTITIES
4-6	EXISTING AND PROPOSED TYPICAL SECTIONS
7-34	EXISTING AND PROPOSED ROADWAY PLANS
35	TRAFFIC CONTROL AND PROTECTION FOR SIDE ROADS INTERSECTIONS, AND DRIVEWAYS
36-37	MULTI LANE FREEWAY PAVEMENT MARKING DETAILS
38	PAVEMENT MARKING LETTERS AND SYMBOLS FOR TRAFFIC STAGING
39	TRAFFIC CONTROL DETAILS FOR FREEWAY, SHOULDER CLOSURES, PARTIAL RAMP CLOSURES
40	SIGNING FOR FLAGGING OPERATIONS AT WORK ZONE OPENINGS

LIST OF STATE STANDARDS:

STANDARD NO.	DESCRIPTION
000001-04	TYPICAL SYMBOLS, ABBREVIATIONS, AND PATTERNS
701101-01	OFF-ROAD OPERATIONS, MULTILANE, 4.5 M(15') TO 600 MM(24") FROM EDGE OF PAVEMENT
701400-02	APPROACH TO LANE CLOSURE, FREEWAY/EXPRESSWAY
701406-04	LANE CLOSURE FREEWAY/EXPRESSWAY DAY OPERATION ONLY
702001-05	TRAFFIC CONTROL DEVICES
701401-03	

GENERAL NOTES - CITY OF CHICAGO

BENCH MONUMENT LOCATIONS WITHIN THE LIMITS OF IMPROVEMENT CAN BE OBTAINED FROM THE DEPARTMENT OF SEWERS AT SUITE 410, 330 SOUTH STATE STREET, CHICAGO, IL 60604-3971. THE CONTRACTOR IS RESPONSIBLE FOR THE COST OF REPLACING ANY BENCH MONUMENT DAMAGED OR DESTROYED DURING CONSTRUCTION.

IN CASE OF DAMAGE TO CITY OF CHICAGO SEWERS, PRIVATE AND PUBLIC DRAINS, SEWER STRUCTURES AND/OR BENCH MONUMENTS, THE CONTRACTOR SHALL IMMEDIATELY CONTACT THE DEPARTMENT OF SEWERS AT 312-747-7892 OR 312-747-7893.

CITY OF CHICAGO WATER VALVE VAULTS AND SEWER STRUCTURES SHALL NOT BE CLOSED, COVERED OR OTHERWISE OBSTRUCTED DURING CONSTRUCTION WITHOUT WRITTEN PERMISSION FROM THE CITY OF CHICAGO DEPARTMENT OF WATER AND/OR DEPARTMENT OF SEWERS.

GENERAL NOTES:

BEFORE STARTING ANY EXCAVATION, THE CONTRACTOR SHALL CALL "JULIE AT 800-892-0123 OR CUAN (CHICAGO UTILITY ALERT NETWORK), 312-744-7000 FOR FIELD LOCATIONS OF BURIED ELECTRIC, TELEPHONE AND GAS FACILITIES. (48 HOURS NOTIFICATION IS REQUIRED).

THE CONTRACTOR SHALL COORDINATE CONSTRUCTION ACTIVITIES WITH UTILITY COMPANIES AND THE VILLAGES OF GLENCOE, NORTHBROOK, WINNETKA, NORTHFIELD, WILMETTE, GLENVIEW, SKOKIE, MORTON GROVE, LINCOLNWOOD AND THE CITY OF CHICAGO

THE CONTRACTOR WILL NOT BE ALLOWED TO SET UP A YARD OR FIELD OFFICE ON STATE PROPERTY WITHOUT WRITTEN PERMISSION FROM THE DEPARTMENT.

THE RESIDENT ENGINEER SHALL CONTACT MR. JOE HUNN, AREA TRAFFIC FIELD ENGINEER AT 847-705-4153 TWO WEEKS PRIOR TO PLACEMENT OF PERMANENT PAVEMENT MARKINGS.

WHEN ARTIFICIAL LIGHTING IS USED IN NIGHT OPERATIONS THE CONTRACTOR SHALL EXERCISE THE UTMOST PRECAUTIONS IN PREVENTING ADVERSE VISIBILITY TO THE MOTORING PUBLIC AND ADJOINING RESIDENTIAL AREAS.

SLURRY SEAL NOTE:

PRIOR TO APPLYING THE SLURRY SEAL MIXTURE, THE CONTRACTOR SHALL CLEAN THE PAVEMENT SURFACE BY REMOVING VEGETATION, LOOSE MATERIALS, DIRT, MUD AND OTHER OBJECTIONABLE MATERIALS.

APPLICATION RATE FOR SLURRY SEAL, SINGLE PASS, TYPE II SHALL BE 11 KG/SQ M (20 LB/SQ YD).

THE CONTRACTOR SHALL DEVISE AND SUBMIT A JOINT PLAN THAT MEETS THE APPROVAL OF THE ENGINEER.

REVISIONS		ILLINOIS DEPARTMENT OF TRANSPORTATION FAI 944-94 LAWRENCE AVE TO LAKE-COOK RD INDEX OF SHEETS, STATE STANDARDS AND GENERAL NOTES
NAME	DATE	
		SCALE: VERT. HORIZ. DATE 6/10/2005
DRAWN BY		CHECKED BY

F.A.I. RTE.	SECTION	COUNTY	TOTAL SHEETS	SHEET NO.
94	2005-0111	COOK	40	3

FED. ROAD DIST. NO. 1 ILLINOIS HIGHWAY PROJECT
CONTRACT NO. 62929

SUMMARY OF QUANTITIES			TOTAL QUANTITIES	CONSTRUCTION TYPE CODE				
CODE NO	ITEM	UNIT		URBAN SFT Y-2A				
67000400	ENGINEER'S FIELD OFFICE, TYPE A	CAL MO	1	1				
67100100	MOBILIZATION	L SUM	1	1				
* 78000200	THERMOPLASTIC PAVEMENT MARKING - LINE 4"	FOOT	147000	147000				
X7011015	TRAFFIC CONTROL AND PROTECTION (EXPRESSWAYS)	L SUM	1	1				
X7013820	TRAFFIC CONTROL SURVEILLANCE, EXPRESSWAYS	CAL DA	15	15				
X2186500	ASPHALTIC EMULSION SLURRY SEAL	SQ YD	196000	196000				

SUMMARY OF QUANTITIES			TOTAL QUANTITIES	CONSTRUCTION TYPE CODE				
CODE NO	ITEM	UNIT						

* SPECIALITY ITEMS

REVISIONS	
NAME	DATE

ILLINOIS DEPARTMENT OF TRANSPORTATION
FAI 94/I-94 (INTERSTATE 94)
LAWRENCE AVE TO LAKE-COOK RD
SUMMARY OF QUANTITIES

Rev.

PLOT DATE: 5/24/2005

6/17/2005 10:30:00 AM

F.A.I. RTE.	SECTION	COUNTY	TOTAL SHEETS	SHEET NO.
94	2005-0111	COOK	40	4
STA.		TO STA.		
FED. ROAD DIST. NO.		ILLINOIS	FED. AID PROJECT	

CONTRACT NO. 62929

LEGEND

- ① EXISTING CONTINUOUSLY REINF. PCC PAVEMENT (10")
- ② EXISTING BITUMINOUS BASE COURSE, 13" (NORTHBOUND)
- ③ EXISTING BITUMINOUS SHOULDER, 13" (SOUTHBOUND)
- ④ EXISTING GRANULAR MATERIAL TYPE A, 6"
- ⑤ EXISTING AGGREGATE SHOULDER, TYPE B
- ⑥ EXISTING BITUMINOUS SHOULDER (10")
- ⑦ EXISTING STABILIZED SUB-BASE, 4"
- ⑧ EXISTING SUB BASE GRANULAR MATERIAL, SPECIAL
- ⑨ EXISTING PIPE UNDERDRAIN, 4"
- ⑩ EXISTING BACKFILL FOR PIPE UNDERDRAIN
- ⑪ EXIST. COMB. CONC. CURB & GUTTER
- ⑫ EXISTING CONSTRUCTION JOINT
- ⑬ EXISTING 4" DIA. PVC DUCT
- ⑭ EXISTING CONCRETE BARRIER WALL, TYPE 1
- ⑮ EXISTING CONCRETE BARRIER WALL, TYPE 2
- ⑯ EXISTING CONCRETE BARRIER WALL, TYPE 3
- ⑰ EXISTING CONCRETE BARRIER WALL, TYPE 4
- ⑱ EXISTING CONSTRUCTION JOINT & KEY WAY, 2" x 6"
- ⑲ PROPOSED ASPHALTIC EMULSION SLURRY SEAL COAT, TYPE IV

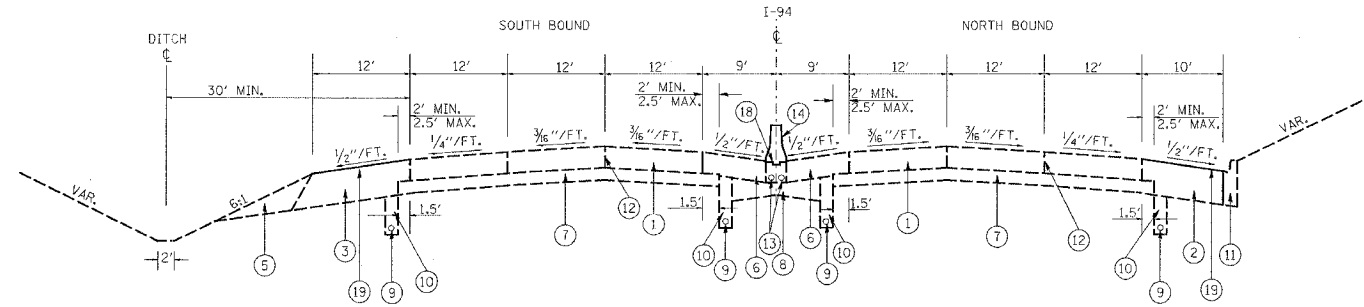

EXISTING/PROPOSED TYPICAL CROSS SECTION
LAWRENCE AVE TO OLD ORCHARD RD

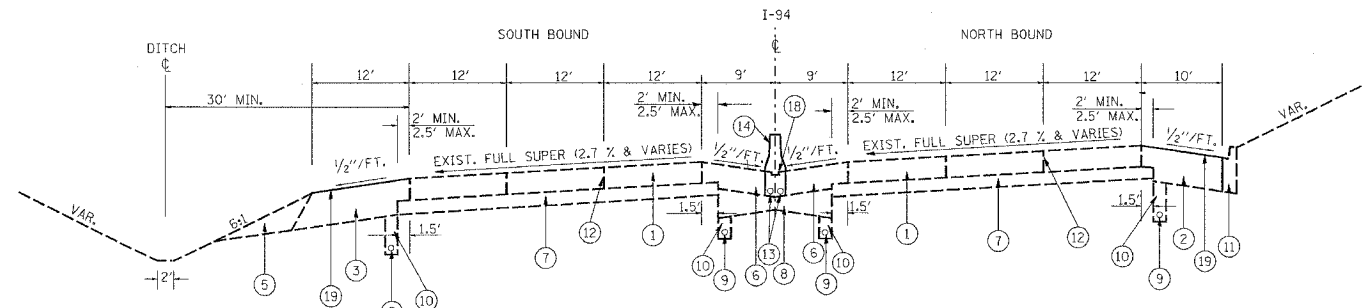

EXISTING/PROPOSED TYPICAL CROSS SECTION
LAWRENCE AVE TO OLD ORCHARD RD

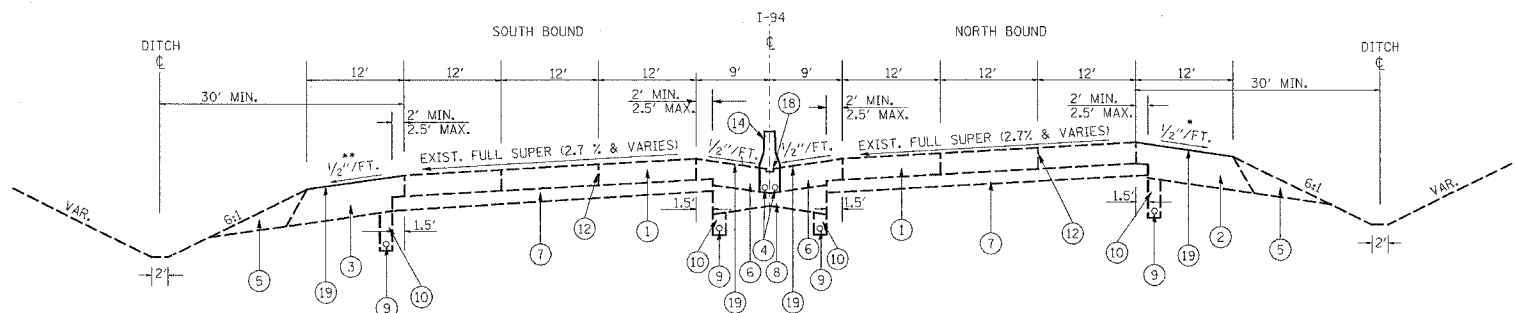

EXISTING/PROPOSED TYPICAL CROSS SECTION
LAWRENCE AVE TO OLD ORCHARD RD

NOTE: EXISTING CONDITION

- WHEN THE SUPERELEVATION RATE OF THE EXISTING PAVEMENT IS BETWEEN 0.00 FT/FT AND 0.03 FT/FT THE SHOULDER SHALL BE SLOPED AT 0.04 FT/FT. WHEN THE SUPERELEVATION RATE OF THE PAVEMENT EXCEEDS 0.03 FT/FT, THE SHOULDER SHALL BE SLOPED SO THAT THE ALGEBRAIC DIFFERENCE BETWEEN PAVEMENT AND SHOULDER WILL NOT BE GREATER THAN 0.07 FT/FT.
- EXISTING BITUMINOUS SHOULDER SLOPE SHALL BE THE SAME AS THE SUPERELEVATION RATE BUT NOT LESS THAN 1/2''/FT.

REVISIONS	
NAME	DATE

ILLINOIS DEPARTMENT OF TRANSPORTATION
FAI 94/ I-94
LAWRENCE AVE TO LAKE-COOK RD
TYPICAL CROSS SECTION

SCALE: VERT. _____
HORIZ. _____
DATE _____ DRAWN BY _____
CHECKED BY _____

PLOT DATE = 5/31/2005
FILE NAME = c:\projects\20050804\100304d.mxd
USER NAME = gabbano

F.A.I. RTE.	SECTION	COUNTY	TOTAL SHEETS	SHEET NO.
94	2005-0111	COOK	40	5
STA.		TO STA.		
FED. ROAD DIST. NO.		ILLINOIS	FED. AID PROJECT	

CONTRACT NO. 62929

LEGEND

- ① EXISTING CONTINUOUSLY REINF. PCC PAVEMENT (10")
- ② EXISTING BITUMINOUS BASE COURSE, 13" (NORTHBOUND)
- ③ EXISTING BITUMINOUS SHOULDER, 13" (SOUTHBOUND)
- ④ EXISTING GRANULAR MATERIAL TYPE A, 6"
- ⑤ EXISTING AGGREGATE SHOULDER, TYPE B
- ⑥ EXISTING BITUMINOUS SHOULDER (10")
- ⑦ EXISTING STABILIZED SUB-BASE, 4"
- ⑧ EXISTING SUB BASE GRANULAR MATERIAL, SPECIAL
- ⑨ EXISTING PIPE UNDERDRAIN, 4"
- ⑩ EXISTING BACKFILL FOR PIPE UNDERDRAIN
- ⑪ EXIST. COMB. CONC. CURB & GUTTER
- ⑫ EXISTING CONSTRUCTION JOINT
- ⑬ EXISTING 4" DIA. PVC DUCT
- ⑭ EXISTING CONCRETE BARRIER WALL, TYPE 1
- ⑮ EXISTING CONCRETE BARRIER WALL, TYPE 2
- ⑯ EXISTING CONCRETE BARRIER WALL, TYPE 3
- ⑰ EXISTING CONCRETE BARRIER WALL, TYPE 4
- ⑱ EXISTING CONSTRUCTION JOINT & KEY WAY, 2" x 6"
- ⑲ PROPOSED ASPHALTIC EMULSION SLURRY SEAL COAT, TYPE IV

NOTE:

EXISTING CONDITION

• WHEN THE SUPERELEVATION RATE OF THE EXISTING PAVEMENT IS BETWEEN 0.00 FT/FT AND 0.03 FT/FT THE SHOULDER SHALL BE SLOPED AT 0.04 FT/FT. WHEN THE SUPERELEVATION RATE OF THE PAVEMENT EXCEEDS 0.03 FT/FT, THE SHOULDER SHALL BE SLOPED SO THAT THE ALGEBRAIC DIFFERENCE BETWEEN PAVEMENT AND SHOULDER WILL NOT BE GREATER THAN 0.07 FT/FT.

•• EXISTING BITUMINOUS SHOULDER SLOPE SHALL BE THE SAME AS THE SUPERELEVATION RATE BUT NOT LESS THAN 1/2"/FT.

EXISTING CONCRETE BARRIER WALL LOCATIONS

TYPE 2 = STA 84+16.25 TO STA 82+10.75
 TYPE 3 = STA 82+10.75 TO STA 80+31.75
 TYPE 2 = STA 80+31.75 TO STA 73+97.45
 TYPE 3 = STA 73+97.45 TO STA 67+87.25
 TYPE 2 = STA 67+87.25 TO STA 65+31.75
 TYPE 3 = STA 65+31.75 TO STA 57+28.75
 TYPE 2 = STA 57+28.75 TO STA 55+56
 TYPE 3 = STA 55+56 TO STA 46+85
 TYPE 2 = STA 46+85 TO STA 44+95.15
 TYPE 1 = STA 44+95.15 TO STA 30+00
 TYPE 1 = STA 27+68 TO STA 25+91
 TYPE 1 = STA 22+35 TO STA 20+50
 TYPE 3 = STA 20+50 TO STA 19+56
 TYPE 3 STA 19+02 TO STA 17+50
 TYPE 1 = STA 17+50 TO STA 00+50.75
 TYPE 2 = STA 00+50.75 TO STA 02+82.75
 TYPE 1 = STA 02+82.75 TO STA 15+00

NOTE:

TYPICAL SECTION - SUPERELEVATED PAVEMENT
 (NORTHBOUND PROFILE GRADE ELEVATION = SOUTHBOUND PROFILE GRADE ELEVATION)

TYPICAL SECTION - SUPERELEVATED PAVEMENT
 (NORTHBOUND PROFILE GRADE ELEVATION ≠ SOUTHBOUND PROFILE GRADE ELEVATION)

TYPICAL SECTION - NORMAL CROWN PAVEMENT
 (NORTHBOUND PROFILE GRADE ELEVATION ≠ SOUTHBOUND PROFILE GRADE ELEVATION)

REVISIONS	
NAME	DATE

ILLINOIS DEPARTMENT OF TRANSPORTATION
 FAI 94/ I-94
 LAWRENCE AVE TO LAKE-COOK RD

TYPICAL CROSS SECTION

SCALE: VERT.
 HORIZ.
 DATE

DRAWN BY
 CHECKED BY

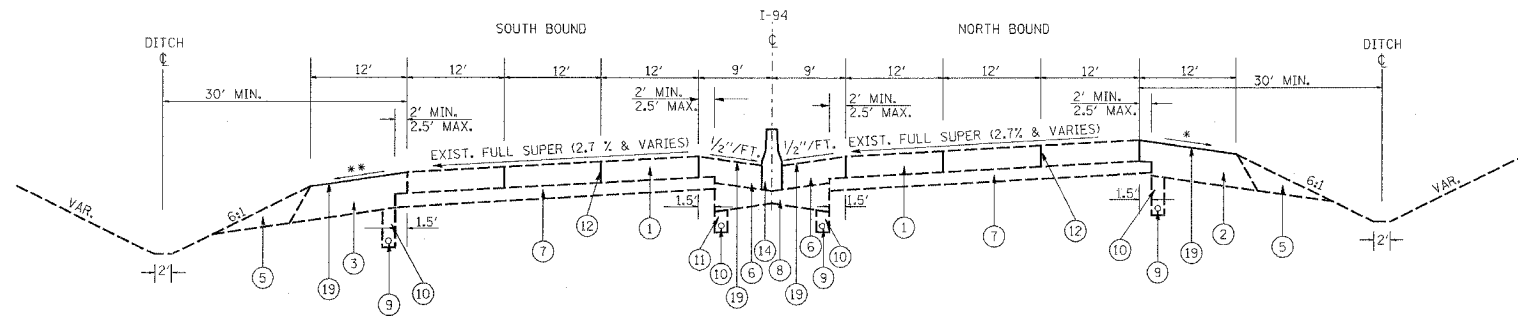

EXISTING/PROPOSED TYPICAL CROSS SECTION
 LAWRENCE AVE TO TOUHY AVE
 WILLOW RD TO DUNDEE RD

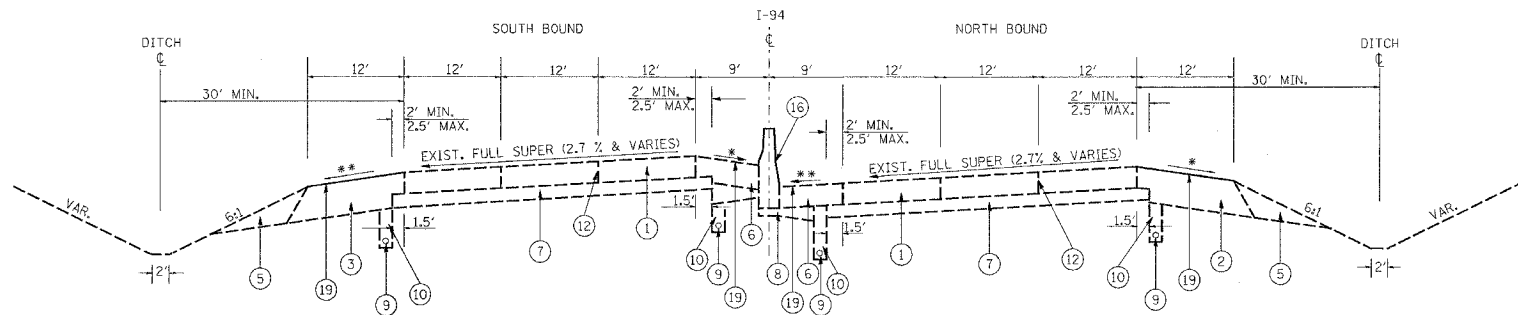

EXISTING/PROPOSED TYPICAL CROSS SECTION
 LAWRENCE AVE TO TOUHY AVE
 WILLOW RD TO DUNDEE RD

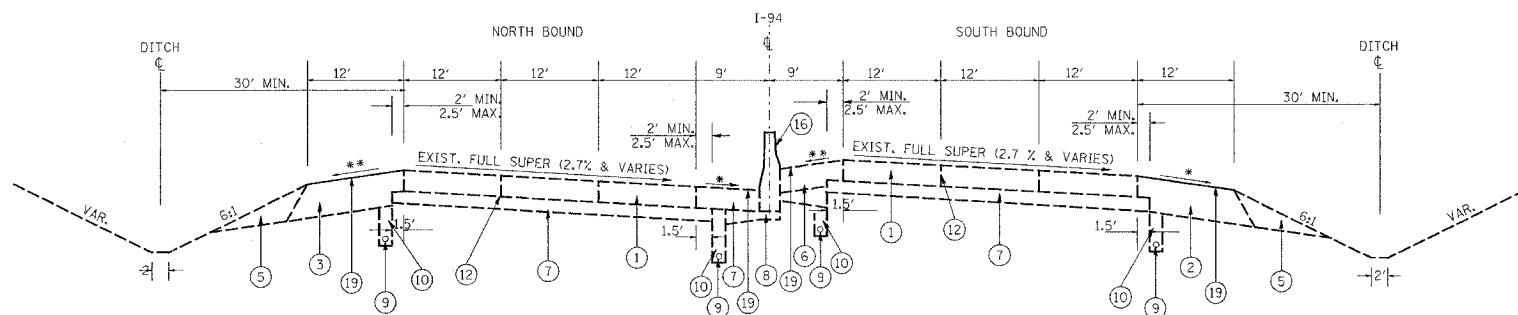

EXISTING/PROPOSED TYPICAL CROSS SECTION
 LAWRENCE AVE TO CALDWELL/PETERSON AVE
 OLD ORCHARD RD TO WILLOW RD
 WILLOW RD TO DUNDEE RD

PLOT DATE = 15/31/2005
 FILE NAME = c:\prowork\10103041\0103041a.mxd
 USER NAME = galbraith

F.A.I. RTE.	SECTION	COUNTY	TOTAL SHEETS	SHEET NO.
94	2005-0111	COOK	40	6
STA.		TO STA.		
FED. ROAD DIST. NO.	ILLINOIS	FED. AID PROJECT		

CONTRACT NO. 62929

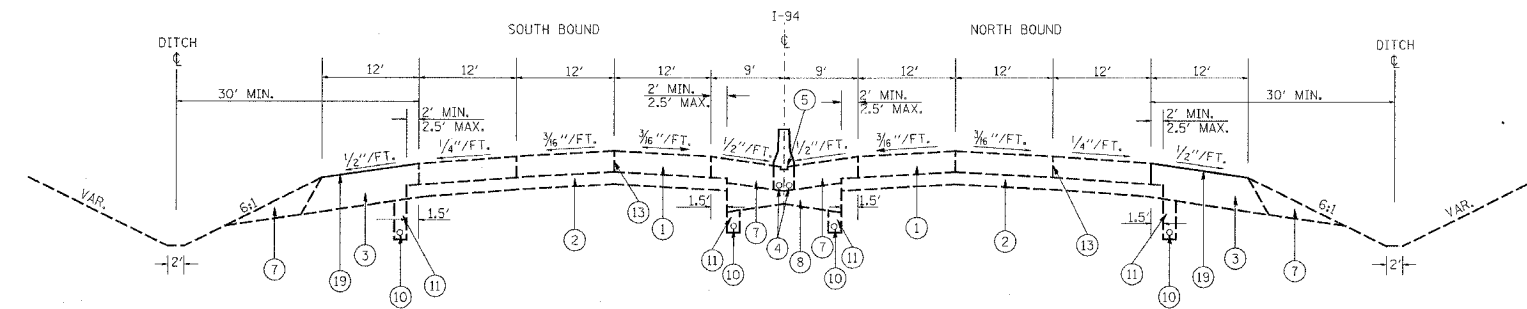

EXISTING/PROPOSED TYPICAL CROSS SECTION
TOUHY AVE TO WILLOW RD
WILLOW RD TO DUNDEE RD
DUNDEE RD TO LAKE-COOK RD

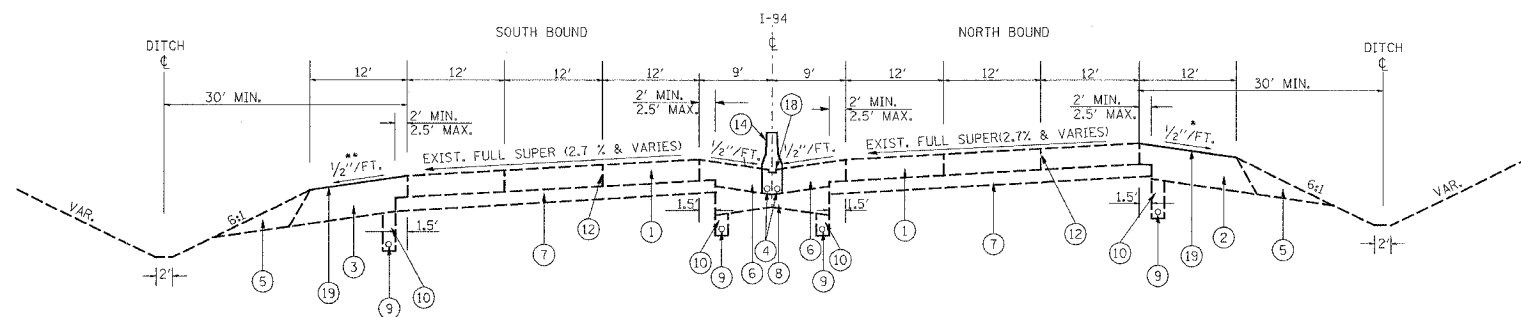

EXISTING/PROPOSED TYPICAL CROSS SECTION
DUNDEE RD TO LAKE-COOK RD
WILLOW RD TO DUNDEE RD

LEGEND

- ① EXISTING CONTINUOUSLY REINF. PCC PAVEMENT (10")
- ② EXISTING BITUMINOUS BASE COURSE, 13" (NORTHBOUND)
- ③ EXISTING BITUMINOUS SHOULDER, 13" (SOUTHBOUND)
- ④ EXISTING GRANULAR MATERIAL TYPE A, 6"
- ⑤ EXISTING AGGREGATE SHOULDER, TYPE B
- ⑥ EXISTING BITUMINOUS SHOULDER (10")
- ⑦ EXISTING STABILIZED SUB-BASE, 4"
- ⑧ EXISTING SUB BASE GRANULAR MATERIAL, SPECIAL
- ⑨ EXISTING PIPE UNDERDRAIN, 4"
- ⑩ EXISTING BACKFILL FOR PIPE UNDERDRAIN
- ⑪ EXIST. COMB. CONC. CURB & GUTTER
- ⑫ EXISTING CONSTRUCTION JOINT
- ⑬ EXISTING 4" DIA. PVC DUCT
- ⑭ EXISTING CONCRETE BARRIER WALL, TYPE 1
- ⑮ EXISTING CONCRETE BARRIER WALL, TYPE 2
- ⑯ EXISTING CONCRETE BARRIER WALL, TYPE 3
- ⑰ EXISTING CONCRETE BARRIER WALL, TYPE 4
- ⑱ EXISTING CONSTRUCTION JOINT & KEY WAY, 2" x 6"
- ⑲ PROPOSED ASPHALTIC EMULSION SLURRY SEAL COAT, TYPE IV

NOTE: EXISTING CONDITION

- WHEN THE SUPERELEVATION RATE OF THE EXISTING PAVEMENT IS BETWEEN 0.00 FT/FT AND 0.03 FT/FT THE SHOULDER SHALL BE SLOPED AT 0.04 FT/FT. WHEN THE SUPERELEVATION RATE OF THE PAVEMENT EXCEEDS 0.03 FT/FT, THE SHOULDER SHALL BE SLOPED SO THAT THE ALGEBRAIC DIFFERENCE BETWEEN PAVEMENT AND SHOULDER WILL NOT BE GREATER THAN 0.07 FT/FT.
- ** EXISTING BITUMINOUS SHOULDER SLOPE SHALL BE THE SAME AS THE SUPERELEVATION RATE BUT NOT LESS THAN 1/2"/FT.

REVISIONS	
NAME	DATE

ILLINOIS DEPARTMENT OF TRANSPORTATION
FAI 94/ I-94
LAWRENCE AVE TO LAKE-COOK RD
TYPICAL CROSS SECTION
SCALE: VERT. _____
DATE _____ HORIZ. _____
DRAWN BY _____
CHECKED BY _____

PLOT DATE = 5/31/2005
FILE NAME = c:\projects\94\9401\9401.dwg
USER = gatorb

F.A.I. RTE.	SECTION	COUNTY	TOTAL SHEETS	SHEET NO.
94	2005-0111	COOK	40	7

STA.	TO STA.
FED. ROAD DIST. NO.	ILLINOIS FED. AID PROJECT

CICERO AVENUE  I-94

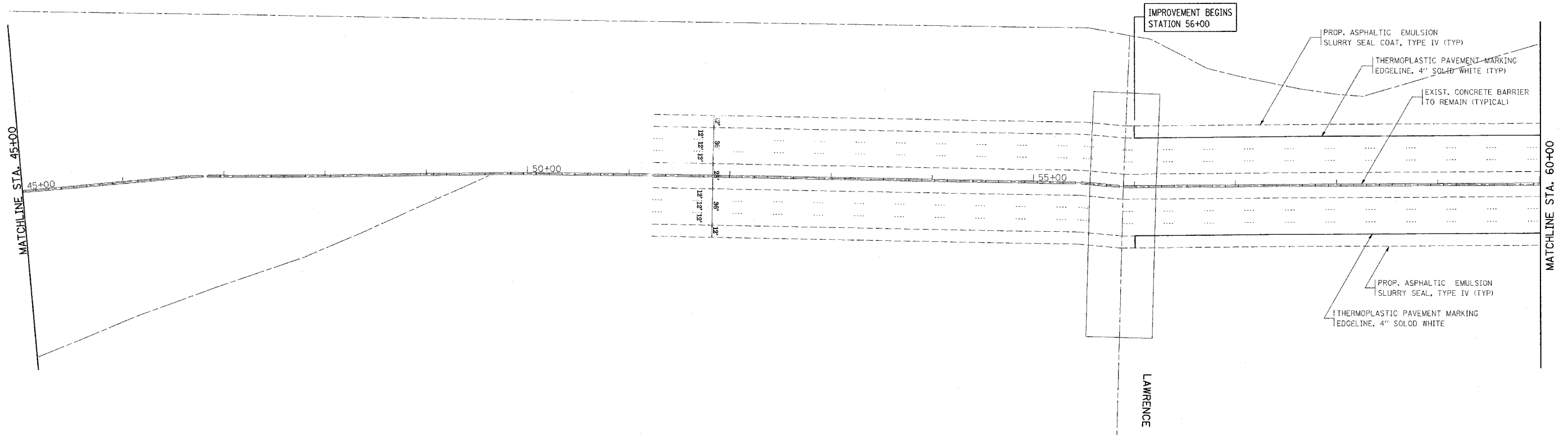

CICERO AVENUE  I-94

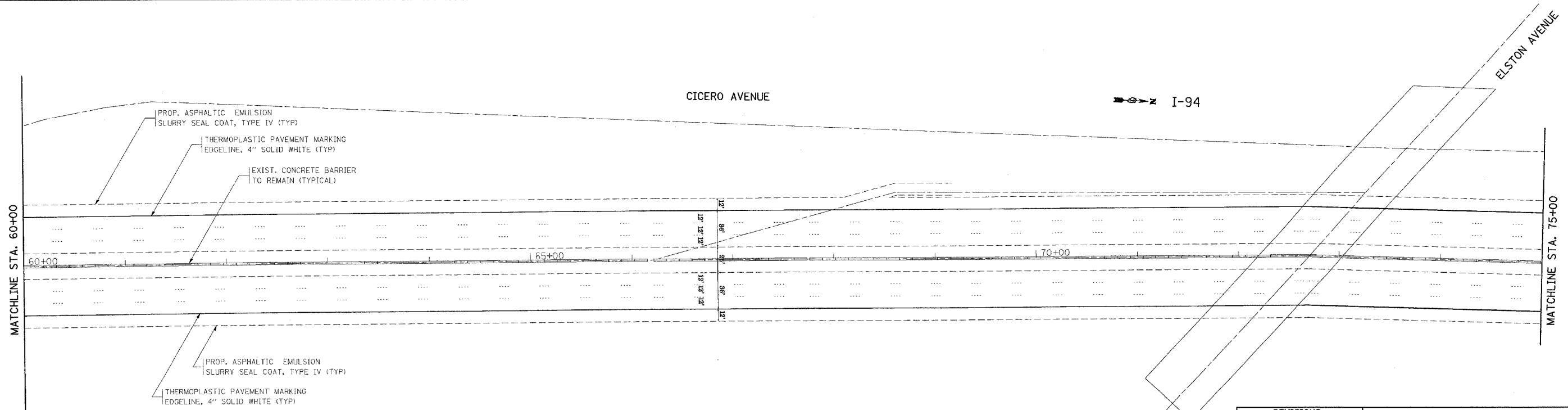

REVISIONS	
NAME	DATE

ILLINOIS DEPARTMENT OF TRANSPORTATION
 ROADWAY PLAN
 I-94
 LAWRENCE AVE TO LAKE-COOK RD.
 VERT. SCALE: 1"=50'
 HORIZ. SCALE: 1"=50'
 DATE 6/8/2005
 DRAWN BY
 CHECKED BY

PLOT DATE = 6/8/2005
 FILE NAME = c:\projects\116105\an_design\p1.dgn
 PLOT SCALE = 500000 / 1 IN.
 USER NAME = galbarr6

F.A.I. RTE.	SECTION	COUNTY	TOTAL SHEETS	SHEET NO.
94	2005-0111	COOK	40	8
STA.		TO STA.		
FED. ROAD DIST. NO.		ILLINOIS FED. AID PROJECT		

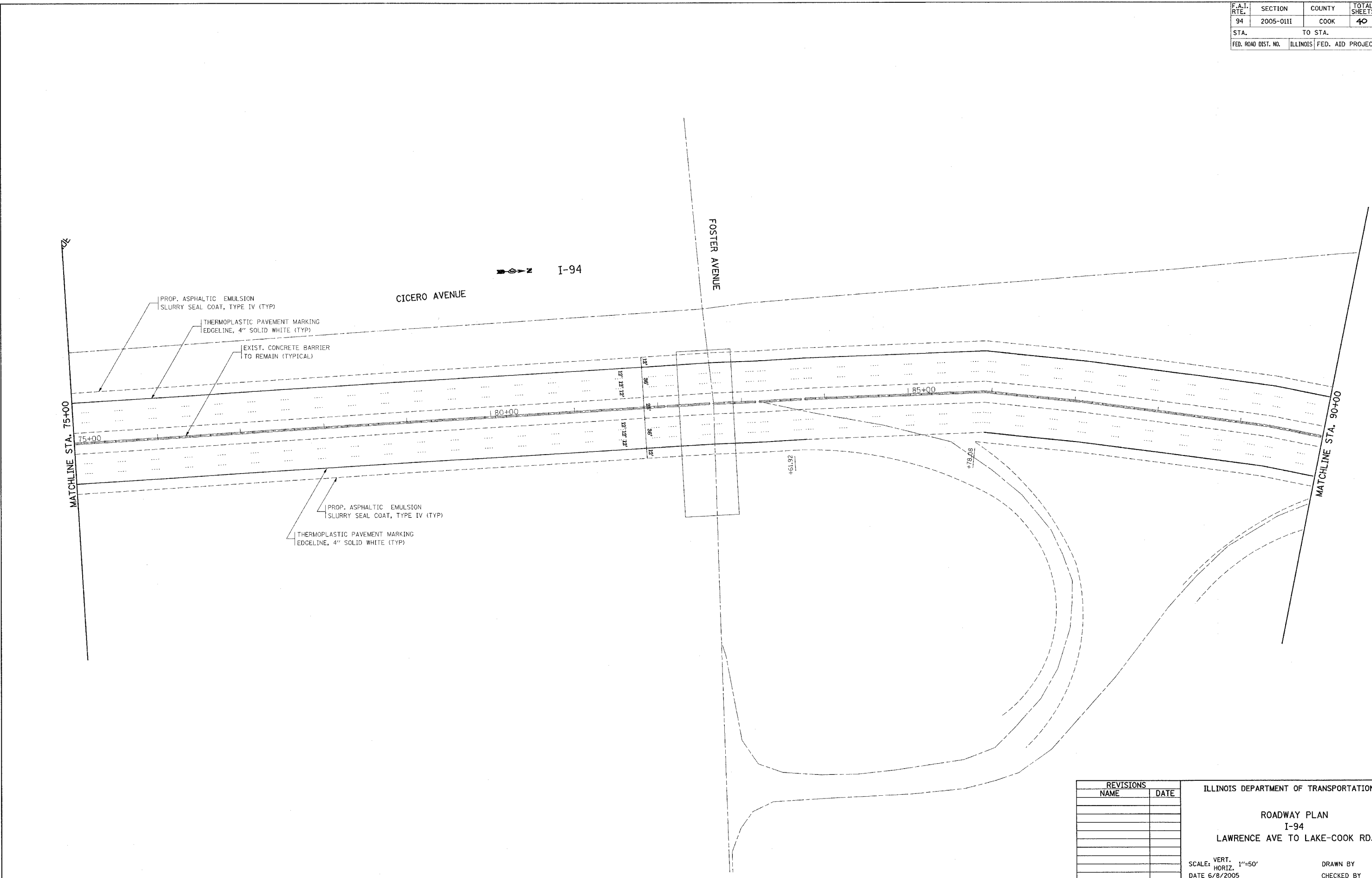

PLOT DATE = 6/8/2005
 FILE NAME = c:\projects\ad\105105\ah_design.dgn
 PLOT SCALE = 50.00000 / IN.
 USER NAME = galbarrb

REVISIONS	
NAME	DATE

ILLINOIS DEPARTMENT OF TRANSPORTATION
 ROADWAY PLAN
 I-94
 LAWRENCE AVE TO LAKE-COOK RD.
 SCALE: VERT. 1"=50'
 HORIZ. 1"=50'
 DATE 6/8/2005
 DRAWN BY
 CHECKED BY

F.A.I. RTE.	SECTION	COUNTY	TOTAL SHEETS	SHEET NO.
94	2005-0111	COOK	40	9
STA.		TO STA.		
FED. ROAD DIST. NO.	ILLINOIS	FED. AID PROJECT		

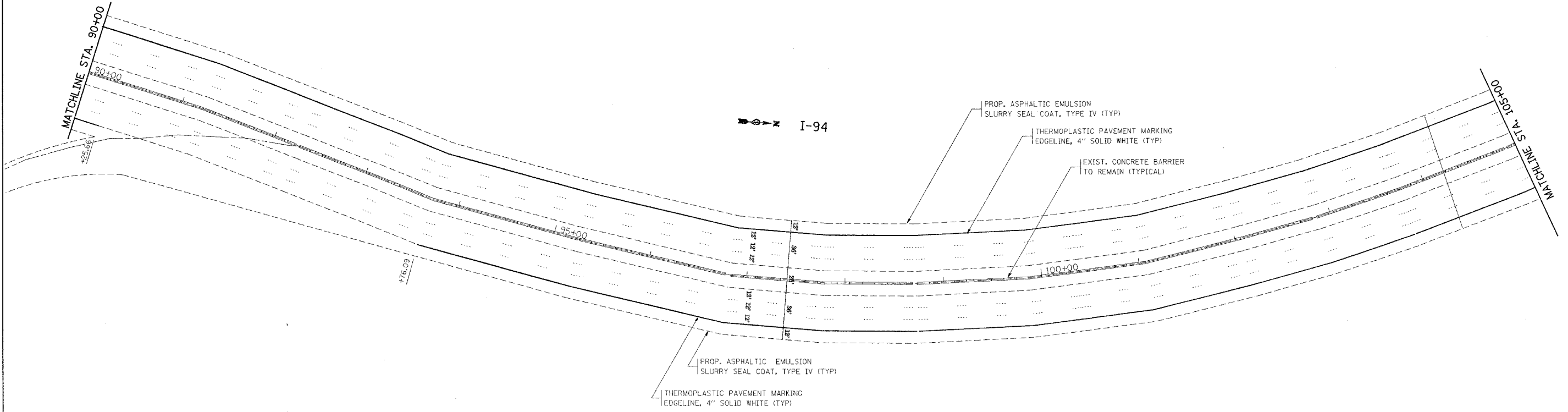

PLOT DATE = 6/8/2005
 USER = golbarnb
 USER NAME = golbarnb

REVISIONS	
NAME	DATE

ILLINOIS DEPARTMENT OF TRANSPORTATION

 ROADWAY PLAN
 I-94
 LAWRENCE AVE TO LAKE-COOK RD.

 SCALE: VERT. 1"=50'
 HORIZ. 1"=50'
 DATE 6/8/2005

 DRAWN BY
 CHECKED BY

F.A.I. RTE.	SECTION	COUNTY	TOTAL SHEETS	SHEET NO.
94	2005-0111	COOK	40	10
STA.		TO STA.		
FED. ROAD DIST. NO.		ILLINOIS		FED. AID PROJECT

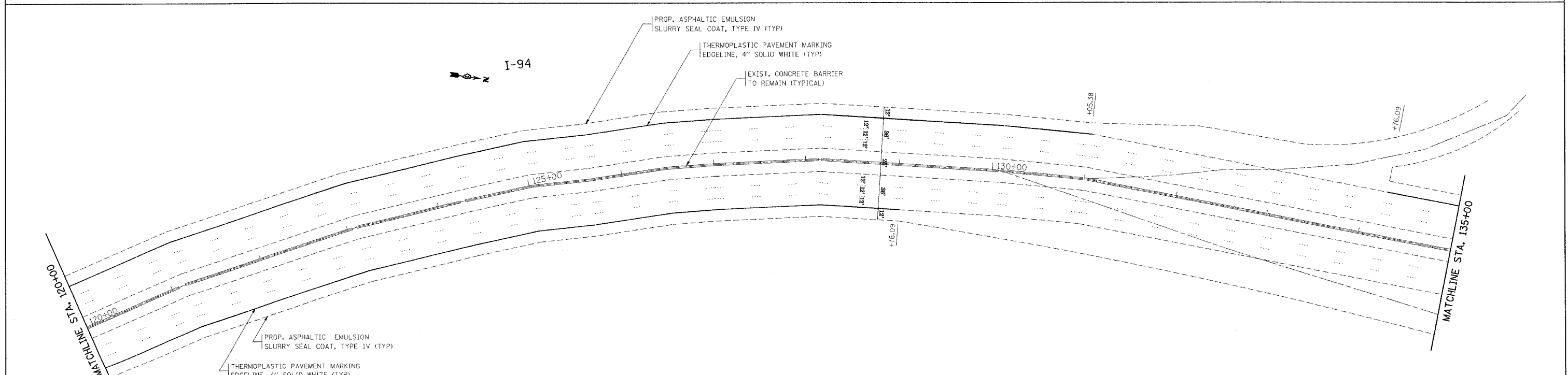
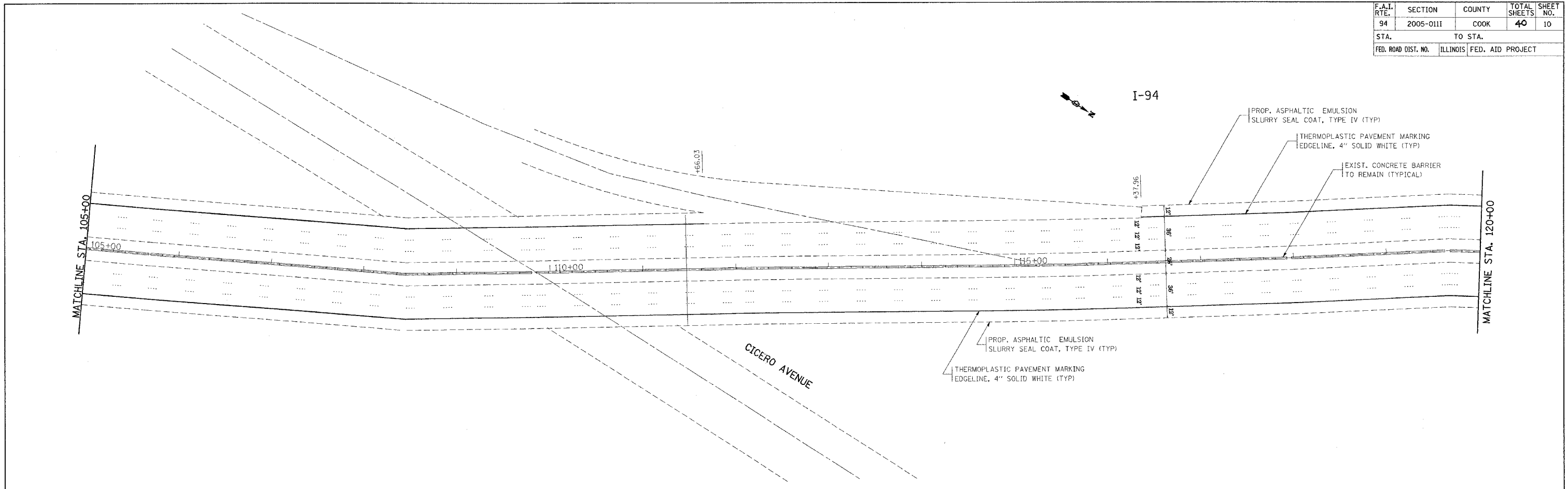

PLOT DATE = 6/8/2005
 FILE NAME = c:\projects\116186\116186.dgn
 PLOT SCALE = 1/8\"/>

REVISIONS	
NAME	DATE

ILLINOIS DEPARTMENT OF TRANSPORTATION

ROADWAY PLAN
I-94
LAWRENCE AVE TO LAKE-COOK RD.

SCALE: VERT. 1"=50'
 HORIZ. 1"=100'
 DATE 6/8/2005

DRAWN BY
 CHECKED BY

F.A.I. RTE.	SECTION	COUNTY	TOTAL SHEETS	SHEET NO.
94	2005-0111	COOK	40	11
STA.		TO STA.		
FED. ROAD DIST. NO.	ILLINOIS	FED. AID PROJECT		

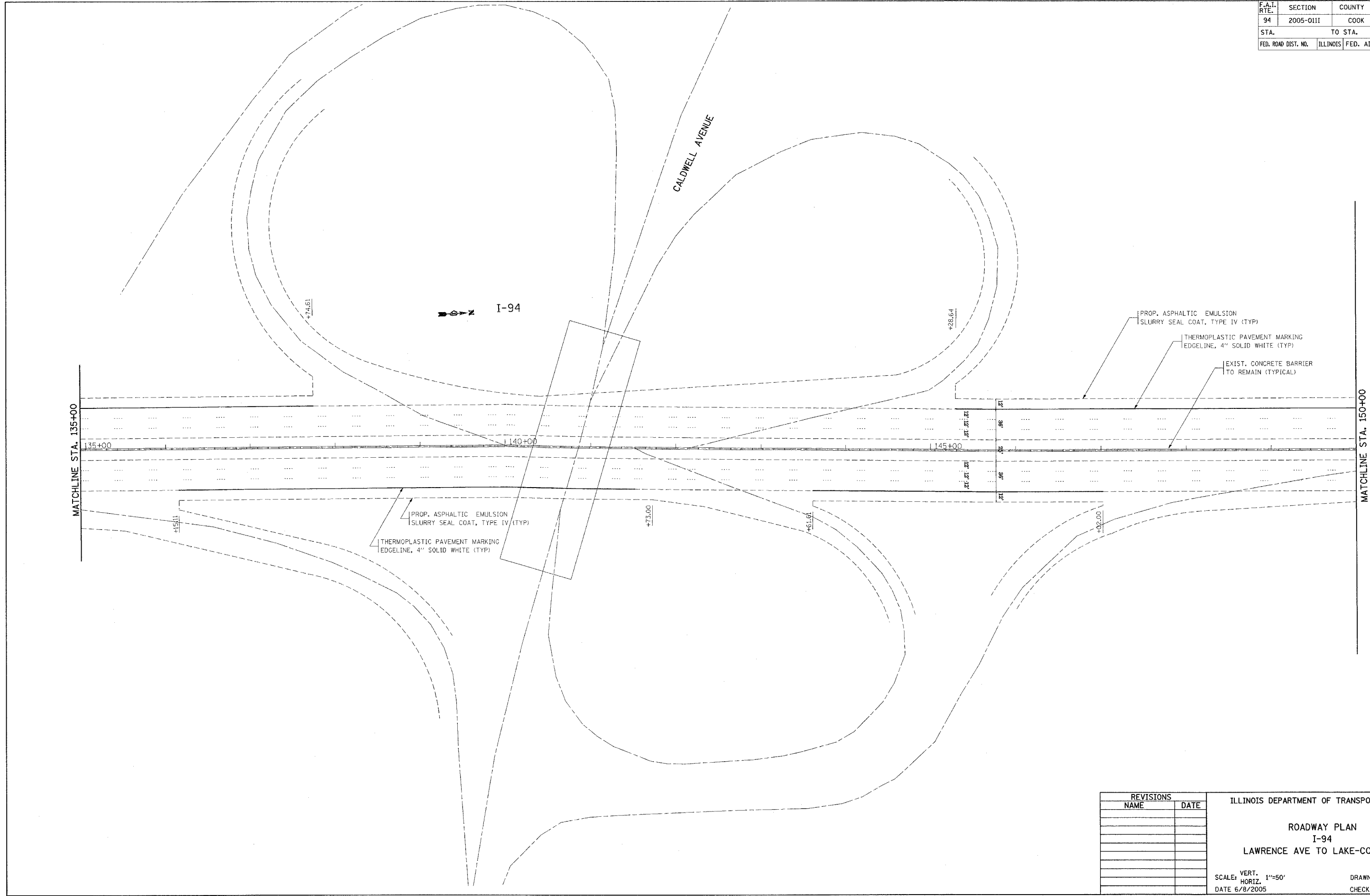

PLOT DATE = 6/8/2005
 FILE NAME = c:\projects\616185\sh_design\pdpn
 PLOT SCALE = 6/8/2005 / JL
 USER NAME = galsano

REVISIONS	
NAME	DATE

ILLINOIS DEPARTMENT OF TRANSPORTATION

ROADWAY PLAN
I-94
LAWRENCE AVE TO LAKE-COOK RD.

SCALE: VERT. 1"=50'
 HORIZ. 1"=50'
 DATE 6/8/2005

DRAWN BY
 CHECKED BY

F.A.I. RTE.	SECTION	COUNTY	TOTAL SHEETS	SHEET NO.
94	2005-0111	COOK	40	12
STA.		TO STA.		
FED. ROAD DIST. NO.	ILLINOIS	FED. AID PROJECT		

I-94

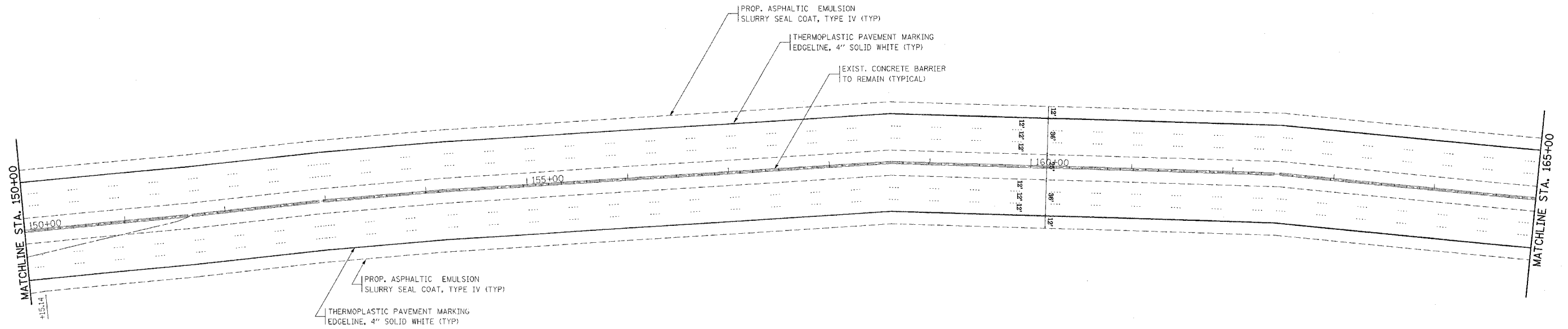

I-94

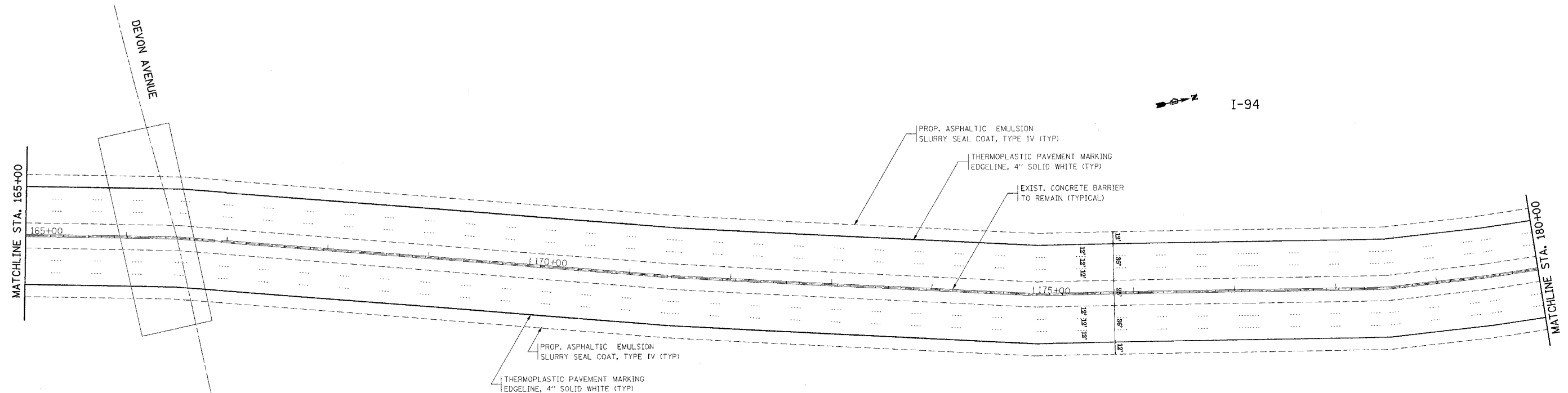

REVISIONS	
NAME	DATE

ILLINOIS DEPARTMENT OF TRANSPORTATION
 ROADWAY PLAN
 I-94
 LAWRENCE AVE TO LAKE-COOK RD.
 SCALE: VERT. 1"=50'
 HORIZ. DATE 6/8/2005
 DRAWN BY
 CHECKED BY

PLOT DATE = 6/8/2005
 PLOT SCALE = 1/4"=50'
 USER NAME = gillbarr

F.A.I. RTE.	SECTION	COUNTY	TOTAL SHEETS	SHEET NO.
94	2005-0111	COOK	40	13
STA.		TO STA.		
FED. ROAD DIST. NO.		ILLINOIS FED. AID PROJECT		

I-94

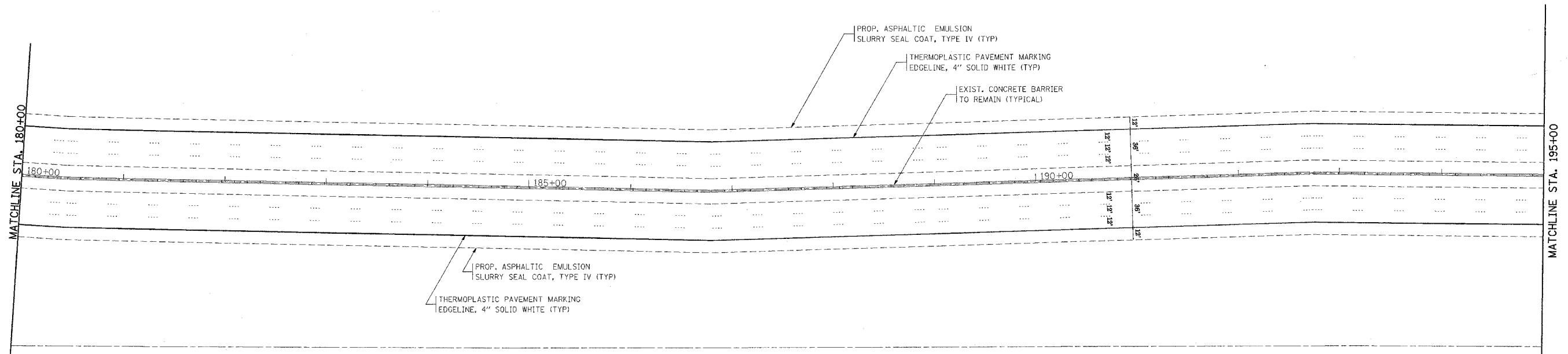

I-94

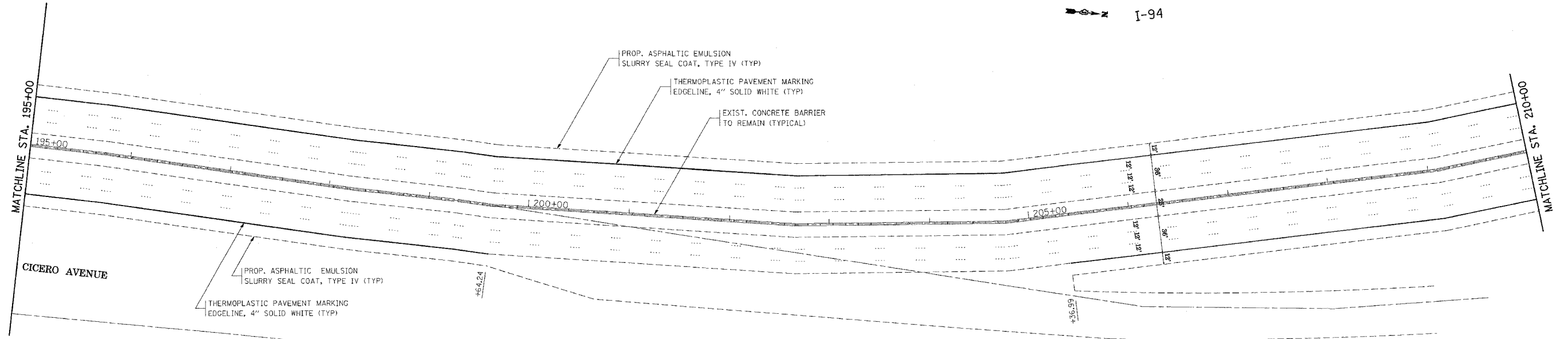

REVISIONS	
NAME	DATE

ILLINOIS DEPARTMENT OF TRANSPORTATION
 ROADWAY PLAN
 I-94
 LAWRENCE AVE TO LAKE-COOK RD.
 SCALE: VERT. 1"=50'
 HORIZ. DATE 6/8/2005
 DRAWN BY
 CHECKED BY

PLOT DATE = 6/8/2005
 FILE NAME = c:\prowork\valleib\valleib.dgn
 PLOT SCALE = 500000 / IN.
 USER NAME = galsworb

F.A.I. RTE.	SECTION	COUNTY	TOTAL SHEETS	SHEET NO.
94	2005-011	COOK	40	14
STA.		TO STA.		
FED. ROAD DIST. NO.		ILLINOIS	FED. AID PROJECT	

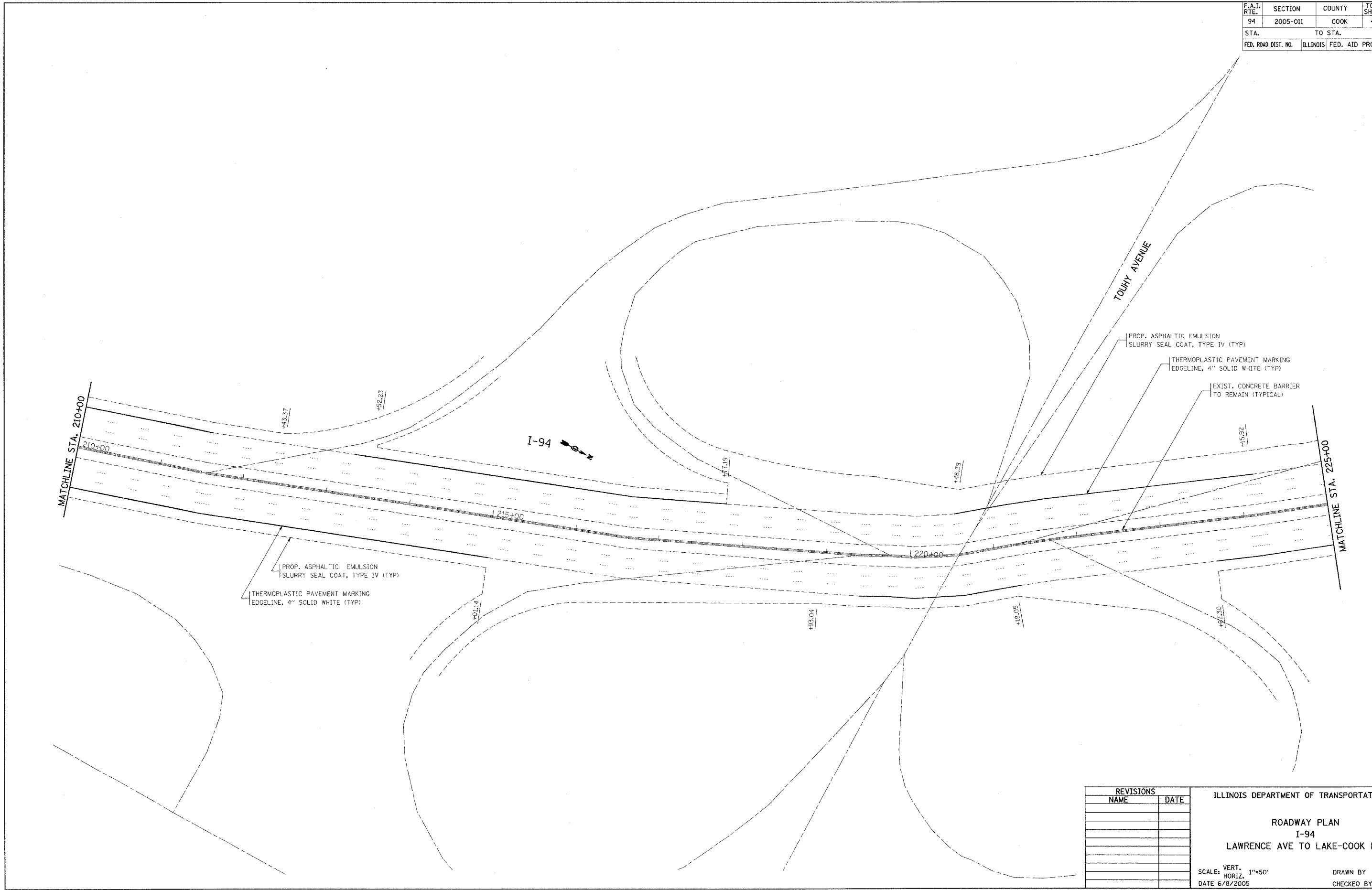

REVISIONS	
NAME	DATE

ILLINOIS DEPARTMENT OF TRANSPORTATION

ROADWAY PLAN
I-94
LAWRENCE AVE TO LAKE-COOK RD.

SCALE: VERT. 1"=50'
DATE 6/8/2005

DRAWN BY
CHECKED BY

PLOT DATE = 6/8/2005
 FILE NAME = c:\projects\62929\i18186\ah_design.dgn
 USER NAME = golbomh

F.A.I. RTE.	SECTION	COUNTY	TOTAL SHEETS	SHEET NO.
94	2005-0111	COOK	40	15
STA.		TO STA.		
FED. ROAD DIST. NO.	ILLINOIS	FED. AID PROJECT		

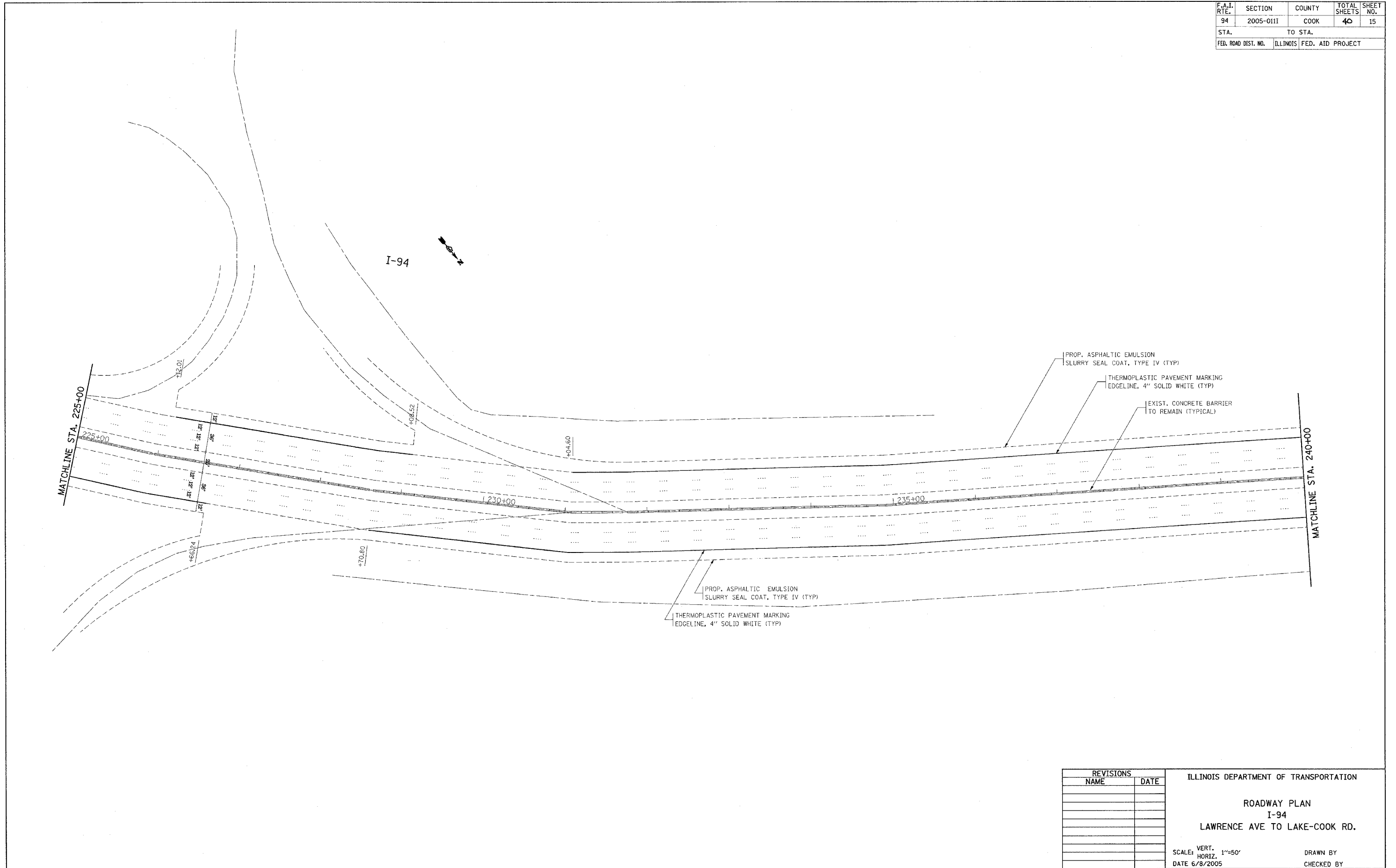

PLOT DATE = 6/8/2005
 FILE NAME = c:\p\proj\2005\i151615\plan_desig.dgn
 PLOT SCALE = 5000000 / IN
 USER NAME = gabbard

REVISIONS	
NAME	DATE

ILLINOIS DEPARTMENT OF TRANSPORTATION

ROADWAY PLAN
I-94
LAWRENCE AVE TO LAKE-COOK RD.

SCALE: VERT. 1"=50'
HORIZ. 1"=50'

DATE 6/8/2005

DRAWN BY _____
CHECKED BY _____

F.A.I. RTE.	SECTION	COUNTY	TOTAL SHEETS	SHEET NO.
94	2005-0111	COOK	40	16
STA.		TO STA.		
FED. ROAD DIST. NO.	ILLINOIS	FED. AID PROJECT		

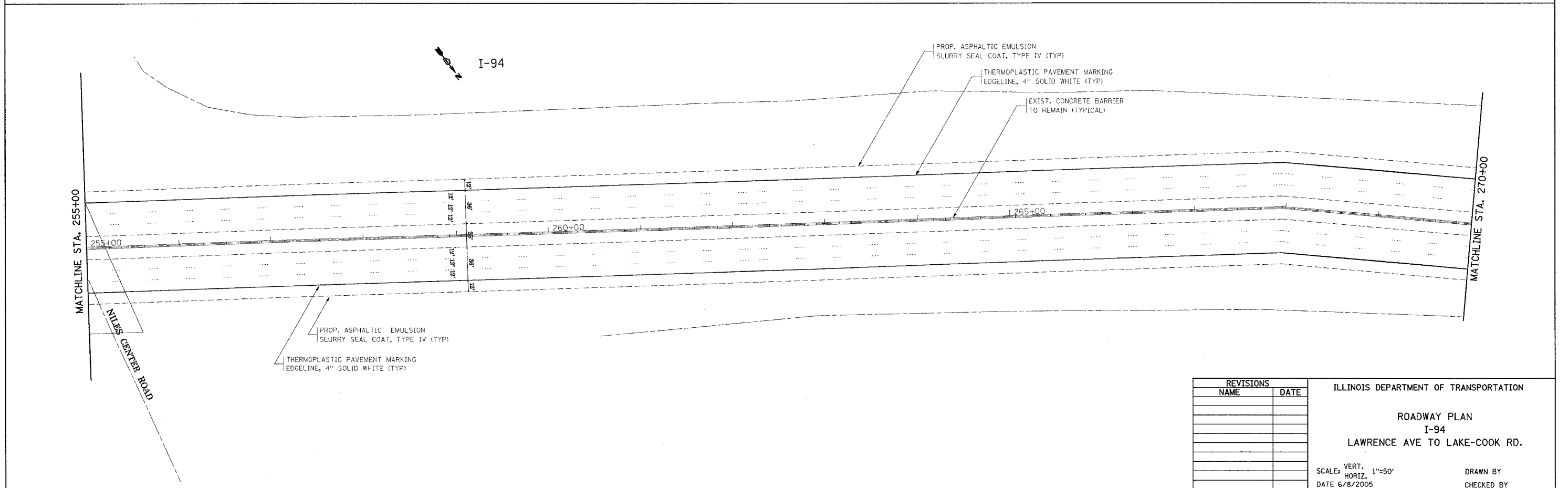
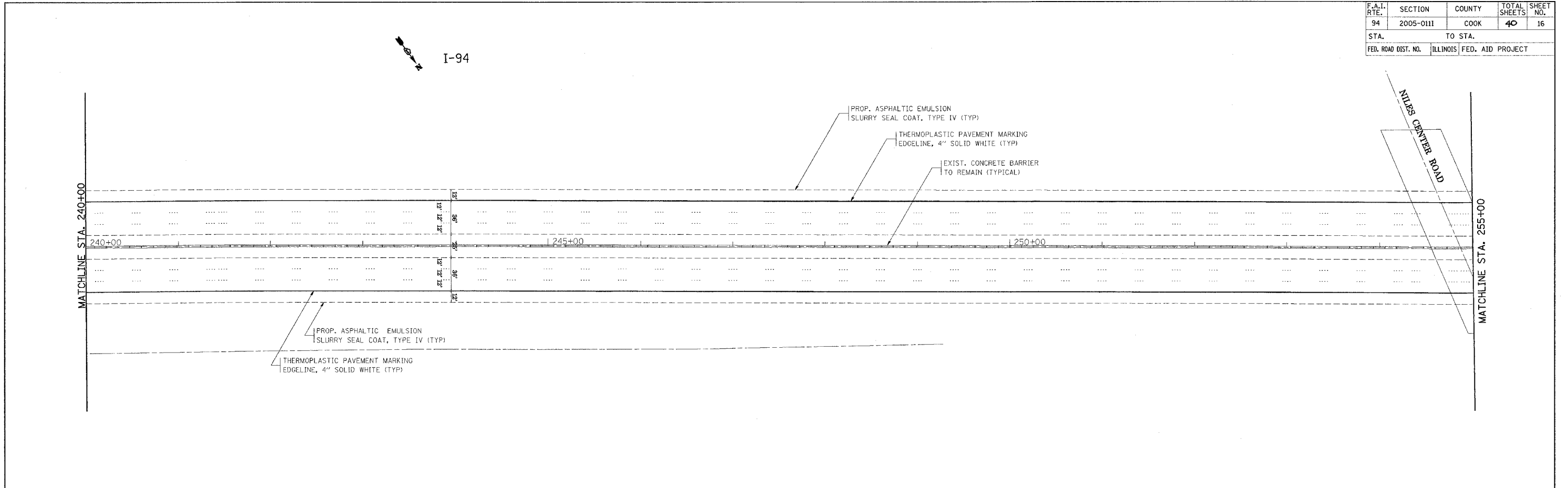

PLOT DATE = 6/8/2005
 FILE NAME = c:\pwworkspace\jls105\ah.dwg
 PLOT NAME = I-94
 USER NAME = gabbard

REVISIONS	
NAME	DATE

ILLINOIS DEPARTMENT OF TRANSPORTATION

ROADWAY PLAN
 I-94
 LAWRENCE AVE TO LAKE-COOK RD.

SCALE: VERT. 1"=50'
 HORIZ. DATE 6/8/2005

DRAWN BY
 CHECKED BY

F.A.I. RTE.	SECTION	COUNTY	TOTAL SHEETS	SHEET NO.
94	2005-0111	COOK	40	17
STA.		TO STA.		
FED. ROAD DIST. NO.	ILLINOIS	FED. AID PROJECT		

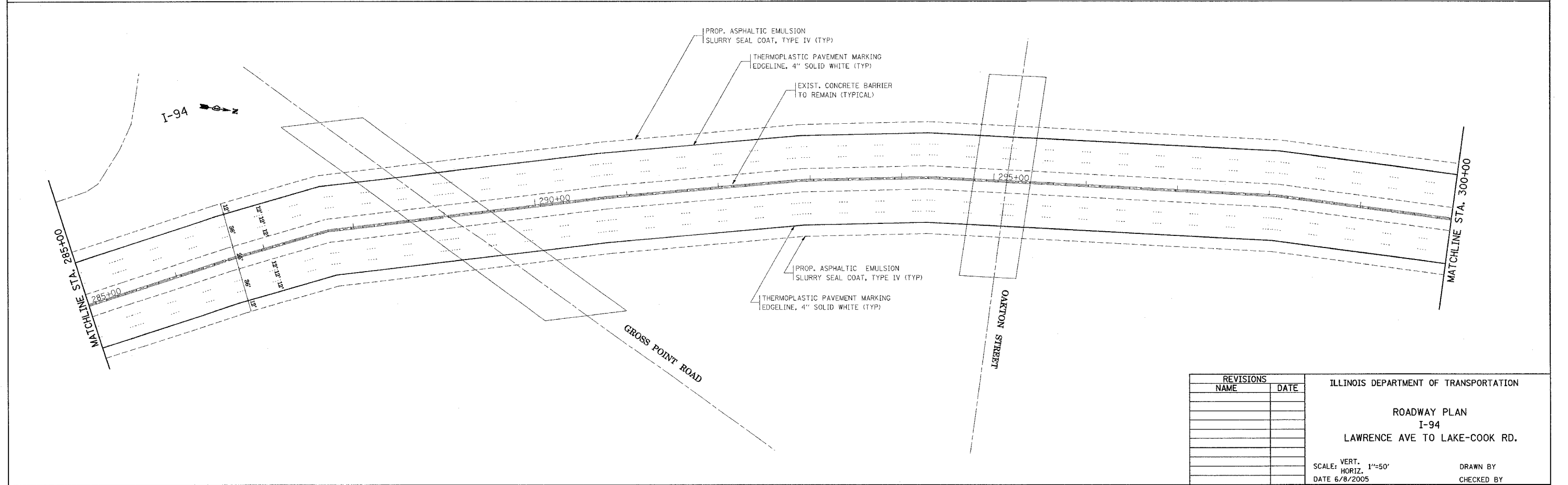
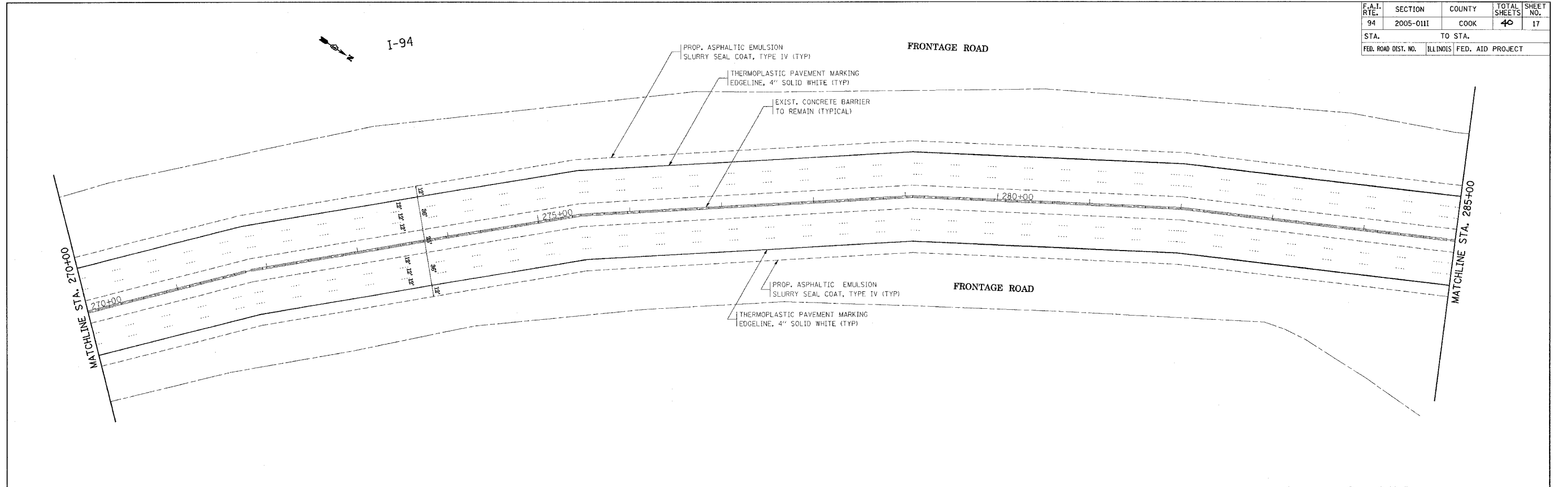

PLOT DATE = 6/8/2005
 FILE NAME = C:\projects\I94\I94\I94.dgn
 PLOT SCALE = 1/8\"/>

REVISIONS	
NAME	DATE

ILLINOIS DEPARTMENT OF TRANSPORTATION

ROADWAY PLAN
 I-94
 LAWRENCE AVE TO LAKE-COOK RD.

VERT. SCALE: 1"=50'
 DATE 6/8/2005

DRAWN BY
 CHECKED BY

F.A.I. RTE.	SECTION	COUNTY	TOTAL SHEETS	SHEET NO.
94	2005-0111	COOK	40	18
STA.		TO STA.		
FED. ROAD DIST. NO.	ILLINOIS	FED. AID PROJECT		

I-94

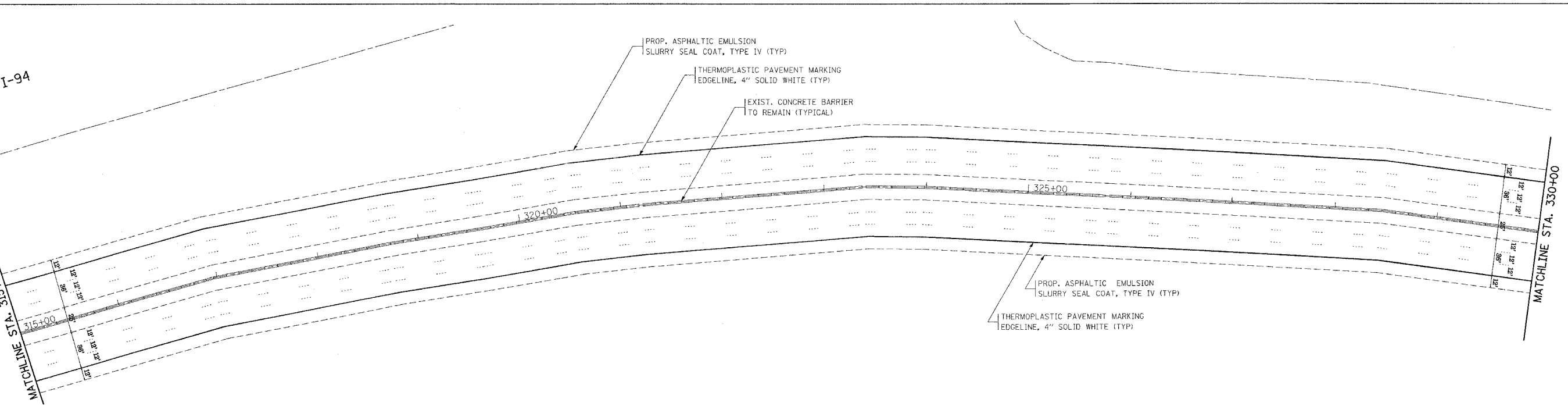
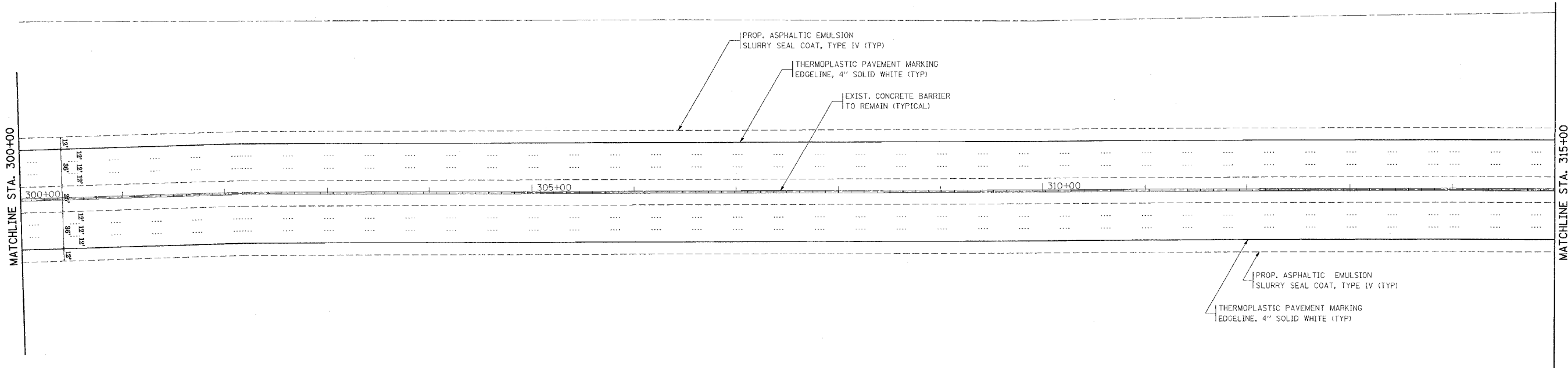

PLOT DATE = 6/8/2005
 FILE NAME = s:\projects\62929\plan\design.dgn
 PLOT SCALE = 50.0000 / IN.
 USER NAME = galbarrb

REVISIONS	
NAME	DATE

ILLINOIS DEPARTMENT OF TRANSPORTATION

ROADWAY PLAN
 I-94
 LAWRENCE AVE TO LAKE-COOK RD.

SCALE: VERT. 1"=50'
 HORIZ. 1"=50'
 DATE 6/8/2005

DRAWN BY
 CHECKED BY

F.A.I. RTE.	SECTION	COUNTY	TOTAL SHEETS	SHEET NO.
94	2005-0111	COOK	40	19
STA.		TO STA.		
FED. ROAD DIST. NO.		ILLINOIS FED. AID PROJECT		

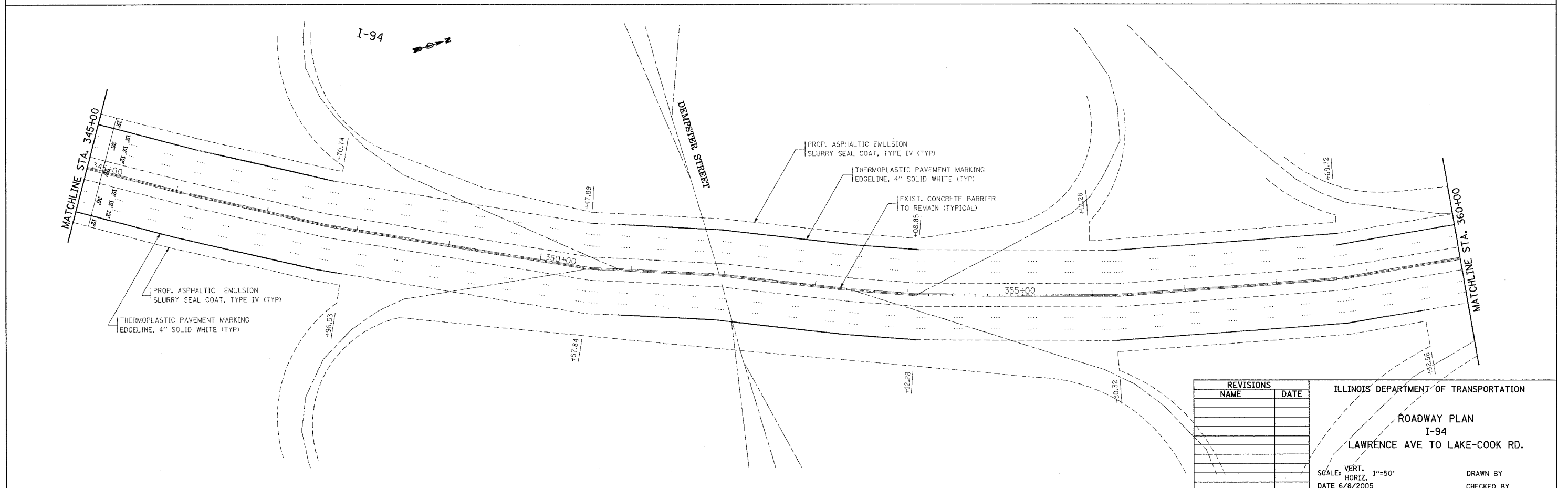
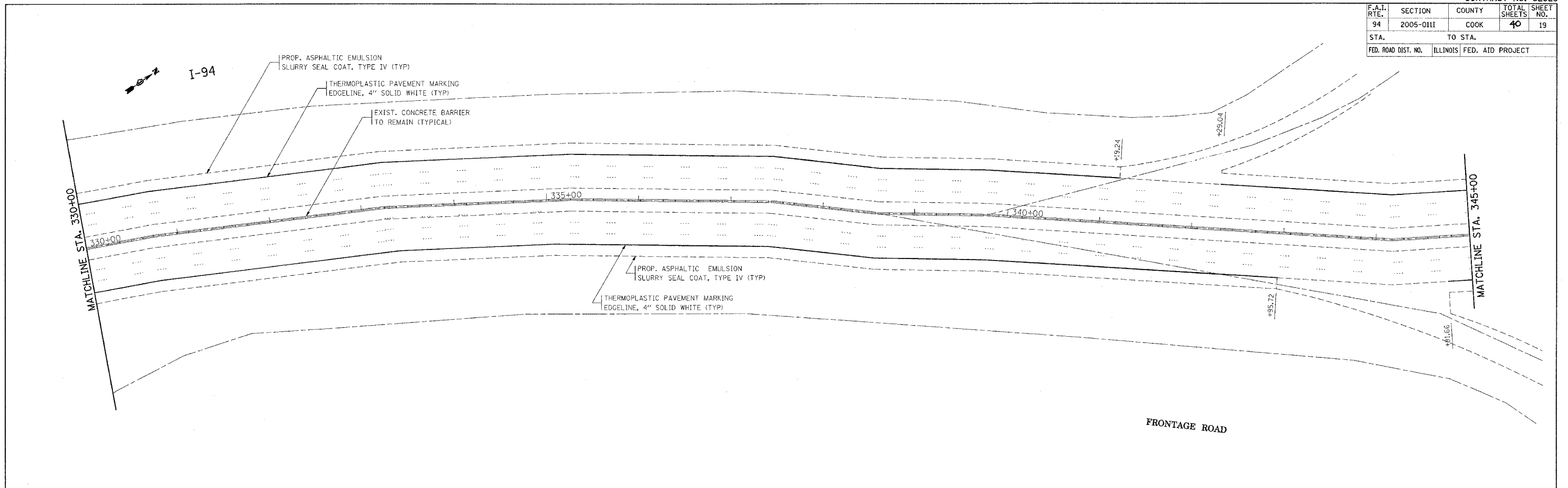

REVISIONS	
NAME	DATE

ILLINOIS DEPARTMENT OF TRANSPORTATION
 ROADWAY PLAN
 I-94
 LAWRENCE AVE TO LAKE-COOK RD.
 SCALE: VERT. 1"=50'
 HORIZ. 1"=50'
 DATE 6/8/2005
 DRAWN BY
 CHECKED BY

PLOT DATE = 6/8/2005
 FILE NAME = c:\projects\ill16105\ah_design\p19.dgn
 USER NAME = gsh5096

F.A.I. RTE.	SECTION	COUNTY	TOTAL SHEETS	SHEET NO.
94	2005-0111	COOK	40	20
STA.		TO STA.		
FED. ROAD DIST. NO.	ILLINOIS	FED. AID PROJECT		

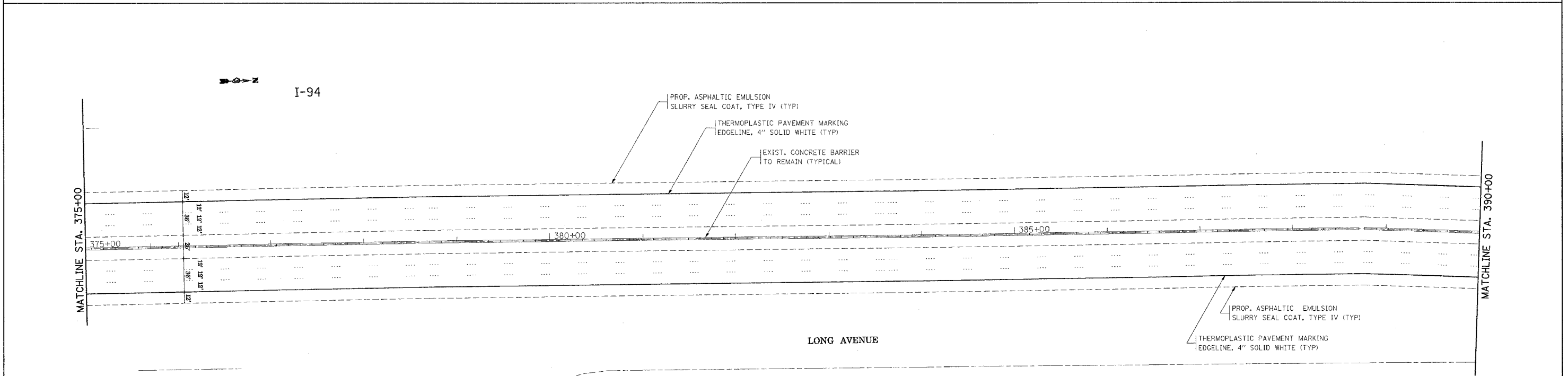
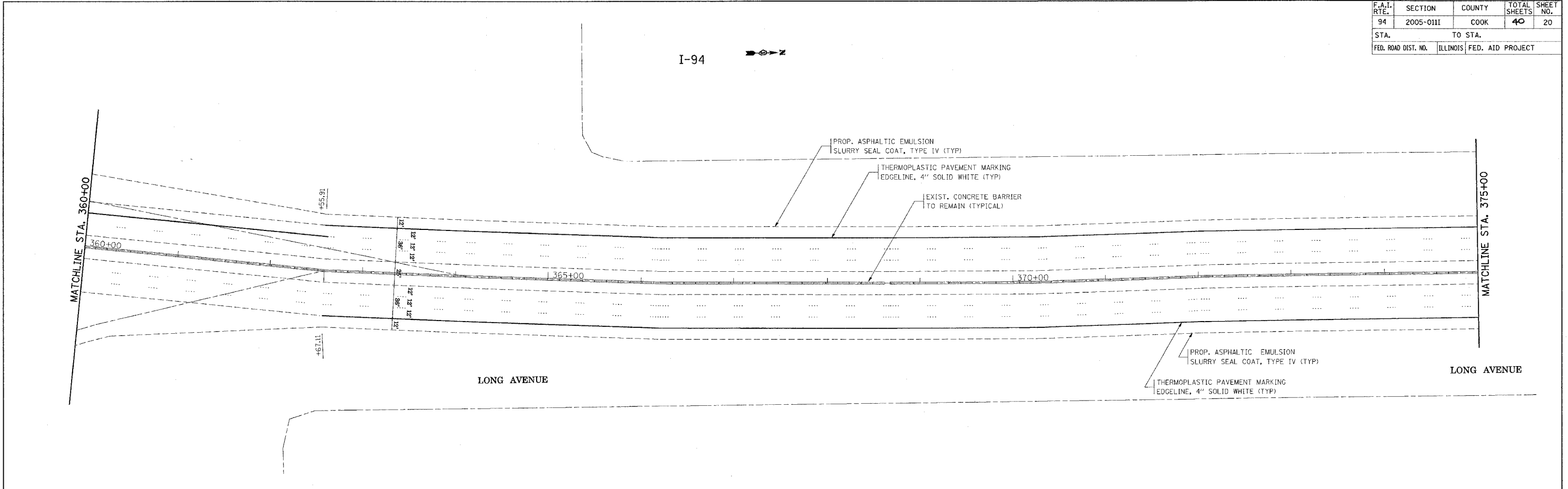

PLOT DATE = 6/8/2005
 FILE NAME = c:\p\proj\62929\1111111111\1111111111.dgn
 PLOT SCALE = 1/8"=1'-0"
 USER NAME = galsomab

REVISIONS	
NAME	DATE

ILLINOIS DEPARTMENT OF TRANSPORTATION

ROADWAY PLAN
 I-94
 LAWRENCE AVE TO LAKE-COOK RD.

SCALE: VERT. 1"=50'
 HORIZ. 1"=50'
 DATE 6/8/2005

DRAWN BY
 CHECKED BY

F.A.I. RTE.	SECTION	COUNTY	TOTAL SHEETS	SHEET NO.
94	2005-0111	COOK	40	21
STA.		TO STA.		
FED. ROAD DIST. NO.	ILLINOIS	FED. AID PROJECT		

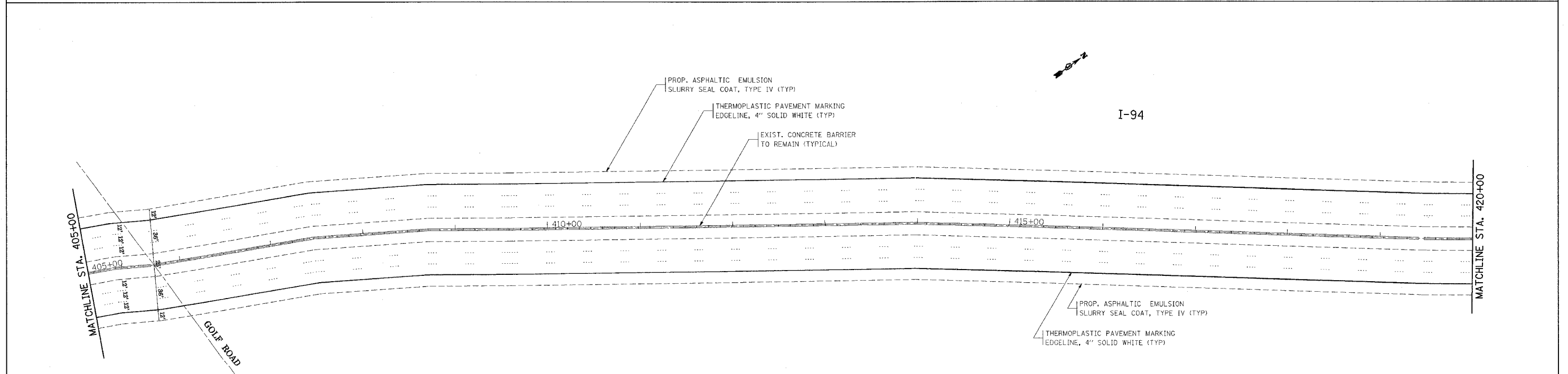
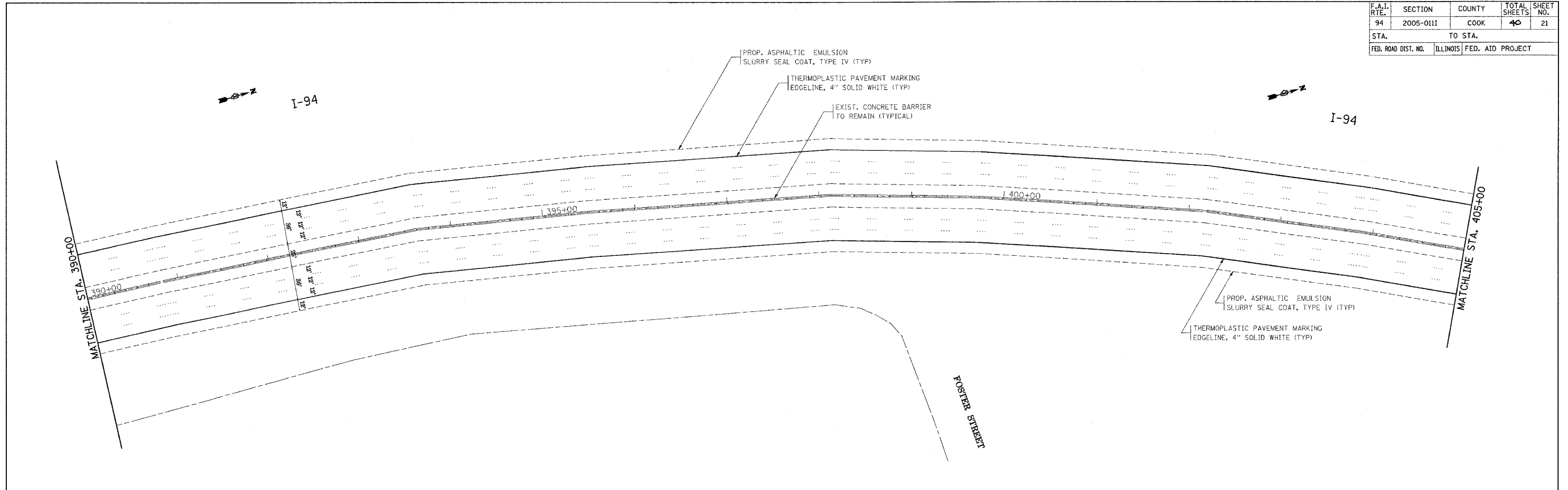

PLOT DATE = 6/8/2005
 FILE NAME = c:\proje\2005\1111\1111.dgn
 USER NAME = galsano

REVISIONS	
NAME	DATE

ILLINOIS DEPARTMENT OF TRANSPORTATION
 ROADWAY PLAN
 I-94
 LAWRENCE AVE TO LAKE-COOK RD.
 SCALE: VERT. 1"=50'
 HORIZ. 1"=50'
 DATE 6/8/2005
 DRAWN BY
 CHECKED BY

F.A.I. RTE.	SECTION	COUNTY	TOTAL SHEETS	SHEET NO.
94	2005-0111	COOK	40	22
STA.		TO STA.		
FED. ROAD DIST. NO.	ILLINOIS	FED. AID PROJECT		

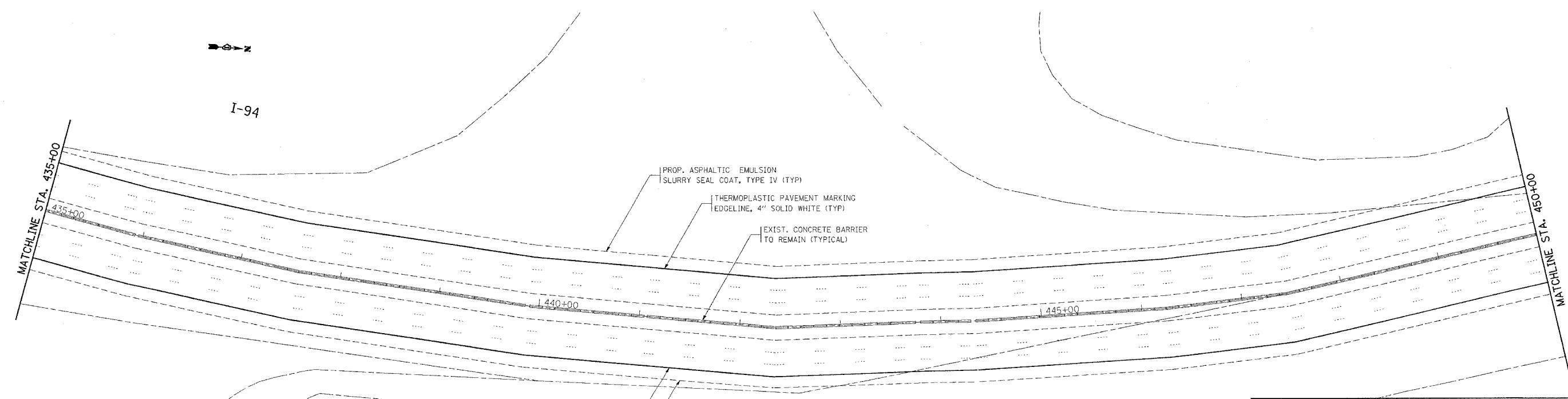
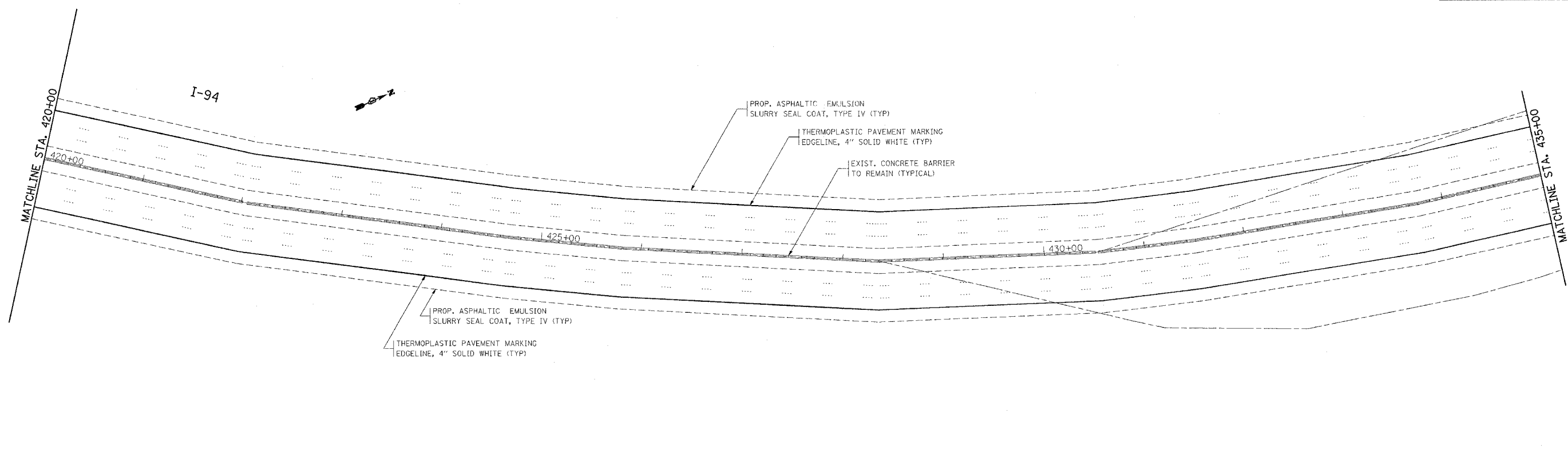

PLOT DATE = 6/8/2005
 PLOT SCALE = 1/8\"/>

REVISIONS	
NAME	DATE

ILLINOIS DEPARTMENT OF TRANSPORTATION

ROADWAY PLAN

I-94

LAWRENCE AVE TO LAKE-COOK RD.

SCALE: VERT. 1"=50'
 HORIZ. 1"=50'
 DATE 6/8/2005

DRAWN BY
 CHECKED BY

BURR OAK DRIVE

F.A.I. RTE.	SECTION	COUNTY	TOTAL SHEETS	SHEET NO.
94	2005-0111	COOK	40	23
STA.		TO STA.		
FED. ROAD DIST. NO.	ILLINOIS	FED. AID PROJECT		

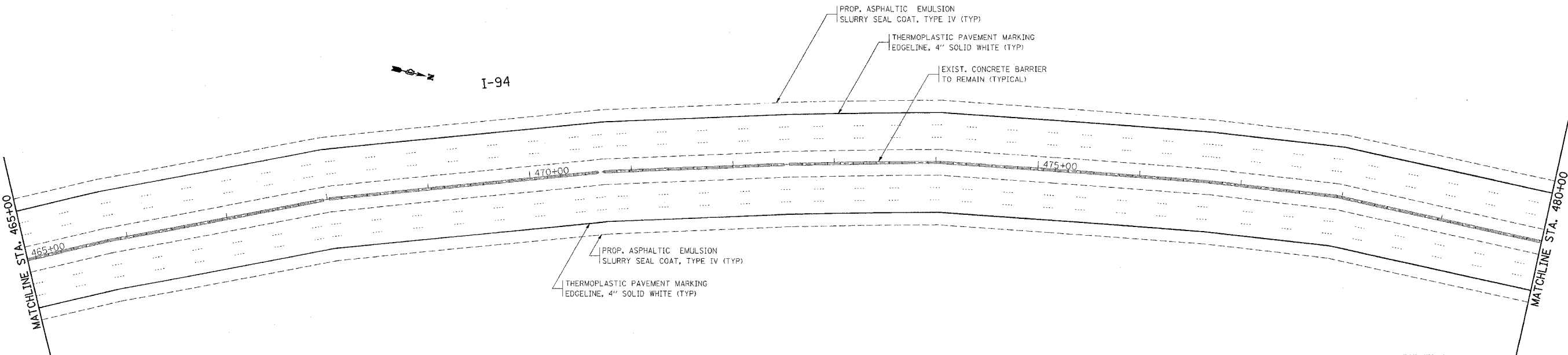
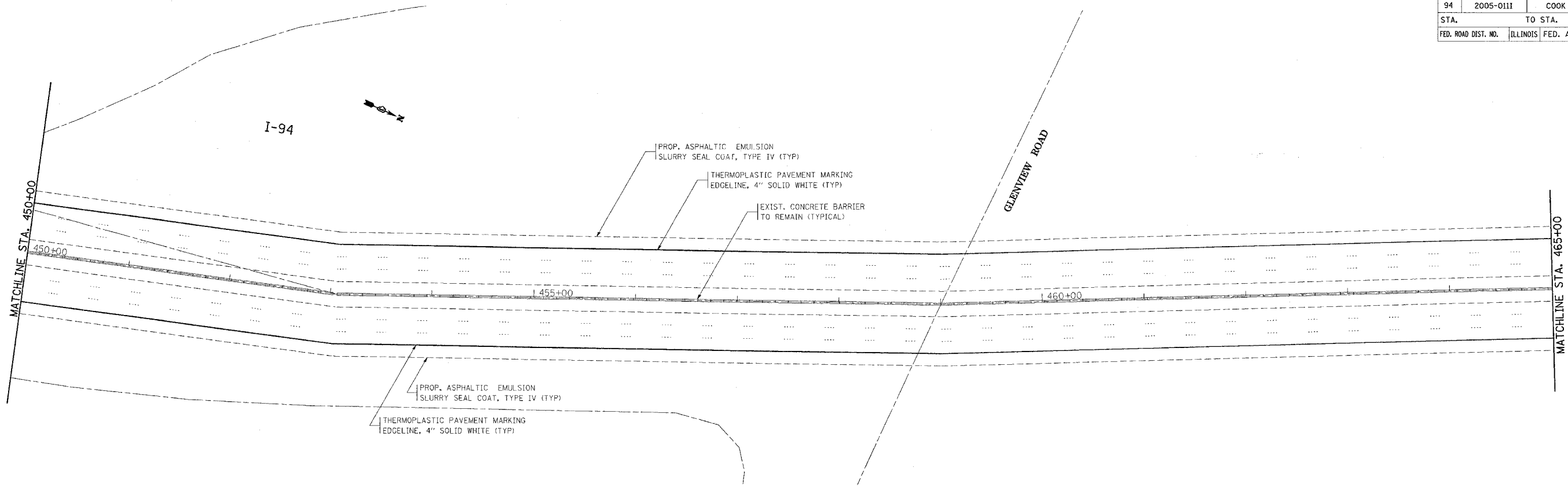

PLOT DATE = 6/8/2005
 PLOT SCALE = 5/8\"/>

REVISIONS	
NAME	DATE

ILLINOIS DEPARTMENT OF TRANSPORTATION

ROADWAY PLAN
 I-94
 LAWRENCE AVE TO LAKE-COOK RD.

SCALE: VERT. 1"=50'
 HORIZ. 1"=50'
 DATE 6/8/2005

DRAWN BY
 CHECKED BY

F.A.I. RTE.	SECTION	COUNTY	TOTAL SHEETS	SHEET NO.
94	2005-0111	COOK	40	24
STA.		TO STA.		
FED. ROAD DIST. NO.	ILLINOIS	FED. AID PROJECT		

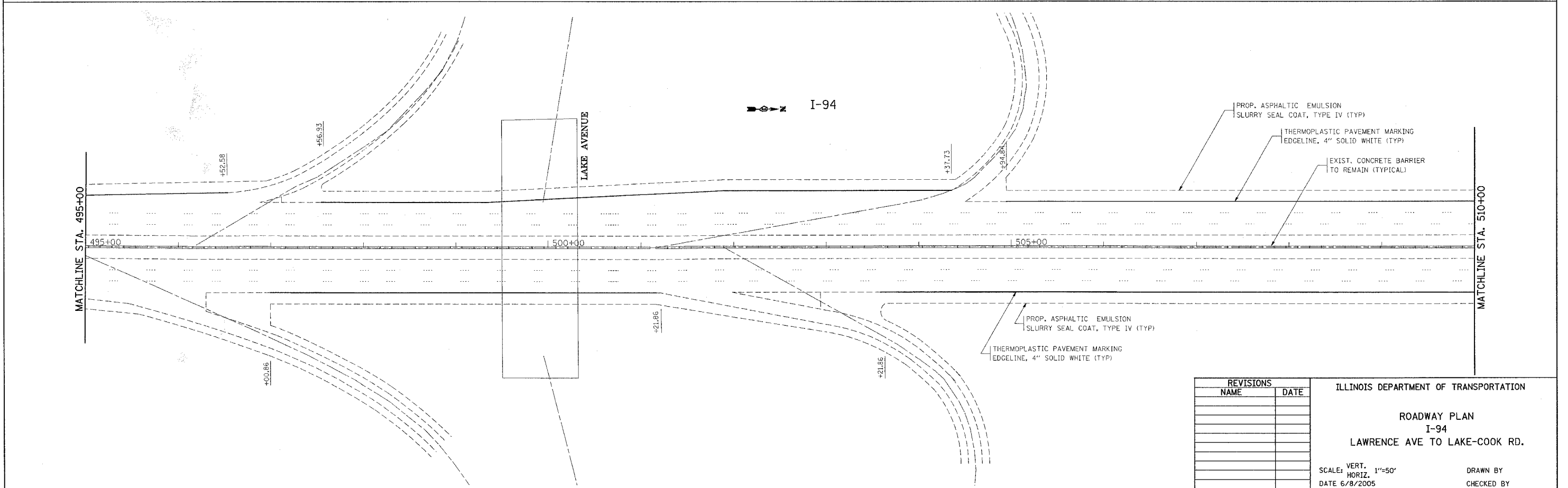
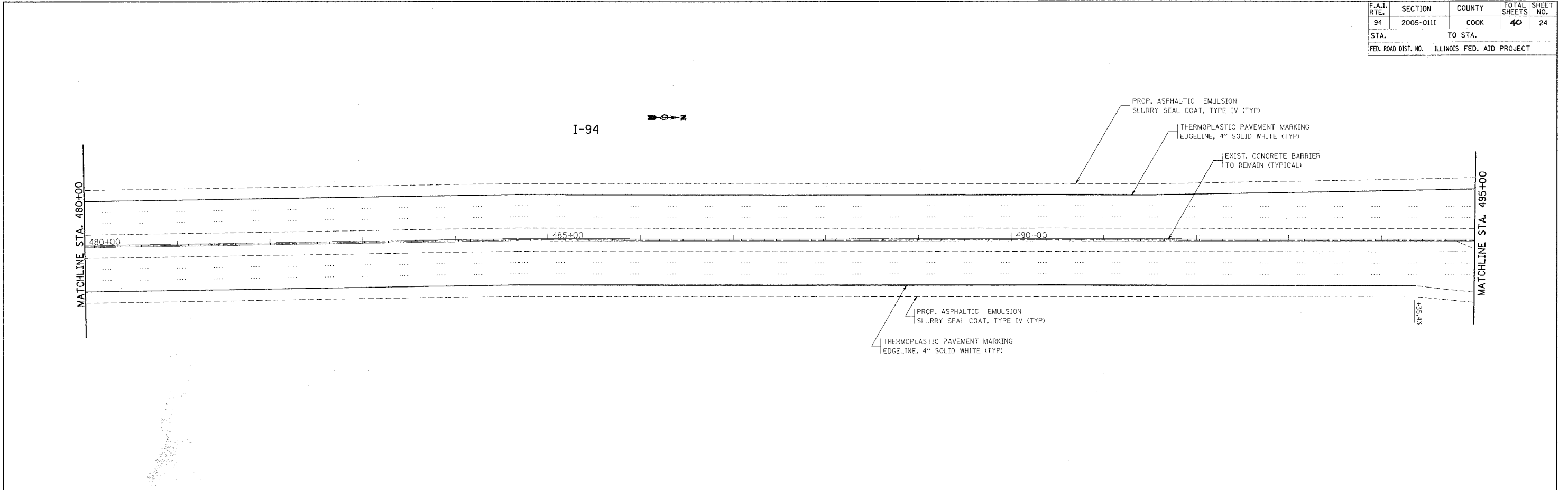

PLOT DATE = 6/8/2005
 PLOT SCALE = 50.0000 7. IN.
 USER NAME = galbannb

REVISIONS	
NAME	DATE

ILLINOIS DEPARTMENT OF TRANSPORTATION
 ROADWAY PLAN
 I-94
 LAWRENCE AVE TO LAKE-COOK RD.
 VERT. SCALE: 1"=50'
 HORIZ. SCALE: 1"=50'
 DATE 6/8/2005
 DRAWN BY
 CHECKED BY

F.A.I. RTE.	SECTION	COUNTY	TOTAL SHEETS	SHEET NO.
94	2005-0111	COOK	40	25
STA.		TO STA.		
FED. ROAD DIST. NO.		ILLINOIS FED. AID PROJECT		

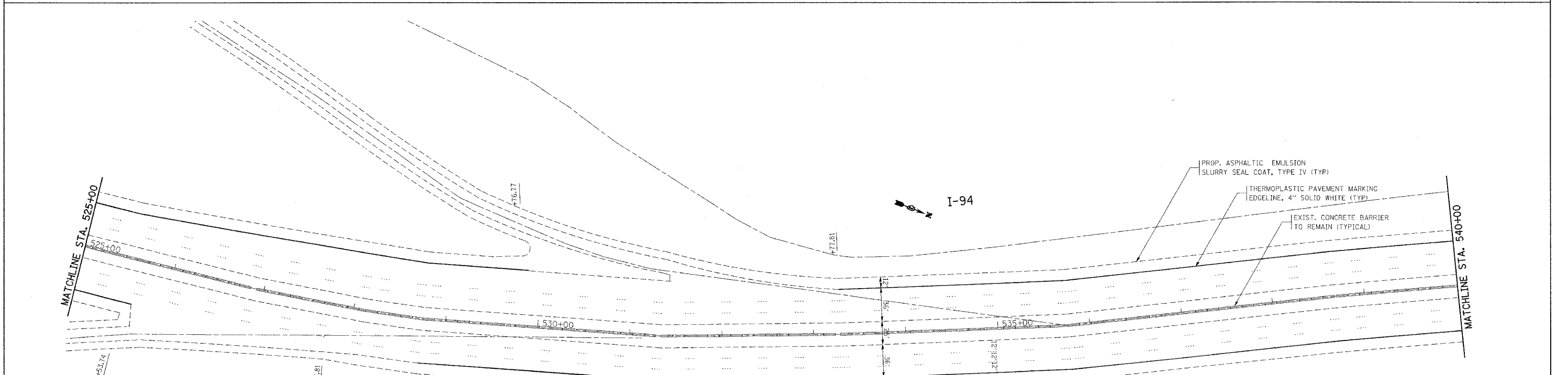
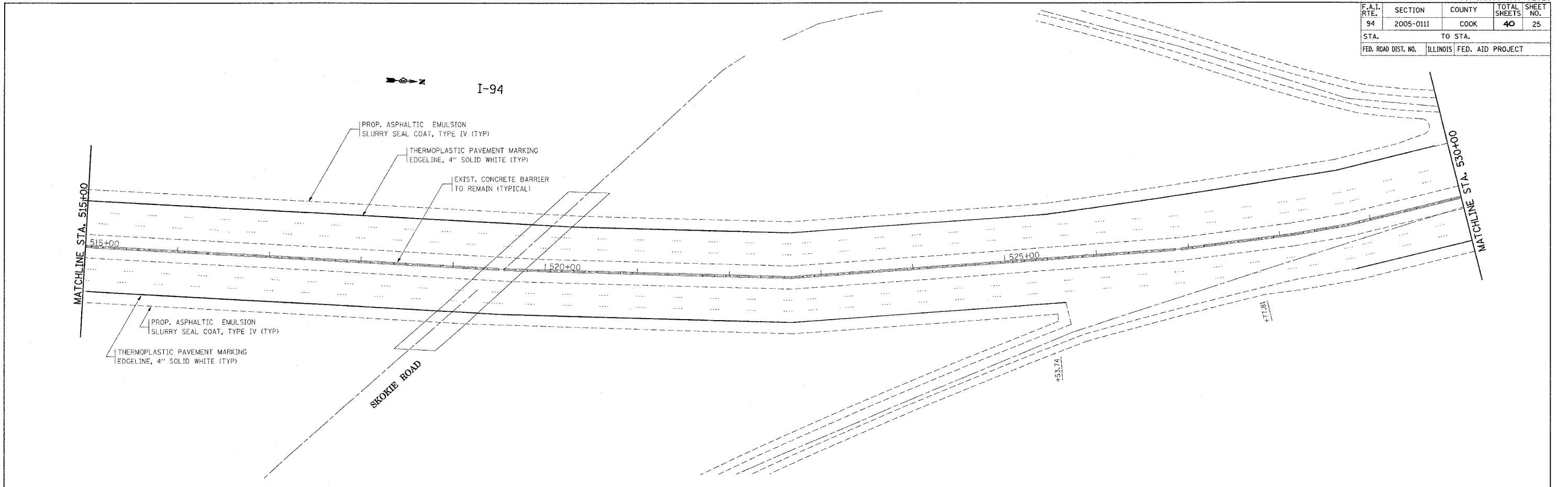

PLOT DATE = 6/8/2005
 FILE NAME = c:\projects\62929\i94\plan.dwg
 USER NAME = gabbard

REVISIONS	
NAME	DATE

ILLINOIS DEPARTMENT OF TRANSPORTATION
 ROADWAY PLAN
 I-94
 LAWRENCE AVE TO LAKE-COOK RD.
 SCALE: VERT. 1"=50'
 HORIZ. 1"=50'
 DATE 6/8/2005
 DRAWN BY
 CHECKED BY

F.A.I. RTE.	SECTION	COUNTY	TOTAL SHEETS	SHEET NO.
94	2005-0111	COOK	40	26
STA.		TO STA.		
FED. ROAD DIST. NO.		ILLINOIS	FED. AID PROJECT	

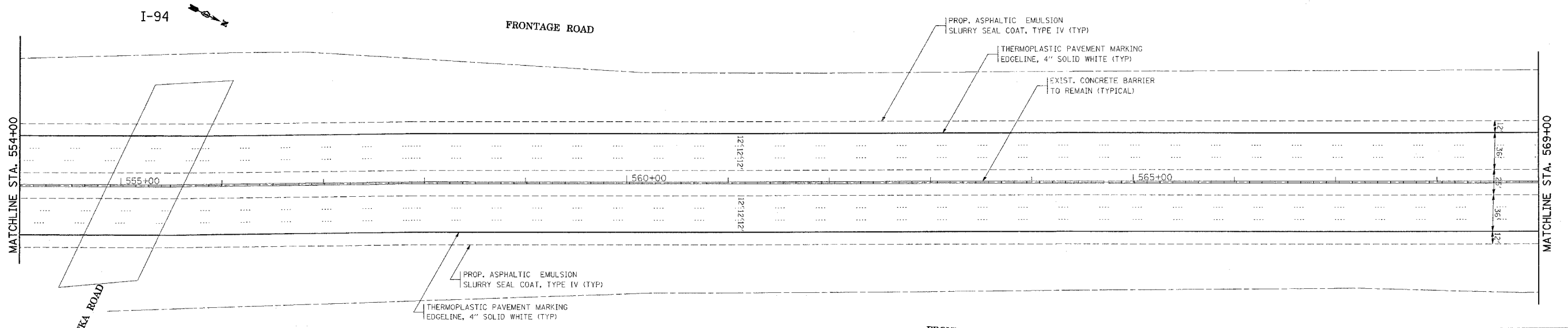
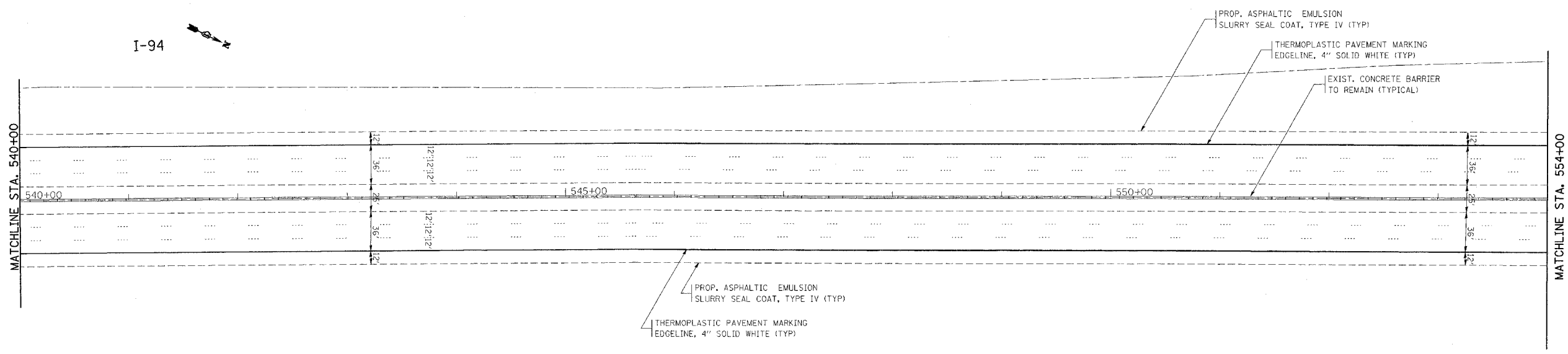

PLOT DATE = 6/6/2005
 FILE NAME = I:\116185\ah_design.dgn
 PLOT SCALE = 1/4"=10'
 USER NAME = golbomh

REVISIONS	
NAME	DATE

ILLINOIS DEPARTMENT OF TRANSPORTATION

ROADWAY PLAN
I-94
LAWRENCE AVE TO LAKE-COOK RD.

SCALE: VERT. 1"=50'
HORIZ. 1"=50'

DATE 6/8/2005

DRAWN BY _____
CHECKED BY _____

F.A.I. RTE. 94	SECTION 2005-0111	COUNTY COOK	TOTAL SHEETS 40	SHEET NO. 27
STA.		TO STA.		
FED. ROAD DIST. NO.	ILLINOIS	FED. AID PROJECT		

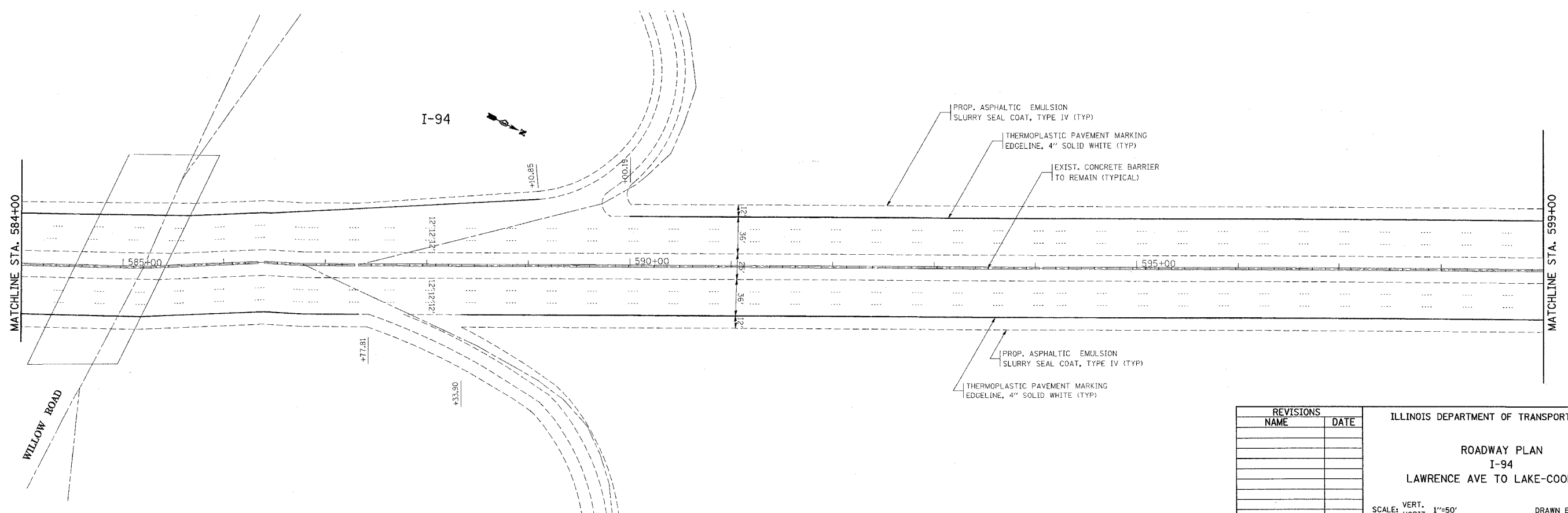
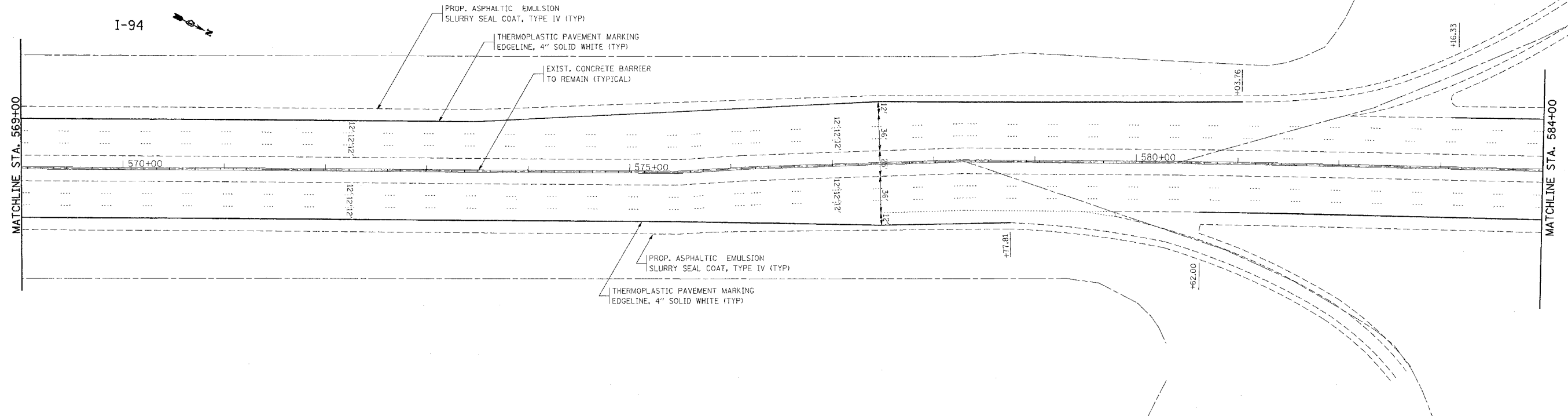

PLOT DATE = 6/8/2005
FILE NAME = c:\p\proj\11161919\sh_dsgn.dgn
PLOT SCALE = 1/8"=1'-0"
USER NAME = gskenneth

REVISIONS	
NAME	DATE

ILLINOIS DEPARTMENT OF TRANSPORTATION

ROADWAY PLAN
I-94
LAWRENCE AVE TO LAKE-COOK RD.

SCALE: VERT. 1"=50'
HORIZ. 1"=50'
DATE 6/8/2005

DRAWN BY
CHECKED BY

F.A.I. RTE.	SECTION	COUNTY	TOTAL SHEETS	SHEET NO.
94	2005-0111	COOK	40	28
STA.		TO STA.		
FED. ROAD DIST. NO.	ILLINOIS	FED. AID PROJECT		

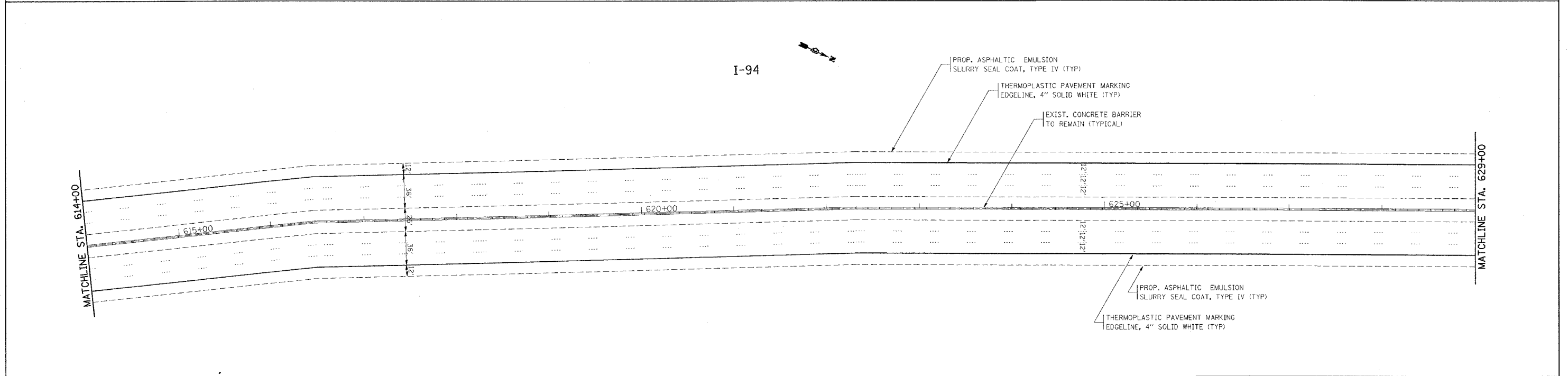
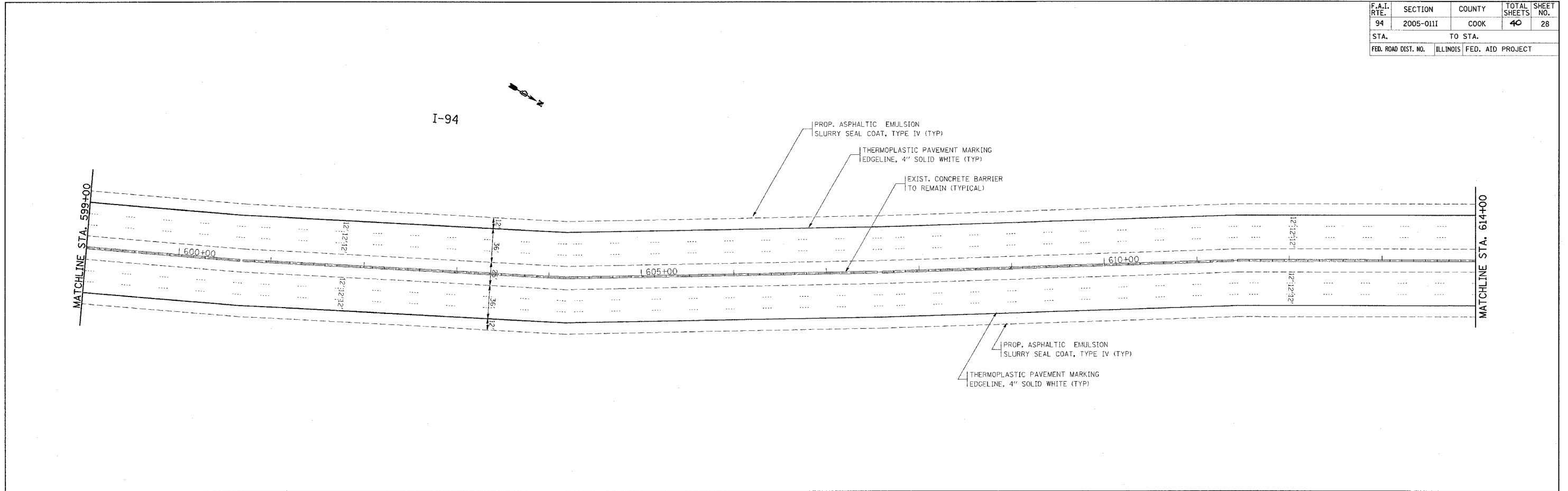

PLOT DATE = 6/8/2005
 FILE NAME = c:\pro\pca\111818\111818.dwg
 PLOT SCALE = 1/8"=1'-0"
 USER NAME = gbluana

REVISIONS	
NAME	DATE

ILLINOIS DEPARTMENT OF TRANSPORTATION

ROADWAY PLAN
 I-94
 LAWRENCE AVE TO LAKE-COOK RD.

SCALE: VERT. 1"=50'
 HORIZ. 1"=50'
 DATE 6/8/2005

DRAWN BY
 CHECKED BY

F.A.I. RTE.	SECTION	COUNTY	TOTAL SHEETS	SHEET NO.
94	2005-0111	COOK	40	29
STA.		TO STA.		
FED. ROAD DIST. NO.	ILLINOIS	FED. AID PROJECT		

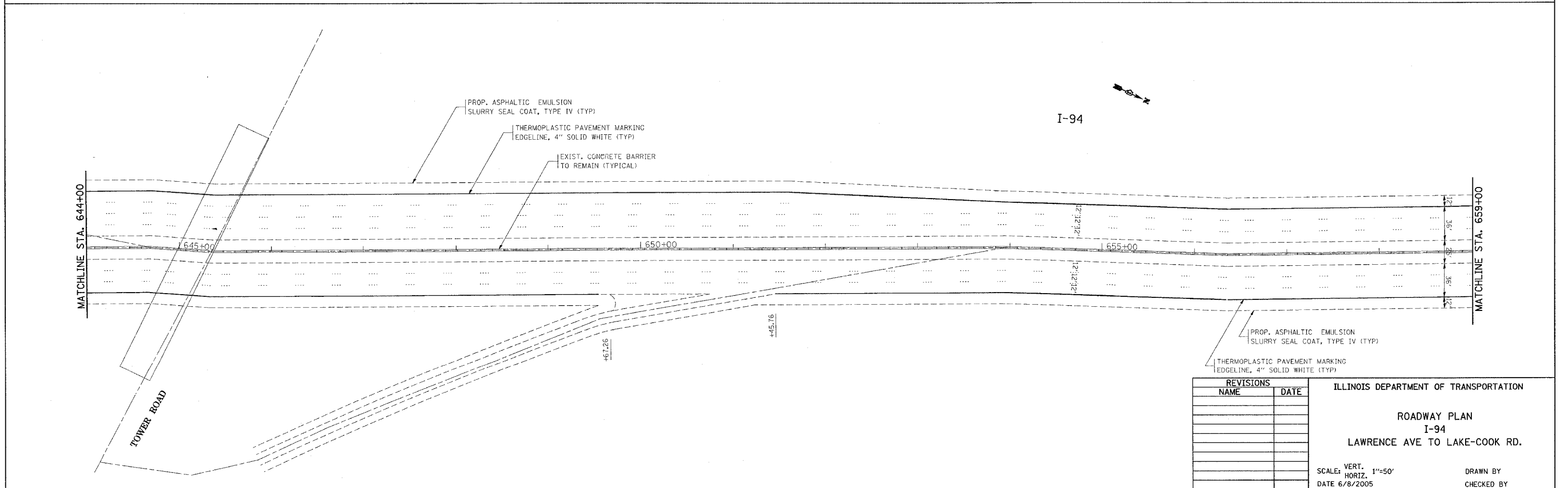
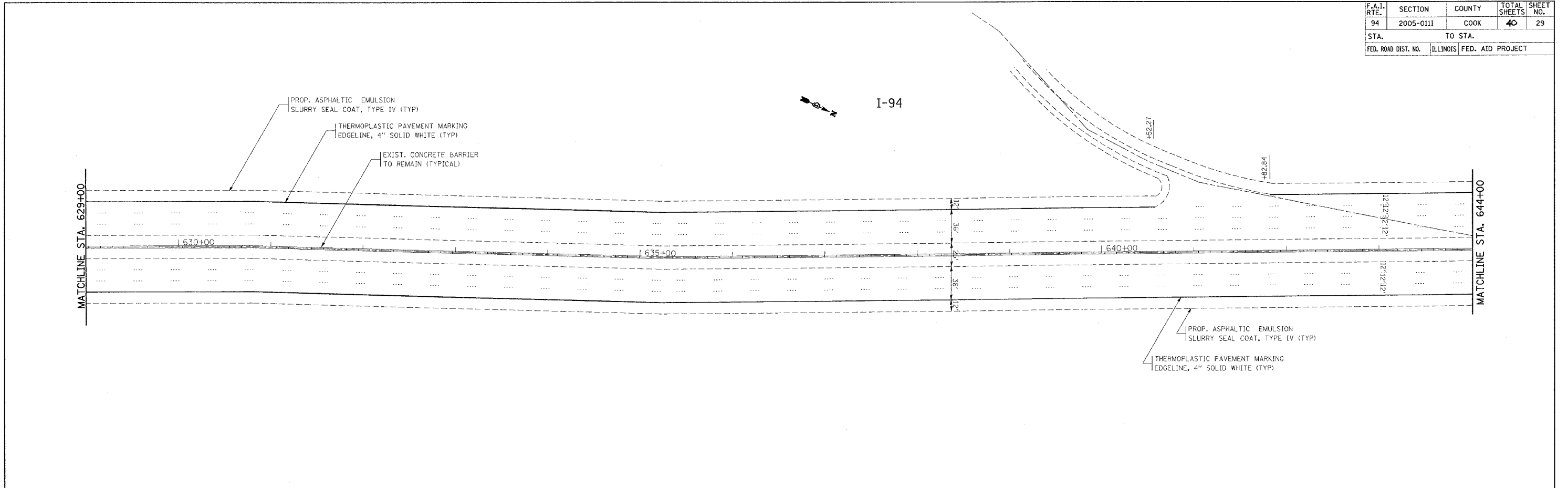

REVISIONS	
NAME	DATE

ILLINOIS DEPARTMENT OF TRANSPORTATION

ROADWAY PLAN
I-94
LAWRENCE AVE TO LAKE-COOK RD.

SCALE: VERT. 1"=50'
HORIZ. DATE 6/8/2005

DRAWN BY
CHECKED BY

PLOT DATE = 6/8/2005
FILE NAME = c:\pwork\2005\62929\62929.dwg
USER NAME = gsbomb

F.A.I. RTE.	SECTION	COUNTY	TOTAL SHEETS	SHEET NO.
94	2005-0111	COOK	40	30
STA.		TO STA.		
FED. ROAD DIST. NO.	ILLINOIS	FED. AID PROJECT		

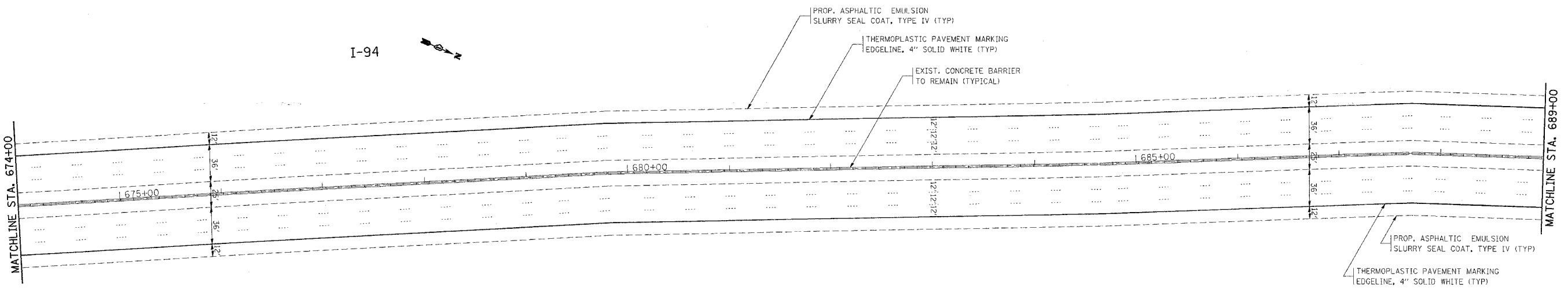
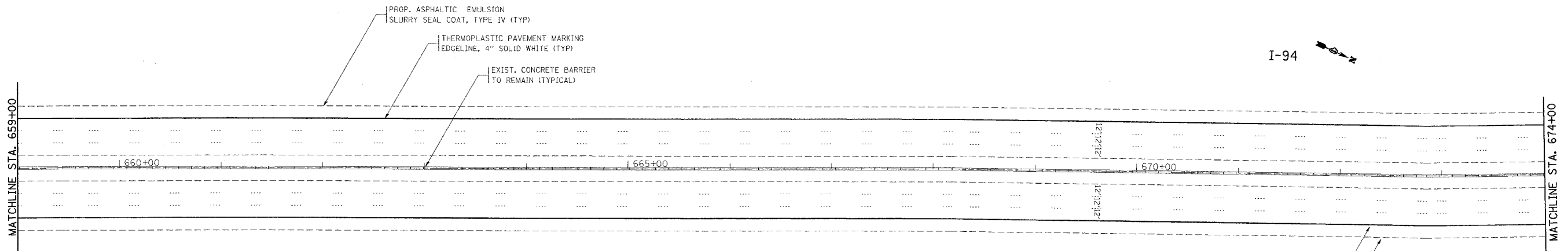

PLOT DATE = 6/8/2005
 PLOT SCALE = 50.0000' / IN.
 USER NAME = galbarrb

REVISIONS	
NAME	DATE

ILLINOIS DEPARTMENT OF TRANSPORTATION

ROADWAY PLAN
I-94
LAWRENCE AVE TO LAKE-COOK RD.

 SCALE: VERT. 1"=50'
 HORIZ. DATE 6/8/2005
 DRAWN BY
 CHECKED BY

F.A.I. RTE.	SECTION	COUNTY	TOTAL SHEETS	SHEET NO.
94	2005-0111	COOK	40	31
STA.		TO STA.		
FED. ROAD DIST. NO.		ILLINOIS	FED. AID PROJECT	

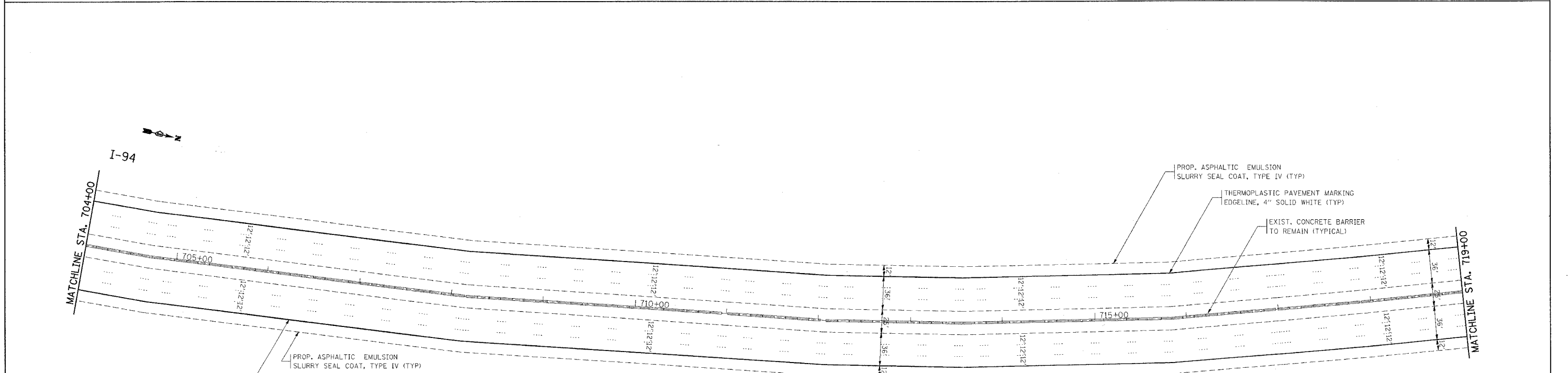
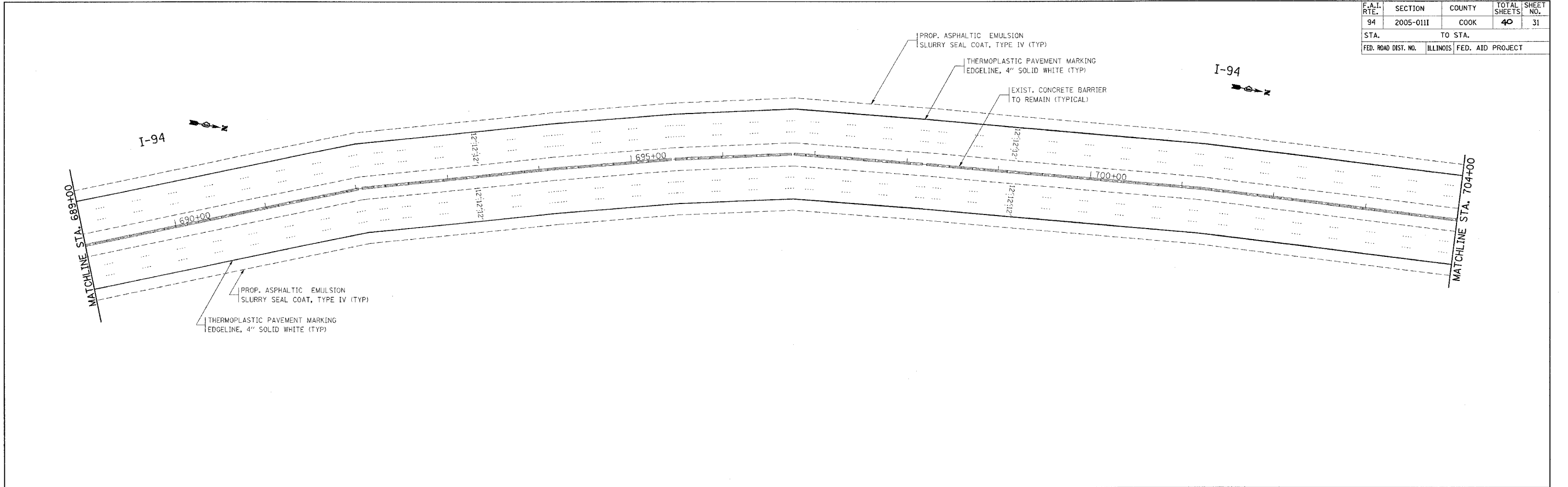

REVISIONS	
NAME	DATE

ILLINOIS DEPARTMENT OF TRANSPORTATION

ROADWAY PLAN
I-94
LAWRENCE AVE TO LAKE-COOK RD.

SCALE: VERT. 1"=50'
HORIZ. 1"=50'

DATE 6/8/2005

DRAWN BY
CHECKED BY

PLOT DATE = 6/8/2005
FILE NAME = c:\projects\62929\62929.dgn
USER NAME = gollanob

F.A.I. RTE.	SECTION	COUNTY	TOTAL SHEETS	SHEET NO.
94	2005-011	COOK	40	32
STA.		TO STA.		
FED. ROAD DIST. NO.	ILLINOIS	FED. AID PROJECT		

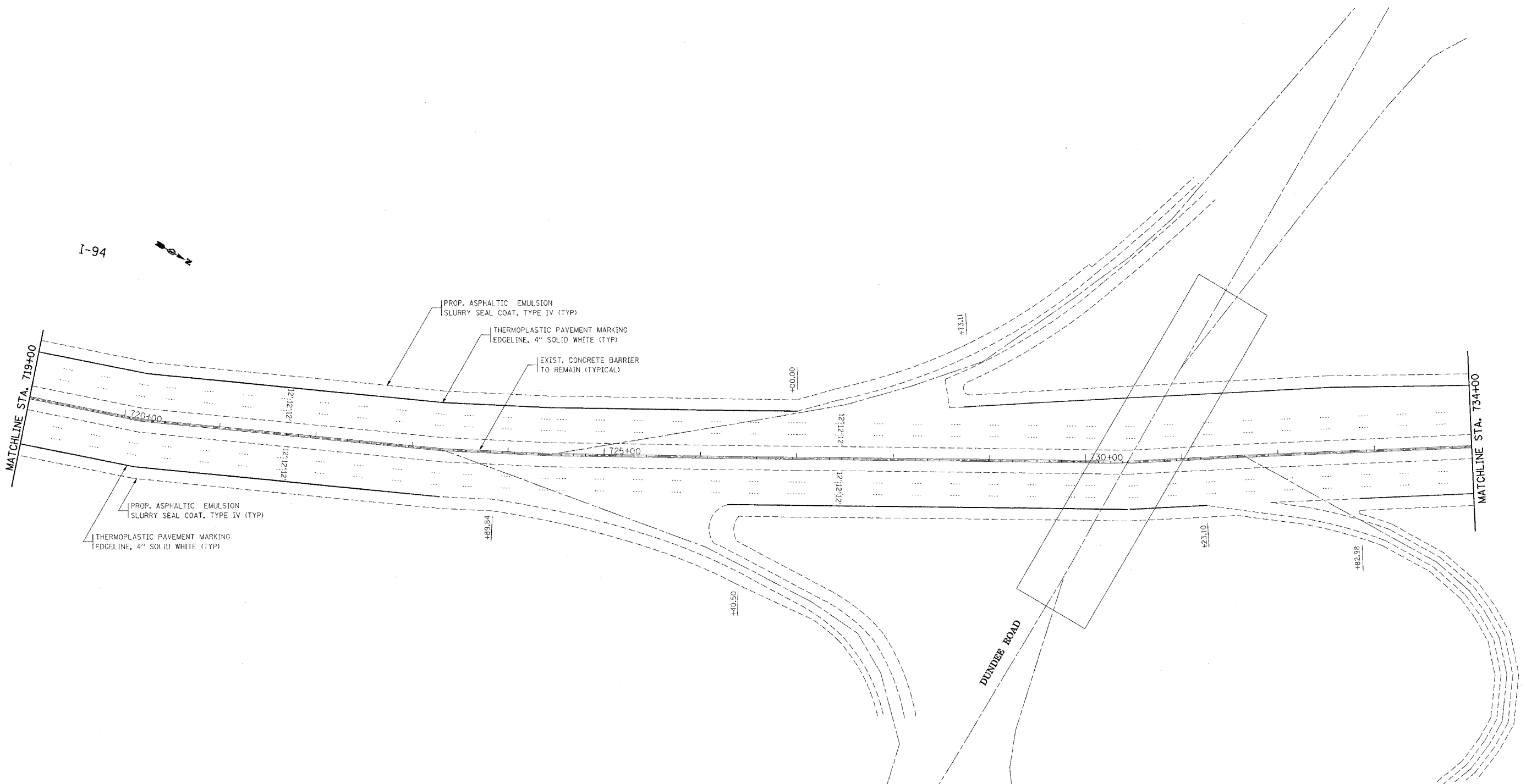

I-94

MATCHLINE STA. 719+00

MATCHLINE STA. 734+00

PROP. ASPHALTIC EMULSION
SLURRY SEAL COAT, TYPE IV (TYP)

THERMOPLASTIC PAVEMENT MARKING
EDGELINE, 4" SOLID WHITE (TYP)

EXIST. CONCRETE BARRIER
TO REMAIN (TYPICAL)

PROP. ASPHALTIC EMULSION
SLURRY SEAL COAT, TYPE IV (TYP)

THERMOPLASTIC PAVEMENT MARKING
EDGELINE, 4" SOLID WHITE (TYP)

DUNDER ROAD

REVISIONS	
NAME	DATE

ILLINOIS DEPARTMENT OF TRANSPORTATION

ROADWAY PLAN
I-94
LAWRENCE AVE TO LAKE-COOK RD.

SCALE: VERT. 1"=50'
HORIZ. DATE 6/8/2005

DRAWN BY
CHECKED BY

PLOT DATE = 6/8/2005
FILE NAME = c:\p\proj\62929\11818\11818.dgn
PLOT SCALE = 1/8"=1'-0"
USER NAME = galbarr

F.A.I. RTE.	SECTION	COUNTY	TOTAL SHEETS	SHEET NO.
94	2005-0111	COOK	40	33
STA.		TO STA.		
FED. ROAD DIST. NO.	ILLINOIS	FED. AID PROJECT		

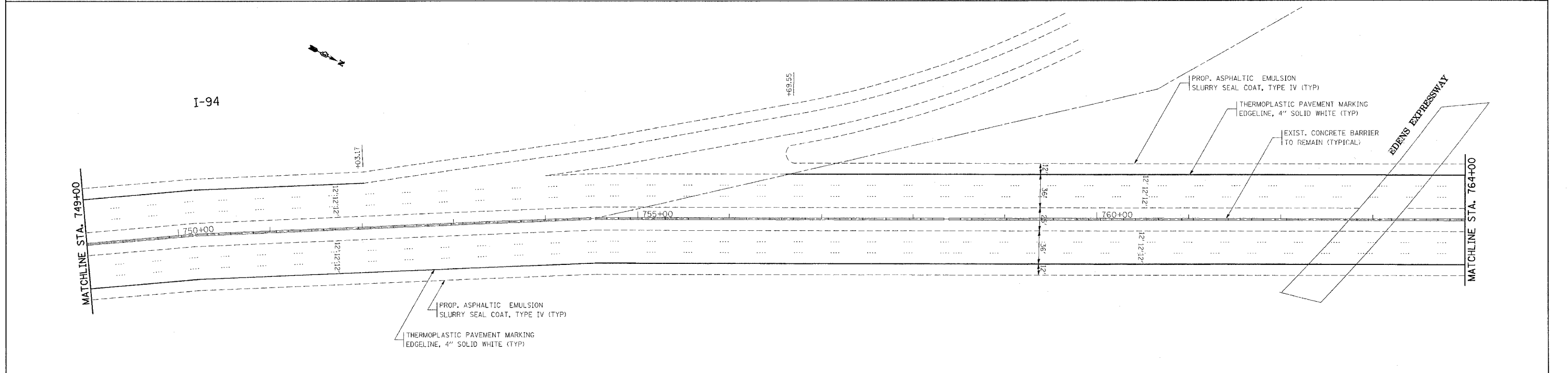
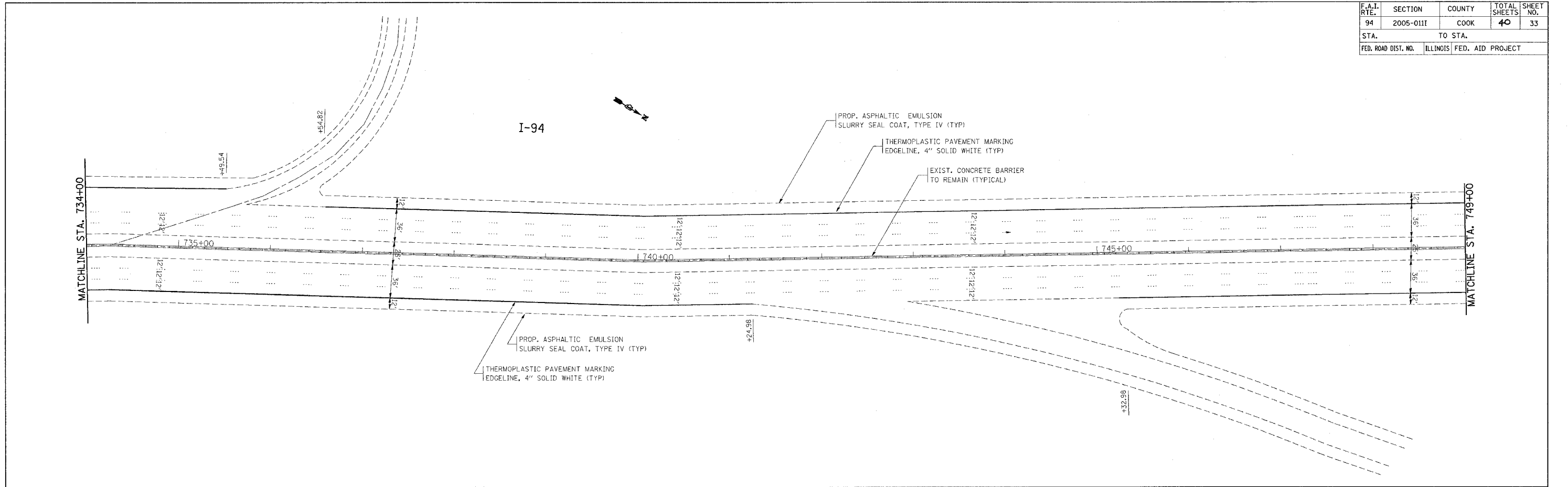

REVISIONS	
NAME	DATE

ILLINOIS DEPARTMENT OF TRANSPORTATION

ROADWAY PLAN

I-94

LAWRENCE AVE TO LAKE-COOK RD.

SCALE: VERT. 1"=50'
HORIZ. 1"=50'

DATE 6/8/2005

DRAWN BY _____
CHECKED BY _____

PLOT DATE = 6/8/2005
FILE NAME = c:\p\proj\2005\ill94\94_vh.dwg
PLOT SCALE = 1/8"=1'-0" / IN.
USER NAME = galsommo

F.A.T. RTE.	SECTION	COUNTY	TOTAL SHEETS	SHEET NO.
94	2005-0111	COOK	40	34
STA.		TO STA.		
FED. ROAD DIST. NO.		ILLINOIS	FED. AID PROJECT	

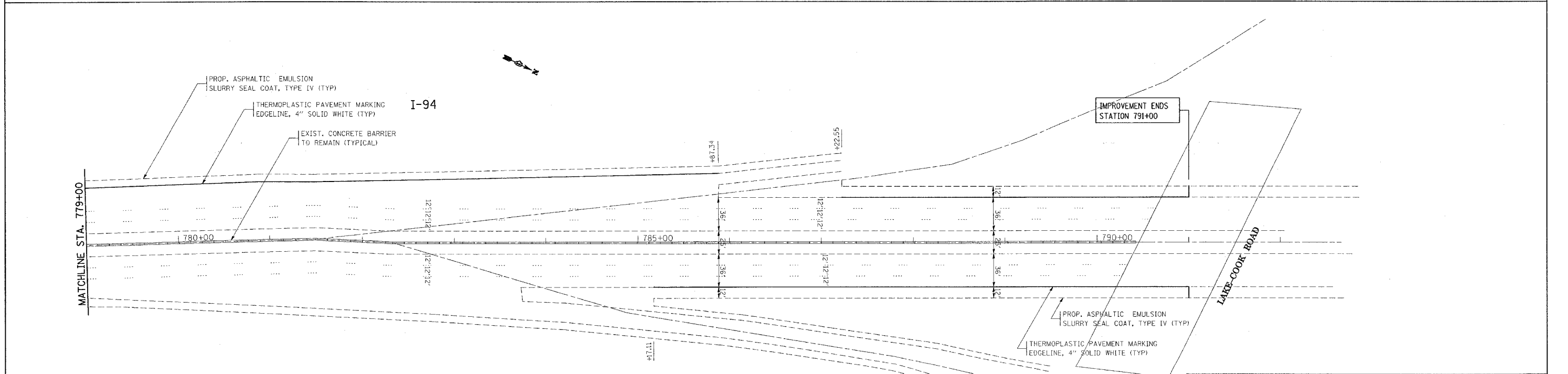
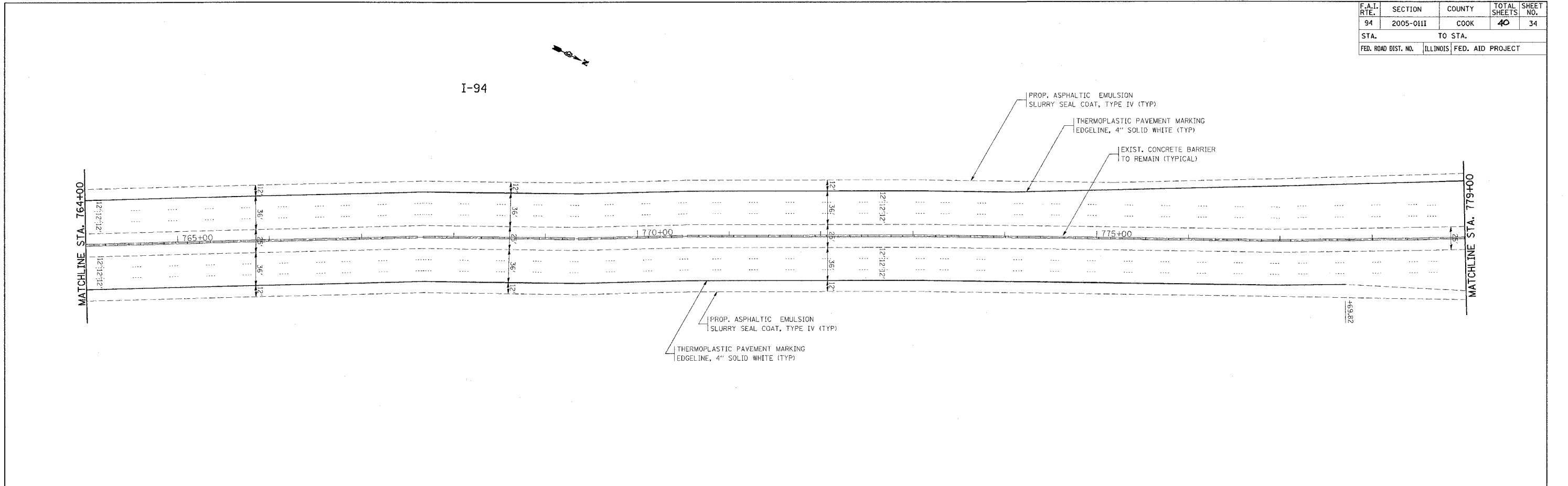

PLOT DATE = 6/8/2005
 FILE NAME = c:\p\proj\2005\118180\ah.dwg
 PLOT SCALE = 60.0000 / IN.
 USER NAME = gabbano

REVISIONS	
NAME	DATE

ILLINOIS DEPARTMENT OF TRANSPORTATION

ROADWAY PLAN
I-94
LAWRENCE AVE TO LAKE-COOK RD.

SCALE: VERT. 1"=50'
 HORIZ. DATE 6/8/2005

DRAWN BY
 CHECKED BY

F.A.I. RTE.	SECTION	COUNTY	TOTAL SHEETS	SHEET NO.
94	2005-011	COOK	40	35
STA.		TO STA.		
FED. ROAD DIST. NO. 1		ILLINOIS FED. AID PROJECT		

62929

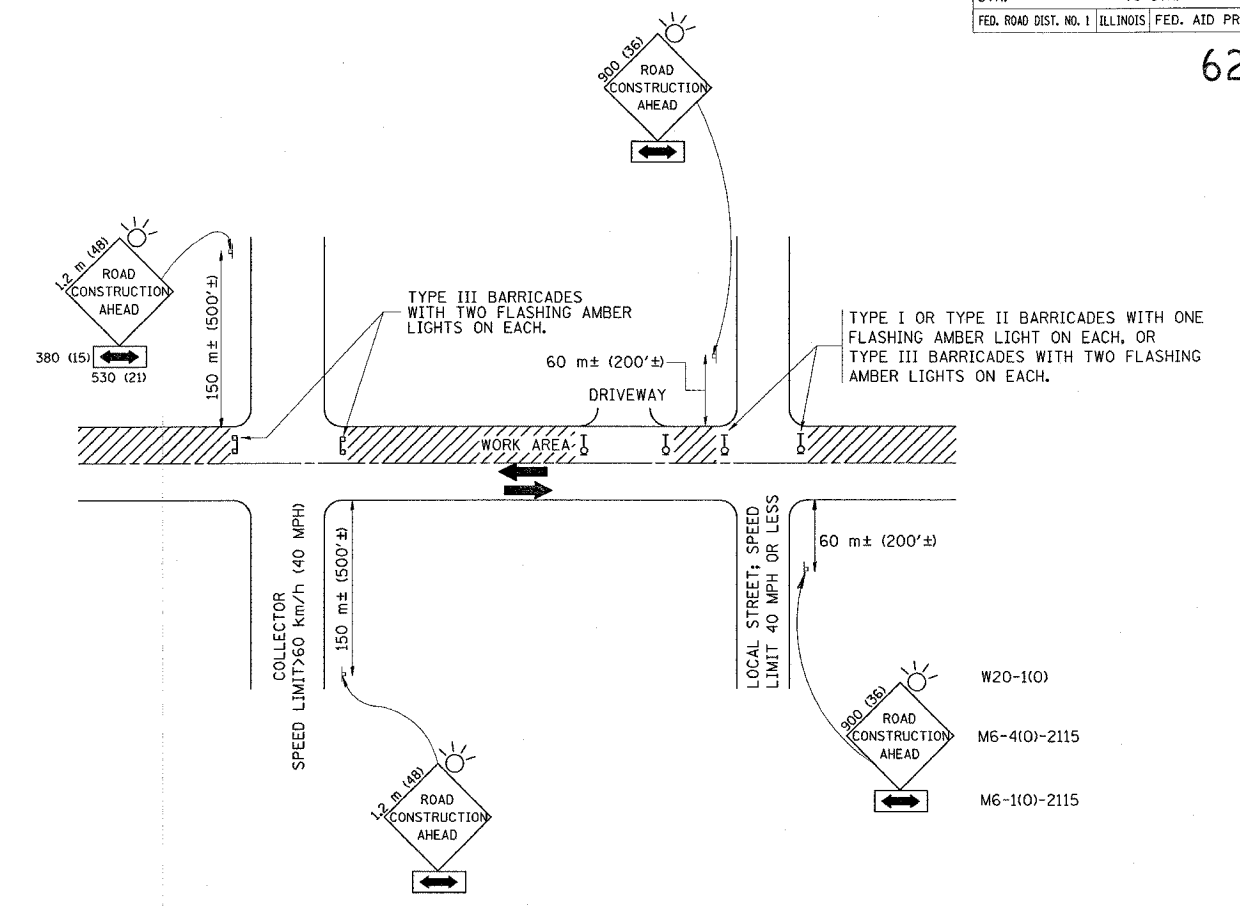

TRAFFIC CONTROL AND PROTECTION FOR SIDE ROADS, INTERSECTIONS, AND DRIVEWAYS

NOTES:

- A. FOR NO LANE RESTRICTION ON THE SIDE ROAD OR DRIVEWAYS**
- SIDE ROAD WITH A SPEED LIMIT OF 60 km/h (40 MPH) OR LESS AS SHOWN ON THE DRAWING AND AS DIRECTED BY THE ENGINEER:
 - ONE ROAD CONSTRUCTION AHEAD SIGN 900x900 (36x36) WITH A FLASHER AND FLAG MOUNTED ON IT APPROXIMATELY 60 m (200') IN ADVANCE OF THE MAIN ROUTE.
 - THE CLOSED PORTION OF THE MAIN ROUTE SHALL BE PROTECTED BY BLOCKING WITH TYPE I, TYPE II OR TYPE III BARRICADES, 1/3 OF THE CROSS SECTION OF THE CLOSED PORTION.
 - SIDE ROAD WITH A SPEED LIMIT GREATER THAN 60 km/h (40 MPH) AS SHOWN ON THE DRAWING AND AS DIRECTED BY THE ENGINEER:
 - ONE ROAD CONSTRUCTION AHEAD SIGN 1.2 m x 1.2 m (48x48) WITH A FLASHER MOUNTED ON IT APPROXIMATELY 150 m (500') IN ADVANCE OF THE MAIN ROUTE.
 - THE CLOSED PORTION OF THE MAIN ROUTE SHALL BE PROTECTED BY BLOCKING WITH TYPE III BARRICADES, 1/2 OF THE CROSS SECTION OF THE CLOSED PORTION.
 - WHEN THE SIDE ROAD LIES BETWEEN THE BEGINNING OF THE MAINLINE SIGNING AND THE WORK ZONE, A SINGLE HEADED ARROW (M6-1) SHALL BE USED IN LIEU OF THE DOUBLE HEADED ARROW (M6-4).
- B. FOR A LANE CLOSURE ON A SIDE ROAD OR DRIVEWAY:**
- USE APPLICABLE PORTIONS OF THE TYPICAL APPLICATION OF TRAFFIC CONTROL DEVICES (STD. 701501, STD. 701606 OR THE APPROPRIATE STANDARD). THE SPACING OF SIGNS AND BARRICADES SHALL BE ADJUSTED FOR FIELD CONDITIONS AS DIRECTED BY THE ENGINEER. THE DIRECTIONAL ARROW SHALL BE COVERED OR REMOVED WHEN NO LONGER CONSISTENT WITH THE SIDE ROAD LANE CLOSURE.
- C. ADVANCE WARNING SIGNS ARE TO BE OMITTED ON DRIVEWAY UNLESS OTHERWISE NOTED.**
- D. THE TRAFFIC CONTROL AND PROTECTION FOR SIDE ROADS, INTERSECTIONS, AND DRIVEWAYS SHALL BE INCIDENTAL TO THE COST OF SPECIFIED TRAFFIC CONTROL STANDARDS OR ITEMS.**

REVISIONS	
NAME	DATE
LHA	6/89
T. RAMMACHER	09/08/94
J. OBERLE	10/18/95
A. HOUSEH	03/06/96
A. HOUSEH	10/15/96
T. RAMMACHER	01/06/00

ILLINOIS DEPARTMENT OF TRANSPORTATION
 TRAFFIC CONTROL AND PROTECTION
 FOR
 SIDE ROADS, INTERSECTIONS, AND
 DRIVEWAYS

SCALE: VERT. _____
 HORIZ. _____
 DATE 5/31/2005

DRAWN BY _____
 CHECKED BY _____
 TC-10

REVISION DATE: 01/06/00

SECTION	COUNTY	TOTAL SHEETS	SHEET NO
94 2005-011 I	COOK	40	36
STA.	TO STA.		
FED. ROAD DIST. NO. 1	ALIGNMENT	FED. AID PROJECT	

62929

- THE DIAGONAL LINES SHALL BE SPACED AT 12M (40') C-C ACROSS ALL STRUCTURES WHICH ARE 150M (500') OR LESS IN LENGTH
- THE DIAGONAL LINES ARE NOT REQUIRED ON SHOULDERS WHICH ARE 1.8M (6') OR LESS IN WIDTH

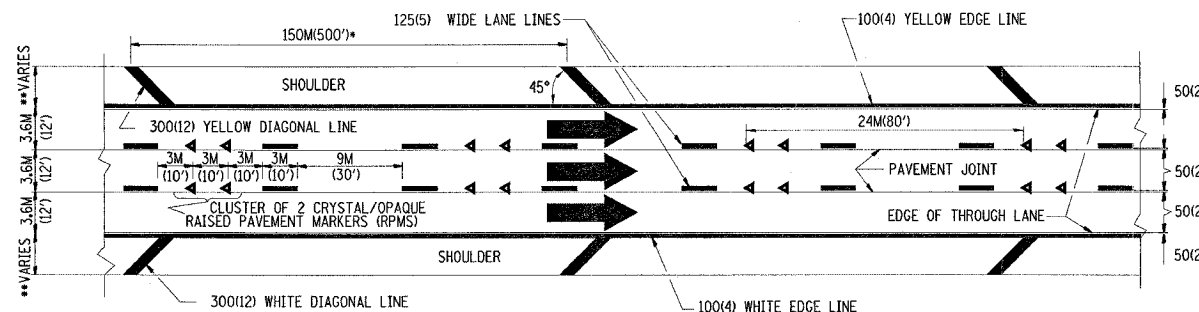

- NOTES:
1. THERMO PLASTIC PAVEMENT MARKING LINE SHALL BE USED FOR THE EDGE LINES, GORE LINES, AND DIAGONAL LINES ON BITUMINOUS PAVEMENT ONLY.
 2. PREFORMED PLASTIC PAVEMENT MARKING LINE SHALL BE USED FOR ALL LANE LINES
 3. PREFORMED PLASTIC PAVEMENT MARKING LINE SHALL BE USED ON PCC PAVEMENT.

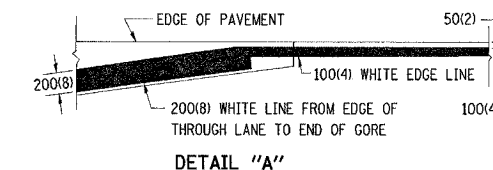

TYPICAL EDGE LINES & LANE LINES

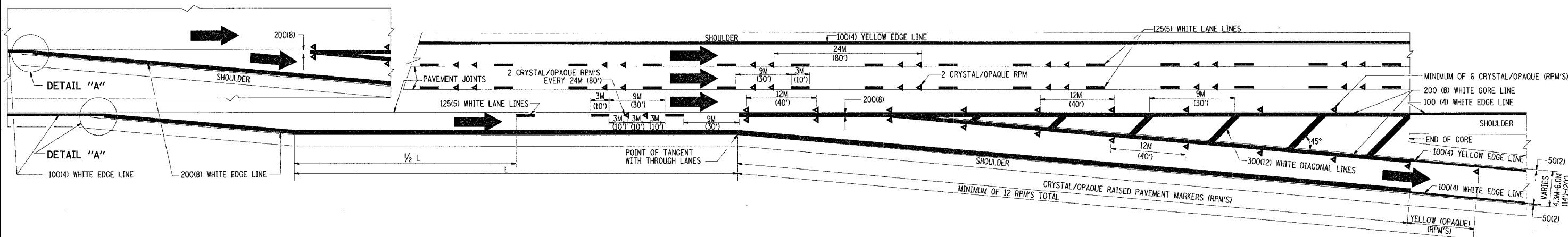

TYPICAL EXIT RAMP PAVEMENT MARKINGS

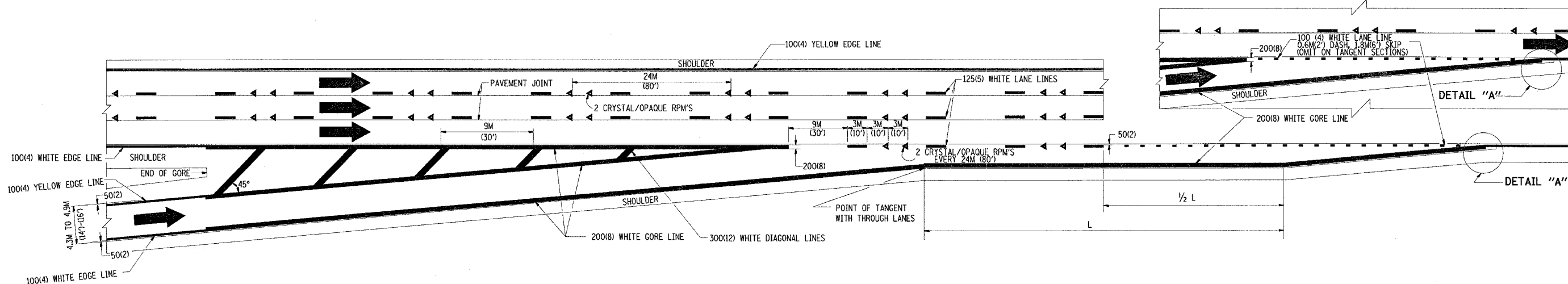

TYPICAL ENTRANCE RAMP PAVEMENT MARKINGS

REVISIONS	
NAME	DATE
DWS	1/90
DWS	5/91
AH	3/96
DWS	7/96

ILLINOIS DEPARTMENT OF TRANSPORTATION

MULTI-LANE FREEWAY PAVEMENT MARKING DETAILS

SCALE: NONE
DATE: 5/31/2005

DRAWN BY C.A.D.D.

CHECKED BY
TC12 SHEET 1 OF 2

REVISION DATE: 01/01/96

P.A.I. NO.	SECTION	COUNTY	TOTAL SHEETS	SHEET NO.
94	2005-011E	COOK	40	37
STA.	TO STA.			
FED. ROAD DIST. NO. 1	ILLINOIS	FED. AID PROJECT		

62929

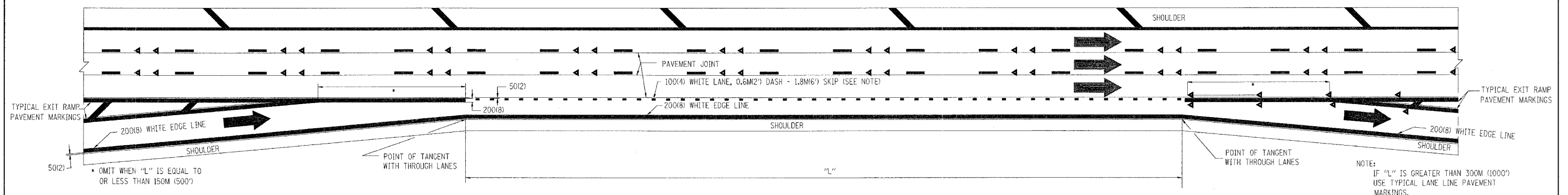

TYPICAL ENTRANCE/EXIT RAMP COMBINATION PAVEMENT MARKINGS

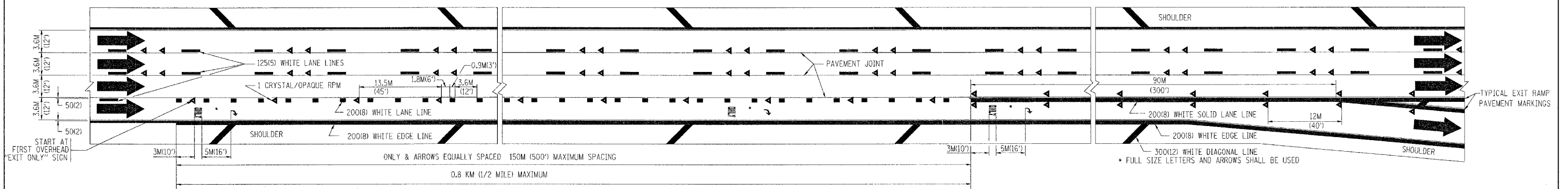

TYPICAL EXIT ONLY LANE PAVEMENT MARKINGS

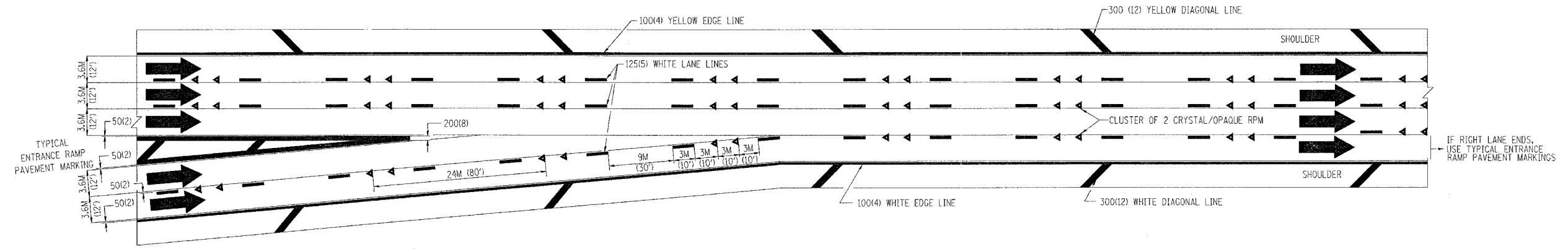

TYPICAL TWO LANE ENTRANCE RAMP PAVEMENT MARKINGS

REVISIONS	
NAME	DATE
DWS	1/90
DWS	5/91

ILLINOIS DEPARTMENT OF TRANSPORTATION

MULTI-LANE FREEWAY PAVEMENT MARKING DETAILS

SCALE: NONE
DATE: 5/31/2005

DRAWN BY C.A.D.D.
CHECKED BY
TC12 SHEET 2 OF 2
REVISION DATE: 01/01/96

5/31/2005
w:\d\stsd\td\2.dgn
VH-T012
galbann

1 1/2" = 100' 5/31/2005 09:24:40

P. A. I. SITE	SECTION	COUNTY	TOTAL SHEETS	SHEET NO.
04	2005-0111	COOK	40	38
STA.	TO STA.			
FED. ROAD DIST. NO.	BLINKS	FED. AID PROJECT		

62929

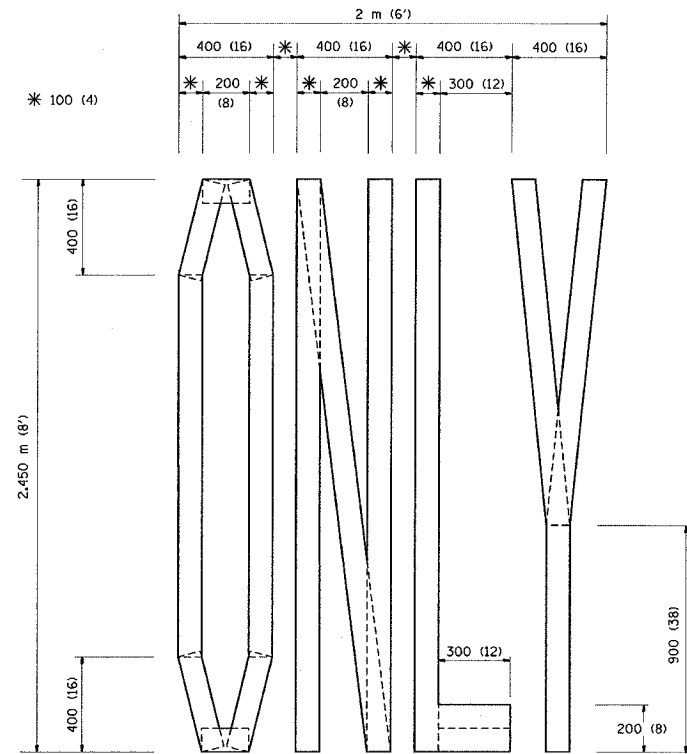

QUANTITY
100 (4) LINE = 19.7 m (64.1 ft.)
1.97 sq. m (21.1 sq. ft.)

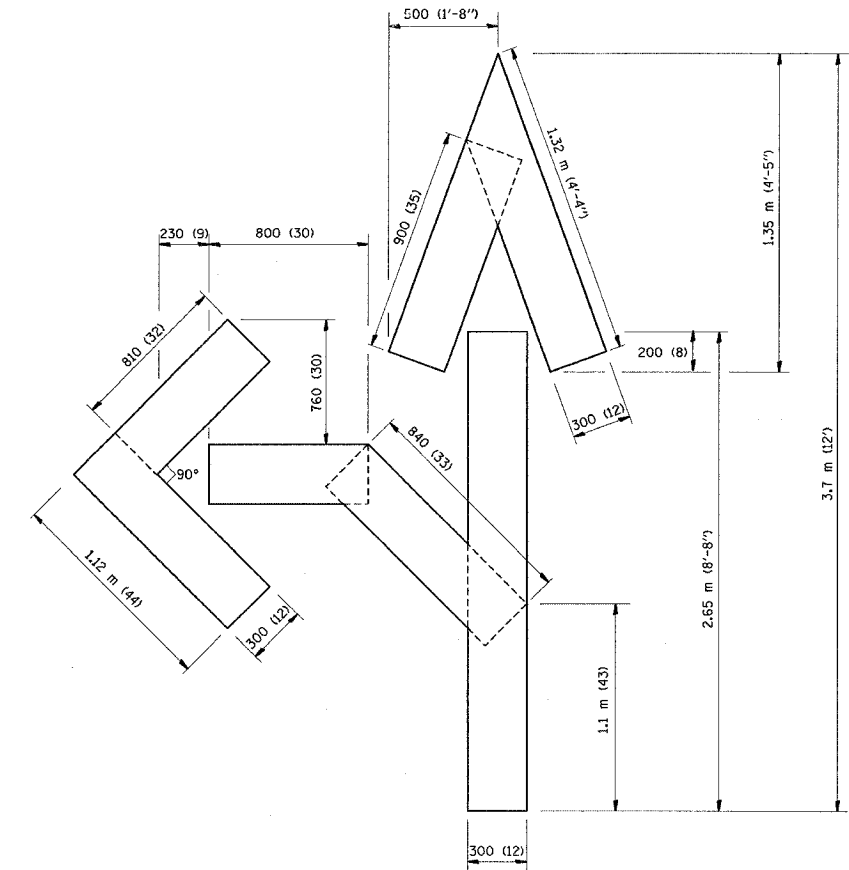

QUANTITY
100 (4) LINE = 25.3 m (82.5 ft.)
2.53 sq. m (27.5 sq. ft.)

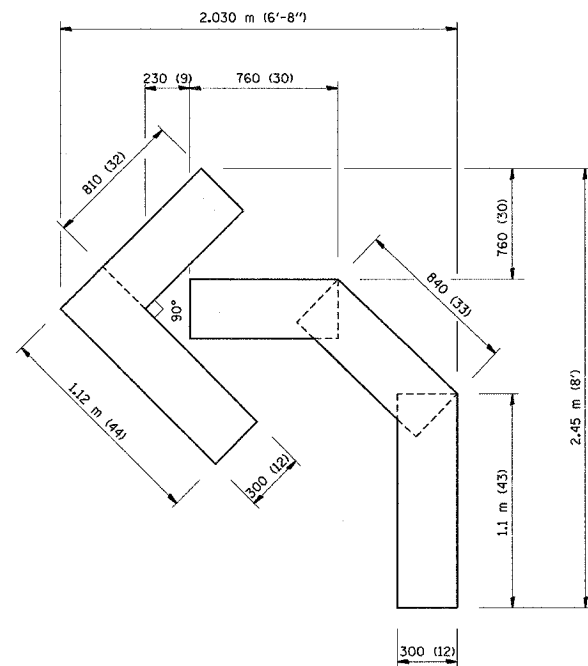

QUANTITY
100 (4) LINE = 13.9 m (45.5 ft.)
1.39 sq. m (15.2 sq. ft.)

All dimensions are in millimeters (inches) unless otherwise shown.

ILLINOIS DEPARTMENT OF TRANSPORTATION

PAVEMENT MARKING
LETTERS AND SYMBOLS
FOR TRAFFIC STAGING

REVISIONS	
NAME	DATE
T. RAMMACHER	09/18/94
J. OBERLE	06/01/96
T. RAMMACHER	06/05/96
T. RAMMACHER	11/04/97
T. RAMMACHER	03/02/98
E. GOMEZ	08/28/00

SCALE: NONE
DATE 6/4/2005

DRAWN BY CADD
CHECKED BY
TC-16

REVISION DATE: 08/28/00

F.A. RTE.	SECTION	COUNTY	TOTAL SHEETS	SHEET NO.
94	200B-D11	COOK	40	39
STA.	TO STA.			
FED. ROAD DIST. NO.	ILLINOIS	FED. AID PROJECT		

PARTIAL RAMP CLOSURE DETAILS

SHOULDER CLOSURE DETAILS

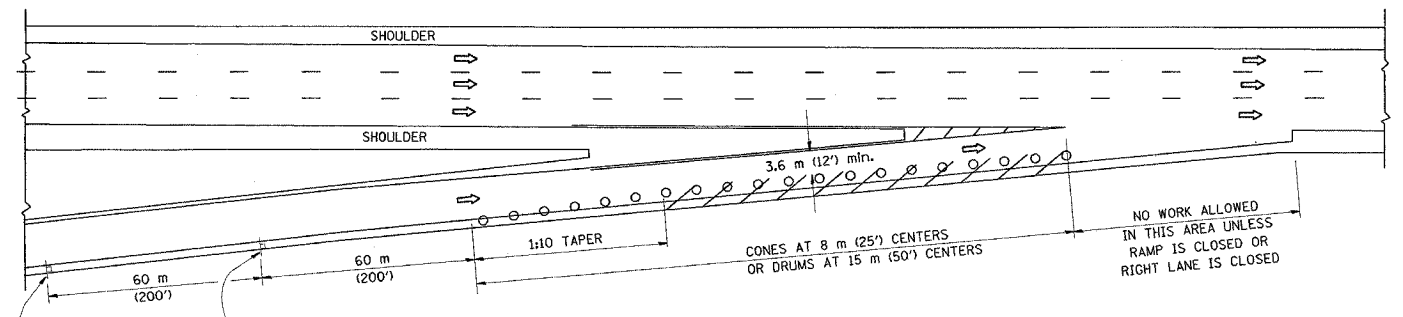

TYPICAL ENTRANCE RAMP

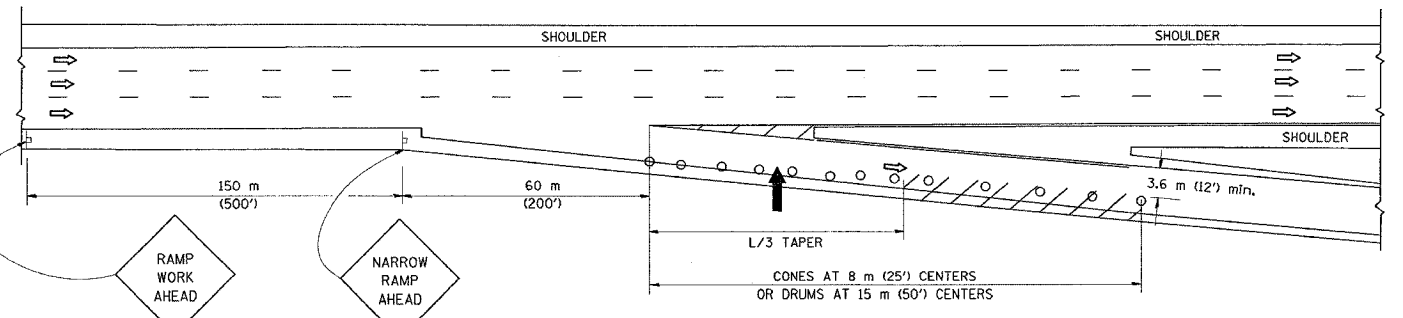

TYPICAL EXIT RAMP

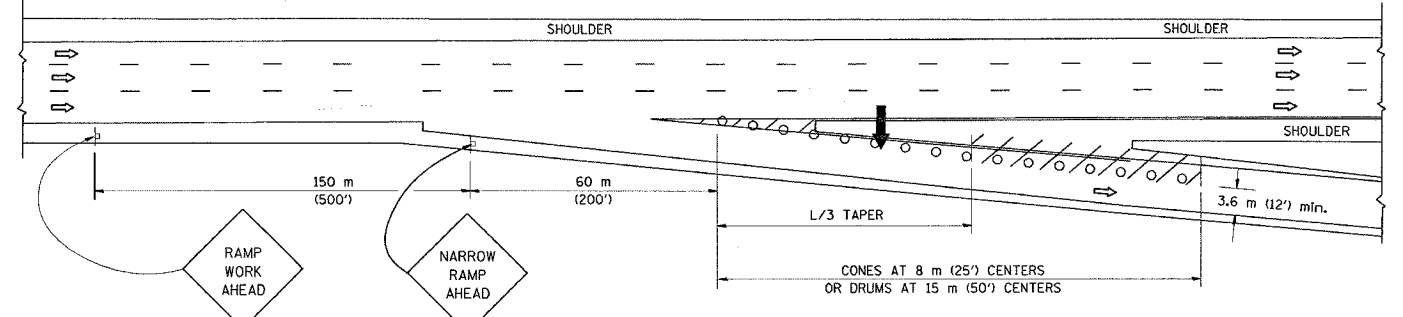

TYPICAL EXIT RAMP

SYMBOLS

- ARROWBOARD
- WORK AREA
- SIGN ON PORTABLE OR PERMANENT SUPPORT
- FLAGGER WITH CONTROL SIGN
- DRUM WITH MONO-DIRECTIONAL STEADY BURNING LIGHT
- CONES - 700 (28) IN HEIGHT

GENERAL NOTES

- THE "L" DISTANCE EQUALS:

SPEED LIMIT	METRIC	ENGLISH
80 km/h (45 mph) OR GREATER:	$L=0.65(WXS)$	$L=(WXS)$

W = WIDTH OF OFFSET IN METERS (FEET)
 S = NORMAL POSTED SPEED KM/H (MPH)
- PLASTIC DRUMS WITH HIGH PERFORMANCE REFLECTIVE SHEETING AND STEADY BURNING LIGHTS ARE REQUIRED FOR ALL NIGHTTIME CLOSURES.
- ALL SIGNS SHALL BE POST MOUNTED IF THE CLOSURE TIME EXCEEDS FOUR DAYS.
- FLASHING LIGHTS SHALL BE USED DURING THE HOURS OF DARKNESS AND SHALL BE INSTALLED ABOVE THE FIRST TWO SETS OF SIGNS.

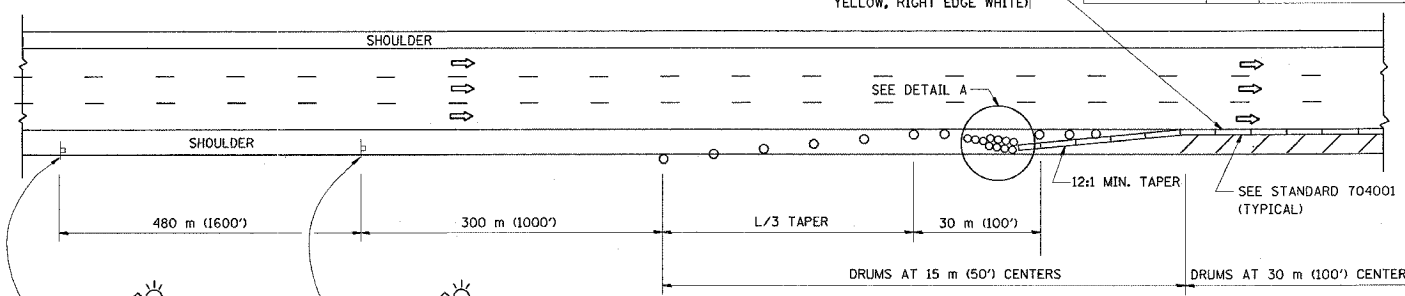

PERMANENT SHOULDER CLOSURE

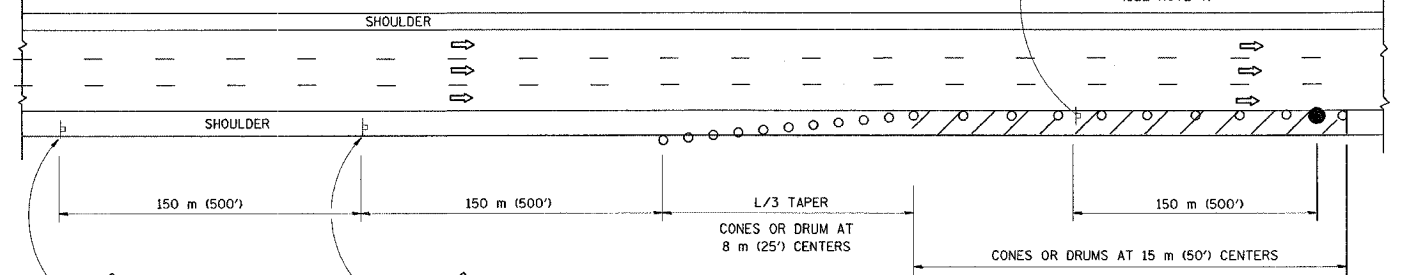

DAYTIME SHOULDER CLOSURE

ARRAY DESIGN PER MANUFACTURER TO BE NCHRP 350 COMPLIANT FOR POSTED SPEED.

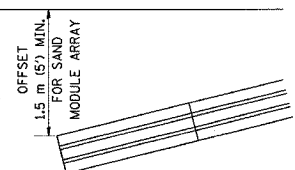

DETAIL "A" IMPACT ATTENUATOR, TEMPORARY (SEE NOTE 5)

ALL DIMENSIONS ARE IN MILLIMETERS (INCHES) UNLESS OTHERWISE SHOWN.

ILLINOIS DEPARTMENT OF TRANSPORTATION

TRAFFIC CONTROL DETAILS FOR FREEWAY SHOULDER CLOSURES PARTIAL RAMP CLOSURES

REVISIONS	
NAME	DATE
DWS	11/96
JAF	12/02
NCHRP 350	04/03

SCALE: NONE
 DATE: 5/31/2005
 DRAWN BY: DWS
 DESIGNED BY: DWS
 CHECKED BY: TC-17

F.A.I. RTE.	SECTION	COUNTY	TOTAL SHEETS	SHEET NO.
94	2005-0111	COOK	40	40
STA. _____		TO STA. _____		
FED. ROAD DIST. NO. _____		ILLINOIS FED. AID PROJECT		

#62929

SIGNING FOR FLAGGING OPERATIONS AT WORK ZONE OPENINGS

WORK ZONE EXIT OPENING

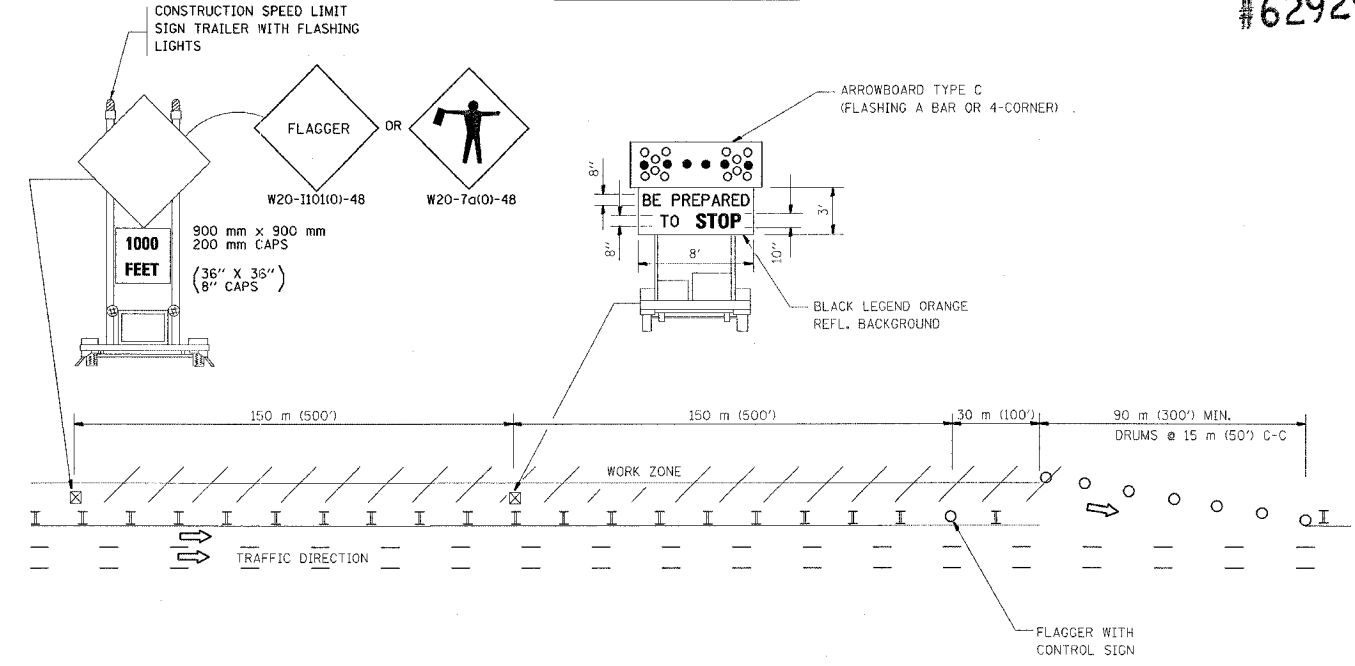

WORK ZONE ENTRY OPENING

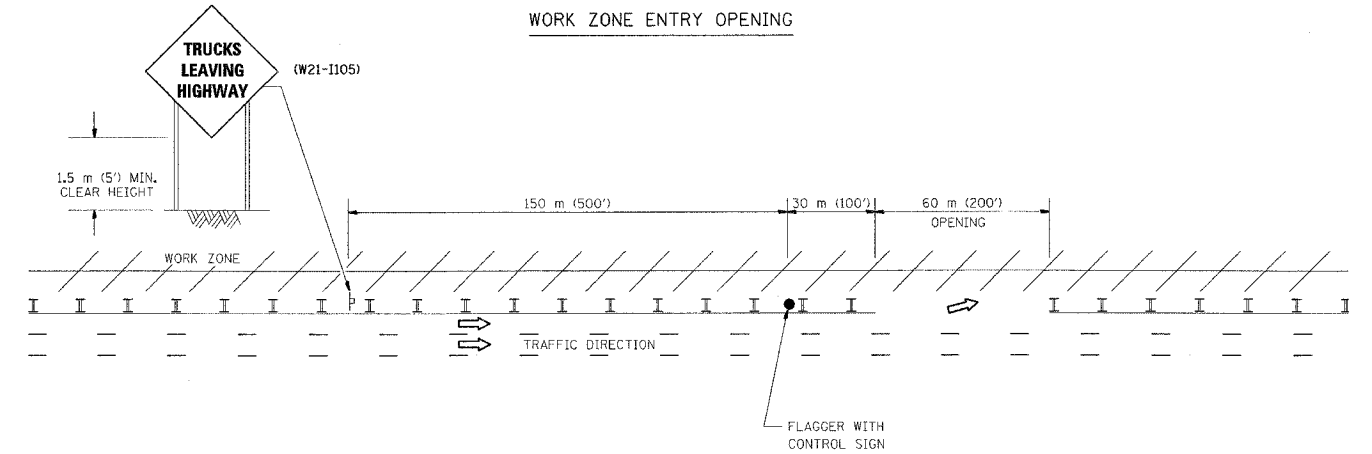

NOTES:

1. The Arrowboard, the Flagger Ahead trailer mounted sign, and the Trucks Leaving Highway sign shall be removed or turned away from traffic and the exit and entry openings shall be closed when the flagging operation ceases.
2. Work Zone Exit Openings should be a minimum of one half mile apart.
3. Exiting the work zone at any place other than at a Work Zone Exit Opening will be prohibited.
4. All vehicles shall enter the work zone at entry openings, using their turn signals to warn motorists

ALL DIMENSIONS ARE IN MILLIMETERS (INCHES) UNLESS OTHERWISE SHOWN

ILLINOIS DEPARTMENT OF TRANSPORTATION

SIGNING FOR FLAGGING OPERATIONS AT WORK ZONE OPENINGS

REVISIONS	
NAME	DATE
DWS	8/98
JAF	4/03

SCALE: NONE
DATE 5/31/2005
DRAWN BY CADD
CHECKED BY TC-18

REVISION DATE: 04/24/03