

FAU RTE.	SECTION	COUNTY	TOTAL SHEETS	SHEET NO.
1346	#	COOK/DUPAGE	84	57
*ELK GROVE VILLAGE SECTION 99-00041-00-CH				
MAST ARM MOUNTED STREET NAME SIGNS-DEVON & TONNE				

CONTRACT NO. 83766

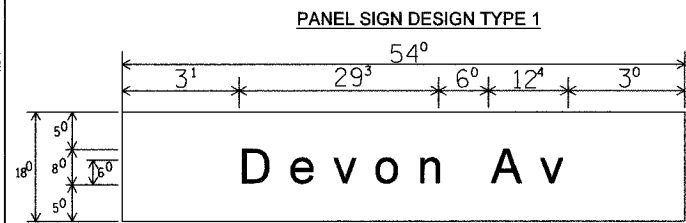

— Sq. M Each
6.75 Sq. Ft. Each
2 Required
Design Series_D

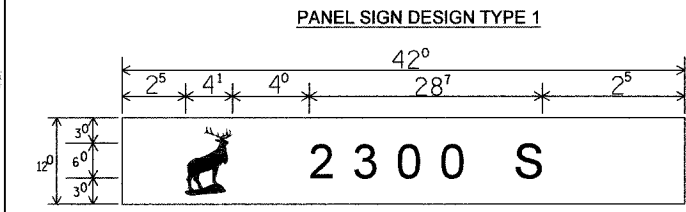

— Sq. M Each
3.5 Sq. Ft. Each
2 Required
Design Series_D

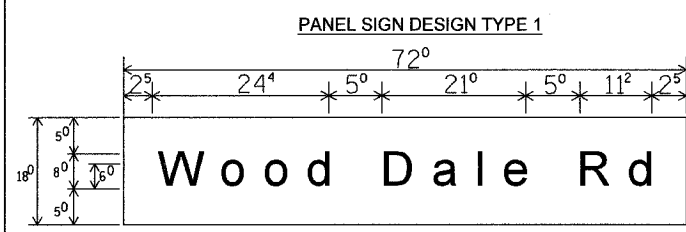

— Sq. M Each
9 Sq. Ft. Each
2 Required
Design Series_D

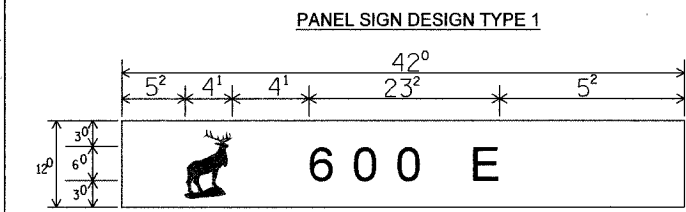

— Sq. M Each
3.5 Sq. Ft. Each
2 Required
Design Series_D

NOTE: SIGN DIMENSIONS ARE IN ENGLISH UNITS.

GENERAL NOTES

- WHERE MAST ARM MOUNTED STREET NAME SIGNS ARE SPECIFIED, THE MAST ARM ASSEMBLY AND POLES SHALL BE DESIGNED TO SUPPORT THE LOADINGS CALLED FOR ON STANDARDS 834001, 834006 AND 834011, AS APPLICABLE, PLUS TWO (2) SIGN PANELS 2'-6" X 6'-0" MOUNTED AS SHOWN. THE DESIGN SHALL BE IN ACCORDANCE WITH THE REQUIREMENTS OF THE CURRENT "STANDARD SPECIFICATIONS FOR STRUCTURAL SUPPORTS FOR HIGHWAY SIGNS, LUMINAIRES AND TRAFFIC SIGNALS" AS PUBLISHED BY THE AMERICAN ASSOCIATION OF STATE HIGHWAY AND TRANSPORTATION OFFICIALS FOR 80 M.P.H. WIND VELOCITY.
- ALL SIGNS SHALL HAVE A WHITE REFLECTORIZED LEGEND AND BORDER ON A GREEN REFLECTORIZED BACKGROUND, TYPE A SHEETING.
- THE SIGN LENGTH SHOULD BE INCREASED IN 6-INCH INCREMENTS, BUT THE OVERALL LENGTH SHOULD NOT EXCEED 6'-0".
- ALL BORDERS SHALL BE 3/4" WIDE AND CORNER RADIUS SHALL BE 2-1/4".
- SIGNFIX ALUMINUM CHANNEL FRAMING SYSTEM SHALL BE USED FOR ALL SIGNS ATTACHED TO SIGNAL POLES AND POSTS. LOCAL SUPPLIERS OF THE SIGNFIX ALUMINUM CHANNEL FRAMING SYSTEM ARE:

- A.K.T. CORPORATION
- SCHAUMBURG, IL
- TUCKER COMPANY, INC.
- WAUWATOSA, WI
- AMERICAN FABRICATION CO.
- CHICAGO HEIGHTS, IL
- WESTERN TRAFFIC CONTROL, INC.
- CICERO, IL

- PARTS LISTING:
- SIGN CHANNEL PART #HPN053 (MED. CHANNEL)
 - SIGN SCREWS 1/4" x 14 x 1" H.W.H #3
 - BRACKETS PART #HPN034 (UNIVERSAL)
 - CHANNEL CLAMPS WITH STAINLESS STEEL STRAPPING

OTHER BRANDS OF MOUNTING HARDWARE ARE ACCEPTABLE, BASED UPON THE DEPARTMENT'S APPROVAL AND COMPATIBILITY WITH THE CHANNEL/BACKET OF THE ABOVE PRODUCT.

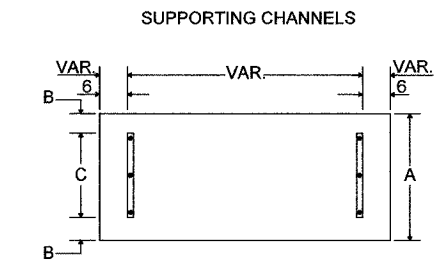

A	B	C
18"	2"	14"

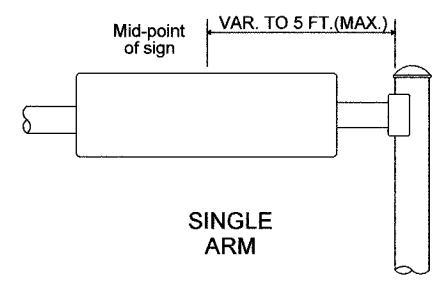

SIGNFIX ALUMINUM CHANNEL FRAMING SYSTEM shall be used. See Note #5.

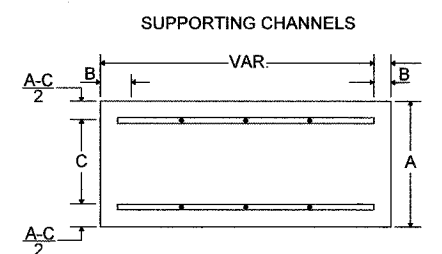

A	B	C
18"	2"	12"
30"	2"	22"

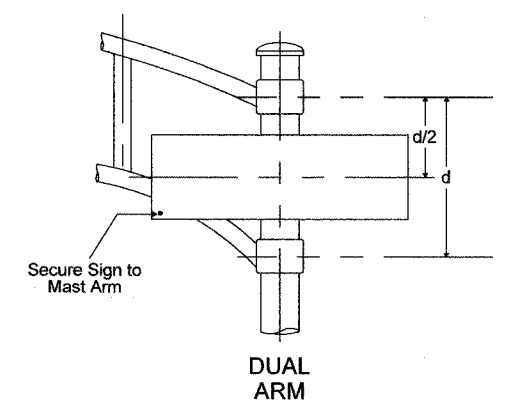

NOTE: THE SIGN PANEL SHALL BE HIGH INTENSITY

UPPER TO LOWER CASE SPACING CHART 8-6 INCH SERIES "C" & "D"

EXAMPLE, 2³ DENOTES 3/8"

SERIES	SECOND LETTER															
	a c c d e		b h i k		f w		j		s t		v y		x		z	
	g	o	q	l	m	n	p	r	u							
A W X	1 ²	1 ⁴	1 ⁴	1 ⁵	1 ²	1 ⁴	0 ⁶	1 ⁰	1 ¹	1 ⁴	0 ⁶	1 ⁰	1 ¹	1 ²	1 ²	1 ⁴
B	1 ⁴	1 ⁵	2 ⁰	2 ¹	1 ⁴	1 ⁵	1 ¹	1 ²	1 ⁴	1 ⁵	1 ²	1 ⁴	1 ²	1 ⁴	1 ⁶	1 ⁷
C E G	1 ⁴	1 ⁵	2 ⁰	2 ¹	1 ²	1 ⁴	0 ⁶	1 ⁰	1 ²	1 ⁴	1 ²	1 ⁴	1 ⁴	1 ⁵	1 ⁴	1 ⁵
D O Q R	1 ⁴	1 ⁵	2 ⁰	2 ¹	1 ⁴	1 ⁵	0 ⁶	1 ⁰	1 ²	1 ⁴	1 ²	1 ⁴	1 ⁴	1 ⁵	1 ⁴	1 ⁵
F	0 ⁵	0 ⁶	1 ⁴	1 ⁵	0 ⁶	1 ⁰	0 ⁵	0 ⁶	0 ⁶	1 ⁰	0 ⁶	1 ⁰	0 ⁶	1 ⁰	1 ¹	1 ²
H I M N	2 ⁰	2 ¹	2 ²	2 ⁴	2 ⁰	2 ¹	1 ⁴	1 ⁵	1 ⁶	1 ⁷	1 ⁶	1 ⁷	2 ⁰	2 ¹	2 ⁰	2 ¹
J U	2 ⁰	2 ¹	2 ⁰	2 ¹	1 ⁶	1 ⁷	1 ⁴	1 ⁵	1 ⁶	1 ⁷	1 ⁶	1 ⁷	1 ⁶	1 ⁷	2 ⁰	2 ¹
K L	1 ¹	1 ²	1 ⁶	1 ⁷	1 ¹	1 ²	0 ⁵	0 ⁶	1 ¹	1 ²	1 ¹	1 ²	1 ¹	1 ²	1 ²	1 ⁴
P	1 ²	1 ⁴	1 ⁴	1 ⁵	1 ²	1 ⁴	0 ⁵	0 ⁶	1 ¹	1 ²	1 ¹	1 ²	1 ²	1 ⁴	1 ²	1 ⁴
S	1 ²	1 ⁴	1 ⁶	1 ⁷	1 ²	1 ⁴	0 ⁶	1 ⁰	1 ²	1 ⁴	1 ²	1 ⁴	1 ²	1 ⁴	1 ²	1 ⁴
T	1 ¹	1 ²	1 ⁶	1 ⁷	0 ⁶	1 ⁰	0 ⁶	1 ⁰	1 ¹	1 ²	1 ¹	1 ²	1 ¹	1 ²	1 ²	1 ⁴
V	0 ⁶	1 ⁰	1 ⁴	1 ⁵	1 ¹	1 ²	0 ⁶	1 ⁰	1 ²	1 ⁴	1 ²	1 ⁴	1 ²	1 ⁴	1 ²	1 ⁴
Y	0 ⁵	0 ⁶	1 ⁴	1 ⁵	0 ⁶	1 ⁰	0 ⁵	0 ⁶	0 ⁵	0 ⁷	0 ⁵	0 ⁶	0 ⁶	1 ⁰	1 ¹	1 ²
Z	1 ⁶	1 ⁷	2 ²	2 ⁴	1 ⁶	1 ⁷	1 ²	1 ⁴	1 ⁶	1 ⁷	1 ⁶	1 ⁷	1 ⁶	1 ⁷	2 ⁰	2 ¹

LOWER CASE TO LOWER CASE SPACING CHART 6 INCH SERIES "C" & "D"

SERIES	SECOND LETTER															
	a c c d e		b h i k		f w		j		s t		v y		x		z	
	g	o	q	l	m	n	p	r	u							
F																
I																
R																
S																
T																
L																
E																
T																
E																
R																

NUMBER TO NUMBER SPACING CHART 8 INCH SERIES "C" & "D"

SERIES	SECOND NUMBER																			
	0		1		2		3		4		5		6		7		8		9	
	C	D	C	D	C	D	C	D	C	D	C	D	C	D	C	D	C	D	C	D
F																				
I																				
R																				
S																				
T																				
L																				
E																				
T																				
E																				
R																				

UPPER AND LOWER CASE LETTER WIDTHS

LETTERS	6 INCH UPPER CASE LETTERS		8 INCH UPPER CASE LETTERS		LETTERS	6 INCH LOWER CASE LETTERS	
	SERIES		SERIES			SERIES	
	C	D	C	D		C	D
A	3 ⁶	5 ⁰	5 ⁰	6 ⁵	a	3 ⁵	4 ²
B	3 ²	4 ⁰	4 ³	5 ³	b	3 ⁵	4 ²
C	3 ²	4 ⁰	4 ³	5 ³	c	3 ⁵	4 ¹
D	3 ²	4 ⁰	4 ³	5 ³	d	3 ⁵	4 ²
E	3 ⁰	3 ⁵	4 ⁰	4 ⁷	e	3 ⁵	4 ²
F	3 ⁰	3 ⁵	4 ⁰	4 ⁷	f	2 ³	2 ⁶
G	3 ²	4 ⁰	4 ³	5 ³	g	3 ⁵	4 ²
H	3 ²	4 ⁰	4 ³	5 ³	h	3 ⁵	4 ²
I	0 ⁷	0 ⁷	1 ¹	1 ²	i	1 ¹	1 ¹
J	3 ⁰	3 ⁶	4 ⁰	5 ⁰	j	2 ⁰	2 ²
K	3 ²	4 ¹	4 ³	5 ⁴	k	3 ⁵	4 ²
L	3 ⁰	3 ⁵	4 ⁰	4 ⁷	l	1 ¹	1 ¹
M	3 ⁷	4 ⁵	5 ¹	6 ¹	m	6 ⁰	7 ⁰
N	3 ²	4 ⁰	4 ³	5 ³	n	3 ⁵	4 ²
O	3 ⁴	4 ²	4 ⁵	5 ⁵	o	3 ⁶	4 ³
P	3 ²	4 ⁰	4 ³	5 ³	p	3 ⁵	4 ²
Q	3 ⁴	4 ²	4 ⁵	5 ⁵	q	3 ⁵	4 ²
R	3 ²	4 ⁰	4 ³	5 ³	r	2 ⁶	3 ²
S	3 ²	4 ⁰	4 ³	5 ³	s	3 ⁶	4 ²
T	3 ⁰	3 ⁵	4 ⁰	4 ⁷	t	2 ⁷	3 ²
U	3 ²	4 ⁰	4 ³	5 ³	u	3 ⁵	4 ²
V	3 ⁵	4 ⁴	4 ⁷	6 ⁰	v	4 ²	4 ⁷
W	4 ⁴	5 ²	6 ⁰	7 ⁰	w	5 ⁵	6 ⁴
X	3 ⁴	4 ⁰	4 ⁵	5 ³	x	4 ⁴	5 ¹
Y	3 ⁶	5 ⁰	5 ⁰	6 ⁶	y	4 ⁶	5 ³
Z	3 ²	4 ⁰	4 ³	5 ³	z	3 ⁶	4 ³

NUMBER	6 INCH SERIES		8 INCH SERIES	
	C	D	C	D
1	2 ²	1 ⁴	1 ⁵	2 ⁰
2	3 ²	4 ⁰	4 ³	5 ³
3	3 ²	4 ⁰	4 ³	5 ³
4	3 ⁵	4 ⁰	4 ⁷	5 ⁷
5	3 ²	4 ⁰	4 ³	5 ³
6	3 ²	4 ⁰	4 ³	5 ³
7	3 ²	4 ⁰	4 ³	5 ³
8	3 ²	4 ⁰	4 ³	5 ³
9	3 ²	4 ⁰	4 ³	5 ³
0	3 ⁴	4 ²	4 ⁵	5 ⁵

REVISIONS	
NAME	DATE
APZ/DAG	11/90
	8-95

ILLINOIS DEPARTMENT OF TRANSPORTATION
DISTRICT 1
MAST ARM MOUNTED
STREET NAME SIGNS
DEVON AVENUE &
WOOD DALE ROAD/TONNE ROAD

SCALE: VERT. NONE
HORIZ. 10-30-04

DRAWN BY TJR
CHECKED BY RKF