

SIDE "A"

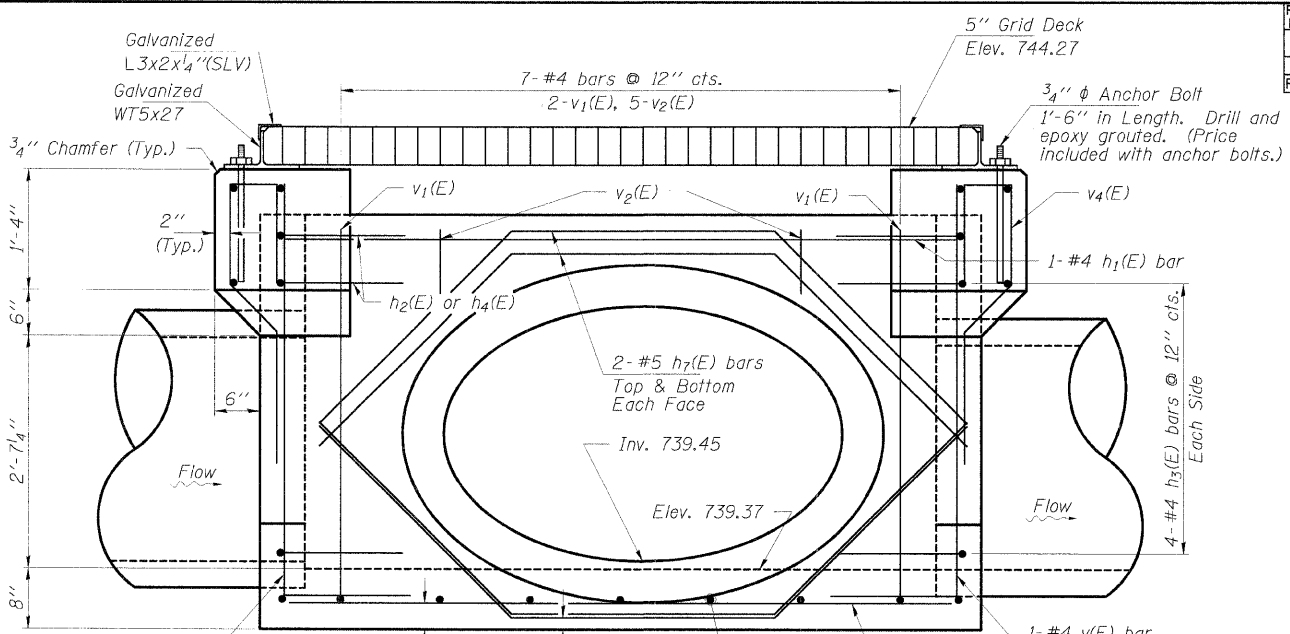

SIDE "B"

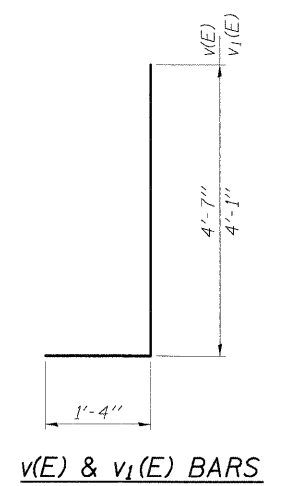

v(E) & v1(E) BARS

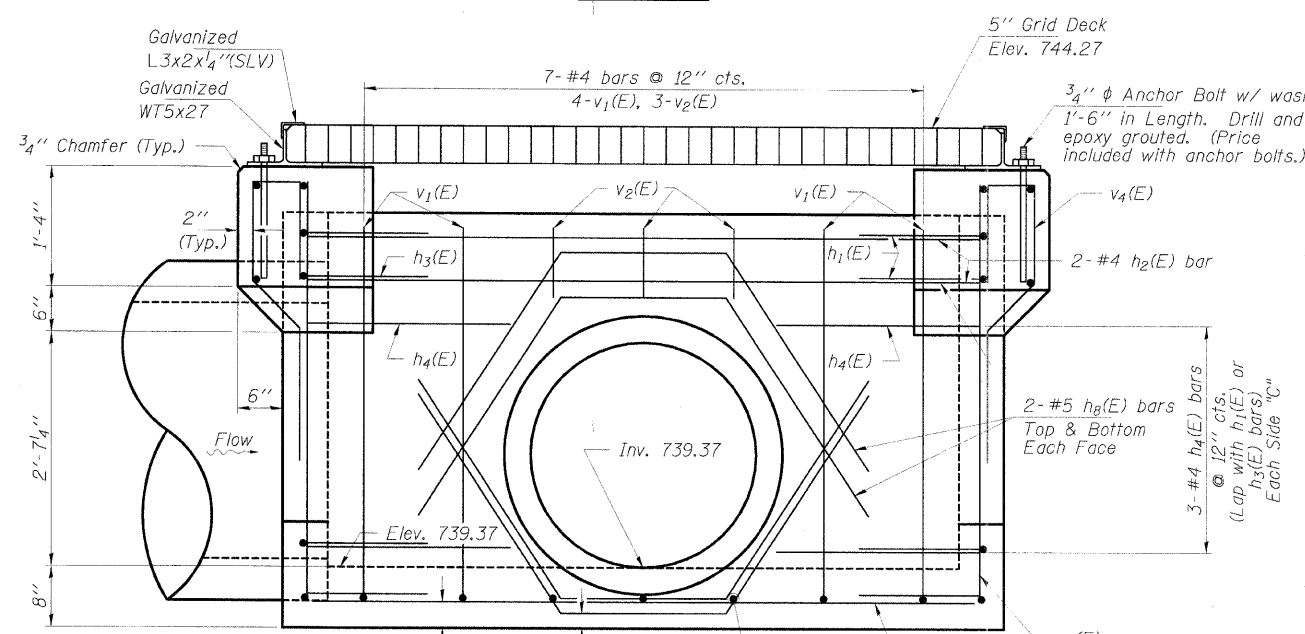

SIDE "C"

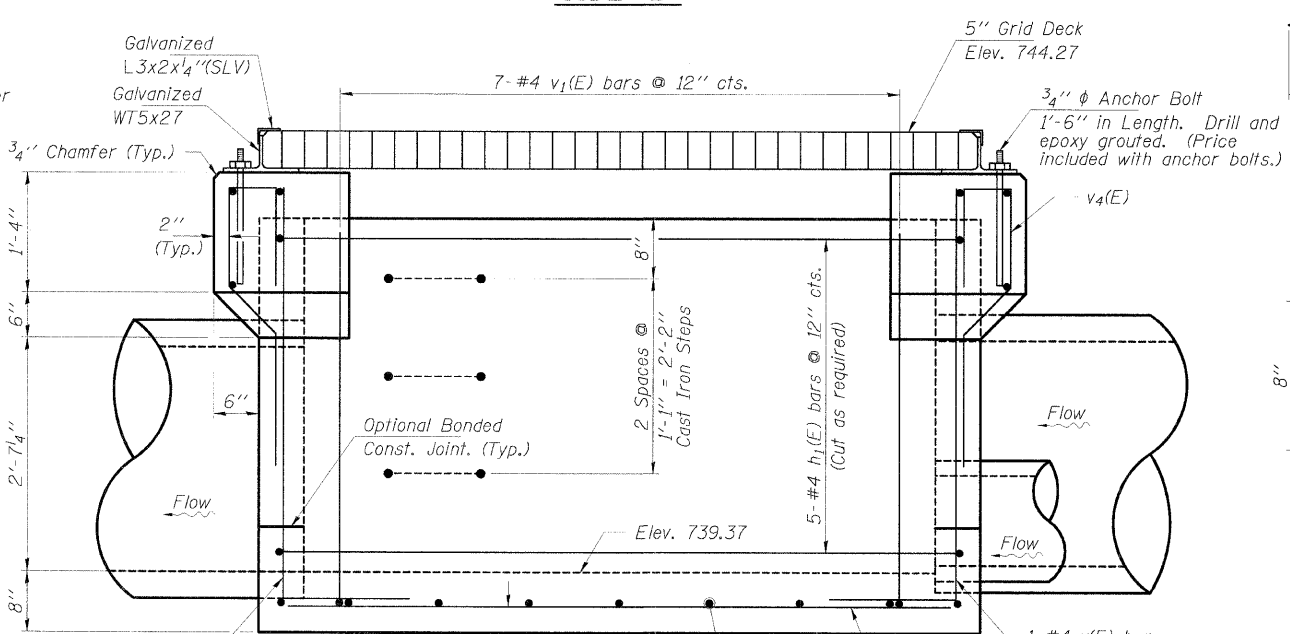

SIDE "D"

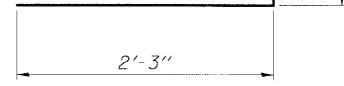

h3(E) BARS

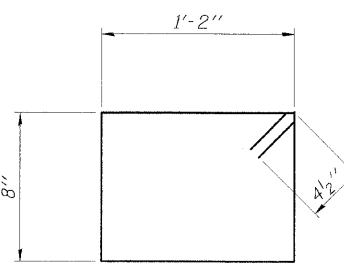

s(E) BAR

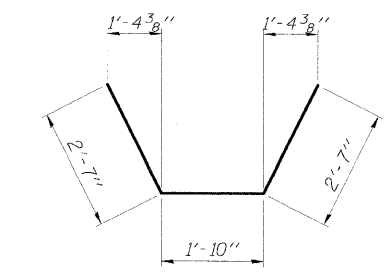

h5(E) BAR

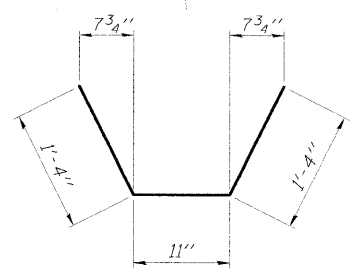

h6(E) BAR

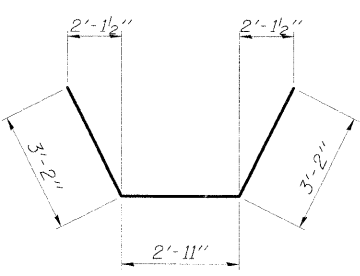

h7(E) BAR

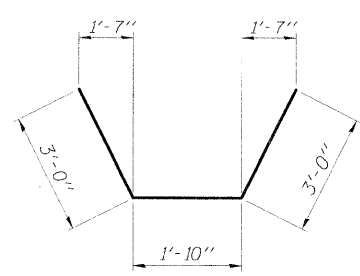

h8(E) BAR

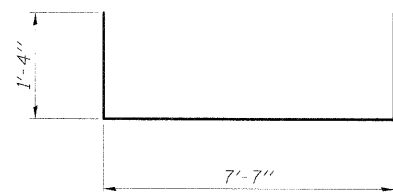

h1(E) BAR

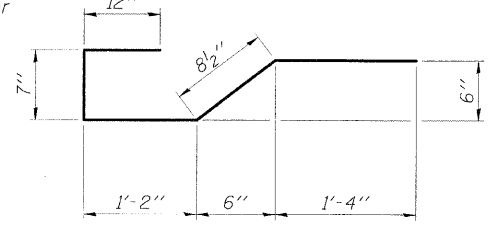

v4(E) BAR

HLR
 Rice, Berry and Associates
 A Division of Hampton, Lonzini and Renwick, Inc.
 Civil & Structural Engineers
 801 S. Durkin Drive
 Springfield, Illinois 62704
 217-546-3400
 P.O. Box 1036
 DuQuoin, Illinois 62832
 618-790-4637
 Account Number 03-05-0181-1
 Date: 01-11-05
 DESIGNED: S.M.S. CHECKED: S.W.V. DRAWN: D.B.

DRAINAGE STRUCTURE SPECIAL
SECTION 99-00243-00-PV
RANDALL ROAD
KANE COUNTY
STATION 23+12