

SPANS 1 & 4 TYPICAL CROSS SECTIONS SPANS 2 & 3

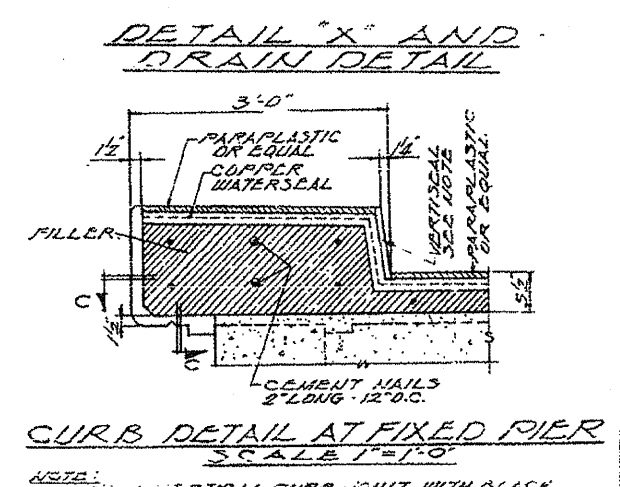

AT BEARINGS AT INTERIOR AT BEARINGS AT INTERIOR TYPICAL DIAPHRAGM DETAILS

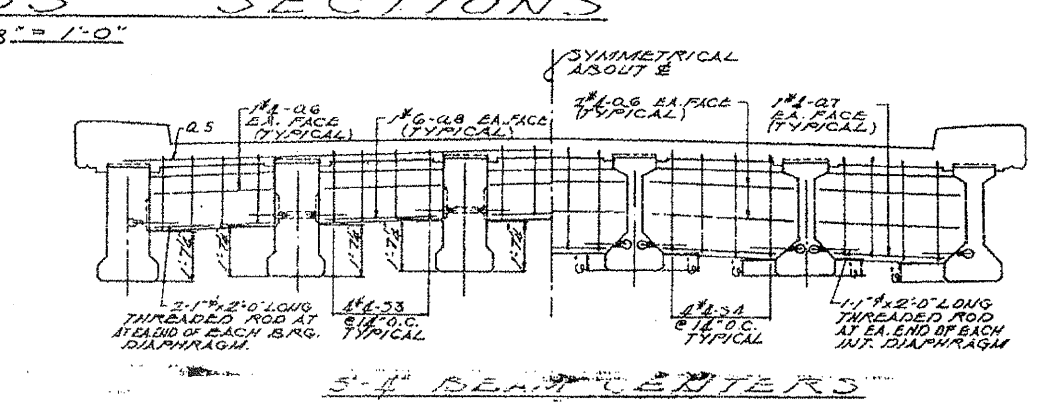
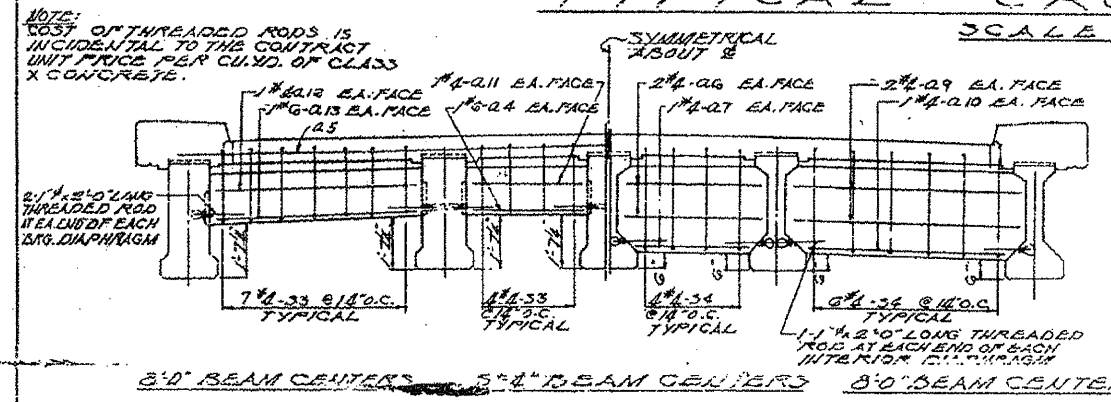
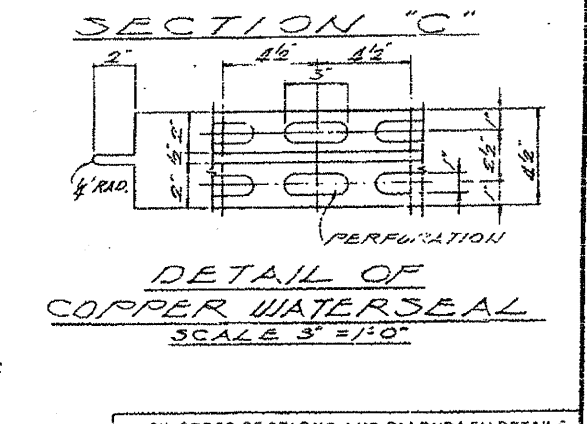
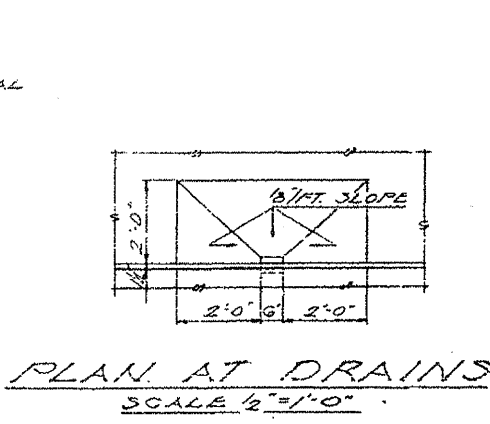
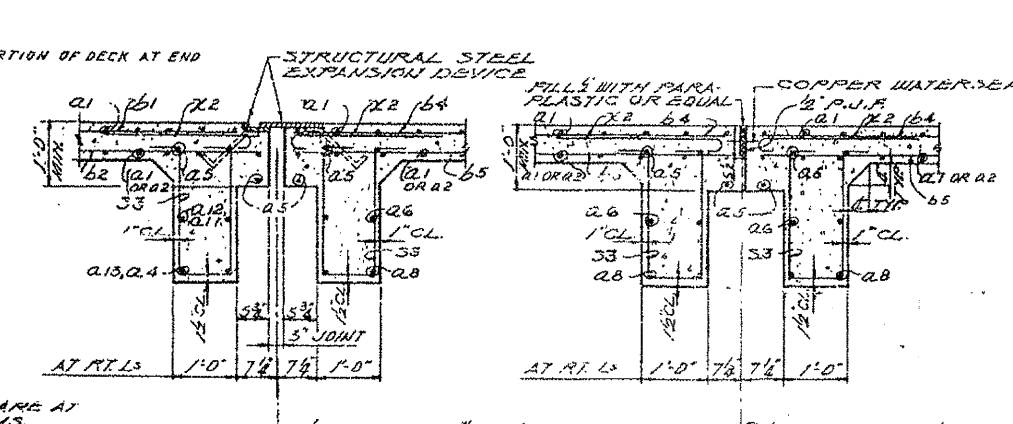
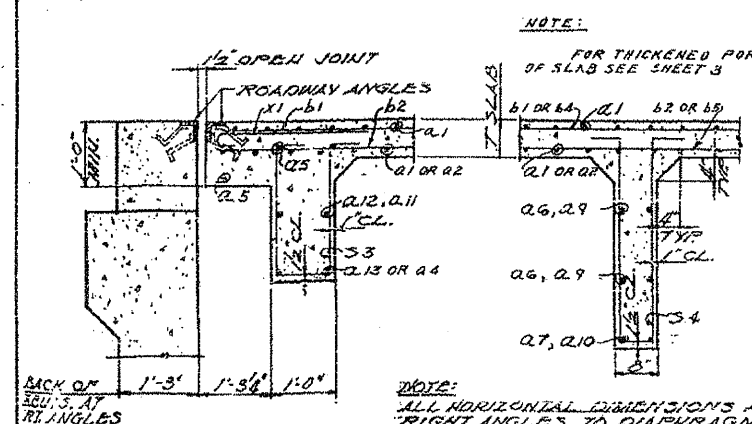

AT ABUTMENTS AT INTERIORS AT EXPANSION PIERS AT FIXED PIER TYPICAL DIAPHRAGM SECTIONS

DECK CROSS SECTIONS AND DIAPHRAGM DETAILS
 GRADE SEPARATION
 CROSS ROAD
 OVER FAI ROUTE 80
 P.A. PROJECT
 FAI ROUTE 80 SECTION (32,47)-4
 GRUNDY-KENDALL COUNTY
 STATION 1397+24.83

ALFRED BENESCH & ASSOCIATES CONSULTING ENGINEERS
 10 SOUTH WABASH AVENUE 602 CHICAGO, ILLINOIS