

NOTE: ALL TIES, UNLESS OTHERWISE STATED, ARE MAG NAILS ±1' FROM EDGE OF BITUMINOUS SHOULDER

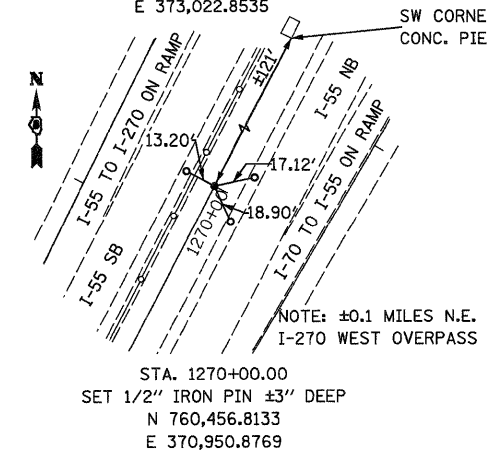
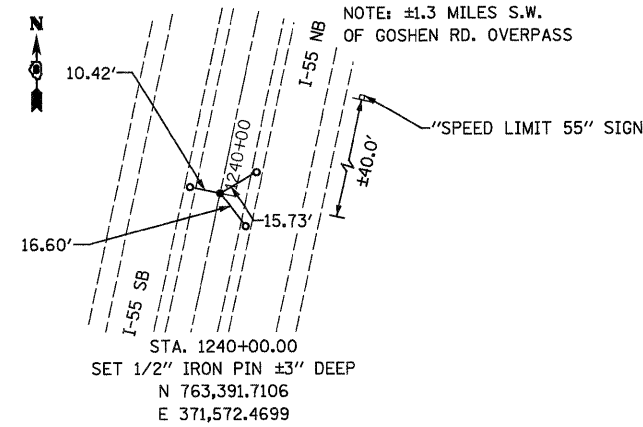
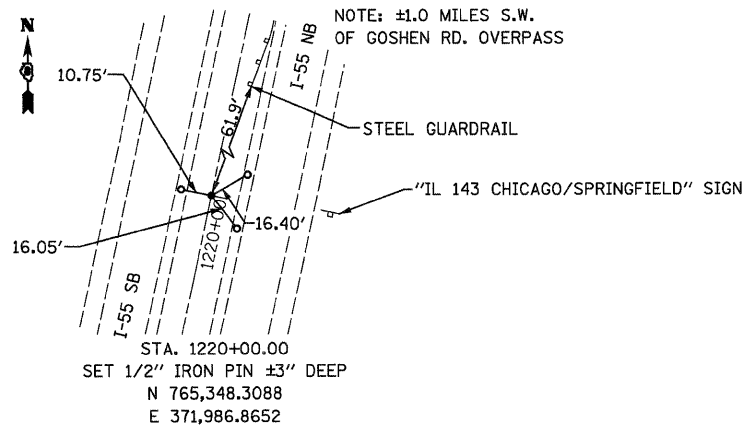
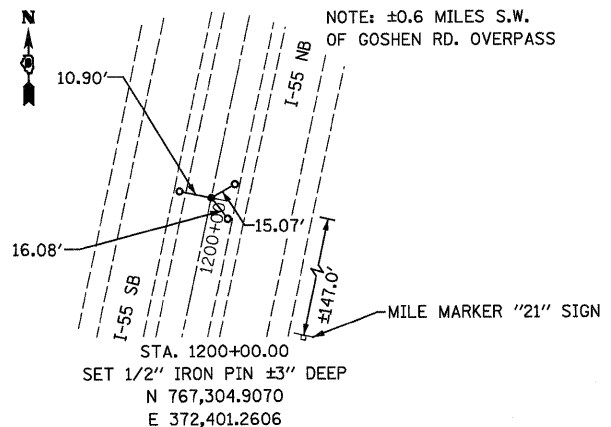
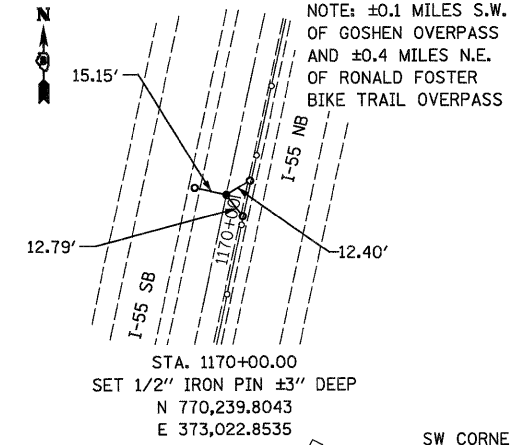
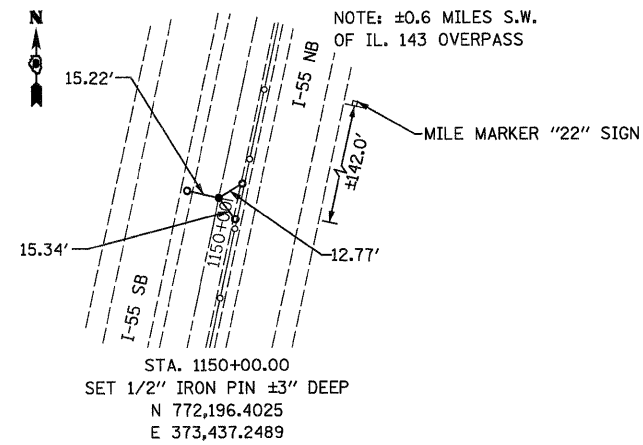
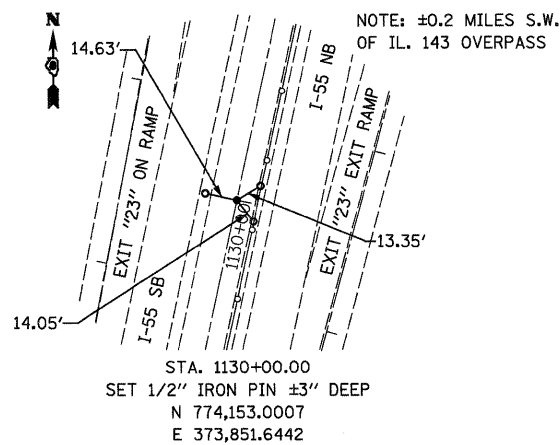
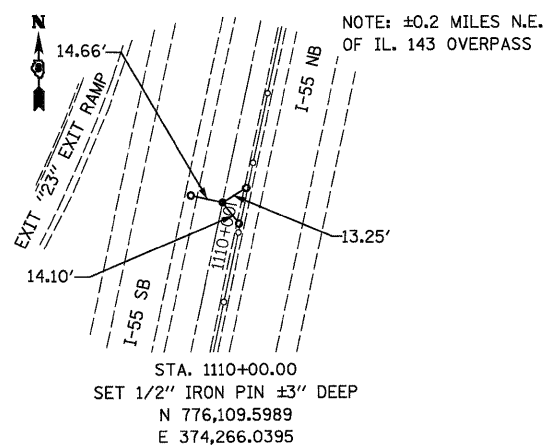
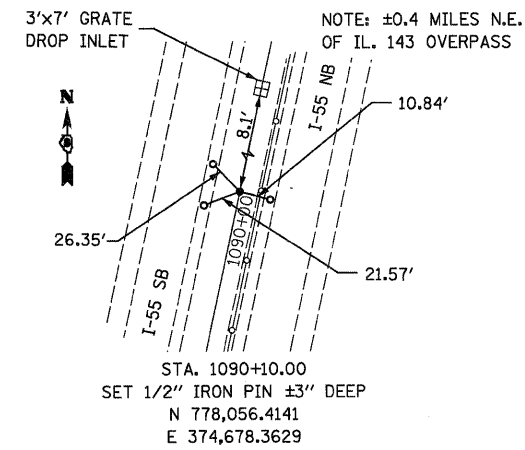
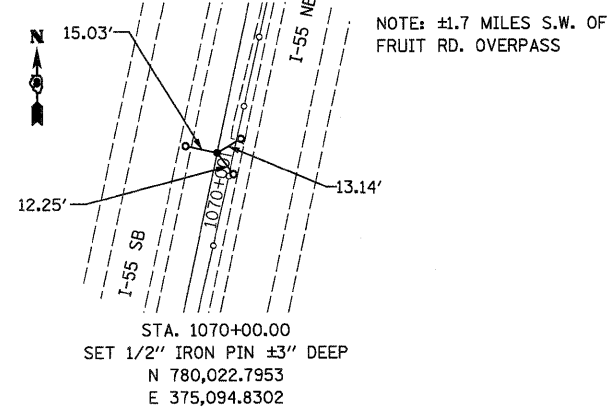
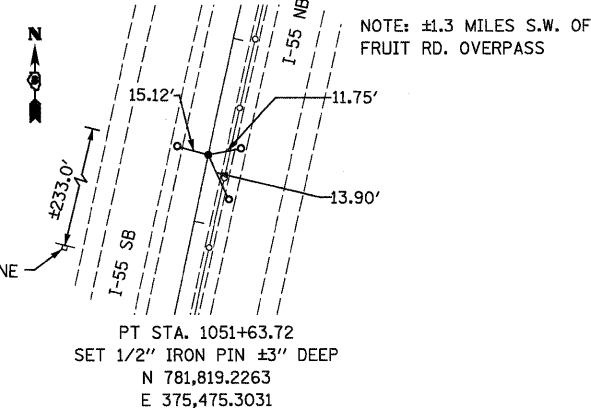
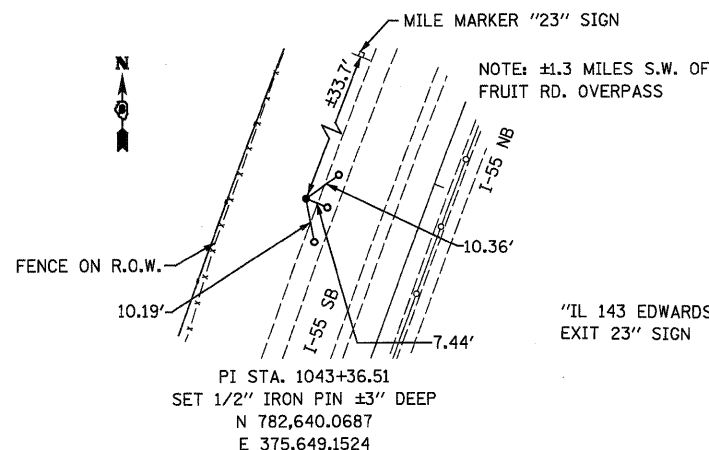
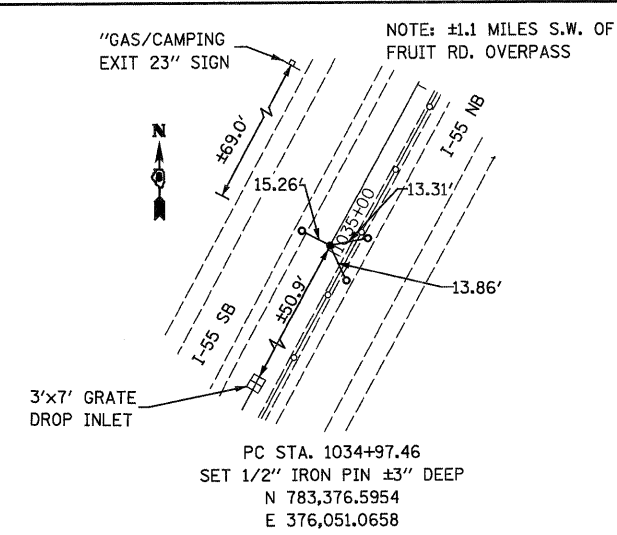
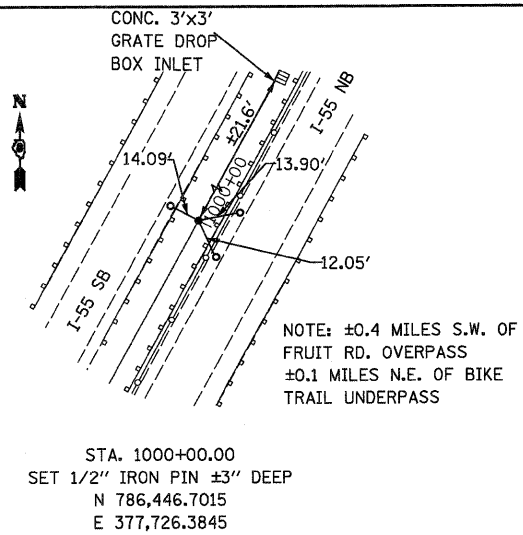
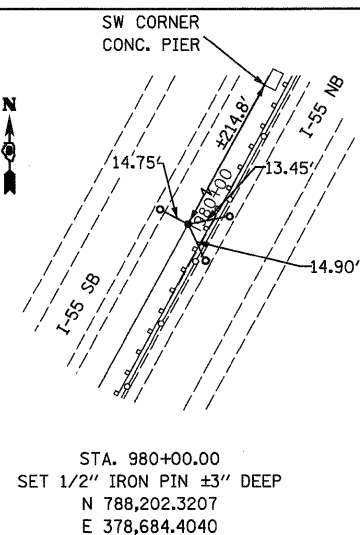
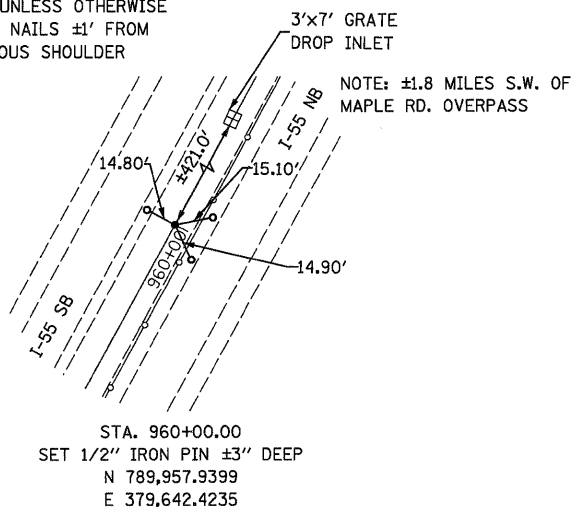

FILE NAME = ...\\oad\ad876e93-ah-ATB.dgn

USER NAME = SJS
PLOT SCALE = 50.0000' / 1" IN.
PLOT DATE = 06/23/2010 15:32:38

DESIGNED -
DRAWN - STM
CHECKED - MTM
DATE - MAY 2010

REVISED -
REVISED -
REVISED -
REVISED -

STATE OF ILLINOIS
DEPARTMENT OF TRANSPORTATION

ALIGNMENTS, TIES AND BENCHMARKS

SCALE: SHEET NO. OF SHEETS STA. TO STA.

F.A.I. RTE.	SECTION	COUNTY	TOTAL SHEETS	SHEET NO.
55	60-(1,2RS-2)	MADISON	156	35
CONTRACT NO. 76C93				
ILLINOIS FED. AID PROJECT				