

If you plan to submit a bid directly to the Department of Transportation

PREQUALIFICATION

Any contractor who desires to become pre-qualified to bid on work advertised by IDOT must submit the properly completed pre-qualification forms to the Bureau of Construction no later than 4:30 p.m. prevailing time twenty-one days prior to the letting of interest. This pre-qualification requirement applies to first time contractors, contractors renewing expired ratings, contractors maintaining continuous pre-qualification or contractors requesting revised ratings. To be eligible to bid, existing pre-qualification ratings must be effective through the date of letting.

REQUESTS FOR AUTHORIZATION TO BID

Contractors wanting to bid on items included in a particular letting must submit the properly completed "Request for Authorization to Bid/or Not For Bid Status" (BDE 124INT) and the ORIGINAL "Affidavit of Availability" (BC 57) to the proper office no later than 4:30 p.m. prevailing time, three (3) days prior to the letting date.

WHO CAN BID ?

Bids will be accepted from only those companies that request and receive written **Authorization to Bid** from IDOT's Central Bureau of Construction.

WHAT CONSTITUTES WRITTEN AUTHORIZATION TO BID?: When a prospective prime bidder submits a "Request for Authorization to Bid/or Not For Bid Status"(BDE 124INT) he/she must indicate at that time which items are being requested For Bidding purposes. Only those items requested For Bidding will be analyzed. After the request has been analyzed, the bidder will be issued a **Proposal Denial and/or Authorization Form**, approved by the Central Bureau of Construction, that indicates which items have been approved For Bidding. If **Authorization to Bid** cannot be approved, the **Proposal Denial and/or Authorization Form** will indicate the reason for denial.

ABOUT AUTHORIZATION TO BID: Firms that have not received an authorization form within a reasonable time of complete and correct original document submittal should contact the department as to status. This is critical in the week before the letting. These documents must be received three days before the letting date. Firms unsure as to authorization status should call the Prequalification Section of the Bureau of Construction at the number listed at the end of these instructions.

ADDENDA AND REVISIONS: It is the contractor's responsibility to determine which, if any, addenda or revisions pertain to any project they may be bidding. Failure to incorporate all relevant addenda or revisions may cause the bid to be declared unacceptable.

Each addendum will be placed with the contract number. Addenda and revisions will also be placed on the Addendum/Revision Checklist and each subscription service subscriber will be notified by e-mail of each addendum and revision issued.

The Internet is the Department's primary way of doing business. The subscription server e-mails are an added courtesy the Department provides. It is suggested that bidders check IDOT's website at <http://www.dot.il.gov/desenv/delett.html> before submitting final bid information.

IDOT IS NOT RESPONSIBLE FOR ANY E-MAIL FAILURES.

Addenda Questions may be directed to the Contracts Office at (217)782-7806 or D&Econtracts@dot.il.gov

Technical Questions about downloading these files may be directed to Tim Garman (217)524-1642 or Timothy.Garman@illinois.gov.

WHAT MUST BE INCLUDED WHEN BIDS ARE SUBMITTED?: Bidders need not return the entire proposal when bids are submitted. That portion of the proposal that must be returned includes the following:

1. All documents from the Proposal Cover Sheet through the Proposal Bid Bond
2. Other special documentation and/or information that may be required by the contract special provisions

All proposal documents, including Proposal Guaranty Checks or Proposal Bid Bonds, should be stapled together to prevent loss when bids are processed by IDOT personnel.

ABOUT SUBMITTING BIDS: It is recommended that bidders deliver bids in person to insure they arrive at the proper location prior to the time specified for the receipt of bids. Any bid received at the place of letting after the time specified will not be accepted.

WHO SHOULD BE CALLED IF ASSISTANCE IS NEEDED?

Questions Regarding	Call
Prequalification and/or Authorization to Bid	217/782-3413
Preparation and submittal of bids	217/782-7806
Mailing of plans and proposals	217/782-7806

ADDENDUMS AND REVISIONS TO THE PROPOSAL FORMS

Planholders should verify that they have received and incorporated any addendum and/or revision prior to submitting their bid. Failure by the bidder to include an addendum or revision could result in a bid being rejected as irregular.

56

RETURN WITH BID

Proposal Submitted By
Name
Address
City

Letting September 19, 2008

BIDDERS NEED NOT RETURN THE ENTIRE PROPOSAL
(See instructions inside front cover)

NOTICE TO PROSPECTIVE BIDDERS

This proposal can be used for bidding purposes by only those companies that request and receive written AUTHORIZATION TO BID from IDOT's Central Bureau of Construction.
(SEE INSTRUCTIONS ON THE INSIDE OF COVER)

Notice To Bidders, Specifications, Proposal, Contract and Contract Bond



**Illinois Department
of Transportation**

Springfield, Illinois 62764

**Contract No. 60E15
Various Counties
Section 2008-002TS
District 1 Formal Contracts
Various Routes**

PLEASE MARK THE APPROPRIATE BOX BELOW:

- A Bid Bond is included.
- A Cashier's Check or a Certified Check is included.

Plans Included
Herein

Prepared by

S

Checked by

(Printed by authority of the State of Illinois)

INSTRUCTIONS

ABOUT IDOT PROPOSALS: All proposals issued by IDOT are potential bidding proposals. Each proposal contains all Certifications and Affidavits, a Proposal Signature Sheet and a Proposal Bid Bond required for Prime Contractors to submit a bid after written **Authorization to Bid** has been issued by IDOT's Central Bureau of Construction.

WHO CAN BID?: Bids will be accepted from only those companies that request and receive written **Authorization to Bid** from IDOT's Central Bureau of Construction. To request authorization, a potential bidder must complete and submit Part B of the Request for Authorization to Bid/or Not For Bid Status form (BDE 124 INT) and submit an original Affidavit of Availability (BC 57).

WHAT CONSTITUTES WRITTEN AUTHORIZATION TO BID?: When a prospective prime bidder submits a "Request for Proposal Forms and Plans" he/she must indicate at that time which items are being requested For Bidding purposes. Only those items requested For Bidding will be analyzed. After the request has been analyzed, the bidder will be issued a **Proposal Denial and/or Authorization Form**, approved by the Central Bureau of Construction, that indicates which items have been approved For Bidding. If **Authorization to Bid** cannot be approved, the **Proposal Denial and/or Authorization Form** will indicate the reason for denial. If a contractor has requested to bid but has not received a **Proposal Denial and/or Authorization Form**, they should contact the Central Bureau of Construction in advance of the letting date.

WHAT MUST BE INCLUDED WHEN BIDS ARE SUBMITTED?: Bidders need not return the entire proposal when bids are submitted. That portion of the proposal that must be returned includes the following:

1. All documents from the Proposal Cover Sheet through the Proposal Bid Bond
2. Other special documentation and/or information that may be required by the contract special provisions

All proposal documents, including Proposal Guaranty Checks or Proposal Bid Bonds, should be stapled together to prevent loss when bids are processed by IDOT personnel.

ABOUT SUBMITTING BIDS: It is recommended that bidders deliver bids in person to insure they arrive at the proper location prior to the time specified for the receipt of bids. Any bid received at the place of letting after the time specified will not be accepted.

WHO SHOULD BE CALLED IF ASSISTANCE IS NEEDED?

Questions Regarding	Call
Prequalification and/or Authorization to Bid	217/782-3413
Preparation and submittal of bids	217/782-7806
Mailing of CD-ROMS	217/782-7806

RETURN WITH BID



PROPOSAL

TO THE DEPARTMENT OF TRANSPORTATION

1. Proposal of _____

Taxpayer Identification Number (Mandatory) _____ a

for the improvement identified and advertised for bids in the Invitation for Bids as:

**Contract No. 60E15
Various Counties
Section 2008-002TS
Various Routes
District 1 Formal Contracts**

Annual maintenance of traffic signals, highway lighting, pump stations, surveillance and other electrical systems located in District One.

2. The undersigned bidder will furnish all labor, material and equipment to complete the above described project in a good and workmanlike manner as provided in the contract documents provided by the Department of Transportation. This proposal will become part of the contract and the terms and conditions contained in the contract documents shall govern performance and payments.

RETURN WITH BID

3. **ASSURANCE OF EXAMINATION AND INSPECTION/WAIVER.** The undersigned further declares that he/she has carefully examined the proposal, plans, specifications, form of contract and contract bond, and special provisions, and that he/she has inspected in detail the site of the proposed work, and that he/she has familiarized themselves with all of the local conditions affecting the contract and the detailed requirements of construction, and understands that in making this proposal he/she waives all right to plead any misunderstanding regarding the same.

4. **EXECUTION OF CONTRACT AND CONTRACT BOND.** The undersigned further agrees to execute a contract for this work and present the same to the department within fifteen (15) days after the contract has been mailed to him/her. The undersigned further agrees that he/she and his/her surety will execute and present within fifteen (15) days after the contract has been mailed to him/her contract bond satisfactory to and in the form prescribed by the Department of Transportation, in the penal sum of the full amount of the contract, guaranteeing the faithful performance of the work in accordance with the terms of the contract.

5. **PROPOSAL GUARANTY.** Accompanying this proposal is either a bid bond on the department form, executed by a corporate surety company satisfactory to the department, or a proposal guaranty check consisting of a bank cashier's check or a properly certified check for not less than 5 per cent of the amount bid or for the amount specified in the following schedule:

<u>Amount of Bid</u>		<u>Proposal Guaranty</u>	<u>Amount of Bid</u>		<u>Proposal Guaranty</u>	
Up to	\$5,000	\$150	\$2,000,000	to	\$3,000,000	\$100,000
\$5,000	to \$10,000	\$300	\$3,000,000	to	\$5,000,000	\$150,000
\$10,000	to \$50,000	\$1,000	\$5,000,000	to	\$7,500,000	\$250,000
\$50,000	to \$100,000	\$3,000	\$7,500,000	to	\$10,000,000	\$400,000
\$100,000	to \$150,000	\$5,000	\$10,000,000	to	\$15,000,000	\$500,000
\$150,000	to \$250,000	\$7,500	\$15,000,000	to	\$20,000,000	\$600,000
\$250,000	to \$500,000	\$12,500	\$20,000,000	to	\$25,000,000	\$700,000
\$500,000	to \$1,000,000	\$25,000	\$25,000,000	to	\$30,000,000	\$800,000
\$1,000,000	to \$1,500,000	\$50,000	\$30,000,000	to	\$35,000,000	\$900,000
\$1,500,000	to \$2,000,000	\$75,000	over		\$35,000,000	\$1,000,000

Bank cashier's checks or properly certified checks accompanying proposals shall be made payable to the Treasurer, State of Illinois, when the state is awarding authority; the county treasurer, when a county is the awarding authority; or the city, village, or town treasurer, when a city, village, or town is the awarding authority.

If a combination bid is submitted, the proposal guaranties which accompany the individual proposals making up the combination will be considered as also covering the combination bid.

The amount of the proposal guaranty check is _____ \$(_____). If this proposal is accepted and the undersigned shall fail to execute a contract bond as required herein, it is hereby agreed that the amount of the proposal guaranty shall become the property of the State of Illinois, and shall be considered as payment of damages due to delay and other causes suffered by the State because of the failure to execute said contract and contract bond; otherwise, the bid bond shall become void or the proposal guaranty check shall be returned to the undersigned.

Attach Cashier's Check or Certified Check Here	
In the event that one proposal guaranty check is intended to cover two or more proposals, the amount must be equal to the sum of the proposal guaranties which would be required for each individual proposal. If the guaranty check is placed in another proposal, state below where it may be found.	
The proposal guaranty check will be found in the proposal for:	Item _____
	Section No. _____
	County _____

Mark the proposal cover sheet as to the type of proposal guaranty submitted.

RETURN WITH BID

6. **COMBINATION BIDS.** The undersigned further agrees that if awarded the contract for the sections contained in the following combination, he/she will perform the work in accordance with the requirements of each individual proposal comprising the combination bid specified in the schedule below, and that the combination bid shall be prorated against each section in proportion to the bid submitted for the same. If an error is found to exist in the gross sum bid for one or more of the individual sections included in a combination, the combination bid shall be corrected as provided in the specifications.

When a combination bid is submitted, the schedule below must be completed in each proposal comprising the combination.

If alternate bids are submitted for one or more of the sections comprising the combination, a combination bid must be submitted for each alternate.

Schedule of Combination Bids

Combination No.	Sections Included in Combination	Combination Bid	
		Dollars	Cents

7. **SCHEDULE OF PRICES.** The undersigned bidder submits herewith, in accordance with the rules and instructions, a schedule of prices for the items of work for which bids are sought. The unit prices bid are in U.S. dollars and cents, and all extensions and summations have been made. The bidder understands that the quantities appearing in the bid schedule are approximate and are provided for the purpose of obtaining a gross sum for the comparison of bids. If there is an error in the extension of the unit prices, the unit prices shall govern. Payment to the contractor awarded the contract will be made only for actual quantities of work performed and accepted or materials furnished according to the contract. The scheduled quantities of work to be done and materials to be furnished may be increased, decreased or omitted as provided elsewhere in the contract.

8. **CERTIFICATE OF AUTHORITY.** The undersigned bidder, if a business organized under the laws of another State, assures the Department that it will furnish a copy of its certificate of authority to do business in the State of Illinois with the return of the executed contract and bond. Failure to furnish the certificate within the time provided for execution of an awarded contract may be cause for cancellation of the award and forfeiture of the proposal guaranty to the State.

CONTRACT NUMBER

60E15

THIS IS THE TOTAL BID

\$ _____

NOTES:

1. Each **PAY ITEM** should have a **UNIT PRICE** and a **TOTAL PRICE**.
2. The **UNIT PRICE** shall govern if no **TOTAL PRICE** is shown or if there is a discrepancy between the product of the **UNIT PRICE** multiplied by the **QUANTITY**.
3. If a **UNIT PRICE** is omitted, the **TOTAL PRICE** will be divided by the **QUANTITY** in order to establish a **UNIT PRICE**.
4. A bid may be declared **UNACCEPTABLE** if neither a unit price nor a total price is shown.

RETURN WITH BID

STATE REQUIRED ETHICAL STANDARDS GOVERNING CONTRACT PROCUREMENT: ASSURANCES, CERTIFICATIONS AND DISCLOSURES

I. GENERAL

A. Article 50 of the Illinois Procurement Code establishes the duty of all State chief procurement officers, State purchasing officers, and their designees to maximize the value of the expenditure of public moneys in procuring goods, services, and contracts for the State of Illinois and to act in a manner that maintains the integrity and public trust of State government. In discharging this duty, they are charged by law to use all available information, reasonable efforts, and reasonable actions to protect, safeguard, and maintain the procurement process of the State of Illinois.

B. In order to comply with the provisions of Article 50 and to carry out the duty established therein, all bidders are to adhere to ethical standards established for the procurement process, and to make such assurances, disclosures and certifications required by law. By execution of the Proposal Signature Sheet, the bidder indicates that each of the mandated assurances has been read and understood, that each certification is made and understood, and that each disclosure requirement has been understood and completed.

C. In addition to all other remedies provided by law, failure to comply with any assurance, failure to make any disclosure or the making of a false certification shall be grounds for termination of the contract and the suspension or debarment of the bidder.

II. ASSURANCES

A. The assurances hereinafter made by the bidder are each a material representation of fact upon which reliance is placed should the Department enter into the contract with the bidder. The Department may terminate the contract if it is later determined that the bidder rendered a false or erroneous assurance, and the surety providing the performance bond shall be responsible for the completion of the contract.

B. Felons

1. The Illinois Procurement Code provides:

Section 50-10. Felons. Unless otherwise provided, no person or business convicted of a felony shall do business with the State of Illinois or any state agency from the date of conviction until 5 years after the date of completion of the sentence for that felony, unless no person held responsible by a prosecutorial office for the facts upon which the conviction was based continues to have any involvement with the business.

2. The bidder assures the Department that the award and execution of the contract would not cause a violation of Section 50-10.

C. Conflicts of Interest

1. The Illinois Procurement Code provides in pertinent part:

Section 50-13. Conflicts of Interest.

(a) Prohibition. It is unlawful for any person holding an elective office in this State, holding a seat in the General Assembly, or appointed to or employed in any of the offices or agencies of state government and who receives compensation for such employment in excess of 60% of the salary of the Governor of the State of Illinois, or who is an officer or employee of the Capital Development Board or the Illinois Toll Highway Authority, or who is the spouse or minor child of any such person to have or acquire any contract, or any direct pecuniary interest in any contract therein, whether for stationery, printing, paper, or any services, materials, or supplies, that will be wholly or partially satisfied by the payment of funds appropriated by the General Assembly of the State of Illinois or in any contract of the Capital Development Board or the Illinois Toll Highway authority.

(b) Interests. It is unlawful for any firm, partnership, association or corporation, in which any person listed in subsection (a) is entitled to receive (i) more than 7 1/2% of the total distributable income or (ii) an amount in excess of the salary of the Governor, to have or acquire any such contract or direct pecuniary interest therein.

(c) Combined interests. It is unlawful for any firm, partnership, association, or corporation, in which any person listed in subsection (a) together with his or her spouse or minor children is entitled to receive (i) more than 15%, in the aggregate, of the total distributable income or (ii) an amount in excess of 2 times the salary of the Governor, to have or acquire any such contract or direct pecuniary interest therein.

(d) Securities. Nothing in this Section invalidates the provisions of any bond or other security previously offered or to be offered for sale or sold by or for the State of Illinois.

(e) Prior interests. This Section does not affect the validity of any contract made between the State and an officer or employee of the State or member of the General Assembly, his or her spouse, minor child or any combination of those persons if that contract was in existence before his or her election or employment as an officer, member, or employee. The contract is voidable, however, if it cannot be completed within 365 days after the officer, member, or employee takes office or is employed.

The current salary of the Governor is \$171,000.00. Sixty percent of the salary is \$102,600.00.

RETURN WITH BID

2. The bidder assures the Department that the award and execution of the contract would not cause a violation of Section 50-13, or that an effective exemption has been issued by the Board of Ethics to any individual subject to the Section 50-13 prohibitions pursuant to the provisions of Section 50-20 of the Code and Executive Order Number 3 (1998). Information concerning the exemption process is available from the Department upon request.

D. Negotiations

1. The Illinois Procurement Code provides in pertinent part:

Section 50-15. Negotiations.

(a) It is unlawful for any person employed in or on a continual contractual relationship with any of the offices or agencies of State government to participate in contract negotiations on behalf of that office or agency with any firm, partnership, association, or corporation with whom that person has a contract for future employment or is negotiating concerning possible future employment.

2. The bidder assures the Department that the award and execution of the contract would not cause a violation of Section 50-15, and that the bidder has no knowledge of any facts relevant to the kinds of acts prohibited therein.

E. Inducements

1. The Illinois Procurement Code provides:

Section 50-25. Inducement. Any person who offers or pays any money or other valuable thing to any person to induce him or her not to bid for a State contract or as recompense for not having bid on a State contract is guilty of a Class 4 felony. Any person who accepts any money or other valuable thing for not bidding for a State contract or who withholds a bid in consideration of the promise for the payment of money or other valuable thing is guilty of a Class 4 felony.

2. The bidder assures the Department that the award and execution of the contract would not cause a violation of Section 50-25, and that the bidder has no knowledge of any facts relevant to the kinds of acts prohibited therein.

F. Revolving Door Prohibition

1. The Illinois Procurement Code provides:

Section 50-30. Revolving door prohibition. Chief procurement officers, associate procurement officers, State purchasing officers, their designees whose principal duties are directly related to State procurement, and executive officers confirmed by the Senate are expressly prohibited for a period of 2 years after terminating an affected position from engaging in any procurement activity relating to the State agency most recently employing them in an affected position for a period of at least 6 months. The prohibition includes, but is not limited to: lobbying the procurement process; specifying; bidding; proposing bid, proposal, or contract documents; on their own behalf or on behalf of any firm, partnership, association, or corporation. This Section applies only to persons who terminate an affected position on or after January 15, 1999.

2. The bidder assures the Department that the award and execution of the contract would not cause a violation of Section 50-30, and that the bidder has no knowledge of any facts relevant to the kinds of acts prohibited therein.

G. Reporting Anticompetitive Practices

1. The Illinois Procurement Code provides:

Section 50-40. Reporting anticompetitive practices. When, for any reason, any vendor, bidder, contractor, chief procurement officer, State purchasing officer, designee, elected official, or State employee suspects collusion or other anticompetitive practice among any bidders, offerors, contractors, proposers, or employees of the State, a notice of the relevant facts shall be transmitted to the Attorney General and the chief procurement officer.

2. The bidder assures the Department that it has not failed to report any relevant facts concerning the practices addressed in Section 50-40 which may involve the contract for which the bid is submitted.

H. Confidentiality

1. The Illinois Procurement Code provides:

Section 50-45. Confidentiality. Any chief procurement officer, State purchasing officer, designee, or executive officer who willfully uses or allows the use of specifications, competitive bid documents, proprietary competitive information, proposals, contracts, or selection information to compromise the fairness or integrity of the procurement, bidding, or contract process shall be subject to immediate dismissal, regardless of the Personnel code, any contract, or any collective bargaining agreement, and may in addition be subject to criminal prosecution.

2. The bidder assures the Department that it has no knowledge of any fact relevant to the practices addressed in Section 50-45 which may involve the contract for which the bid is submitted.

RETURN WITH BID

I. Insider Information

1. The Illinois Procurement Act provides:

Section 50-50. Insider information. It is unlawful for any current or former elected or appointed State official or State employee to knowingly use confidential information available only by virtue of that office or employment for actual or anticipated gain for themselves or another person.

2. The bidder assures the Department that it has no knowledge of any facts relevant to the practices addressed in Section 50-50 which may involve the contract for which the bid is submitted.

III. CERTIFICATIONS

A. The certifications hereinafter made by the bidder are each a material representation of fact upon which reliance is placed should the Department enter into the contract with the bidder. The Department may terminate the contract if it is later determined that the bidder rendered a false or erroneous certification, and the surety providing the performance bond shall be responsible for completion of the contract.

B. Bribery

1. The Illinois Procurement Code provides:

Section 50-5. Bribery.

(a) Prohibition. No person or business shall be awarded a contract or subcontract under this Code who:

(1) has been convicted under the laws of Illinois or any other state of bribery or attempting to bribe an officer or employee of the State of Illinois or any other state in that officer's or employee's official capacity; or

(2) has made an admission of guilt of that conduct that is a matter of record but has not been prosecuted for that conduct.

(b) Businesses. No business shall be barred from contracting with any unit of State or local government as a result of a conviction under this Section of any employee or agent of the business if the employee or agent is no longer employed by the business and:

(1) the business has been finally adjudicated not guilty; or

(2) the business demonstrates to the governmental entity with which it seeks to contract, and that entity finds that the commission of the offense was not authorized, requested, commanded, or performed by a director, officer, or high managerial agent on behalf of the business as provided in paragraph (2) of subsection (a) of Section 5-4 of the Criminal Code of 1961.

(c) Conduct on behalf of business. For purposes of this Section, when an official, agent, or employee of a business committed the bribery or attempted bribery on behalf of the business and in accordance with the direction or authorization of a responsible official of the business, the business shall be chargeable with the conduct.

(d) Certification. Every bid submitted to and contract executed by the State shall contain a certification by the contractor that the contractor is not barred from being awarded a contract or subcontract under this Section. A contractor who makes a false statement, material to the certification, commits a Class 3 felony.

2. The bidder certifies that it is not barred from being awarded a contract under Section 50.5.

C. Educational Loan

1. Section 3 of the Educational Loan Default Act provides:

§ 3. No State agency shall contract with an individual for goods or services if that individual is in default, as defined in Section 2 of this Act, on an educational loan. Any contract used by any State agency shall include a statement certifying that the individual is not in default on an educational loan as provided in this Section.

2. The bidder, if an individual as opposed to a corporation, partnership or other form of business organization, certifies that the bidder is not in default on an educational loan as provided in Section 3 of the Act.

D. Bid-Rigging/Bid Rotating

1. Section 33E-11 of the Criminal Code of 1961 provides:

§ 33E-11. (a) Every bid submitted to and public contract executed pursuant to such bid by the State or a unit of local government shall contain a certification by the prime contractor that the prime contractor is not barred from contracting with any unit of State or local government as a result of a violation of either Section 33E-3 or 33E-4 of this Article. The State and units of local government shall provide the appropriate forms for such certification.

RETURN WITH BID

(b) A contractor who makes a false statement, material to the certification, commits a Class 3 felony.

A violation of Section 33E-3 would be represented by a conviction of the crime of bid-rigging which, in addition to Class 3 felony sentencing, provides that any person convicted of this offense or any similar offense of any state or the United States which contains the same elements as this offense shall be barred for 5 years from the date of conviction from contracting with any unit of State or local government. No corporation shall be barred from contracting with any unit of State or local government as a result of a conviction under this Section of any employee or agent of such corporation if the employee so convicted is no longer employed by the corporation and: (1) it has been finally adjudicated not guilty or (2) if it demonstrates to the governmental entity with which it seeks to contract and that entity finds that the commission of the offense was neither authorized, requested, commanded, nor performed by a director, officer or a high managerial agent in behalf of the corporation.

A violation of Section 33E-4 would be represented by a conviction of the crime of bid-rotating which, in addition to Class 2 felony sentencing, provides that any person convicted of this offense or any similar offense of any state or the United States which contains the same elements as this offense shall be permanently barred from contracting with any unit of State or local government. No corporation shall be barred from contracting with any unit of State or local government as a result of a conviction under this Section of any employee or agent of such corporation if the employee so convicted is no longer employed by the corporation and: (1) it has been finally adjudicated not guilty or (2) if it demonstrates to the governmental entity with which it seeks to contract and that entity finds that the commission of the offense was neither authorized, requested, commanded, nor performed by a director, officer or a high managerial agent in behalf of the corporation.

2. The bidder certifies that it is not barred from contracting with the Department by reason of a violation of either Section 33E-3 or Section 33E-4.

E. International Anti-Boycott

1. Section 5 of the International Anti-Boycott Certification Act provides:

§ 5. State contracts. Every contract entered into by the State of Illinois for the manufacture, furnishing, or purchasing of supplies, material, or equipment or for the furnishing of work, labor, or services, in an amount exceeding the threshold for small purchases according to the purchasing laws of this State or \$10,000.00, whichever is less, shall contain certification, as a material condition of the contract, by which the contractor agrees that neither the contractor nor any substantially-owned affiliated company is participating or shall participate in an international boycott in violation of the provisions of the U.S. Export Administration Act of 1979 or the regulations of the U.S. Department of Commerce promulgated under that Act.

2. The bidder makes the certification set forth in Section 5 of the Act.

F. Drug Free Workplace

1. The Illinois "Drug Free Workplace Act" applies to this contract and it is necessary to comply with the provisions of the "Act" if the contractor is a corporation, partnership, or other entity (including a sole proprietorship) which has 25 or more employees.

2. The bidder certifies that if awarded a contract in excess of \$5,000 it will provide a drug free workplace by:

(a) Publishing a statement notifying employees that the unlawful manufacture, distribution, dispensation, possession or use of a controlled substance, including cannabis, is prohibited in the contractor's workplace; specifying the actions that will be taken against employees for violations of such prohibition; and notifying the employee that, as a condition of employment on such contract, the employee shall abide by the terms of the statement, and notify the employer of any criminal drug statute conviction for a violation occurring in the workplace no later than five (5) days after such conviction.

(b) Establishing a drug free awareness program to inform employees about the dangers of drug abuse in the workplace; the contractor's policy of maintaining a drug free workplace; any available drug counseling, rehabilitation, and employee assistance programs; and the penalties that may be imposed upon employees for drug violations.

(c) Providing a copy of the statement required by subparagraph (1) to each employee engaged in the performance of the contract and to post the statement in a prominent place in the workplace.

(d) Notifying the Department within ten (10) days after receiving notice from an employee or otherwise receiving actual notice of the conviction of an employee for a violation of any criminal drug statute occurring in the workplace.

(e) Imposing or requiring, within 30 days after receiving notice from an employee of a conviction or actual notice of such a conviction, an appropriate personnel action, up to and including termination, or the satisfactory participation in a drug abuse assistance or rehabilitation program approved by a federal, state or local health, law enforcement or other appropriate agency.

(f) Assisting employees in selecting a course of action in the event drug counseling, treatment, and rehabilitation is required and indicating that a trained referral team is in place.

(g) Making a good faith effort to continue to maintain a drug free workplace through implementation of the actions and efforts stated in this certification.

RETURN WITH BID

G. Debt Delinquency

1. The Illinois Procurement Code provides:

Section 50-11 and 50-12. Debt Delinquency.

The contractor or bidder certifies that it, or any affiliate, is not barred from being awarded a contract under 30 ILCS 500. Section 50-11 prohibits a person from entering into a contract with a State agency if it knows or should know that it, or any affiliate, is delinquent in the payment of any debt to the State as defined by the Debt Collection Board. Section 50-12 prohibits a person from entering into a contract with a State agency if it, or any affiliate, has failed to collect and remit Illinois Use Tax on all sales of tangible personal property into the State of Illinois in accordance with the provisions of the Illinois Use Tax Act. The contractor further acknowledges that the contracting State agency may declare the contract void if this certification is false or if the contractor, or any affiliate, is determined to be delinquent in the payment of any debt to the State during the term of the contract.

H. Sarbanes-Oxley Act of 2002

1. The Illinois Procurement Code provides:

Section 50-60(c).

The contractor certifies in accordance with 30 ILCS 500/50-10.5 that no officer, director, partner or other managerial agent of the contracting business has been convicted of a felony under the Sarbanes-Oxley Act of 2002 or a Class 3 or Class 2 felony under the Illinois Securities Law of 1953 for a period of five years prior to the date of the bid or contract. The contractor acknowledges that the contracting agency shall declare the contract void if this certification is false.

I. Addenda

The contractor or bidder certifies that all relevant addenda have been incorporated in to this contract. Failure to do so may cause the bid to be declared unacceptable.

J. Section 42 of the Environmental Protection Act

The contractor certifies in accordance with 30 ILCS 500/50-12 that the bidder or contractor is not barred from being awarded a contract under this Section which prohibits the bidding on or entering into contracts with the State of Illinois or a State agency by a person or business found by a court or the Pollution Control Board to have committed a willful or knowing violation of Section 42 of the Environmental Protection Act for a period of five years from the date of the order. The contractor acknowledges that the contracting agency may declare the contract void if this certification is false.

K. Apprenticeship and Training Certification (Does not apply to federal aid projects)

In accordance with the provisions of Section 30-22 (6) of the Illinois Procurement Code, the bidder certifies that it is a participant, either as an individual or as part of a group program, in the approved apprenticeship and training programs applicable to each type of work or craft that the bidder will perform with its own forces. The bidder further certifies for work that will be performed by subcontract that each of its subcontractors submitted for approval either (a) is, at the time of such bid, participating in an approved, applicable apprenticeship and training program; or (b) will, prior to commencement of performance of work pursuant to this contract, begin participation in an approved apprenticeship and training program applicable to the work of the subcontract. The Department, at any time before or after award, may require the production of a copy of each applicable Certificate of Registration issued by the United States Department of Labor evidencing such participation by the contractor and any or all of its subcontractors. Applicable apprenticeship and training programs are those that have been approved and registered with the United States Department of Labor. The bidder shall list in the space below, the official name of the program sponsor holding the Certificate of Registration for all of the types of work or crafts in which the bidder is a participant and that will be performed with the bidder's forces. Types of work or craft work that will be subcontracted shall be included and listed as subcontract work. The list shall also indicate any type of work or craft job category that does not have an applicable apprenticeship or training program. **The bidder is responsible for making a complete report and shall make certain that each type of work or craft job category that will be utilized on the project as reported on the Construction Employee Workforce Projection (Form BC-1256) and returned with the bid is accounted for and listed.**

The requirements of this certification and disclosure are a material part of the contract, and the contractor shall require this certification provision to be included in all approved subcontracts. In order to fulfill this requirement, it shall not be necessary that an applicable program sponsor be currently taking or that it will take applications for apprenticeship, training or employment during the performance of the work of this contract.

L. Executive Order Number 1 (2007) Regarding Lobbying on Government Procurements

The bidder hereby warrants and certifies that they have complied and will comply with the requirements set forth in this Order. The requirements of this warrant and certification are a material part of the contract, and the contractor shall require this warrant and certification provision to be included in all approved subcontracts.

RETURN WITH BID

M. Disclosure of Business Operations in Iran

Public Act 95-0616 provides that each bid, offer, or proposal submitted for a State contract shall include a disclosure of whether or not the Company acting as the bidder, offeror, or proposing entity, or any of its corporate parents or subsidiaries, within the 24 months before submission of the bid, offer, or proposal had business operations that involved contracts with or provision of supplies or services to the Government of Iran, companies in which the Government of Iran has any direct or indirect equity share, consortiums or projects commissioned by the Government of Iran, or companies involved in consortiums or projects commissioned by the Government of Iran and either of the following conditions apply:

- (1) More than 10% of the Company's revenues produced in or assets located in Iran involve oil-related activities or mineral-extraction activities; less than 75% of the Company's revenues produced in or assets located in Iran involve contracts with or provision of oil-related or mineral-extraction products or services to the Government of Iran or a project or consortium created exclusively by that government; and the Company has failed to take substantial action.
- (2) The Company has, on or after August 5, 1996, made an investment of \$20 million or more, or any combination of investments of at least \$10 million each that in the aggregate equals or exceeds \$20 million in any 12-month period, which directly or significantly contributes to the enhancement of Iran's ability to develop petroleum resources of Iran.

The terms "Business operations", "Company", "Mineral-extraction activities", "Oil-related activities", "Petroleum resources", and "Substantial action" are all defined in the Act.

Failure to make the disclosure required by the Act shall cause the bid, offer or proposal to be considered not responsive. The disclosure will be considered when evaluating the bid, offer, or proposal or awarding the contract. The name of each Company disclosed as doing business or having done business in Iran will be provided to the State Comptroller.

Check the appropriate statement:

Company has no business operations in Iran to disclose.

Company has business operations in Iran as disclosed the attached document.

TO BE RETURNED WITH BID

IV. DISCLOSURES

A. The disclosures hereinafter made by the bidder are each a material representation of fact upon which reliance is placed should the Department enter into the contract with the bidder. The Department may terminate the contract if it is later determined that the bidder rendered a false or erroneous disclosure, and the surety providing the performance bond shall be responsible for completion of the contract.

B. Financial Interests and Conflicts of Interest

1. Section 50-35 of the Illinois Procurement Code provides that all bids of more than \$10,000 shall be accompanied by disclosure of the financial interests of the bidder. This disclosed information for the successful bidder, will be maintained as public information subject to release by request pursuant to the Freedom of Information Act.

The financial interests to be disclosed shall include ownership or distributive income share that is in excess of 5%, or an amount greater than 60% of the annual salary of the Governor, of the bidding entity or its parent entity, whichever is less, unless the contractor or bidder is a publicly traded entity subject to Federal 10K reporting, in which case it may submit its 10K disclosure in place of the prescribed disclosure. If a bidder is a privately held entity that is exempt from Federal 10K reporting, but has more than 400 shareholders, it may submit the information that Federal 10K companies are required to report, and list the names of any person or entity holding any ownership share that is in excess of 5%. The disclosure shall include the names, addresses, and dollar or proportionate share of ownership of each person making the disclosure, their instrument of ownership or beneficial relationship, and notice of any potential conflict of interest resulting from the current ownership or beneficial interest of each person making the disclosure having any of the relationships identified in Section 50-35 and on the disclosure form.

In addition, all disclosures shall indicate any other current or pending contracts, proposals, leases, or other ongoing procurement relationships the bidding entity has with any other unit of state government and shall clearly identify the unit and the contract, proposal, lease, or other relationship.

2. Disclosure Forms. Disclosure Form A is attached for use concerning the individuals meeting the above ownership or distributive share requirements. Subject individuals should be covered each by one form. In addition, a second form (Disclosure Form B) provides for the disclosure of current or pending procurement relationships with other (non-IDOT) state agencies. **The forms must be included with each bid or incorporated by reference.**

C. Disclosure Form Instructions

Form A: For bidders that have previously submitted the information requested in Form A

The Department has retained the Form A disclosures submitted by all bidders responding to these requirements for the April 24, 1998 or any subsequent letting conducted by the Department. The bidder has the option of submitting the information again or the bidder may check the following certification statement indicating that the information previously submitted by the bidder is, as of the date of submission, current and accurate. Before checking this certification, the bidder should carefully review its prior submissions to ensure the Certification is correct. If the Bidder checks the Certification, the Bidder should proceed to Form B instructions.

CERTIFICATION STATEMENT

I have determined that the Form A disclosure information previously submitted is current and accurate, and all forms are hereby incorporated by reference in this bid. Any necessary additional forms or amendments to previously submitted forms are attached to this bid.

(Bidding Company)



Signature of Authorized Representative

Date

Form A: For bidders who have NOT previously submitted the information requested in Form A

If the bidder is a publicly traded entity subject to Federal 10K reporting, the 10K Report may be submitted to meet the requirements of Form A. If a bidder is a privately held entity that is exempt from Federal 10K reporting, but has more than 400 shareholders, it may submit the information that Federal 10K companies are required to report, and list the names of any person or entity holding any ownership share that is in excess of 5%. If a bidder is not subject to Federal 10K reporting, the bidder must determine if any individuals are required by law to complete a financial disclosure form. To do this, the bidder should answer each of the following questions. A "YES" answer indicates Form A must be completed. If the answer to each of the following questions is "NO", then the NOT APPLICABLE STATEMENT on the second page of Form A must be signed and dated by a person that is authorized to execute contracts for the bidding company. Note: These questions are for assistance only and are not required to be completed.

1. Does anyone in your organization have a direct or beneficial ownership share of greater than 5% of the bidding entity or parent entity? YES ___ NO ___
2. Does anyone in your organization have a direct or beneficial ownership share of less than 5%, but which has a value greater than \$102,600.00? YES ___ NO ___
3. Does anyone in your organization receive more than \$102,600.00 of the bidding entity's or parent entity's distributive income? (Note: Distributive income is, for these purposes, any type of distribution of profits. An annual salary is not distributive income.) YES ___ NO ___
4. Does anyone in your organization receive greater than 5% of the bidding entity's or parent entity's total distributive income, but which is less than \$102,600.00? YES ___ NO ___

(Note: Only one set of forms needs to be completed per person per bid even if a specific individual would require a yes answer to more than one question.)

A "YES" answer to any of these questions requires the completion of Form A. The bidder must determine each individual in the bidding entity or the bidding entity's parent company that would cause the questions to be answered "Yes". Each form must be signed and dated by a person that is authorized to execute contracts for your organization. **Photocopied or stamped signatures are not acceptable.** The person signing can be, but does not have to be, the person for which the form is being completed. The bidder is responsible for the accuracy of any information provided.

If the answer to each of the above questions is "NO", then the NOT APPLICABLE STATEMENT on page 2 of Form A must be signed and dated by a person that is authorized to execute contracts for your company.

Form B: Identifying Other Contracts & Procurement Related Information Disclosure Form B must be completed for each bid submitted by the bidding entity. Note: *Checking the NOT APPLICABLE STATEMENT on Form A does not allow the bidder to ignore Form B. Form B must be completed, checked, and dated or the bidder may be considered nonresponsive and the bid will not be accepted.*

The Bidder shall identify, by checking Yes or No on Form B, whether it has any pending contracts (including leases), bids, proposals, or other ongoing procurement relationship with any other (non-IDOT) State of Illinois agency. If "No" is checked, the bidder only needs to complete the check box on the bottom of Form B. If "Yes" is checked, the bidder must do one of the following:

Option I: If the bidder did not submit an Affidavit of Availability to obtain authorization to bid, the bidder must list all non-IDOT State of Illinois agency pending contracts, leases, bids, proposals, and other ongoing procurement relationships. These items may be listed on Form B or on an attached sheet(s). Do not include IDOT contracts. Contracts with cities, counties, villages, etc. are not considered State of Illinois agency contracts and are not to be included. Contracts with other State of Illinois agencies such as the Department of Natural Resources or the Capital Development Board must be included. Bidders who submit Affidavits of Availability are suggested to use Option II.

Option II: If the bidder is required and has submitted an Affidavit of Availability in order to obtain authorization to bid, the bidder may write or type "See Affidavit of Availability" which indicates that the Affidavit of Availability is incorporated by reference and includes all non-IDOT State of Illinois agency pending contracts, leases, bids, proposals, and other ongoing procurement relationships. For any contracts that are not covered by the Affidavit of Availability, the bidder must identify them on Form B or on an attached sheet(s). These might be such things as leases.

D. Bidders Submitting More Than One Bid

Bidders submitting multiple bids may submit one set of forms consisting of all required Form A disclosures and one Form B for use with all bids. Please indicate in the space provided below the bid item that contains the original disclosure forms and the bid items which incorporate the forms by reference.

- The bid submitted for letting item _____ contains the Form A disclosures or Certification Statement and the Form B disclosures. The following letting items incorporate the said forms by reference:

**ILLINOIS DEPARTMENT
OF TRANSPORTATION**

**Form A
Financial Information &
Potential Conflicts of Interest
Disclosure**

Contractor Name		
Legal Address		
City, State, Zip		
Telephone Number	Email Address	Fax Number (if available)

Disclosure of the information contained in this Form is required by the Section 50-35 of the Illinois Procurement Code (30 ILCS 500). Vendors desiring to enter into a contract with the State of Illinois must disclose the financial information and potential conflict of interest information as specified in this Disclosure Form. This information shall become part of the publicly available contract file. This Form A must be completed for bids in excess of \$10,000, and for all open-ended contracts. **A publicly traded company may submit a 10K disclosure (or equivalent if applicable) in satisfaction of the requirements set forth in Form A. See Disclosure Form Instructions.**

DISCLOSURE OF FINANCIAL INFORMATION

1. Disclosure of Financial Information. The individual named below has an interest in the BIDDER (or its parent) in terms of ownership or distributive income share in excess of 5%, or an interest which has a value of more than \$102,600.00 (60% of the Governor's salary as of 7/1/07). **(Make copies of this form as necessary and attach a separate Disclosure Form A for each individual meeting these requirements)**

FOR INDIVIDUAL (type or print information)

NAME: _____

ADDRESS _____

Type of ownership/distributable income share:

stock _____ sole proprietorship _____ Partnership _____ other: (explain on separate sheet):
% or \$ value of ownership/distributable income share: _____

2. Disclosure of Potential Conflicts of Interest. Check "Yes" or "No" to indicate which, if any, of the following potential conflict of interest relationships apply. If the answer to any question is "Yes", please attach additional pages and describe.

(a) State employment, currently or in the previous 3 years, including contractual employment of services. Yes ___ No ___

If your answer is yes, please answer each of the following questions.

1. Are you currently an officer or employee of either the Capitol Development Board or the Illinois Toll Highway Authority? Yes ___ No ___
2. Are you currently appointed to or employed by any agency of the State of Illinois? If you are currently appointed to or employed by any agency of the State of Illinois, and your annual salary exceeds \$102,600.00, (60% of the Governor's salary as of 7/1/07) provide the name the State agency for which you are employed and your annual salary. _____

RETURN WITH BID/OFFER

- 3. If you are currently appointed to or employed by any agency of the State of Illinois, and your annual salary exceeds \$102,600.00, (60% of the Governor's salary as of 7/1/07) are you entitled to receive (i) more than 7 1/2% of the total distributable income of your firm, partnership, association or corporation, or (ii) an amount in excess of the salary of the Governor? Yes ___ No ___
- 4. If you are currently appointed to or employed by any agency of the State of Illinois, and your annual salary exceeds \$102,600.00, (60% of the Governor's salary as of 7/1/07) are you and your spouse or minor children entitled to receive (i) more than 15 % in the aggregate of the total distributable income of your firm, partnership, association or corporation, or (ii) an amount in excess of 2 times the salary of the Governor? Yes ___ No ___

(b) State employment of spouse, father, mother, son, or daughter, including contractual employment services in the previous 2 years.

Yes ___ No ___

If your answer is yes, please answer each of the following questions.

- 1. Is your spouse or any minor children currently an officer or employee of the Capitol Development Board or the Illinois Toll Highway Authority? Yes ___ No ___
- 2. Is your spouse or any minor children currently appointed to or employed by any agency of the State of Illinois? If your spouse or minor children is/are currently appointed to or employed by any agency of the State of Illinois, and his/her annual salary exceeds \$102,600.00, (60 % of the Governor's salary as of 7/1/07) provide the name of your spouse and/or minor children, the name of the State agency for which he/she is employed and his/her annual salary. _____

- 3. If your spouse or any minor children is/are currently appointed to or employed by any agency of the State of Illinois, and his/her annual salary exceeds \$102,600.00, (60% of the salary of the Governor as of 7/1/07) are you entitled to receive (i) more then 71/2% of the total distributable income of your firm, partnership, association or corporation, or (ii) an amount in excess of the salary of the Governor? Yes ___ No ___
- 4. If your spouse or any minor children are currently appointed to or employed by any agency of the State of Illinois, and his/her annual salary exceeds \$102,600.00, (60% of the Governor's salary as of 7/1/07) are you and your spouse or minor children entitled to receive (i) more than 15 % in the aggregate of the total distributable income of your firm, partnership, association or corporation, or (ii) an amount in excess of 2 times the salary of the Governor? Yes ___ No ___

(c) Elective status; the holding of elective office of the State of Illinois, the government of the United States, any unit of local government authorized by the Constitution of the State of Illinois or the statutes of the State of Illinois currently or in the previous 3 years.

Yes ___ No ___

(d) Relationship to anyone holding elective office currently or in the previous 2 years; spouse, father, mother, son, or daughter.

Yes ___ No ___

(e) Appointive office; the holding of any appointive government office of the State of Illinois, the United States of America, or any unit of local government authorized by the Constitution of the State of Illinois or the statutes of the State of Illinois, which office entitles the holder to compensation in excess of the expenses incurred in the discharge of that office currently or in the previous 3 years.

Yes ___ No ___

(f) Relationship to anyone holding appointive office currently or in the previous 2 years; spouse, father, mother, son, or daughter.

Yes ___ No ___

(g) Employment, currently or in the previous 3 years, as or by any registered lobbyist of the State government.

Yes ___ No ___

RETURN WITH BID/OFFER

(h) Relationship to anyone who is or was a registered lobbyist in the previous 2 years; spouse, father, mother, son, or daughter. Yes ___ No ___

(i) Compensated employment, currently or in the previous 3 years, by any registered election or reelection committee registered with the Secretary of State or any county clerk of the State of Illinois, or any political action committee registered with either the Secretary of State or the Federal Board of Elections. Yes ___ No ___

(j) Relationship to anyone; spouse, father, mother, son, or daughter; who was a compensated employee in the last 2 years by any registered election or re-election committee registered with the Secretary of State or any county clerk of the State of Illinois, or any political action committee registered with either the Secretary of State or the Federal Board of Elections. Yes ___ No ___

APPLICABLE STATEMENT

This Disclosure Form A is submitted on behalf of the INDIVIDUAL named on previous page.

Completed by: _____ Date _____
Signature of Individual or Authorized Representative

NOT APPLICABLE STATEMENT

I have determined that no individuals associated with this organization meet the criteria that would require the completion of this Form A.

This Disclosure Form A is submitted on behalf of the CONTRACTOR listed on the previous page.

_____ Date _____
Signature of Authorized Representative

RETURN WITH BID/OFFER

ILLINOIS DEPARTMENT
OF TRANSPORTATION

Form B
Other Contracts &
Procurement Related Information
Disclosure

Contractor Name		
Legal Address		
City, State, Zip		
Telephone Number	Email Address	Fax Number (if available)

Disclosure of the information contained in this Form is required by the Section 50-35 of the Illinois Procurement Act (30 ILCS 500). This information shall become part of the publicly available contract file. This Form B must be completed for bids in excess of \$10,000, and for all open-ended contracts.

DISCLOSURE OF OTHER CONTRACTS AND PROCUREMENT RELATED INFORMATION

1. Identifying Other Contracts & Procurement Related Information. The BIDDER shall identify whether it has any pending contracts (including leases), bids, proposals, or other ongoing procurement relationship with any other State of Illinois agency: Yes ___ No ___

If "No" is checked, the bidder only needs to complete the signature box on the bottom of this page.

2. If "Yes" is checked. Identify each such relationship by showing State of Illinois agency name and other descriptive information such as bid or project number (attach additional pages as necessary). SEE DISCLOSURE FORM INSTRUCTIONS:

THE FOLLOWING STATEMENT MUST BE CHECKED

<input type="checkbox"/>	_____	_____
	Signature of Authorized Representative	Date

RETURN WITH BID

SPECIAL NOTICE TO CONTRACTORS

The following requirements of the Illinois Department of Human Rights' Rules and Regulations are applicable to bidders on all construction contracts advertised by the Illinois Department of Transportation:

CONSTRUCTION EMPLOYEE UTILIZATION PROJECTION

- (a) All bidders on construction contracts shall complete and submit, along with and as part of their bids, a Bidder's Employee Utilization Form (Form BC-1256) setting forth a projection and breakdown of the total workforce intended to be hired and/or allocated to such contract work by the bidder including a projection of minority and female employee utilization in all job classifications on the contract project.
- (b) The Department of Transportation shall review the Employee Utilization Form, and workforce projections contained therein, of the contract awardee to determine if such projections reflect an underutilization of minority persons and/or women in any job classification in accordance with the Equal Employment Opportunity Clause and Section 7.2 of the Illinois Department of Human Rights' Rules and Regulations for Public Contracts adopted as amended on September 17, 1980. If it is determined that the contract awardee's projections reflect an underutilization of minority persons and/or women in any job classification, it shall be advised in writing of the manner in which it is underutilizing and such awardee shall be considered to be in breach of the contract unless, prior to commencement of work on the contract project, it submits revised satisfactory projections or an acceptable written affirmative action plan to correct such underutilization including a specific timetable geared to the completion stages of the contract.
- (c) The Department of Transportation shall provide to the Department of Human Rights a copy of the contract awardee's Employee Utilization Form, a copy of any required written affirmative action plan, and any written correspondence related thereto. The Department of Human Rights may review and revise any action taken by the Department of Transportation with respect to these requirements.



**Contract No. 60E15
Various Counties
Section 2008-002TS
Various Routes
District 1 Formal Contracts**

PART I. IDENTIFICATION

Dept. Human Rights # _____ Duration of Project: _____
Name of Bidder: _____

PART II. WORKFORCE PROJECTION

A. The undersigned bidder has analyzed minority group and female populations, unemployment rates and availability of workers for the location in which this contract work is to be performed, and for the locations from which the bidder recruits employees, and hereby submits the following workforce projection including a projection for minority and female employee utilization in all job categories in the workforce to be allocated to this contract:

TABLE A

TOTAL Workforce Projection for Contract												
JOB CATEGORIES	TOTAL EMPLOYEES		MINORITY EMPLOYEES						TRAINEES			
	M	F	BLACK		HISPANIC		*OTHER MINOR.		APPRENTICES		ON THE JOB TRAINEES	
			M	F	M	F	M	F	M	F	M	F
OFFICIALS (MANAGERS)												
SUPERVISORS												
FOREMEN												
CLERICAL												
EQUIPMENT OPERATORS												
MECHANICS												
TRUCK DRIVERS												
IRONWORKERS												
CARPENTERS												
CEMENT MASONS												
ELECTRICIANS												
PIPEFITTERS, PLUMBERS												
PAINTERS												
LABORERS, SEMI-SKILLED												
LABORERS, UNSKILLED												
TOTAL												

TABLE B

CURRENT EMPLOYEES TO BE ASSIGNED TO CONTRACT			
TOTAL EMPLOYEES		MINORITY EMPLOYEES	
M	F	M	F

TABLE C

TOTAL Training Projection for Contract								
EMPLOYEES IN TRAINING	TOTAL EMPLOYEES		BLACK		HISPANIC		*OTHER MINOR.	
	M	F	M	F	M	F	M	F
APPRENTICES								
ON THE JOB TRAINEES								

FOR DEPARTMENT USE ONLY

* Other minorities are defined as Asians (A) or Native Americans (N).
Please specify race of each employee shown in Other Minorities column.

Note: See instructions on page 2

RETURN WITH BID

**Contract No. 60E15
Various Counties
Section 2008-002TS
Various Routes
District 1 Formal Contracts**

PART II. WORKFORCE PROJECTION - continued

B. Included in "Total Employees" under Table A is the total number of **new hires** that would be employed in the event the undersigned bidder is awarded this contract.

The undersigned bidder projects that: (number) _____ new hires would be recruited from the area in which the contract project is located; and/or (number) _____ new hires would be recruited from the area in which the bidder's principal office or base of operation is located.

C. Included in "Total Employees" under Table A is a projection of numbers of persons to be employed directly by the undersigned bidder as well as a projection of numbers of persons to be employed by subcontractors.

The undersigned bidder estimates that (number) _____ persons will be directly employed by the prime contractor and that (number) _____ persons will be employed by subcontractors.

PART III. AFFIRMATIVE ACTION PLAN

A. The undersigned bidder understands and agrees that in the event the foregoing minority and female employee utilization projection included under **PART II** is determined to be an underutilization of minority persons or women in any job category, and in the event that the undersigned bidder is awarded this contract, he/she will, prior to commencement of work, develop and submit a written Affirmative Action Plan including a specific timetable (geared to the completion stages of the contract) whereby deficiencies in minority and/or female employee utilization are corrected. Such Affirmative Action Plan will be subject to approval by the contracting agency and the **Department of Human Rights**.

B. The undersigned bidder understands and agrees that the minority and female employee utilization projection submitted herein, and the goals and timetable included under an Affirmative Action Plan if required, are deemed to be part of the contract specifications.

Company _____ Telephone Number _____

Address _____

NOTICE REGARDING SIGNATURE

The Bidder's signature on the Proposal Signature Sheet will constitute the signing of this form. The following signature block needs to be completed if revisions are required.

Signature: _____ Title: _____ Date: _____

- Instructions: All tables must include subcontractor personnel in addition to prime contractor personnel.
- Table A - Include both the number of employees that would be hired to perform the contract work and the total number currently employed (Table B) that will be allocated to contract work, and include all apprentices and on-the-job trainees. The "Total Employees" column should include all employees including all minorities, apprentices and on-the-job trainees to be employed on the contract work.
- Table B - Include all employees currently employed that will be allocated to the contract work including any apprentices and on-the-job trainees currently employed.
- Table C - Indicate the racial breakdown of the total apprentices and on-the-job trainees shown in Table A.

RETURN WITH BID

**Contract No. 60E15
Various Counties
Section 2008-002TS
Various Routes
District 1 Formal Contracts**

PROPOSAL SIGNATURE SHEET

The undersigned bidder hereby makes and submits this bid on the subject Proposal, thereby assuring the Department that all requirements of the Invitation for Bids and rules of the Department have been met, that there is no misunderstanding of the requirements of paragraph 3 of this Proposal, and that the contract will be executed in accordance with the rules of the Department if an award is made on this bid.

Firm Name _____
(IF AN INDIVIDUAL) Signature of Owner _____
Business Address _____

Firm Name _____
By _____
(IF A CO-PARTNERSHIP) Business Address _____

Name and Address of All Members of the Firm:

Corporate Name _____
By _____
Signature of Authorized Representative

Typed or printed name and title of Authorized Representative
(IF A CORPORATION) Attest _____
Signature
(IF A JOINT VENTURE, USE THIS SECTION
FOR THE MANAGING PARTY AND THE
SECOND PARTY SHOULD SIGN BELOW) Business Address _____

Corporate Name _____
By _____
Signature of Authorized Representative

Typed or printed name and title of Authorized Representative
(IF A JOINT VENTURE) Attest _____
Signature
Business Address _____

If more than two parties are in the joint venture, please attach an additional signature sheet.



Return with Bid

Division of Highways
Proposal Bid Bond
(Effective November 1, 1992)

Item No. _____

Letting Date _____

KNOW ALL MEN BY THESE PRESENTS, That We _____

as PRINCIPAL, and _____

_____ as SURETY, are held jointly, severally and firmly bound unto the STATE OF ILLINOIS in the penal sum of 5 percent of the total bid price, or for the amount specified in Article 102.09 of the "Standard Specifications for Road and Bridge Construction" in effect on the date of invitation for bids, whichever is the lesser sum, well and truly to be paid unto said STATE OF ILLINOIS, for the payment of which we bind ourselves, our heirs, executors, administrators, successors and assigns.

THE CONDITION OF THE FOREGOING OBLIGATION IS SUCH, that whereas, the PRINCIPAL has submitted a bid proposal to the STATE OF ILLINOIS, acting through the Department of Transportation, for the improvement designated by the Transportation Bulletin Item Number and Letting Date indicated above.

NOW, THEREFORE, if the Department shall accept the bid proposal of the PRINCIPAL; and if the PRINCIPAL shall, within the time and as specified in the bidding and contract documents, submit a DBE Utilization Plan that is accepted and approved by the Department; and if, after award by the Department, the PRINCIPAL shall enter into a contract in accordance with the terms of the bidding and contract documents including evidence of the required insurance coverages and providing such bond as specified with good and sufficient surety for the faithful performance of such contract and for the prompt payment of labor and material furnished in the prosecution thereof; or if, in the event of the failure of the PRINCIPAL to make the required DBE submission or to enter into such contract and to give the specified bond, the PRINCIPAL pays to the Department the difference not to exceed the penalty hereof between the amount specified in the bid proposal and such larger amount for which the Department may contract with another party to perform the work covered by said bid proposal, then this obligation shall be null and void, otherwise, it shall remain in full force and effect.

IN THE EVENT the Department determines the PRINCIPAL has failed to comply with any requirement as set forth in the preceding paragraph, then Surety shall pay the penal sum to the Department within fifteen (15) days of written demand therefor. If Surety does not make full payment within such period of time, the Department may bring an action to collect the amount owed. Surety is liable to the Department for all its expenses, including attorney's fees, incurred in any litigation in which it prevails either in whole or in part.

In TESTIMONY WHEREOF, the said PRINCIPAL and the said SURETY have caused this instrument to be signed by their respective officers this _____ day of _____ A.D., _____.

PRINCIPAL

(Company Name)

(Company Name)

By: _____
(Signature & Title)

By: _____
(Signature of Attorney-in-Fact)

Notary Certification for Principal and Surety

STATE OF ILLINOIS,

County of _____

I, _____, a Notary Public in and for said County, do hereby certify that

_____ and _____
(Insert names of individuals signing on behalf of PRINCIPAL & SURETY)

who are each personally known to me to be the same persons whose names are subscribed to the foregoing instrument on behalf of PRINCIPAL and SURETY, appeared before me this day in person and acknowledged respectively, that they signed and delivered said instrument as their free and voluntary act for the uses and purposes therein set forth.

Given under my hand and notarial seal this _____ day of _____ A.D. _____

My commission expires _____

Notary Public

In lieu of completing the above section of the Proposal Bid Form, the Principal may file an Electronic Bid Bond. By signing the proposal and marking the check box next to the Signature and Title line below, the Principal is ensuring the identified electronic bid bond has been executed and the Principal and Surety are firmly bound unto the State of Illinois under the conditions of the bid bond as shown above.

Electronic Bid Bond ID# _____

Company / Bidder Name _____

Signature and Title _____

PROPOSAL ENVELOPE



PROPOSALS

for construction work advertised for bids by the
Illinois Department of Transportation

Item No.	Item No.	Item No.

Submitted By:

Name:
Address:
Phone No.

Bidders should use an IDOT proposal envelope or affix this form to the front of a 10" x 13" envelope for the submittal of bids. If proposals are mailed, they should be enclosed in a second or outer envelope addressed to:

Engineer of Design and Environment - Room 326
Illinois Department of Transportation
2300 South Dirksen Parkway
Springfield, Illinois 62764

NOTICE

Individual bids, including Bid Bond and/or supplemental information if required, should be securely stapled.

CONTRACTOR OFFICE COPY OF CONTRACT SPECIFICATIONS

NOTICE

None of the following material needs to be returned with the bid package unless the special provisions require documentation and/or other information to be submitted.

Contract No. 60E15
Various Counties
Section 2008-002TS
Various Routes
District 1 Formal Contracts



Illinois Department of Transportation



NOTICE TO BIDDERS

1. **TIME AND PLACE OF OPENING BIDS.** Sealed proposals for the improvement described herein will be received by the Department of Transportation at the Harry R. Hanley Building, 2300 South Dirksen Parkway, in Springfield, Illinois until 10:00 o'clock a.m., September 19, 2008. All bids will be gathered, sorted, publicly opened and read in the auditorium at the Department of Transportation's Harry R. Hanley Building shortly after the 10:00 a.m. cut off time.

2. **DESCRIPTION OF WORK.** The proposed improvement is identified and advertised for bids in the Invitation for Bids as:

**Contract No. 60E15
Various Counties
Section 2008-002TS
Various Routes
District 1 Formal Contracts**

Annual maintenance of traffic signals, highway lighting, pump stations, surveillance and other electrical systems located in District One.

3. **INSTRUCTIONS TO BIDDERS.** (a) This Notice, the invitation for bids, proposal and letter of award shall, together with all other documents in accordance with Article 101.09 of the Standard Specifications for Road and Bridge Construction, become part of the contract. Bidders are cautioned to read and examine carefully all documents, to make all required inspections, and to inquire or seek explanation of the same prior to submission of a bid.

(b) State law, and, if the work is to be paid wholly or in part with Federal-aid funds, Federal law requires the bidder to make various certifications as a part of the proposal and contract. By execution and submission of the proposal, the bidder makes the certification contained therein. A false or fraudulent certification shall, in addition to all other remedies provided by law, be a breach of contract and may result in termination of the contract.

4. **AWARD CRITERIA AND REJECTION OF BIDS.** This contract will be awarded to the lowest responsive and responsible bidder considering conformity with the terms and conditions established by the Department in the rules, Invitation for Bids and contract documents. The issuance of plans and proposal forms for bidding based upon a prequalification rating shall not be the sole determinant of responsibility. The Department reserves the right to determine responsibility at the time of award, to reject any or all proposals, to readvertise the proposed improvement, and to waive technicalities.

By Order of the
Illinois Department of Transportation

Milton R. Sees, Secretary

BD 351 (Rev. 01/2003)

STATE OF ILLINOIS
DEPARTMENT OF TRANSPORTATION
DISTRICT 1 ELECTRICAL MAINTENANCE CONTRACT
60E15
FOR YEARS 2009-2010

SECTION 1

ARTICLE 1.0	Instruction to Bidders and Pre-Qualification Submittals
ARTICLE 2.0	Definitions, Specifications & Standards
ARTICLE 3.0	Pre-Construction Submittals
ARTICLE 4.0	General Contract Requirements
ARTICLE 5.0	Routine Maintenance Work and Payment
ARTICLE 6.0	Non-Routine Maintenance Work and Payment
ARTICLE 7.0	Lighting, Navigation and Sign Illumination System
ARTICLE 8.0	Pump Station System
ARTICLE 9.0	Surveillance and Dynamic Message Sign Systems
ARTICLE 10.0	Traffic Signal System
ARTICLE 11.0	Extra Systems

SECTION 2

SYSTEM SPECIFICATIONS:

GENERAL SYSTEM
LIGHTING, NAVIGATION AND SIGN ILLUMINATION SYSTEM
PUMP STATION SYSTEM
SURVEILLANCE AND DYNAMIC MESSAGE SIGN SYSTEM
TRAFFIC SIGNAL SYSTEM
EXTRA SYSTEMS

SECTION 3

LIST OF LOCATIONS

SECTION 4

BDE SPECIAL PROVISIONS

INDEX
FOR
SUPPLEMENTAL SPECIFICATIONS
AND RECURRING SPECIAL PROVISIONS

Adopted January 1, 2008

This index contains a listing of SUPPLEMENTAL SPECIFICATIONS and frequently used RECURRING SPECIAL PROVISIONS.

ERRATA Standard Specifications for Road and Bridge Construction (Adopted 1-1-07) (Revised 1-1-08)

SUPPLEMENTAL SPECIFICATIONS

<u>Std. Spec. Sec.</u>		<u>Page No.</u>
205	Embankment	1
251	Mulch	2
253	Planting Woody Plants.....	3
280	Temporary Erosion Control	5
443	Reflective Crack Control Treatment	6
502	Excavation for Structures.....	9
503	Concrete Structures	10
505	Steel Structures	11
540	Box Culverts	12
633	Removing and Reerecting Guardrail and Terminals.....	13
672	Sealing Abandoned Water Wells	14
701	Work Zone Traffic Control and Protection.....	15
838	Breakaway Devices.....	16
1004	Coarse Aggregates	17
1020	Portland Cement Concrete	18
1022	Concrete Curling Materials.....	20
1042	Precast Concrete Products.....	21
1062	Reflective Crack Control System.....	22
1069	Pole and Tower	24
1081	Materials for Planting.....	27
1083	Elastomeric Bearings	29
1102	Hot-Mix Asphalt Equipment.....	30

RECURRING SPECIAL PROVISIONS

The following RECURRING SPECIAL PROVISIONS indicated by an “X” are applicable to this contract and are included by reference:

<u>CHECK SHEET #</u>	<u>PAGE NO.</u>
1	31
2	33
3 X	34
4 X	44
5 X	49
6	54
7	55
8	56
9	57
10	60
11	63
12	65
13	69
14	71
15	72
16	74
17	75
18	77
19	78
20	79
21	83
22	85
23	87
24 X	89
25 X	90
26	91
27	92
28	93
29	94
30	100
31	108

STATE OF ILLINOIS
DEPARTMENT OF TRANSPORTATION
DISTRICT 1 ELECTRICAL MAINTENANCE CONTRACT
60E15
FOR YEARS 2009-2010

SCHEDULE OF PRICES.....	27
ARTICLE 1.0 -- INSTRUCTIONS TO BIDDERS AND PRE-QUALIFICATION SUBMITTALS.....	48
1.1 Description of Work.....	48
1.2 Schedule of Prices – Submittal (For Attached Bidding Sheets)	48
1.3 Pre-Bid Meeting	49
1.4 Site Inspections	49
1.5 Examination Of Plans, Specifications, Special Provisions, And Site Of Work	49
1.6 Proposal Guaranty	49
1.7 Requirement Of Contract Bond.....	50
1.8 Insurance.....	50
1.9 Bidders’ Special Qualifications Submittal	51
ARTICLE 2.0 -- DEFINITIONS, SPECIFICATIONS & STANDARDS	53
ARTICLE 3.0 – PRE-CONSTRUCTION SUBMITTALS	60
ARTICLE 4.0 -- GENERAL CONTRACT REQUIREMENTS	62
4.1 Basic Contract Provisions.....	62

4.1.1	Term of Contract.....	62
4.1.2	Renewal.....	62
4.1.3	Completion Of Annual Work.....	63
4.1.4	De-Authorization and/or Cancellation of Work.....	63
4.2	Subcontracting of Work	63
4.2.1	General Requirements	63
4.2.2	Subcontracting Limitations.....	64
4.2.3	Subcontractor Billing.....	64
4.3	Contract Transition	64
4.3.1	Basic Requirements.....	64
4.3.2	Electrical System Survey	65
4.3.3	State Stock Transfer	65
4.3.4	Contractor Owned Spare Parts Procurement	65
4.3.5	Locks and Keys.....	65
4.3.6	End of Contract Transition	65
4.4	Contractor Performance.....	65
4.4.1	Priority of Work.....	65
4.4.2	Suspension Of Work	66
4.4.3	Unsatisfactory Service.....	66
4.4.4	Withholding and Release of Funds	66
4.4.5	Liquidated Damages	66
4.5	Contractor Facility Requirements	67
4.5.1	General Requirements	67
4.5.2	EMC Office.....	67
4.5.3	EMC Dispatch Center.....	68
4.5.4	Equipment Service Shop.....	68
4.5.5	Storage Facilities	68

4.6	Communication Equipment	69
4.6.1	Wireless Field Communication Systems	69
4.6.2	Voice and Data Communication Lines	70
4.6.3	Supervisory Control And Data Access System (SCADA).....	71
4.6.4	AEGIS Alarm System	72
4.6.5	CLMS	72
4.6.6	EMCMS – Electrical Maintenance Contract Management System	72
4.7	Contract Administration And Correspondence	76
4.7.1	Daily Contract Administration	76
4.7.2	Formal Correspondence	76
4.7.3	Informal Correspondence.....	76
4.8	Contract Personnel.....	77
4.8.1	General Responsibilities	77
4.8.2	General Workforce Responsibilities.....	77
4.8.3	Organizational Documentation	78
4.8.4	Principal (Owner) or Project Manager Responsibilities.....	78
4.8.5	System Manager Responsibilities.....	79
4.9	Dedicated Personnel Positions.....	79
4.9.1	Responsibilities of Dedicated Personnel	79
4.9.2	EMC Administrative Manager	80
4.9.3	Lighting And Repair Manager.....	80
4.9.4	Lighting Night-Rider Patrolman	81
4.9.5	Pump Station Specialist (Working Foreman).....	81
4.9.6	Pump Station Service Crew.....	81
4.9.7	Repair Crew.....	82
4.9.8	SCADA Specialist.....	83
4.9.9	SCADA Trainee.....	83

4.9.10	Surveillance/DMS Specialist (Working Foreman)	84
4.9.11	Surveillance/DMS Patrolmen	84
4.9.12	Traffic Signal System Manager	85
4.9.13	Surveillance/DMS Crew Trainee	86
4.10	Assigned Contract Personnel Positions	86
4.10.1	Responsibilities of Assigned Contract Personnel	86
4.10.2	Dispatch Center Supervisor	86
4.10.3	Dispatch Center Personnel	87
4.10.4	EMC Administrative Assistant	87
4.10.5	Equipment Service Shop Personnel	87
4.10.6	Patrolmen	88
4.10.7	Pump Station System Manager	88
4.10.8	Traffic Signal Systems/Railroad Specialist	89
4.10.9	Traffic Signal Systems Trainee	90
4.11	Personnel Documentation	90
4.12	Personnel Training Programs	90
4.12.1	General Requirements	91
4.12.2	OSHA and Other Safety Training	91
4.12.3	National Electrical Code/Grounding/Lightning Protection	91
4.12.4	Equipment/System Training	91
4.13	Safety Programs and Requirements	93
4.13.1	General Requirements	93
4.13.2	Confined Space Entry And Training	94
4.13.3	Hazardous Materials Operations	94
4.14	Traffic Control And Safety	95
4.14.1	Traffic Control Plan	95
4.14.2	Keeping the Expressway Open to Traffic	95

4.14.3	Payment for Traffic Control	96
4.14.4	Traffic Control Deficiencies and Liquidated Damages.....	96
4.15	Vehicles	96
4.15.1	General Requirements	96
4.15.2	Vehicles For Traffic Signal Patrolmen.....	97
4.15.3	Vehicles for Surveillance System Patrolmen, Specialist, & Trainee.....	98
4.15.4	Vehicles for System Managers, TS and SCADA Specialists.....	99
4.15.5	Vehicles for TS and SCADA Specialist Trainees.....	100
4.15.6	PS Specialist, PS Crew and Lighting System Night-Patrolman:.....	100
4.16	Equipment for Maintenance Operations.....	101
4.17	Construction Test Equipment	102
ARTICLE 5.0 -- ROUTINE MAINTENANCE WORK AND PAYMENT		105
5.1	Control of Work	105
5.2	Priority of Work.....	106
5.3	Contractor Emergency Response.....	106
5.4	Contractor Call-Out Policy	107
5.5	Special Response Situations.....	107
5.5.1	Unauthorized Access or Tampering Of Idot Property.....	107
5.5.2	Vandalism	107
5.5.3	Intrusion at Facilities and/or Theft of Idot Property	107
5.6	Locating Cable or Other Components of IDOT Systems	108
5.7	Providing System Services.....	108
5.8	General Maintenance Work.....	108
5.9	Repair of Damaged or Malfunctioning System Equipment	109
5.9.1	General Requirements	109
5.9.2	Damage Caused by Department Personnel.....	109
5.9.3	Damage Caused By Construction (3 RD Party Damage).....	109

5.9.4	Work Request Made by 3rd Party	110
5.9.5	Damage Caused by Motorists.....	110
5.10	Patrol Inspections.....	111
5.10.1	Patrol of Systems	111
5.10.2	Night Outage Patrol Survey	111
5.10.3	Red-Light Running Camera Survey and GPS Survey	112
5.11	Coordination with Electric Utility Companies, Contractors, and Others.....	113
5.12	Formal Transfer of Maintenance.....	113
5.13	Routine Maintenance Submittals and Documentation	114
5.13.1	Daily Work Agenda.....	114
5.13.2	Release of Dedicated Personnel.....	114
5.13.3	Dispatch and Call Out Schedule	115
5.13.4	Contractor Advisory	115
5.13.5	EMC Tickets.....	115
5.13.6	Plan Records Management.....	116
5.13.7	Monthly Routine Work Documentation Submittal.....	117
5.14	State Stock	118
5.14.1	General Requirements	118
5.14.2	Disbursement of State Stock.....	118
5.14.3	Receipt of State Stock	118
5.14.4	Disposal of Scrap	119
5.14.5	State Stock Documentation	119
5.14.6	State Stock Documentation	120
5.15	Contractor Spare Parts Inventory Responsibilities	120
5.15.1	Suggested Starting Quantities Of Contractor Owned Parts For The Lighting System	120
5.15.2	Suggested Starting Quantities of Contractor Owned Parts for The Pump Station System.....	122
5.15.3	Suggested Starting Quantities of Contractor Owned Parts for The Traffic Signal System:	122

5.16	Material and Equipment	123
5.16.1	Use of Approved Materials.....	123
5.16.2	Submittals for Approval.....	123
5.16.3	Forms	123
5.16.4	Certification Requirements	124
5.16.5	Samples	124
5.16.6	New Materials Inspection Requirements	124
5.17	Routine Maintenance Payment	124
5.17.1	Monthly Payment.....	124
5.17.2	Monthly Pay Meeting.....	125
6.1	Control of Work	126
6.1.1	Description of Work.....	126
6.1.2	Unit Price Authorizations.....	126
6.1.3	Agreed-Price Authorizations.....	126
6.1.4	Force Account Authorizations	127
6.1.5	Expenses Incurred By The Department.....	127
6.1.6	Transmittal of Non-Routine Work Assignments.....	128
6.2	Non-Routine Work Completion/Approval/Invoice Requirements.....	128
6.2.1	Completion Time.....	128
6.2.2	Work Completion Notification to The Engineer	128
6.2.3	Contractor EMCMS Work Completion Requirements.....	128
6.2.4	EMCMS Work Inspection Approval.....	128
6.2.5	EMCMS Corrective Work List.....	128
6.2.6	EMCMS Non-Routine Work Invoicing Procedures.....	128
6.2.7	Payment To Specialty Vendors	129
6.2.8	Payment for State Stock Warehouse Personnel	129

ARTICLE 7.0 -- LIGHTING, NAVIGATION AND SIGN ILLUMINATION SYSTEM130

7.1	System Description and Maintenance Responsibilities	130
7.2	Lighting System Routine Maintenance Pay Items.....	130
7.3	Response And Repair Time Requirements	130
7.4	Routine Maintenance Equipment Responsibilities.....	131
7.5	Lighting SCADA System	136
7.6	Monthly Daytime Tunnel Lighting Inspections.....	137
7.7	Monthly Lighting Installation Inventory Inspection.....	137
7.8	Monthly Faa Obstruction Light Inspection	137
7.9	Routine Maintenance Programs	137
7.9.1	Yearly Clock, Radio, and Exterior Cabinet Inspection	138
7.9.2	First Year Scada Backup Battery Replacement For Radio.....	138
7.9.3	Yearly Control Cabinet Inspection.....	138
7.9.4	Yearly Light Pole and Underpass Safety Inspection.....	139
7.9.5	Yearly Light Tower Safety Inspection.....	140
7.9.6	Annual Photo-Cell Calibration	140
7.10	Annual Lighting Controller Replacement.....	140
7.11	Non-Routine Maintenance.....	146
7.12	Logs and Forms.....	146
ARTICLE 8.0 -- PUMP STATION SYSTEM		146
8.1	Pump Station System Description.....	146
8.2	General Maintenance Responsibilities	146
8.3	Site Maintenance	147
8.4	Response Maintenance for PS System.....	147
8.4.1	Contractor PS Call-Out Response	147
8.4.2	Station Procedures and Response Documentation	148
8.4.3	PS Alarm Response	148
8.4.4	Station Pre-Storm Condition Check.....	149

8.4.5	Water on Pavement Situations.....	149
8.4.6	Station Post Storm Condition Check.....	149
8.4.7	Temporary Pumping Requirements.....	149
8.5	Service Companies	150
8.5.1	Submittals of Service Company Names.....	150
8.5.2	Service Company Work.....	150
8.6	Scheduled Daily Maintenance	150
8.6.1	Daily SCADA Maintenance.....	150
8.6.2	Daily AEGIS Maintenance	151
8.6.3	Documentation of Daily Scheduled Maintenance.....	152
8.7	Monthly PS Quick Check – All Stations	152
8.8	Monthly Preventive Maintenance Program.....	153
8.8.1	Monthly Pump Operation Inspection – All Stations	153
8.8.2	Monthly Pump Maintenance.....	153
8.8.3	Monthly Automatic Trash Rack Maintenance	153
8.8.4	Monthly Bar Screen Maintenance	154
8.8.5	Monthly Air Compressor Inspection.....	154
8.8.6	Monthly Flow Meter Inspection.....	154
8.8.7	Monthly Generator Inspection.....	154
8.8.8	Monthly Transfer Switch Operation Inspection	154
8.8.9	Monthly Air Induction Inspection	155
8.8.10	Monthly AEGIS Monthly Inspection – All Stations.....	155
8.8.11	Monthly State Stock Inventory Maintenance	155
8.9	Semi-Yearly Preventive Maintenance Programs.....	155
8.9.1	Semi-Yearly Dry Pit/Wet Pit Submersible Pump Maintenance.....	155
8.9.2	Semi-Yearly Automatic Trash Rack Maintenance.....	155
8.9.3	Semi-Yearly Vertical Pump Motor Maintenance.....	156

8.9.4	Semi-Yearly Actuators, Valves & Sluice Gate Operation – All Stations.....	156
8.9.5	Semi-Yearly Side Volute Discharge Pump Maintenance.....	156
8.10	Yearly Preventive Maintenance Programs	156
8.10.1	Yearly Air Induction Heater And Space Heater Inspection.....	156
8.10.2	Yearly AEGIS Alarm System Inspection - All Stations.....	156
8.10.3	Yearly SCADA Inspection.....	156
8.10.4	Yearly Wet Pit Inspection – All Stations.....	157
8.10.5	Yearly Pump Control System Inspection – All Stations	157
8.10.6	Yearly Pump Station Inspection And Maintenance – All Stations	158
8.10.7	Yearly Pump Capacity, Motor Current, Voltage, Moisture, Megger Test -	158
8.10.8	Yearly Impeller Adjustment Of Vertical Axial Flow Pumps	159
8.10.9	Yearly Submersible Pump Inspection	159
8.10.10	Yearly Oil Analysis - All Stations	159
8.10.11	Yearly Main Circuit Breaker Testing Inspection	160
8.10.12	Yearly Flow Meter Inspection.....	160
8.10.13	Yearly Fire Alarm Systems Inspection.....	161
8.10.14	Yearly Motor Control Center Inspection – All Stations	161
8.10.15	Tube Type Pump Maintenance – Year 2009 Only	162
8.10.16	Yeoman Pump Maintenance - Year 2010 Only	162
8.10.17	Yearly Generator Maintenance	162
8.10.18	Yearly Equipment Identification Program	163
8.11	Pump Station Non-Routine Maintenance:	163
8.12	Logs and Forms.....	163
8.13	Tables	163
ARTICLE 9.0 -- SURVEILLANCE AND DYNAMIC MESSAGE SIGN SYSTEMS		171
9.1	Surveillance and Dynamic Message Sign System Description	171
9.1.1	Surveillance Equipment.....	171

9.1.2	DMS System Equipment.....	171
9.1.3	Field Locations	171
9.1.4	Traffic Systems Center	171
9.1.5	IDOT Com Center.....	173
9.1.6	IDOT Station One (Springfield).....	173
9.1.7	General Maintenance Responsibilities	173
9.2	Response and Repair Time Requirements	174
9.3	Specific Maintenance Responsibilities.....	174
9.4	Daily Ticket Review	177
9.5	DMS Patrol Requirements	178
9.6	DMS Special Inventory Requirements	178
9.7	State Stock for The Surveillance System.....	179
9.8	Semi-Monthly Ramp Metering Cabinet Inspection	179
9.9	Monthly Ramp Metering Cleaning.....	180
9.10	Monthly Dms Cabinet Inspection And Cleaning.....	180
9.11	Monthly CCTV Inspection	181
9.12	Monthly Sign Enclosure Cleaning	181
9.13	Yearly Surveillance Cabinet Inspection and Cleaning	181
9.14	Yearly Sign Support Inspection	182
9.15	Yearly Grounding and Electric Service Upgrade.....	182
9.16	Surveillance Non-Routine Maintenance.....	184
9.17	Logs And Forms	184
ARTICLE 10.0 -- TRAFFIC SIGNAL SYSTEM		185
10.1	Traffic Signal System Description	185
10.1.1	Traffic Signals (Refer To Section 3, T-1a).....	185
10.1.2	Temporary Traffic Signal (Refer To Section 3, T-1b)	187
10.1.3	Flashing Overhead Mount Beacons (Refer To Section 3, T-2a).....	187

10.1.4	Flashing Low Mount Beacons (Refer To Section 3, T-2b)	187
10.2	General Maintenance Responsibilities	187
10.3	Response And Repair Time Requirements	188
10.4	Repair of Signal Lamp/Module Outages	189
10.5	Signal Damage Equipment Replacement	190
10.6	Power Outages And Flashing Operation Procedures	190
10.7	New, Revised or Transferred Traffic Signal And Flashing Beacon Inspections	190
10.8	Patrol Inspections	191
10.8.1	General Requirements	191
10.8.2	Routine Patrol Duties and Responsibilities	192
10.8.3	Controller and Cabinet Inspections	193
10.9	Site Maintenance	193
10.10	Group Relamping of Flashing Beacon and Traffic Signal Locations	194
10.10.1	Schedules and Reports	194
10.10.2	Daily Reports	194
10.10.3	Lens Cleaning and Replacement	194
10.10.4	Special Types of Lamps Required for Special Indications	194
10.10.5	Specification of Lamps	195
10.10.6	Lamp Disposal	195
10.10.7	Led Relamping	195
10.11	Annual Conflict Monitor Testing Program	196
10.12	Annual Mast Arm Assembly and Pole Inspection	196
10.13	Annual Railroad Interconnected Traffic Signal Inspection	197
10.14	Detector Loop Maintenance and Replacement	197
10.14.1	Traffic Signal Loop Resealing	197
10.14.2	Detector Loop Replacement	197
10.15	Video Detection	198

10.16	Integrated Closed-Loop Traffic Signal Monitoring System (Clms)	198
10.16.1	Contractor Responsibilities	198
10.16.2	Department LAN and Software Support	198
10.16.3	Contractor Monitoring Duties for the CLMS	199
10.16.4	Responsibilities	199
10.17	Traffic Signal Inventory	201
10.18	Painting By Others On State Maintained Facilities	202
10.19	Traffic Signal Grounding And Electrical Service Upgrade	202
10.20	Railroad Insurance	205
10.21	Non-Routine Maintenance	205
10.21.1	Non-Routine Work in the Railroad Right-Of Way	205
10.22	Logs and Forms	205
ARTICLE 11.0 -- EXTRA SYSTEMS		206
11.1	Extra Systems Description	206
11.2	Inspection Of Service Entrance And Feeder Panels	206
11.3	Generator Inspection	206
11.4	Locations	206
11.4.1	Base Stations	207
11.4.2	Bridge Monitoring	207
11.4.3	EMC Dispatch Center Location	207
11.4.4	Fiber Optic Network Locations	208
11.4.5	Highway Advisory Radio Locations	210
11.4.6	Highway Maintenance Yard Facility Locations	211
11.4.7	Highway Rest Area Locations	211
11.4.8	Ice Beacon	211
11.4.9	IDOT Facilities	211
11.4.10	Weigh Station	214

11.4.11 Matteson Flood Warning System.....	215
11.5 General Maintenance Responsibilities	216
11.6 Response And Repair Time Requirements	216
11.7 Non-Routine Maintenance Pay Items.....	216
11.8 Logs And Forms	216

NON-ROUTINE MAINTENANCE PAY ITEMS FOR ALL ELECTRICAL SYSTEMS

.....	218
GAC1 Aerial Cable With Messenger Wire.....	218
GAS1 Asphalt, Remove And Replace.....	218
GC01–GC06 Conduit, Galvanized Steel, Attached to Structure	218
GC07–GC08 Conduit, Galvanized Steel, Encased In Concrete.....	219
GC09–GC10 Conduit, Galvanized Steel, in Ground	220
GC11–GC12 Conduit, Non-Metallic, Coilable, in Ground	220
GC13 Conduit, PVC, for Buildings, 1 Inch, Schedule 40.....	221
GC14 Conduit, Removal.....	222
GCC1 Controller, Calcium Chloride Pump	223
GCX1 Coaxial Cable.....	223
GE01–GE02 Electric Cable Assembly	224
GE03–GE07 Electrical Cable in Conduit, EPR	224
GE08 Electric Cable, Pull Or Remove	225
GE09 Electrical Cable, THWN.....	225
GE10 Electric Service Disconnect, 2 or 3 Wire, Combination.....	226
GE11 Electric Service Disconnect, 2 or 3 Wire, Surveillance/Traffic	227
GE12–GE13 Electric Service	228
GF01 Fiber Optic Trunk/Distribution/Lateral Cable Single Mode Up To 96 SM.....	229
GF02 Fiber Optic Lateral Installation SM.....	235
GF03 Fiber Optic Cable, Hybrid 12 MM And 12 SM.....	235

GF04 Fiber Optic Termination Panel, 12F or 24F	236
GF05 Fiber Optic Patch Panel 96 SM.....	237
GF06 Fiber Optic Splice Closure	237
GF07 Fiber Optic Innerduct, up to 1 1/2'	237
GF08 Fiber Optic Cable, Install Only.....	238
GFC1 Foundation, Concrete, Type 1.....	239
GFR1 Foundation Removal.....	240
GGR1 Ground Rod.....	240
GH01–GH04 Handhole	241
GH05 Handhole, Heavy Duty, Special.....	242
GH06 Handhole, Remove	243
GH07 Handhole, Rebuild.....	243
GH08 Handhole, Rebuild Existing Handhole To Heavy-Duty	243
GIG1 Inspection, Standby Generator	244
GIT1 Inspection, Thermo Graphic	247
GJ01 Junction Box And All Appurtenances, Remove	248
GJ02 Junction Box, Inline Connectors and Termination	248
GJ03–GJ04 Junction Box, Stainless Steel	249
GMR1 Median, Remove and Replace	249
GPC1 Pump, Calcium Chloride.....	249
GRB1 Radio Tower Beacon, Relamp.....	250
GRT1 Radio Tower, Budgetary Allowance.....	250
GRT2 Radio Tower, Inspection And Report.....	251
GSD1 Sidewalk, Remove And Replace.....	251
GSO1 Sodding.....	251
GTC1 Traffic Control	252
GTR1 Trench and Backfill with Warning Tape	252

GU01–GU03 Uniduct.....	252
GU04 Uniduct, Install Only.....	253
GV01 EMCMS	253
GV02 Operational Support.....	254
GWR1–GWR2 Welding Receptacle And Plug.....	254

LIGHTING AND SIGN ILLUMINATION SYSTEM NON-ROUTINE PAY ITEMS ... 255

LA01 Arm, or Twin Arm with Luminaire, Install Only	255
LB01 Breakaway Device, T-Base, Furnish and Install.....	255
LBB1 Breaker, Branch 20A to 70A	256
LBB2–LBB3 Breaker, Main	257
LBT1 Buck-Boost Transformer.....	258
LC01 Controller, Duplex Console, with Radio.....	259
LC02 Controller, Duplex Console, without Radio.....	259
LC03 Controller, Lighting, Install Only.....	259
LC04 Controller, Lighting, Remove and Salvage	260
LC05 Controller, Single Door, Console, Without Radio	260
LC06 Controller, Combination Lighting.....	260
LCL1 Clock, Digital Astronomical	261
LCN1–LCN2 Contactor	261
LD01–LD04 Decal Set, Lighting Unit.....	262
LD05 Decal Set, Sign Unit, Truss Or Cantilever	263
LD06 Decal Set, Sign Unit, Bridge Facia with Bracket	263
LDS1 Disconnect Switch.....	263
LE01 Electrical Outlet, GFCI Type.....	264
LE02 Convenience Receptacle, 120 Volts.....	265
LF01 Foundation, Light Pole	265
LF02 Foundation, Light Pole, Metal	265

LF03	Foundation, Light Tower, Up To 48 Inch Diameter	266
LF04	Foundation, Lighting Controller	266
LF05	Foundation, Modification for Concrete or Metal	267
LGF1	Ground Field	267
LP01	Light Pole, Kit.....	268
LP02	Light Pole Unit, Install Only	268
LP03	Light Pole Unit, Removal And Salvage	269
LP04	Wood Pole Unit, Install Only	269
LP05	Wood Pole Unit, Removal and Salvage	270
LPN1	Panel, Distribution	270
LS01	SCADA, Lighting, Radio Control Equipment	272
LS02	SCADA, Lighting, Radio Inspection.....	273
LS03	SCADA, Lighting, RTU Terminal Configuration	273
LT01–LT02	Light Tower.....	274
LT03	Light Tower, in Place, Clean and Paint.....	275
LT04	Light Tower, Remove And Re-Erect	281
LT05	Light Tower, Install Only	282
LT06	Light Tower, Lowering Device for Retrofit	282
LT07	Cable, Combination Cctv & Lighting, Install.....	283
LU01	Luminaire, Fluorescent, For Building	284
LU02	Luminaire, Fluorescent, for Wet Locations	285
LU03	Luminaire, HPS, for Building Roof	285
LU04	Luminaire, HPS, for Building Wall.....	286
LU05	Luminaire, Keeper	287
LU06	Luminaire, Navigation LED.....	287
LU07	Luminaire, Removal and Salvage	288
LU08	Luminaire Shield, Pole.....	288

LU09	Luminaire Shield, Tower	288
LU10	Luminaire, Tower, Install Only	289
LU11	Luminaire, Two Lamp Fluorescent, Install Only	289
LU12	Luminaire, Wall, Underpass or Tunnel, Install Only	289
LU13	Emergency Light Fixture	290
LU14	Luminaire, Metal Halide	290
LW01–LW02	Wash Luminaires	295
LW03–LW05	Wash Tunnel Walls	295
LWR1–LWR6	Wash and Relamp, Luminaires	296
LWR7–LWR8	Wash and Relamp Tube Lights	298
PUMP STATION SYSTEM – NON ROUTINE PAY ITEMS:		300
PA01	Alarm, Intrusion Override Key Switch	300
PC01	Coating, Anti Graffiti	300
PC02	Coating, Concrete Surface	300
PC03	Coating, Steel Surface	301
PD01	Detection System, Fire	301
PF01–PF02	Fence, Gate, Remove and Replace	302
PG01	Gas Sensor, Remove and Replace	302
PI01	Inspection, Automatic Bus Transfer System	303
PI02	Inspection, Auto Transfer Switch	304
PI03	Inspection, Gas Detector System	305
PI04	Inspection, Switchgear System	306
PI05	Inspection, Motor Starter, Soft Start Type	308
PI06	Inspection, Scada Radio Equipment	309
PI07	Inspection, Scada Radio	309
PI08	Inspection, Backflow Preventer	310
PM01	Pump Motor Balancing	310

PRB1	Pump Rebuild, Type 1	313
PRB2	Pump Rebuild, Type 2	313
PRB3	Pump Rebuild, Type 3	314
PRB4	Pump Rebuild, Type 4	315
PRB5	Pump Rebuild, Type 5	315
PRB6	Pump Rebuild, Type 6	317
PS01	Pump, Scada Equipment, Furnish and Install.....	319
PS02	Pump, Vibration Testing and Analysis.....	327
PSR1	Roof, Remove and Replace.....	328
PV01–PV03	Vendor Budgetary Allowance	334
PW01	Wet Pit, Cleaning	335
PW02	Wet Pit, Power Wash	335
 SURVEILLANCE AND DYNAMIC MESSAGE SYSTEMS NON-ROUTINE PAY		
ITEMS:	345
SB01	Beacon, Flashing, Low Mount, 1 Face.....	345
SC01	Cabinet Housing Equipment, Remove and Reinstall.....	345
SC02	Cabinet, Metering, Remove and Salvage	345
SC03	Cabinet, Type 2, for Surveillance.....	345
SC04	Cabinet, Type 3, for Surveillance.....	346
SC05	Cabinet, Model 334	347
SC06	Cabinet, System Detector, Model 334.....	351
SC07	Cabinet, Ramp Meter, Model 334.....	351
SC08	Cabinet, Ramp Meter/System Detector, Model 334.....	351
SC09	Controller, Model 2070 Lite	357
SCA1	Capacitor Bank.....	360
SCF1	Clear Facia Sign Panel.....	361
SCP1–SCP2	DMS Power Cabinet.....	361

SD01	Detector Loop Sensor Unit, Four Channel Digital	363
SD02	Detector Loop Sensor Unit, Two Channel Digital	365
SD03	Detector Loop Round, Square, or Rectangular	367
SDC1	Dome Camera	370
SE01	Electric Service Upgrade and Grounding	373
SE02	Electrical Cable in Conduit, 4C/ No. 18 Shielded Loop Detector	375
SI01	Inspection, Automatic Suppression System	377
SJ01	Junction Box, Stainless Steel	378
SLP1	Lightning Protection For Communication Lines	378
SLP2	Lightning Protection for Induction Loop Detectors.....	378
SP01	Paint Surveillance Installation	379
SP02	Paint Traffic Signal Mounting Hardware.....	380
SPB1	Post Base, Traffic Signal.....	380
SPG1	Post, Guard	380
SPI1	Public Information Surveillance System.....	380
SPI2	Public Information Surveillance System, Relocate	381
SPT1	Post, Traffic Signal, 1' TO 3'-6'	381
SPW1	Post, Wood	382
SR01	Radar Vehicle Detector.....	382
SR02	Radar Vehicle Detection Station.....	386
SR03	Radar Vehicle Detection Hub.....	390
SR04	RVD Station, Remove, Salvage, and Reinstall.....	393
SR05	RVD Hub, Remove, Salvage, and Reinstall	393
SR06	RVD Hub/RVD Station Radio Site Survey	395
SS01	Signal Head, 1 Face	396
SS02	Signal Section or Head, Remove And Salvage.....	396
SS03	Signaling Load Relay, Mechanical.....	396

SS04	Solar Panel, 10 W	397
SS05	Solar Panel, 20 W	397
SSU1	Surge Protectors, AC Filtering.....	397
ST01	TELCO Suppression.....	397
ST02	Telecommunication Cable Inline Connectors And Termination	398
ST03	Telecommunication Cable - No. 19/3 Pair.....	398
ST04	Telecommunication Cable- No. 19/25 Pair.....	400
ST05	Telecommunication Cable, Install Only	401
STN1	Tone Power Supply	402
STN2	Tone Rack Cradle Assembly for Field	403
STN3	Tone Receiver, F.S.K.	403
STN4	Tone Transmitter, F.S.K.....	404
SU01	UPS System, Inspection	405
SU02	U.P.S. System, Storage Battery, Remove And Replace.....	406
SV01	Vendor Budgetary Allowance for Repair Services.....	406
SV02	Vendor Budgetary Allowance for ATMS Maintenance/Support.....	406
TRAFFIC SIGNAL SYSTEM NON-ROUTINE PAY ITEMS:.....		408
TC01–TC02	Full Actuated Controller in Cabinet.....	408
TC03	Full Actuated Controller in Type IV Cabinet With RR Equipment	408
TC04	Full Actuated Controller	408
TC05–TC06	Install Existing Traffic Signal Controller or Controller and Cabinet.....	409
TC07	Controller Cabinet, Type IV	409
TC08	Controller And Cabinet Modification	409
TC09–TC10	Communications Control Equipment.....	410
TC11	Traffic Signal Master Controller	410
TC12	Install Telephone Line And Modem	410
TC13	Install Updated Prom Set At Existing Local Or Master Controller	411

TC14	NEMA Conflict Monitor/ MMU with Event Logging	411
TC15	UPS System	412
TCS1	Portable Changeable Message Sign	412
TD01	Drill Existing Handhole	412
TE01–TE06 AND TEC1–TEC2	Electric Cable	412
TF01–TF06	Concrete Foundations	413
TF07	Concrete Foundation, Rebuild/Modify, Type D	413
TFB1	Flashing Beacon, Post Mount, 1 Face	413
TFB2	Flashing Beacon, Span Wire Mounted	414
TFB3	Flashing Beacon, Solar, Post Mount, 1 Face	414
TGS1	Additional Grounding And Electric Service Upgrade	415
TL01	Inductive Detector Loop	417
TL02	Detector Loop	418
TLS1	LED Illuminated Sign	418
TM01	Microwave Vehicle Sensor	419
TMA1–TMA5	Steel Mast Arm Assembly And Pole	419
TMA6	Relocate or Install Existing Mast Arm Assembly And Pole	420
TPP1	Pedestrian Push-Button Post, Galvanized Steel, Type II	420
TPP2	Pedestrian Push-Button	420
TR01	Rotate Signal Phasing at an Existing Traffic Signal Intersection	421
TR02	Re-Assign System Detectors	421
TS01	Manhole Cover And Frame Grounding Furnish And Install	421
TSD1	LED Signal Display	421
TSH1–TSH3	Incandescent Signal Head, 1 Face	422
TSH4	Signal Head Lens	422
TSH5	Pedestrian Incandescent Signal Head, 1 Face	422
TSL1–TSL8	LED Signal Head, 1 Face	423

TSL9	LED PEDESTRIAN SIGNAL HEAD, 1 FACE	424
TSL10	LED Pedestrian Signal Head, Countdown, 1 Face	424
TSR1	Remove Signal Section Or Head	424
TSR2	Relocate or Install Existing Signal Section Or Head.....	425
TT01	Temporary Traffic Signal Installation	425
TTM1	Thermoplastic Pavement Marking Line 24 Inch.....	426
TTP1	Traffic Signal Post, 10 FT to 18 FT	426
TTP2 - TTP3	Remove Traffic Signal Post and Remove Mast Arm Assembly and Pole	426
TTP4	Relocate or Install Existing Signal Post.....	426
TVD1	Video Detection System, Complete Intersection.....	427
TVD2	Video Detection System, Single Camera/Processor.....	433
TWD1	Wireless Detection System, Complete Intersection	434
TWD2	Wireless Detection System, Single Approach	435
TWI2	Wireless Interconnect System	436
SECTION 3 – LIST OF LOCATIONS		489
SECTION 4 – BDE SPECIAL PROVISIONS – TABLE OF CONTENTS		581

SCHEDULE OF PRICES

Item	Item Description	# of Bid Locations	Units per Location	ELU**
L-1	Lighting System - On-Expressway	250	3.00	750.00
L-2	Lighting System - Off-Expressway	185	1.50	277.50
L-3	Lighting System - Other Luminaires	100	0.25	25.00
P-1	Pump Stations > or = 4 Pumps	27	6.00	162.00
P-2	Pump Stations < 4 Pumps	21	4.00	84.00
S-1	Surveillance System - Ramp Controls	118	1.00	118.00
S-2	Surveillance System - Cabinets	659	0.25	164.75
S-3	Surveillance System - Expressway DMS	40	2.00	80.00
S-4	Surveillance System - Arterial DMS	15	1.00	15.00
T-1	Traffic Signal System - Signals	2445	1.00	2445.00
T-2	Traffic Signal System - Flashing Beacons	275	0.25	68.75
X-1	Extra Systems	89	0.50	44.50

Total Equivalent Location Units (ELUs)

4234.50

Bid Price per ELU per month

\$
\$
\$

Monthly Cost of Routine Maintenance (Bid Price per ELU X Total ELU)

Routine Maintenance/Yr (Monthly Cost X 12)

****Equivalent Location Units (ELUs) = # of Bid Locations X Units per Location**

Item	Item Description	Units	Quantity	Unit Cost	Extension
GAC1	Aerial Cable, with Messenger Wire, 4-1/C up to No. 2	Ft	1,500	\$	\$
GAS1	Asphalt, Remove and Replace	SF	1,000	\$	\$
GC01	Conduit, Galvanized Steel, Attached to Struct. 3/4 to 1 1/4"	Ft	2,500	\$	\$
GC02	Conduit, Galvanized Steel, Attached to Struct. 1 1/2" to 2 1/2"	Ft	500	\$	\$
GC03	Conduit, Galvanized Steel, Attached to Struct. 3" to 5"	Ft	300	\$	\$
GC04	Conduit, Galv. Steel, Attached to Struct. PVC Coated, 3/4 to 1 1/4"	Ft	1,500	\$	\$
GC05	Conduit, Galv. Steel, Attached to to Struct. PVC Coated, 1 1/2" to 2 1/2"	Ft	500	\$	\$
GC06	Conduit, Galv. Steel, Attached to Struct. PVC Coated, 3" to 5"	Ft	300	\$	\$
GC07	Conduit, Galvanized Steel, Encased in Concrete, 3/4" to 2 1/2"	Ft	200	\$	\$
GC08	Conduit, Galvanized Steel, Encased in Concrete, 3" to 5"	Ft	250	\$	\$
GC09	Conduit, Galvanized Steel, in Ground, 3/4 to 2 1/2"	Ft	3,000	\$	\$
GC10	Conduit, Galvanized Steel, In Ground, 3" to 5"	Ft	1,000	\$	\$
GC11	Conduit, Non-Metallic, Coilable, in Ground, 1 1/4"	Ft	1,000	\$	\$
GC12	Conduit, Non-Metallic, Coilable, in Ground, 2"	Ft	500	\$	\$
GC13	Conduit, PVC, for Buildings, 1", Schedule 40	Ft	300	\$	\$
GC14	Conduit, Removal	Ft	1,000	\$	\$

GCC1	Controller, Calcium Chloride Pump	Ea	2	\$	\$
GCX1	Coaxial Cable	Ft	500	\$	\$
GE01	Electric Cable Assembly, EPR, 3/C No. 2, 1/C No. 6 Green	Ft	1,000	\$	\$
GE02	Electric Cable Assembly, EPR, 3/C No. 4, 1/C No. 6 Green	Ft	1,000	\$	\$
GE03	Electric Cable, EPR, 1/C up to No. 6	Ft	16,500	\$	\$
GE04	Electric Cable, EPR, 1/C from No. 4 to No. 1	Ft	5,000	\$	\$
GE05	Electric Cable, EPR, 1/C from No. 1/0 to No. 2/0	Ft	1,000	\$	\$
GE06	Electric Cable, EPR, 1/C from No. 3/0 to No. 4/0	Ft	1,000	\$	\$
GE07	Electric Cable, EPR, 1/C from 250 MCM to 500 MCM	Ft	1,000	\$	\$
GE08	Electric Cable, Pull or Remove	Ft	10,000	\$	\$
GE09	Electric Cable, THWN, 1/C from No.14 to No.10	Ft	10,000	\$	\$
GE10	Electric Service Disconnect, 2 or 3 Wire, Combination	Ea	10	\$	\$
GE11	Electric Service Disconnect, 2 or 3 Wire, Surveillance/Traffic	Ea	5	\$	\$
GE12	Electric Service, Pedestal or Pole Mounted, Complete	Ea	5	\$	\$
GE13	Electric Service, Relocate	Ea	3	\$	\$
GF01	Fiber Optic Trunk/Distribution/ Lateral Cable, up to 96 SM	Ft	5,000	\$	\$

GF02	Fiber Optic Lateral Installation SM	Ft	5,000	\$	\$
GF03	Fiber Optic Cable, Hybrid 12 MM & 12 SM	Ft	5,000	\$	\$
GF04	Fiber Optic Termination Panel, 12F or 24F	Ea	5	\$	\$
GF05	Fiber Optic Patch Panel, 96 SM	Ea	5	\$	\$
GF06	Fiber Optic Splice Enclosure	Ea	5	\$	\$
GF07	Fiber Optic Innerduct, up to 1 1/2"	Ft	5,000	\$	\$
GF08	Fiber Optic Cable, Install Only	Ft	5,000	\$	\$
GFC1	Foundation, Concrete, Type 1	Ft	20	\$	\$
GFR1	Foundation Removal	Ea	5	\$	\$
GGR1	Ground Rod	Ea	40	\$	\$
GH01	Handhole	Ea	8	\$	\$
GH02	Handhole, Fiber Optic	Ea	4	\$	\$
GH03	Handhole, Heavy-Duty	Ea	4	\$	\$
GH04	Handhole, Heavy-Duty, Double	Ea	4	\$	\$
GH05	Handhole, Heavy-Duty, Special	Ea	4	\$	\$
GH06	Handhole, Remove	Ea	10	\$	\$

GH07	Handhole, Re-build	Ea	5	\$	\$
GH08	Handhole, Re-build Existing to Heavy-Duty	Ea	5	\$	\$
GIG1	Inspection, Standby Generator	Ea	15	\$	\$
GIT1	Inspection, Thermo Graphic	Ea	2	\$	\$
GJ01	Junction Box, and all Appurtenances, Remove	Ea	10	\$	\$
GJ02	Junction Box, Inline Connectors and Termination	Ea	5	\$	\$
GJ03	Junction Box, Stainless Steel, up to 6" Depth	Ea	45	\$	\$
GJ04	Junction Box, Stainless Steel, 8" Depth	Ea	15	\$	\$
GMR1	Median, Remove and Replace	SF	20	\$	\$
GPC1	Pump, Calcium Chloride	Ea	5	\$	\$
GRB1	Radio Tower Beacon, Relamp	Ea	10	\$	\$
GRT1*	Radio Tower, Budgetary Allowance	LS	1	\$ 100,000	\$ 100,000
GRT2	Radio Tower, Inspection and Report	Ea	6	\$	\$
GSD1	Sidewalk, Remove and Replace	SF	45	\$	\$
GSO1	Sodding	SF	500	\$	\$
GTC1	Traffic Control	Ea	50	\$	\$

GTR1	Trench & Backfill with Warning Tape	Ft	5,000	\$	\$
GU01	Uniduct, EPR, 3/c No. 6 & 1/c No. 8 Green, 1"	Ft	3,000	\$	\$
GU02	Uniduct, EPR, 3/c No. 4 & 1/c No. 6 Green, 1 1/4"	Ft	3,000	\$	\$
GU03	Uniduct, EPR, 3/c No. 2 & 1/c No. 6 Green, 1 1/2"	Ft	1,000	\$	\$
GU04	Uniduct, Install Only	Ft	1,000	\$	\$
GV01*	Vendor Budgetary Allowance, EMCMS	LS	1	\$ 30,000.00	\$ 30,000.00
GV02*	Vendor Budgetary Allowance, Operational Support	LS	1	\$ 10,000.00	\$ 10,000.00
GWR1	Welding Receptacle and Plug, 3 Pole, 30 Amp, Furnish and Install	Ea	5	\$	\$
GWR2	Welding Receptacle and Plug, 3 Pole, 60 Amp, Furnish and Install	Ea	2	\$	\$
LA01	Arm or Twin Arm with Luminaire, Install Only	Ea	150	\$	\$
LB01	Breakwawy Device, T-Base	Ea	100	\$	\$
LBB1	Breaker, Branch, 20A to 70A	Ea	10	\$	\$
LBB2	Breaker, Main, 60A to 100A	Ea	5	\$	\$
LBB3	Breaker, Main, 125A to 175A	Ea	5	\$	\$
LBT1	Buck Boost Transformer	Ea	5	\$	\$
LC01	Controller, Duplex Console, with Radio	Ea	2	\$	\$

LC02	Controller, Duplex Console, w/o Radio	Ea	2	\$	\$
LC03	Controller, Lighting, Install only	Ea	6	\$	\$
LC04	Controller, Lighting, Remove & Salvage	Ea	6	\$	\$
LC05	Controller, Single Door Console, w/o Radio	Ea	2	\$	\$
LC06	Controller, Combination Lighting	Ea	2	\$	\$
LCL1	Clock, Digital Astronomical	Ea	10	\$	\$
LCN1	Contactor, 125A to 225A	Ea	2	\$	\$
LCN2	Contactor, 30A to 100A	Ea	5	\$	\$
LD01	Decal Set, Lighting Unit, Pole	Ea	100	\$	\$
LD02	Decal Set, Lighting Unit, Tower	Ea	100	\$	\$
LD03	Decal Set, Lighting Unit, Tunnel or Underpass with Bracket	Ea	100	\$	\$
LD04	Decal Set, Lighting Unit, Tower with Camera	Ea	20	\$	\$
LD05	Decal Set, Sign Unit, Truss or Cantilever	Ea	30	\$	\$
LD06	Decal Set, Sign Unit, Bridge Facia with Bracket	Ea	10	\$	\$
LDS1	Disconnect Switch	Ea	5	\$	\$
LE01	Electrical Outlet, GFCI Type	Ea	10	\$	\$

LE02	Convenience Receptacle, 120 Volts	Ea	20	\$	\$
LF01	Foundation, Light Pole	L. Ft.	100	\$	\$
LF02	Foundation, Light Pole, Metal	Ea	50	\$	\$
LF03	Foundation, Light Tower, up to 48" Dia.	L. Ft.	100	\$	\$
LF04	Foundation, Lighting Controller	Ea	5	\$	\$
LF05	Foundation, Modification for Concrete or Metal	Ea	5	\$	\$
LGF1	Ground Field	Ea	10	\$	\$
LP01	Light Pole, Kit	Ea	200	\$	\$
LP02	Light Pole Unit, Install only	Ea	100	\$	\$
LP03	Light Pole Unit, Removal & Salvage	Ea	50	\$	\$
LP04	Wood Pole, Install only	Ea	8	\$	\$
LP05	Wood Pole, Removal & Salvage	Ea	8	\$	\$
LPN1	Panel, Distribution	Ea	4	\$	\$
LS01	SCADA, Lighting, Radio Control Equipment	Ea	4	\$	\$
LS02	SCADA, Lighting, Radio Inspection	Ea	12	\$	\$
LS03	SCADA, Lighting, RTU Terminal Configuration	Ea	4	\$	\$

LT01	Light Tower, 110' or less	Ea	1	\$	\$
LT02	Light Tower, 111' or more	Ea	1	\$	\$
LT03	Light Tower, in Place, Clean and Paint	Ft	1,500	\$	\$
LT04	Light Tower, Remove and Re-Erect	Ea	1	\$	\$
LT05	Light Tower, Install only	Ea	2	\$	\$
LT06	Light Tower, Lowering Device for Retrofit	Ea	6	\$	\$
LT07	Cable, Combination CCTV & Lighting, Install	Ea	5	\$	\$
LU01	Luminaire, Fluorescent, for Building	Ea	30	\$	\$
LU02	Luminaire, Fluorescent, for Wet Locations	Ea	15	\$	\$
LU03	Luminaire, HPS, for Building Roof	Ea	4	\$	\$
LU04	Luminaire, HPS, for Building Wall	Ea	16	\$	\$
LU05	Luminaire, Keeper	Ea	50	\$	\$
LU06	Luminaire, Navigation LED Light Fixture	Ea	5	\$	\$
LU07	Luminaire, Removal & Salvage	Ea	105	\$	\$
LU08	Luminaire Shield, Pole	Ea	50	\$	\$
LU09	Luminaire Shield, Tower	Ea	40	\$	\$

LU10	Luminaire, Tower, Install only	Ea	45	\$	\$
LU11	Luminaire, Two Lamp Fluorescent, Install only	Ea	75	\$	\$
LU12	Luminaire, Underpass or Tunnel, Install only	Ea	50	\$	\$
LU13	Emergency Light Fixture	Ea	10	\$	\$
LU14	Luminaire, Metal Halide	Ea	20	\$	\$
LW01	Wash Luminaires, Light Poles	Ea	4,680	\$	\$
LW02	Wash Luminaires, Underpasses or Tunnels	Ea	2,670	\$	\$
LW03	Wash Tunnel Walls, Hubbard's Cave	Ea	4	\$	\$
LW04	Wash Tunnel Walls, 99th Street Tunnel	Ea	4	\$	\$
LW05	Wash Tunnel Walls and Piers, Old Post Office	Ea	4	\$	\$
LWR1	Wash and Relamp, Luminaires, Fluorescent and CFL	Ea	5050	\$	\$
LWR2	Wash and Relamp, Luminaires, HPS	Ea	7,100	\$	\$
LWR3	Wash and Relamp, Luminaires, Incandescent	Ea	100	\$	\$
LWR4	Wash and Relamp, Luminaires, LPS	Ea	980	\$	\$
LWR5	Wash and Relamp, Luminaires, MH	Ea	5	\$	\$
LWR6	Wash and Relamp, LED Luminaires	Ea	90	\$	\$

LWR7	Wash and Relamp, Tube Lights, HPS	Ea	26	\$	\$
LWR8	Wash and Relamp, Tube Lights, MH	Ea	14	\$	\$
PA01	Alarm, Intrusion Override Key Switch	Ea	50	\$	\$
PC01	Coating, Anti Grafitti	SF	2,500	\$	\$
PC02	Coating, Concrete Surface	SF	5,000	\$	\$
PC03	Coating, Steel Surface	SF	1,000	\$	\$
PD01	Detection System, Fire	Ea	6	\$	\$
PF01	Fence, Remove and Replace	Ft	1,000	\$	\$
PF02	Fence Gate, Remove and Replace	Ft	200	\$	\$
PG01	Gas Sensor, Remove and Replace	Ea	15	\$	\$
PI01	Inspection, Automatic Bus Transfer System	Ea	4	\$	\$
PI02	Inspection, Auto Transfer Switch	Ea	24	\$	\$
PI03	Inspection, Gas Detector System	Ea	47	\$	\$
PI04	Inspection, Switchgear System	LS	1	\$	\$
PI05	Inspection, Motor Starter, Soft Start Type	Ea	5	\$	\$
PI06	Inspection, SCADA Radio Equipment	LS	2	\$	\$

PI07	Inspection, SCADA Radio	Ea	40	\$	\$
PI08	Inspection, Backflow Preventer	Ea	8	\$	\$
PM01	Pump Motor Balancing	Ea	6	\$	\$
PRB1	Pump Rebuild, Type 1	Ea	3	\$	\$
PRB2	Pump Rebuild, Type 2	Ea	4	\$	\$
PRB3	Pump Rebuild, Type 3	Ea	1	\$	\$
PRB4	Pump Rebuild, Type 4	Ea	15	\$	\$
PRB5	Pump Rebuild, Type 5	Ea	1	\$	\$
PRB6	Pump Rebuild, Type 6	Ea	1	\$	\$
PS01	Pump, SCADA Equipment, Furnish and Install	Ea	6	\$	\$
PS02	Pump, Vibration Testing and Analysis	Ea	256	\$	\$
PSR1	Roof, Remove and Replace	SF	1,500	\$	\$
PV01*	Vendor Budgetary Allowance for Pump Repair Services	LS	1	\$ 100,000.00	\$ 100,000.00
PV02*	Vendor Budgetary Allowance for Pump Bowl Replacement	LS	1	\$ 150,000.00	\$ 150,000.00
PV03*	Vendor Budgetary Allowance for Pump Replacement	LS	1	\$ 150,000.00	\$ 150,000.00
PW01	Wet Pit, Cleaning	SY	800	\$	\$

PW02	Wet Pit, Power Wash	HR	200	\$	\$
SB01	Beacon, Flashing, Low Mount, 1 Face	Ea	1	\$	\$
SC01	Cabinet Housing Equipment, Remove & Re-install	Ea	5	\$	\$
SC02	Cabinet, Metering, Remove & Salvage	Ea	5	\$	\$
SC03	Cabinet, Type 2, for Surveillance	Ea	1	\$	\$
SC04	Cabinet, Type 3, for Surveillance	Ea	10	\$	\$
SC05	Cabinet, Model 334	Ea	3	\$	\$
SC06	Cabinet, System Detector, Model 334	Ea	2	\$	\$
SC07	Cabinet, Ramp Meter, Model 334	Ea	2	\$	\$
SC08	Cabinet, Ramp Meter/System Detector, Model 334	Ea	2	\$	\$
SC09	Controller, Model 2070 Lite	Ea	3	\$	\$
SCA1	Capacitor Bank	Ea	11	\$	\$
SCF1	Clear Fascia Sign Panel	SF	450	\$	\$
SCP1	DMS Power Cabinet, Type 2, with Meter	Ea	1	\$	\$
SCP2	DMS Power Cabinet, Type 3, with Meter	Ea	1	\$	\$
SD01	Detector Loop Sensor Unit, 4 Channel Digital	Ea	20	\$	\$

SD02	Detector Loop Sensor Unit, 2 Channel Digital	Ea	20	\$	\$
SD03	Detector Loop, Round, Square or Rectangular	Ft	4,500	\$	\$
SDC1	Dome Camera	Ea	7	\$	\$
SE01	Electric Service Upgrade and Grounding	Ea	1	\$	\$
SE02	Electrical Cable in Conduit, 4/c No. 18, Shielded Loop Detector	Ft	1,525	\$	\$
SI01	Inspection, Automatic Suppression System	Ea	2	\$	\$
SJ01	Junction Box, Stainless Steel	Ea	1	\$	\$
SLP1	Lightning Protection for Communication Lines	Ea	5	\$	\$
SLP2	Lightning Protection for Induction Loop Detectors	Ea	5	\$	\$
SP01	Paint Surveillance Installation	Ea	275	\$	\$
SP02	Paint Traffic Signal Mounting Hardware	Ea	1	\$	\$
SPB1	Post Base, Traffic Signal	Ea	1	\$	\$
SPG1	Post, Guard	Ea	1	\$	\$
SPI1	Public Information Surveillance System	Ea	1	\$	\$
SPI2	Public Information Surveillance System, Relocate	Ea	1	\$	\$
SPT1	Post, Traffic Signal, 1' to 3' 6"	Ea	1	\$	\$

SPW1	Post, Guard	Ea	1	\$	\$
SR01	Radar Vehicle Detector	Ea	5	\$	\$
SR02	Radar Vehicle Detection Station	Ea	4	\$	\$
SR03	Radar Vehicle Detection Hub	Ea	2	\$	\$
SR04	RVD Station, Remove, Salvage and Re-install	Ea	26	\$	\$
SR05	RVD Hub, Remove, Salvage and Re-install	Ea	7	\$	\$
SR06	RVD Hub/RVD Station Radio Site Survey	LS	1	\$	\$
SS01	Signal Head, 1 Face	Ea	1	\$	\$
SS02	Signal Section or Head, Remove & Salvage	Ea	1	\$	\$
SS03	Signaling Load Relay, Mechanical	Ea	113	\$	\$
SS04	Solar Panel - 10 W	Ea	2	\$	\$
SS05	Solar Panel - 20 W	Ea	2	\$	\$
SSU1	Surge Protectors, AC Filtering	Ea	5	\$	\$
ST01	TELCO Suppression	Ea	25	\$	\$
ST02	Telecommunication Cable, Inline Connectors & Termination	Ea	10	\$	\$
ST03	Telecommunication Cable, No. 19/ 3 Pair	Ft	1,500	\$	\$

ST04	Telecommunication Cable, No. 19/ 25 Pair	Ft	1,500	\$	\$
ST05	Telecommunication Cable, install only	Ft	1,500	\$	\$
STN1	Tone Power Supply	Ea	10	\$	\$
STN2	Tone Rack Cradle Assembly for Field	Ea	10	\$	\$
STN3	Tone Receiver, FSK	Ea	10	\$	\$
STN4	Tone Transmitter, FSK	Ea	10	\$	\$
SU01	UPS System, Inspection	Ea	1	\$	\$
SU02	UPS System, Storage Battery, Remove & Replace	Ea	5	\$	\$
SV01*	Vendor Budgetary Allowance for Repair Services	LS	1	\$ 40,000.00	\$ 40,000.00
SV02*	Vendor Budgetary Allowance for ATMS Maintenance/Support	LS	1	\$ 75,000.00	\$ 75,000.00
TC01	Full-Actuated Controller in Type IV Cabinet	Ea	15	\$	\$
TC02	Full-Actuated Controller in Type V Cabinet	Ea	5	\$	\$
TC03	Full-Actuated Controller in Type IV Cabinet W/RR Equipment	Ea	5	\$	\$
TC04	Full-Actuated Controller	Ea	5	\$	\$
TC05	Install Existing Traffic Signal Controller	Ea	20	\$	\$
TC06	Install Existing Traffic Signal Controller and Cabinet	Ea	10	\$	\$

TC07	Controller Cabinet, Type IV	Ea	5	\$	\$
TC08	Controller and Cabinet Modification	Ea	25	\$	\$
TC09	FSK/Wire Communications Control Equipment	Ea	1	\$	\$
TC10	Fiber Optic Communications Control Equipment	Ea	20	\$	\$
TC11	Traffic Signal Master Controller	Ea	2	\$	\$
TC12	Install Telephone Line and Modem	Ea	10	\$	\$
TC13	Install Updated PROM Set at Existing Local or Master Controller	Ea	150	\$	\$
TC14	NEMA Conflict Monitor/MMU with Event Logging	Ea	5	\$	\$
TC15	UPS System	Ea	30	\$	\$
TCS1	Portable Changeable Message Sign	Ea	10	\$	\$
TD01	Drill Existing Handhole	Ea	20	\$	\$
TE01	Electric Cable No. 14 2/C	Ft	3,500	\$	\$
TE02	Electric Cable No. 14 3/C	Ft	3,500	\$	\$
TE03	Electric Cable No. 14 5/C	Ft	3,500	\$	\$
TE04	Electric Cable No. 14 7/C	Ft	2,000	\$	\$
TE05	Electric Cable No. 14 2/C, Twisted Shielded	Ft	3,000	\$	\$

TE06	Electric Cable No. 18 3 Pair, Twisted Shielded	Ft	200	\$	\$
TEC1	Electric Cable in Conduit, Tracer No. 14 1/C	Ft	10,000	\$	\$
TEC2	Electric Cable No. 14 3/C Railroad	Ft	750	\$	\$
TF01	Concrete Foundation, Type A	Ft	50	\$	\$
TF02	Concrete Foundation, Type D	Ft	24	\$	\$
TF03	Concrete Foundation, Type E, 24 inch Diameter	Ft	15	\$	\$
TF04	Concrete Foundation, Type E, 30 inch Diameter	Ft	60	\$	\$
TF05	Concrete Foundation, Type E, 36 inch Diameter	Ft	60	\$	\$
TF06	Concrete Foundatino, Type E, 42 inch Diameter	Ft	60	\$	\$
TF07	Concrete Foundation, Rebuild/Modify, Type D	Ea	5	\$	\$
TFB1	Flashing Beacon, Post Mounted, 1 Face	Ea	10	\$	\$
TFB2	Flashing Beacon, Span Wire Mounted	Ea	2	\$	\$
TFB3	Flashing Beacon, Solar, Post Mounted, 1 Face	Ea	30	\$	\$
TGS1	Traffic Signal Additional Grounding & Electric Service Upgrade	Ea	10	\$	\$
TL01	Inductive Loop Detector	Ea	100	\$	\$
TL02	Detector Loop	Ft	3,500	\$	\$

TLS1	LED Illuminated Sign	Ea	10	\$	\$
TM01	Microwave Vehicle Sensor	Ea	5	\$	\$
TMA1	Steel Mast Arm Assembly and Pole, 16' to 28'	Ea	2	\$	\$
TMA2	Steel Mast Arm Assembly and Pole, 30' to 44'	Ea	2	\$	\$
TMA3	Steel Mast Arm Assembly and Pole, 46' to 55'	Ea	4	\$	\$
TMA4	Steel Mast Arm Assembly and Pole, 56 ft to 65 ft	Ea	2	\$	\$
TMA5	Steel Mast Arm Assembly and Pole, 66 ft to 75 ft	Ea	2	\$	\$
TMA6	Relocate or Install Existing Mast Arm Assembly and Pole	Ea	2	\$	\$
TPP1	Pedestrian Pushbutton Post, Galvanized Steel, Type II	Ea	5	\$	\$
TPP2	Pedestrian Pushbutton	Ea	100	\$	\$
TR01	Rotate Signal Phasing at an Existing Traffic Signal Intersection	Ea	5	\$	\$
TR02	Re-assign System Detectors	Ea	5	\$	\$
TS01	Manhole Cover and Frame Grounding, Furnish and Install	Ea	10	\$	\$
TSD1	LED Signal Display	Ea	10	\$	\$
TSH1	Signal Head, 1 Face, 3 Section	Ea	25	\$	\$
TSH2	Signal Head, 1 Face, 4 Section	Ea	5	\$	\$

TSH3	Signal Head, 1 Face, 5 Section	Ea	15	\$	\$
TSH4	Signal Head Lens	Ea	5	\$	\$
TSH5	Pedestrian Signal Head, 1 Face	Ea	26	\$	\$
TSL1	LED Signal Head, 1 Face, 2 Section	Ea	5	\$	\$
TSL2	LED Signal Head, 1 Face, 3 Section	Ea	100	\$	\$
TSL3	LED Signal Head, 1 Face, 4 Section	Ea	50	\$	\$
TSL4	LED Signal Head, 1 Face, 5 Section	Ea	80	\$	\$
TSL5	LED Signal Head, Optically Programmed, 1F, 3S	Ea	50	\$	\$
TSL6	LED Signal Head, Optically Programmed, 1F, 5S	Ea	10	\$	\$
TSL7	LED Signal Head, Remotely Steerable Optics, 1 Face, 3S	Ea	4	\$	\$
TSL8	LED Signal Head, Remotely Steerable Optics, 1 Face, 5S	Ea	6	\$	\$
TSL9	LED Pedestrian Signal Head, 1 Face	Ea	25	\$	\$
TSL10	LED Pedestrian Signal Head, Countdown, 1 Face	Ea	50	\$	\$
TSR1	Remove Signal Section or Head	Ea	50	\$	\$
TSR2	Relocate or Install Existing Signal Head	Ea	25	\$	\$
TT01	Temporary Traffic Signal Installation	Ea	5	\$	\$

TTM1	Thermoplastic Pavement Marking Line, 24"	Ft	500	\$	\$
TTP1	Traffic Signal Post, 10' to 18'	Ea	30	\$	\$
TTP2	Remove Traffic Signal Post	Ea	10	\$	\$
TTP3	Remove Mast Arm Assembly and Pole	Ea	2	\$	\$
TTP4	Relocate or Install Existing Signal Post	Ea	3	\$	\$
TVD1	Video Detection System, Complete Intersection	Ea	5	\$	\$
TVD2	Video Detection System, Single Camera/Processor	Ea	5	\$	\$
TWD1	Wireless Detection System, Complete Intersection	Ea	2	\$	\$
TWD2	Wireless Detection System, Single Approach	Ea	4	\$	\$
TWI1	Wireless Intereconnect System	Ea	4	\$	\$

Sub-Total Non-Routine: \$ _____

Routine Maintenance/Yr (RM/Yr)= \$ _____

Total Contract Bid Price (Routine + Non-Routine): \$ _____

* Non-Biddable Pay Items

District 1 Electrical Maintenance Contract

Article 1.0 -- Instructions to Bidders and Pre-Qualification Submittals

1.1 Description of Work

This contract is for the maintenance of a Lighting, Navigation, and Sign Illumination System, Pump Station System, Surveillance and Dynamic Message Systems, Traffic Signal System, and Extra Systems including Bridge Monitoring, ComCenter Monitoring, Fiber Backbone, Highway Advisory Radio, Ice Beacons, Maintenance Yard electrical equipment, Radio Base and Tower Stations, Weigh Station Systems, and rest area lighting/electrical equipment. Each of these major systems consists of many subsystems and components at many locations throughout District 1.

1.2 Schedule of Prices – Submittal (For Attached Bidding Sheets)

1. The undersigned bidder submits herewith, in accordance with the rules and instructions, a schedule of prices for the items of work for which bids are sought.
2. The Contractor, for specified unit prices listed under the Schedule of Prices, shall conform to all requirements as specified herein these articles.
3. Each Pay Item shall have a unit price and a total price.
4. The unit prices bid are in U.S. dollars and cents.
5. The unit price shall govern if no total price is shown or if there is a discrepancy between the product of the unit price multiplied by the quantity.
6. If a unit price is omitted, the total price will be divided by the quantity in order to establish a unit price.
7. A bid will be declared unacceptable if neither unit price nor a total price is shown.
8. The bidder understands that the quantities appearing in the bid schedule are approximate and are provided for the purpose of obtaining a gross sum for the comparison of bids.
9. Payment to the contractor awarded the contract will be made only for actual quantities of work performed and accepted or materials furnished, according to the contract. The Department is under no obligation to authorize non-routine pay item work. Non-routine work will be authorized based on preventative maintenance assessments, ongoing operational needs and system inspections.
10. The scheduled quantities of work to be done and materials to be furnished may be increased, decreased or omitted as provided elsewhere in the contract.

Quantities included for bidding are only estimates and actual quantities may vary. The pace of construction activities within the District as well as a number of other unpredictable factors will cause variances from these indicated quantities, both for routine maintenance pay items as well as non-routine pay items.

The Contractor's unit prices are expected to be realistic and no additional compensation will be allowed due to a variance in quantities; however, the Engineer retains the right to seek a revised unit price where quantities exceed estimated quantities to the extent that additional economies of scale would be normal.

The Engineer also retains the right to use force account procedures or use other procurement means available to the Department where unit prices reflect pricing significantly higher than Department project

norms. The contractor is cautioned against unbalanced bidding and is directed to Article 102.01 of the Standard Specifications.

1.3 Pre-Bid Meeting

It is the intent of this Contract that it be performed only by a contractor having the size, special expertise and organizational capabilities necessary to accomplish its wide-ranging scope of work. The prospective bidder should familiarize himself with all aspects of the Contract prior to bidding.

All bidders must be pre-approved, by the IDOT Central Bureau of Operations, prior to bidding upon the District 1 Electrical Maintenance Contract. **A Bidder's Special Qualifications submittal must be presented to the Department at the Pre-Bid Meeting.** See Article 1.9, herein.

A pre-bid information meeting will be conducted to review details of the work for prospective bidders:

Thursday, August 28, 2008

10:00 A.M.

Illinois Department of Transportation

201 West Center Court

Schaumburg, IL 60196-1096

The Pre-Bid Meeting attendance is mandatory for all prospective bidders.

1.4 Site Inspections

Pre-Bid Site Inspection locations, itinerary and program schedules will be finalized and distributed at the Pre-Bid Meeting. Bidders are expected to be familiar with the type and extent of systems covered under the Contract. Certain items will be made available for detailed inspection during the Pre-Bid Site Inspection. Bidders are encouraged to request inspection items prior to the Pre-Bid Meeting. The Department reserves the right to limit the inspections.

1.5 Examination Of Plans, Specifications, Special Provisions, And Site Of Work

The prospective bidder shall, before submitting his bid, carefully examine the proposal form, plans, specifications, special provisions and form of contract and bond. All locations to be maintained under this Contract may be inspected in order for the prospective bidder to become familiar with all the local conditions affecting the Contract and the detailed requirements of maintenance.

The prospective bidder shall be responsible for any pre-existing maintenance deficiencies that may exist at the time this contract is awarded and his bid shall reflect these deficiencies. If this bid is accepted, he will be responsible for all errors in his proposal resulting from his failure or neglect to comply with these instructions. The Department will, in no case, be responsible for any change in anticipated profits resulting from such failure or neglect.

Numerous figures, charts, forms, or required contractor submittals, as mentioned herein, shall be furnished to all bidders at the Pre-Bid meeting.

1.6 Proposal Guaranty

Each proposal shall be accompanied by either a bid bond on the Department form, executed by a corporate surety company, satisfactory to the Department, or a bank cashier's check or a properly certified check for Three Hundred Thousand Dollars (\$300,000) made payable to the Treasurer, State of Illinois. The proposal guaranty checks will be returned as prescribed in Section 102 of the Standard Specifications. Bid bonds will not be returned.

1.7 Requirement Of Contract Bond

The successful bidder, at the time of execution of the Contract, shall deposit with the Department a surety bond in the amount of four million dollars (\$4,000,000). The form of the bond shall be acceptable to the Department.

1.8 Insurance

The Contractor shall comply with the provisions of Section 107 of the Standard Specifications for Road and Bridge Construction, legal relations and responsibility to public. Insurance shall be in compliance with the requirements of Article 107.27 except for liability minimum amounts as modified herein.

The Contractor's insurance shall be written for not less than limits of liability as follows:

A. Employers Liability

(1) Each Accident	\$12,500,000
-------------------	--------------

B. Commercial General Liability

(1) General Aggregate Limit	\$12,500,000
-----------------------------	--------------

(2) Products-Completed Operations Aggregate Limit	\$12,500,000
--	--------------

(3) Each Occurrence Limit	\$12,500,000
---------------------------	--------------

C. Commercial Automobile Liability

Bodily Injury & Property Damage
Liability Limit Each Occurrence \$ 12,500,000

D. Umbrella Liability

Refer to Art.107.27

- The Chicago Transit Authority and the Illinois Department of Transportation shall be named as additional insureds and furnished with certificates of insurance and a full copy the insurance policy.
- The customary exclusion that negates coverage when working within 50 feet of a railroad track shall be eliminated from the Liability policy and the certificates submitted shall plainly state that coverage extends to work being done on or over track right-of-way. The Contractor shall carry a railroad protective insurance policy for the purpose of maintaining traffic signal facilities and appurtenances on railroad right-of-way (R.O.W.). The policy shall cover the Contractor's crews performing normal routine maintenance on traffic signal heads and other traffic signal related items attached directly to the railroad's truss or structure containing the railroad's warning devices. (This coverage is required for all existing locations with traffic signal heads attached directly to railroad structures, or with existing railroad interconnects.)
- The Contractor shall obtain railroad protective liability insurance coverage, to perform non-routine work relating to the installation of new traffic signal facilities on railroad R.O.W. where the Department has no existing appurtenances, e.g., railroad interconnect, railroad structure mounted traffic devices, etc.

- The Contractor shall provide insurance coverage for all State Stock Inventory in the possession of the Contractor or in the State Stock Warehouse, for losses due to fire, theft or vandalism. Estimated value of current stock on hand is approximately \$500,000.

The Contractor shall provide full insurance coverage as described in the above items until all routine and authorized non-routine work has been completed in accordance with the terms of this Contract.

The Contractor shall submit original and duplicate copies of all insurance policies when requested by the Engineer. The complete policies, with all riders, etc., shall be submitted.

1.9 Bidders' Special Qualifications Submittal

All prospective bidders shall submit the following special qualification information for review and evaluation at the Pre-Bid mandatory meeting:

1. It is understood that due to the unique skills and experience required to maintain the electrical systems in District 1, it will not be possible for prospective bidders to furnish all names of personnel who will be involved in the EMC 2009/2010, prior to the beginning of the Contract, however, it is expected that the Contractor would know the name of the prospective Project Manager and System Managers. Therefore resumes of the Principal and/or Project Manager, System Managers, and Specialists are a required submittal. The resumes of other dedicated personnel; administrative manager, dispatch supervisor, and pump station crew are requested, as are the resumes of assigned personnel; the patrolmen and repair crew. (Section 1, Article 4)
2. The location and description, including square footage, of the bidder's current Headquarters, the spaces which shall be utilized for the EMC Office, EMC Dispatch Center, and any shop facilities as proposed to meet the requirements for the EMC 2009/2010. (Section 1, Article 4)
3. A description of the plans for service work, or in-house test facilities which the bidder would use, to overhaul and benchtest all electromechanical, solid state, microprocessor and analog and digital control equipment. (Section 1, Article 4)
4. A sample of a weekly staffing schedule for the EMC Dispatch Center, which shows number of personnel working each hour, 24/7. (Section 1, Article 4)
5. A report which provides the number of vehicles in use in the bidder's current operations, and the number of new vehicles to be purchased or leased to meet the requirements of the EMC 2009/2010. (Section 1, Article 4)
6. A report which summarizes the number and types of maintenance/construction equipment currently owned or leased by the bidder. (Section 1, Article 4)
7. Financial information, audited and certified by an accounting firm, listing company receipts for the past year(s) and/or financial means for mobilization, to purchase equipment and vehicles, and meet payroll for start-up months of this contract.
8. Copy of statement which verifies the Contractor is pre-qualified by the Department to do Electrical Construction work of the dollar amount of this contract.

The above information shall be submitted at the Pre-Bid meeting and addressed to each of the following in sealed envelopes:

Joseph S. Hill, P.E.
Engineer of Operations

Ms. Diane O'Keefe, P.E.
Deputy Director of Highways,

Illinois Department of Transportation
Electrical Maintenance Contract # 60E15
Section 1 – Contract Requirements

Various Routes
Section 2008-002TS
Various Counties

Attn.: Jim Schoenherr
2300 South Darkness Parkway
Springfield, Illinois 62764

Region One Engineer
Attn.: Stephen M. Travia, P.E.
201 West Center Court
Schaumburg, IL 60196-1096

The submitted information will be reviewed, and if requested by the Engineer, an inspection made of the prospective bidder's facilities and/or equipment. If it is determined that the prospective bidder is qualified to bid, he will be issued the "Authorization to Bid".

Article 2.0 -- Definitions, Specifications & Standards

Definitions of Terms Used Herein

AEGIS District 1 Dial-up Pump Station Alarm System

ANSI American National Standards Institute

ASMC Advanced Systems Maintenance Contract

ASSIGNED PERSONNEL

When used herein shall refer to Contractor personnel whose daily work shall normally be devoted to a particular electrical system as noted herein. Assigned personnel are not solely dedicated to performing EMC 2009/2010 work.

ATMS Advanced Traffic Management System

CLMS Closed-Loop (Traffic Signal) Monitoring System

CMS Changeable Message Sign

COMCENTER Illinois Department of Transportation, District 1 Communications Center

DAMAGED EQUIPMENT

Any piece of equipment owned or maintained by the Department that is no longer capable of functioning as originally designed, or as since modified, or any piece of equipment that has deteriorated sufficiently in the opinion of the Engineer so that failure is imminent, or for which safety could be a concern

DEDICATED PERSONNEL

When used herein shall refer to Contractor personnel whose daily work shall be devoted solely to the EMC 2009/2010

DBE Disadvantaged Business Enterprise

DID Direct Inward Dialing

DISPATCH CENTER

The Contractor's 24/7 dispatching area as required herein, also referred herein as the EMC Dispatch Center

DISTRICT 1 IDOT Department of Transportation area defined as Cook, DuPage, Kane, Lake, McHenry, Will, and a portion of Kendall Counties

DMS Dynamic Message Sign

EFO Illinois Department of Transportation, District 1, Bureau of Electrical Operations Field Office, 201 W. Center Ct., Schaumburg, IL 60196

ELU Equivalent Location Unit, the result for bidding purposes, of a total of locations per system multiplied by an assigned unit factor

EMC Electrical Maintenance Contract or the Electrical Maintenance Contractor

EMCMS Electrical Maintenance Contract Management System with emergency call-out database

EMERGENCY A condition which is a hazard to the public, or is designated by the Engineer to be a hazard of such severity that life and property are endangered and which requires immediate corrective action

ENGINEER IDOT Resident Engineer on this Contract or authorized representative

EQUIPMENT SERVICE

Refers to the servicing and/or restoration of any equipment to normal operating condition and appearance necessitated by service equipment wear-out, failure, damage or loss

FIU Field Interface Unit, sometimes called an FEP, Front End Processor

FROM ANY CAUSE WHATSOEVER

When used herein shall include any and all causes except those resulting in extensive damage from declared area wide disasters such as fires and floods, acts of the public enemy, or an Act of God. (The area wide disaster exclusion will be valid only for the time period and area as defined by a Governor's Disaster Declaration.) Damages due to lightning are not included in this exclusion.

GENERAL BILLING INVOICE

Refers to a daily invoice created by the Contractor for time and material work or additional services rendered or work performed for, or on behalf of, a 3rd party, on any part thereof or concerning System installations and equipment owned by IDOT which is included under the scope of maintenance of this contract. Examples would include 3rd party construction related damage repair invoices, work for 3rd party permits involved with construction in the state ROW, 3rd party invoicing for additional cable locate services, etc.

GUI Graphical User Interface

IDOT INSPECTOR

Employees of the Illinois Department of Transportation assigned duties by the Engineer

IMMEDIATE CORRECTIVE ACTION

Refers to all activity necessary to restore the safe operating integrity of a system or system element, without delay

IMSA International Municipal Signal Association

KNOCKDOWN (KD)

Refers to damage which results in the knockdown of a Light pole, Luminaire, or Cabinet, a Traffic Signal or Cabinet, or a Surveillance Signal, or Cabinet

LIGHTING INSTALLATION

One or more lighting units powered from one common electric service

LIGHTING SCADA

The standard specifications for the Illinois Department of Transportation, District 1, Lighting System Supervisory Control and Data Acquisition System

LOCATION For purposes of this Contract, a single defined locally-operational sub-portion of a defined system, usually having a unique electric service or service combination, operated from a unique control cabinet, building, etc., and having a unique system identifier in the Contract.

MANUAL ON TRAFFIC CONTROL DEVICES (M.U.T.C.D.)

State of Illinois "Manual on Uniform Traffic Control Devices for Streets and Highways"

MOSCAD Motorola Supervisory Control and Data Acquisition

MOSYS Motorist Outreach System, a computer system located at the Traffic Systems Center and ComCenter, which controls Dynamic Message Signs at various expressway locations

MOTORIST CAUSED HIGHWAY DAMAGE (MCHD) REPAIR FUND

A budgeted, reappropriated item in the state budget from which the Illinois Department of Transportation is given the replacement costs for damaged system equipment caused by motorists, if a police accident report links the motorist to the accident.

NEC National Electrical Code

NEMA National Electrical Manufacturers Association

NORMAL WEATHER

Time during which regular dispatch operations continue; no storm alert procedures in effect.

NON-DEDICATED PERSONNEL

When used herein shall refer to Contractor personnel whose daily work priority is the EMC 2009/2010, but whose duties may include other similar type work for the Contractor, but not within the requirements of the EMC.

NON-ROUTINE WORK

Non-routine work shall refer to all maintenance work which is not included under routine work, but which is authorized and paid separately. IDOT is under no obligation to issue authorizations for non-routine work. Methods of payment include use of contract pay items, established agreed prices, or other force mechanisms.

OSHA Occupational Safety Health Administration

PATROLMAN Defines an electrician, who is assigned regular electrical system patrol and street maintenance response duties by the Contractor. Patrolmen have the responsibility for inspecting and servicing a pre-assigned select group of installations in accordance with a defined regular time schedule. The assigned installations may be from any one (1) or all, of the Electrical Systems included under the overall scope of the Contract.

PAY MEETING

Meeting normally held on the second Wednesday morning of each month, to which the Contractor brings the monthly invoice for the payment of the reconciled quantities of routine maintenance work from the prior month.

PERMANENT REPAIR TIME

Amount of time from initial notification to the Contractor until the time permanent (non-temporary) repairs are made.

POTS Plain old telephone service

PLNC Private line telephone service which provides a direct connection between two points through an automatic ring signal at one end when initiated at the other.

PS Pump or Pumping Station

PS-SCADA The standard specifications for the Illinois Department of Transportation, District 1, for Pumping Station Supervisory Control and Data Acquisition System

QA/QC Quality Assurance/Quality Control

RESPONSE TIME

Amount of time from the initial notification to the Contractor until a repair person physically arrives at the location.

REVLAC Reversible Lane Access and Control System for the Kennedy Expressway

ROUTINE MAINTENANCE

Refers to all work required to staff, equip, patrol, inspect and maintain electrical systems, whole and operational, at locations as defined herein, except for work specifically excluded from routine maintenance coverage and paid separately as non-routine maintenance work

RUS Rural Utilities Service, USDA

SCADA Supervisory Control and Data Acquisition System

SERVICE RESTORATION TIME

Amount of time from the initial notification to the Contractor until the time the system is safe and operational. (In cases of motorist caused damage, when the undamaged portions of the system are operational.)

SPECIALTY SERVICE

Specialty Service, or Specialty Service Work shall refer to work performed by entities other than the electrical maintenance contractor who may not be pre-qualified subcontractors but whose services are necessary because of specialized equipment, specialized expertise or the maintenance restrictions on a particular piece of electrical system equipment. Examples of specialty service entities include traffic signal control equipment and cabinet repair, motor repair shops, pump rebuild shops, communication and/or electronics repair shops, manufacturer's authorized repair agents and similar service providers. Such work is not restricted to in-shop work and such services may be field-performed. Such services will not be considered as materials.

STANDARD SPECIFICATIONS

Illinois Department of Transportation's "Standards Specifications for Road and Bridge Construction"

STATE STOCK

When used herein refers to stocks of materials and equipment which are state owned, are to be kept separate from the Contractor's materials and equipment, and shall be used exclusively for the Department's installations and systems.

STORM ALERT

A communication issued by the IDOT ComCenter, as provided by its weather service. Upon receipt of this report, the EMC Dispatch Center storm alert procedure goes into effect.

SYSTEM

When used herein refers to any or all the Electrical Systems covered by this Contract such as Lighting and Sign Illumination System, Traffic Signal System, Surveillance/DMS Systems, Pump Station System and Extra Systems.

SYSTEM ENGINEER

When used herein refers to IDOT Engineers in charge of maintenance for a particular electrical system for a designated IDOT Bureau.

THIRD PARTY Any entity other than IDOT or the Contractor

TICKET Maintenance input record of the EMCMS which is used by the Contractor to record various types of malfunctions, failures, damages, knockdowns, vandalism, theft or various other concerns relating to safety matters and/or the reported follow-up response information as necessary to make temporary and/or permanent repairs to restore and/or assure that the system equipment is operating in a normal manner. A ticket consists of various entry screens; dispatch, field response, crew repair follow-up, MCHD repair log, and 3rd party damage information.

TRAFFIC SPECIFICATIONS

The Illinois Department of Transportation's "Standard Specifications for Traffic Control Items", and "Keeping the Expressway Open to Traffic".

TSC The Illinois Department of Transportation, District 1, Bureau of Traffic, Traffic Systems Center, 445 W. Harrison, Oak Park, IL 60304

TSC SPECIFICATIONS

The Illinois Department of Transportation's "Standard Specifications for Traffic Control Items" which includes current design standards for the traffic surveillance system

UPS Uninterruptible Power Supply

V.A.R. Value Added Reseller

WEEK A period of seven (7) consecutive calendar days. Any multiple of this term shall mean a corresponding multiple of number of calendar days.

WORKING DAY

The definition of a working day shall be in accordance with Article 108.04 of the Standard Specifications, with the exception that working days may be charged throughout the entire year.

YARD Any District 1 maintenance yard, sign shop, or other field facility

24/7 Refers to operations required twenty-four hours per day, seven days per week.

All definitions in referenced publications and standards shall apply, except as may be modified herein.

Specifications And Standards

The latest issue, at the bid date, of the following standards, including subsequent additions or revisions made prior to the bid date, shall apply to all work, materials and equipment furnished and installed under this Contract. In case of conflict with any or parts of the standards listed below the Special Provisions contained herein shall take precedence and shall govern. In case of conflict between referenced standards, the most stringent as determined by the Engineer, shall take precedence and shall govern.

Illinois Department of Transportation Standards And Specifications

- Standard Specifications for Road and Bridge Construction, current version
Note: Article 801.02, Standards of Installation shall apply to all systems under this Contract and is not limited to Lighting.
- Design Manual Section 3-600 published on Highway Lighting
- Flaggers' Handbook
- Highway Standards
- Manual on Uniform Traffic Control Devices
- Accommodating Utilities on Rights-of-Way of IL. State Highway System
- Recurring Special Provisions for Traffic Signals, Road and Bridge

- Special Provisions for Special Non-RCRA Waste and RCRA Hazardous Waste Working Conditions
- BDE Special Provisions
- Standard Specifications for Traffic Control Items
- Supplemental Construction Specifications and Recurring Specifications, Current Version

IDOT DISTRICT 1 - STANDARDS AND SPECIFICATIONS

- Confined Entry Space Policy
- District 1 Highway Standards
- Freeway Details Freeway Entrance and Exit Ramp Closure Details
- Traffic Control Details for Freeway Shoulder and Partial Ramp Closures
- Micro Computer Management Manual
- Permit Specifications Governing Permit Work on State Right-of-Way
- Recurring Traffic Signal Specifications
- Recurring Special Provisions for Roadway Lighting
- Resident Engineers Construction Guide for Electrical Equipment Construction on State Highways
- Standard 2308-4 (Day or Night Moving Operations)
- Standard Specifications for Electrical Maintenance Contract Management System
- Standard Specifications for the Emergency Data Acquisition System
- Standard Specifications Integrated Closed-Loop Traffic Signal Monitoring
- Standard Specification for Pump Station Supv. Control/Data Acquisition System
- Standards for Roadway Lighting by Permit on State Routes
- Standard Traffic Signal Design Details
- Traffic Signal Plan Preparation and Design Guide
- Traffic Surveillance Special Provisions & Traffic Surveillance Typical Drawings
- Keeping the Expressway Open to Traffic
- Traffic Control Plans for Daytime and Nighttime Traffic Operations

National Standards And Specifications

- An Informational Guide for Roadway Lighting, published by American Association of State Highway and Transportation Officials (AASHTO), 444 N. Capitol St., NW, Washington, DC 20001
- Insulated Cable Engineers Assn. and Underwriters Laboratories publications when applicable for cable and other materials
- National Electrical Manufacturers Association Standards, American National Standards Institute, where applicable, for signals, lamps, ballasts, and other accessories
- American National Standards Institute, where applicable, for ballasts, and other accessories
- ASTM Standards for materials
- All applicable manuals and policies of FHWA
- American National Standard Practice for Roadway Lighting, published by Illuminating Engineering Society of North America, 120 Wall St., 17th Floor, New York, NY 10005, Phone (212-248-5000)
- National Electrical Code, National Fire Protection Association, Batterymarch Park, Quincy, MA 02269, approved by the American National Standards Institute, Publication #ANSI/C2, published by IEEE, 345 E. 47th Street, New York, NY 10017
- Standard Specifications for Structural Supports for Highway Signs, Luminaires and Traffic Signals, an AASHTO Publication
- Institute of Traffic Engineers Technical Report No. 1 (A Standard for Adjustable Face Vehicular Traffic Control Heads)
- Emergency Response Guidebook by U.S. Dept. of Transportation, latest version, for further assistance call National Response Center (NRC) 1-800-424-8802
- Hazardous Materials Regulations, Hazardous Materials Transportation Uniform Safety Act of 1990, Hazardous Materials Regulations and Motor Carrier Safety Regulating by U.S. Department of Transportation
- OSHA, all applicable regulations
- RUS, all applicable regulations
- IMSA Standards & manuals

Article 3.0 – Pre-Construction Submittals

A Pre-Construction Meeting will be held. It is normally conducted during the second week of November, prior to the January 1 assumption of maintenance. The following list of reports shall be submitted:

- #1** Two (2) copies of all insurance policies (complete policies), meeting all requirements in Article 107.27 of the Standard Specifications, current version, and Article 1.8 herein
- #2** Copies of BC 260A, Request for Approval of Sub-Contractors (Article 4.2.1)
- #3** Copy of DBE Participation Statement SBE2025 and DBE Utilization Plan SBE 2026 (Article 4.2.1) previously submitted for pre-qualification to bid.
- #4** The catalog cut details of the proposed wireless field communication system, including unit models. (Engineer approval needed prior to purchase or lease). (Article 4.6.1)
- #5** A spreadsheet report which identifies all Contractor personnel, including subcontractor personnel, by assignment and job title, email address, NEXTEL(or equivalent) call and telephone number, and office telephone extension (if applicable). (Articles 4.6.1, 4.7.3, 4.11)
- #6** The name(s) of the proposed vendor(s) for EMCMS maintenance and support (submitted for Engineer approval). Contact names, email addresses, and telephone numbers shall also be provided. (Article 4.6.6)
- #7** Copy of recent photo from company assigned identification for dedicated personnel and patrolmen. (Article 4.8.1)
- #8** Company and EMC organization chart (including names and all positions as stated herein). Resumes of dedicated and assigned personnel on the EMC shall be submitted. (Article 4.8.3)
- #9** A sample of format for submittal of certified weekly payroll reports and system work reports (Article 4.11)
- #10** Outline of proposed formal training programs and name of instructors (Article 4.12.1)
- #11** One (1) copy of Company’s safety program manual and name of Safety Coordinator or Manager (Article 4.13.1)
- #12** A copy of the confined space entry and training policy and list of personnel who will be trained (Article 4.13.2)
- #13** A list of the full service contractors who will be handling the hazardous material waste from the pump stations and highway lighting locations (Article 4.13.3)
- #14** Two (2) copies of the Contractor’s Traffic Control Plan, and the name of the subcontractor for traffic control installation and maintenance, if one shall be requested for use on this Contract (Article 4.14.1)
- #15** An itemized list of all test equipment and copies of certification of calibration (Article 4.17)
- #16** A sample of all company letterhead and invoices, including 7-part MCHD statement packet (submitted for Engineer approval) (Article 5.9.5)
- #17** Two (2) copies of the Contractor’s proposed patrol schedule, in an Excel spreadsheet format, noting week, day, and stop number, for each electrical system; Lighting System, Pump Station

System, Surveillance System, Traffic Signal System, and Extra Systems (System Articles herein). The Traffic Signal System proposed patrol schedule shall include all private or county maintained locations as regularly patrolled by the Contractor (Article 5.10).

- #18** The name of the individual appointed as State Stock Manager (Article 5.14.1)
- #19** A list of the certified facilities who will be disposing used lamps (Article 5.14.4)
- #20** Temporary pump station operation plan and specifications regarding temporary pumps and list of suppliers (Article 8.4.7)
- #21** A list of vertical/submersible service repair companies (minimum six) within the tri-state area of IL/IN/WI. (Article 8.5.1)
- #22** A list of lab facilities certified to test oil and lubrication fluids (Article 8.5.1)
- #23** Name of proposed ATMS Software Vendor, resumes of qualified personnel to work on ATMS, list of previous projects by the vendor, name of contact person as well as title, phone numbers, and email address. (Article 9.1.4)

Article 4.0 -- General Contract Requirements

4.1 Basic Contract Provisions

Unless noted herein, all requirements as listed in Article 4.0 General Requirements shall be paid through, are part of, and incidental to routine maintenance.

4.1.1 Term of Contract

The Contract shall be valid for all operations from 12:00 a.m. on January 1, 2009 to 12:00 a.m. (midnight) on December 31, 2009, subject to cancellation provisions specified herein. The Contract shall remain in force, even following the completion of routine maintenance response requirements, until 12:00 a.m. (midnight) on December 31, 2010. All routine and non-routine contract work shall be completed by that date. The Contractor shall comply with authorized work completion dates; however, any authorized non-routine work which has not yet been started, due to circumstances such as delays in issuance of permits by outside agencies, will be cancelled. If the Contract is renewed, the Department shall make the effort, if circumstances allow, to re-authorize in the renewal term, any work items cancelled from the prior contract term.

4.1.2 Renewal

The Department has the sole discretion to renew this contract for one (1) additional term. This option would extend the Contract for one additional term from 12:00 a.m. January 1, 2010, to 12:00 a.m. (midnight) December 31, 2010, per all revisions or amendments as defined. If renewed, the Contract shall remain in force, even following the completion of routine maintenance response requirements until 12:00 a.m. (midnight) on December 31, 2011. All routine and non-routine contract work shall be completed by that date. The Contractor shall comply with authorized work completion dates; however, any authorized non-routine work which has not yet been started, due to circumstances such as delays in issuance of permits by outside agencies, will be cancelled.

The Contractor shall accept the renewal of the Contract if offered by the Department. Upon notification of the contract renewal by IDOT, the Contractor shall complete and submit IDOT's contract renewal form within fifteen (15) days of notification, together with documentation of the contract bond extension and copies of the required insurance policies for the renewal year as well as any other documentation required by the Department.

The original contract term and the renewal term shall be considered independent with respect to completion of work, payment, and withholding of payment as well as all associated work documentation.

No later than one month prior to the start of the renewal year, the Contractor shall provide the Department the following for approval:

- Acknowledgement of the renewal acceptance
- Documentation of the contract bond extension
- Copies of required insurance policies covering the renewal year
- Submittal of contract vehicle assignments, vehicle models and current mileage Submittal of new vehicle purchase invoices or leases (necessary to meet yearly mileage limits)
- Proposed date for vehicle re-inspection
- Requests for Sub-Contractor Approval, form BC260-A for each desired sub-contractor to be utilized in the renewal year
- A new Disadvantaged Business Utilization Plan for the renewal year on Department forms SBE 2026, and DBE Participation Commitment Statement on Department forms SBE 2025 (which must be approved by the Department prior to the start of the renewal year work)
- Submittals for any new equipment or materials not submitted and approved in the prior contract term, but anticipated for use in the renewal year

- Submittals for any changes to pay items submitted and approved in the prior contract term

4.1.3 Completion Of Annual Work

The Department shall authorize all work by the end of the Contract term and the Contractor is expected to complete said work by the agreed due date. If the one year renewal provision is exercised by the State, the renewal shall not relieve the Contractor from the requirements to complete work from the first year in a timely fashion. The existence of a backlog from a prior year shall not be a justification for delay of work in the renewal year. Incomplete routine or non-routine work without an approved delayed completion date may cause the application of liquidated damages or retainage of the routine maintenance payment.

The Engineer shall apply a withholding of up to 75% of the December, 2009 routine maintenance payment (or December, 2010 if this Contract is renewed) until all authorized routine and non-routine maintenance work is complete, but may progressively release portions of the retainage as the incomplete work is reduced. Key items for completion of work under a calendar year (or term) include:

- All routine work complete, approved, with all documentation
- All workforce analysis reports submitted and accepted
- All DBE/EEO submittals complete and accepted/approved

4.1.4 De-Authorization and/or Cancellation of Work

Work which may not be completed by the end date of the Contract, due to circumstances beyond the control of the Contractor such as major weather events, delays in issuance of permits by outside agencies, etc., shall be completed by December, 31 2010, (or December 31, 2011, if this Contract is renewed) or shall be subject to de-authorization.

Only the Department may cancel the contract. The Contractor shall be given 30 days advance notice of cancellation of this Contract. In the event of cancellation, the Contractor shall be entitled to receive payment for services and work performed and materials or equipment furnished under the terms of the Contract prior to the effective date of cancellation, but shall not be entitled to receive any damages on account of such cancellation or any further payment whatsoever. There shall be no payment for incomplete work.

The Department may take possession of the incomplete work and all materials, associated special tools and appliances, for any reason, which the Engineer deems to be in the public interest, and this decision shall be final. Upon the receipt of a notice of cancellation, the Contractor shall provide the Engineer with a list of all State Stock inventory in his possession as of that date.

4.2 Subcontracting of Work

4.2.1 General Requirements

The Contractor shall obtain approval from the Engineer for employment of all subcontractors performing work on this Contract, prior to the commencement of work. Except as modified herein, subcontracting of the contract work shall be in conformance with the requirements of the Standard Specifications and Supplements and Recurring Special Provisions.

The Contractor shall submit to the Engineer, prior to the start of work, and at the Pre-Construction Meeting:

- A request for Approval of Subcontractor, form BC260A for each subcontractor to be employed for work under this Contract
- A certification stating that the required Federal and State provisions will be inserted in the final contract with the subcontractor. Inclusion of the required contract provisions will be monitored by the Bureau of Small Business Enterprises, as part of its compliance review.

- A written subcontract agreement for each proposed subcontractor which sets forth the scope of services to be subcontracted, the lump sum or unit price for such services and the signatures of the subcontracting parties
- A copy of the Disadvantaged Business Utilization Plan on Department forms SBE 2026, and DBE Participation Commitment Statement on Department forms SBE 2025, all as required to be submitted within seven (7) working days after the date of the letting.

4.2.2 Subcontracting Limitations

In addition to the limitations imposed by the Standard Specifications, there shall not be wholesale subcontracting of the herein defined electrical systems. The Contractor shall perform not less than 51% of the maintenance of each electrical system with his own forces. Except for subcontracting of one or two patrol routes, as may be approved by the Engineer, in the fulfillment of DBE or minority participation requirements, work that depends on a dispersed workforce and timely response activities shall not be subcontracted. Moreover, there shall be no geographically-based subcontracting of the work, e.g., by north Cook or by south Cook, etc. Furthermore, the Contractor's daily management and supervision for each system, all administrative functions and dispatching, shall be done with his own forces.

Work, which is subcontracted, shall not include work which is in turn subcontracted to an additional party. Subcontracted work shall be limited to work performed by the subcontractors' own forces.

Work suggested for subcontracting, either to achieve DBE goals or to provide specialized expertise includes, but is not limited to detector loop replacements, group washing and group re-lamping, painting, tile washing, traffic control and protection, repair crew helpers, and portions of other work as required under the terms of the EMC.

4.2.3 Subcontractor Billing

For non-routine agreed price work (not pay items) performed by an approved subcontractor as named on the authorization for work and on the contractor invoice, in accordance with Article 109.04 (b)(7) of the Standard Specifications for Road and Bridge Construction, when work is performed by an approved subcontractor, the Contractor shall be allowed administrative costs of an amount equal to five (5) percent of the total approved costs on a individual work authorization, with the minimum being \$100.

Specialty service work as authorized and originated by the Department shall be considered as work by the Contractor, and not subcontracted work for purposes of billing.

4.3 Contract Transition

4.3.1 Basic Requirements

It is the obligation of the Contractor to make every effort to provide a smooth transition from the prior contract to this contract. This may involve adjustments in ongoing operations to adjust to revised contract provisions or it may involve a startup of operations and the assumption of maintenance responsibility if there is a change in Contractor. In either case, full professional cooperation by the Contractor is expected by the Department to assure that the District's electrical systems remain continuously monitored and maintained.

The Contractor shall assure the Department that at 12:01 a.m. on January 1, 2009 the maintenance transfer is complete and transparent to the public, that the District's electrical systems remain continuously monitored and maintained. It shall be recognized that the transfer and transition from one contract to the next will not be instantaneous with regard to all aspects of all systems.

4.3.2 Electrical System Survey

Following the award of the Contract the Contractor may submit to the Engineer a schedule for joint Contractor and Department inspections of all electrical systems to determine any outstanding maintenance issues. The inspections shall be completed by December 1, 2008.

4.3.3 State Stock Transfer

The Contractor shall prepare facility storage areas for delivery, during the last half of December 2008, of miscellaneous state stock not stored in the state stock warehouse. The Engineer shall provide the Contractor a list of the state stock prior to delivery.

The Contractor shall provide the Engineer on December 1, 2010 (or December 1, 2009 if this contract is not renewed) a list of all state stock inventory and its applicable location that is in his possession on that day. All state stock inventory and/or other equipment or materials owned by IDOT in the possession of the Contractor shall be moved to state owned locations or locations as designated by the Engineer, by a date to be specified by the Engineer (during December 2010, or December 2009 if this contract is not renewed). The Contractor shall use his own spare parts for contract work for the remaining days of the term of the Contract. The Contractor shall replace missing stock in kind due to loss, theft, burglary, or damage caused by his workforce.

4.3.4 Contractor Owned Spare Parts Procurement

After execution of the Contract, the Contractor shall procure the spare parts as necessary for system equipment as listed in Article 5.0 such that at the time routine maintenance activities begin, adequate spare parts, as approved by the Engineer, are on hand.

4.3.5 Locks and Keys

At the Pre-Construction Meeting the Engineer shall provide the Contractor a list of equipment; doors, cabinets, hatches, gates, and other items within the electrical systems, which will need to have locks replaced by January 31, 2009. Refer to System Articles, herein, for quantities required. The padlock shall meet the specifications of the weather resistant padlock currently utilized for the District 1 pump stations, and the key number shall be approved by the Engineer prior to the purchase/install. If additional locks are required, they shall be furnished through State Stock and installed under non-routine maintenance.

At the end of the Contract term(s) the Contractor shall make arrangements to submit to the Engineer all keys to IDOT System equipment, including alarm keys and keys to traffic signal cabinets, railroad cabinets, lighting cabinets, high mast towers, pump station gates, doors and hatches, base station fences and doors, navigational lighting equipment (including I-55 & Harlem Avenue bridge) on a date as specified by the Engineer. All existing, replacement and/or new locks added to the electrical systems during the Contract become the property of the Department.

4.3.6 End of Contract Transition

It is the obligation of the Contractor to cooperate fully to facilitate the transition period work from this contract to any subsequent contract, providing prompt communications, timely completion of authorized work, and other transfers as noted herein.

4.4 Contractor Performance

4.4.1 Priority of Work

For the Contractor's forces employed on this Contract, the work on this Contract shall take precedence over work performed for others, including other government agencies, except as expressly permitted by the Engineer or specified herein. This requirement applies to work activities on a daily basis. The Engineer reserves the authority to re-direct the Contractor's work priorities in response to emergency situations, potential hazards, contract coordination and incomplete or deficient work and the Contractor will be allowed no additional compensation for priorities so redirected.

4.4.2 Suspension Of Work

If in the option of the Engineer any work performed on this Contract may seriously jeopardize the welfare of the general motoring public, the Engineer has the authority to order the immediate suspension of the work task. Depending on the offense, the Engineer may withhold all or a portion of the monthly routine maintenance payment due to the Contractor, and/or assess liquidated damages.

4.4.3 Unsatisfactory Service

Failure to perform all functions in the manner specified herein or in the Standard Specifications, and within any time limit specified, or should the Contractor refuse or fail to perform the work or any separable part thereof promptly and in the manner specified in this Contract with such diligence as will insure its satisfactory completion, the Engineer will advise the Contractor via written transmittal regarding the nature of unsatisfactory service. The Contractor shall take necessary action to correct the items listed and shall respond back to the Engineer within five (5) working days from the time of receipt of the report, explaining the reasons for the improper service and the expected date of the resolution of the listed problems.

If after two (2) written warnings that a work item is not in Contract compliance or work has not been completed per the agreed time frame, the Engineer will take additional remedial action such as withholding of all or a portion of the monthly routine maintenance payment due to the Contractor, assessing liquidated damages, or both.

If the Contractor cannot perform the work per contract specifications, it will be the Engineer's option to require the Contractor pay another contractor, (as approved by the Engineer) for the corrective work, the actual time and materials cost of which shall be deducted from the Contractor monthly routine maintenance payment as liquidated damages.

4.4.4 Withholding and Release of Funds

The Engineer may withhold up to 100% of the total monthly routine maintenance payment for all systems for non-compliance of the Contract; the incomplete or otherwise unsatisfactory performance on any system, including but not limited to failure to respond to reported incidents in a timely manner, perform maintenance in compliance of contract requirements, complete work per the agreed time frame, or document dispatch or response work activities in the time and/or manner as specified in articles herein.

After the previously uncompleted or deficient work has been subsequently completed to the satisfaction of the Engineer, the Contractor shall advise the Engineer in writing, requesting the release of funds previously withheld. The Engineer shall approve the release of funds previously withheld from the Contractor through an authorization letter.

4.4.5 Liquidated Damages

The Engineer may assess liquidated damages, to be deducted from the Contractor monthly routine maintenance payment, for any items not in compliance of the Contract, unless the Contractor can demonstrate to the satisfaction of the Engineer, that his/her efforts were deterred by the Department, or by other contractors employed by the Department or by unforeseeable causes beyond his control and without the fault or negligence of the Contractor.

It shall be the decision of the Engineer whether the liquidated damages per day or one time charge will be assessed as follows:

Liquidated Damage Assessment

<u>Per Day</u>	<u>One Time</u>	<u>Per Contract Specifications</u>
\$200.00	\$200.00	Failure to Respond per Time Specifications
\$500.00	\$500.00	Failure to Respond per Time Specifications to a Railroad Inter-Connected Traffic Signal and/or

Make Timely Repairs, or Fix Outages

\$200.00	\$300.00	Failure to Provide Documentation
\$200.00	\$300.00	Failure to Provide Timely Repair/Replacement of Parts
\$200.00	\$300.00	Failure to Provide Proper Service
\$200.00	\$300.00	Failure to Provide Reports/Communication
\$200.00	\$300.00	Failure to Follow Specified Procedures
\$200.00	\$300.00	Failure to Provide Proper Staffing
\$200.00	\$300.00	Improper Use of Materials or Methods
\$500.00	\$1000.00	Improper Use of Traffic Control
na	\$2000.00*	Blocking Lane or Ramp to Traffic
na	\$5000.00*	Blocking Two Lanes to Traffic
\$500.00	\$1000.00	Failure to Replace State Stock
\$500.00	\$3000.00	Failure to Return State Stock at End of Contract

*per each and every 15 minute interval or portion thereof that a lane is blocked outside the allowable time limitations

4.5 Contractor Facility Requirements

4.5.1 General Requirements

At the time of bidding the Contractor shall have an established business presence in the District to assure the timeliness of the assumption of the contract work on the first day of the Contract.

The Contractor shall have and maintain adequate facilities at all times for the timely completion of work under this contract. These facilities shall include an EMC Office and 24-hour Dispatch Center and other permanent facilities, which may be strategically located, geographically, to support the Contractor's work force. The size and type of facility may vary depending on the location, type, and quantity of electrical equipment to be serviced within that area.

All Contractor's facilities shall be complete and ready for operation no later than December 23, 2008, ready for a demonstration inspection by the Engineer, except that dial-up phone numbers which are transferred from the outgoing contractor need not be established by the Contractor until a mutually acceptable date is arranged with the Engineer.

4.5.2 EMC Office

The Contractor shall establish, for the duration of this Contract, a contractor's office in-District, (in the six county area covered by this Contract) for management of all contractor work under this Contract. This EMC office may be a satellite office remote from the Contractor's headquarters or it may be a singular and clearly-defined section within the Contractor's in-District headquarters. In order to facilitate communication and shared interest in contract matters, the contract management and technical/administrative functions as defined herein and represented in the Contractor's organization chart shall not be dispersed throughout various areas of the Contractor's operations but shall be established here

as an identifiable group with dedicated physical space. One desk shall be dedicated for use by IDOT personnel when they are in the office and this space shall have a chair, working telephone, EMCMS terminal, and file cabinet with padlock approved by the Engineer.

4.5.3 EMC Dispatch Center

Unless another location is approved by the Engineer, the Contractor's in-District headquarters or in-District EMC office shall include the 24/7 hour operations of the EMC Dispatch Center, which may be used for other Contractor dispatch functions, but shall be adequately equipped and staffed to service the EMC on a first-priority basis. This function cannot be sub-contracted.

The EMC Dispatch Center shall contain a minimum of four (4) desks and chairs for dispatch personnel, shall be equipped by the Contractor with adequate lighting, voice and data communications lines and equipment necessary to perform contract monitoring functions, system alarms, and the like, including, but not limited to equipment for the emergency call-out database, the EMCMS, the lighting system SCADA, the dial-up pump station alarm system (AEGIS), and the pump station SCADA telemetry system, and the CLMS for traffic signal alarms for all brands of signal systems in use throughout the contract.

The space shall be suitably equipped to protect system electronic equipment. The designated space shall have a HVAC system, air cleaner, emergency lighting, fire detection and smoke detection system. An on-line (true) UPS system is required to provide clean power and back-up electrical power for all dispatch electronic equipment for a minimum of eight (8) hours.

A back-up communications system shall also be in place for emergency back-up communications provisions for a minimum of eight (8) hours. Proper rack(s) for all computer equipment shall be furnished, which shall be a minimum of eighteen (18) inches above floor level. The space shall be kept at a temperature optimum for proper performance of the required electronic equipment, and free of dust and/or other contaminants.

4.5.4 Equipment Service Shop

Unless another location is approved by the Engineer, the headquarters shall incorporate facilities for the testing and repair of traffic signal controllers, lighting controllers, luminaires, pump controls, DMS equipment, surveillance equipment, and similar equipment maintained under this contract. These facilities shall be adequately equipped with instruments, test rigs and the tools necessary for the work.

The traffic signal portion of the facility shall be able to handle a minimum of, but not limited to, 600 controller and auxiliary failures a year, which includes electrical-mechanical, solid-state analog, solid state digital, and microprocessor equipment.

Typical testing facilities should include a minimum of five (5) work stations consisting of printers and computers of sufficient operating capacity, to troubleshoot system equipment (masters, local, telemetry modules and modems) and monitor, on a daily basis, the closed loop traffic control system.

4.5.5 Storage Facilities

State Stock Warehouse

To facilitate security, inventory control, physical separation of state owned materials from Contractor materials, and to reduce costs of material transfers when there is a change of Contractor, most state stock inventory is currently housed at a commercial bonded warehouse at Combined Warehouse Co., 5000 South Central, Chicago, Illinois, 60638 (hereafter referred to as the state stock warehouse).

The state stock warehouse shall be centrally located to the District's major concentration of systems, and located within the boundaries of Devon Avenue on the north, 63rd Street on the south, Cicero Avenue on the east, and I-355 on the west.

The Contractor shall obtain a minimum of 10,000 square feet of rental storage space at the state stock warehouse. The storage arrangements must also include 7 day, 24 hour security, an hourly rate for necessary on-site equipment and labor to access any stored item, all warehouse material handling fees, and a mechanism for formal check-in and check out of materials. The inventory management shall include computerized record keeping of all inventory and all transactions, including regular monthly reports and occasional reports, on demand by the Engineer. All costs for the state stock warehouse shall be included in routine maintenance.

If the Engineer requests additional state stock warehouse storage space, the Contractor shall be reimbursed through non-routine maintenance at the same rate per sq. ft. as the approved state stock warehouse costs.

Any change in the designation of the state stock warehouse, or facility requirements, shall require approval of the Engineer. The Contractor shall have the option of retaining storage at the existing state stock warehouse or providing an alternate commercial bonded warehouse which is suitable for storage of materials of the type used for the District's electrical maintenance, and meets the space and facility requirements of the current state stock warehouse. All costs associated with any transfer of state stock inventory from the existing state stock warehouse to an approved alternate warehouse shall be borne by the Contractor, and no additional compensation will be allowed.

Contractor Storage Facilities

The Contractor shall have and furnish sufficient and adequate types of material storage areas, stock room space and shelving to house materials and equipment for use on this Contract. Equipment and parts to be used on system equipment including controllers and traffic signal heads and anything which comes boxed or which could deteriorate or be damaged by exposure to the weather shall be stored indoors. The Contractor shall obtain Engineer approval for all state stock to be stored other than in the State Stock Warehouse.

All state stock inventory shall be clearly identified and physically separated from the storage of Contractor-owned materials and equipment. State stock shall be kept screened or fenced, with locked access.

Insurance and Inspections

The Contractor shall provide insurance coverage for all state stock inventory in the possession of the Contractor or in the state stock warehouse, for losses due to fire, theft or vandalism. Estimated value of current stock on hand is approximately \$500,000.

The Contractor shall comply with the instructions given by the Engineer relating to the care, storage, and marking of state stock inventory for identification purposes. The Engineer shall be allowed access to inspect state stock inventory at the Contractor's designated sites or the official state stock warehouse at any time.

4.6 Communication Equipment

4.6.1 Wireless Field Communication Systems

The Contractor shall have in place, a district-wide wireless field communications system with a central base established at the Contractor's EMC Dispatch Center or other location as approved by the Engineer.

To assure a consistent and reliable transmit and receive coverage throughout the entire 4400 square mile geographic area of District 1, the Contractor shall have a multiple-location-infrastructure based, digital wireless communications system (trunked radio system with integral cellular telephone capability) as offered by Nextel™ or an equivalent provider.

To facilitate Contractor communications, timely transmission of data, inspection of work by Department personnel, and transmittal of photos of damage to state property, individual units shall be assigned as described herein. All Contractor patrolmen, dedicated personnel positions, field supervisory or management personnel, subcontractor supervisory personnel, and thirty-five (35) Department EMC

supervisory field inspection personnel and communications center personnel shall be provided units with features equal or better than Nextel ic902. Unlimited direct talk, voice, and text, 2.0 megapixel camera, and email photo transmittal features shall be provided for each assigned unit.

Cigarette lighter charger/adapters, AC recharging units in the form of cords, largest Lithium-Ion battery available, separate carry case or protector (unless flip-top model), belt carry attachment, and twenty-five (25) hands-free receivers equal or better than Motorola H710, meeting all requirements of state laws and designed for the approved model, shall be provided for Department units. As these units are used for field work, it may be necessary for the Contractor to replace up to five inspector units or receivers, and furnish additional new parts, holsters, chargers, adapters or batteries to all units, as necessary, during each contract year. The Contractor shall furnish field email access for data/photo transfers for each unit, all necessary cables, original CD with PC compatible software for the programming of numbers, name changes, and other programmable functions, and device necessary for the copying of SIMS cards.

Each communication unit shall be new, and models and accessory equipment shall be approved by the Engineer prior to purchase or lease by the Contractor. The Contractor shall submit catalog cuts of the proposed system, units, and programming software, at the Pre-Construction Meeting.

The list of proposed call numbers shall be furnished to the Engineer for approval and assignment by December 1, 2008. The system shall be in purchased or leased, and units delivered, ready for programming, with applicable software and cables, by December 15, 2008.

The Contractor is responsible under routine maintenance for the monthly billing and other provider assistance as necessary for data transfers and proper operation of the communication units.

4.6.2 Voice and Data Communication Lines

The Contractor shall have the following telephone and data communications lines installed and fully operable by January 1, 2009:

- One (1) high speed T-1 data line between IDOT and the Dispatch Center for the Lighting and Pump Station SCADA and EMCMS connections
- One (1) dedicated “hot-line” (PLNC) between the Dispatch Center and the ComCenter
- A minimum of eight (8) incoming voice lines to the Dispatch Center available to police agencies, etc. (The Contractor shall not utilize an automated voice-answering or voice mail option for the Dispatch Center.)
- Minimum of one (1) high speed data line from the nearest EMCMS node to the EMC Contract Office for the EMCMS terminals.
- One (1) telephone lines (DID or POTS) at the Dispatch Center for dial-up access to the Pump Station’s AEGIS equipment
- One (1) telephone line (DID or POTS) at the Dispatch Center for dial-up access to the Lighting SCADA
- Three (3) telephone lines (DID or POTS) at the Dispatch Center for dial-up access to the Pump Station SCADA
- One (1) telephone line (DID or POTS) at the Dispatch Center for dial-up access from the PS SCADA field processor to the PS SCADA

- Seven (7) telephone lines, (2 lines to monitor Econolite signals, 2 lines to monitor Eagle signals and 3 lines for polling the traffic signals) as applicable for Traffic Signal System, refer to Article 10.0
- Minimum one (1) ISDN line for video monitoring of the traffic signal intersections
- One (1) high speed data line between the qualified vendor facility and TSC for maintenance and support of ATMS
- Other telephone lines as necessary for Contractor communications, and Plan Record System, or other Systems as needed

The Contractor shall keep a list of all contract required telephone lines, their outlet locations, and applicable telephone numbers. The Contractor is responsible under routine maintenance for installation charges, monthly billing, number change charges, and any other related telephone installation charges.

4.6.3 Supervisory Control And Data Access System (SCADA)

Lighting SCADA System

At the time of the award of this Contract the Engineer shall provide the Contractor a list of lighting SCADA equipment in the possession of the outgoing contractor. On December 30, 2008, or a date as approved by the Engineer, the Contractor shall move the applicable lighting SCADA system and appurtenances to its EMC Dispatch Center. The SCADA Specialist shall assist in the transfer of equipment.

The Contractor shall, at his expense, provide a Motorola V.A.R. to furnish (if required) and install antennas, coaxial cable, and appurtenant equipment in order that on or by December 2, 2008, the Motorola V.A.R. shall test the four port communications system. The Contractor shall provide documentation to the Engineer from the Motorola V.A.R. that the lighting SCADA system is installed correctly and operating accordingly. The Contractor shall assure a fully functional lighting SCADA system by January 1, 2009.

As part of the lighting and pump station SCADA hardware configuration, the Contractor shall furnish a high speed data connection between the IDOT Schaumburg servers and the required EMC Dispatch Center servers. This high speed data connection shall provide a means of connecting the Schaumburg server and the EMC server computers via ethernet. The high speed data line shall be a dedicated point to point connection, and all related hardware and cabling shall be provided by the Contractor. The Contractor may use a common T-1 line and combine communications for the Lighting SCADA, PS SCADA and EMCMS. All installation and integration work shall be coordinated by the SCADA Specialist. The data line and hardware shall be configured and ready to be connected to SCADA hardware by December 15, 2008. The Contractor shall assure network connection between the computers and data integrity by January 1, 2009.

At the end of the Contract term(s) the Contractor shall cooperate fully with the Engineer to move the applicable Lighting SCADA system and appurtenances from his possession.

Pump Station SCADA System

At the time of the award of this Contract the Engineer will provide the Contractor a listing of all Department owned PS SCADA equipment currently in the possession of the outgoing contractor.

The Contractor shall furnish and install his own antenna pole tower, antenna line, antenna and all appurtenance connectors for the radio link of the PS SCADA system to the IDOT base station. This system shall be set-up and ready for radio implementation by December 2, 2008.

On December 30, 2008, or date as approved by the Engineer, the Contractor SCADA Specialist shall coordinate and arrange for a factory licensed sales and service company for Microwave Data System radios, to install the PS SCADA radio at the Contractor's EMC Dispatch Center.

The radio shall be installed and connected to the Contractor's radio equipment to create a complete operational radio system. The Contractor shall provide documentation to the Engineer that the SCADA radio system is installed correctly and operating accordingly.

The satellite central processor (slave) shall be transferred to the Contractor at the same time as the radio equipment, on December 30, 2008, or date as approved by the Engineer. This work shall be performed by the SCADA Specialist.

As part of the Pump Station SCADA hardware configuration, a high speed data connection shall be furnished between the IDOT Schaumburg and the EMC Dispatch Center. This high speed data connection shall provide a means of connecting the Schaumburg server and the EMC server computers via Ethernet. The high speed data line shall be a dedicated point to point connection, and all related hardware and cabling shall be provided by the Contractor. The Contractor may use a common T-1 line and combine the communications for the Lighting SCADA, PS SCADA and EMCMS. All installation and integration work shall be coordinated by the SCADA Specialist. The data line and hardware shall be configured and ready to be connected to SCADA hardware by December 15, 2008.

The Contractor shall have a fully operational PS SCADA system by January 1, 2009 and shall program all PS SCADA controllers to dial-up the Contractor's Dispatch telephone numbers by January 31, 2009.

At the end of the Contract term(s) the Contractor shall cooperate fully with the Engineer to move the applicable PS SCADA system and appurtenances from his possession.

4.6.4 AEGIS Alarm System

On January 1, 2009, the Contractor shall accept the transfer of the existing Pump Station AEGIS telephone line from the outgoing contractor. The Contractor shall assure that all units are functioning for emergency call-out to the receivers and shall supply and program PROM chips as required for each alarm transmitter unit, or arrange for transfer of the alarm notification telephone number, as necessary, to assure a functioning alarm system. By January 31, 2009, the Contractor shall have all pump station AEGIS prompts programmed to the Contractor's AEGIS phone number.

At the end of the Contract term(s) the call forwarding of the AEGIS telephone number shall remain in place for approximately one month, and shall only be terminated upon notification of the Engineer.

4.6.5 CLMS

Refer to Article 10.0, Traffic Signal System.

4.6.6 EMCMS – Electrical Maintenance Contract Management System

General Requirements

Successful performance of the Electrical Maintenance Contract is highly dependent upon an emergency call-out database, electrical systems inventories, and a timely, accurate flow of information regarding contract work and billing. The Electrical Maintenance Contract Management System (EMCMS), which facilitates the emergency call-out database and these functions, consists of hardware, software, and an information database to support these Contract needs. The hardware includes one database server with Solaris OS, one application server, one infrastructure server (both with Windows 2000 OS), one Veritas 4.5 Net backup unit in the ComCenter equipment room, routers, switches and other network equipment, one development workstation with Windows XP OS, Oracle 9 ids software or as updated, MS Office, and several workstations and several printers in District 1 Headquarters, Electrical Field Office, Traffic Systems Center, and Contractor locations.

The Contractor shall maintain the existing established Department EMCMS, which shall continue into this Contract to assure operational continuity. No disruption of the instantaneously-available emergency call-out location master information to the District 1 ComCenter will be permitted.

The Contractor is required to have the complete EMCMS, including full data access through screens/reports, communication links, and all required equipment as specified elsewhere herein, in place at the EMC Office and EMC Dispatch Center for approval by the Engineer by December 23, 2008. The EMCMS entry documentation shall begin as of midnight January 1, 2009. The Contractor is allowed, however, until January 10, 2009 to complete entry of all patrol schedules for all systems.

Vendor Qualified Maintenance

The Contractor, under routine maintenance, shall provide system maintenance and system support for the EMCMS from an established, qualified business entity or a combination of entities, as a specialty service approved by the Engineer. Where multiple entities are used to provide the specified service and support, the division of responsibilities shall be identified. Minimum requirements for the combined service entity or entities include an existing business presence within District 1, 24/7 on-call service capability, on-line monitoring and intervention capabilities, experience in programming using the existing system software, qualified ongoing experience with hardware of the type installed, and qualified ongoing experience with software of the type installed.

As part of vendor-qualified service, the Contractor shall obtain for the Department, annual maintenance agreements:

- 1) From the data base vendor for software
- 2) From the server/operating system vendor for the database servers and its OS
- 3) From the Net Backup Unit vendor for the tape back up unit and its software

The maintenance agreement for the database servers shall include 24/7 onsite coverage with two (2) hour response time. Maintenance agreements shall be vendor standard offerings, which shall include, as a minimum, software upgrades; and 24/7 telephone and web based support. Unless otherwise approved by the Engineer, all EMCMS vendor maintenance agreements shall be in effect for the period of April 1, 2009 to March 31, 2010, and shall be renewable for the second year. The Contractor may utilize the existing maintenance agreements for the period of January 1, 2009 through March 31, 2009.

If system upgrades of hardware or software are necessary to assure continuity of service and vendor maintenance support, the Contractor shall propose necessary upgrades to the Engineer for approval. The costs for the necessary upgrades and installation, if approved by the Engineer, will be paid through non-routine maintenance under agreed price, from budget allowance Pay Item GV01 (\$30,000). Upon approval by the Engineer, the Contractor shall furnish and install upgrades, and care shall be exercised to assure the preservation of system data.

Only Department approved maintainers may perform any changes on the EMCMS. To assure security and integrity of the system, the Contractor may use the current maintainer of the EMCMS, Xsys Inc., 653 Steele Drive, Valparaiso, IN. 46385. For questions regarding the current maintenance of the EMCMS, the bidders may contact Xsys at telephone 219-477-4816.

At the Pre-Construction Meeting the Contractor shall provide the Engineer with the name of the proposed EMCMS maintainer for Department approval. Should the Contractor intend to choose a new maintainer, he/she shall also submit the qualifications and references of the company, and a detailed emergency operations/system support plan.

System Maintenance

The Contractor shall provide maintenance and operational support for all hardware (IDOT and Contractor owned or leased), including communications hardware between the servers and all remote workstations, software, and information as carried in the database. All items, including paper, and work necessary to assure a functional operating system in all locations, shall be the responsibility of the Contractor. In

addition, in 2009 the Contractor will need to furnish and install four (4) Epson LQ-2090 units or equal, as approved by the Engineer, as replacement units for current obsolete equipment. The contractor shall provide space and access to system equipment at the designated or approved Contractor facilities for the installation and maintenance of all system equipment. Also refer to EMCMS equipment maintenance requirements in Article 11.0

The Contractor Administrative Manager shall respond to Department maintenance calls within one hour, providing the estimated time of repair, programming correction, or service restoration.

Normal service restoration for all EMCMS equipment, (all hardware, software, and information as carried in the database software, or communications, including communications hardware between the headquarters computer and all remote terminals) shall be within twelve (12) hours, except as otherwise permitted by the Engineer.

All costs for system operation and maintenance, except for the existing IDOT telephone lines and power provided by the Department shall be borne by the Contractor and included in the routine maintenance bid prices for all systems.

Maintenance requirements shall include daily on-line monitoring of system and equipment status, and daily data back-ups by qualified personnel, with preventive maintenance or component replacement as required to forestall preventable system failures. A dedicated telephone line shall be allowed into the server at the Schaumburg IDOT Headquarters for use by the Contractor furnished programmer/service technician, as approved by the Engineer.

Operational support as included under routine maintenance shall include two hundred hours of programming support per year for adjustments to system programs to address system malfunctions and occasional modifications or additions to the tables, screens, and reports employed in the system. An accounting of the time utilized shall be submitted monthly in the routine maintenance documentation book. User documentation, as existing, and as developed during the course of this Contract shall be provided to the Contractor and the Department.

Site Inspection

As part of the site inspection visits offered by the Department prior to bidding, a limited tour of the EMCMS equipment and operations at various IDOT locations, including the District 1 Headquarters in Schaumburg will be offered to familiarize bidders with the equipment and condition of the existing system. The Contractor shall also be provided with a list of screens, reports and user functions.

Equipment Requirements

The Contractor is responsible for establishing EMCMS communications between the Contractor's facilities and the central computer at District 1 Headquarters and for providing terminals and other peripherals for Contractor access to the system. Minimum requirements include:

EMC Office:

Minimum of three (3) shared printers, one with tractor feed and one (1) workstation for:

- Each electrical System Manager
- Administration Manager
- Administrative Assistant

EMC Dispatch Center:

Minimum of two (2) shared printers, and three (3) workstations

End of Contract Term Requirements

The Contractor shall contract with an applicable subcontractor, as approved by the Engineer, to provide programming support and equipment in order to continue to perform certain specified functions on the EMCMS until all work, both routine and non-routine is complete, per Contract term requirements. These

necessary functions include the data query of location maintainer and owner information, completion of work repair Tickets, accounting of state stock, invoicing of routine and non-routine work, and providing Motorist Caused Highway Damage logs, statements and invoices.

EMCMS Screens and Reports

The following EMCMS screens and reports are to be maintained by the Contractor. This is an approximate list, however, and items may be added or deleted at any time. The Contractor is responsible for the data entry for most listings.

IDOT/Contractor Screens:

Ticket View/Entry
Ticket History Look-up
Ltg Ticket MCHD Look-up
Equipment and Labor Rates
Patrol Schedules
ComEd Info Entry
Location View
Location Locate
Location Update
Pay Item Letter Entry/View
Agreed Price Letter Entry/View
Vendor Letter Entry/View
Quote Letter Entry/View
Log Invoice Received
SS Control Cabinets
SS Control Cabinet Parts
SS Cables
SS Luminaires
SS Luminaire Parts
SS Mast Arms
SS Miscellaneous
SS Poles
SS Pole Parts
SS Tower Parts & Equipment
SS Reset SS Quantities
Supervisory Approval/Auth Ltr
RE/Bureau Chief Approval/Auth Ltr
Apprv to Transmit Pay Item Ltr
Apprv to Transmit Agreed Price Ltr
Apprv to transmit Vendor Ltr
Schedule Auth. Letter for Pymt
Schedule Auth. Letter for Pymt
Cable Locate Entry

Screens for IDOT Use Only:

Tech Pay Item Letter Mgmt
Tech Agreed Price Letter Mgmt
Tech Vendor Letter Mgmt
Ticket Entry
Location Names Update
Auth. Letters Transmitted by Date
Maintain C.O.D.

IDOT/Contractor Reports:

Ticket Summary - All
Ticket Summary – Not Completed
Ticket Screen Report
Ticket Chronology – All Systems
Pay Item Listing
Owner/Maintainer By Intersection
ON RM Locations
OFF RM Locations
RM Status
Patrol Schedule Report
Patrol Exceptions Report
Print Pay Item Letter
Print Agreed Price Letter
Print Vendor Letter
Non-State Owned Intersections Report
Print TS MCHD Statement
Print Ltg MCHD Statement
Print Quote Letter
Print Quote Letter Summary
Print Invoice
Letters Ready to be Logged
Outstanding Auth. Work
List of Transmitted Auth. Letters
List of All Auth. Letters
CWL per Auth. Letter
CWL Summary
Work Compl/Not Apprv or Not Inv
Vendor Payment Status
SS Inventory Summary
SS Inventory Transaction Details
SS EMC Inventory Transaction Details
SS Other Contractor Inventory Transaction Details
SS Inventory Activity
Auth. Letter Ready for Suprv Review
Auth. Letter Approved/Ready to Transmit

Reports for IDOT Use Only:

EMC Budget Report
Tickets Completed Count
Tickets Not Completed Count
EMC 1999-2000 Financial Statement
EMC 2001-2002 Financial Statement
EMC 2003-2004 Financial Statement
EMC 2005-2006 Financial Statement

Maintain LD & Retainage	EMC 2007-2008 Financial Statement
Maintain RM Monthly Pymt	Update Pay Item Usage
Maintain MCHD Monthly Claim	Print Pay Item Usage
Modified Auth Letters	Police Agency Report
Maintain Pay Item Description	Category Report
New Location Street Names	Owner Report
New Location Cross Reference	Maintainer Report
Police Agency Entry	MCHD Chronology
Maintain Category Code	MCHD Claims Collections/Month
Maintain County Code	Ticket Number Police Report Request
Maintain Owner List	TS MCHD Statement
Maintain Maintainer List	Ltg MCHD Statement
MCHD Log Entry	MCHD Accident Report Request
Ticket Number Request Entry	MCHD Monthly Summary

4.7 Contract Administration And Correspondence

4.7.1 Daily Contract Administration

The EMC will be administered by the IDOT District 1 Bureau of Traffic Operations. The Resident Engineer, Mr. Rao Vaitla, will be responsible for the control of the work. The Contractor Project Manager shall communicate with the IDOT Resident Engineer on all formal contract matters. Contractor Supervisors and Administrative personnel shall normally communicate with the IDOT System Engineers and Technicians.

The Contractor shall address all matters of Contract interpretation or dispute at the lowest possible level. Issues which are not addressed to the Contractor's satisfaction at the Engineer/Technician level may be raised first to the IDOT Resident Engineer level and if not resolved may be raised to the level of Bureau Chief of Traffic Operations, Mr. Steve Travia.

4.7.2 Formal Correspondence

All formal correspondence to IDOT regarding contractual matters shall only be submitted by the Principal or Project Manager and shall be addressed as follows:

Ms. Diane O'Keefe, P.E., District Engineer
Illinois Department of Transportation, District 1
Attn: Mr. Stephen M. Travia, P.E.
Bureau Chief of Traffic Operations
201 W. Center Court
Schaumburg, Illinois 60196-1096

cc: H. Rao Vaitla, P.E. Resident Engineer

4.7.3 Informal Correspondence

Informal correspondence related to day-to-day maintenance matters shall be made by means of email where possible, or fax, and may be made directly to the parties involved. The Contractor Project Manager, all System Managers, EMC Working Foremen, EMC Specialists, EMC Administrative Manager and assistant, EMC Dispatch Supervisor, and other personnel as requested by the Engineer shall have an email address. The email service used by the Contractor shall not be a service that attaches advertising to email. The Contractor shall have and maintain plain paper facsimile (fax) equipment at the headquarters, EMC Office, and EMC Dispatch Center, for the purpose of rapid dissemination of written information not in email form.

The Project Manager shall communicate with the Resident Engineer on all contract matters. System Managers and administrative personnel shall normally communicate with the IDOT System Engineers and Technicians.

4.7.4 Work Status Meetings

Work status meetings may be requested by the Engineer or the Contractor. These meetings shall normally be held once per month, but may be held weekly if necessary. The Contractor Project Manager, Systems Managers, Specialists, Working Foremen, or other personnel, as requested by the Engineer, shall attend work status meetings, when requested by the Engineer.

4.8 Contract Personnel

4.8.1 General Responsibilities

The Contractor shall at all times provide a force of qualified personnel, approved by the Engineer, sufficient in number to simultaneously perform the routine maintenance work, non-routine work and any specialized work operations required and described herein, and/or emergency operations at all times of the day and night.

All personnel working on IDOT systems and equipment shall have the proper training associated with their working environment, and shall use safety practices in accordance with OSHA rules and regulations such as those associated with confined space, fall protection, and lock-out-tag-out.

Except as otherwise restricted, the Contractor may utilize the workforce employed on this contract to serve the maintenance needs of other parties, however, this Contract requires that the Department of Transportation's work shall take precedence over other work. The Engineer may grant the Contractor authorization to postpone IDOT work to address emergency situations of others, but the shortage of workforce shall otherwise be insufficient grounds for the Contractor's failure to perform routine or other non-routine work within the prescribed time constraints.

The Engineer retains the right to reject the Contractor's structure for management of the contract if the specific requirements defined herein are not addressed or if the proposed structure or staffing is such that the effective execution of contract performance is compromised. If work performance is not acceptable to the Engineer, the Contractor shall have thirty days, after written notification is received, to comply with a personnel position change, as approved by the Engineer, or liquidated damages shall be assessed.

The Contractor shall remain responsible for any and all union agreements applicable to his workforce on the Contract. Union jurisdictions and other union contract requirements shall not become grounds for failure to perform the contract work.

The Contractor shall provide individual photo card identification for all personnel working on the Electrical Maintenance Contract.

4.8.2 General Workforce Responsibilities

The Contractor's workforce shall possess the skills and knowledge necessary to perform all work consistent with the best practices of the trade. The workforce shall include personnel having certain special expertise, including, but not limited to the following:

- Materials Management
- General Electrical Power
- Building Wiring (Indoor Electrician)
- Motor Controls and Control Systems
- Various Types of Pump Rebuild
- Various Types of Mechanical Work
- Low Voltage Power Distribution Systems
- Roadway Electrical (Outdoor Lineman)
- Telemetry/Telecommunications
- Traffic Signal Closed Loop Monitoring System
- Fiber Optic Cable Installation and Repairs

- Hardware/Software Troubleshooting
- Dynamic Message Sign Technology
- Programmable Logic Controller Installation and Maintenance
- Lighting SCADA Trouble-shooting
- Pump Station SCADA Trouble-shooting
- Office Administration

4.8.3 Organizational Documentation

Certain operational capabilities, functions and relationships are prescribed in this Contract. The Contractor shall produce an organization chart to document the chain of command and demonstrate compliance with the requirements defined by the contract, including reporting relationships of field personnel. The submittal shall provide the name of individuals assigned to all positions as required herein, both dedicated and assigned (non-dedicated). This document shall be submitted with the pre-bid qualifications, re-submitted at the Pre-Construction Meeting with any proposed revisions, and submitted to the Engineer at any time there is a change in personnel or the chain of command.

The Engineer may also reject the assignment of specific personnel to certain functions if the Contractor fails to demonstrate the qualifications matching personnel to defined responsibilities.

4.8.4 Principal (Owner) or Project Manager Responsibilities

Experience has shown that personal involvement of a Principal, an officer of the company with signature authority, is inevitable in all major or overall contract matters under the Contract. The Principal may, however, establish a Project Manager to be responsible for performance of the contract, and have the authority to fully represent the Principal in all matters on this Contract. The requirements for attendance at monthly pay meetings, signing of documents and meeting with Department representatives, and other overall-contract duties, may also be delegated to the Project Manager.

Any Project Manager so established shall have supervisory authority over all System Managers.

Reporting to Principal or Project Manager:

- Traffic Signal System Manager
- Lighting and Repair Crew Manager
- Surveillance/DMS System Manager
- Pump Station System Manager
- Dispatch Supervisor
- Administrative Manager

If at any time, the Engineer determines that a Project Manager has insufficient authority and flexibility to effectively manage the work under the contract, the Engineer retains the right to demand the Principal be in charge of the contract, with appropriate attendance at meetings, etc.

To assure 24-hour continuity of a person in responsible charge of the Contract, the Contractor shall establish a prioritized list of staff who are to act, with full authority to speak definitively for the Principal, relative to this contract, in the event of illness, vacation, or other similar lack of availability of the Principal and, if established, the Project Manager. The Engineer shall be notified as far in advance as possible whenever a substitute Principal officer, Project Manager or System Manager is necessary. System Managers may act in a temporary substitute capacity for the Principal or Project Manager, while retaining their day-to-day responsibilities, however, the Engineer must be notified of the substitution.

If a Project Manager position is established, the individual appointed to this position shall be approved by the Engineer prior to the start of the contract.

4.8.5 System Manager Responsibilities

System Managers shall report directly to the Principal or Project Manager as applicable. If specified herein to be dedicated fully to work under this Contract, System Managers may only be released from Contract obligations through written approval by the Engineer or his appointed representative. Responsibilities of the System Managers shall include:

- Authority to commit workforce and other resources at all times and/or as directed by the Engineer on a 24 hour basis, seven days a week
- Preparation of the daily agenda
- Daily review of ticket summary
- Daily review and timely distribution of all maintenance repair and modification work documentation including daily agenda, ticket follow-up data, and miscellaneous reports
- Overseeing of maintenance transfers and new installation inspections
- Lane closure requests and implementation of approved traffic control plans
- Coordination of emergency operations for the applicable system(s)
- On a rotating basis, be on call 24 hours per day as an Emergency Response Coordinator, prioritizing the emergency response for all electrical Systems. In this capacity the System Manager shall coordinate with the EMC Dispatch Center Supervisor and also have the authority to call out additional personnel for dispatching or patrol duties. (Refer to Article 5.0 Call-Out Policy).
- Supervision of all routine and non-routine work in the assigned system

4.9 Dedicated Personnel Positions

4.9.1 Responsibilities of Dedicated Personnel

In order for the Contract to function effectively specific personnel functions are required to provide quality maintenance service to the public. Furthermore, the size of the Contract dictates that certain personnel be dedicated to this maintenance Contract in full-time capacities as specified herein. No dedicated EMC System Manager, or other EMC personnel, shall hold more than one EMC job responsibility as described herein or as shown on the Contractor's organization chart, unless as approved in writing by the Engineer.

Personnel noted as dedicated herein shall perform work as assigned for this Contract, until authorized routine and/or non-routine work is complete to the satisfaction of the Engineer, except when emergency situations take precedence or a release is given by the Engineer or Systems Engineer.

Dedicated Positions in the EMC: (alphabetical order)

- EMC Administrative Manager
- Lighting and Repair Manager
- Lighting Night-Rider Patrolman
- Pump Station Specialist (Working Foreman)
- Pump Station Crew (4)
- Repair Crew (20) of which (4) perform Light Tower work
- SCADA Manager
- SCADA Trainee
- Surveillance Specialist (Working Foreman)

Surveillance/DMS Patrolmen (4)
Traffic Signal Manager
Surveillance Trainee

4.9.2 EMC Administrative Manager

The Contractor shall appoint an EMC Administrative Manager, dedicated to this Contract, who shall work in the EMC Office and oversee all administrative functions of the Contract. This individual shall supervise the daily activities of the EMC Administrative Assistant(s), and shall be responsible for various documentation submittals to the Engineer (refer to Article 5.0) such as Motorist Caused Damage Repair Logs and Statements, the Monthly Routine Maintenance Work Documentation Book, properly formatted quotes and authorizations on the EMCMS, and documentation of timely payment to specialty vendors.

Required qualifications include:

- BA or BS Degree
- Minimum of three (3) years of business experience with a contractor or in a related field
- Minimum of five (5) years experience with Windows 98 or better and spreadsheet software
- Good verbal and written communication skills

The individual appointed to this position shall be approved by the Engineer prior to the start of the contract.

4.9.3 Lighting And Repair Manager

The Contractor shall appoint an individual to the position of Lighting and Repair Manager who shall be dedicated to this Contract and who shall have full daily responsibility for all maintenance and modification work of the Lighting System and Extra Systems, under this contract. In addition, this individual shall manage a portion of the Repair Crew, (refer to Article 4.9.7).

This individual shall be responsive to the needs of the Lighting and Extra Systems and may be requested to attend weekly work progress meetings at the electrical field office. Various IDOT system representatives shall have free access to this Manager to address specific system repair issues. In the event of conflicts in work priorities the Principal/Project Manager shall coordinate service acceptable to the Engineer.

This individual shall have the ability to manage a staff of twenty or more, shall communicate effectively, and have knowledge of electrical codes and work related safety practices (OSHA).

The individual appointed to this position shall be approved by the Engineer prior to the start of the contract.

Required Qualifications:

- Minimum of ten (10) years electrical and mechanical maintenance experience as an electrical tradesperson with local electrical contractor companies working on the construction and maintenance of various types of highway lighting and/or other electrical systems
- Experience in the operation of IDOT electrical control circuits
- Ability to interpret contract drawings and wiring diagrams
- Familiarity with diesel engine power generators and related transfer switches for back-up power
- Familiarity with fiber optic signs and CCTV
- Familiarity with fiber optic trunk lines
- Familiarity with cable underground work
- A valid electrician's card
- Valid driver's license and ability to respond in the field
- Available for 24/7 emergency call-out

The individuals appointed to this position shall be approved by the Engineer prior to the start of the contract.

4.9.4 Lighting Night-Rider Patrolman

One (1) individual shall be dedicated to the EMC in the position of the all systems Night-Rider Patrolman, who conducts an outage survey for the highway lighting locations, sign illumination locations, navigational lighting locations, and extra system installations three (3) weeks per month, and performs other assigned duties for the System Managers, or warehouse duties as assigned by the Lighting/Repair Crew Manager for other times.

Required Qualifications:

- Minimum of two (2) years experience with Windows XP or 2000 and Excel software
- Minimum of two (2) years experience with the EMCMS
- Knowledge of IDOT highway lighting and sign structure identification system
- Ability to perform work at night
- Valid driver's license

The individual appointed to this position shall be approved by the Engineer prior to the start of the contract.

4.9.5 Pump Station Specialist (Working Foreman)

The Contractor shall appoint an individual as the Pump Station Specialist who shall be a Working Foreman, and shall be dedicated to this Contract. This individual shall supervise the PS Service Crew in their daily work activities at pump stations, shall conduct patrol inspections, and perform assigned routine or non-routine work. The individual appointed to this position shall be approved by the Engineer prior to the start of the contract.

The Pump Station Specialist shall be on-call for mechanical malfunctions or during emergencies at pump stations resulting from rainstorms, power outages, hazardous materials conditions, etc., which may cause travel hazards to the motoring public.

This individual shall be fully responsible for compliance with all NEC requirements.

Required Qualifications:

- Minimum of eight (8) years hands-on experience working with 240V and 480V 3 phase motors, relay logic control systems, vertical/submersible pumps and their appurtenant equipment
- Trained and skilled, capable of troubleshooting and repairing pumps and other mechanical equipment located at each pump station
- Familiarity with relay logic controls
- Valid electrician's card
- Valid commercial driver's license and ability to respond in the field
- Available for 24/7 emergency call-out

4.9.6 Pump Station Service Crew

The Contractor shall employ a Pump Station Service Crew, individuals sufficient in number, a minimum of four (4), dedicated to this Contract, to perform routine and non-routine work, including equipment malfunction trouble-shooting, follow-up repairs, testing, pump rebuilding and replacement work, and an inspection of each pump station once per month. The PS Service crew may perform non-routine unit price work, however, the Contractor shall obtain approval for the use of this personnel for any non-routine agreed price work.

The Pump Station Service Crew shall be on-call during emergencies at pump stations resulting from rainstorms, power outages, hazardous materials conditions, etc., which may cause travel hazards to the motoring public.

These individuals shall be fully responsible for compliance with all NEC requirements.

The individuals appointed to this position shall be approved by the Engineer prior to the start of the Contract.

Required Qualifications:

- Minimum of five (5) years hands-on experience working with 240/480V 3 phase motors
- Familiarity with HVAC
- Knowledge of pump maintenance procedures
- Familiarity with pump break-down and re-builds
- Familiarity with the installation of submersible/column pumps
- Valid electrician's card
- Valid commercial driver's license and ability to respond in the field
- Available for 24/7 emergency call-out

4.9.7 Repair Crew

The Contractor shall employ a minimum contract repair crew workforce of twenty (20) individuals whose work shall be dedicated to the repair work on this Contract unless formally released. Work performed by the repair crew may involve any of the systems covered by this contract. Work includes damage repair; motorist caused damage repair, modifications to system installations, troubleshooting special maintenance problems, cable repairs, temporary signal installations, loop repairs, and other authorized routine or non-routine work. The Repair Crew shall be trained for emergency response call-out to pump stations. Foremen may be applied toward required crew personnel.

The Contractor is responsible for all repair crew work assignments, however, under normal operations, it is expected that a minimum of ten (10) individuals shall be regularly assigned for Traffic Signal System work, and ten (10) individuals for Lighting System, Pump Stations, Surveillance Systems and Extra Systems work. When assigned to work on a specific System, the Repair Crew personnel shall be made responsible to the Contractor's manager of the respective System for the work.

The Contractor shall train, staff, and provide proper equipment for not less than three (3) loop crews to operate simultaneously, although they need not be exclusively assigned to loop repair work.

Due to the increase in light towers and highway lighting in general, the Contractor shall train, staff, and provide proper equipment for two (2) light tower crews to operate simultaneously, to meet routine maintenance work requirements. If the workload allows, one crew may be released for other system repair work.

Unless otherwise permitted by the Engineer, the Contractor shall have 50% of the required level of repair crew personnel engaged in contract work on a daily basis by January 1, 2009, and the required 100% staffing by March 15, 2009, and on a continuing daily basis through the remainder of the contract.

Required Qualifications:

Ten (10) of the required twenty (20) individuals shall have:

- Valid electrician's card and a minimum of four (4) years electrical and mechanical maintenance experience as an electrical trades person with local electrical contractor companies

One (1) individual shall have:

- Minimum of two (2) years of work experience in splicing, termination and testing of fiber optic cable
- Successfully completed a four-day (minimum) training in the "installation of fiber optic products" conducted by a major manufacturer of fiber optic products or a generic fiber training session as approved by the Engineer

One (1) individual shall be:

- Skilled to perform electrical work within buildings, with valid union license

All individuals shall have:

- Union journeymen level electrician's license
- Skills in all typical highway system general work, construction and/or repair of traffic signals, surveillance equipment, lighting or sign equipment, etc.
- Ability to interpret contract drawings and wiring diagrams
- Ability to read current and voltage readings and use meggers, multimeters, and other test equipment
- Valid driver's license and ability to respond in the field
- Available for 24/7 emergency call-out

The individual(s) appointed to this position shall be approved by the Engineer prior to the start of the contract.

4.9.8 SCADA Specialist

The Contractor shall assign an individual to the position of SCADA Specialist, who shall be dedicated to contract work, and shall perform pump station patrol inspections, troubleshoot pump station and lighting SCADA systems, as directed by the PS Manager, and occasionally troubleshoot malfunctions on the Dynamic Message System for the Surveillance/DMS Manager, as directed by the Surveillance/DMS Manager.

The SCADA Specialist shall be on-call for emergency response situations or call-out for emergencies at pump stations resulting from rainstorms, power outages, hazardous materials conditions, etc., which may cause travel hazards to the motoring public.

This individual shall be fully responsible for compliance with all NEC requirements.

The individual appointed to this position shall be approved by the Engineer prior to the start of the contract.

Required Qualifications

- Electrical Engineering degree or equivalent technical school certification
- Three (3) years working experience on Windows 95/98/2000 and NT and familiarity with Windows XP operating system setup
- Working knowledge of ladder logic GUI programming
- Trained on RSView 32 Project Development, Control Logix 5000 and Liq. V Programming
- Ability to perform telephone data line troubleshooting via implementation of break-out box
- Knowledge of dynamic data exchange communications
- Knowledge of open database architecture
- Valid electrician's card
- Valid driver's license and ability to respond in the field

4.9.9 SCADA Trainee

The Contractor shall assign an individual to the position of SCADA Trainee, dedicated to this Contract who shall perform pump station patrol inspections, and assist the SCADA Specialist in troubleshoot pump station and lighting SCADA systems, as directed by the PS Manager.

The SCADA Trainee shall be on-call for emergency response situations or call-out for emergencies at pump stations resulting from rainstorms, power outages, hazardous materials conditions, etc., which may cause travel hazards to the motoring public.

This individual shall be fully responsible for compliance with all NEC requirements.

Required Qualifications:

- Minimum of three (3) years experience with Windows 2000 and Windows NT operating system setup
- Trained on RSVIEW 32 Project Development, Control Logix 5000 and Liq. V Programming
- Familiarity with wiring of control systems
- Familiarity with ladder logic programming or traffic signal programming
- Familiarity with telephone data line troubleshooting via implementation of break-out box
- Familiarity with dynamic data exchange communications
- Familiarity with open database architecture
- Valid electrician's card
- Valid driver's license and ability to respond in the field

The individual appointed to this position shall be approved by the Engineer prior to the start of the contract.

4.9.10 Surveillance/DMS Specialist (Working Foreman)

The Contractor shall appoint a journeyman electrician to the position of Surveillance/DMS Specialist (Working Foreman) to be dedicated to the Surveillance/DMS Systems and have daily responsibility to oversee the work of the Surveillance/DMS Patrolmen. With Engineer approval, this individual may also serve as the Surveillance/DMS Manager.

This individual normally performs patrol duties on the Surveillance/DMS Systems, investigates 3rd party damage issues, oversees maintenance transfers or new installation inspections, coordinates requests for lane closure approvals, and attends field site meetings to discuss equipment modifications.

Required Qualifications:

- Minimum of ten (10) years electrical maintenance experience in telemetry, traffic signals, electrical controls, instrumentation, communications networks or other similar large-scale wide area distributed systems and with experience in Surveillance/DMS system maintenance and in electrical construction
- Significant experience with large scale FSK tone telemetry systems
- Significant experience with various types of telecommunication systems
- Experience in planning and coordinating diverse and numerous work tasks
- An IMSA level II certificate and Work Zone Safety certificate
- Familiarity with single mode fiberoptic cable installations
- Familiarity with IDOT Traffic Control Standards
- Familiarity with CCTV system troubleshooting and repair
- Ability to troubleshoot and repair fiberoptic cable
- Familiarity with fiber optic and LED DMS and CCTV
- Familiarity with OSHA Safety Standards
- Communication and documentation skills
- Valid electrician's card
- Valid driver's license and ability to respond in the field
- Available for 24/7 emergency call-out

During emergencies resulting from rainstorms, power outages, hazardous materials conditions, etc., which may cause travel hazards to the motoring public, the Surveillance System Manager shall be responsible for the Contractor's emergency response call-out for the Surveillance Systems. This individual shall meet the approval of the Engineer.

4.9.11 Surveillance/DMS Patrolmen

The Contractor shall appoint a minimum of four (4) Surveillance/DMS Patrolmen, dedicated to the Surveillance/DMS System. Their basic work assignments shall be the patrol duties, preventive maintenance, outage surveys dynamic message sign locations and response services for the

Surveillance/DMS Systems. It is not expected that call-out duties on other systems shall be required except in emergency situations, however, these Patrolmen shall be cross-trained for the Traffic Signal System.

The individuals appointed to this position shall be approved by the Engineer prior to the start of the contract.

Required Qualifications:

- Minimum (5) years construction experience with electronic equipment and communication repair
- Minimum (5) years Surveillance System maintenance experience
- Minimum (3) years traffic signal maintenance experience
- Minimum (3) years DMS MOSYS maintenance experience
- Fiber flip disk and LED DMS maintenance experience
- Ability to troubleshoot low voltage equipment malfunctions
- Familiarity with single mode fiberoptic cable installations
- An IMSA level II certificate
- Familiarity with IDOT Traffic Control standards
- Familiarity with OSHA safety requirements
- A valid electrician's card
- Valid driver's license and ability to respond in the field
- Available for 24/7 emergency call-out

4.9.12 Traffic Signal System Manager

The Contractor shall appoint an individual to the position of Traffic Signal System Manager who shall be dedicated to this Contract and have full daily responsibility for all maintenance and modification work of the Traffic System installations under this contract.

The Traffic Signal System Manager shall retain supervisory authority over all EMC work performed by the minimum twenty-six (26) Patrolmen assigned to the Traffic Signal System, including maintenance response work outside the work of this Contract, but he shall not be responsible for other traffic signal construction work being performed by the Contractor under other contracts. The Traffic Signal Systems/Railroad Specialist, the Traffic Signal System/Railroad Trainee, and all Equipment Shop personnel shall report to the Traffic Signal System Manager. In addition, this individual shall manage a portion of the Contract Repair Crew.

During emergencies resulting from rainstorms, power outages, hazardous materials conditions, etc., which may cause travel hazards to the motoring public, the Traffic Signal System Manager shall be responsible for the Contractor's emergency response call-out for the Traffic Signal System.

The individual appointed to this position shall be approved by the Engineer prior to the start of the contract.

Required Qualifications

- Degree from an Electrical Technical Institute or Electrical Engineering College
- Have or be in the position of obtaining an ISM level III certificate by July 1, 2009
- Ability to manage a technical staff of fifty (50) or more and communicate effectively
- Minimum of ten (10) years experience in construction, maintenance, and operation of all traffic signals and traffic signals systems currently being used in District 1
- Hands-on ability to solve trouble calls for any traffic signal cabinet or communications failure
- Knowledge of the operation of software for the Econolite, Eagle, Peek, Traconex, and Transyt Traffic Signal Closed Loop Systems, controller and equipment operations manuals, and equipment safety and Work Zone Traffic Control and Protection measures
- Valid electrician's card
- Valid driver's license and ability to respond in the field

4.9.13 Surveillance/DMS Crew Trainee

The Contractor shall assign an individual to the position of Surveillance/DMS Crew Trainee, dedicated to the Surveillance/DMS system, who shall perform preventative maintenance, patrol duties, and provide backup assistance during emergencies for the Surveillance/DMS Systems Patrolmen.

The individual appointed to this position shall be approved by the Engineer prior to the start of the contract. The Contractor shall confirm to the Engineer, by June 1, 2009, that the trainee has enrolled in the local union's electronics school.

Required Qualifications

- 1 year Construction experience in either Traffic Signals or Surveillance installations
- Union helper or groundsman level status
- Attain IMSA level 1 certification by October 1, 2009
- Valid drivers license and the ability to respond in the field
- Available for 24/7 emergency call-out

4.10 Assigned Contract Personnel Positions

4.10.1 Responsibilities of Assigned Contract Personnel

Assigned Contract Personnel hold required positions in the EMC, are listed on the EMC organization chart, and normally work daily on the EMC, but since they may have additional assignments they are not required to be dedicated to Contract work.

Assigned Position in the EMC:

Dispatch Center Supervisor
Dispatch Center Personnel
Equipment Shop Personnel
Patrolmen
Pump Station Manager
Traffic Signal/Railroad Specialist
Traffic Signal Systems Trainee

4.10.2 Dispatch Center Supervisor

The Contractor shall provide an assigned EMC Dispatch Supervisor in the EMC Dispatch Center, on duty during the hours of 7 a.m. to 3 p.m., Monday through Friday. A substitute, on-call EMC Dispatch Supervisor shall be available for consultation by the EMC dispatch staff or IDOT Departmental staff during the remaining hours of the week.

It is the responsibility of the EMC Dispatch Center Supervisor to supervise the EMC dispatch staff, to monitor the entry of all tickets in the EMCMS in order to meet the one (1) hour entry requirement, and to disseminate on a daily basis the ticket summary reports and maintenance transfer reports to all Departments and Contractor System Managers, and to provide monthly updated patrol reports for the routine maintenance documentation book.

Required Qualifications:

- Minimum of four (4) years experience in electrical construction work administration or dispatch
- Minimum of two (2) years experience with Windows XP/2000 or the EMCMS
- Good verbal and written communication skills

The individual(s) appointed to this position shall be approved by the Engineer prior to the start of the contract.

4.10.3 Dispatch Center Personnel

The Contractor is responsible to provide trained, responsive dispatchers, 24/7.

Minimum Required Staffing:

Monday through Friday, 7 A.M. to 3 P.M. -- 2 dispatchers and 1 supervisor

Monday through Friday 3 P.M. to 11 P.M. -- 2 dispatchers and an on-call supervisor

Other Normal Operational Times: -- 1 dispatcher and an on-call supervisor

During Storm Alerts (as received from IDOT ComCenter):

2 dispatchers and an on-call supervisor, (from start time of storm until clearing notification is received from IDOT ComCenter)

Historically the EMC Dispatch Center creates approximately 10,000 work tickets per year on the EMCMS. Other dispatcher duties include documentation of cable locate requests, 3rd party damage reports, maintenance transfers, water on pavement reports, maintenance of EMCMS database, and call-out duties for incidents reported to the Dispatch Center for locations as maintained by the state, county, and municipalities.

Although past dispatching experience is not a requirement, it is essential that the individuals on staff be willing to learn, both dispatching and computer skills for the EMCMS, and are able to speak clearly and distinctly. Due to the importance of the dispatcher duties to the success of the EMC operations, if the dispatcher work performance is not acceptable to the Engineer, routine maintenance payment may be withheld, or liquidated damages assessed.

4.10.4 EMC Administrative Assistant

The administrative functions on the EMC require either a full-time EMC Administrative Assistant or the duties may be shared between a part-time Administrative Assistant and an EMC Dispatcher.

Suggested work includes:

- EMCMS Logging of non-routine work authorizations
- EMCMS Logging of non-routine work completion dates
- EMCMS Entry of motorist caused damage repair logs as received from crews
- EMCMS Entry of motorist caused damage statements (invoices)
- EMCMS Entry of work quotes
- EMCMS Entry of state stock inventory
- EMCMS Non-Routine work invoicing
- 3rd party damage repair invoicing
- Coordination of Contractor Advisory Reports
- Routine maintenance monthly invoicing
- Coordination of weekly certified payroll submittals
- Subcontractor approval documentation submittals
- DBE documentation submittals
- EEO documentation including workforce analysis submittals
- Coordination of the monthly routine maintenance work documentation book

Qualifications include a minimum five (5) year's administrative experience, preferably with a contractor or in a related field, a minimum of five (5) years' experience with Windows 98 or better software, spreadsheet software, and good verbal and written communication skills.

The individual(s) appointed to this position shall be approved by the Engineer prior to the start of the contract.

4.10.5 Equipment Service Shop Personnel

The Contractor shall provide sufficient Equipment Service Shop personnel to meet all equipment repair time requirements as stated herein. Work shall include, but is not limited to, the service and overhaul of

Surveillance and DMS system equipment, and traffic signal equipment. Types of work includes repair of controllers and programming, bench tests all types of electromechanical, CMOS, solid state, microprocessor, analog and digital control equipment, and surveillance system tone equipment including DMS control equipment. The Contractor shall be aware of requirements stated herein as to the use of new versus repaired equipment (refer to specific system articles).

Required Qualifications:

- Associate Degree from a 2-year technical college
- Minimum five (5) years of related equipment troubleshooting, bench experience, and problem solving diagnostic experience

The individual(s) appointed to this position shall be approved by the Engineer prior to the start of the contract.

4.10.6 Patrolmen

Patrolmen shall perform response services, on a daily basis, for all of the various systems under this Contract, but the basic work assignment for the Patrolmen shall be the regular patrol of traffic signals, and emergency call-out response for the Traffic Signal System. Those patrolmen assigned to the Traffic Signal System shall also be cross-trained in the Surveillance/DMS Systems.

Although not dedicated to EMC Contract work, the Contractor shall assign twenty-six (26) individuals to be TS Patrolmen. The Contractor is required to have these Patrolmen on duty to meet one (1) hour in-district response requirements as stated in Article 5.0 and patrol requirements as stated in Article 10.0.

A sufficient number of the Patrolmen shall be scheduled for night, weekend and holiday patrol duties to meet the one (1) hour in-district response requirements.

The TS patrolmen shall maintain the integrity of all timing, parameter programming information, traffic responsive and time of day signal systems, and shall be trained to troubleshoot equipment malfunctions including all closed loop signal system malfunctions.

If the routine work performance, including response time, is not acceptable to the Engineer, the number of required Patrolmen shall be increased to twenty-eight (28). The Contractor shall have thirty days to comply with this change, after written notification is received.

Required Qualifications:

TS Patrolmen

- Experienced journeymen-level technician
- An IMSA level II certificate
- Minimum of eight (8) years experience with NEMA traffic signal closed loop systems operating in the traffic responsive mode.
- Valid electrician's card
- Valid driver's license and ability to respond in the field
- Available for 24/7 emergency call-out

The individuals appointed to this position shall be approved by the Engineer prior to the start of the contract.

4.10.7 Pump Station System Manager

The Contractor shall appoint an individual to the position of Pump Station System Manager who shall be assigned to have full daily responsibility for all maintenance and modification work of the Pump Station System. His duties shall not be delegated to the Pump Station Specialist (working foreman) or others

unless released by the Engineer. The individual appointed to this position shall be approved by the Engineer prior to the start of the contract.

The Pump Station System Manager position need not be dedicated to this Contract, but he is expected to devote a significant portion of his time to pump station activities on a daily basis. The other work activities of the Pump Station System Manager must be significantly related to the technology and type of work employed in the Pump Station System, and shall allow daily supervision of work activities of the Pump Station Specialist (working foreman), and Pump Station Service Crew, SCADA Specialist, and SCADA Trainee. He shall be stationed at the facility from where the Pump Station Service Crew is dispatched daily.

It is the responsibility of the Pump Station Manager to recommend modifications or upgrades to optimize the existing PS System, to troubleshoot all facets of pump station equipment, and to be fully responsible for compliance with all NEC requirements.

During emergencies at pump stations resulting from rainstorms, power outages, hazardous materials conditions, etc., which may cause travel hazards to the motoring public, the Pump Station System Manager shall be responsible for the Contractor's emergency response call-out for the Pump Station Specialist, Pump Station Specialist Trainee, and Pump Station Service Crew, and when assigned by the Project Manager, shall direct other Contract personnel in emergency response duties for the Pump Station System. Refer also to responsibilities for hazardous materials operations in Article 4.0.

Required Qualifications

- Technical Institute certificate/diploma
- Extensive construction experience in mechanical/electrical of pump station or commercial work
- Facility and building work
- Basic fundamental skills, knowledge and understanding of power distribution
- Eight (8) years of electrical and mechanical maintenance experience, working on all types of storm water pumping station equipment
- Knowledge of implementation and preventive maintenance of vertical and submersible pumps
- Familiarity in the maintenance and operation of switch-gear and circuit protection equipment
- Familiarity with motor control panel/alarm wiring
- Familiarity with low voltage motor-control centers for 3-phase (240/480) systems
- Familiarity with engine power generators and related transfer switch equipment
- A valid electrician's card
- Valid driver's license and ability to respond in the field
- Available for 24/7 emergency call-out

4.10.8 Traffic Signal Systems/Railroad Specialist

The Contractor shall appoint a highly skilled and trained Engineer or Technician to provide technical expertise to all patrolmen and signal technicians responsible for the traffic signal systems, and to manage the trouble-shooting of all types of system equipment at various field sites. Responsibilities shall also include the overall maintenance of the Closed Loop Traffic Signal Monitoring System Equipment, alarm monitoring and follow up of all CLMS daily activities.

Required Qualifications:

- Degree from an Electrical Technical Institute or Electrical Engineering College
- An IMSA level III certificate
- Ability to communicate effectively
- Demonstrable knowledge and minimum of eight (8) years experience in operations of all traffic signals and traffic signals systems currently being used in District 1
- Hands-on ability to solve trouble calls for any traffic signal cabinet or communications failure

- Knowledge of the operation of software for the Econolite, Eagle, Peek, Traconex, and Transyt Traffic Signal Closed Loop Systems, controller and equipment operations manuals, and equipment safety and Work Zone Traffic Control and Protection measures
- Valid electrician's card
- Valid driver's license and ability to respond in the field

The individual appointed to this position shall be approved by the Engineer prior to the start of the contract.

4.10.9 Traffic Signal Systems Trainee

The Contractor shall appoint a qualified Traffic Signal Systems Trainee who shall work daily with the Traffic Signal System/Railroad Specialist to provide technical expertise to all patrolmen and signal technicians. Responsibilities include alarm monitoring and CLMS daily work activities.

Required Qualifications:

- Degree from an Electrical Technical Institute or Electrical Engineering College
- Ability to communicate effectively
- Demonstrable knowledge and minimum of four (4) years experience in traffic signal maintenance or demonstrate skills in computers or electronics
- Valid electrician's card
- Valid driver's license and ability to respond in the field

The individual appointed to this position shall be approved by the Engineer prior to the start of the contract.

4.11 Personnel Documentation

The Contractor shall remain responsible for any and all union agreements applicable to his/her work force on this contract. Union jurisdictions and other union contract requirements shall not become grounds for failure to perform the contract work.

If union apprentices are working on this Contract, local union certification or federal approval must be submitted prior to submitting certified payroll reports.

The Contractor shall submit EMC and all Subcontractors' records, to the EEO/Labor Compliance Area, District 1, Schaumburg, of the following reports:

- Certified Weekly Payroll Reports, SBE 348
- A Weekly Workforce Report , SBE 956
- Quarterly DBE reports

The Contractor shall submit to the Engineer, weekly, a single report with the following:

1. Identification of employee (name or employee number)
2. Total weekly hours worked by the employee
3. Total weekly hours worked on EMC, listing hours worked per system and category (routine and non-routine)

The Contractor shall maintain a current list of all personnel (including sub-contracting personnel) assigned work on the EMC, applicable radio call numbers, telephone numbers, and/or pager numbers. This list shall initially be furnished to the Engineer at the Pre-Construction meeting and the Contractor shall issue an updated list, at each monthly pay meeting, with changes in personnel highlighted on each revised list.

4.12 Personnel Training Programs

4.12.1 General Requirements

Proper training of contract personnel shall assure acceptable maintenance by the Contractor while attaining the highest level of safety for contract personnel and the motoring public. The training programs listed herein shall be completed by June 1, 2009, unless otherwise approved by the Engineer. Although these personnel training programs shall be included under routine maintenance, depending upon the dedicated personnel workday, the Contractor may be required to conduct these training sessions on employee overtime. Training may be required more than once per year if situations and/or personnel changes occur.

The training programs shall be taught by qualified instructors, and where certification of the trainer is applicable, the trainer shall be certified. The Contractor shall provide the Engineer a list of the proposed training schedule with the name of the trainer at the Pre-Construction Meeting. The instructor and instructional materials shall be approved by the Engineer prior to the training sessions. The Contractor shall update the routine maintenance work documentation book monthly with any training schedule changes and following each training session shall submit an employee attendance list. The Contractor shall provide for the attendance of IDOT inspectors, maximum of twelve, at each training session. The Engineer may arrange for use of the District 1 auditorium classroom for large training session(s) if sufficient advanced notice is given.

4.12.2 OSHA and Other Safety Training

The Contractor shall establish training for all personnel in applicable OSHA requirements and other safety-related topics, to include but not be limited to; lock-out/tag-out, confined space, safety, hazmat training, respirator training (as applicable), use of safety harnesses for work on signs and other structures and basic first aid.

4.12.3 National Electrical Code/Grounding/Lightning Protection

The Contractor shall establish a training program(s) not less than one (1) day in duration per contract year to address proper and safe grounding, and/or National Electrical Code, and/or lightning protection of electrical systems. The program shall be taught by a professional trainer regularly engaged on this topic, and the training shall specifically address applications to typical IDOT systems such as electrical installation and maintenance, traffic signals, highway lighting and pump stations. This training shall be provided for all appropriate technical personnel, including all personnel engaged in electrical wiring work.

4.12.4 Equipment/System Training

The Contractor shall provide in-house or local training sessions for those individuals who would be maintaining specific equipment on this Contract, for equipment requiring detailed maintenance or troubleshooting and/or situations requiring special attention, or for specific procedures which are unique to this Contract. Requirements include:

Traffic Signal System:

The Contractor shall provide user training on traffic signal controller operations, from the controller manufacturers, for all Patrolmen, the TS Specialist and Trainee, Surveillance/DMS Patrolmen, and IDOT personnel, for each of the types of controllers in use by the Traffic Signal System in District 1, or as approved by the Engineer, including but not limited to:

- NEMA TS-1 cabinets
- NEMA TS-2 cabinets
- Econolite System controllers
- Eagle System controllers
- Peek System controllers
- Intersection controllers – Transyt, TCT, Multisonic, Traconek, Eagle, Econolite, Peek, Honeywell
- Video Detection – Iteris, Autoscope
- Conflict Monitors – EDI
- MMU – EDI, Reno, Econolite

- BIU – Eagle, Econolite
- Traffic Signal troubleshooting
- Traffic Signal System timings
- Fiber Optic troubleshooting
- Radio interconnect troubleshooting
- System and intersection controller software uploading and downloading
- Detector amplifiers
- Grounding troubleshooting
- UPS systems

Lighting System:

Personnel working on the Lighting System shall have basic training on the following items:

Cabinet Control:

- Clock programming
- Control wiring
- SCADA MOSCAD alarm response
- Lock out – tag out
- Lighting SCADA training

The Contractor shall schedule formal advanced training from an approved trainer on the Lighting SCADA radio (ACE3600) system for the SCADA Specialist, SCADA trainee, applicable patrolmen and three (3) IDOT Engineers/Technicians.

Pump Station System:

The SCADA Specialist, SCADA Trainee, Surveillance/DMS Patrolmen, PS Specialist, PS Service Crew, Repair Crew or any Contractor personnel, conducting any routine and/or non-routine work on the Pump Station System shall have introductory training on the following items:

- Ladder logic
- Mechanical training
- Emergency response training for water-on-pavement
- Emergency response training for hazardous material situation
- Lock out – tag out
- PS SCADA maintenance and troubleshooting

The Contractor shall schedule advanced training on the SCADA system for applicable employees and the PS IDOT Engineer. Training shall include how to make changes or updates to show old and new equipment on the existing system, and removing or adding a pump station from the system. The Contractor shall develop and submit a manual to explain the SCADA system change procedures for the equipment at the pump stations, the ComCenter, and Contractor locations, by April 1, 2009.

Microwave System Configuration Training:

The Contractor shall provide an instructor and three day class by Proxim Systems Training which shall cover the following subjects of broadband wireless basics and advanced broadband wireless, Tsunami PTP and Tsunami MP.11, Lynx, TeraBridge, GigaLink, TeraOptic, Quickbridge, Wifi solutions, ORINOCO Access points and clients. Any field processors needed for class training, and/or as described herein, shall be made available by the contractor.

EMC Dispatch Center:

The Dispatch Center Supervisor, substitute supervisors, and all Dispatch Center personnel shall be trained on Contract EMCMS entry and documentation requirements and SCADA requirements.

Prior to the start of the Contract:

The Contractor shall conduct a one-day training seminar on EMCMS entry and documentation and other Contract requirements. Upon completion of the seminar each dispatcher on duty shall be competent to complete the following:

- Ticket entry on EMCMS
- Maintenance transfer documentation
- Cable locate entry of EMCMS
- Traffic signal patrol logging
- Water on pavement reporting
- Acknowledge/Response for PS SCADA
- Acknowledge/Response for Lighting SCADA
- Acknowledge/Response to AEGIS alarms

Prior to the EMCMS training seminar:

The Contractor shall conduct a field tour for all dispatch personnel to learn the names of the various systems' electrical equipment to aid in Ticket entry. An IDOT Engineer/Inspector shall also accompany the group.

4.13 Safety Programs and Requirements

The Contractor shall assign an individual to the position of Surveillance/DMS Crew Trainee, dedicated to the Surveillance/DMS system, who shall perform preventative maintenance, patrol duties, and provide backup assistance during emergencies for the Surveillance/DMS Systems Patrolmen.

The individual appointed to this position shall be approved by the Engineer prior to the start of the contract. The Contractor shall confirm to the Engineer, by June 1, 2009, that the trainee has enrolled in the local union's electronics school.

Required Qualifications

- 1 year Construction experience in either Traffic Signals or Surveillance installations
- Union helper or groundsman level status
- Attain IMSA level 1 certification by October 1, 2009
- Valid drivers license and the ability to respond in the field
- Available for 24/7 emergency call-out

4.13.1 General Requirements

The Contractor shall establish a formal safety program to assure overall safety of EMC personnel, operations and the electrical systems maintained as they affect the safety of the motoring public and the public at large. The Contractor shall furnish an overall description of this program at the Pre-Construction Meeting, and furnish the name of the Safety Coordinator or Manager.

As part of the safety program, the Contractor shall initiate a procedure that states: "When a circuit is de-energized, the Contractor shall meter the downstream circuits with an instrument to assure that they are de-energized and safe for working conditions." The Contractor shall be fully responsible for compliance with all OSHA requirements. Particular attention is directed to the lock-out/tag-out requirements to assure that systems undergoing maintenance work cannot be inadvertently energized, causing harm to maintenance person.

The Contractor shall assure that all personnel be trained in, and have knowledge of, approved equipment grounding methods for all work under this contract. The Contractor shall be fully responsible for compliance with all NEC requirements. The Contractor shall be responsible for the maintenance of all existing system and equipment grounding under routine maintenance.

Should locations be identified for which system or equipment grounding is missing or otherwise not in compliance with NEC requirements, the Contractor is obligated to report such locations to the Engineer.

The Contractor shall keep all systems free of hazards to the work force and the public, all in conformance with Article 107 of the Standard Specifications. Special care shall be taken to assure that electrical systems are not left in an exposed or otherwise hazardous condition. All electrical boxes, cabinets, pole handholes, etc., which contain wiring, either energized or non-energized, shall be closed or shall have their covers in place and shall be locked when configured for locking, except when work is being done at the location at the moment. If the worksite is left, enclosures shall be closed and no potentially hazardous electrical situation shall be left unattended.

4.13.2 Confined Space Entry And Training

The Contractor shall submit at the Pre-Construction Meeting, a copy of the Contractor's confined space entry and training policy which shall be in full compliance with all OSHA requirements for the duration of this Contract. Employees shall be required to:

- Follow all general safety rules and regulations
- Abide by confined space regulations
- Wear proper safety equipment at all times
- Report unsafe conditions to supervisory personnel and IDOT Engineer
- Report any injuries sustained within a confined space

The Contractor shall train and provide safety equipment to all field personnel that are involved with work within a space, as defined as confined space within the training policy. A listing of personnel who are trained or who will be trained for entry into confined spaces shall be included in the Pre-Construction Meeting submittal.

4.13.3 Hazardous Materials Operations

All activity with contaminated waste shall conform to the Department's Standard Specifications for Road and Bridge Construction Article 669. The Contractor shall employ for emergency hazmat response the services of, or have a full-service Subcontractor designated as the EMC hazardous waste contractor, familiar with and capable of complying with all federal, state, or local regulatory requirements/regulations pertaining to RCRA hazardous and special non-RCRA waste management, and shall be responsible for ensuring the implementation of these requirements. The hazardous waste contractor shall have a 24-hour emergency call number and shall be capable of responding to a pump station within one (1) hour of notification. No additional compensation will be allowed for these services.

The Pump Station Manager shall direct the hazardous waste contractor and other Contractor personnel as necessary to remove and properly dispose of oil, gasoline or other pollutants from the pump station wet pit, or other area as directed. Removal shall be by means other than pumping pollutants into the normal station discharge sewer or receiving open water channel. (The Contractor may store suitable absorbent battens in a drum at each pump station which discharges to a waterway.)

The Contractor shall provide a list of proposed full service contractors, for Engineer approval, at the Pre-Construction Meeting.

The EMC hazardous waste contractor shall:

- Coordinate with all pertinent regulatory agencies to secure all necessary permits and approvals and shall be responsible for coordinating all permits with the IEPA
- Submit to the Engineer, for approval, a copy of all federal, state, or local required licensing documents to perform this work

- Select a hazardous/special waste landfill/disposal facility, verifying that selected landfill/disposal facility is in compliance with applicable standards for hazardous and special waste and whether the disposal facility is presently, has previously been, or has never been, on the U.S. EPA's National Priorities List or the RCRA List of Violating Facilities
- Obtain written approval of the selected landfill/disposal facility from the Engineer, who, reserves the right to review and to accept or reject the selection
- Perform all tests required and make all necessary arrangements for waste disposal approval with the selected landfill/disposal facility
- Be responsible for transporting and disposing all material classified as a "non-special waste", "special waste" or hazardous waste" from the job site to the approved landfill/disposal facility, assuring that the transporter and vehicles comply with all federal, state, and local regulations governing the transportation of non-special, special or hazardous wastes.
- Shall prepare a technical report within 30 days of the conclusion of the project, describing the activities conducted during the life of the project and submit two (2) copies to the Engineer

If the state police or municipal agency has declared a hazardous material spill which affects system equipment and the IDOT Claims Department collects repair costs through the Motorist Caused Damage Repair fund, the Department shall make separate payment to the Contractor of the repair costs collected, following submittal of complete documentation of material purchases and labor repair costs. The Department reserves the right to use Pay Item prices, where applicable, for materials and equipment. The IDOT Claims Department has the final determination as to the amount of the repair cost recovery.

4.14 Traffic Control And Safety

4.14.1 Traffic Control Plan

The Contractor shall provide bound copies of their Traffic Control Plan for the Electrical Maintenance Contract operations, for all patrol vehicles, work crew vehicles, and supervisory vehicles.

The Contractor shall provide a copy of their Traffic Control Plan to the IDOT Expressway/Traffic Operations Engineer for review prior to or at the Pre-Construction Meeting. The Contractor shall submit the name of the subcontractor for traffic control installation and maintenance, if one shall be requested for use on this Contract, at the Pre-Construction Meeting.

4.14.2 Keeping the Expressway Open to Traffic

The Contractor shall provide the necessary traffic control devices to warn the public and to delineate the work zone as required in these Special Provisions, the Standard Specifications for Road and Bridge Construction, latest version, Supplemental Specifications, the "Illinois Manual on Uniform Traffic Control Devices for Streets and Highways", "Highway Standards", the District One Traffic Control and Protection, latest version. The Contractor's personnel shall be limited to these barricaded work zones and shall not cross the expressway.

The governing factor in the execution and staging of work is to provide the motoring public with the safest possible travel conditions on the expressway through the work zone. The Contractor shall arrange his operations to keep the closing of lanes and/or ramps to a minimum.

The Contractor shall request and gain approval from the Illinois Department of Transportation's Expressway Traffic Operations Engineer (847-705-4151) twenty-four (24) hours in advance of all daily lane, partial ramp and shoulder closures and seventy-two (72) hours in advance of all permanent and weekend closures on all Freeways and/or Expressways in District One. Shoulder closures will not be

permitted on weekdays (Monday through Friday) from 5:00 a.m. to 9:00 a.m. and from 3:00 p.m. to 7:00 p.m. Lane closures hours, if needed, will be determined by the expressway Traffic Operations Engineer, and will be made a part of the Traffic Control Plan.

The approval for emergency closures or emergency moving operations during the normal workday, shall be requested from the Expressway Traffic Operations Engineer (847-705-4151). After office hours request for approval shall be made to the ComCenter, (847-705-4612) as soon as the need is determined, prior to the Contractor's arrival on the expressway.

All daily lane closures shall be removed during adverse weather conditions such as rain, snow, and/or fog and as determined by the Engineer.

Additional lane closure hour restrictions may have to be imposed to facilitate the flow of traffic to and from major sporting events and/or other events.

Private vehicles shall not be parked in the work zone. Contractor's equipment and/or vehicles shall not be parked on the shoulders or in the median during non-working hours. The parking of equipment and/or vehicles on State right-of-way will only be permitted at the locations approved by the Engineer.

4.14.3 Payment for Traffic Control

Traffic Control and protection will not be paid separately but shall be considered as incidental to the contract and the cost for all work shall be included as part of the unit bid prices for the routine maintenance pay items. These contract unit prices for routine maintenance shall be payment in full for all labor, materials, transportation, handling and incidentals necessary to furnish, install, maintain, replace, relocate and remove all traffic control devices indicated in these specifications.

Where non-routine work requires the use of pay items which specifically allow additional payment for non-routine traffic control and protection, payment will be made in accordance with the applicable unit bid prices of the non-routine traffic control pay items included in the Contract. Otherwise, the traffic control plan costs shall be incidental to the non-routine items.

4.14.4 Traffic Control Deficiencies and Liquidated Damages

Upon notification from the Engineer or Department Expressway/Traffic Operations personnel, the Contractor shall dispatch qualified personnel immediately to make needed corrections of deficiencies that constitute an immediate safety hazard and/or the blocking of traffic lanes or ramps.

Should the Contractor fail to completely open and keep open all the traffic lanes to traffic or fails to restore the required traffic control and protection, in accordance with the limitations specified under the Special Provisions for "Keeping the Expressway Open to Traffic", the Engineer will impose daily monetary liquidated damages for each 15 minute interval (or portion thereof) that the deficiency exists. This time period will begin with the time of notification to the Contractor and end with the Resident Engineer's acceptance of the corrections. (Refer to liquidated damages in Article 4.0).

4.15 Vehicles

4.15.1 General Requirements

The Contractor shall provide at all times sufficient vehicles and construction equipment to perform the routine and non-routine work and specialized operations required and described herein. The Contractor is expected to be familiar with the extent of systems to be maintained under this contract and the equipment necessary to provide the specified work response. Failure to have adequate equipment to perform the work shall not be sufficient grounds for the delay of routine or other authorized work. The equipment shall be owned or under long-term lease to the Contractor, and available at all times for the Contractor's use.

The Contractor's vehicles, including but not limited to the minimum special equipment listed herein, shall be in good working condition and physical appearance (no rust) to be suitable for providing timely

response for systems' maintenance and to represent a quality product to the motoring public. All vehicles and equipment used by the Contractor shall conform with all applicable laws and the Department safety and traffic control requirements. The Contractor is strongly urged to have six (6) attenuators in his fleet for the safety of repair crews.

Prior to the start of the contract period, the Contractor shall have all vehicles and equipment staged and available for inspection by the Engineer. The Engineer shall provide not less than five (5) calendar days advance notice to the Contractor of the desired inspection date.

All Contractor vehicles and equipment shall be clearly identified by a decal with the Contractor's name, location, and telephone number. The decal shall be readily visible on the exterior sides and rear of each vehicle. Removable magnetic signs or similar non-permanent identification is not permitted at any time. Sub-Contractor vehicles shall be held to similar requirements.

4.15.2 Vehicles For Traffic Signal Patrolmen

These required fleet vehicles shall have no more than 60,000 certified odometer miles as of the beginning of the Contract, January 1, 2009. If this Contract is renewed for a second year, all required fleet vehicles shall have no more than 110,000 certified odometer miles as of January 1, 2010.

Truck Specifications: (minimum standards)

- 80% of fleet shall have Extended Cab
- Utility Body with Locking Storage
- Air Conditioning
- Two internal power source jacks (for cellular and PC use)
- Strobe warning lights
- Spot light
- Directional Light Bar (all new purchases to be equal to or better than Federal Signal Corp Model SAE-W-91 with Control Unit equal to or better than Federal Corp. Model SMC5 B)
- 10 ft. ladder

Vehicle Equipment (per vehicle)

- One (1) Digital camera or camera phone
- One (1) For all Patrolmen Only:
Lap-Top PC, Intel Core 2 Duo processor, minimum 2.1GHz, 15.4" WXGA TFT Display, 512MB Shared DDR SDRAM, 80GB Hard Drive, 24x CD Burner, Internal Wireless Card, Licensed copies of Windows Vista Ultimate OS and MS Word and Access software, Internal Mouse, Ethernet port, PCMCIA Modem Network card (built in), USB to serial port converter, 10 hour use with three batteries, Carrying case, and power cords to run in vehicle, Lenovo Thinkpad T61 or approved equal, and capable of operating all applications/software as required for the Traffic Signal system
- One (1) EDI Malfunction Management Unit (MMU 16E or better)
- One (1) EDI Conflict Monitor
- One (1) TS2 Bus Interface Unit
- One (1) Cell-Phone Interface for PC (Systems Trucks)
- One (1) 3-Point Ground Tester
- One (1) Amp-Volt Meter
- One (1) Loop Analyzer Model ILA-550
- One (1) Conduit-Cable Locator
- One (1) Light Source for Fiber Cable
- One (1) Audible tester for Fiber Cable (System trucks)
- One (1) Emergency Pre-emption Emitter
- One (1) Fish Tape – 100 ft.
- One (1) Measuring Wheel

One (1)	ASC-II's Controller
One (1)	EPAC Controller
One (1)	Load Switch
One (1)	Electric Drill – ½ chuck
One (1)	Shovel
Eight (8)	Stop Signs
Eight (8)	Traffic Cones
Two (2)	Lane Closure Signing

Equipment as Necessary:

Loop Amplifiers (shelf & rack)
Loop Splicing Equipment
Cabinet Keys & Locks
Relays, Fuses, Circuit Breakers
Work Lights
Signal Heads
Pedestrian Heads
Pedestrian Pushbuttons
Service Door Covers
Visors
Backplates
Bulbs
Cabinet Logos
Bolt Cutters
Graffiti Removal Solvent
Extension Cord, 100 ft.
Set of Tools
Handhole Cover
Cable, Uniduct
Cabinet Fan, Filter
Cabinet Thermostat
Cabinet Silicone
Caulk
Duct Seal

4.15.3 Vehicles for Surveillance System Patrolmen, Specialist, & Trainee

The vehicle mileage requirements shall be as specified in 4.15.2.

Truck Specifications (minimum requirements)

- Minimum 3/4 Ton with Extended Cab
- Utility Body with Locking Storage
- Air Conditioning
- Two internal power source jacks (for cellular and PC use)
- Strobe warning lights
- Spot light
- Directional Light Bar (all new purchases to be equal to or better than Federal Signal Corp Model SAE-W-91 with Control Unit equal to or better than Federal Corp. Model SMC5 B)
- 10 ft. ladder

Two (2) trucks shall be equipped with aerial tower capable of 12.2M (40 ft.) working height to reach Dynamic Message Signs.

Vehicle Equipment (per vehicle)

- One (1) AC generators capable of 40 amp output to power DMS sign
- One (1) Digital Camera
- Eight (8) Stop Signs
- Eight (8) Traffic Cones
- Two (2) Lane Closure Signing
- One (1) Loop Analyzer Model ILA-550
- One (1) Lineman's test set, Harris Dracon TS-21x89
- One (1) Digital multimeter, true RMS multimeter, with case
- One (1) Tektronix TX3 or latest version
- One (1) Wide band scope with case equal to or exceeding Halcyon 704A-200 or W & G VF-1
- One (1) Digital AC clamp on meter with case equal to or exceeding Fluke Model 30 or latest
- One (1) Breakout box with case equal to or exceeding Black Box Model SAM232-6S
- One (1) Hand held digital Oscilloscope equal to or exceeding Tektronix (THS710A) with spare battery and case or Latest version
- One (1) Wide band TMS/Signaling test set equal to or exceeding Halcyon 704A-400
- One (1) Pipe and cable locator equal to or exceeding Nilsson Pipe and Cable Locator Model #715 with Nilsson 12 volt
- One (1) Rechargeable battery Model # 110A or latest version
- One (1) Clamp on ground resistance meter equal to or exceeding AEMC Model #3700 or latest version
- One (1) Major megger
- One (1) Lap-Top PC, Intel Core 2 Duo Processor L7500, 4MB L2 Cache Processor Speed, 1.6GHz, 800MHz FSB, MIL-STD-810F compliant, moisture and dust proof design, with wide area wireless and GPS capable, 13.3" 1024 x768 (XGA) transmissive, daylight readable TFT active matrix color LCD display, 1024MB DDR SDRAM minimum, 80GB removable Hard Drive, Combo drive (DVD-ROM/CD-RW), 1 GB USB 2.0 Flash Drive, External USB Video interface adaptor with s-video in, composite in, and antenna in, backlit keyboard, GPS receiver, Internal Wireless Card, Licensed copy of Windows XP Professional, Internal Mouse, PCMCIA Modem Network card (built in), Carry Bag, and power cords to run in vehicle, and capable of operating all applications/software as required for the Surveillance System including PC to cellular interface loaded with latest Skyline DMS Maintenance software, TSC DMS portable sign control software (PSCP) by Telespot, latest remote radar sensor software by EIS and Wavetronix, Latest 3M Canoga microloop software, Virtual keyboard program LTC 5138 by Philips (Bosch) and IDOT Springfield speed and count station software, Internal Modem and Modem configuration software, Required Interfaces: infrared: 4mbps IrDa, Serial: D-sub 9 pin, Parallel: D-sub 25 pin, USB: 4 pin, 10/100/1000 Ethernet RJ45, Lithium Ion Battery, AC Adapter, Battery Charging time: minimum 5 hours off, 8.5 hours on, 2nd battery pack. Each computer shall be equipped with the following cable/adaptor combination 50' DB 9 male to female serial extension cable, 6' DB9 male to female serial cable, DB 9 null modem adaptor male to female, DB 9 mini male to male gender changer, DB 9 mini female to female gender changer, 15' DB 9 female to DB 25 male modem cable.

4.15.4 Vehicles for System Managers, TS and SCADA Specialists

The Contractor shall provide the System Managers, the Traffic Signal Specialist, and the SCADA Specialist with a ¾ Ton Extended Cab Truck or SUV type vehicle, either of which shall have no more than 75,000 certified odometer miles as of the beginning of the Contract, January 1, 2009, or no more than

125,000 certified odometer miles as of January 1, 2010. The vehicles shall be equipped with strobe lights, air conditioning, two internal power source jack for cellular and PC use, and a directional light bar which meets the specifications for TS Patrol trucks (if street work is performed) and one (1) digital camera.

Equipment for System Managers and TS Specialist Vehicle:

- One (1) Lap-Top PC, Pentium 4 Processor, minimum 2.66GHz, 15" XGA TFT Display, 512MB Shared DDR SDRAM, 30GB Hard Drive, 24x CD Burner, Internal Wireless Card, Licensed copy of Windows XP Professional, Internal Mouse, PCMCIA Modem Network card (built in), Carry Bag, and power cords to run in vehicle
- One (1) Digital Camera

Equipment for TS Specialist Vehicle:

- One (1) Portable PROM Programmer Dataman 54 or equivalent
- One (1) O.T.D.R., Siecor Model 340 or equal with necessary modules capable of testing both single-mode and multi-mode fiber cable
- One (1) CD Writer which transcribes 3 ½ disk onto blank CD
- One (1) Digital Camera

Equipment for SCADA Specialist Vehicle:

- One (1) Lap-Top PC, Pentium 4 Processor, minimum 2.66GHz, 15" XGA TFT Display, 512MB Shared DDR SDRAM, 30GB Hard Drive, 24x CD Burner, Internal Wireless Card, Licensed copy of Windows XP Professional and Microsoft Access, Internal Mouse, PCMCIA Modem Network card (built in), Carry Bag, Modem configuration software (Telix/ Reflections), MOSCAD Toolbox firmware, MOSCAD System Tools Suite (STS) firmware, Tesco Workbench Firmware, Intrac MRTU Firmware, and power cords to run in vehicle
- One (1) Digital Camera

4.15.5 Vehicles for TS and SCADA Specialist Trainees

The Contractor shall provide the TS and SCADA Specialist Trainees, a truck or SUV type vehicle, either of which shall have no more than 75,000 certified odometer miles as of the beginning of the Contract, January 1, 2009, or no more than 125,000 certified odometer miles as of January 1, 2010. The vehicles shall be equipped with strobe lights, air conditioning, two internal power source jack for cellular and PC use, and a directional light bar which meets the specifications for TS Patrol trucks (if street work is performed).

Equipment for TS Specialist Trainee Vehicle:

- One (1) Lap-Top PC, Pentium 4 Processor, minimum 2.66GHz, 15" XGA TFT

Equipment for SCADA Specialist Trainee Vehicle:

- One (1) Air Pressure Calibrator Meri-Cal EE33 with kit or equivalent

4.15.6 PS Specialist, PS Crew and Lighting System Night-Patrolman:

The Contractor shall provide the Pump Station Specialist an extended cab truck, and the Pump Station Crew personnel and Lighting Night-Survey Patrolman a regular cab or extended cab truck. All trucks shall have no more than 75,000 certified odometer miles as of the beginning of the Contract, January 1, 2009, or no more than 125,000 certified odometer miles as of January 1, 2010. The vehicles shall be equipped with strobe lights, air conditioning, two internal power source jack for cellular and PC use, and a directional light bar which meets the specifications for TS Patrol trucks (if street work is performed).

All vehicles shall be equipped with one (1) digital camera or camera phone. The Lighting Night-Survey Patrolman vehicle shall also be equipped with a spot light.

Equipment for PS Specialist Vehicle:

- One (1) Lap-Top PC, Pentium 4 Processor, minimum 2.66GHz, 15" XGA TFT Display, 512MB Shared DDR SDRAM, 30GB Hard Drive, 24x CD Burner, Internal

	Wireless Card, Licensed copy of Windows XP Professional and Microsoft Access, Internal Mouse, PCMCIA Modem Network card (built in), Carry Bag, Modem configuration software, power cords to run in vehicle, and email service
One (1)	Phase Rotation Indicator
One (1)	RPM Strobe
One (1)	Megger
One (1)	Multimeter
One (1)	Digital camera

4.16 Equipment for Maintenance Operations

The following is a list of equipment used by contractors on prior EMC contracts, which can be used as a guide for equipment as necessary on this Contract.

Arrowboard
Augur, Airhammer
Boat, (for accessing navigational light outages)
Cable Plow
Compactor, Tamper
Compactor, Air
Crane (Under 20 Ton)
Crane (20 Ton)
Drill, Boring 125 HP
Drill, Boring 50 HP
Drill, Boring 37.5 HP
Generator 6.5 HP (small)
Generator 13 HP (large)
Joint Sealer, Loop
Pavement Breaker
Pump, Water (gas) 2"
Pump, Water (gas) 3"
Pump, Water (diesel) 6"
Saw, Concrete
Tractor, Backhoe
Tractor, Skid Loader
Trailer, Cable Rack
Trailer, Flat Bed
Trencher 40 HP Wheelmounted
Trencher 57 HP
Truck, Aerial Bucket 30'
Truck, Aerial Bucket 55'
Truck, Aerial Bucket 70'
Truck, W/Augur
Truck, Cable
Truck, W/Crash Attenuator
Truck, Dump
Truck, Fiber Optic Splice
Truck, Loop w/Saw
Truck, Pick-Up
Truck, Semi
Truck, Stakebody Flatbed
Truck, PS Equipment, with 10,000 lb winch, generator 4500 watt continuous at 120 volts, combination welder, and ability to operate a hydraulic pump

4.17 Construction Test Equipment

The Contractor shall own and maintain test equipment, available for specialized maintenance testing at all times by Contractor's work crews, and given two (2) hour notice, for the Engineer's use in inspecting the Contractor's work. All equipment shall be owned or under long-term lease to the Contractor.

The Contractor is expected to maintain all test equipment, in accordance with the manufacturer's specifications at all times, including certified calibration by a responsible test lab. The equipment shall have the test lab's most recent calibration ticket attached.

The minimum quantities and types of required test equipment, as listed below, shall be ready for inspection by the Engineer by January 2, 2009.

At the Pre-Construction Meeting, the Contractor shall submit to the Engineer for approval an itemized list of all test equipment, a manufacturer's product data sheet for each item, and copies of each instrument certification calibration.

- One (1) Lineman's Test Set
Equal to Harris Dracon Model 7522A
- One (1) Time Domain Reflectometer with case
Equal to Tektronix Model 1502B (metric version)
with battery pack and chart recorder
- Two (2) Signal Field Strength Meter with case
Equal to POTOMAC INSTRUMENTS, Model FIM-21
- One (1) RUSTRAK RANGER II POWER LOGGERS
Model RR2-123 or equal, with Communications Module
for Recording, Monitoring, and Reporting. Multimeters with
Current Probe, and Thermal Probe.
- Twenty-eight(28) AMPROBE & DIGITAL MULTIMETERS
Equal to FLUKE latest model
- One (1) HOTSPOT LOCATOR
Equal to Probe Eye 6EMITST2LC Locator with battery & case
- One (1) LINEMANS TEST SET
Equal to Harris Dracon Model TS-21x89
- Three (3) BREAKOUT BOX WITH CASE
Equal to Black Box Model SAM232-6s
- Two (2) HANDHELD DIGITAL OSCILLOSCOPE
Equal to Tektronix (THS710A) with spare battery, case and charger
- Two (2) PIPE AND CABLE LOCATOR
Equal to Nilsson Pipe and Cable Locator, Model 715 with
Nilsson 12 Volt Rechargeable Battery, Model 110A or latest
- One (1) DIGITAL TACHOMETER (Latest Model)
- One (1) SURVEY RODS-LEVEL
Round Fiberglass, 25' – 5 Section, D electric Certified
- Eleven (11) 4 CHANNEL GAS DETECTOR

- Two (2) TRIAXIAL GAUSS METER, equal to Bell Technologies, Model 4080 or better
- One (1) Coaxial Cable Tester, equal to TWA Communication Model #62-204
- One (1) Infrared thermometer, equal to Fluke 60 series or equivalent
- Two (2) DIGITAL LOW RESISTANCE OHMMETERS, which meet the following requirements:
Ranges: 2, 20, 200, 2000, and 20000 Ohms
Resolution: 0.5×10^{-3} x range
Accuracy: $\pm (0.2\% + 2)$
Power Source: Line Voltage/Battery
Accessories: Ground Test Kit
Make: AEMC Digital Ground Resistance Tester or approved equal
- Two (2) DIGITAL MULTIMETERS, which meet the following requirements:
Voltage AC: Maximum Voltage: 1,000 V
Basic Accuracy: $\pm (1.0\% + 4)$
Resolution: 0.1mV X Range multiplier
Voltage DC: Maximum Voltage: 1,000 V
Resolution: 0.1 mV X Range Multiplier
Basic Accuracy: $\pm (1.5\% + 3)$
Resistance: 600 Ohms – 50 M Ohms
Power Source: Rechargeable Battery
Make: Fluke 80 Series DMM or approved equal
- Two (2) FALL-OFF-POTENTIAL GROUND RESISTANCE TESTER, which meets the following requirements:
Ranges: 2Ω to $20k\Omega$
Resolutions: 0.5×10^{-3} x range
Accuracy: $\pm (2\% + 1)$ from 10% to 100% of range
- Four (4) INSULATION RESISTANCE TEST EQUIPMENT, which meets the following requirements:
Mega Ohm Range: Resistance: 0 to 2,000 M Ohms
Voltage: 250, 500, 1000 V dc + 30 % Max.

Accuracy: +/- 1.25 % of full scale deflection on 2.8” arc length

Lo-Ω resistance Resistance: 0 to 5,000 Ohms@ 3 V +/- 0.2 V
 Voltage: 0 to 600 Volts
 Accuracy: +/- 3 % of reading

Power Source: Hand Crank/Line/Battery

Make: Megger or approved equal

Two (2) AMPROBES, which meet the following requirements:

Current AC

Range:	1 A - 600 A, AC	1 A - 1,000 A, DC
Lowest:	0.5 A	0.5 A
Accuracy:	2 % + 0.5 A	2 % + 0.5 A
Useable Frequency:	DC – 10 KHz	
Output Levels:	1 mV/A	
Power Source:	Rechargeable Battery	
Make:	Fluke 80-i1010 or approved equal	

Three (3) CLAMP-ON GROUND RESISTANCE METER, which meet the following requirements:

Range	0.1Ω to 1.00Ω	1.0Ω to 50Ω	50Ω to 100Ω	100Ω to 200Ω	200Ω to 400Ω	400Ω to 600Ω	600Ω to 1200Ω
Resolution	0.01Ω	0.1Ω	0.5Ω	1Ω	5Ω	10Ω	50Ω
Accuracy	±(2%+2)	±(1.5%+1)	±(2%+1)	±(3%+1)	±(6%+2)	±(10%+1)	±(25%+1)
Current Measurement Ranges	Auto-Ranging 1mA to 30.00 Arms						
Range	300 mA, 3A, 30A						
Resolution	1 mA, 0.001 A, 0.01 A						
Accuracy	± (2.5% + 2)						
Power Source:	Battery						
Make:	AEMC 3700 Clamp-On Ground Resistance Meter or approved latest equal model						

One (1) Ultrasonic thickness measuring instrument, referred as a D – Meter to measure the thickness of corrosion on high mast tower structure. Meter recommendation – Krautkramer DMS – 2 offered by GE Inspection Technologies.

One (1)	Echo Pulse ultrasonic instrument to measure the length and integrity of anchor rods, Meter recommendation – Krautkammer USN 58L offered by GE Inspection Technologies.
One (1)	Magnetic instrument to measure the magnitude of cracks on the surface of high mast tower, Meter recommendation – Magnaflux Y8 Battery Powered Yoke, part no. 620145.
One (1)	Dye Penetrant to check the presence and extent of the surface crack on high mast tower, recommended kit – Magnaflux General Purpose Kit SK-816.
One (1) Set	Fiber Optic Light Source and Detector for testing both SM and MM fiber optic cables, Noyes Model SMLP 5-5 or equal

Article 5.0 -- Routine Maintenance Work and Payment

5.1 Control of Work

Except as notified in writing by the Engineer, the Contractor is automatically authorized and required to perform routine maintenance work, which includes response, scheduled and preventative actions on all state maintained electrical Systems in a manner prescribed in this Contract.

Unless certain work is specifically described herein to be non-routine work, all work required by the Contract shall be incidental to the requirements of routine maintenance. Specific items of routine maintenance work are described under the description of work for each respective system. General requirements in support of routine maintenance are included in, but not limited to, this article.

The Engineer appointed for this Contract will be responsible for the control of the work in conformance with Section 105 of the Standard Specifications for Road and Bridge Construction, and contract Special Provisions.

The Contractor shall continuously watch for System elements that are malfunctioning or in need of replacement. Malfunctioning equipment shall be repaired or replaced as part of routine maintenance. The Contractor shall, however, submit a Contractor Advisory, per Article 5.13.4, for items which are a safety risk or due to age have become prone to imminent failure, and receive non-routine payment for the material portion of the repair.

The Contractor shall document to the Engineer that the various items of equipment at all locations perform properly, that maintenance operations for the respective installations and systems prescribed by this contract are not to be interrupted, that maintenance completion dates as specified or agreed are met, and that repair work as performed on system equipment meets all applicable codes and IDOT requirements.

The Contractor is responsible to perform maintenance under this Contract which prevents operational problems, minimizes trouble calls, safeguards electrical safety, promotes operational safety and which prolongs the operations life of installed systems. Some of these maintenance activities will be initiated by the Engineer, some will be jointly developed between the Contractor and the Engineer, and some are expected to be routine maintenance obligations of the Contractor.

The Engineer may make frequent investigations of Contractor work and periodic inspections of the respective systems and installations to determine if all maintenance operations are being performed satisfactorily and in the manner specified in the Contract.

Refer to systems articles herein to review required maintenance programs which may be paid either through the monthly routine work payment or may be individually authorized through the non-routine bid items.

Examples of required work necessary on a routine basis, but paid through a non-routine work authorization include, but are not limited to, lighting luminaire washing and relamping, lighting cabinet replacement or modification, pump station wet pit cleaning, traffic signal painting, and many other necessary maintenance programs.

5.2 **Priority of Work**

The following top priorities of work, in the order listed, shall take precedence over work for others and other work on this contract, unless permitted, on a case-by-case basis, by the Engineer. The response times to these situations shall be as defined elsewhere herein.

It is not necessary for the Contractor to obtain approval to utilize dedicated personnel, as specified herein, to respond to these top priorities.

- Railroad/Vehicle Conflict
- Railroad Interconnect Problem/Outage
- Traffic Control Conflict
- Traffic Obstruction
- Electrical Hazard
- Power Outage
- Water on Pavement
- Hazardous Materials on Highway
- Power Center Outage
- Other incidents as specifically alerted by the Engineer

5.3 **Contractor Emergency Response**

When equipment failures do occur due to unforeseen events, motorist caused damage, or from any cause whatsoever, time is of the essence for Contractor personnel to arrive at the scene, shut-down or safely isolate any potentially hazardous electrical condition, clear the pavement of any equipment debris resulting from the damage and take corrective measures to assure the safety of the motoring public, and coordinate the efforts to restore normal traffic operations.

The Contractor's response shall include not only reporting to the location of an incident or trouble, but also timely immediate action as prescribed for the various systems herein, or as required by the situation to mitigate immediate hazards and effect necessary temporary and/or permanent repairs and restoration of electrical systems.

It is an objective of this Contract to have the Contractor respond to trouble calls as quickly as possible after obtaining an acceptable amount of information. The Contractor shall dispatch patrol personnel for response after being provided with a main route and a cross street by the ComCenter or other police/municipal agency.

Normal response time shall be one (1) hour, with temporary service restoration in four (4) hours, and permanent equipment repairs in seven (7) days. The systems articles herein discuss specific response time requirements. (Also refer to ticket documentation requirements herein.)

All damaged equipment, determined by the Contractor not to be re-usable, shall be removed from the state highway right-of-way within twenty-four (24) hours from the time of the notification of the incident, exclusive of Saturdays, Sundays, and Holidays, and taken to the Contractor's shop area.

After inspection by the Engineer ownership shall be conveyed to the Contractor of the non-re-usable equipment via a state scrap transfer log. (Review disposal of scrap herein.) Any damaged concrete poles, broken concrete or other such refuse and debris generated from the motorist caused damage shall be disposed of by the Contractor.

All expressway, shoulder, or lane closures required for clearing, and installing temporary or permanent repairs shall be in conformance with existing Departmental standards governing lane closures. (Refer to Article 4.14 for Traffic Control Specifications).

5.4 Contractor Call-Out Policy

The Contractor is required to have a Call Out policy that formalizes the 24/7 response necessary to provide continuous maintenance for systems covered under this Contract. The Contractor shall, in addition to the EMC Dispatch Center Supervisor, appoint a System Manager or Specialist to be on-call (on a rotating basis) after the normal workday hours and on weekends, to serve as an Emergency Response Coordinator, to prioritize the emergency response for all electrical systems. In this capacity the Emergency Response Coordinator shall coordinate work with the EMC Dispatch Center Supervisor.

The Emergency Response Coordinator shall have the authority to call out additional personnel for dispatching or patrol duties. During storms or other emergency situations, the EMC Dispatch Center Supervisor and all EMC dispatchers shall be responsible to the Emergency Response Coordinator (or the Project Manager, if in attendance at the EMC Dispatch Center).

Under storm conditions, emergency situations or other special circumstances requiring the setting of priorities from among system needs requiring immediate corrective action, which go beyond the Contractor's immediate ability to respond, the assigned on-call System Manager (Emergency Coordinator) shall set response priorities in such a manner as to minimize hazard and inconvenience to the public and otherwise optimize the effectiveness of the contractor's forces, but only, after first initiating the callout of additional forces in sufficient number to address the situation. The Contractor shall communicate and coordinate with the Engineer in such situations.

The Engineer reserves the authority to re-direct the Contractor's work priorities in response to emergency situations, potential hazards, contract coordination and incomplete or deficient work and the Contractor will be allowed no additional compensation for priorities so redirected.

5.5 Special Response Situations

All special response incidents shall be documented with an EMCMS Ticket.

5.5.1 Unauthorized Access or Tampering Of Idot Property

If the Contractor sees an unauthorized individual at a site he shall radio the EMC Dispatch Center to call for police assistance, before confronting an individual.

5.5.2 Vandalism

If the Contractor arrives on the scene of major vandalism to IDOT property, the Engineer shall be notified to determine if a police report is necessary. Photos of major damage shall be taken by the Contractor and forwarded to the Engineer within 24 hours. Following incidents of tampering, vandalism, or theft, the Contractor shall notify the local police agency so they may more frequently monitor the area.

5.5.3 Intrusion at Facilities and/or Theft of Idot Property

If an entry alarm is received, the EMC Dispatch Center shall dispatch a Patrolman to the scene. If a break-in is confirmed, the Patrolman shall notify the IDOT ComCenter who shall dispatch Police to the area, and notify the IDOT Engineer(s) assigned to that facility. The Patrolman shall wait for the IDOT representative to arrive on the scene and make thorough inspection of the facility to ascertain if anything is missing or damaged, before the Patrolman files an official police theft report.

The Patrolman shall take photos of the damage and radio all information to the EMC Dispatch Center so as a Ticket may be created. The EMC Dispatch Center shall obtain a copy of the official police report and forward it and copies of the photos to the Engineer as soon as possible.

When, in judgment of the Engineer, damage or loss of system equipment is the result of extensive, specific theft activity affecting continuity of service, the Engineer may authorize non-routine maintenance payment

of all or a portion of the permanent repair work, using contract pay items wherever applicable. The potential for the permanent work authorization, however, shall in no way relieve the Contractor from the responsibility to promptly respond and perform repairs.

5.6 Locating Cable or Other Components of IDOT Systems

To prevent damage and facilitate work by others, the Contractor shall promptly respond to calls requesting a locate of state owned electrical systems at all locations. The Contractor is required to perform a locate of state owned underground cables or any other components, one time for each system location, per project or contract, as requested by the general contractor of the construction project, before or after the transfer of maintenance responsibilities. Each request may involve multiple locations where separated electrical systems are involved. Markings shall be given with a horizontal tolerance of one foot to either side. (Review cable locate documentation requirements herein.)

5.7 Providing System Services

Upon request of the Engineer, the Contractor is required to provide trained personnel for the following miscellaneous routine maintenance work:

- Provide system access to utility workers or inspectors approved by the Department
- Provide system access for other contractors and consultants who have approved contracts to work on IDOT equipment
- Conduct an immediate System or component inspection upon notice of the Engineer
- Provide labor, transportation, and equipment, to assist IDOT inspectors in their inspection of any portion of a System(s)
- Provide additional special patrols, inspections, and tests to confirm proper system equipment operation
- Collect information to analyze the nature of repetitious or intermittent system malfunctions
- Travel to a designated location/installation to determine ownership, take photos of the requested area, and email photos and information back to the department (response required within four (4) hours of request, unless directed otherwise).
- Travel to the site of a hazmat spill to oversee proper pump station operations (response required within one hour of request)
- Provide occasional Patrolman for monitoring (stand-by time) of hazardous or emergency situations

5.8 General Maintenance Work

All maintenance activities, equipment repairs and/or replacements and all associated work as found necessary for the proper maintenance of the systems as described herein shall be considered as part of routine maintenance, except as otherwise noted.

All equipment shall be maintained in accordance with manufacturer specifications and recommendations. Routine maintenance equipment service schedules and work shall be executed in accordance with equipment operations and maintenance (O & M) manuals unless otherwise stated herein.

Permanent repairs shall be started promptly following emergency temporary repairs, and shall be continued insofar as possible without interruption, until completion. If a permanent repair delay is due to "parts on order", the Contractor shall furnish the corresponding material requisition and purchase order for those parts or components of the system required to complete the repair.

The Department retains ownership of all damaged equipment until a state scrap transfer log is signed by the IDOT Inspector. (Refer to state scrap provisions as stated herein.)

All graffiti, including advertising decals, found on system equipment shall be removed within one (1) working day.

Following repair work, the associated area restoration shall be equal to or better than the original area condition. For example, if the soil/sod has been disturbed during the course of his work, the Contractor shall regrade the surface work area with black dirt, placing seed or sod.

The Contractor shall perform maintenance on equipment not maintained by him at contract unit prices, or if approved by the Engineer, at an agreed price.

5.9 Repair of Damaged or Malfunctioning System Equipment

5.9.1 General Requirements

The Contractor is required, under routine maintenance, to clear site for safety, provide immediate corrective action, provide immediate temporary repairs, provide timely permanent repairs, and replace where necessary new parts or equipment for all state maintained system equipment found damaged or malfunctioning for any reason, regardless of the type of damage or who caused the damage, unless otherwise directed by the Engineer. Examples of damage include vehicular caused damage, third party damage, vandalism, natural causes, or incidental damage on or affecting system equipment as caused by the failure or the fault of utility company equipment. Permanent repairs are paid through routine maintenance, unless specified elsewhere herein, and shall normally be completed within seven (7) calendar days, or sooner, if specified in system articles herein. All work on system equipment must be documented. Review requirements for Ticket documentation.

Damaged equipment parts and materials shall be replaced with new equipment, previously approved by the Engineer, in equal quantities, which shall be identical to the original elements except as otherwise specified herein, or permitted by the Engineer. Materials, repair methods and/or equipment replacements shall be suitable for the intended use per specifications and Standards as listed in Article 2.0 and contract requirements herein.

All expressway, shoulder, or lane closures required for the response and repair of damaged System equipment is routine maintenance work and shall be in conformance with existing Departmental standards governing lane closures. (Review Article 4.0 for Traffic Control information.)

5.9.2 Damage Caused by Department Personnel

The Contractor shall abide by requirements of Article 5.9.1 herein, however, when damage to system equipment has been caused by Department personnel, in the performance of their assigned duties, the Contractor shall receive payment for temporary and permanent repair work necessary. The Contractor shall be paid through non-routine maintenance, where unit price items are applicable.

Upon finding damage to state property caused by department personnel, the Contractor shall take a date stamped, digital photo of the damage and email to the Engineer or designated IDOT inspector.

Within twenty-four hours of the found damage, the Contractor shall contact the Engineer to establish a mutually agreed date for a field inspection to ascertain the materials and/or parts necessary for the repair. Repairs shall be completed within seven (7) days, or as specified in system articles herein.

The Department reserves the right to furnish any or all of the materials or parts for any non-routine work, so no charge for items so furnished shall be made by the Contractor. Materials or parts furnished by the Department may be from the Department's state stock inventory or from other sources available to the Department.

5.9.3 Damage Caused By Construction (3RD Party Damage)

The Contractor shall abide by requirements of Article 5.9.1 herein, however, when damage to system equipment (Contractor maintained) has been caused by construction activity, the Contractor may invoice the offending third party for damage repairs, including clearing costs, if Engineer approval is given. Examples of third parties include contractors working under contract with IDOT, contractors working on a construction project under permit issued by the District's Traffic Permits Section or the District's Design

Utility Section, or municipal and county agency workers and their contractors. Repairs shall be completed as specified in system articles herein.

3rd Party Damage Repair Documentation:

- a. Upon finding 3rd party damage to state property (not caused by departmental personnel), the first Contractor patrolman responding to the scene shall take a date stamped, digital photo of the damage and email to the Engineer or designated IDOT inspector.
- b. The Contractor shall create an EMCMS GB (general billing) ticket, noting the name of the contractor at the scene, address, contract or permit number and contact name and phone numbers.
- c. The applicable party shall be sent a written estimate of repair (or construction) costs.
- d. The Contractor shall notify the IDOT Engineer/Inspector when the work is complete and ready for inspection by submitting, in the monthly routine maintenance work documentation book, a file on each 3rd party damage (or work) incident where permanent repairs have been completed. The file shall include copies of the completed ticket, daily general billing log(s), all correspondence, and Contractor original invoice. (Note: The 3rd party invoice number shall be the same as the ticket number.)
- e. After the work has been inspected, and the Engineer has signed an approval on the original invoice, the Contractor may submit it to the third party. If the work is inspected but not approved, the unsigned invoice shall be returned with a corrective work list. Contractor shall not submit an invoice to a third party for damage to IDOT property without an IDOT approval signature.

5.9.4 Work Request Made by 3rd Party

The Contractor shall create an EMCMS WR (work request) ticket for third parties requesting legally permitted work within the IDOT right of way which is not related to the repair of system equipment damage, but for which the Contractor will receive direct payment from a third party. An example of a work request would be the relocation of a lightpole for a developer. The Contractor shall obtain Engineer approval prior to the start of work. The Contractor shall follow same procedures as points c., d., and e. in Article 5.9.3.

5.9.5 Damage Caused by Motorists

The Contractor shall abide by routine maintenance damage repair requirements of Article 5.9.1 herein for temporary and permanent repairs.

When the Contractor responds to a notification of state property damaged by motorists, or damage is found upon patrol, the Contractor shall create an EMCMS MC (motorist caused damage) ticket and the first Patrolman on scene shall take date stamped, digital photos of the damage. Refer also to Ticket documentation requirements herein. At the end of each week, the Contractor shall email the Engineer the photos of motorist caused damage, specifying the Ticket number and Patrolman call number.

The Contractor shall enter the work crew repair information (equipment damaged and/or salvaged, equipment re-used, new equipment installed, identifying state stock or contractor parts used, and total of labor repair time and vehicles used) in the EMCMS Ticket and MCHD Log as soon as possible following the damage repairs.

Highway Lighting System

When any part of a light pole unit (pole, arm, luminaire, etc.) is damaged by a motorist, the Contractor is allowed to use state stock materials, if available, for the repair. At the end of each month the Department shall be credited for the materials used, in the routine maintenance monthly payment. The Contractor is responsible for an accurate state stock accounting. Refer also to State Stock documentation requirements and Routine Maintenance Payment herein.

MCHD Claims Processing

The Contractor shall submit printed EMCMS MCHD statements, prepared from EMCMS MCHD Ticket Log entries, for the IDOT Claims Department. The EMCMS MCHD statement format shall be provided to the Contractor at the Pre-Construction Meeting. Each statement shall consist of one (1) original and six (6) copies, in a 7-part multi-copy form. Each statement number shall be the same as the ticket number. All statements shall be signed by the Contractor to verify repair work completion. The Contractor shall submit the statements, with Engineer approved envelopes and address tape within seven (7) days of the request of the Engineer.

MCHD Accounting Procedure

The Contractor is paid for repair work for motorist caused damage through routine maintenance bid items. However, as an accounting procedure, the total dollar amount of the monthly processed MCHD statements is deducted from the monthly routine maintenance payment to the Contractor, and approximately sixty (60) days later, the Contractor shall receive that dollar amount directly from State of Illinois Motorist Caused Highway Damage Fund.

Special Payment for Damage Repairs

Motorist caused damage repair work is paid through routine maintenance and the Contractor is not allowed to collect repair costs from licensed motorists or insurance companies. In special situations, however, the Contractor may receive from the Department, an additional partial payment for permanent repairs, as follows:

- a. Where there is damage to light towers the Contractor shall be paid for repairs through non-routine maintenance, where unit price items are applicable. (Refer to Article 7.0)
- b. Where there is damage to the fiber optic network the Contractor shall be paid for repairs through non-routine maintenance, where unit price items are applicable, or if approved by the Engineer, through agreed price.
- c. Where there is wide-spread and/or costly damage to state property (in excess of \$25,000) caused by a licensed motorist, the Contractor provides complete documentation of material purchases and labor repair costs, and the IDOT Claims Department obtains repair cost reimbursement, the Department shall make separate payment to the contractor of the repair costs collected, after deducting any payment received by the Contractor in situations where non-routine pay items or agreed prices were applicable. (Refer to (a) and (b) above). Note the repair costs collected by the Department may not equal the total dollar amount of the Contractor's repair invoice. The IDOT Claims Department shall have the final determination of the amount of repair costs collected.

5.10 Patrol Inspections

5.10.1 Patrol of Systems

Routine work requirements of this Contract require patrol inspections of systems. Refer to system articles herein for specific system requirements and patrolmen duties. The Contractor shall strictly adhere to the approved routes and schedules. The patrolling of a new location accepted for maintenance shall be instituted immediately.

The Patrolmen responding to emergency calls shall be stationed so that their travel time to arrive at any designated point of trouble shall not exceed one hour during normal weather, 24/7. Response times for specific situations are located in system articles herein.

The Contractor shall submit proposed system patrol routes, for Engineer approval, at the Pre-Construction Meeting.

5.10.2 Night Outage Patrol Survey

The Contractor shall patrol all highway lighting, sign illumination, and navigational lighting system locations, traffic signal locations with combination traffic signals and overhead lighting, and various Extra

System locations, to assure safe, operational conditions of equipment and materials, and to assure that all installations are performing at the level of service for which they are designed. The patrol survey shall include installations for which maintenance responsibility has been temporarily transferred to a construction contractor or other third party.

Patrols shall be arranged to inspect an approximate equal number of locations, during the first three full weeks of the month, (four or five nights per week). The proposed patrol outage survey shall be presented to the Engineer, for his approval, at the Pre-Construction meeting. The Contractor shall not deviate from the schedule, unless approved in advance by the Engineer.

The patrolman shall be provided a hand free voice activated tape recorder to record each outage found, by noting the unit number (or cabinet designation and the pole or sign's proximity to a cross-street or road). Each night the patrolman shall record his name, call number, route week, day and date and odometer reading at the beginning and end of the patrol outage survey. The patrolman shall also radio the EMC Dispatch Center to create a ticket when multiple outages or tower outages, other malfunctions or damage are noted.

The Contractor shall email the Engineer an Excel spreadsheet report of the previous night's outage survey by 10 a.m., every workday morning, following a night time patrol. The listing shall include location numbers and names, unit numbers of outages, and ticket numbers of any special problems found. The report shall be divided in separate categories, by county, for:

- 1) Highway lighting outages
- 2) Sign lighting outages
- 3) Navigation lighting outages
- 4) X system outages of various equipment, including beacon lights on radio towers, weigh stations, weigh stations open/close signs, and rest areas
- 5) Off-maintenance location outages

Under normal weather situations, the Contractor has one week, seven (7) calendar days to repair outages found on the nightly outage survey. The Contractor shall repair all outages found, both those found on the patrol and those found when the cabinet is energized. In some cases this may substantially increase the number of outage repairs on a particular date. For those outages that require special lane closures, special parts, etc., the Contractor shall create a ticket and obtain Engineer's approval of the repair delay.

The number of patrol survey outages found and repaired as well as repair crew outages found and repaired, as well as ticket numbers for locations where repair work was not completed, all sorted by category and county, shall be reported on a monthly outage repair summary spreadsheet to be submitted to the Engineer by the 5th working day of the following month, signed and dated by the appropriate system manager, stating the repair of each outage was completed in accordance with contract specifications. A sample night patrol summary report will be presented to the Contractor at the Pre-Construction meeting.

5.10.3 Red-Light Running Camera Survey and GPS Survey

While performing patrol duties, for the duration of the Contract, the Contractor Patrolman shall make note of any red-light running camera locations and agency responsible for their installation (if known) and report the installations or removals once per month on a cumulative yearly spreadsheet, to be submitted in the monthly routine maintenance work documentation book.

The Contractor shall conduct a survey and record the GPS position of all traffic signal cabinets, surveillance cabinets and cabinets which provide power for all X System locations during the normal patrols of those locations. The survey format shall be furnished by the Engineer. The information shall be submitted to the Engineer by the end of the contract year.

5.11 Coordination with Electric Utility Companies, Contractors, and Others

The Contractor shall keep incoming power service in proper condition at all times. The Engineer shall be promptly notified by email for cases such as the planned disruption of service power to System equipment.

The Contractor shall monitor the condition of electric service wiring and equipment, telephone service wiring and equipment, natural gas service lines and accessories and water service piping and appurtenances for all systems and facilities maintained under this contract. The Contractor shall maintain contacts with the respective utilities or providers for these services and shall coordinate with the utility and the Department to assure that services are installed in a timely manner, in compliance with requirements established for the service.

The Contractor shall fully coordinate access as required for utility company or contractor inspection, modification work as applicable, repair work as necessary and other matters as necessary to assure continuity of services and proper revisions when needed.

The Engineer may require the Contractor to inspect related non-system equipment, such as Com Ed power lines, that may interfere with the functioning and/or maintenance of systems as covered in the contract.

The Contractor shall assist the Engineer with the inspection of work completed by others such as the construction and/or replacement of intermittent median walls by a construction contractor (the non-EMC) and the necessary inspection of the required electrical ducts by the Contractor.

5.12 Formal Transfer of Maintenance

The Contractor shall cooperate with the Engineer and construction contractors with respect to transfers of maintenance on system elements and inspection of completed construction work for Department acceptance. The Contractor shall assist the Engineer and/or IDOT Inspectors to make equipment inspections of installations to be added or removed from routine maintenance to ascertain that the equipment and/or workmanship is in proper working order and verify equipment inventory quantities. The Engineer may request the Contractor provide new locks for system equipment at the maintenance transfer meeting.

There will be transfer inspection site meetings in the field. The Contractor shall attend these official joint transfer site meetings and shall fill out and sign any required maintenance transfer forms or equipment inventory forms. The Contractor shall provide the Engineer, a minimum of 24-hours in advance of the maintenance transfer meeting, the names of the Contract personnel who shall be attending the meeting.

Transfer of Location Maintenance Responsibility to EMC

In examining construction work for acceptance by the Department, the Contractor shall advise the Engineer with respect to the completeness, workmanship, safety and maintainability of the installation, and the Engineer will make the final determination regarding acceptance. The Contractor is required to assume maintenance responsibility for system work accepted by the Engineer.

Transfer of Location Maintenance Responsibility from EMC

Following the site meeting, if a corrective work list has been developed, the Contractor shall be required to correct any outstanding deficiencies through routine maintenance or unless otherwise permitted by the Engineer.

Transfer EMCMS Entry

Upon acceptance of routine maintenance responsibilities or transfer of maintenance responsibilities to another entity, the Contractor representative shall radio the EMC Dispatch Center the information to immediately complete and enter into the EMCMS Location Update the following information:

- Date and time of maintenance transfer
- EMC Maintenance status (ON or OFF)

- Type of maintenance or other notable information
- Name and address of Contractor
- Contact and 24/7 telephone number for the responsible Contractor
- Police agency responsible for the location

After EMCMS entry, the EMC Dispatch Center shall send the completed Maintenance Transfer Log to the Engineer, applicable system Engineers, via email or fax. Note the Department retains the right to change state ownership and pay item categories, in the EMCMS, for all maintenance transfers.

The Contractor shall be responsible for the correct contents of the EMCMS Locate Location screens, and the Engineer shall be notified if errors are found.

5.13 Routine Maintenance Submittals and Documentation

5.13.1 Daily Work Agenda

The scheduling of daily work shall be a responsibility of the Contractor, but governed by established schedules and/or authorized work completion dates. The Contractor is required to email the Engineer, each IDOT System Engineer/Inspector, and the IDOT ComCenter, a daily agenda which shall account for all scheduled repair work, project work, or preventive maintenance program work to be performed on system equipment. The daily agenda shall be received by 8:30 a.m. on the specified workday or by 2:30 p.m. on Fridays when weekend work is scheduled by the Contractor.

The Department will provide the Contractor the format for the daily agenda. The daily agenda shall account for all personnel, noting dedicated or assigned personnel status, listing their name, cell phone number, radio number, description of work assignments, both routine and non-routine for all systems, the location number, and ticket number or authorization number if applicable.

If the Contractor's work/testing, as specified herein, requires the presence of an IDOT Engineer/Inspector, the Contractor shall give a minimum 24 hour notice to the appropriate Engineer/Inspector when that work is to be scheduled on the daily agenda. If the Contractor proceeds with the work without this pre-notification, the Contractor shall, by the decision of the Engineer, be required to either re-perform the work/test or shall be assessed liquidated damages.

When a special project and/or system modification warrants, the Engineer may direct the Contractor to create a separate special project agenda. The same issuance requirements apply for the special project agenda as for the daily agenda.

5.13.2 Release of Dedicated Personnel

Daily Release (during the week day)

Any request for the daily release of dedicated personnel to address emergency situations outside this contract shall be made directed to the IDOT System Engineers, via telephone or email. Release without substitution will be based on the status of completion of applicable work for that day.

Dedicated Personnel Notice of Absence

When the Contractor is made aware of a planned or sudden absence of dedicated personnel an email notice of the dates of absence and the name of the assigned substitute shall be sent to the Engineer and System Engineers. Substitute personnel shall be qualified and trained for the work involved. Only under special circumstances shall the Engineer/System Engineers grant release of dedicated staff for regular leave purposes without substitution.

The Contractor shall account for the work schedule of all substitutes for dedicated personnel on the emailed Daily Agenda. The name of any substitute personnel shall be highlighted.

5.13.3 Dispatch and Call Out Schedule

On Thursday of each week, the Contractor shall provide the Engineer and each IDOT System Engineer/Inspector an email or fax of the next week's EMC Dispatch Center personnel work schedule, Patrolmen night work schedule, Patrolmen weekend on-call schedule for each system, and the scheduled Emergency Response Coordinator for the week. Names, telephone numbers, call numbers, hours to be worked, or hours on-call shall be noted on this schedule.

5.13.4 Contractor Advisory

If the Contractor identifies system elements, which, due to age or normal wear and tear have become prone to recurring or imminent failure, or which otherwise pose a significant liability or a safety risk, the Contractor shall recommend replacement or repair by submitting an advisory inspection report in the monthly routine work documentation book.

The Engineer shall review and respond to the Contractor in regards to the advisory inspection, and reserves the right to determine a course of action to rectify any identified condition. When the Engineer concurs with the Contractor's basic recommendations, a non-routine authorization will be issued for the material portion of the repair and this will reduce the Contractor's routine maintenance obligation to the labor necessary to replace the deteriorated system element. Should the Engineer determine, however, that a deteriorated condition is due to neglectful maintenance on the part of this Contractor, all remedial work shall be performed as routine maintenance.

Repair of damage from weather-related failures of electric utility systems, broken aerial electrical lines, or damage from deteriorated electric utility systems which have been observed and reported by the Contractor to the utility and the Engineer prior to the occurrence of damage, may also be eligible for payment subject to approval of the Engineer. Engineer approval of the work will be based on adequate contractor repair response, proper advisory inspection report documentation, and the substantiated link to weather-related failure or previously reported deteriorated utility systems as noted above.

In the absence of an advisory inspection report received and acknowledged by the Engineer, if system elements fail or are observed by the Engineer to be causing recurring failures or imminent safety hazards, then the Contractor is obligated for the full cost of replacement or repair under routine maintenance. Such obligation is not limited only to individual components but may extend to the multiples of components at a location(s).

5.13.5 EMC Tickets

The use of Tickets for the documentation of Contractor response and work on system equipment is integral to the EMC. In the past four years, approximately 10,000 tickets per year have been created on the EMCMS by the Electrical Maintenance Contractor.

The EMCMS shall be the source and control of ticket number assignments for selected work activities of all systems. A single series of numbers will be sequentially assigned from the EMCMS database and will be used for all work activities related to the original work assignment. A separate numbering system for tickets will not be allowed.

The Contractor shall immediately create a ticket on the EMCMS when:

- Contractor personnel is dispatched to a state maintained location
- Contractor personnel finds malfunctions or damage to system equipment
- IDOT personnel or any 3rd party reports malfunctions or damage to a state maintained or non-state maintained location
- Any work in progress on equipment installation(s) is found not properly grounded and may endanger the public at large or other Department property

The Contractor shall, within 1 hour of receipt of information, record in the EMCMS ticket, the following information:

- name of informant and call-back number
- time dispatched
- time of arrival at scene
- problem found (including unit number of effected equipment)
- time incident is cleared
- description of work completed at scene
- follow-up work necessary
- clearing information as given to IDOT ComCenter
- police accident number as received from the IDOT ComCenter or other agency for Motorist Caused Damage to system equipment

Communication with the IDOT ComCenter

The EMC Dispatch personnel shall be provided with EMCMS call-out location numbers when the ComCenter workload allows, but it is the responsibility of the EMC Dispatch personnel to have a thorough knowledge of the location look-up feature of the EMCMS. The Contractor shall dispatch patrol personnel for response after being provided with a main route and a cross street by the ComCenter or other police/municipal agency.

During certain emergency situations it may be necessary that the EMC Dispatch personnel provide periodical updates, including estimated time of arrival and status of repairs, when requested by the ComCenter. In addition, the Contractor is required to telephone the IDOT ComCenter once a damage incident has been cleared for safety for the motoring public, or in the case of major highway lighting outages, when the service has been temporarily restored.

After office hours request for approval of emergency lane closures shall be made to the ComCenter, (847-705-4612) as soon as the need is determined, prior to the Contractor's arrival on the expressway.

Incidents at Non-State Maintained Locations

When a third party, IDOT personnel, or the Contractor's work force notify the EMC Dispatch Center of a problem with an IDOT system location which has been temporarily taken off of routine maintenance due to construction or modification, the Contractor shall create a ticket, but shall notify the proper maintainer.

When a third party, or IDOT personnel, notify the EMC Dispatch Center of a problem with a location which is maintained by a municipality or is owned by a private party, the Contractor shall notify the proper maintainer.

Transmitting Ticket Summary Information

The Contractor shall transmit the EMCMS ticket summary to the Bureau of Traffic Operations and Maintenance Sections and Traffic Systems Center Operations Section by 8:30 A.M., Monday through Friday workdays. This report shall account for all tickets created from 7 a.m. the prior day to 7 a.m. the current day. The Monday daily ticket summary shall account for the time period from Friday 7 a.m. through Monday at 7 a.m.

5.13.6 Plan Records Management

The IDOT plan records system provides for retrieval of system documentation, and provides a digitized central storage of the data records. The Engineer shall specify the pdf format to be used at the Pre-Construction meeting. When the Contractor modifies system equipment, through routine or non-routine work, the revised plans, with system location numbers and catalog cuts, shall be scanned and delivered to the Engineer monthly, in the routine maintenance work documentation book. The monthly CD submittal shall be accompanied by a cumulative yearly spreadsheet noting system location number, description of modification work, and date work was completed.

Plan Records Management Project

The Engineer shall provide the Contractor access to obtain drawings and catalog cuts for the Plan Records System. Twice per contract year, in June and December, the Contractor shall scan onto CD's, 300 plan sheets into an 11 inch by 17 inch format, with system location numbers provided, and 300 catalog cut sheets into an 8 ½ inch by 11 inch format, and submit to the Engineer in the monthly routine maintenance work documentation book. The CD submittals shall be accompanied by a cumulative yearly spreadsheet noting system location number and name, catalog model item name and number, and scan date.

5.13.7 Monthly Routine Work Documentation Submittal

On the first day of each month the Contractor shall submit to the Engineer a three ring binder, which contains the required documentation of the various items of work as required herein, for the prior month. These submittals include, but are not limited to:

Maintenance Transfer Summary Report

A spreadsheet noting the system, county, date of each maintenance transfer, location number, location name, and new maintainer name and/or owner

Patrol Schedule Change Summary Report

A copy of an EMCMS patrol schedule summary, updated with all maintenance location transfers

Equipment Inventory Summary Report

A spreadsheet noting the system, county, location number, location name, equipment change quantities, and date of maintenance transfer or authorization of new equipment install

EMCMS Time Summary Report

Refer to Article 4.6.6

Personnel Training Summary

Training Schedule, changes noted, list of attendees
Refer to Article 4.12.1

Third Party Invoices

Original Invoice ready to be signed by the Engineer
Refer to Article 5.9.3

MCHD for Lighting System

Ticket Report with State Stock Usage and cash value
Refer to Article 5.9.5

Red-Light Running Camera Survey

Cumulative location list, with EMCMS number and names,
Agency responsible, date of installation
Refer to 5.10.3

Contractor Advisory Reports

Refer to Article 5.13.4

Plan Records Management

Contractor submittals of CD and cumulative spreadsheet with plan data
Refer to Article 5.13.7

State Stock Scrap Logs

A copy of all State Scrap logs; all items approved for scrap in the prior month Refer to Article 5.14.5

Vendor Payment Summary

EMCMS summary of non-routine payment to vendors, noting the date Contractor paid each vendor.
Refer Article 6.2.7

Grounding and Service Upgrade Progress Report

Contractor submittal for Traffic Signals, Lighting and Surveillance System

System Preventative Maintenance Work Documentation

Contractor submittals of required documentation as specified in system articles herein

5.14 State Stock

5.14.1 General Requirements

The Contractor is responsible, under routine maintenance, for the storage and inventory reporting of the Department's stock of parts, materials, and equipment which is to be used exclusively for the Department's installations and systems. The Contractor shall appoint a state stock manager, who shall be responsible for the Contractor submittal of state stocks reports and shall be the Department contact for state stock transactions. This individual shall be named at the Pre-Construction Meeting. Refer also to Article 4.0 Storage Facilities.

The Contractor shall use state stock only when directed and approved by the Engineer. The Department is not obligated to furnish specific parts or equipment in state stock inventory for Contractor use. The Contractor may not use any state stock inventory for any work outside the scope of this contract.

5.14.2 Disbursement of State Stock

Upon receiving an approved state stock disbursement/receiving log from the Engineer, the Contractor is responsible for timely, safe transportation and handling to deliver designated state stock inventory from the state stock warehouse, Contractor shops or sites, or other approved state work sites within District 1, to approved Contractor or state work sites within District 1. The Contractor also shall provide all labor and equipment as necessary to relocate any IDOT equipment (stock) to new facilities as directed by the Engineer.

The Contractor shall fax the Engineer a state stock disbursement/receiving log requesting the use of state stock. The state stock disbursement/receiving log must state whether the equipment to be removed is for a routine or non-routine work project. The Contractor may not use any state stock until written approval is received from the Engineer.

5.14.3 Receipt of State Stock

Upon receiving an approved state stock disbursement/receiving log from the Engineer, the Contractor is responsible for timely, safe transportation and handling to pick up materials, parts, and equipment which is to be designated as state stock inventory from Contract routine work sites and locations within District 1 and deliver to the state stock warehouse, Contractor shops or sites, or state work sites within District 1.

The Contractor shall fax the Engineer a state stock disbursement/receiving log requesting delivery of items into state stock. The state stock disbursement/receiving log must state who will be delivering the items and state the project from which the items will be arriving. If the Contractor is replacing state stock items previously used for routine maintenance work, the log must clearly note the original disbursement date of the item. The Contractor may not place any items into state stock until written approval is received from the Engineer.

In order to assure that only materials in good working order and/or condition shall be placed in the state stock warehouse, the Contractor shall provide trained personnel (helper/groundsman) to inspect the materials, separate salvage materials, and/or box/wrap/categorize the various in-coming materials at the

state stock warehouse. This work shall be paid through non-routine maintenance. (Refer to payment of non-routine authorized work in Article 6.0).

With Engineer approval the Contractor is allowed to take receipt of materials at the Contractors facilities, but the materials must be moved, at Contractor expense, to the state stock warehouse within five working days of the receipt of materials.

5.14.4 Disposal of Scrap

The Engineer shall have the sole determination as to whether material (equipment) is re-usable as system equipment. Except as otherwise indicated herein, all removed items remain property of the state. The Contractor may not dispose (scrap) any materials without receiving prior approval from the Engineer in writing.

The Contractor shall fax the Engineer a state scrap transfer log requesting Engineer approval of items to be scrapped. The state scrap transfer log must state the item name/model/type, condition, and location where item was located. If after inspection the materials are determined to be scrap, the Engineer shall sign the state scrap transfer log, and convey ownership of the scrap materials to the Contractor. Upon receiving the transfer of ownership, the Contractor shall be responsible, at his expense, for the proper, legal disposal of all scrap items; materials, parts, equipment, etc. The estimated salvage value of scrap materials shall be reflected in the bid unit prices for routine maintenance items.

All lamps removed as part of re-lamping operation, outage repairs or other authorized work shall become property of the Contractor and shall be disposed of in full compliance with Environmental Protection Agency (EPA) regulations. The EPA Rule 40 CFR, part 273, finalized in May 1995 established a guideline for the recycling of lamps and the mercury from scrapped lamps. Fluorescent, high-intensity, low pressure sodium, and other lamps bearing mercury may be classified as a potential hazardous waste.

The Contractor shall recycle removed lamps to the maximum extent possible and shall submit to the Engineer, for approval, the name and background of a qualified lamp recycling specialty service which shall be used for lamp recycling under this Contract. Over the course of the Contract, the Contractor shall provide documentation of all lamp recycling activity to the satisfaction of the Engineer. The Contractor shall provide the names of qualified facilities certified to dispose of used lamps at the pre-construction meeting.

5.14.5 State Stock Documentation

The Contractor shall conduct an audit of the state stock inventory as of January 2, 2009, and create an initial EMCMS state stock inventory report, accounting for all parts, materials and equipment. After approval signature of the principal of the company and the Engineer, the Contractor shall have full responsibility for all state stock inventory for the duration of the contract, including the EMCMS reporting of use, disbursements or receipts.

The Contractor shall keep current the EMCMS database of all state stock inventory information, including stock totals, material reservations, receipts, and disbursements for each electrical system, and shall include information as to size, type, manufacturer, location (including all materials at the warehouse facility, shop facilities, etc.) and state of repair of all parts and equipment, as well as a record of where the prior months' stock was utilized, by staging area, category or routine or non-routine work, and ticket number or contract number if applicable.

A monthly EMCMS state stock inventory report from the entered EMCMS data shall be sent to the Engineer by the 5th day of the month, prior to the pay meeting. The state stock inventory report shall be signed by the person directly accountable for the accuracy of same and an officer of the firm with a statement attesting to the accuracy of the report and proper use of the inventory. The Contractor is required to retain all inventory records for a period of 5-years following the completion of the Contract.

In addition, the Contractor shall reconcile the monthly inventory as issued by the leased warehouse to the EMCMS state stock report and shall notify the Engineer of any discrepancies. Both reports and all logs shall be submitted monthly to the Engineer.

5.14.6 State Stock Documentation

The Contractor shall conduct an audit of the state stock inventory as of January 2, 2009, and create an initial EMCMS state stock inventory report, accounting for all parts, materials and equipment. After approval signature of the principal of the company and the Engineer, the Contractor shall have full responsibility for all state stock inventory for the duration of the contract, including the EMCMS reporting of use, disbursements or receipts.

The Contractor shall keep current the EMCMS database of all state stock inventory information, including stock totals, material reservations, receipts, and disbursements for each electrical system, and shall include information as to size, type, manufacturer, location (including all materials at the warehouse facility, shop facilities, etc.) and state of repair of all parts and equipment, as well as a record of where the prior months' stock was utilized, by staging area category of routine or non-routine maintenance, and Contract number if applicable.

A monthly EMCMS state stock inventory report from the entered EMCMS data shall be sent to the Engineer by the 5th day of the month, prior to the pay meeting. The state stock inventory report shall be signed by the person directly accountable for the accuracy of same and an officer of the firm with a statement attesting to the accuracy of the report and proper use of the inventory. The Contractor is required to retain all inventory records for a period of 5-years following the completion of the Contract.

In addition, the Contractor shall reconcile the monthly inventory as issued by the leased warehouse to the EMCMS state stock report and shall notify the Engineer of any discrepancies. Both reports and all logs shall be submitted monthly to the Engineer.

5.15 Contractor Spare Parts Inventory Responsibilities

The Contractor shall be responsible, under routine maintenance for providing spare equipment for emergency and routine service and for overhauling equipment, to meet the response and maintenance requirements as stated herein. The Contractor and the Engineer shall meet by December 1, 2008 to agree on the minimum quantity of equipment which the Contractor shall have in his possession at the start of this Contract. The Contractor shall submit his current inventory of spare parts for each system to the Engineer as of January 1, 2009.

Per the Engineer's directive and/or following an inventory-related failure to meet the routine maintenance performance requirements of the contract, the Engineer may direct the Contractor to maintain a minimum quantity of specific items on hand. The additional cost of maintaining the required parts inventory shall be borne solely by the Contractor.

A shortage of any parts or equipment causing delays in the implementation of replacements or repairs shall be sufficient cause to assess liquidated damages. The Contractor shall submit anticipated schedule(s) for ordered replacement items when required for this Contract. The Engineer may inspect the Contractor spare parts inventory at any time as deemed necessary. (Review Article 4.0 for Contractor storage facility requirements.)

5.15.1 Suggested Starting Quantities Of Contractor Owned Parts For The Lighting System

LUMINAIRES

Qty	Item
25	HPS, 230 Volt, 200 W
10	HPS, 230 Volt, 310 W
20	HPS, 230 Volt, 400 W
15	HPS, MT, 200 W

10	HPS, MT, 310 W
10	HPS, MT, 400 W
15	HPS, 480 Volt, 200 W
10	HPS, 480 Volt, 310 W
10	HPS, 480 Volt, 400 W
10	LPS, 230 Volt, 55 W
2	HPS, 208 Volt, 400 W
3	HPS, 240 Volt, 1000 W

Cabinets

Qty	Item
2	240 Volt, 150 Amp, Asco contactor
2	240 Volt, 200 Amp, Asco contactor
2	277 Volt, 200 Amp, Asco contactor
2	110/120 Volt, 60 Amp, Asco contactor
2	240 Volt, Tork Astronomical Clock

Wire

Qty	Item
3000 Ft.	#4 Quadruplex

Poles and Arms

Qty	Item
20	11.5" BC, 32 Ft., Alum Lt Pole 8 x 4.5", .250 Wall
5	15.0" BC, 39 Ft., Alum Lt Pole 10 x 6", .250 Wall
20	15.0" BC, 45 Ft., Alum Lt Pole 10 x 6", .250 Wall
2	15.0" BC, 45 Ft., Alum Lt Pole, 10 x 6", .250 Wall, Special HandHole Location
2	15.0" BC, 55 Ft., Alum Lt Pole, 10 x 6", .250 Wall
5	15.0" BC, 26 Ft., Davit Pole
5	15.0" BC, 31 Ft., Davit Pole
5	15.0" BC, 39 Ft., Davit Pole, 38' – 7"
5	8 Ft., Truss Arm 4", 34" Rise
5	10 Ft., Truss Arm 4", 34" Rise
30	12 Ft., Truss Arm 4", 34" Rise
20	15 Ft., Truss Arm 4", 34" Rise
5	6 Ft., Single Lt Arm
20	8 Ft., Truss Arm 6", 34" Rise
2	8 Ft., Truss Arm 6", 48" Rise
15	12 Ft., Truss Arm 6", 34" Rise
2	12 Ft., Truss Arm 6", 48" Rise
20	15 Ft., Truss Arm 6", 34" Rise
15	15 Ft., Truss Arm 6", 48" Rise
5	15 Ft., Truss Arm 6", 72" Rise
5	8 Ft., Davit Arms, Twin
5	8 Ft., Davit Arm

Pole Parts

Qty	Item
10	15" BC, Adapter Plate
2	16" BC, Adapter Plate
5	T-Base, 13-15" Top, 15-17" Bottom
5	T-Base, 11.5" Top, 15" Bottom
5	T-Base, 11.5" Top, 11.5" Bottom
5	T-Base, 15" Top, 15" Bottom
75	Breakaway Coupling Sets

75	11.5" Fiberglass Shroud
45	15.0" Fiberglass Shroud
25	11.5" Aluminum Skirt
25	15.0" Aluminum Skirt
200	Small Pole Leaves
150	Large Pole Leaves

5.15.2 Suggested Starting Quantities of Contractor Owned Parts for The Pump Station System

Qty	Item
6	AEGIS EPROM Chips

De-watering Pumps

3	4" Pump to de-water the PS, 480/240 volts
1	3" Pump to de-water the PS, 480/240 volts

The Contractor shall have pump(s) capable of a pumping variable head, including piping, fittings, wiring, motor switch gear, and controls to provide a complete operational pump system.

SCADA Spare Parts shall comply with specifications of PS-886 and PV non-biddable pay items PV01-PV04:

Qty	Item
3	Compressors (Gas)
3	Solenoids
1	12V Power Supply
2	Batteries
1	Battery Charger
6	120v Relays
6	12v Relays
2	Level Transducers
3	Voltage-to-Current converter (0-250mv)
3	Voltage-to-Voltage converter (0-160v)
1	Voltage-to-Voltage converter
4	SCADA panel interconnect terminal blocks, one of each type
2	MDS radios 9710B
1	Antennas (Parabolic)
2	Radio batteries
2	Radio power supplies
1	MDS diagnostics board

5.15.3 Suggested Starting Quantities of Contractor Owned Parts for The Traffic Signal System:

Qty	Item
5	TS-I 8 phase – 12 channel cabinets and controllers
2	TS-II 8 phase -- 12 channel cabinet and controller
10	TSI and TSII controllers
2	Eagle Master Controllers
2	Econolite Master Controllers
10	Mast arms and foundation bolts of various sizes
3	Electrical service enclosures

10	Conflict monitors
40	Detector Amplifiers – rack and shelf
5	MMU's
10	BIU's
50	Traffic signal posts of various sizes
30	Signal heads of various sizes
3	Each; LED signal modules, green, red, yellow, green arrow, yellow arrow, red arrow
20	Mast arms signal head mounts
50	Mast arms port mounts
2	Controllers with Railroad Security Software (one each Eagle and Econolite)

5.16 Material and Equipment

5.16.1 Use of Approved Materials

The Contractor shall clearly understand that no equipment or material shall be installed prior to approval by the Engineer and that any equipment or material installed without the approval of the Engineer is subject to removal from the right-of-way solely at the Contractor's expense. If the Contractor changes the supplier of any approved materials for the contract, a new submittal for that item must be made for review and approval by the Engineer. The Contractor shall provide free access to the Bureau of Materials personnel for inspection to insure that the approved materials are used.

The Contractor (including all supervising personnel) is expected to familiarize themselves with all requirements with respect to proper materials, methods and procedures and failure to do so will not be justifiable grounds for lack of compliance with the contract requirements.

5.16.2 Submittals for Approval

Within 60 days after contract execution, the Contractor shall submit to the Engineer for approval, complete, approvable manufacturer's product data (for standard products and components) and detailed shop drawings (for fabricated equipment) of materials and project equipment (products) proposed for use on this Contract for both routine and non-routine maintenance. The Engineer may grant permission to delay certain submittals until the applicable work is authorized, but the 60-day requirement shall apply to all commonly used and general items.

Submittals need not include all project equipment and materials in one submittal; however, the submittals for the equipment and materials for each individual pay item shall be complete in every respect. The Contractor may request, in writing, permission to make a partial submittal. The Engineer will evaluate the circumstances of the request and may agree to review such a partial submittal.

Prior to submittal, the Contractor shall review the submittal material and shall affix his stamp of approval, with comments as applicable, signed by a responsible representative, to each appropriate submittal item. In the case of subcontractors' submittals, both the subcontractor and the general Contractor shall review and stamp approval of the submittal.

The receipt of submittal information from the Contractor will be construed as the Contractor's assurance that he has reviewed the submittal information and attests to the submittal's accuracy and conformance to the requirements of the contract documents. Unless otherwise indicated, manufacturer's guarantees shall be included with the submittal information.

5.16.3 Forms

The Department will furnish the multi-part IDOT submittal record and transmittal form that is required with each submittal. The Contractor and any subcontractor as applicable shall sign the submittal form. Submittal forms shall contain items for only one (1) electrical system. Forms which contain multiple systems, or submittals made without the official form, and/or incomplete forms, will be returned to the Contractor without review.

5.16.4 Certification Requirements

Where certifications are specified, the information submitted for approval shall incorporate certification information. When a certification is available prior to equipment manufacture, the certification shall be included with the submittal information. When a certification is available only after equipment manufacture, the submittal shall include a statement of intent to furnish the certification after equipment approval and manufacture. Certifications involving inspections and/or tests of equipment shall be complete with all test data, dates and times.

5.16.5 Samples

The Engineer may request from the Contractor a sample of a specific item of a submittal for review and evaluation. The sample shall remain property of the Contractor and shall be returned after the review and evaluation with comments as applicable.

5.16.6 New Materials Inspection Requirements

The Contractor shall comply with the applicable requirements of Section 106 and 1000 of the Standard Specifications for Road and Bridge Construction. No uninspected equipment/material is to be delivered to the job site. When underground materials are furnished, the Contractor shall notify the State of Illinois, Department of Transportation, Bureau of Materials personnel to provide proper inspection for the approval of the materials, prior to delivery to the job site.

5.17 Routine Maintenance Payment

5.17.1 Monthly Payment

Each defined electrical system under the Contract will be measured (counted) for payment based upon the quantity of “equivalent location units”, or ELUs, that are under routine maintenance coverage for each monthly pay period. Each monthly pay period shall be a calendar month. Pay quantities for routine maintenance shall be arranged by individual system, but the bid ELU price will apply to all systems.

Payment for the routine work of maintaining system equipment and installations shall be made monthly, based on ELUs applied to mutually-agreed quantities of locations maintained by the Contractor, per electrical system, as existing on the last calendar day of the month. The single routine maintenance bid ELU price shall be applied to the total ELUs under maintenance for the pay period, in order to determine payment to be made to the Contractor.

Those locations, which were removed from Contractor maintenance on or before the last day of the month, shall not be paid routine maintenance.

The Contractor shall be paid the monthly routine maintenance payment for a lighting system location, where only a portion of a cabinet was transferred off routine maintenance.

When the Engineer has determined that all monthly routine work submittals are complete, a monthly routine maintenance letter, which authorizes payment of the prior month’s routine maintenance work, and which itemizes any credits, including credit for state stock used during the past month, debits, withholding, liquidated damages, or deductions for motorist caused damage statement processing, applicable to the monthly payment (also review Article 5.9.5 Damage Caused by Motorists), shall be presented to the Contractor. The Contractor shall create the monthly routine maintenance invoice from the monthly routine maintenance authorization, and bring to the monthly pay meeting.

If routine maintenance work completion is severely delayed or deficient or if the routine maintenance work documentation book has not been received on time, the Engineer, at his option, may delay the pay meeting, thus delaying the routine maintenance payment to the Contractor.

5.17.2 Monthly Pay Meeting

Unless otherwise permitted by the Engineer, beginning in February 2009, pay meetings shall be scheduled monthly by the Engineer, on the second Wednesday or Thursday of the month at IDOT District 1 Schaumburg. The Project Manager and other Contractor personnel, as requested by the Engineer, shall meet with Department personnel to present the Routine Maintenance invoice for payment and to review the routine maintenance work progress of the prior month and work planned for the future months. The Contractor shall be provided with a completed ticket summary for the past month and comments from the Engineer regarding the submittals of the monthly routine maintenance documentation book. The Contractor shall be notified of the satisfactory or unsatisfactory work in the prior month, both for routine and non-routine work.

Article 6.0 -- Non-Routine Maintenance Work and Payment

6.1 Control of Work

6.1.1 Description of Work

Non-routine work under this Contract is specifically authorized work, not covered under the requirements of routine maintenance, for materials and work on the systems that tends to be irregular, event driven, or otherwise based on the selective direction of the Engineer in response to system needs. Non-routine work shall include unit-priced (PAY ITEM) work, agreed price work, force-account work, and non-routine specialty service work.

An EMCMS authorization letter shall be received by the Contractor prior to the start of all non-routine work. Any non-routine maintenance work undertaken by the Contractor prior to receiving an approved authorization is done at the Contractor's own risk. The Department is under no obligation to pay for unauthorized work or work which is not in compliance with this contract.

The Department is under no obligation to authorize any non-routine work. The Department shall authorize unit price work wherever possible, as meets the system needs, or unit price work in addition to agreed price or force account work for the same project/location, if in the best interest of the Department. Quote work or force account work shall be performed using first shift labor rates for straight time whenever possible, or first shift overtime or double-time rates when permitted by the Engineer. Allowable equipment operating rates shall be taken from the FHWA hourly rates in the Equipment Watch Rental Rate Blue Book. A separate standby time hourly rate will not be paid.

Contract provisions or practices employed under other contracts shall have no bearing on these constraints under this contract.

Payment to the contractor will be made only for actual quantities of work performed and accepted, materials furnished as specified, and new record drawings submitted as requested.

The Department reserves the right to furnish any or all of the materials or parts for non-routine work, in which case no charge for items so furnished, shall be made by the Contractor. Materials or parts furnished by the Department may be from the state stock inventory or from other sources available to the Department.

If requested by the Engineer, the Contractor may be required to perform non-routine work at a location not listed herein.

6.1.2 Unit Price Authorizations

Unit-priced (PAY ITEM), non-routine work shall consist of work which has been authorized based upon the unit prices (PAY ITEMS) bid on this contract for the various non-routine work items.

Non-routine unit price work as required herein shall be authorized by the Engineer on an EMCMS estimated authorization letter, prior to the beginning of a job, when quantities are estimated.

All pay items listed herein can be used for any electrical system.

6.1.3 Agreed-Price Authorizations

Agreed-price, non-routine work shall consist of work for which bid unit prices are not applicable. The Contractor shall prepare, in accordance with Article 109.04 (a) of the Standard Specifications, and as directed by the Engineer, a quote for an agreed price.

The Contractor shall enter all price quotes for agreed price or force account non-routine work authorizations in the EMCMS within five (5) working days of the Engineer request. The Contractor is

required to enter clearly written concise quotes in the specified format of the EMCMS, and email or fax copies to the Engineer, but is not required to mail typed (hard copy) quotes. If additional explanation is necessary the Contractor may, however, submit additional paperwork to accompany any quote that explains complete details or provides justification of the work or price. One quote shall be necessary for each non-routine authorization letter.

The Contractor may submit an estimated quote for agreed price work, prior to the beginning of a job, when quantities are estimated. If specifically requested by the Engineer, however, the Contractor shall submit a fixed, agreed price quote for the necessary work.

Non-routine agreed price work, as required, shall be authorized by the Engineer on an EMCMS authorization letter, prior to the beginning of a job. Once the Department issues an agreed-price authorization from a Contractor supplied quote and the Contractor has logged it as received, there will be no revision to the per hour labor costs effective on that date. The quote submitted to the Department should take into account the expected completion date of the work.

The Contractor may be requested to provide an agreed price quote for Department specialty service work as necessary. If the Contractor is furnishing an invoice for materials for specialty service work, the quote may include an appropriate mark-up per Article 109.04(b)(3) of the Standard Specifications for Road and Bridge Construction. In no case shall specialty service work, in its entirety be considered “materials” when a quote for specialty service work is submitted to the Department, or shall Article 109.05 of the Standard Specifications for Road and Bridge Construction be applicable.

6.1.4 Force Account Authorizations

Force Account Work shall consist of work for which an agreed price cannot be established between the Engineer and the Contractor. The Engineer may direct the Contractor to perform any non-routine work as force account work which shall be measured and paid as described in Article 109.04(b) of the Standard Specifications for Road and Bridge Construction.

A time/work accounting shall be kept on the daily general billing log, which shall be signed by the Contractor’s field supervisor and submitted to the Engineer at the completion of each work day for the authorized work. A summary of all daily general billing logs, as well as proper documentation of materials used, shall be submitted to the Engineer within seven (7) working days following the completion of work.

A general foreman’s time will not be billable on force account work unless there are more than five (5) additional crew workers employed at any one time, place and job and then only with the prior approval of the Engineer. A mark-up of fifteen (15) percent is allowed for material costs, which shall include any shipping and handling fees. The Contractor shall not be allowed overtime and/or prime time billing unless prior approval is received from the Engineer.

The Contractor is required to submit an estimated price for the force account work, prior to the beginning of the job. Force account work as required herein shall be authorized by the Engineer on an EMCMS estimated authorization letter.

6.1.5 Expenses Incurred By The Department

In accordance with Article 109.05 of the Standard Specifications for Road and Bridge construction, as hereby modified, upon written request of the Engineer, the Contractor shall pay the bills for specialty service work and/or expenses incurred by the Department. The Contractor shall be paid administrative costs of an amount equal to five (5) percent of the first \$10,000, with a minimum of \$ 100.00, and the Department shall allow an additional one (1) percent of any amount over \$10,000 of the total approved costs, for an individual work authorization. This work shall be authorized on an EMCMS estimated authorization letter.

6.1.6 Transmittal of Non-Routine Work Assignments

It is the Contractor's responsibility to review daily, on the EMCMS, the list of authorizations which have been transmitted to the Contractor, and subsequently view and print the non-routine work authorization letters. The Contractor shall communicate with the Engineer regarding any questions about the work assignment. Any non-routine authorization letters which have been transmitted, but not entered as received by the Contractor on the EMCMS within seven (7) working days shall be subject to the assessment of liquidated damages. (Review liquidated damages as specified herein.)

6.2 Non-Routine Work Completion/Approval/Invoice Requirements

6.2.1 Completion Time

The normal completion time for non-routine work shall be 90 calendar days from the IDOT_transmittal date of the authorization letter, or as specified by the Engineer. The Contractor may contact the Engineer to request a later date, or the Engineer may request an earlier date from the Contractor. If the Contractor fails to seek a change in completion date, the work completion time will remain as initiated by the Engineer. The Contractor is urged to check the EMCMS to review all authorizations which have been transmitted.

6.2.2 Work Completion Notification to The Engineer

Unless prior approval is given by the Engineer, the Contractor shall notify the Engineer one day, (24 hours), prior to the Contractor's completion of the authorized work project in order that a joint EMC/IDOT inspection of the work may be held. In addition, the Contractor shall submit record drawings of any changes to the system(s) prior to the completion of the work.

6.2.3 Contractor EMCMS Work Completion Requirements

When the work is complete the Contractor shall enter the work completion date in the EMCMS authorization letter, print an EMCMS copy of the authorization letter, note any pay item quantity changes, enter EMCMS quote final quantities if required, and email or fax to the Engineer.

6.2.4 EMCMS Work Inspection Approval

Following a field inspection, if all required documentation of work has been received, and record drawings submitted if requested, the Engineer shall enter the final pay item quantities, work inspection approval date, and EMCMS Engineer approval in the EMCMS final authorization letter. This final non-routine work authorization is transmitted to the Contractor.

The Engineer may waive the physical field inspection of any work if he believes the completion to be reasonably demonstrated by performance of the system, electronic monitoring, or other means. In such cases, the Engineer reserves the right to follow-up and/or selective spot inspections, and if evidence of prior incomplete or incorrect work is found, the Contractor shall remain responsible for corrective action and open to liquidated damages and/or payment withholding as provided elsewhere herein.

6.2.5 EMCMS Corrective Work List

In cases where deficiencies are found at the IDOT inspection of the Contractor's work, the Engineer shall issue a corrective work list (CWL) on the EMCMS. The Contractor should view the EMCMS corrective work list summary report on a regular basis in order to promptly address any work deficiencies. When the Contractor has completed the work deficiencies the Contractor shall notify the Engineer that the work is ready to re-inspect.

6.2.6 EMCMS Non-Routine Work Invoicing Procedures

The Contractor shall review daily, on the EMCMS, the list of authorizations which have been transmitted to the Contractor, and subsequently view and print the final non-routine work authorization letters. After these procedures are completed the Contractor may create an EMCMS invoice for payment of the work.

The Contractor shall prepare an EMCMS invoice for each Final Authorization letter. Each EMCMS invoice shall carry the same number as the authorization letter and shall be signed by a Principal of the

Company, attesting that the work, as invoiced, has been completed and inspected in accordance with the provisions of the Contract and all applicable specifications. The invoice shall also show a notarized certification by an officer of the Company. The Contractor's invoice shall conform to the EMCMS form requirements. The Engineer, prior to the start of the contract, shall review and approve the style and format of the Contractor's invoice.

All work billed for payment shall be complete, no billing for partially-completed work will be allowed. All invoices shall be submitted to the Department no later than 30 days following work completion approval by the Engineer.

To receive payment for completed work, the Contractor shall submit to the Engineer an original signed invoice with one copy, and an original signed final authorization letter with one copy. (An estimated authorization letter will not be acceptable.) The Engineer will sign the original invoice and final authorization and will forward to the District's Financial Services office personnel for scheduling of payment. An EMCMS entry is made for all invoices, noting the date it was scheduled for payment. Normal processing time for non-routine work payment to the Contractor is 6 to 8 weeks.

6.2.7 Payment To Specialty Vendors

Refer to Article 6.1.5 for a definition of non-routine work authorization for Expenses Incurred by the Department. Within seven (7) days following the EMCMS entry of the date the work was scheduled for payment, the Contractor shall pay the specialty vendor invoice, and fax or e-mail a confirmation of the payment with check number to the Engineer. If this procedure is not followed the Contractor shall be subject to the assessment of liquidated damages. (Review liquidated damages as specified herein.)

6.2.8 Payment for State Stock Warehouse Personnel

The Contractor will be reimbursed, through a monthly non-routine work authorization, for the State Stock Warehouse personnel warehousing time (labor and equipment) to move construction (non-EMC) materials into the State Stock Warehouse. At the end of the month the Contractor shall provide the Engineer with a summary of the dates of construction material receipts accompanied by an invoice(s) from the State Stock Warehouse, noting actual hourly labor and equipment charges (warehousing time).

Article 7.0 -- Lighting, Navigation and Sign Illumination System

7.1 System Description and Maintenance Responsibilities

The lighting, navigation and sign illumination system (Lighting System) consists of highway lighting, underpass/ tunnel lighting, navigational lighting, and sign illumination; potentially 550 independently controlled installations on the expressways, primary highways, and navigation channels in District 1. These installations include various types of lighting fixtures and lamps, lenses, reflectors, shields, poles, mast arms, mounting devices, supporting unistrut (U-channels), step-down or buck-boost transformers, ballasts, T-bases, decals, mile markers, cables, cable brackets, foundations, conduit, control devices, radios, lighting cabinets, fenced enclosures, access gates including locks, above ground cable splice boxes, exposed conduit, uniduct, facility outdoor lighting equipment, fixtures mounted on fixed bridges, piers and abutment walls, lighting SCADA equipment, and other lighting appurtenances owned by the State of Illinois and under jurisdiction of the Department.

A summary of the current lighting locations are show in Section 3.

All items as listed in the system description herein shall be maintained under routine maintenance, unless stated otherwise herein. Also refer to Article 5.0 for other maintenance responsibilities and Article 1.0 for the bidding quantities.

7.2 Lighting System Routine Maintenance Pay Items

The routine maintenance pay items for the lighting system are as follows:

L-1, Lighting System – On-Expressway: The lighting system locations on Interstate Highways and their extensions leading in to State and/or US Routes.

L-2, Lighting System – Off-Expressway: The lighting systems at off-expressway locations, where the number of luminaires at the location are greater than 8.

L-3, Lighting System – Other Lighting: The lighting system locations on State maintained routes, where the number of luminaires at the location are less than or equal to 8. The luminaires at these locations may be mounted on combination traffic signal posts and/or on light poles and/or on towers and/or on navigational structures, and/or in an underpass and/or on sign structures as shown in the List of Locations.

7.3 Response And Repair Time Requirements

Article 5.0 discusses general response requirements of routine maintenance. The following chart lists routine maintenance maximum response time, service restoration, and permanent repair times specifically allowed for the Lighting, Navigation and Sign Illumination System.

Incident or Problem	Service Response Time	Service Restoration Time	Permanent Repair Time
Control cabinet out	1 hour	4 hours	7 Calendar days
Hanging mast arm, head or open luminaire	1 hour to clear	na	7 Calendar days
Radio problem	1 hour	4 hours	7 Calendar days
Motorist caused damage or leaning light pole 10 degrees or	1 hour to clear	4 hours	7 Calendar days

more			
Circuit out – breaker	1 hour	4 hours	7 Calendar days
Circuit out – Cable trouble	1 hour	24 hours	21 Calendar days
Outage of 3 or more successive lights	1 hour	4 hours	NA
Outage of 75% of lights on one tower	1 hour	4 hours	7 Calendar days
Outage of light nearest RR crossing approach, islands, or gores	1 hour	4 hours	NA
Multiple Outages (found on night patrol survey or reported to EMC)	1 hour	4 hours	7 Calendar days
Navigation light outage, single	NA	1 day	7 calendar days

- **Service Response Time** -- amount of time from the initial notification to the Contractor until a patrolman physically arrives at the location.
- **Service Restoration Time** – amount of time from the initial notification to the Contractor until the time the system is fully operational again (In cases of motorist caused damage, the undamaged portions of the system are operational.)
- **Permanent Repair Time** – amount of time from initial notification to the Contractor until the time permanent repairs are made if the Contractor was required to make temporary repairs to meet the service restoration requirement.

7.4 Routine Maintenance Equipment Responsibilities

Decal

The cabinet, light pole, underpass or light tower identification decal shall be replaced on the same day in which the decal is observed and/or reported to be missing or damaged from any cause whatsoever.

The accident reference (mile marker) decals affixed to light poles shall be replaced on the same day in which the decal is observed and/or reported to be missing or damaged from any cause whatsoever.

Light pole replacements due to motorist caused damage shall have all decals, including accident reference numbers, furnished and installed by the Contractor.

Controller

The lighting controller has several components that require special training (refer to Article 11.0) to understand the operation and its maintenance. The Contractor must follow a procedure that implements those items covered with special training classes to enable the patrolman to troubleshoot systematically and identify the faulty component whenever there is a problem with the controller. After responding to a trouble call, the patrolman must record the purpose of call and action taken for temporary service

restoration. The purpose of recording into the log sheet is to reduce repetitive calls caused by the same component. If there is a more than one service call due to the same component within a month, the Contractor shall replace that component with a new one instead of making temporary repairs.

SCADA Alarms:

Receipt of three (3) alarms during one (1) month period, indicating the existence of a recurring problem, shall be investigated and promptly repaired to eliminate the reported alarms. The Contractor shall report his corrective action via email or “The Contractors Advisory Inspection Log Sheet” as per Article 5.

Cabinet Components:

Receipt of three (3) or more independent lighting service tickets where the problem is caused by the same component(s) during any two (2) month period indicating the existence of a recurring problem will be considered unsatisfactory service.

Clock setting:

The repeated controller malfunctions due to an incorrect time of the day setting on the controllers’ time clock which results in not energizing lighting at sunset and not de-energizing the lighting installation at sunrise shall be considered unsatisfactory service.

Cabinet:

The Contractor shall repair lighting cabinet doors, hinges, meter box, etc., to keep the cabinet functioning effectively.

Log Sheets:

All inspections shall be logged and recorded with action taken. The Contractor shall maintain service log sheets in each lighting cabinet. New log sheets shall be placed in the cabinet (in protective plastic) in January 2009. The removed (completed) log sheets shall be submitted to the Engineer by January 31st in the monthly routine maintenance work documentation book.

Foundation:

Minor repairs to concrete foundations shall be completed within seven (7) calendar days from the date of discovery and issuance of a ticket, or within twenty one (21) days if the rebuilding or complete replacement of a concrete foundation is required.

Pad and bumper post:

If the cabinet pad and/or bumper post are found to be missing, damaged or have shifted due to the ground condition, then Contractor shall repair or replace to the original condition.

Warning sign:

The Contractor shall affix a “voltage warning” decal/sign (as approved by the Engineer) to all cabinets if it is missing or damaged for any cause whatsoever.

Radio:

When the Contractor removes a lighting cabinet radio for repair, it must immediately be replaced with a spare radio from the Contractor’s spare parts inventory. The Contractor is required to have two (2) working, SCADA radios available in his spare parts inventory at all times. The Contractor shall repair the defective radio within seven (7) calendar days, or shall replace with a new radio similar in kind or current version. The ticket shall document this exchange/repair.

Utility Service Voltage:

The Contractor shall dispatch a patrolman to check if there has been a notification of low voltage and/or utility problems within one (1) hour of notification. If the service voltage is not restored before sunset, then the Contractor shall provide a generator to power the lights.

Vegetation:

The Contractor shall clear all vegetation within the 10-ft. areas surrounding the controller.

Light Pole Unit

Pole:

Standard (non-davit) round-tapered, conventional or davit light poles decorative or painted of different manufacture than the originally-installed pole may be used, but shall otherwise be in conformance with approved submittal requirements. Standard light pole mast arms shall be replaced with the same length, diameter, and shape as the original installation or as modified by plan. All resets of light poles from knockdowns or new installs shall use a transformer base (T-base) not a breakaway coupling. The replacement pole shall meet UL standard.

Ground Lug:

If existing ground tap/lug is damaged or not functional, then the pole should be drilled and the ground wire lugged on and not wrapped.

Light Pole Foundation:

It is the Contractor's responsibility to be knowledgeable of safety requirements for light pole foundation construction and current approved height limitations for base extensions above the adjacent grade. See lighting Figures L-5a (concrete) and L-6 (metal) for foundation details distributed at pre-bid meeting as per Article 1.5.

Minor repairs to concrete foundations shall be completed within seven (7) calendar days from the date of discovery and issuance of a ticket, or within twenty-one (21) days if the rebuilding or complete replacement of a concrete foundation is required.

Uniduct Exposure:

Uniduct must be visible inside the pole. Below the foundation grade or flush is not acceptable. Where uniduct is below grade or flush, a split 12" uniduct extension shall be installed in place (excluding existing direct buried cable).

Mast Arm:

The Contractor shall use the same mast arm of the type, color, length, direction and rise, replaced after a knockdown by a motorist, or fall down due to high wind or age. The davit arm shall be horizontal to the X-axis and 90 degrees to the shaft plus/minus a tolerance allowed by the manufacturer.

Anti-Theft Locking Devices:

Selected locations of the Eisenhower (I-290) Expressway have a special anti-theft locking device on handhole covers and junction boxes at power centers to prevent cable theft. It is the Contractor's responsibility to monitor the special coded, keyed nut drivers required for these junction boxes. If a coded key is lost, it shall be the Contractor's responsibility to furnish and replace a new coded fastener nut at all locations with these anti-theft locking devices, and replace the coded, keyed nut drivers, all at the Contractor's expense.

Light Tower

Light Towers Requiring Special Maintenance:

Additional personnel and equipment may be required to perform routine maintenance (outages and safety inspections) on light towers located on I-290 (Eisenhower Expressway) near Wolf Road, I 80/90 Kingery Expressway and I 394. A lane closure is required, as are attenuators and a bucket truck due to the barrier wall adjacent to the foundation.

CCTV:

The Contractor shall list separately all the towers with CCTV during the Wash and Relamp and Tower Inspection Programs. If there are any damages to the camera and/or cable, the Contractor shall create

an EMCMS ticket for repair. The EMC dispatcher shall notify the IDOT ComCenter and Advanced System Maintenance Contractor (ASMC) of the problem.

Tower Knockdown:

Within ten (10) calendar days from notification of a tower knockdown, the Contractor shall install temporary lighting (under routine maintenance) to restore lighting service and shall provide catalog material cuts for the tower replacement to the Engineer for approval. The Contractor shall complete the permanent restoration work under the non-routine maintenance pay item when the light tower is replaced.

Tower Reset:

The Contractor shall be paid through a non-routine work authorization for the permanent replacement of a light tower due to motorist caused damage. Following the approval of the catalog cuts, and receipt of a non-routine authorization, the Contractor shall order the material and complete the reinstallation of the light tower within a three (3) month period.

Block Retaining Wall and Pad:

If a light tower block retaining wall and adjacent concrete pad are found to be damaged, they shall be promptly repaired.

Site Maintenance:

The Contractor shall clear all vegetation within the 10 ft area surrounding a light tower.

Rust:

The Contractor shall inspect rust on outside of the shaft and at all slip joints during the wash/relamp and tower inspection programs. The location and magnitude of the rust spots shall be described in detail on the inspection report. Contractor shall note if immediate corrective action is necessary by submitting a Contractor Advisory Report. Any rust spots, found within 20 feet from ground, shall be cleaned and touched up at the time of the wash/relamp or tower inspection program through routine maintenance. If the Engineer determines the need to paint the whole tower, the Contractor shall be paid through Non-Routine maintenance pay items.

Analysis Report:

The Contractor shall subcontract to conduct an analysis and inspection for rust at tower slip joints on twenty (20) light towers per year. The Contractor shall use a program equal to Utilivations Mast Check (www.utilivations.com) which records a complete 360 degree digital video record of the entire tower exterior (pole surface, slip joints, and foundation) while performing data collection. A summary report shall be provided with photo analysis. This program is similar to other Department of Transportation (DOT) agencies programs which use CCTV to test for safety.

Corrosion Depth at Base of Tower:

Measure and record the thickness of the tower material at eight (8) points around the base using an ultrasonic meter. The eight points will consist of one point six (6) inches above the base and another at eighteen (18) inches above the base. There will be four (4) sets of these points spaced at approximately 90 degrees around the tower base.

Base Weld Cracks:

The vertical tower column is connected to the base with a fillet weld. Clean and prepare the surface for a dye penetrant test by mechanically removing the paint and other coatings followed by a chemical cleaning on each tower to detect the presence and extent of weld cracks.

Anchor Bolts:

Use an ultrasonic testing system to analyze each anchor bolt searching for cracks within the first 6-8 inches.

External Portable Drive:

The Contractor shall maintain, in proper working order, all external portable drive units in state stock, which are used to lower the towers which are without an internal drive.

Luminaires

Replacement:

Certain requirements apply when lighting units are replaced or repaired in place under routine maintenance. Unless otherwise authorized by the Engineer, luminaire ballasts shall match the system voltage and be of the same type and characteristic as the original design and installation being replaced. In addition, except as otherwise indicated or authorized by the Engineer, the luminaires installed as replacements at an installation location, installed within six (6) years of the current year, shall be of the same manufacturer, and have the same photometric performance specification as the originally installed luminaire.

When a replacement luminaire is installed, it shall be equipped with a new lamp. Ballasts in luminaires, employed on other than the District's standard voltage of 240 volts single phase, may be of a multi-tap type, as approved by the Engineer. Luminaires replacing drop-lens (reflector-type) may be replaced with flat-glass cut-off type units of a distribution type and photometric performance approved by the Engineer. The Contractor shall submit proposed variant replacements to the Engineer for approval.

Tower:

The Contractor shall wash all the luminaires on the ring during an outage repair and record on the tower safety inspection log.

Shields (Light Towers or Light Pole Luminaires):

The luminaire shield, if found to be torn or ineffective, or missing, or at the time of a knockdown repair, shall be replaced with the same kind or better.

Luminaire Keeper:

The luminaire keeper, if found to be torn or ineffective, or missing, or at the time of a knockdown repair, shall be repaired or replaced with the same kind or better.

Cable

Repair or replacement:

The Contractor shall repair or replace all cable and associated equipment grounding cable or integral cable-in-duct combination, which becomes damaged, displaced, defective or missing from any cause whatsoever. If an aerial cable is used for temporary response, it shall be installed so that its lowest point is at least twenty-five (25) feet above ground level. When cable deficiencies become suspected or known, the Contractor shall take immediate corrective action to make temporary repairs. Permanent repairs shall follow as soon as possible and shall be completed within 21 calendar days. Only for notifications of cable failure after December 1, when frozen ground conditions restrict permanent repair work, will the temporary repairs be acceptable for a longer period of time. When temporary cable is installed, all splices shall be as good as splices for permanent repairs and proper grounding shall be observed. In all cases where temporary repairs were made during the winter months, permanent repairs shall be completed by May 30.

The Contractor shall document on tickets all cases where temporary aerial cable was installed or found, failure to respond such instances shall be grounds for assessment of liquidated damages. Temporary ground laid cable or attachment to the metal structures is not allowed. Except as otherwise authorized by the Engineer, cable used to repair or replace faulty cable runs under routine maintenance shall be new, and shall be copper conductor EPR-insulated cable. The new cable run shall include a separate green ground wire sized in accordance with codes, even if it did not exist before the malfunction.

Cable in Duct or Conduit:

Where damaged cable is in duct or conduit, the faulty wiring shall be removed and replaced with the approved new cable and the duct or conduit shall be repaired. The rigid galvanized conduit shall be used under roadways and driveways to push the uniduct

Cable Run/Grounding Conductor:

The new cable run shall include a green equipment ground conductor sized in accordance with the electrical codes. All cable used shall be new copper conductor, EPR-insulated as specified. If the uniduct cannot accommodate the green insulated ground wire, then the bare ground wire continuity shall be tested/measured. All pertinent information shall be documented and communicated to the Engineer by email. If the existing installation is without an equipment ground wire, the Contractor shall also note this information in email to the Engineer.

Ground Well/Rod:

The ground well/rod for lighting cabinet, HMLT (high mast lighting tower) and pole shall be inspected for exothermic weld and continuity, if defective shall be repaired or replaced.

Cable Repair (Direct Buried):

The Contractor shall remove and replace any section of faulty direct buried cable plus a minimum of three (3) feet on each side including all of the undamaged adjacent cables. If the fault is six (6) feet or less from a pole, splicing handhole, or a control cabinet, the six (6) foot section shall be removed and replaced. The Engineer shall approve the cable to be used and the type of splices. Existing underground wires may be spliced. If no equipment ground wire exists, the Contractor shall note this information in email to the Engineer.

Sign

Construction Coordination

When a sign structure is being repaired or replaced, the Contractor shall disconnect and/or reconnect the sign structure as requested by the departmental personnel. Prior to a maintenance transfer, the Contractor shall inspect the sign installation with the Engineer and/or IDOT inspector.

Disconnect switch

The contractor shall replace disconnect switch if it is rusted and inoperable to isolate sign lighting fixtures.

7.5 Lighting SCADA System

The lighting SCADA system enables the remote control of the lighting at the cabinets equipped with radios along the expressway system on certain arterial highways within District 1. The lighting at such locations is automatically turned on after sun set and turned off before sunrise by the photocell control at D-1 ComCenter.

Manual remote control features are also available at the IDOT ComCenter, the Traffic Operations Field Office, and the EMC Dispatch Center. The Contractor shall assume responsibility for all manually-initiated commands of the system, such as that required for day time inspection of selected lighting system installations. (In no case, shall the Contractor substitute this partial control of the system for the required lock-out/tag-out procedures necessary for safe work practices.) The Contractor shall note, however, that unless there are specific arrangements with the Engineer to the contrary, all normal automatic features shall remain operational at all times.

The Department retains the right to suspend or terminate the Contractor's privilege to use the system for misuse of the system or any other reason. Only trained/qualified Contractor personnel shall be allowed to operate the lighting SCADA system. Also refer to Article 11, Extra Systems.

7.6 Monthly Daytime Tunnel Lighting Inspections

The Lighting System Manager or other personnel, as approved by the Engineer, shall under routine maintenance, schedule an inspection during the first half of the month, to review the operational condition of daytime tunnel lighting equipment to assure that systems are performing at the level of service for which they are designed. The equipment required for both day and night circuit operation shall be inspected.

The Contractor shall record all lighting outages and other deficiencies, on the tunnel outage log L-1, and date of repairs when complete. Outage repairs for all tunnels are to be completed within seven (7) calendar days of the monthly daytime inspection. The tunnel outage logs are to be emailed to the Engineer, when repairs are complete. In addition, the lighting system manager shall notify the Engineer or appointed IDOT Inspector, when repair work is complete, so a joint inspection may be conducted, on a mutually agreed date, during the last work week of the month.

Locations for tunnel inspections:

Loc. # L0115	Stewart's Cave Tunnel
Loc. # L0137	I-55 Tunnel @ Pulaski Road
Loc. # L0873	Erie Street Tunnel
Loc. # L0883	Hubbard's Cave Tunnel
Loc. # L1325	I-290 @ Canal St. (under Post Office)
Loc. # L1740	Lower Wacker Drive @ Randolph
Loc. # L1745	Lower Wacker Drive @ Madison
Loc. # L1753	Lower Wacker Drive @ Adams
Loc. # L1755	Lower Wacker Drive @ Van Buren
Loc. # L1713	US 34 (Ogden Ave) @ 26 th St.,

7.7 Monthly Lighting Installation Inventory Inspection

The Contractor shall conduct a physical inventory inspection of five (5) lighting locations (power centers) per month per contract year, as designated by the Engineer. The Contractor shall obtain a copy of each installation plan from Traffic Operations field office in order to verify the quantity of each lighting unit shown on the design plan. After the field inspection, the Contractor shall mark and update the record plans or sketches with any equipment changes or additions to the installation.

The updated plan including the single line diagram and an inventory (log L-6), noting quantity, sizes, types and manufacturer of the lighting units and control cabinet components shall be submitted with the monthly routine maintenance work documentation book. In addition, the Contractor shall submit verification that all lighting units are operating and that each unit is properly labeled and wired to the circuit as labeled in accordance with the record drawings. Tickets shall be created for all displaced defective, damaged or missing items as found.

7.8 Monthly Faa Obstruction Light Inspection

The Contractor shall conduct a monthly inspection of the obstruction light mounted on top of light pole "HH26" on I/B I 290 @ Western Ave., Location L1335, Cabinet "H". The power for the obstruction light is fed from a Surveillance Cabinet "G10". Any outage found shall be reported to the EMC Dispatch Center and an EMCMS ticket created. The ComCenter shall also be notified. Repairs shall be made within 24 hours, under routine-maintenance.

7.9 Routine Maintenance Programs

The Contractor shall list inspections and repair work in the daily agenda. No allowances will be made for delays due to poor weather or personnel shortages. If work is not completed on time, routine maintenance withholding of up to \$5,000 per location and/or liquidated damages may be assessed until all work is completed.

7.9.1 Yearly Clock, Radio, and Exterior Cabinet Inspection

The Contractor shall conduct an exterior control cabinet and clock inspection at every lighting system location, once per year. An inspection schedule shall be followed, as presented by the Engineer. Approximately fifty (50) cabinets are to be inspected monthly. This schedule will be available at the Pre-Construction meeting.

The Contractor shall replace the back-up battery for clocks (chargeable or regular), record the battery model and number installed on inspection log L-2. The Contractor is also required to put a sticker on the clock indicating the date for new battery, record the location number, name and battery model and serial number installed information to a spreadsheet, and submit monthly in the routine maintenance work documentation book.

The Contractor shall clean the cabinet install decals or replace if necessary, and check the following (refer to log L-2):

- Time clock, including escapement (reserve power) and back up battery
- Background timer
- Springs (reset as required)
- Lighting contactors and surge suppressor
- Tighten all the contacts with proper torque
- Radio harness, connectors, cables
- Clean inside with vacuum cleaner
- Antenna

In order to enhance the information available on the EMCMS, the Contractor shall identify each lighting cabinet by the name of the nearest cross street at its starting and ending points, both by GPS, and list all cross streets (including those over and under) and/or ramps.

Repairs must be completed in the same month as the inspection. L-2 logs with repair work notations and ticket numbers shall be submitted to the Engineer in the monthly routine maintenance work documentation book. Tickets shall be created for any problems found.

The log form for this survey will be available at the Pre-Construction meeting. Logs shall be submitted in the monthly routine maintenance work documentation book.

7.9.2 First Year Scada Backup Battery Replacement For Radio

The Contractor shall replace the SCADA backup battery for the radio at all lighting locations in 2009, during clock, radio and exterior cabinet inspection program. The location number and name, and the battery model installed shall be recorded on inspection log L-2.

7.9.3 Yearly Control Cabinet Inspection (One Half of all Lighting Locations Per Year)

The Contractor shall conduct control cabinet inventory inspections on one half of all lighting locations once per year. Information to be collected on log L-3 includes, but is not limited to, CE meter number, CE supply voltage, transformer size, location and transformer number, conduit and cable types, and clock manufacturer and model number.

The contractor shall carry a digital camera to record the control cabinet pictures, one to show inside of the cabinet and other to view outside of cabinet, for each location. All the pictures shall be transferred into a file on disc to submit with monthly submittal book.

Objectionable current flow from one ground connection to another, which occurs from multiple grounds on the same system equipment or highly unbalanced loads shall be identified and logged. Also the ground resistance and the continuity test for all the circuits shall be measured and documented on the log L-3 as

part of the inspection. Before making test measurements, the Contractor shall verify that all luminaires are operating.

As part of this inspection the following SCADA system items shall also be completed:

1. All SCADA inputs/outputs shall be checked for proper operation. This shall be verified by visual inspection of the SCADA CPU.
2. SCADA radio system communications shall be checked to and from the cabinet.
3. Confirm the calibration of analog input values. (This is done by measuring the current and voltage inputs and having the EMC Dispatch Center interrogate the power center.) The interrogated values shall be equivalent to measured values. If the voltage is different by +/- 3 volts or if the amperage is different by +/- 2 amps, a Ticket shall be generated.

The Contractor shall follow an inspection schedule as presented by the Engineer. Approximately twenty (20) cabinets are to be inspected monthly. This schedule will be available at the Pre-Construction meeting. Repairs must be completed in the same month as the inspection. L-3 logs with repair work notations and ticket numbers shall be submitted to the Engineer in the monthly routine maintenance work documentation book.

7.9.4 Yearly Light Pole and Underpass Safety Inspection

The Contractor shall conduct a safety inspection of all lighting locations once per year. The purpose of this inspection is to insure that all lighting unit components are maintained in a safe and effective operating condition as originally designed or as subsequently modified by the Department. A minimum of fifty (50) lighting system locations per month must be inspected beginning in February, and continuing in subsequent months, with the remainder of the locations due in November of each calendar year.

Repairs must be completed in the same month as the inspection. L-4 logs with repair work notations and ticket numbers shall be submitted to the Engineer in the monthly routine work documentation book.

Required repair work includes replacement of damaged poles, T-base, mast arms, luminaires, shields, luminaire keeper, leaning poles, hardware, underpass fixtures, junction boxes, conduit, conduit hangers, or missing appurtenances such as decals, decal mounting brackets, mile markers, shrouds, skirts, leaves, and handhole doors. All equipment and materials required for repairs and replacements shall be furnished as part of routine maintenance.

The Contractor shall identify:

- existing light pole bases which are too high and do not conform with the current approved height limitations for base extensions above the adjacent grade
- loose and/or worn nuts and washers by lifting the shroud or removing the skirt
- any other abnormality (cracks, loose nuts and joints) due to the wind load condition
- leaning (more than 10 degrees) poles
- Davit poles with open mast arm (not parallel to ground)
- pole that is susceptible to hit by motorist due to road condition
- mast arms fastened with riv-nuts
- lighting locations with temporary aerial cable

The Contractor may be entitled to material only re-imbusement per Article 5.0, Contractor Advisory Inspections.

It is at the Contractor's option to conduct this PM program at the same time as the non-routine group wash and relamp program.

The Contractor shall conduct any safety inspection of light poles or underpass fixtures when recommended by the manufacturer, upon request by the Engineer, which is in addition to the regular inspection as specified herein.

7.9.5 Yearly Light Tower Safety Inspection

The Contractor shall conduct a safety inspection of all light towers once per year. The purpose of this inspection is to insure that all tower components are maintained in a safe and effective operating condition as originally designed or as subsequently modified by the Department. The inspections shall be completed by the end of November of each year. The same tower locations shall be inspected the same month in both the first and second year of the Contract.

The Contractor shall examine for deterioration:

- Paint
- Metal parts (for corrosion and/or rust)
- Foundation
- Mounting bolts
- Shaft
- Handhole doors
- Lowering device including motor and cables
- Ring assembly electrical cable (faulty splices)
- Fuse kits
- Decals and decal mounting brackets
- ESCO stainless steel swage sockets for cracks

The Contractor shall also identify the number of towers at each location and the number of lamps per tower, tower with CCTV.

All the deficiencies found during this inspection shall be listed on the inspection form and repairs must be completed within 30 days of the inspection. L-5 logs with repair work notations shall be submitted to the Engineer in the monthly routine work documentation book. The Contractor may be entitled to material only re-imburement per Article 5.0, Contractor Advisory Inspections.

It is at the Contractor's option to conduct this PM program at the same time as the non-routine group wash and relamp program. The Contractor shall conduct any safety inspection of light towers recommended by the manufacturer, upon request by the Engineer, which is in addition to the regular inspection as specified herein.

7.9.6 Annual Photo-Cell Calibration

Each year, on the day of the summer solstice, normally June 21st, the Contractor shall test and adjust the Hubbard's Cave and Stewart's Cave tunnel consoles per manufacturer's operation manual. The Engineer shall attend this inspection and provide the luminance level specifications for Stewart's Cave (L0115) Tunnel and Hubbard's Cave (L0883). Also on this day, the Contractor shall check and clean the Schaumburg photo cell and adjust to 5 +/- 0.5 ft. cd., or as specified by the Engineer for proper lighting SCADA control operations.

7.10 Annual Lighting Controller Replacement

As part of Routine Maintenance of the Lighting System, the Electrical Maintenance Contractor shall upgrade service including the service conductors and conduit, remove and replace Lighting Controller, modify foundation as required, and replace bumper post if missing or damaged at eight (8) lighting locations annually. It is intended that the Contractor complete the work within the calendar year. In addition to the eight (8) locations to be modified annually under Routine Maintenance, the Engineer may designate additional locations to be modified. The work at additional locations will be paid under Non-Routine Maintenance.

The locations to be modified in the first year of contract are L0825 I 90 @ Cumberland Ave., PC:E, L0890 I 90 @ Van Buren St., PC:Z, L0945 I 90/94 @ 27th St., PC:X, L0950 I 90/94 @ Normal Ave., PC:Y, L0955 I 90/94 @ Wallace St., PC:Z, L0960 I 90/94 @ 21st St., PC:A, L0965 I 90/94 @ 17th St., PC:B, and L0970 I 90/94 @ Maxwell St., PC:C. If the contract is renewed for a second year, then location to be modified are L0975 I 90/94 @ Polk St., PC:D, L0150 I 55 @ Central Ave., PC:X, L0177 I 55 @ IL 171 PC:Z, L0435 I 57 @ IN. Harbor Belt RR, PC:H, L0440 I 57 @ Spaulding Ave., PC:I, L0445 I @ 147th St., PC:J, and L0450 I 57 @ Kedzie Ave., PC:K, L0150 I-55 @ Central Ave., North PC:X.

If one of these control cabinets is replaced for any cause whatsoever, then it is the Engineers option to designate an alternate location to keep the same number of locations per contract year.

The Contractor is responsible for scheduling the work and for coordinating with the Engineer whenever Engineer-witness functions are required. The Contractor shall also advise the Engineer when each location is complete and shall provide a written certification to that effect. The Engineer reserves the right to require a final inspection of the changeover at any or all of the locations certified as complete. Should deficiencies be found upon inspection, a corrective work list will be prepared. If progress of the work is inadequate, or if errors in certified complete work are repeatedly found, the Engineer may initiate withholding of Routine Maintenance payment. The Contractor shall provide a progress report in the monthly routine maintenance submittal book.

The Contractor shall be responsible for all traffic control and temporary provisions required for the work, all at no additional cost to the contract. All materials and work shall be in conformance with the requirements of applicable contract specifications and Article 250 of the National Electrical Code.

The Contractor shall be responsible for coordination with the Electric Utility as necessary and shall be responsible for any modifications arising from the work. Although it is anticipated that all service shall be restored on the same day and if for any reasons it is not completed on the same day, then the contractor shall provide generator power or make temporary service connections as necessary to assure continuity of operations as modifications are made at no additional cost to the contract.

The work will generally include:

- New conduit and cable from the service disconnect to the controller cabinet
- Removal and replacement of side walk or driveway, if required
- Restoration of ground with seed or sod
- New grounding of the service except the existing grounding is adequate witnessed by the Engineer
- Removing of the old cabinet and transferring into State Stock.
- Replacing with new SCADA type cabinet with the same radio code
- Co-ordinate the RTU terminal and FIU configuration GUI modification
- Testing and documentation

Replace Electric Service Conductors

The work shall include the removal of the existing service conductors and shall include the furnishing and installing a new service conductors, based on the manner of the existing service

Provide New System Ground of Electric Service

The work shall include the installation of a new system ground, using one or more ground rod grounding electrodes, or other means approved by the Engineer. The system ground shall have a resistance to earth not to exceed 10 ohms. The system ground resistance shall be verified by a contractor test, using the fall-of potential method and witnessed and approved by the Engineer, with a record of the test entered by the Contractor and signed by the Contractor and the Engineer. Ground resistance readings shall be submitted on progress reports. Should more than one electrode be required to establish a low enough resistance, additional electrodes shall be connected to the grid, with re-testing. All ground electrode connections shall

be exothermically welded. Ground rods and grounding electrode conductors shall be as specified and detailed.

Lighting Cabinet:

This item shall consist of furnishing a roadway lighting controller, duplex console type with radio control and associated wiring for control of highway lighting controller, as specified herein.

Materials.

Materials shall be according to Article 1068 of the Standard Specification for Road and Bridge Construction, current version, except as follows: First three paragraphs of Article 1068.01 (c) (2) to be eliminated.

Surface Preparation: The cabinet, doors and all other parts to be painted will be submerged in each tank of a 3-step iron phosphate conversion technique. After phosphatizing the parts shall be passed through an oven and baked to eliminate any moisture.

Finish coat: Shall be polyester powder paint applied electrostatically to a minimum thickness of 2 mils and baked at 375 degrees for 20 minutes.

Revise the first sentence of Article 1068.01 (e) (4) of the Standard Specifications to read:

“Contactors shall be electrically operated, mechanically held as specified, with the number of poles required for the service and with operating coil voltage as indicated.”

Add the following to Article 825 of the Standard Specifications:

Radio Control Equipment

Receiver - Decoder: The radio control module consists of a radio receiver, digital decoder, and an output interface which allows centralized remote radio control of the lighting controller turn-on and turn-off functions. The radio control module must be capable of operation consistent with the existing radio control system, a Motorola SCADA Central Station.

The existing control system currently operates over 250 discrete lighting controllers via a securely coded proprietary data scheme. For this reason, the control module must consist of a Motorola ACE 3600 Modular Remote Unit, model F 7563, (small housing), with no less than the following options:

Motorola Designation	Description
F 7563 (VHF), F 7564 (UHF)	ACE 3600 CPU **
V 245	Mixed I/O
V 261	240 VAC Power Supply w/charger
Z 857AA	Surge Protection

** Includes (1) three slot frame, (1) ACE 3600 CPU plus firmware, (1) mixed I/O Module, (1) VHF or UHF* CDM 750 Radio with FSK Radio Interface, port 3 (1) AC Power Supply with Charger, (1) 6.5 Ah battery, installed in a 15“ X 15” X 8.26” NEMA 4X/IP 56 painted metal enclosure with instruction manual.

* As directed by the Engineer

The manufacturer's designation by no means relieves the Contractor of providing a fully functional radio system as described herein.

The Radio Control Module shall be programmed for the following operational parameters:

- Transceiver Frequency: To be specified by the Engineer
- Receive Frequency: To be specified by the Engineer
- Communications Failure Preset: Normally Open
- Individual Station address: To be specified by the Engineer

Antenna:

The antenna shall be thick mount up to ½” mounting surface mounted by screw adapter (no magnet mounts). The low profile antenna mount shall be equivalent to Antenex – MABT8XNSI antenna Mount Low Profile. Accompanying antenna shall be equivalent to Antenex – B132 (Broad Band – VHF/UHF ¼ wave 150-928 MHz. Accompanying cable shall be equivalent to Antenex-RG8X and conductor equivalent to Antenex – CN8X from Radio to Antenna and shall be of appropriate length and not longer than 8 ft.

Installation:

I/O Module:

All motherboard cards shall be configured and installed as per manufacturer’s specifications and IDOT specification Ltg SCADA 397. Modules include but are not limited to; CPU, Mixed I/O. All digital inputs terminated on the Mixed I/O card shall be dry. Termination points for all digital input points will be reflected on power center wiring diagram or additional wiring schematic provided by the engineer. All digital outputs received from the Mixed I/O card shall be rated at 24 VAC 2A. All digital outputs shall be connected to interposing relays prior to being integrated into the power center wiring logic. The digital outputs shall maintain a momentary closure for approximately 2 seconds.

All wiring termination points shall be tagged using the nomenclature given on the wiring diagram. The alarms acknowledge button shall be implemented with a placard stating “Alarm Acknowledge”. Site configuration, map implementation, screens tagging and other related software configurations shall be specified elsewhere herein.

The antenna shall be centered on the top of the control cabinet. The antenna cable shall be dressed and trimmed for minimal length, allowing sufficient slack of removal of the radio connection for replacement or testing without disruption to the installation. The antenna connector shall be properly soldered to the cable assembly. Great care shall be exercised in the assembly of the antenna connector, excessive heat will destroy the inner insulation, and insufficient heat will produce a cold solder connection on the outer shield.

Intra-module wiring shall be 18 AWG stranded wire, color coded (American) consistent with battery polarity, and signal. The wire connection from terminal block (TB2) to the interpose relays shall be 14AWG stranded. All wires connected to the radio modules shall be dressed and tinned prior to insertion, (crimp on connectors will not be allowed for use in the radio system). Cost of all wire is inclusive within the scope of this work.

A terminal strip separate from the integral radio module and power supply shall be provided to interface power and signal conductors to the lighting controller. Terminals and wiring shall be labeled in accordance with the drawings, and dressed to allow service. The radio module shall be provided with constant 240 VAC power. The control power breaker shall provide power for the SCADA system. This is to allow the system to be energized at all times.

The SCADA system shall be tested in conjunction with the controller inspection, prior to field installation. The turn-on and turn-off function shall be tested ten (10) consecutive times utilizing actual signals originating from District 1 Headquarters. Any failures must be cleared before the controller is delivered to the job site.

Null covers shall be provided for the slots not used. All analog inputs shall be 4-20 mA. All I-O wiring including analog and digital shall be wired as per the enclosed table.

SCADA System Control Relay Assembly:

The Contractor shall mount and wire four (4) relays in a box as shown in the wiring diagram. Two relays shall be 240 volts sealed type and two relays shall be 24 volts sealed type, unless otherwise indicated, shall have contacts rated at not less than 20 amperes at 240 volts. The power relay for activating the lighting contactors shall have contacts rated to handle the contactor inrush. The relays shall be wired to a marked terminal strip.

Testing:

As part of final acceptance testing, all individual I/O points and internal status alarms shall be tested for proper operation and transmission. The transmission shall be confirmed at IDOT District 1 HQ. and the contractors dispatch facility. This full SCADA system start-up shall be completed with the Engineer present.

The SCADA radio system shall have the following items tested: VSWR, cable impedance, RSSI to the power center and confirmation that data sent from power center is received by the IDOT lighting system computers.

Analog Inputs And Transducers:

The panel shall include one voltage transducer for monitoring the line voltage and one current transducer for monitoring the neutral current. Their outputs shall be 4-20 mA DC each and shall be wired to channels 1 and 2 of the Mixed I/O module as shown. The voltage transducer shall be Scientific Columbus Model # VT110 – PAN7 – A4-2 for 480/240 volt single phase systems. The current transducers shall be Mel Kirchler Technologies Model # AT2-420-24L-FT, with power supply, PS-240-24P-1A. Both analog inputs shall be wired using shielded cable. Both transducers shall also be calibrated so that the SCADA system reads the correct value.

Testing Of The Assembled Cabinet:

Prior to shipment of the completed control cabinet, the control cabinet shall be tested for load, short circuits and complete operation of the cabinet as specified herein and as shown on the plans. The test shall be made at the manufacturer’s shop, by the manufacturer and shall be witnessed by the Engineer. The Contractor shall arrange the test date with the Engineer and so allow not less than seven (7) days advance notice. The cabinet shall not be delivered to the job site until inspected, tested and approved for delivery by the Engineer.

Construction Requirements

General.

The lighting controller shall be delivered to the storage facility located within District 1. Wood blocking or other supports and appurtenant items required for proper storage shall be included in this item.

Staging:

Manufacturer recommendation is for all Central Configuration programming be completed prior to the initial check out/PM of the SCADA unit in the field. This is to assure/confirm 2 way radio communications from the field RTU the Central. Lighting controller information submitted for approval shall include any recommendations of the Manufacturer for storage as provided under this contract.

The packaging of the lighting controller shall incorporate the provisions recommended by the Manufacturer to accommodate storage.

TERM	MOSCAD DESTINATION	WIRE #	DESCRIPTION OF INPUT
32	Analog Input 1 (+)	TB2 B11	CABINET NEUTRAL CURRENT
33	Analog Input 1 (-)	TB2 B1	CABINET NEUTRAL CURRENT
34	Analog Input 2 (+)	TB2 A2	CABINET SERVICE VOLTAGE
35	Analog Input 2 (-)	TB2 B2	CABINET SERVICE VOLTAGE
40	P. Ground	TB2 A3	GROUND
1	Digital Input 1	TB2 B3	ALARM ACKNOWLEDGE
2	Digital Input 2	TB2 A4	DOOR OPEN
3	Digital input 3	TB2 A5	MAIN(S) BREAKER OPEN
4	Digital input 4	TB2 A7	CONTACTOR 1 OPEN

5	Digital Input 5	TB2 A8	CONTACTOR 2 OPEN
6	Digital input 6	TB2 A9	CABINET IN NON-AUTO
7	Digital input 7	TB2 A10	BACK-UP CLOCK OFF CALL
8	Digital Input 8	TB2 A11	BACK-UP CLOCK ON CALL
18	DI Common	*	COMMON
20	K1 NO	TB2 A12	LIGHTS ON CALL
21	K1 Com	TB2 B17	K1 COMMON
23	K2 NO	TB2 A13	LIGHTS OFF CALL
24	K2 Com	TB2 B17	K2 COMMON
17	24 V+	TB2 B13	24+ VDC

All analog inputs will be 4-20 mA only. Digital output relays will be electrically energized and momentarily held.

Mixed I/O module model number V 245

Lighting SCADA RTU terminal Configuration

Description:

This work shall consist of having the SCADA system manufacturer design, implement and test a new RTU on the Lighting SCADA System on all system terminals.

Materials:

All software work shall be completed by the manufacturer or approved factory licensed sales and service company for the SCADA equipment. All licensing shall be provided by the entity completing the work. Licenses are to be held by IDOT.

Work:

SCADA RTU CONFIGURATION AND PROGRAMMING:

1. Setup of CPU and accompanying modules.
2. Setup of RTU site number, octal address, group call and All Call.
3. Configure application alarm parameters (download config./application).
4. Development and implementation of control and alarm application from IDOT submitted telemetry requirements.

NOTE: IDOT shall supply checklist listing I/O, telemetry, all call, group call and individual call data.

SCADA SERVICE/CLIENT WONDERWARE PROGRAMMING:

1. Add RTU to Wonderware.
2. Configure Wonderware to poll SCADA CPU for data on that specific RTU.
3. Setup servers and clients for alarm notification and database I/O, for that specific RTU.
4. Configure RTU polling.
5. Activate RTU on FIU polling.

SCADA FIU CPU PROGRAMMING:

1. If RTU exists as an Intrac site, it will have to be setup as a MOSCAD site (MOSCAD CPU). If RTU is a new site, it will have to be configured as a MOSCAD site (MOSCAD CPU).

Submittals:

The Motorola VAR shall submit ladder programming, quiescent telemetry and SCADA configuration files for approval by the IDOT Engineer. Submittal will be reviewed by the Engineer and returned noting changes and/or comments.

Testing and Documentation

As part of final acceptance testing, all individual I/O points and internal status (COS) alarms shall be tested for proper operation and transmission. The transmission shall be confirmed at IDOT Dist. HQ. And the contractors dispatch facility. This full SCADA system start-up shall be completed with the Engineer present.

The control cabinet shall be tested for complete operation and the electrical load on each circuit shall be measured and documented on the Log form L-3. The ground resistance test shall be performed by the Contractor using the fall-of-potential method, with results recorded by the Contractor and witnessed by the Engineer. Ground continuity shall be tested using an approved low-impedance ohmmeter, to the farthest point of each circuit extension from the controller cabinet. Results shall be recorded by the Contractor and witnessed by the Engineer.

Acceptance Transition:

After the appropriate testing has been completed and approved by the Engineer, the new SCADA equipment shall be monitored for up to 2 weeks for proper operation. If any problems are to arise, all configuration changes shall be completed at no extra cost.

7.11 Non-Routine Maintenance

The Contractor shall be advised that several routinely maintained items such as, but not limited to, tower painting, group wash and relamp, navigation relamping, cabinet modifications, the breakaway coupling replacement program, direct burial of cable, and several inspections are paid through non-routine pay items. Review Section 2 Special Provisions.

7.12 Logs and Forms

A sample of logs and forms as required for this Contract will be available at the Pre-Bid Meeting.

Article 8.0 -- Pump Station System

8.1 Pump Station System Description

There are 48 State-owned pumping stations in District 1, used for pumping water collected from expressways and viaducts into sewers and area waterways. It is essential that these pump stations shall be available and ready to operate at their designed capacity at all times to keep the traffic moving and to ensure motorist safety. The type of equipment used varies from station to station. The equipment at the stations include several types of: electric motor driven pumps; multiple sources of utility power; emergency generators; electrical switchgear; motor control centers; transformers; transfer switches; control systems; electrical and flow instrumentation; alarm systems; gas detection systems; lighting systems; power wiring; SCADA RTUs; central, satellite and remote engineering processors of the PS SCADA system; SCADA repeater; radio transceivers, including antenna cables, antennas and antenna towers/poles; fuel and fuel tanks; purged air water level indicating systems; compressed air systems; lubrication systems; automatic trash racks and bar screens; water systems; heating and ventilation systems; steel fencing and gates, wrought iron fencing and gates, windows, doors, locks, highway advisory radio in certain stations, and all associated equipment and appurtenances owned by the State of Illinois and under the jurisdiction of the Department.

8.2 General Maintenance Responsibilities

All items as listed in the System Description herein shall be maintained under routine maintenance. Equipment found during any inspection (routine and non-routine) which needs repair or replacement is covered under routine maintenance, unless otherwise stated herein. Unless specifically noted, all work required herein this Article shall be paid through routine maintenance. Also refer to response and maintenance requirements as listed in Article 5.0.

At the beginning of the Contract, the Contractor shall, under routine maintenance:

- Organize log books in each pump station as described herein,

- Replace approximately 200 locks at pump stations, base stations (Article 11.0) and communication towers (Article 7.0)

8.3 Site Maintenance

The Contractor shall provide general site maintenance at pump stations, including, grass cutting, weed control, debris disposal, snow plowing and removal operations as required to provide safe access to facilities, and to maintain the sites in an aesthetically acceptable condition to the public.

Grass cutting, weed control, and debris disposal work shall be performed in the station areas, in the IDOT R.O.W., to a radius of fifty (50) feet surrounding the building, and within five (5) feet of the access driveway. This maintenance shall be performed a minimum of once per month in the months, April through September.

Snow removal operations shall be conducted as necessary to provide safe and reasonable access to each facility. All pump stations, that require access for patrol, construction or other scheduled EMC work, shall be attended to immediately following a snowfall of more than three (3) inches. The Contractor shall notify the Engineer of his snow removal plan after each significant snowfall.

The Contractor shall submit a spreadsheet, noting the station and date above-mentioned work was completed, in the monthly routine maintenance book.

For snowfalls of less than 3 inches:

The Contractor shall provide reasonable access to each pump station via sidewalk, staircase, walkway, driveway, and parking areas by shoveling and salting within 48 hours.

For snowfall of more than 3 inches:

The Contractor shall provide snow plowing and salting of each station sidewalk, staircases, walkway, driveway, and parking areas, to commence within 24 hours, and shall be complete within 72 hours in the following order of priority:

- Group #1: PS # 4, 7, 17, 28, 32, 37, 38, 40, 42 and 44.
- Group #2: PS # 2, 3, 5, 9, 15, 20, 24-26, 30, 34, 46-48, 50 and 51.
- Group #3: PS # 10 - 14, 16, 18, 19, 21-23, 27, 29, 33, 35, 36, 39, 41 and 43

8.4 Response Maintenance for PS System

8.4.1 Contractor PS Call-Out Response

Pump Stations shall remain in continuous operation during normal and emergency maintenance activities. It is imperative that the Contractor immediately address alarms, reports of water on pavement, reports of clogged inlets, hazmat spills, or other serious malfunctions or damage by dispatching trained personnel to check the pump station.

Although the availability/location of trained personnel dictates the call-out, during normal workday hours, the order of call-out response shall be:

1. SCADA Specialist
2. PS Specialist
3. PS Crew
4. Other Contractor Personnel Trained in PS Operations

The Contractor shall develop an appropriate emergency PS Call-Out plan to provide trained personnel on-call after normal workday hours for pump station emergencies. This PS Call-Out shall be sent to the Engineer on a weekly basis, with the EMC Dispatch Center Emergency Call-Out Plan. (Refer to Article 5.0).

OSHA safety regulations must be followed at all pump stations. Any Contractor personnel entering a pump station shall be properly trained and equipped for confined space entry.

The Pump Station Manager shall be notified of any reports of possible hazardous materials in the pump station wet pits, and he shall be responsible to immediately contract the services of an approved full service materials waste contractor to remove the hazardous material and dispose of properly off of state property. (Refer to Article 4.0)

8.4.2 Station Procedures and Response Documentation

EMC personnel shall not manually operate the pumps with insufficient wet pit water elevation, for general maintenance operations, including pump inspection, wet pit cleaning, and all other wet pit work. Contractor shall use his own pump equipment to de-water the wet pit.

Two log books are maintained in each pumping station to document entry/inspection. The Contractor shall maintain the log books so that one book contains the current year information and the second log book contains information recorded in the previous years. In January of each year, the Contractor shall transfer the sheets from the current year log book to the previous year log book and place blank sheets in the current year log book. The Contractor shall furnish a new log book for newly rehabbed pump stations. The log book shall not be altered or removed from the station.

There are specific procedures, which are required of all personnel when entering or leaving any pump station. It is necessary to:

- Notify the EMC Dispatch Center of arrival (10-7)
- Complete log book chart I, with the date, time, persons name and reason for entry
- Upon completion of inspection, record the observations in the required charts in the log book.
- Notify the EMC Dispatch Center to issue a Ticket for any deficiencies, observed during the inspection. (Refer to Article 5.0 for Ticket requirements and procedures.) Record the ticket number and the deficiency in the logbook.
- Acknowledge any alarms before departure
- Check all pumps that are not tagged "Out of Service" and set in the auto position (H-O-A switch) immediately before departing the pump station
- Secure all station doors and hatches
- Notify the EMC Dispatch Center of departure (10-8)

8.4.3 PS Alarm Response

Upon receipt of an AEGIS and/or SCADA Pump Station alarm, the EMC Dispatch Center shall:

1. Create a ticket.
2. For all alarms, except entry alarms, dispatch a patrolman to the station, to check the alarm. Arrival shall be within one hour of the receipt of the alarm. For entry alarms (Zone 1), notify the IDOT ComCenter and the respective police department for the station, for a police escort for the patrolman. He shall not enter the premises without having the pump station investigated by the police. (Refer to Article 5.0 for information on procedures for incidents of intrusion, vandalism or theft).

Upon arrival at the station, the patrolman shall:

1. Notify the EMC Dispatch Center of the arrival information, including a notation of all alarms flashing on the annunciator and SCADA panel.
2. Record all information on the incident in the log book
3. Perform all necessary repairs required to restore the pump station to its normal operating condition, if possible. (If follow-up repairs are needed in an emergency situation, notify the PS Manager immediately.)

4. Notify the EMC Dispatch Center, as to status of problem, whether it was cleared or if follow-up work by the SCADA Specialist or PS Crew is necessary, before departing the pump station. (All response information shall be recorded on the ticket)
5. In the event of a power failure alarm (Zone 3), monitor the power outage status at regular intervals and notify the Pump Station System Manager and the IDOT ComCenter if a high water level is imminent. (Temporary Pumping Requirements as stated herein shall be applied.)

8.4.4 Station Pre-Storm Condition Check

Upon receiving a storm warning, code Red or Black, from the IDOT ComCenter or IDOT Engineer, the Contractor shall dispatch sufficient trained personnel to initiate these actions within one hour:

1. Check the operating status of each pump station
2. Check the condition of the trash on bar screen(s), clean if necessary
3. Check the status of the low point inlet and catch basins for the pump station, if found clogged notify IDOT Com Center immediately.
4. Submit a checklist (spreadsheet), indicating the time each pump station was checked, to the PS Engineer when completed.

8.4.5 Water on Pavement Situations

The responding patrolman shall be equipped with the necessary measuring devices to trouble shoot and mark the water level with a reference point.

Upon observing Water on the Pavement (WOP) or extremely high water levels at the station, the Patrolman shall immediately notify the EMC Dispatch Center, who shall in turn notify the IDOT ComCenter.

Immediately after entering the station, the dispatched patrolman shall report the following information:

1. Pumps Running -- Yes or No.
2. Water Depth in Wet Well
3. Depth of Water on Pavement
4. Street Inlet Clogged -- Yes or No

The patrolman shall obtain a ticket number from the EMC Dispatch Center and complete the station log book, Chart W. All ticket information and WOP report information shall be relayed to the EMC Dispatch Center within one (1) hour of receipt of information from the field. All WOP report tickets shall be marked for follow-up until the pump station system is back to normal operation and there is no water on the pavement. All incidents shall be reported to the Engineer via a W.O.P. report and ticket summary report by 8 a.m. the next day (within 24 hours on Holidays).

The Contractor shall retrieve the archived data from the pump station PLC and email to IDOT Engineer. When there is water on the pavement, the Contractor shall submit the archived data on a CD to the IDOT Engineer within 24 hours.

During high water level or WOP conditions, the patrolman shall remain at the station unless approved otherwise by the PS System Manager.

8.4.6 Station Post Storm Condition Check

After each major rainstorm, the pump station crew shall:

- Clean the trash rack bin, bar screen, and the area between the automatic trash rack/bar screen and the inlet sewer to the bare concrete floor.
- Check WOP float and probe sensor for proper operation, and remove debris, and
- Check the inlet/catch basins. If clogged, notify IDOT ComCenter.

8.4.7 Temporary Pumping Requirements

The Contractor shall provide and install temporary portable standby pumps to maintain adequate total station outflow capacity as described in Table P-1.

The Contractor shall submit a detailed temporary pumping operating plan, to the Engineer for approval, at the Pre-Construction meeting, for all maintenance activities which will directly affect normal inflow and outflow pumping operations. The Temporary Operating Plan submittal shall include a list of suppliers that, on an immediate on-call basis, can provide the Contractor with temporary pumps, or generators, to maintain the outflow capacity.

A back-up generator(s) shall be immediately mobilized to each pump station when the Contractor is notified of a high water level or alarm, or water on the pavement due to a power failure. Upon approval of the Engineer, the Contractor may utilize the two 200KW generators which are normally kept in state stock. These generators may not be considered in the Contractor's temporary pumping operations plan.

8.5 Service Companies

8.5.1 Submittals of Service Company Names

The Contractor shall submit the following, for Engineer approval, at the Pre-Construction meeting:

- Names, addresses qualifications of at least six potential vertical/submersible services repair companies within the tri-state area of Illinois/Indiana/Wisconsin.
- Name(s) of lab facilities that are certified and equipped to test oil and other lubricant fluids.

8.5.2 Service Company Work

When the Contractor is unable to complete repairs to pump station equipment, the Contractor shall provide an IDOT approved Service Company to supplement his forces in order to meet contract requirements.

The Contractor shall provide all labor, equipment, and general services necessary to schedule and assist a specialty service company in conducting various comprehensive testing and inspections, including routine and non-routine work.

The Contractor shall coordinate the work with the service companies and provide qualified personnel to:

- Allow free and clear access to and from the pump station and all equipment
- Open and close all enclosures to provide access to the electrical equipment being inspected, replaced and/or repaired.
- Notify the power utility company to schedule all power outages required for the project.
- Perform all switching, de-energizing and re-energizing of electrical equipment
- Perform lock out tag out procedures
- Provide safe working conditions in accordance with OSHA requirements
- Assist in data collection when requested by the Engineer

8.6 Scheduled Daily Maintenance

8.6.1 Daily SCADA Maintenance

The Contractor shall be responsible for proper operation and maintenance of all SCADA System equipment described herein, and in the standard specifications for the SCADA System PS-SCADA-886. (Refer also to PS SCADA equipment/ComCenter monitoring in Article 11.0, Extra Systems.)

On a daily basis, the SCADA Specialist shall review the daily operations of the SCADA System. The SCADA System, including the Master, Slave and RTU equipment shall have its periodic maintenance activities/programs completed by the SCADA Specialist. This work would include, but is not limited to system back-ups, central algorithms, Windows OS debugging, Tescode and/or RSView Programming, Ligitronic 5 Firmware, modem configuration, database and archive array configuration and collating.

- Keep back-ups of all system software/firmware. Any changes to the system shall be submitted to the Engineer for approval, before execution. System changes shall be documented on tickets for documentation.
- Troubleshoot any problems related to network configuration of the system, troubleshoot any Windows OS and/or RSView processing errors, modem configuration, and telecommunication line testing (including network high-speed lines, dedicated leased lines and dial-up lines).
- Upload and download RTU software configuration and application files, archive array configuration data and review the status of the SCADA system and alarms. The SCADA Specialist shall complete all Tescode programming setpoint changes and remote configuration. A total RTU programming disk shall be stored and updated by the SCADA Specialist in each PS SCADA panel and stored in an appropriate sealed case.
- Shall perform updates to OS and GUI software when released by the manufacturer.
- Shall perform software revisions, program and screen modifications required to integrate additional PLC's or devices in the pump station system into the existing central (Schaumburg) and satellite (Contractor Dispatch Center) processors. Processor functionality and integrity shall be maintained with each added device. Any device furnished, installed, and terminated to pump station PLC or removed from monitoring, including but not limited to the gas detectors and fire alarm systems during the contract year shall be configured and interfaced with the station PLC and HMI unit screens. This work shall be included under routine maintenance of the pump stations system. IDOT engineer shall be notified prior to any changes and modifications to the SCADA system.

The Contractor shall add any pump station that will become under maintenance during contract year to the SCADA system in order to make a complete operational system and shall develop new screens at all processors. The screens shall be identical to existing pump station screens, such as the pump station information screen, control screen, main pump station screen and status screen with all devices in the pump station properly monitored.

The Contractor shall maintain all SCADA Hardware and software this will include but not limited to RSVIEW 32, ControlLogix5000, RSLinx, Winbench, Liq V as required and all communication media to connect to remote pump stations. Contractor shall also maintain all remote SCADA hardware and software at the pump stations this will include but not limited to ControlLogix PLC, HMI unit, Liq. V PLC. The contractor shall provide a yearly technical support as required for all pump station SCADA system software..

8.6.2 Daily AEGIS Maintenance

The Contractor shall be responsible for proper operation and maintenance of all AEGIS System equipment. The Contractor shall maintain:

- One AEGIS Silent Knight 9500 pump station alarm receiver,
- One AEGIS Silent Knight 9000 backup unit receiver,
- One printer at the IDOT Electrical Field Office (EFO),
- One AEGIS receiver in the Contractor's EMC Dispatch Center, and
- All existing alarm transmitter units at each pump station including any new units added during the contract year and all associated equipment.

The Engineer shall provide the EMC Dispatch Center with an AEGIS Alarm Zone code list.

The Contractor shall assure that all AEGIS units are functioning for call out to the receivers and shall supply and program prom chips as required for each alarm transmitter unit. A 20-second time delay shall be programmed to prevent nuisance alarms due to contact bouncing.

The AEGIS system shall be configured to execute a 24-hour communication check. This daily check shall be monitored and documented by dispatchers at the EMC Dispatch Center; tickets shall be created for any problems. The weekly report of the communication checks shall be submitted to the Engineer.

The Contractor shall maintain one alarm center in Bureau of Traffic' Electrical Field Office for windows monitoring software for single user module, 250 account version, and provide a "one year office hours" support. The Contractor shall maintain the software and configure to make a complete operational system at all times.

8.6.3 Documentation of Daily Scheduled Maintenance

All preventive maintenance reports and inspections shall be emailed to the IDOT Engineer and Contractor Pump Station System Manager directly from the pump station, when follow-up work is required. All maintenance reports shall be submitted on a CD in the monthly book.

The contractor shall conduct field survey to provide and maintain a Fiber Drawing of all pump station termination, connection and splice points for the SCADA system, which shall also show fiber color, number and assignment. The contractor shall provide and install Microsoft Office 2007 with Access and AutoCad LT 2009 on SCADA engineering processor.

8.7 Monthly PS Quick Check – All Stations

The Contractor shall perform a monthly PS quick check at all pump stations. The patrolman shall notify the EMC Dispatch Center to create a Ticket for all deficiencies or malfunctions found.

During the inspection, check the following:

1. Are inlets clear of debris?
(If clogged on expressway stations, radio Com Center; for off expressway stations, create a ticket).
2. Is grass cutting required?
3. Is fence secure?
4. Is building roof free of leaks?
5. Are doors, windows, walls, and hatches secure and free of graffiti?
6. Dry pit condition OK?
7. Alarm panel OK? (No alarms holding)
8. Lighting fixtures outages?
9. MCC panel indicator lamps OK?
10. Water level meters at proper levels?
11. Ground detection indication lamps OK?
12. Is trash bin free of debris?
13. Does the bar screen need cleaning and free from debris build-up?
14. Is wet pit free of hazardous materials?
15. Pump On/Off operation OK? (Simulate a call)
16. Abnormal noise from pumps?
17. Is piping free of leaks?
18. Is pump free of abnormal noise or vibration?
19. Is oil level consumption OK?
20. Is grease operation OK?
21. Are grease and oil lines free of leaks?
22. Is thermostat set properly and heater operating properly?
23. Are dampers and exhaust system OK?
24. Verify gas detector calibration

25. Fire extinguisher OK?

8.8 Monthly Preventive Maintenance Program

The Contractor shall perform the following inspections and allow thirty (30) days between the inspections. A schedule/chart shall be submitted via CD that show the pump station, preventive maintenance programs (routine and non-routine) and date of completion for each program. Each preventive maintenance program shall have a monthly summary of item(s) require follow-up and associated ticket number. The schedule/chart(s) shall also include the status of all open tickets that require follow-up and shall be submitted at the end of each month. A copy of all routine and non-routine maintenance reports shall be submitted to IDOT Engineer via CD.

8.8.1 Monthly Pump Operation Inspection – All Stations

The Contractor shall perform the following and record on Chart A:

- Operate each pump and check alternator or selector switch for proper sequence in accordance with recommended manufacturer's procedures. Caution: Do not draw down the wet well level past the designated stop elevation under any circumstances.
- Set the selector switch on the pump with the least number of hours as the lead pump.
- Operate each unit noting the current draw and compare with the motor plate and note any deviation, and/or any abnormal operating sounds
- Record number of starts
- Take flow meter reading and record on log chart
- Record number of starts and hours run of each pump

The Contractor shall submit a copy of the chart A on a 3.5 inch disk using spreadsheet software, as approved by the Engineer, once every three months, in the monthly routine maintenance work documentation book.

8.8.2 Monthly Pump Maintenance

PS # 2, 3, 4, 7, 12, 14, 15, 19, 21, 24, 25, 26, 27, 29, 30, 32, 33, 35, 47, 50

The Contractor shall inspect the oil lube system and greaser for proper lubrication; and inspect both oil and grease lines for leakage or clogging. In addition, the Contractor shall inspect the automatic greaser and manual cap for proper operation, and maintain the proper oil/grease level. All information shall be entered on log chart F. The Contractor shall also grease all fittings such as flap valves, check valves, gate valves, flow meters, and pumps.

At PS # 14, 15, 32, 38, 47, 50, and 51 with the side volute discharge pumps, the Contractor shall lubricate the pump bearings with oil/grease when required, (minimum twice per year), inspect packing glands for leakage, lubricate motor, and clean the motor. In addition, the air release valves/pipes shall be inspected (replace when required) and cleaned.

8.8.3 Monthly Automatic Trash Rack Maintenance

PS # 4, 5, 21, 22, 23, 26, 28, 35, 46

At pump stations with automatic trash racks, the Contractor shall:

- Grease the rake assembly and head shaft bearings with EP#2 waterproof grease, grease drum bores on rope drum,
- Grease teeth on bull gear and pinion,
- Grease chains where applicable, and
- Check limit switches.

The Contractor shall use Bison #88 molybdenum grease or may substitute environmentally safe grease upon approval by the Engineer.

8.8.4 Monthly Bar Screen Maintenance

PS # 2, 3, 9, 10, 20, 24, 25, 27, 29, 30, 31, 32, 33, 36, 39, 40, 47, 50, 51 and 52

At pump stations with bar screens, the Contractor shall inspect the bar screen, rake and manually clean the bar screen and remove all debris in the area between the sewer and the trash rack/bar screen. The trash rack itself shall be kept free of debris.

8.8.5 Monthly Air Compressor Inspection

PS # 4, 24, 25, 27, 29, 33, 40, 50, 51

The Contractor shall check the compressor and air tank for proper operating pressure in the pump stations. The tanks are used for reserve air supply for the bubbler control systems.

Record the inspection results and the date tank was inspected on chart S in the log book.

8.8.6 Monthly Flow Meter Inspection

PS # 4, 5, 7, 9, 10, 17, 21, 23, 24, 25, 26, 27, 28, 29, 30, 33, 34, 35, 39, 42, 46, 50, 51

The Contractor shall check the flow meters in each station for proper operation and record their readings on chart A in the log book. A grease fitting is furnished in the head plate and requires greasing once a month, to replace grease that has worked out in the operations. The Contractor is advised not to over-grease the meter, and to lubricate with Lubriplate grease, available from Sparling, Inc.

8.8.7 Monthly Generator Inspection

PS # 9, 11, 15, 18, 19, 28, 34, 36, 39, 41, 42, 47, Two in State Stock

Engine driven pumps and back-up generators in state stock shall be inspected. The Contractor shall:

- Check control panel and transfer switch operation
- Check engine oil and coolant levels
- Check that block heater is working
- Check battery charging system
- Check for holes or leaks and loose connections in the air cleaner
- Check fuel level and fuel transfer pump operation
- Check for exhaust system leaks or restrictions
- Drain the condensation trap
- Check all meters, gauges, and indicator lamps
- Check generator fuel and note level.
- Check for fluid/fuel leaks.
- Check oil reservoir and battery acid level and maintain proper operating levels.
- Check the air filter monthly and change at specified intervals
- Exercise generator at full load for one (1) hour

The Generator check list, log P-10, shall be completed and submitted to the Engineer in the routine maintenance monthly submittal book (refer to Article 5).

Diesel fuel shall be filled to the proper level at all times, for the generator operation. If fuel level is less than one half of full level, then a ticket shall be created to schedule the refill of the tank.

8.8.8 Monthly Transfer Switch Operation Inspection

PS # 2, 3, 4, 5, 7, 9, 10, 11, 12, 13, 15, 16, 17, 18, 19, 20, 21, 22, 23, 24, 25, 26, 27, 28, 29, 30, 31, 32, 33, 34, 35, 36, 37, 39, 40, 42, 44, 46, 47, 50, 51 and 52

The Contractor shall exercise the transfer switch, on a monthly basis, to inspect for proper transfer and time delay to secondary power source and time delay from secondary to primary and shall be recorded in the chart. This work shall apply for pump stations shall be noted in chart C of the logbook.

8.8.9 Monthly Air Induction Inspection

PS# 4, 7, 8, 9, 10, 17, 20, 21, 22, 23, 24, 25, 26, 27, 28, 29, 30, 34, 35, 40, 50, 51 and 52

The Contractor shall change the air induction filter, clean the bird screens, and clean heating element insulators to maintain proper ventilation within the pump station. The date shall be noted on chart U in the log book. The Contractor shall supply and store the proper filters at each pump station.

8.8.10 Monthly AEGIS Monthly Inspection – All Stations

The Contractor shall check the AEGIS alarm system for each pump station which are not being monitored by the central SCADA system. This inspection will consist of transmitting of all the possible alarm codes for that specific station. Note that each station has an individual listing for zone 2 alarms. When checking the alarm system, each item that is incorporated into a zone 2 alarm shall be checked. The low and high level alarms shall be checked by a continuity test or by jumpering the relay. The Contractor shall not use the pumps to drawn down to a low level. All results shall be entered in chart E in the log book for each station.

8.8.11 Monthly State Stock Inventory Maintenance

The Contractor shall check the State stock as follows:

- Rotate motor/pump shaft, few revolutions by hand
- Fill oil reservoir to the proper level
- Check bearings for proper lubrication
- Clean motor windings with air, to remove any dust accumulation
- After cleaning, provide protective covering for motors to prevent dirt, moisture and other contaminates

A spreadsheet noting pump station name, inventory items, and work performed on inventory items in the prior month shall be submitted in the monthly routine book.

8.9 Semi-Yearly Preventive Maintenance Programs

To be completed by June and December of each year. A copy of all reports shall be submitted to IDOT Engineer via email.

8.9.1 Semi-Yearly Dry Pit/Wet Pit Submersible Pump Maintenance

PS # 2, 3, 5, 8, 9, 10, 11, 12, 13, 14, 15, 16, 17, 18, 19, 20, 21, 22, 23, 25, 27, 28, 29, 30, 31, 34, 36, 37, 38, 39, 40, 41, 42, 43, 44, 46, 48, 51, 52

The Contractor shall visually inspect pump impeller for clogging, shall inspect oil reservoir for contaminants, shall check and clean air release pipes/valves, and shall flush the cooling system from debris. The wet pit submersible pumps shall be washed down with a pressure hose.

8.9.2 Semi-Yearly Automatic Trash Rack Maintenance

PS # 4, 5, 21, 22, 23, 26, 28, 35, 46

The Contractor shall grease guides with Bison #88 molybdenum disulfide, and grease, lubricate, and perform an oil change on the worm reducer and coupling. The band brake assembly shall also be inspected and tightened evenly as required.

8.9.3 Semi-Yearly Vertical Pump Motor Maintenance
PS # 2, 3, 4, 7, 14, 24, 25, 26, 27, 29, 30, 33, 35

The Contractor shall check motor heaters and clean the motor inside and out, wiping off dirt, dust, oil and water from external surfaces of the motor. Any dust or debris from the ventilating air inlets shall be removed. The motors shall be cleaned internally by blowing with clean, dry compressed air.

8.9.4 Semi-Yearly Actuators, Valves & Sluice Gate Operation – All Stations

Minimum of eight (8) stations are due per month from January through June and July through November and the inspections for each station shall be spaced six months apart throughout the term of the contract.

The Contractor shall operate the flap valves, check valves, gate valves and sluice gates at all the pump stations. All the valves and gates shall be lubricated with environmentally safe grease.

The Contractor shall check the actuators' lubrication consistency and level. If required, it shall be filled or replaced. All electrical connections shall be inspected and tightened. The Contractor shall also check for mechanical damage.

All results shall be entered into chart B in the log book for each station. Create tickets for any deficiencies found and enter the ticket numbers on chart B. When repairs are complete, chart B shall be submitted in the monthly routine maintenance work book.

8.9.5 Semi-Yearly Side Volute Discharge Pump Maintenance
PS # 14, 15, 32, 47, and 50

The Contractor shall lubricate the pump bearings with oil/grease, inspect packing glands for leakage, lubricate motor, and clean the motor on the side volute discharge pumps. In addition, the air release valves/pipes shall be inspected (replace when required) and cleaned.

8.10 Yearly Preventive Maintenance Programs

8.10.1 Yearly Air Induction Heater And Space Heater Inspection
PS# 4, 5, 7, 8, 9, 10, 17, 20, 21, 22, 23, 24, 25, 26, 27, 28, 29, 30, 34, 35, 40, 41, 43, 44, 50, 51, 52

Before each heating season, the Contractor shall check the air induction heating elements and space heating elements, replace defective heating elements, if any, check and lubricate, if necessary, fan motors and damper mechanisms, check thermostat and settings and clean the finned heating element and fan inlets.

8.10.2 Yearly AEGIS Alarm System Inspection - All Stations
Inspections shall be completed during January of each year

During January of each year, the Contractor shall test the AEGIS alarm system by transmitting all the possible alarm codes for each station. Note that each station has an individual listing for zone 2 alarms. Each item that is incorporated into a zone 2 alarm shall be checked. The low level alarm shall be checked by continuity test or by jumpering the relay. All results shall be entered in the log book for each station, in chart E. A copy of each log P-1 shall be included in January routine maintenance work documentation book for each year.

8.10.3 Yearly SCADA Inspection
All Stations

Minimum of fifteen (15) stations are due monthly in January, February, and March, with the program to be completed during April of each year. Each station shall be inspected in the same month in the second year of the Contract.

The SCADA specialist shall physically inspect all of the equipment and wiring, and record on log P-100 the digital inputs/outputs, and analog inputs for the SCADA system. Create tickets for any deficiencies found on this inspection and enter the numbers on the inspection report, log P-100. When repairs are complete, the log P-100 reports shall be included in the monthly routine maintenance work documentation book.

The Contractor shall inspect the primary, and where applicable, the secondary water level monitoring systems in each station. The Engineer shall be present for each inspection. This work shall consist of physically measuring the water level in the wet pit and comparing that value with the primary and secondary reactive air system of the SCADA unit, the bubbler system implemented into the MCC, and the TLC water level monitoring system. The Contractor shall use the Meri-Cal air pressure calibration device with an associated hand pump, fittings, and valves required to calibrate the primary, secondary reactive air system and other bubbler systems. The Contractor shall use the calibration device any time calibration of the above equipment is required during the contract year.

This inspection shall also include the inspection of the trash rack and creek levels reactive air systems. Create tickets for any deviations over 1/2 foot and enter the numbers on the report log P-100. All work required on the SCADA system shall be coordinated with the Engineer and completed by the SCADA Specialist.

8.10.4 Yearly Wet Pit Inspection – All Stations

Minimum of six (6) stations due per month from April through October with the program to be completed during November of each year. Each station shall be inspected in the same month in the second year of the Contract.

The Contractor shall complete the wet pit inspection of all pump stations. The Contractor shall use his own portable pump to draw down the wet pit to a low level and maintain the existing inflow water in the wet pit. The Contractor shall:

- Inspect all grease lines to ascertain if any are broken or clogged
- Inspect the integrity of all equipment attached to the structure such as the air bell, air line and the floats
- Inspect the floats for operational efficiency, and clear them of any debris
- Inspect the probes for operational efficiency, and clear them of any debris
- Take a photograph (3.1 Mega Pixel digital camera & flash) of any bowl assemblies that show any wear on the impeller and/or if the suction is clogged with debris. The photos shall be appropriately labeled and placed in a sheet album with the station report, log P-9
- Inspect the silt accumulation
- Visually inspect the inlet sewer from inside of the pump station

Each report, including photo album, shall be included with the monthly routine maintenance work documentation book. Create tickets for any deviations found and enter the numbers on the report log P-9.

8.10.5 Yearly Pump Control System Inspection – All Stations

Minimum of fifteen (15) stations due per month from January through March with the program to be completed during April of each year. Each station shall be inspected in the same month in the second year of the Contract.

The Contractor shall inspect all pump control systems within all pump stations. The Engineer shall be present for each inspection. This work shall include inspection of a bubbler, electrode, and float systems, whichever secondary control system is utilized. The inspection shall consist of all starts, stops and alarm control elevations. Any control elevations which are different than the required elevations shall be noted and corrected.

Create tickets for any deficiencies found on this inspection and enter the numbers on the inspection report, log P-6. Each report shall be included with the monthly routine maintenance work documentation book.

8.10.6 Yearly Pump Station Inspection And Maintenance – All Stations

Minimum of four (4) stations due per month, January through November, with program to be completed during December of each year.

The Contractor shall conduct an annual comprehensive inspection of the electrical and mechanical equipment at each pump station using log P-4 and shall:

- dispose of any debris found on the grounds
- remove or paint over graffiti with comparable paint
- check the building roof drainage system
- for stations with flat roofs drain any large recessed areas of standing water.
- remove any debris build up in gutters, drains or down spouts
- night time infrared roof inspection is required
- repair roof leaks
- replace any glass blocks or broken windows
- patch or repair cracks found in concrete
- clean all cabinets, walls, motors and equipment by wiping with a damp cloth
- wash floors with a mop or a suitable floor cleaner
- lubricate exposed trolley drive pinion and wheel teeth

The Contractor shall provide an Infrared Camera by FLIR Systems Model ThermaCAM E4 or equivalent for IDOT equipment inspections as requested by the Engineer. The Infrared Camera shall be used with other preventive maintenance programs elsewhere here in this contract and as directed by the Engineer.

Create tickets for any deficiencies found on this inspection and enter the numbers on the inspection report, log P-4. A re-inspection will be scheduled by the Engineer following completion of any necessary repair work. When repairs are complete the P-4 reports shall be included in the monthly routine maintenance work documentation book. The stations shall be inspected in the same month in the second year of the Contract.

8.10.7 Yearly Pump Capacity, Motor Current, Voltage, Moisture, Megger Test - All Stations

Minimum of eight (8) stations due per month, January through May, with program to be completed by June of each year.

The Contractor shall conduct a pump capacity, motor running current, voltage measurement, megger, and Yeoman submersible pump moisture tests. The Contractor shall also utilize the services of the specialty services subcontractor for this test. The Contractor shall be responsible for providing or storing water for testing, not to exceed high level elevations.

The Contractor shall provide all necessary equipment, tools, material and labor to set up the pumping stations for capacity testing using either the recirculation method, wet pit draw down method or the discharge chamber method with discharge sewer and recirculation gates closed, as applicable for the station.

Prior to testing, record all necessary name plate information for pump and motor. Pump testing will require the presence of at least two personnel equipped with radio communications and measuring tape and block.

A draw down test shall be done in all the pump stations. Record flow meter reading and measure accumulated pumped water in the discharge chamber where sluice gates are present to store water in the

discharge chamber. The pumps shall be tested for at least for 1 minute duration. Record all readings, including full load current, flow reading and water level change.

The following data shall be recorded and submitted to the Engineer on log P-5:

- Water depth
- TDH
- Capacity
- Vibration
- Current
- Voltage
- Insulation resistance to ground
- Pressure

In addition, the Contractor shall megger all motor windings and feeder cables. Any reading below 1 Mohm will require the Contractor to determine the source or cause of the low reading and make prompt repairs as required. A copy of the log P-5 shall be kept in the log book. Create tickets for any deficiencies found on this inspection and enter the numbers on the inspection report, log P-5. A copy of the results of the capacity and megger test on log P-5 and on a CD shall be submitted to the Engineer with the monthly routine maintenance book. The stations shall be reinspected in the same month in the second year.

The Contractor shall retrieve all archived data from the pump station PLC upon completion of the pump capacity test and shall submit the archived data on a CD to the IDOT Engineer.

8.10.8 Yearly Impeller Adjustment Of Vertical Axial Flow Pumps

PS # 2, 3, 4, 7, 24, 25, 26, 27, 29, 33, 35

Minimum of five (5) stations due per month, during January and February. This adjustment shall be done only when pumps do not perform according to their design.

The vertical axial flow pumps shall be checked for proper impeller settings in accordance with manufacturer's specifications. This work shall include dropping the suction bell to inspect the wear ring and impeller for wear. The Contractor shall record "as found" measurements, record the adjustment setting on log P-5 and include it in the monthly routine maintenance work documentation book.

8.10.9 Yearly Submersible Pump Inspection

PS # 2, 3, 5, 8, 9, 10, 11, 12, 13, 14, 15, 16, 17, 18, 19, 20, 21, 22, 23, 25, 27, 28, 29, 30, 31, 34, 36, 37, 38, 39, 40, 41, 42, 43, 44, 46, 48, 51, 52

Minimum of five (5) stations due per month from July through October with the program to be completed during November of each year

The Contractor shall remove, inspect and service all submersible pumps, each contract year. Service work shall include the changing of oil, check and adjust clearance between impeller and wear ring. This work shall be done in accordance to manufacturers specifications and instructions. Create tickets for any deficiencies found on this inspection and enter the numbers on the inspection report, log P-8.

8.10.10 Yearly Oil Analysis - All Stations

Minimum of twelve (12) stations due per month, from July through October.

The Contractor shall obtain suitable test containers from an approved lab facility. Collect oil samples from the motor upper and lower bearing compartments, dry pit/wet pit submersible pumps and all generators. The oil shall be drawn from the equipment reservoir. The oil should drain for a few seconds before collecting the sample. A minimum of two (2) ounces of oil shall be used for analysis. Do not use the same container for different equipment or for different compartments of the same equipment.

Samples shall be taken after running the motor, pump or engine or within fifteen minutes after the equipment is turned off. This work shall be done along with the capacity and vibration test.

The Contractor shall provide the laboratory with the brand and type of oil, type of equipment from which the sample was taken, number of days since the last oil change, and any suspected abnormalities in the equipment. Each sample of oil shall be identified with the equipment and compartment from which the sample was taken. The Contractor shall ship the oil samples to the lab facility within one month of collection.

The lab facility shall conduct a wear particle analysis to determine:

- Wear metals
- Contaminants
- Additives elements
- Viscosity
- Solid percent volume
- Water percent volume
- Fuel where required
- Particle counting and direct reading ferrography

Create tickets for any deficiencies found from the lab testing and submit the lab reports to the Engineer on a CD with operating software that can utilize existing data for trending. A condition summary report shall be submitted on paper. Based upon the lab report, the Engineer may request additional analytical ferrography testing. The oil shall be changed if the lab results indicate that the oil is contaminated. All charges for lab work, shipping, and changing of oil etc., shall be covered under routine maintenance. A summary of the report shall be submitted via email at the end of the program.

8.10.11 Yearly Main Circuit Breaker Testing Inspection
PS # 25, 28 and 29 to be inspected during May of 2009
and
PS # 30, 33 and 35 to be inspected during May of 2010

The Contractor shall obtain an approved engineering services company for testing the main circuit breakers, branch circuit breakers and motor starters in three (3) pump stations each year. The IDOT Engineer shall be notified at least twenty-four hours in advance to witness the tests. The Contractor shall coordinate with the electrical utility to turn power off and on where required. The Contractor shall furnish the test set and operator along with all necessary fittings, cables and connectors to connect the test set to the circuit breakers. Prior to testing, a general clean up of the buses and cabinets are required.

Testing shall consist of visual and electrical tests as shown on log P-7. Overcurrent relays and dash pots shall be inspected where present, and are to be set as directed by the Engineer. The inspection and testing shall also include the trip unit, contact resistance and insulation tests. Create tickets for any deficiencies found on this inspection, and enter the numbers on the inspection report, log P-7. The reports shall be submitted via email at the end of the program.

8.10.12 Yearly Flow Meter Inspection
PS # 4, 5, 7, 9, 10, 17, 21-30, 33, 34, 35, 39, 46, 50, 51

Minimum of five (5) stations due per month from July through October with the remainder of the program to be completed during November of each year

The Contractor shall remove the meter heads out of the line and check the mechanism, note the condition of the pipe and straighten the vanes. The meter head shall be examined, cleaned, and parts replaced per manufacturer recommendations. Create tickets for any deficiencies found on this inspection.

The transmitter and receiver shall be tested and calibrated by a factory certified/approved representative.

8.10.13 Yearly Fire Alarm Systems Inspection

PS # 2, 3, 4P, 5, 7P, 8P, 9, 10, 11, 12, 13, 14, 15, 16, 10, 17, 18, 19, 20P, 21, 22, 23, 24, 25, 26, 27P, 29P, 30, 31, 32P, 33P, 35P, 36P, 37P, 38P, 39, 41, 42, 43, 44, 46, 50, and 52

Minimum of nine (9) stations due per month from July through October with the remainder of the program to be completed during November of each year. Pump station that have Fire alarm system installation in progress (P) will be completed in 2008.

The Contractor shall furnish a factory trained service representative and shall use factory authorized testing equipment for all testing procedures, to complete a comprehensive fire alarm system inspection and maintenance in accordance with NFPA 72 Chapter 7 and as recommended by the manufacturer.

All fire extinguishers in the fifty- (50) pump stations have been hydrostatically tested in 2002.

Upon completion of the inspections, a written report shall be submitted to the Engineer. This report shall identify all devices that were tested as well as any corrective measures that are recommended. Create tickets for any deficiencies found on this inspection and enter the numbers on the inspection report.

8.10.14 Yearly Motor Control Center Inspection – All Stations

Minimum of four (4) stations due per month, January through November, with program to be completed during December of each year

The Contractor shall perform the following inspection:

- A. Clean enclosure and control equipment by blowing out with low air pressure or vacuuming
- B. Check and clean contacts, relays and timers and visually inspect for damage or out of adjustment parts.
Remove all dust off of electrical devices and equipment.
- C. Check motor control center indicating lamps and all switches and push buttons
- D. Circuit breaker maintenance:
 - Check connections
 - Exercise breaker
 - Check trip setting
- E. Motor Starter Contact Maintenance:
 - Check contacts and burnish, if necessary
 - Check coil and clean
 - Inspect arc chute for cracks or burns
 - Check contact pressure and measure contact resistance on all 3 phases
- F. Oil Dash Pots:
 - Check oil levels
 - Inspect settings
- G. Inspect wiring/conductors for overheating and discoloration
- H. Check sizing of motor overload heaters
- I. Check tightness of wire terminations and connections
- J. Check for proper labeling, provide and install missing labels
- K. Check wire tags/labels, provide and install missing tags or labels
- L. Check fans for proper operation and clean filters
- M. Check fuse disconnects for proper operations, keep fuse clips clean and tight
- N. Check fuses for proper size, and overheating
- O. Test equipment ground system of the station.

Create tickets for any deficiencies found on this inspection and enter the numbers on the inspection report.

8.10.15 Tube Type Pump Maintenance – Year 2009 Only
PS #5, 22 and 23

The maintenance program shall be completed by September 2009

The Contractor personnel and/or service company shall:

- Remove the pumps, inspect and replace, if necessary, the upper mechanical seals. The condition of the mechanical seal is satisfactory if no fluid leakage (contaminant) or only light seepage out of the inner hole in the casing.
- Dismantle the pump partially, if fluid has leaked, which is evidence that the bearing has also been affected. Check the mechanical seals and replace if necessary.
- Replace the roller bearing grease, if water has penetrated into the bearing.
- Drain all the leakage fluid and the liquid seal, and refill with a sealing fluid as recommended by the manufacturer.

8.10.16 Yeoman Pump Maintenance - Year 2010 Only
PS # 21, 27, 29, 30, 42

In June 2010, at stations with Yeoman Pumps, the Contractor shall:

- Drain, flush and refill the seal chamber with new oil.
- Inspect oil for water intrusion in the motor seal chamber.
- Inspect the cable for any signs of abrasion or damage.
- Inspect the impeller and casing wear ring.
- Notify the Engineer in advance of this scheduled work.
- Create tickets for any problems found during the inspection.

8.10.17 Yearly Generator Maintenance
PS # 9, 11, 15, 18, 19, 25, 28, 34, 36, 39, 41, 42, 47, Two in State Stock

The Contractor shall perform inspection and maintenance required for the standby generators in October of each year as follows:

- Change oil and oil filters
- Drain, flush, and replace coolant
- Replace cooling system hoses
- Replace thermostats
- Replace fan belts
- Check and adjust valves as necessary
- Conduct operational inspection to insure proper valve rotation
- Check fan hub
- Check pulley
- Check water pump
- Change the day tank breather
- Clean or replace the crankcase breather
- Change fuel filter
- Drain sediment from the fuel tank
- Clean accumulation of grease, oil and dirt on set
- Lubricate generator bearing
- Check vibration isolators for proper adjustment and conditions
- Check circuit breaker and transfer switch, and test equipment by simulating a power outage

- Record inspection on log P-10 in the log book and submit a copy of the report with the monthly submittal book

**8.10.18 Yearly Equipment Identification Program
Pump Stations 8, 20, and 32 in Year 2009
And
Pump Stations 37, 38, and 48 in Year 2010**

The Contractor shall conduct a thorough inspection of three pump stations a year. The inspection shall include all termination points, wire labels, equipment labels, electrical equipment, pump and piping. All wiring shall be traced and properly labeled and identified in the pump station. The Contractor shall furnish and install all missing labels and provide four (4) copies of the following:

- Single line diagram – shall show type and size of electrical equipment, size of circuit protective conductor, protective device size and rating, contactors, bus bar size and detail power sources details
- Control Ladder Diagram for all circuits – shall show all relays, contacts, coils, transformers, fuses, timers and wiring terminations
- Point to point wiring terminations
- All electrical equipment physical and dimensional layouts – shall show locations, size type and conduit sizes
- All mechanical pump and piping equipment – shall show pump and piping layout and dimensions

The complete set of diagrams provided shall completely illustrate all wiring and equipment in the existing pump station. A soft copy of the diagram shall be submitted to IDOT via e-mail in a PDF format. The Contractor shall also submit four (4) copies of the final record drawings and a copy in AutoCad format for IDOT approval.

8.11 Pump Station Non-Routine Maintenance:

The Contractor shall be advised that several routinely maintained items such as, but not limited to, the gas detector inspection, automatic transfer system service, adjustment of existing controls, removal and replacement of gas sensors, intrusion override key switch, motor balancing, SCADA equipment, motor inspection, pump re-building type 1-6, SCADA radio equipment inspection, pump station SCADA radio inspection, switchgear system inspection, pump repair and pump replacement, vibration testing and analysis, cleaning of wet pit, and wet pit power wash. Review Section 2 Special Provisions and Programs.

8.12 Logs and Forms

A sample of logs and forms as required for this Contract will be available at the Pre-Bid Meeting.

8.13 Tables

Table P-1 Pump Station Locations

PS	PUMP STATION LOCATION			RR CROSSING	OUTLET	STATION	CAP	PS
NO	MUNICIPALITY	ROUTE NUMBER	NEAREST CROSS STREET	AT PUMP STATION	WATERWAY	GPM	CFS	NO
1		Reserved for future						1
2	NORTHFIELD	I 94 EDENS EXPY	WINNETKA RD	NONE	SKOKIE RIVER	54000	120	2
3	CHICAGO	I 94 EDENS EXPY	CALDWELL/PETERSON	NONE	N. BR CHICAGO RV	70000	156	3
4	FOREST PK	I 290 EISENHOWER EXPY	E. OF 1ST AVE	NONE	DES PLAINES RV	90000	201	4
5	CHICAGO	I 290 EISENHOWER EXPY	DES PLAINES AVE	NONE	CHICAGO RV	38000	85	5
6		Reserved for Future						6
7	CHICAGO	I 290 EISENHOWER EXPY	WELLS ST PLAZA	NONE	CHICAGO RV	6000	13	7
8	DES PLAINES	US 14 NORTHWEST HWY	1/2 MILE E. OF IL RT 45	Wisconsin Central	WELLER CREEK	3000	7	8
9	STONE PK	US 45 MANNHEIM RD	LAKE ST	NONE	ADDISON CREEK	24000	53	9
10	NILES	US 14 DEMPSTER ST	MILWAUKEE AVE	NONE	SEWER	1200	3	10
11	OAK FOREST	IL 50 CICERO AVE	158TH STREET	NIRC	MIDLOTHIAN CREEK	5400	12	11
12	MELROSE PK	IL 64 NORTH AVE	W. OF 25TH AVE	BRC	27"SS SILVER CREEK	11000	25	12
13	SKOKIE	US 41 SKOKIE BLVD	SO. OF OAKTON AVE	SKOKIE SWIFT	OAKTON SEWER	11000	25	13
14	RIVERDALE	WOOD / ASHLAND	139TH STREET	IHB & BRC	LITTLE CALUMET RV	11000	25	14
15	CHICAGO	79TH ST	KEDZIE AVE	NS	SEWER ON KEDZIE	5500	12	15
16	ROSEMONT	IL 72 HIGGINS RD	E. OF MANNHEIM RD	Wisconsin Central	WILLOW CREEK	5400	12	16
17	DES PLAINES	IL 58 GOLF RD	E. OF DES PLAINES RV RD	Union Pacific	DES PLAINES RV	3000	7	17
18	SO. HOLLAND	US 6 159TH ST	SOUTH PARK	U.P.	LITTLE CALUMET RV	5800	13	18
19	OAK FOREST	US 6 159TH ST	IL 50 (CICERO AVE)	NIRC	MIDLOTHIAN CREEK	7000	16	19
20	HILLSIDE	I 290 EISENHOWER EXPY	W. OF WOLF RD	NONE	SEWER	7900	13	20
21	CHICAGO	I 94 DAN RYAN EXPY	72ND ST	NONE	SEWER	32000	71	21
22	CHICAGO	I 90 / 94 KENNEDY EXPY	FULTON AVE	C & NW, SOO & CR	SEWER	60000	134	22
23	CHICAGO	I 90 / 94 KENNEDY EXPY	ROSCOE ST	NONE	SEWER	72000	160	23
24	ROSEMONT	I 190 KENNEDY EXPY	E. OF MANNHEIM RD	Wisconsin Central	DES PLS RV & WLRS CK	111000	247	24
25	BRIDGEVIEW	US 12 / 20 95TH ST	IL 43 (HARLEM AVE)	BRC	STONE CREEK	37200	83	25
26	CHICAGO	I 90 / 94 DAN RYAN EXPY	ROOSEVELT RD	NONE	SB CHICAGO RIVER	70000	156	26
27	CHICAGO	I 94 CALUMET EXPY	110TH ST	NONE	LAKE CALUMET	240000	535	27
28	CICERO	IL 50 CICERO AVE	US 34 (OGDEN AVE)	BURLINGTON N	SEWER	31800	71	28
29	CHICAGO	I 90 / 94 DAN RYAN EXPY	WALLACE ST	NONE	SO. BR CHICAGO RV	108000	241	29
30	CHICAGO	I 55 STEVENSON EXPY	HOMAN AVE	ATSP	SAN. SHIP CANAL	40000	89	30
31	OAKLAWN	111TH ST.	CENTRAL	B&OCT RR		7400	16.5	31
32	MELROSE PK	IL 64 NORTH AVE	1ST AVE	SOO LINE	DES PLAINES RV	9600	21	32
33	PROSPECT HTS	PALATINE RD	MILWAUKEE AVE	NONE	DES PLAINES RV	64000	143	33
34	ELMHURST	I 290 EISENHOWER EXPY	EMROY AVE	NONE	SEWER TO DOYLE RES.	11000	25	34
35	BLUE ISLAND	I 57	127TH ST	NONE	CAL SAG CHANNEL	112500	251	35
36	TINLEY PK	IL 43 HARLEM AVE	176TH STREET	NIRC	DITCH	22500	50	36
37	LAKE BLUFF	US 41 SKOKIE HWY	IL 176 (ROCKLAND RD)	NONE	SKOKIE RV	6000	13	37
38	LAKE FOREST	US 41 SKOKIE HWY	DEERPATH AVE	NONE	SKOKIE RV	5000	11	38
39	LAKE FOREST	IL 60	W. OF IL 41	SOO LINE	36" SS N.BR.CHLRV.	6000	13	39
40	MUNDELEIN	US 45 LAKE AVE	N. OF IL 60	EJ & E	SEWER	2400	5	40
41	KNOLLWOOD	US 41 SKOKIE HWY	N. OF IL 176	EJ & E	SKOKIE RV	6000	13	41
42	HAMPSHIRE	IL 47	IL 72	SOO LINE	SEWER TO DITCH	3000	7	42
43	GURNEE	US 41 SKOKIE HWY	N. OF IL 132	SOO LINE	DES PLAINES RV	6000	13	43
44	ELMHURST	IL 83 KINGERY HWY	SO. OF NORTH AVE	ICG & C & NW	SALT CREEK	5000	11	44
45		Reserved for Future						45
46	HIGHLAND PK	US 41 SKOKIE HWY	CLAVEY RD	NONE	E. SKOKIE DR NG. DITCH	7600	17	46
47	NAPERVILLE	IL 59	NORTH AURORA AVE	BURLINGTON N	SEWER TO DITCH	4000	9	47
48	WARRENVILLE	IL 56 BUTTERFIELD RD	W. OF IL 59	E J & E	FERRY CREEK	5800	13	48
49		Reserved for Future						49
50	HIGHLAND PK	IL 22 HALF DAY RD	US 41	Union Pacific	E. SKOKIE DRNG. DITCH	4800	11	50
51	ALSIP	127TH ST	E. OF CRAWFORD	CSX	STONY CREEK	6800	15	51
52	PLAINFIELD	IL 59	IL 126	E.J. & E. RR				52

Table P-2a: Pump Station Construction History & Reference Notes

PS NO	INSTALL/MOD DATE	NOTE REF. NO.	STATION TYPE	SECONDARY SERVICE	PUMP CONTROL			ALARM TYPES		CAP METER	PS NO
					PRIMARY	SEC(1)	TERTIARY	AEGIS	SCADA		
1											1
2	1951/72/95	3,5,8,9,23	WET PIT	2ES FAT	LIQ. V	FLOATS		AEGIS	SCADA		2
3	1951/72/95	3,5,8,9,23	WET PIT	2ES FAT	CL 5000	FLOATS		AEGIS	SCADA		3
4	1951/71	2,3,7,8,10,22	WET PIT	2ES SBAT	LIQ. V	BUBBLER	PROBES	AEGIS	SCADA	YES	4
5	1965/2005	2,7,8,10,22	WET PIT	2ES SBAT	CL 5000	BUBBLER	PROBES	AEGIS	SCADA	YES	5
6											6
7	1955	8,9	WET PIT	-2ES FAT	LIQ. V	FLOAT		AEGIS	SCADA		7
8	1928/87/88	22,25,13	WET PIT	-	FLOAT	PROBE		AEGIS			8
9	1977	1,3,7,11,23,24	DRY PIT	GEN(D)		FLOAT		AEGIS	SCADA	YES	9
10	1990	3,5,9,23	DRY PIT	2ES FAT	LIQ. V	FLOAT		AEGIS	SCADA	YES	10
11	1934	5,11,24,25	DRY PIT	GEN (D)	LIQ. V	FLOAT		AEGIS	SCADA		11
12	1934/72	9,20	DRY PIT	2ES FAT	LIQ. V	FLOAT		AEGIS	SCADA		12
13	1934	5,9,24,25	DRY PIT	2ES FAT	LIQ. V	FLOAT		AEGIS	SCADA		13
14	1934/72	20,22,25	DRY PIT	-	LIQ. V	FLOAT		AEGIS	SCADA		14
15	1940	11(P),24	DRY PIT	-	LIQ. V	FLOAT		AEGIS	SCADA		15
16	1934	5,9,20	DRY PIT	-2ES FAT(P)	LIQ. V	FLOAT		AEGIS	SCADA		16
17	1931/91	3,5,9,23,24	WET PIT	2ES FAT	LIQ. IV	FLOAT		AEGIS	SCADA	YES	17
18	1942	24,25	DRY PIT	-	LIQ. V	FLOAT		AEGIS	SCADA		18
19	1948	11(P),24,25	DRY PIT	-	LIQ. V	FLOAT		AEGIS	SCADA		19
20	1958/86	5,8,9,24	WET PIT	2ES FAT	LIQ. V	FLOAT		AEGIS	SCADA		20
21	1960	7,8,9,15,22,25	WET PIT	2ES FAT	LIQ. V	BUBBLER	PROBES	AEGIS	SCADA	YES	21
22	1970/96	2,3,5,8,12,23	WET PIT	2ES SBFAT	LIQ. V	FLOAT		AEGIS	SCADA	YES	22
23	1970/96	2,3,5,8,12,23	WET PIT	2ES SBFAT	LIQ. V	FLOAT		AEGIS	SCADA	YES	23
24	1960/70	3,7,8,19,22	WET PIT	2ES FAT	LIQ V	BBL/ELCT	PROBES	AEGIS	SCADA	YES	24
25	1962	3,7,9	WET PIT	2ES FAT	LIQ. V	BUBBLER	PROBES	AEGIS	SCADA	YES	25
26	1962/72	2,3,7,8,19,22	WET PIT	2ES SBFAT	LIQ. V	FLOATS		AEGIS	SCADA	YES	26
27	1961	3,7,8,9,19,22	WET PIT	2ES FAT	LIQ. V	BUBBLER	PROBES	AEGIS	SCADA	YES	27
28	1961	2,3,5,11,16,23	WET PIT	GEN(D)	LIQ. V	FLOATS		AEGIS	SCADA	YES	28
29	1962	7,8,10	WET PIT	2ES SBAT	LIQ. V	BUBBLER	PROBES	AEGIS	SCADA	YES	29
30	1963	3,5,8,9,16,22	WET PIT	2ES FAT	LIQ. V	FLOATS		AEGIS	SCADA		30
31	1999	3,5,16,28	WET PIT	2ES FAT	CL 5000	FLOATS		AEGIS	SCADA	YES	31
32	1963	9	DRY PIT	2ES FAT	CL 5000	FLOATS		AEGIS	SCADA		32
33	1975	3,9,33	WET PIT	2ES FAT	LIQ. V	BUBBLER	PROBES	AEGIS	SCADA	YES	33
34	1961/90	3,5,8,11,23,24	DRY PIT	GEN(D)	CL 5000	FLOAT		AEGIS	SCADA	YES	34
35	1967	2,3,8,9,12	WET PIT	2ES FAT	LIQ. V	FLOATS		AEGIS	SCADA	YES	35
36	1972	1,18,23	DRY PIT	GEN(D)	LIQ. V	FLOATS		AEGIS	SCADA		36
37	1937	9,22,24,25	DRY PIT	2ES FAT	LIQ. V	FLOAT		AEGIS	SCADA		37
38	1937	24	DRY PIT	-	LIQ. V	FLOAT		AEGIS	SCADA		38
39	1990	3,5,11,23,24	WET PIT	GEN(D)	CL 5000	FLOAT		AEGIS	SCADA	YES	39
40	1985	3,9,23	WET PIT	2ES FAT	LIQ. V	FLOAT	PROBES	AEGIS	SCADA	YES	40
41	1937	22,24,25	DRY PIT	-	CL 5000	FLOAT		AEGIS	SCADA		41
42	1935/86/87/95	5,11,12,23	WET PIT	GEN(D)	LIQ. V	FLOAT		AEGIS	SCADA	YES	42
43	1936	3,5,9,15,23	DRY PIT	-	FLOAT	-		AEGIS			43
44	1938/00	5,16,23,24	DRY PIT	2ES FAT	LIQ. V	FLOATS		AEGIS	SCADA	YES	44
45											45
46	1993	2,3,5,9,23	WET PIT	2ES FAT	CL 5000	FLOAT		AEGIS	SCADA	YES	46
47	1955/86	5,11	WET PIT	GEN(D)	LIQ. V	FLOAT		AEGIS	SCADA		47
48	1942	24,25	DRY PIT	-	LIQ. V	FLOAT		AEGIS	SCADA		48
49											49
50	1985	3,9,23	DRY PIT	2ES FAT	LIQ. V	BUBBLER	FLOAT	AEGIS	SCADA	YES	50
51	1984	3,9,23	DRY PIT	2ES FAT	LIQ. V	BUBBLER	FLOAT	AEGIS	SCADA	YES	51
52	2002	16,9	WET PIT	2ES FAT	LIQ V	FLOAT		AEGIS	SCADA		52

Table P-2b Continued
Pumping Station Construction History & Reference Notes

Note #	Description
1	
2	PUMPING STATION # 4(2), 5, 21, 22, 23, 26, 28, & 35(2)AND 46 HAVE AUTOMATIC TRASH RACKS
3	PUMPING STATIONS # 2, 3, 4, 5, 9, 10, 17, 21, 22, 23, 24, 25, 26, 27,28, 30, 31, 33, 34, 35, 39, 40, 41, 43, 44, 46, 50 & 51 HAVE WATER RECIRCULATING SYSTEMS
4	ALL PUMPING STATIONS HAVE AEGIS ALARM TRANSMITTERS
5	INSTALLATION OF NEW PUMPS, ELECTRICAL CONTROLS AND BLDG RENOVATION# 2,3,9,10,11,13,16,17,18,20,22,23,28,31,34, 36, 39,42,46
7	PUMP STATIONS HAVING STAND-BY COMPRESSED AIR TANKS FOR BUBBLER CONTROL ARE: 4,24,25,26,27,29,33,35
8	EXPRESSWAY PUMPING STATIONS: TOTAL 18 I-55(30) I-57(35) I-80(1,6) I-290(4,5,7,20,34) Bishop Ford(27) DAN RYAN(21,26,29) EDENS(2,3) KENNEDY(22,23,24)
9	TWO ELECTRIC SERVICES FULL AUTOMATIC TRANS. (2ES FAT) STATIONS ARE: 2,3,5,7,10,12,13,16,17,20,21,22,23,24,25, 27,30,31,32,33,35,37,40,43,44,46,50,51,52
10	TWO ELECTRIC SERVICE SPLIT BUS AUTOMATIC TRANSFER (2ES SBAT) STATIONS ARE: 4,29
11	STAND-BY GENERATOR, NG=NATURAL GAS, D=DIESEL PUMP STATION NUMBERS: 9(D), 11(D),15, 18 (D), 19, 25(D), 28(D), 34(D), 36(D), 39(D), 41(D), 42(D), 47(D) AND TWO (2) MOBILE GENERATORS 31(D), 46(D)
12	MAIN TIE MAIN SCHEME 22,23,26 & 35
13	PS08: Access is limited and requires lane closure for preventative maintenance and other routine maintenance items.
14	
15	PUMPING STATIONS PROGRAMMED FOR CONSTRUCTION 14, 48, 38, 8, 25, 27, 26, 4, 7, 24, 33
16	PUMP STATIONS UNDER CONSTRUCTION 1,6
17	
18	
19	WATER RECIRCULATION IS POSSIBLE, BUT CURRENTLY NOT USABLE AT THE FOLLOWING STATIONS: 24,26,27,33
20	PS12, 14 HAVE COMMON DISCHARGE
21	
22	THE FOLLOWING PUMPING STATIONS ARE UNDER IMPROVEMENT PROGRAM; 4,8,14,24,26,27,48
23	PUMP STATIONS THAT HAVE A STANDBY PUMP: 2,3,5,9,10,21,22,23,28,30,31,34,35,36,39,40,41,42,43,44,46,50, 51 & 52
24	PUMP STATIONS HAVE INTERCHANGEABLE PUMPS: 11,15,18,19,20,31,37,38,39,41,44,48 BUT DIFFERENT IMPELLER SIZES/VOLTAGE
25	PUMP STATIONS ON A MULTI-YEAR IMPROVEMENT SCHEDULE BUT NOT PROGRAMMED: 7,9,11,12,13,15,16,18,19,20,24,29,32,33,35,36,37
26	PUMP STATIONS WITH INTERCHANGEABLE PUMPS : 9, 13, 17, 31, 34 BUT DIFFERENT IMPELLER SIZE/VOLTAGE

GENERAL ABBREVIATION CODES
 P OR (P)..... PROPOSED
 UC..... UNDER CONSTRUCTION

PUMP COMPANY ABBREVIATIONS	PUMP REBUILD HISTORY CODES	PUMP TYPE CODES
AB..... ABS PUMP CO.	N..... NEW PUMP	VA..... VERTICAL AXIAL
AC..... ALLIS CHALMERS	R..... REBUILT PUMP	S..... SUBMERSIBLE
AV..... AURORA PUMP CO.	O..... ORIGINAL	SVD..... SIDE VOLUTE DISCHARGE
CA..... CASCADE PUMP CO.	RWK..... REWORK	DPS..... DRY PIT SUBMERSIBLE
CO..... CORNELL MFG. CO.	NS..... NEW SPARE BOWL	* LOW FLOW PUMP
CP..... CHICAGO PUMP	RS..... REBUILT SPARE	
FL..... FLYGT PUMP CO.	J..... JUNK	
FM..... FAIRBANKS MORSE CO.		
JP..... JOHNSTON PUMP CO.		
PA..... PATTERSON		
PE..... PEERLESS PUMP CO.		
CY..... CLOW YEOMANS		
SC..... SCAN PUMP CO.		

TABLE P-3 PUMP SPECIFICATIONS

PS	MAIN PUMPS							LOW FLOW PUMPS							PS
	MAIN	STAND BY PUMPS	PUMP	PUMP	DSC HG	MOTOR/ENG	CURRENT(FL)	LOW FLOW	PUMP	PUMP	DSCHG	MOTOR/ENG	CURRENT (FL)		
NO	(QTY)	(GPM)	TYPE	SIZE	SIZE	VLT/PHASE/RPM	(AMPS/HP)	(QTY)	(GPM)	TYPE	SIZE	SIZE	VLT/PHASE/RPM	(AMPS/HP)	
1															1
2	4	13200	VA	24	24	460/3/892	181/150	1	9200	VA	18	20	460/3/1188	152/125	2
3	4	17500	VA	30	30	460/3/709	273/200	1	9550	VA	18	20	460/3/1188	120/100	3
4	9	10000	VA	20	24	480/3/1200	227/200	-	-						4
5	4	7000	VA	12	16	208/3/1175	252/100	1	10000	SVD			208/3/710	437/150	5
6															6
7	2	3250	VA	12	14	208/3/1165	70/25	-	-						7
8	2	1500	S	8	8	240/3/890	50/20	-	-						8
9	4	8000	DPS	16	18	480/3/700	224/175	1	3500	DPS	12	12	230/3/875	160/60	9
10	3	640	DPS	6	6	460/3/1750	20/14.8	2	290	DPS	4	4	480/3/1750	9/6.4	10
11	2	2700	DPS	12	12	230/3/860	80/30	-	-						11
12	2	5500	DPS	14	14	230/3/875	159/60	-	-						12
13	2	5500	DPS	12	14	230/3/890	160/60	-	-						13
14	2	5500	SVD	14	14	230/3/875	98/20	-	-						14
15	2	2750	SVD,DPS	10	12	230/3/860	54/20, 80/30	-	-						15
16	2	2700	DPS	10	12	480/3/1170	-/25	-	-						16
17	2	4200	S	14	16	460/3/875	60/60	1	375	S	4	4	480/3/		17
18	2	2900	DPS	12	12	230/3/870	80/30	-	-						18
19	2	3500	DPS	10	12	230/3/860	80/30	-	-						19
20	2	3950	S	12	14	480/3/860	41/30	-	-						20
21	4	10700	S	-	-	480/3/175	207/175	1	3000	S	10	12	460/3/880	82.5/60	21
22	5	15000	S	-	30	480/3/1175	230/189	2	2500	S	8	12	480/3/1160	437/54	22
23	6	14400	S	-	32	480/3/875	196/153	2	2500	S	10	12	480/3/1160	74/52	23
24	6	17500	VA	24	30	480/3/1175	277/250	1	6000	VA	6	6	480/3/	117/100	24
25	6	6000	VA	20	24	480/3/1175	49.5/40	1	1200	S	6	10		-/15	25
26	6	10000	VA	20	20	480/3/1200	138.5/125	1	10000	VA			480/3/1180	140/125	26
27	8	30000	VA	24	36	480/3/708	386/350	2	2500	S	8	12	460/3/1160	77/60	27
28	4	8000	DPS		14	460/3/880	90	2	3000	S		12	460/3/1160	/30	28
29	6	18000	VA	36	30	480/3/705	422/350	2	2700	S	8	12	460/3/1160	92/75	29
30	3	13300	S	50	20	460/3/885	170	1	2800	S	8	12	460/3/1165	67/50	30
31	2	3050	S		12	460/3/1180	0/160	2	1300	S		8	460/3/1170	/35	31
32	2	4800	SVD	14	14	440/3/695	55/40	-	-						32
33	6	9000	VA	18	20	480/3/1175	140/125	1	10000	VA			480/3/1180	144/125	33
34	3	5050	DPS	12	16	460/3/1150	81/60	-	2000	DPS	12	12	480/3/1180	34/25	34
35	5	22500	VA	30.5	36	480/3/700	345/300	1	17500	VA	30.5	36	480/3/700	345/300	35
36	4	7507	DPS	14	16	480/3/880	129/100	-	-						36
37	2	3000	DPS	10	12	230/3/860	82/30	-	-						37
38	2	2500	SVD/DPS	10	12	230/3/860	67/25, 82/30	-	-						38
39	3	2900	S	12	12	460/3/860	41/30	1	840	S	6	6	460/3/1750	20/14.8	39
40	4	800	S	4	6	480/3/1750	16.1/12	-	-						40
41	3	3400	DPS	12	12	460/3/860	40/30	-	-						41
42	3	2500	S	6	6	460/3/1160	24.9/20	1	500	S	4	4	460/3/1160	11.5/7.5	42
43	3	3000	DPS	12	12	460/3/860	40/30	-	-						43
44	3	2500	DPS	16	12	460/3/860	41/30	1	350	DPS	6	4	460/3/1800	/7.5	44
46	3	3800	S	14	14	460/3/885	39.7/30	2	1100	S	6	8	480/3/1750	-/15	46
47	2	2000	SVD	8	8	460/3/875	37.5/20	-	-						47
48	2	2900	DPS	12	12	230/3/870	82/30	-	-						48
50	3	2400	SVD	12	12	480/3/705	50/30	-	-						50
51	3	3400	SVD	12	12	480/3/885	50.5/40	-	-						51
52	3	2200	S	12	10	480/3/860	41/30	1	500	S	4	4	480/3/1750	13/10	52

TABLE P-4: PUMP REBUILD HISTORY

PS NO	POSITION										PS NO	
	1	2	3	4	5	6	7	8	9	10		
1												1
2	95(O)	95(O)	95(O)	06(R)	06(R)	*02(O)*	*02(O)*					2
3	95(O)	95(O)	95(O)	95(O)	*95(O)*	*02(O)*	*02(O)*					3
4	7/04(P)	10/01(RS)	7/03(RS)	2/02(R)	9/05(RW)	3/94(N)	10/03 RS	12/03 (R)	4/08(R)			4
5	3/06(R)	3/06(N)	3/06(N)	3/06(N)	3/06(N)	*3/06(R)*						5
6												6
7	11/88(N)	11/88(N)										7
8	6/06(R)	8/99R										8
9	04(O)	04(O)	04(O)	04(O)	*94(O)*							9
10	93(O)	93(O)	93(O)	6/99R	*02(R)							10
11	1/94(N)	96(P)										11
12	12/04 (P)	10/03 (O)										12
13	5/01(R)	5/01(R)										13
14	12/07 (R)	8/08 (N)										14
15	12/06(N)	9/92(N)										15
16	01(N)	01(N)										16
17	93(O)	93(O)	8/05(R)									17
18	9/93(N)	7/04 (R)										18
19	10/90	11/93(N)										19
20	4/00(N)	4/00(N)										20
21	6/04 (N)	6/04 (N)	6/04 (N)	6/04 (N)	* 6/04 (N)*							21
22	96(O)	96(O)	96(O)	96(O)	96(O)	*96(O)*	02/04(R)					22
23	96(O)	96(O)	96(O)	96(O)	96(O)	96(O)	06(R)	06(R)				23
24	2/02(NS)	02(R)	1-04 (RW)	7/04(RW)	60(O)	60(O)	*12/93(RS)*					24
25	4/04 (RS)	3/27/52	2/95(RS)	5/93(R)	8/91(N)	5/94(R)	*8/01(R)*					25
26	7/97(N)	05/02 NS	9/91(N)	12/07(R)	8/00(N)	06(R)	*12/04 N*					26
27	12/87(N)	6/94(NS)	11/88(N)	11/99@	9/95(RS)		12/01(R)	02/(R)	3/05(R)	*5/01(R)*		27
28	2/01 (N)	2/01 (N)	2/01 (N)	2/01 (N)	2/01 (N)	*2/01 (N)*	*2/01 (N)*					28
29	7/97(N)	5/99(N)	06(R)	5/99(N)	3/96(N)	8/93(N)	06(R)	*00(R)*				29
30	8/02 (N)	8/02 (N)	8/02 (N)	8/02 (N)	*8/02 (N)*							30
31	99(O)	99(O)	99(O)	*7/04 (RW)*	7/04 (RW)							31
32	3/08(N)	96(N)										32
33	06(N)	75(O)	75(O)	8/86(RS)	6/86(RS)	1/96(N)	3/06(N)					33
34	7/04(RW)	2/99@	5/99@	3/08(RW)								34
35	02(NS)	67(O)	67(O)	3/82(S)	67(O)		5/02(NS)					35
36	04 (O)	04 (O)	04 (O)	04 (O)								36
37	10/99	4/92(R)										37
38	08(N)	5/92(N)										38
39	91(O)	7/04 (RW)	91(O)	91(O)								39
40	3/06(N)	06(N)	3/06(N)	0(N)								40
41	10/04 (N)	10/04 (N)	10/04 (N)									41
42	95(O)	95(O)	95(O)	*95(O)*								42
43	9/05 (N)	9/05 (N)	9/05 (N)									43
44	11/02(N)	11/02(N)	11/02 (N)	*02 (N)*								44
45												45
46	12/90(O)	12/90(O)	12/90(O)	01/02(R)	*90(O)*							46
47	1/94(R)	1/94(R)										47
48	3/96(N)	99@										48
49												49
50	85(O)	85 (O)	85(O)									50
51	07(N)	06(N)	06(N)									51
52	1/08 (RW)	02(O)	02(O)	*02(O)*								52

TABLE P-5 SPARE PUMPS AND PUMP REBUILD PROGRAM

PS NO	MAIN PUMPS		LOW FLOW PUMPS		IMPELLER	OIL-TUBE ASSEMBLY	2009 PUMP #	PS NO
	NEW	REBUILT	NEW	REBUILT				
1								1
2			1	1				2
3		1	1					3
4		2						4
5		1		1				5
6								6
7	1						1P	7
8							1P	8
9	1						2,3 & 4P	9
10	1							10
11					1			11
12								12
13								13
14								14
15					1			15
16	1							16
17	1							17
18					1			18
19								19
20								20
21				1				21
22		1			1			22
23		1						23
24				1				24
25		1						25
26								26
27							1&4P	27
28			1					28
29	1	2				2	5&6P	29
30	1							30
31				1				31
32	1				1			32
33		1		1	2		1&6P	33
34							2P	34
35	1							35
36	1							36
37					1		1&2P	37
38								38
39		1						39
40		1					1P	40
41								41
42	1						1,2&3P	42
43					1			43
44			1					44
45								45
46	1				3			46
47								47
48								48
49								49
50	1							50
51					1			51
52			1					52

TABLE P-7 WET PIT CLEANING AND ROOF MAINTENANCE RECORD

PS NO	WET PIT	CLEANING		INSTALL DATE	SUB CONTRACT	REPLACE		WARRANTY		DATE INSPECTED	STATUS	PS NO
	AREA (SQ FT)	PREVIOUS DATE	LATEST DATE			ROOF	COST	5 YRS	10 YRS			
1												1
2	684	10/01	7/02		BOICE	(84)			YES	7/23/07	OK	2
3	684	7/01	5/02		BOICE	(84)			YES	8/28/07	OK	3
4	1144	10/03	9/07		ARROW	(93)	9775		YES	8/30/07	08(P)	4
5	277	7/01	5/04							8/10/07	OK	5
6												6
7	79		10/03	SLAB						3/21/06	OK	7
8	88	UNK		ORIGINAL						1/4/06	OK	8
9	826	9/01		ORIG(77)	Elgin Roofing	(06)				8/28/07	06	9
10	970		4/04							9/4/07	OK	10
11	159		9/07		ERC	(08)			YES	7/25/07	OK	11
12	222	12/05	6/08		ERC	(08)			YES	8/30/07	OK	12
13	223	3/94	6/08			(87)	2070			7/23/07	OK	13
14	182		10/03	ORIGINAL						7/25/07	OK	14
15	143	8/00	10/03		ACER	(90)	1395		YES	8/30/07	OK	15
16	156		86(A)		ACER	(90)	1395		YES	8/27/07	OK	16
17	88	87(A)	88(R)							7/23/07	OK	17
18	212	8/00	6/08		Riddiford	(97)	5,197		20yr-yes	7/25/07	OK	18
19	200	8/00	9/07		Elgin Roofing	(05)				7/25/07	OK	19
20	265	7/01	4/04		38630	(86)				8/28/07	OK	20
21	787	06	8/07		7 K'S	(89)	8484		YES	8/31/07	OK	21
22	478	UNK	10/01		PINNACLE	(87)	5190		YES	8/10/07	OK	22
23	1114		10/01	ORIGINAL						7/23/07	OK	23
24	639	10/98	8/01		ACER	(85)			YES	8/28/07	08(P)	24
25	956	11/99	11/88	ORIGINAL						8/30/07	OK	25
26	432	11/05	26/08		Riddiford	(97)	21,560		20yr-yes	8/10/07	OK	26
27	1984	5/04	9/07			(84)				8/31/07	OK	27
28	1692	8/01	4/04	ORIGINAL						8/10/07	OK	28
29	1223	06	7/08		Riddiford	(97)	30,443		20yr-yes	8/10/07	OK	29
30	809	9/00	7/08	ORIGINAL	ARROW	(93)				8/30/07	OK	30
31	738									9/4/07	OK	31
32	280	10/05	9/07	ORIGINAL						8/28/07	OK	32
33	1039	4/99	7/01		Riddiford	(97)	22,374		20yr-yes	7/23/07	OK	33
34	163	86(A)	9/01							8/28/07	OK	34
35	2002	86(A)	4/02		D&S	(88)	8067		YES	7/25/07	OK	35
36	573	9/01	4/04		Elgin Roofing	(05)				7/25/07	OK	36
37	253	4/97	4/04	ORIGINAL						5/10/06	10P	37
38	198	10/88	4/04	ORIGINAL						5/10/06	OK	38
39	436	10/01	5/04							9/4/07	OK	39
40	1868		10/01							8/27/07	OK	40
41	231		3/02		ACER	(90)	1854		YES	8/27/07		41
42	144		8/00	SLAB						7/24/07	OK	42
43	242	8/00	3/02		ACER	(90)	1395		YES	8/27/07		43
44	204	5/00	11/05	ORIGINAL						8/30/07	OK	44
45												45
46	793									9/4/07	OK	46
47	88		11/11/88(R)		Elgin Roofing	(05)			YES	7/24/07	OK	47
48	216		8/00		CSR	(96)				7/24/07	OK	48
49	-	UNK		SLAB								49
50	624	UNK								8/27/07	OK	50
51	327	8/00	4/04							7/25/07	OK	51
52	443									7/24/07	OK	52

Article 9.0 -- Surveillance and Dynamic Message Sign Systems

9.1 Surveillance and Dynamic Message Sign System Description

9.1.1 Surveillance Equipment

The Surveillance System consists of all devices and appurtenances used for roadway surveillance, Advanced Traffic Management System (ATMS), driver information and ramp metering, control cabinets, load relays, foundations, power services including stand by engine and generator with battery storage units, monitoring and alarm systems, ventilation and cooling systems, switch gear, solar panels, piezo sensors, flashing beacons, inductance loops, 2070 lite controllers, microwave vehicle detectors, micro loops, digital and analog inductance loop detectors shelf and rack mounted, telemetry tone racks, video matrix switches, communication protocol converters, all interconnecting cables, and wooden posts owned or maintained by the State of Illinois and under the jurisdiction of the Department. Specifically included are all FSK tone telemetry power supplies, transmitters, modems, and receivers. A list of the Surveillance Systems locations is available in Section 3.

9.1.2 DMS System Equipment

The Dynamic Message Sign (DMS) system is comprised of LED, fiber flip disk, and flip disk message signs, cameras, control cabinets, 360 Surveillance's Cameleon system for managing signs and cameras and other appurtenances on the various expressways throughout District 1, and video monitors and other control components and appurtenances as located in the Traffic Systems Center (TSC) in Oak Park, Illinois, at the IDOT ComCenter at the District 1 headquarters in Schaumburg, Illinois and IDOT Station One at the Central Office Headquarters in Springfield, Illinois. A list of the DMS locations is available in Section 3.

9.1.3 Field Locations

Specific equipment at field locations includes:

Eleven (11) Tele-Spot 18-inch 3 line, line matrix fiber reflective flip disk fiber optic illumination display and enclosures (including fans and filters, intercabling structural support and service walkway, Tele-Spot sign controller including firmware (software) and enclosure, quartz halogen lamps; twenty five (25) Skyline full matrix LED illuminated DMS, structural support and service walkways, Skyline NTCIP 170 and 2070 controllers, heaters, filters, intercabling, fans; six (6) Ferranti-Packard (FP) 18-inch 3 line character matrix display and enclosures (including filters and fans), intercabling, structural support and including service walkways, fluorescent lighting, Tele-Spot sign controller including firmware (software) and enclosure, multiple output regulated DC power supply; fifteen (15) Arterial DMS 8, 10, or 12-inch full matrix LED illuminated DMS front access lift door, structural support, NTCIP controllers, heaters, filters, intercabling, fans, modems, utilities services (includes all taps, terminations, conduit and cabling interconnect), handholes, above ground splice boxes, meter cabinets, electrical heater and thermostat, control cabinet housing equipment and other appurtenances. 57 Signs and 56 structural supports.

9.1.4 Traffic Systems Center

Specific equipment at the Traffic Systems Center includes:

One (1) Tele-Spot, 3 line, reflective flip disk, line matrix display, and all cabling, one (1) Tele-Spot 1 line, portable 18 inch, 1 module, fiber reflective display and all cabling, sign controller including firmware (software), multiple output regulated DC power supplies including fans and filters, 360 Surveillance Camelon server, 4 workstations, each with dual 18" LCD monitors, DMS drivers, Tele-Spot drivers, NTCIP drivers, and Skyline drivers, and video drivers, 202 sign modems and sign fiber modems (RS232 Transceivers).

The video monitoring system as specified herein shall be a complete and operational system. The system shall include, cameras, pan and tilt drives, command receivers/drivers, system control panels, video

monitors, power, controls, video cables, modems, and telephone line conduit installation and other appurtenances.

ATMS Maintenance and Support

ATMS is used to control ramp metering, provide travel/congestion times, manage incidents/events and manage DMS and amber alerts after completion. Its hardware includes VMIC data acquisition equipment for ramp metering, vehicle detector stations and other field device inputs and outputs; one Christy FRC 5000 video wall controller, two PC based work stations, in addition to Sun servers and workstation equipment. The application was developed by NET Systems, Arlington Heights, IL. The system details will be furnished upon request at the Pre-Bid meeting.

The routine maintenance for ATMS includes preventive maintenance, periodical inspections, at least once per month, response and investigation of trouble calls/deficiencies/abnormalities; replacement of lamps and other periodical maintenance, as specified in Article 11, ComCenter Equipment, in the Christie display system; and replacement of other miscellaneous items less than \$300 each in value. The routine maintenance shall also include ten (10) hours per month of approved ATMS vendor work time and shall include system behavior and resource use review, performing backups, checking processes, routine review of the data acquisition equipment and the network, responding to system use questions and aiding and assisting the Department in user management, such as adding, deleting users of ATMS and resetting user passwords. The Department has a Sun Spectrum Silver contract with Sun Microsystems for maintenance and support of the Sun equipment and is, therefore, excluded from routine maintenance. The Contractor shall, however, perform troubleshooting investigations, preventive maintenance; identify possible failures of this equipment; if necessary, contact and seek Sun for support for resolution of the problem; and implement the final resolution. Under routine maintenance, the Contractor shall provide a high speed data line (speeds up to 1.544mb/s), between TSC and its ATMS vendor, for remote access to ATMS to perform the required work, as defined herein.

Software Vendor Qualifications:

Minimum requirements for the entity or entities include an existing business presence within District 1, 24/7 on-call service capability, on-line monitoring and intervention capabilities, experience in programming using the existing software, qualified ongoing experience with hardware of the type installed, and qualified ongoing experience with software of the type installed. At the Pre-Construction meeting, the contractor shall submit for approval, to the engineer, a qualified vendor to perform systems support and maintenance of the ATMS. The vendor shall meet the following requirements:

1. Have experience in a data acquisition system, specifically synchronized VMIC front end processors.
2. Have experience in coordination control of three Sun Enterprise 3500 servers networked to process, control, and archive data from the data acquisition system, within and outside IDOT for traffic management control information dissemination and analytical functions; in an environment similar to that of TSC.
3. Have experience in the software environment, similar to that of TSC.
4. Have 5 continuous years of maintenance and support of similar systems in size, and scope, in the Sun Solaris environment.

The vendor shall submit, to the Engineer, resumes of the qualified personnel listed to work on the ATMS. Resumes shall list previous projects and specific duties/responsibilities the individual were responsible for as part of the project. The vendor shall list his previous projects, which involved the Sun Solaris software environment. The list shall include the projects contact person, organization, title, and current phone or e-mail information. The resumes shall be submitted at the Pre-Construction meeting.

The Contractor and his ATMS vendor, when applicable, shall provide on-call support with a two-hour response during off business hours, weekends and holidays. The Contractor shall provide the following on-call support:

1. Traffic Systems Center (TSC) personnel or the Contractor personnel shall initiate a System Problem Ticket , (SPT), for the EMCMS, whenever problems are discovered.
2. The Contractor or the ATMS vendor, if applicable, shall respond within the required response time. When applicable and approved by the Engineer, a telephone response from the vendor's technical staff may suffice to meet the response requirement.
3. If the support and resolution requires less than 4 hours of the ATMS vendor's technician's time, he shall perform the work in a timely manner and verbally inform TSC of the required work.
4. If the support and resolution requires more than 4 hours of the ATMS vendor's technician's time, the Contractor shall follow and document according to the following guidelines:
 - a. All actions taken by the vendor shall be documented on a general billing log, identified by the SPT
 - b. SPT will include the date, time, workstation, and username at the time of the occurrence, description of the observed details, and screen print when applicable.
 - c. The SPTs will be submitted to the vendor, via the Contractor, on Friday, each week, or as needed if deemed an emergency by TSC. The Contractor or vendor shall have until the following Friday to respond to the SPT, except in an emergency, in which case the 1-hour response during normal business hours and 4-hour response during off-peak, weekend, or holiday hours will hold. In cases where extensive research is needed to resolve application problems, the vendor will be allowed 4 man-hours per SPT without additional approval to research/determine the response to the Engineer.
5. The vendor response shall include a detailed description of work required to resolve the SPT or complete the improvement, and number of hours required to complete the task.
6. The Engineer will review and approve/deny/choose to negotiate the description of work and man-hours to complete. Work shall not continue without Engineer's approval.
7. The Contractor shall provide documentation, in the routine maintenance monthly documentation book, of vendor work time, both routine and non-routine work, and a ticket summary for the month. Approved non-routine work shall be paid monthly, through an agreed price authorization, or vendor authorization, from budget allowance Pay Item SV02.

9.1.5 IDOT Com Center

Specific equipment at the ComCenter (remote facility):

360 Surveillance Cameleon workstation, 18" LCD monitors and Ethernet interconnect cabling.

9.1.6 IDOT Station One (Springfield)

360 Surveillance Cameleon workstation, monitors and Ethernet interconnect cabling

9.1.7 General Maintenance Responsibilities

All items as listed in the system descriptions above shall be maintained under routine maintenance, unless otherwise stated herein.

Damaged parts, material, or other equipment from field installations, which is salvageable, may be repaired by the Contractor and may be reused in the system upon approval by the Engineer.

Refer also to Article 9.7 Special Inventory Requirements.

For other General Maintenance responsibilities refer to Article 5.

9.2 Response and Repair Time Requirements

Article 5.0 discusses general response requirements of routine maintenance. The following chart lists the maximum response, service restoration, and permanent repair time the Contractor will be allowed to perform corrective action on specific surveillance system equipment before liquidated damages are assessed. (For response and repair time documentation requirements (tickets) review Article 5.0).

Incident or Problem	Response Time	Service Restoration Time	Permanent Repair Time
Ramp Metering Malfunction or Damage	1 hour	4 hours *	24 hours
Cabinet Motorist Caused Damage	1 hour	48 hours	**
DMS Malfunction or Damage	1 hour	8 hours	10 days
Inoperable Loop Detector Unit	1 hour	4 hours	10 days
Repair/Replace Induction Loop (Non-Metering Location)	1 hour	48 hours	14 days
Repair of Power Supplies, Telemetry, etc.	1 hour	4 hours	14 days
Repair/Replace 2070 Lite Controller DMS/Ramp Meter/Detector Cabinet	1 hour	4 hours	30 days
Cable Repairs (Temp Cable Needed)	1 hour	24 hours	21 days
Inoperable Microloop	1 hour	4 hours	14 days
Inoperable Microwave Vehicle Detector	1 hour	4 hours	14 days
Conduit Repairs	1 hour	24 hours	21 days

*In case of ramp metering cabinet knockdowns, service restoration of all component parts affecting the ramp metering operation shall be completed within four (4) hours or by the next ramp metering control period, whichever is first.

** Dependant upon availability of new control cabinet

9.3 Specific Maintenance Responsibilities

Cable Locates

The Surveillance/DMS patrolmen or Specialist shall normally perform all cable locates for the Surveillance and DMS Systems.

Ramp Control Signal Head, Post Mounted, One Face

The Contractor shall maintain a traffic signal head, a traffic signal post and foundation. The traffic control signal head shall consist of one (1) face and two (2) signal sections.

Flashing Beacon Signal, Low Mounted, 2 Signal Sections

The Contractor shall maintain a low mounted flashing beacon and module, and all appurtenances, mounted on a wood pole.

Ramp Metering Control Cabinet and All Components

The Contractor shall maintain an expressway ramp metering control cabinet, foundation, load relay, telemetry mounting frame, and all other appurtenances including the telemetry power supply, transmitters and receivers.

Ramp Metering Control Cabinet with P.I.M.S. and All Components

The Contractor shall maintain an expressway ramp metering control cabinet, foundation, load relay, telemetry mounting frame, a CB radio, CB antenna, a 4” PVC duct to hide and mount the CB antenna, a 12 volt power supply, a dial-up telephone circuit, and all other appurtenances including the telemetry power supply, transmitters and receivers.

Ramp Meter Control Cabinet, Type 334

The Contractor shall maintain an expressway ramp metering control cabinet Type 334 with Type I foundation, PDA, solid state flasher cube, load relay, detector input file, and all other appurtenances located or attached to the ramp meter cabinet Type 334 location.

Surveillance Cabinet and All Components

The Contractor shall maintain a surveillance, cabinet post and base, foundation, telemetry mounting frame, where applicable, including the telemetry power supply, transmitters and receivers, and I-55 CCTV.

Surveillance Cabinet with P.I.M.S. and All Components

The Contractor shall maintain a surveillance cabinet, cabinet post and base, foundation, telemetry mounting frame, where applicable, a CB radio, CB antenna, a 4” PVC duct to hide and mount the CB antenna, a 12 volt power supply and a dial-up telephone circuit, and the telemetry power supply, transmitters and receivers.

Surveillance Cabinet and all Components, Type 334

The Contractor shall maintain a Type 334 surveillance cabinet on Type I foundation, PDA, detector input file and all other appurtenances located in or attached to the surveillance cabinet Type 334.

Ramp Metering Loop Detector Wire, Sensor Unit and All Components

The Contractor shall maintain an in-road loop wire either embedded in a sawed slot in the roadway pavement or embedded in the concrete pavement (pre-formed loops), a loop detector sensor unit, vehicle loop detector amplifier or active channel encased in a durable housing within the Ramp Metering Control Cabinet.

Expressway Loop Detector Wire, Sensor Unit, and All Components

The Contractor shall maintain an in-road loop wire either embedded in a sawed slot in the roadway pavement or embedded in the concrete pavement (pre-formed loops), an expressway loop detector, vehicle loop detector amplifier or active channel encased in a durable housing within the Detector Cabinet. These detectors shall be located on expressway mainlines, exit ramps and uncontrolled entrance ramps.

Inoperable Induction Loop, Microloop, or Microwave Detector Procedures

If an inoperable induction loop, microloop, or microwave detector is found on patrol (or discovered via Dispatched Incident), the Surveillance/DMS patrolman shall retune the detector or immediately replace the loop detector with a spare detector from the EMC Spare Parts Inventory or IDOT State Stock.

If it is found that the loop detectors (original and spares) are still inoperable, the Contractor shall immediately start an analysis of the induction loop wire and lead-in and report findings to the IDOT TSC Manager. All information shall be recorded on a ticket.

Analysis of Induction Loop Wire and Lead-in

Before each analysis the patrolmen shall calibrate and date the megger and loop tester and then follow these instructions for the induction loop wire and lead-in:

- Measure a minimum of 100 megohms (above ground under any weather or moisture conditions) when tested with a major megger.
- Have a resistance not greater than five (5) ohms when measured with a loop tester in a continuity test.
- Have an inductance between 50 and 1000 microhenries when tested with the loop tester.

No installation shall be left inoperable because a detector has been removed. The Traffic Systems Center's original detector shall be repaired (or replaced with new) and returned to the original installation within 10 working days.

Both the IDOT original equipment number and the EMC spare part equipment number shall be recorded on the ticket, as well as the other pertinent information concerning the replacement of an inoperable loop detector.

The ticket shall not be cleared until original equipment has been re-installed.

Analysis of Microloop Sensors

Before each analysis the patrolman shall calibrate and date the megger, loop tester and volt/ohm meter, then follow these instructions for the microloop, microloop lead-in and microloop homerun cable:

- The microloop probe inductance shall be between 50 μ H and 80 μ H
- The inductance of lead-in cable shall be 16.5 μ H per 100 feet
- The inductance of the homerun cable shall be 23 μ H per 100 feet
- The total inductance shall be the sum of probe, lead-in and homerun cable calculated \pm 20 percent
- The measured DC resistance shall be the sum of the probe, lead-in and homerun cable calculated \pm 20 percent
- Probe resistance shall be 1.5 ohms
- Lead-in cable resistance 3.0 ohms per 100 feet
- Homerun cable resistance shall be 2.0 ohms per 100 feet.
- The patrolman can use a properly calibrated functioning matched vehicle detector to measure the change in inductance of the sensor when a standard mid-size vehicle is driven directly over the sensor
- The measured change in inductance for a standard mid-size vehicle shall be in the range from 120 Nh to 1200 Nh.
- If it is found a microloop is inoperable, a repair ticket shall be started and all pertinent information for the replacement shall be logged and used for ordering a replacement sensor.

Analysis of Microwave Vehicle Detectors

The microwave vehicle detector shall be remotely interrogated from the detector cabinet with a laptop PC loaded with the latest version of the detector's manufacturer's software available and/or a test cable used locally at the detector.

- The Contractor shall verify if it's the detector or communications cable which has failed.
- Each detector shall have a RS 232 serial port available to use the diagnostic program to talk to the detector.
- If it is found that the detector needs to be replaced, a spare state stock detector shall be used to replace the defective unit until the defective unit can be repaired or replaced.
- If it is found the communication cable is defective, a new cable shall be installed immediately to restore the operations of the detector site.
- A work ticket shall be started and the original equipment shall be repaired and returned to the original locations within 10 working days. Both the original IDOT equipment number and EMC spare part equipment number shall be recorded on the ticket along with all other pertinent information.
- The ticket shall be cleared when the original equipment has been reinstalled.

Induction Loop

Following the analysis of the induction loop by the Specialist and/or TSC inspectors, and it is ascertained by TSC Engineer that damage was not due to State personnel, the Contractor shall replace the loop under routine maintenance.

Off- Expressway Loop Detector Wire, Sensor Unit, and All Components

The Contractor shall maintain an in-road loop wire embedded in a sawed slot in the roadway pavement, a loop detector, vehicle loop detector amplifier or active channel encased in a durable housing within the detector system cabinet.

Traffic Data Collection Station with Solar Panel

The Contractor shall maintain a traffic data collection location with solar panel installation, including a control cabinet of any type, foundation, model 241 counters, multiplexer input cables, AC power adapterchargers, multiplexer, modem cable, with or without 12 volt battery, VDS 103S-lp modem and #MSX-10- solar panel.

Traffic Data Collection Station without Solar Panel

The Contractor shall maintain a traffic data collection location without solar panel installation, including a control cabinet of any type, foundation, model 241 counters, multiplexer input cables, service breaker, multiplexer, modem cable and service installation.

Cross Connect Surveillance Cabinets

The Contractor shall maintain an expressway cross connect surveillance cabinet, including a cabinet shell, foundation, telemetry card racks, mounting frame, the telemetry power supply dual line amps, S-666B8-50 terminal blocks, and A.C. duplex outlets.

Surveillance Conduit and Cable

Cable which is damaged shall be removed from the job and new cable installed to replace the existing. The damaged cable shall be replaced to the nearest upstream and downstream cabinet or junction box from which it originates or terminates in. No cable splices will be allowed below ground except for induction loop lead in cable. If an induction loop lead-in cable is damaged it shall be replaced back to the loop dive hole or closest handhole to the loop dive and a new lead-in cable shall be spliced there.

Damage to Unit Duct (Polyethylene conduit):

If unit duct is damaged but cable inside is not damaged, then the Contractor shall make the following repairs:

- A. Install a split corrugated slip duct over the damaged section
- B. Install a wrap around heat shrink tube over the damaged section overlapping each end by three inches minimum to make a water-tight installation

If unit duct is damaged and cable is also damaged, then the Contractor shall make the following repairs:

- A. Remove cable and damaged section of conduit
- B. Replace damaged unit duct with compression couplers (E Loc Coupler) and new unit duct
- C. Install heat shrink over entire repaired area, overlapping repair on each end by three inches minimum to make a water-tight repair

Refer to Article 5.0 for other General Maintenance responsibilities.

9.4 Daily Ticket Review

The Surveillance/DMS Manager shall review all tickets every work day, edit and/or correct responses, and discuss work activities with the IDOT TSC Manager, prior to the issuance of the Surveillance/DMS Daily Agenda by 8:30 each work day. (Review also Daily Agenda requirements in Article 5.0).

9.5 DMS Patrol Requirements

The Surveillance/DMS Patrolmen shall perform a weekly inspection of each Dynamic Message Sign location to assure that each installation and its components are functioning properly. Unless otherwise permitted or requested by the Engineer, except for emergencies, the Contractor is required to schedule the IDOT surveillance patrol routes the first portion of each workday and on the approved route day. Emergency services required by IDOT or other agencies shall be attended to immediately, however, any incomplete daily patrol shall be completed (by the original patrolman or by an approved substitute) during the normal patrol work week. This may require patrols after the normal work day has ended in order to complete the normal patrol work week.

The Engineer shall be notified on a daily basis at the end of the patrol work day of the following:

- List of all incomplete patrols for the day
- Specific reason for each individual incomplete patrols
- Plan as to how Contractor will make-up each incomplete patrols

All repairs not completed at the time of the patrol route inspection must be logged and turned over to Contractor’s area supervisor. Repairs not completed at the time of the patrol route inspection are subject to the time limits in Article 10. All Patrol records shall be maintained and submitted to the Engineer weekly.

9.6 DMS Special Inventory Requirements

The manufacturer of the IDOT Dynamic Message Sign equipment is no longer in business. The replacement parts for this equipment are not readily available. Therefore, the Contractor is required to have any defective boards repaired by qualified service personnel, as approved by the Engineer. The Department maintains a small supply of necessary spare boards in State Stock. The Contractor may use these boards, if available at the time, but must replenish them as soon as possible. The following is a list of approximate quantities of Department owned State Stock available for Contractor use.

Quantity	Item
10	Light Control Master Module
9	Light Control Photocell Module
2	Photocell
5	3101 Controller
13	3901 Controller
2	3201 Controller
2	3201 Distribution Board
2	RS232 Board
10	Light Control Slave Module
16	3901 Column Board
13	3901 Row Board
10	3101 Column Board
10	3101 Row Board
4	3901 Key Pad
9	5 Volt-12 Volt Power Supply, 3101 Controller
8	12 volt Power Supply, 3101 Controller
3	4 Wire Modems
6	TS-232 Modem
7	3901-3801 Power Supplies
13	3900 GP/IO Boards
9	Distribution Boards
2	3101 Modems
11	3202 Controller

1	3101 Capacitor Bank
---	---------------------

9.7 State Stock for The Surveillance System

The Department has a limited amount of state stock on hand which may be used by the Contractor, but must be replenished as soon as possible. The TSC Manager shall be notified of any shortages of state stock materials.

Quantity	Item
91	FSK Tone Transmitter
66	FSK Tone Transmitter (mini)
67	FSK Tone Receiver
41	4 Channel Loop Amps
16	2 Channel Loop Amps
12	Type 3 Surveillance Cabinets
5	Type 2 Surveillance Cabinets
2	Type 2 Speed Cabinets
310	Moisture Covers
39	FSK Power Supplies
8	1 Channel Loop Amps

9.8 Semi-Monthly Ramp Metering Cabinet Inspection

The Surveillance/DMS patrolmen shall perform a patrol inspection of each Surveillance System Ramp Metering Cabinet location twice per month and provide the following information on Log form S-10:

- Database Location Number
- Expressway Name
- Arrival Time
- Cabinet Number
- Designate Inbound or Outbound
- Inspect Loop Detectors (if applicable)
- Check 2070 lite controller for proper operation (if applicable)
- Check tones for proper operation (if applicable)
- Verify functioning of bulbs, LED’s, signal load relays, and flashing beacon controllers
- Telephone TSC for Location Turn-On
- Verify aim of beacon and signal head.
- Beacon head shall face the top of the ramp, the right hand signal facing the metering input loop (Loop 1), and the left hand signal shall face the top of leading edge of the demand loop (Loop 2).
- Replace burnt-out lamps, LED heads, and damaged lenses.
- Inspect cabinet PDA for proper operation (if necessary)
- Check for missing, damaged or loose signs.
- Check cabinet and signal foundation and tighten where necessary.
- Check lubrication of cabinet doors, hinges, and locks.
- Check tuning and operation of loop detectors and/or detector input files.
- Inspect stop bar striping for deficiencies.
- Log follow-up activity needed and telephone the EMC Dispatch Center for ticket number.
- Before leaving the surveillance installation, the patrolman shall verify the accuracy of the data with TSC. The patrolman shall not leave the location until the Traffic Systems Center’s personnel have checked on the accuracy of the data being received at the TSC office.
- Record Departure Time

The EMC Dispatch Center shall be notified to create a ticket noting problems found and/or repairs made.

Log form S-10 shall be delivered to the TSC Manager within 24 hours of completion of work.

9.9 Monthly Ramp Metering Cleaning

The Contractor shall wash the ramp control signal head lenses and reflectors, flashing beacons, and signs associated with each ramp metering installation, and clean the inside and outside of the cabinets once per month. The cleaning materials and procedures shall be approved by the TSC Manager prior to starting the work.

Ramp metering cleaning shall be performed during non-peak congestion hours when ramp metering is not in operation controlling traffic. All work shall be noted on the Daily Agenda.

The EMC Dispatch Center shall be notified to create a ticket if problems are found.

9.10 Monthly Dms Cabinet Inspection And Cleaning

The Surveillance/DMS Patrolmen shall inspect, check and service all parts of the DMS cabinet monthly. Information to be collected includes:

- Database location number
- Expressway name
- Arrival/departure time
- Cabinet number
- ComEd meter number
- ComEd transformer number
- Verify photocell operation
- Verify functioning of fans/heaters; replace or repair if necessary.
- Check cabinet and meter foundation and tighten where necessary.
- Check filters; replace if necessary.
- Inspect/test battery back up units (BBU's) where necessary
- Inspect/test PDA's where necessary
- Check operation of 2070 lite controllers. Verify correct version of firmware loaded in local and remote operations where necessary
- Check operation of 170 controllers. Local and remote modes verify firmware version loaded
- Inspect communications and power cables incoming and outgoing.
- Verify with Control Room Operator at TSC, message correctness and lamp intensities on DMS sign. Replace lamps (as a group, not individually) as needed.
- Check voltage levels of power supplies and battery and adjust where needed.
- Check blank-out functions.
- Check levels on transmit and receive pair in cabinet.
- Check meter housing making sure it is seated properly, and weather-tight. If any problems, coordinate with utility company.
- Check ribbon cables in sign enclosure for worn spots or breaks in the cable/insulation. Verify seating of components and connections. The DMS M.O.S.Y.S. sign are subject to vibrations which cause loose connections and ribbon cable which rest on metal surfaces to become worn and become shorted over a period of time. The contractor shall take immediate corrective action to correct these problems when discovered.
- Check CCTV as required by CCTV manufacturer or as directed by TSC Engineer.

All repairs requiring follow-up should be radioed to the EMC Dispatch Center and a Ticket created. Log form D-1 shall be completed and submitted to the TSC Manager within 24 hours of completion of work. All work activity shall be reported on the Daily Agenda.

The Contractor shall also clean the DMS cabinets, inside and out, once per month, in off-peak rush periods between 9:30 am and 2:00 PM Monday through Friday. The cleaning materials and procedures shall be approved by the TSC Manager prior to starting the work. All work activity shall be reported on the Daily Agenda.

9.11 Monthly CCTV Inspection

The Surveillance/DMS Manager or Specialist shall perform routine maintenance on the CCTV cameras of DMS, monthly, in accordance with the recommended preventative maintenance schedule provided by the CCTV camera manufacturer. The camera and its lens shall be cleaned as needed, a minimum of three times per calendar year. All work activity shall be reported on the Daily Agenda.

9.12 Monthly Sign Enclosure Cleaning

The Contractor shall hand wash and clean each DMS sign enclosure, inside and/or outside, on a monthly basis, or less frequently as determined by the Engineer, to ensure proper sign functioning. The Engineer/TSC Manager shall approve the cleaning agent and cleaning materials prior to the first cleaning, and shall provide the Contractor with a procedure instruction sheet. All work activity shall be reported on the Daily Agenda.

The Contractor shall contract with a specialty service company, subject to approval by the Engineer, employing a trained and certified closed circuit video service technician in the event of a CCTV failure. Following notification (Ticket entry) of a CCTV failure, the Contractor shall do basic trouble shooting (within four hours of notification) to determine extent of the malfunction. This trouble shooting would entail verification of video out of camera, local control of PTZ at the cabinet location, proper power supply voltages, etc. After consulting with the Engineer, if it is determined that the Contractor cannot adequately repair the problem, the specialty contractor shall be notified to make the repairs.

9.13 Yearly Surveillance Cabinet Inspection and Cleaning

The Surveillance/DMS patrolmen shall perform an inspection of each surveillance expressway detector cabinet once per calendar year, and record on Log form S-11. Information to be collected or activity required includes:

- Database Location Number
- Expressway Name
- Arrival Time
- Cabinet Number
- Designate Inbound or Outbound
- Inspect Induction Loops
- Inspect electric service disconnect. Note any deficiencies in an advisory report to the TSC Manager.
- Check Tones for proper operation
- Check 2070 lite controllers for proper operation (if necessary)
- Check Cabinet Foundation, tighten where necessary
- Check lubrication of cabinet doors, hinges, and locks
- Clean cabinet inside and out
- Inspect cabinet PDA for proper operation (if necessary)
- Check tuning and operation of loop detectors or detector input files
- Log follow-up activity needed and radio the EMC Dispatch Center to create ticket
- Record/edit cabinet inventories
- Before leaving Surveillance location, patrolman shall call TSC and ask that the accuracy of data be checked. The patrolman shall not leave until the Traffic Systems Center personnel have check on the accuracy of the data being received at the Traffic Systems Center.
- Record departure time

The EMC Dispatch Center shall be notified to create a ticket noting problems found and/or repairs made.

Log form S-11 shall be delivered to the TSC Manager within 24 hours of completion of work.

All Surveillance System cabinets are also to be cleaned once per year. The cleaning materials and procedures shall be approved by the TSC Manager prior to starting the work. All work shall be noted on the Daily Agenda.

9.14 Yearly Sign Support Inspection

Each July the Contractor shall visually inspect for general safety the condition of each DMS sign support structure and catwalk, including the sign support brackets/bolts which attach the DMS sign box to the sign structure. All work activity shall be reported on the Daily Agenda.

9.15 Yearly Grounding and Electric Service Upgrade

As part of routine maintenance of the Surveillance System, the Contractor shall perform electric service and grounding modifications to a total of five (5) Surveillance System and Dynamic Message System cabinets by October 31 of each contract year, as described herein. Note that the service entrance disconnect is the type used for the Surveillance System, and the distribution extends through one or more surveillance cabinets to complete grounding to all downstream equipment.

The locations to be modified will be designated by the Engineer prior to March 1 of the contract year. The Contractor shall include a progress report in the monthly routine maintenance submittal book.

The Contractor is responsible for scheduling the work and for coordinating with the engineer whenever Engineer-witness functions are required. The Contractor shall also advise the engineer when each location is complete and shall provide a written certification to that effect. The Engineer reserves the right to require a final inspection of the modification at any or all of the locations certified as complete. Should deficiencies be found upon inspection, a corrective work list will be prepared. If progress of the work is inadequate, or if errors in certified complete work are repeatedly found, the Engineer may initiate withholding of routine maintenance payment.

The surveillance installations being modified shall be kept operational at all times except as expressly allowed herein or otherwise permitted by the Engineer. The Contractor shall be responsible for all traffic control and temporary provisions required for the work, all at no additional cost. All cable, conduit, fittings and accessories shall be new. All materials and work shall be in conformance with the requirements of applicable Contract Special Provisions and specifications and article 250 of the National Electrical Code.

The Contractor shall be responsible for coordination with the Electric Utility as necessary and shall be responsible for reporting any account modifications arising from the work to the Engineer in a timely manner. Although it is anticipated that all service agreements and accounts will remain as-is, if new agreements are required, the Contractor shall facilitate coordination between the Electric Utility and the Engineer, with the Department to sign any appropriate new agreements.

The work will generally include:

- Replacement of the electric service entrance equipment and cables
- New grounding of the service
- New feeder conductors from the service disconnect to the controller cabinet
- Cabinet grounding modifications
- Supplementary ground electrodes at handholes
- Extension of equipment ground wires to all poles, posts, handholes, etc.
- Bonding of equipment ground to all exposed metal parts
- Testing and documentation

Replace Electric Service Entrance

The work shall include the removal of the existing service disconnecting means and the service conductors and shall include the furnishing and installing a new pole-mounted or pedestal-mounted service disconnecting means and new service conductors, based on the manner of the existing service. The new electric service disconnect, cables and the service connection shall be in accordance with details included herein. Unless otherwise indicated, the pole-mounted electric service box provided for these installations shall be as shown in Figure L-3A, in Section 1, Article 7.0, unless specified otherwise by the Engineer.

Provide New System Ground of Electric Service

The work shall include the installation of a new system ground, connected to the ground bar of the service disconnect, using one or more ground rod grounding electrodes, or other means approved by the Engineer. The system ground shall have a resistance to earth not to exceed 10 ohms without connection to the additional electrodes established at poles or other points at the surveillance/DMS location. The system ground resistance shall be verified by a contractor test, using the fall-of potential method and witnessed and approved by the engineer, with a record of the test entered by the Contractor and signed by the Contractor and the Engineer. Should more than one electrode be required to establish a low enough resistance, additional electrodes shall be connected to the grid, with re-testing. All ground electrode connections shall be exothermically welded. Ground rods and grounding electrode conductors shall be as specified and detailed.

The service grounded circuit conductor (which may or may not be a system neutral) shall be bonded to the system ground at the service disconnect and shall be isolated from ground throughout the remainder of the electrical distribution.

Extend New Conductors to Controller

A new ground terminal bar shall be installed at the surveillance cabinet and this bar shall be bonded to the cabinet enclosure. The work shall include the replacement of the existing feeder and the extension of new feeder conductors from the service disconnect to the surveillance cabinet. The cable will be a multi-conductor jacketed cable as specified and it shall include a green-insulated ground wire to bond the service ground bar to the controller cabinet ground bar. The Contractor shall confirm the integrity of the existing feeder conduit run, and shall clean the run before installing the new feeder. If the size of the conduit is demonstrated to be inadequate for the new feeder cable or if it is demonstrated as not re-usable for some other reason and no other alternative is feasible, the contractor shall use a new feeder conduit run, as part of this routine maintenance work, with all cable work remaining as the Contractor's responsibility at no additional cost.

Cabinet Grounding Modifications

The Contractor shall confirm the presence of a terminal bar, with suitable terminals, for the grounded circuit conductor (white wire) at the controller cabinet and shall assure isolation of this bar from the cabinet enclosure and other grounded parts. If the existing bar is inadequate or is not isolated properly, the Contractor shall provide a new bar or otherwise correct the installation, removing any incorrect items. Similarly, the contractor shall confirm the presence of a ground bar, with suitable terminals, which is bonded to the cabinet enclosure and grounded metal parts. If the existing ground bar is inadequate or is not bonded properly, the Contractor shall provide a new bar or otherwise correct the installation, removing any incorrect items.

Extension of Equipment Ground

The contractor shall extend an equipment ground conductor from the ground bar in the controller cabinet to distributed elements of the system, bonding the equipment ground conductor to all handhole frames, metal poles and other enclosures, metal conduit, etc., including any existing supplemental ground rods that may be in place. The Contractor shall assure that good equipment ground continuity and a low-impedance ground return path is established throughout for all exposed metal parts of the installation.

It is not the intent of this work item to require re-cabling of the surveillance load equipment to achieve grounding. In all cases, a green-insulated ground conductor shall be used whenever possible, and only if conduit space will not accommodate an insulated conductor will a bare conductor be allowed. A common conductor may be employed for multiple load circuit cables in a given conduit, but an equipment ground conductor shall be run with or shall encircle each set of circuit conductors extended from the controller cabinet.

Recognizing the intent to leave existing conductors in place and operations, the contractor may chose from among identified and prioritized acceptable alternative to affect the grounding modifications:

If an existing conduit will accommodate the installation of a ground wire, the ground wire shall be installed within the conduit with the circuit conductors. Existing conductors should only be withdrawn from a conduit run to facilitate pulling of the ground wire if absolutely necessary.

If an existing metal conduit will not accommodate the required ground wire, and if the Contractor can identify end-to-end electrical continuity of the conduit, the Contractor may bond to the conduit externally in an approved manner to establish ground continuity, thus using the metal conduit as the equipment ground conductor.

If a given conduit run is demonstrated to be damaged and electrically discontinuous in the presence of the Engineer, and if no other alternative is feasible, the Engineer will authorize a new conduit run, to be paid under separate pay time, with all cable installation to remain part of the grounding modification work at no additional cost to the pay item. When a new conduit is installed, an insulated ground conductor must be installed within, together with the circuit conductors, regardless of the ground continuity of the new conduit, and the new conduit shall be appropriately bonded to the equipment ground.

Bonding

The Contractor shall establish equipment ground bonding to the cover frame of every handhole with an approved connection. The contractor shall establish equipment ground bonding at every metal pole, post or other enclosure or device, also with an approved connection. At poles or post bases, it may be possible to install washers, lugs, and extra nuts where extra anchor bolt protrusion allows it. Otherwise, poles may be drilled and tapped and fitted with appropriate ground lugs. Connections at poles and other enclosures shall be pigtailed from splices whenever more than one ground conductor is connected so that ground continuity is not dependent upon ground lug connection. Splices of ground conductors (in lieu of exothermic weld connectors) will be permitted at poles an other such connection point above grade, with splices to be made using suitable copper crimp sleeves and heat-shrink insulated caps as specified.

Testing and Documentation

As noted above, the system ground resistance to earth shall be tested, in isolation from equipment ground extensions from that point. Testing shall be performed by the contractor using the fall-of-potential method, with results recorded by the Contractor and witnessed by the Engineer. Ground continuity shall be tested using an approved low-impedance ohmmeter, to the farthest point of each circuit extension from the controller cabinet. Results shall be recorded by the contractor and witnessed by the Engineer.

9.16 Surveillance Non-Routine Maintenance

The Contractor shall be advised that several routinely maintained items such as, but not limited to, yearly UPS system inspection, the auto suppression system inspection, and inspections of equipment/physical items at the TSC facility, integral to operations and maintenance of system equipment, such as HVAC, battery storage units, and monitoring systems, are paid through non-routine maintenance. Review Section 2 Special Provisions.

9.17 Logs And Forms

A sample of logs and forms as required for this Contract will be available at the Pre-Bid Meeting.

Article 10.0 -- Traffic Signal System

10.1 Traffic Signal System Description

The Traffic Signal System consists of electronically operated traffic control devices owned and maintained by the Department, which includes traffic signal installations and the integrated closed-loop traffic signal monitoring system, and flashing beacon installations.

The Traffic Signal installations (locations) include, but are not limited to, master and local controllers, time base coordinators, coordination units, intersection monitors, modems, controller cabinets, battery backup systems (UPS), phone lines, microwave communication lines, detectors (induction loop type, magnetic type, wireless type, microwave type, video type, pedestrian push-button and infrared type, and light sensing or radio communication emergency vehicle type), incandescent and light emitting diode signal heads (traffic and pedestrian), aviation red obstruction beacons, internally illuminated, fiber optic signs, LED signs, audible and countdown pedestrian signals, electronically steerable beam LED signals, in-pavement lights, traffic signal posts, mast arm assembly and poles, electric cable (standard multi conductor, shielded multi conductor, coaxial and fiber optic), conduit, communications lines and conduit between intersections, concrete foundations, handholes, junction boxes, service installations, ground rods, railroad interconnect security systems, tilt/pan/zoom video cameras and control units, red light running enforcement video cameras, microwave interconnect systems, radio interconnect systems, Cisco communication switches, video decoders, and other appurtenances. The Closed Loop Monitoring System (CLMS) includes approximately 325 master controllers interconnected to 2300 intersection controllers. Also included in the CLMS is the interconnect cable, conduit, handhole systems, hardware, software, supplies for the Schaumburg headquarters office, and CLMS field equipment for monitoring. The Lake County Traffic Management Center (TMC) currently includes approximately one hundred (100) and Kane County TMC has less than twenty-five (25) IDOT intersection controllers with additional intersections planned.

The flashing beacon installations include both low and high mounted twelve inch signal sections, a service installation, flasher controller in cabinet, cable and conduit as well as solar flashers and all necessary appurtenances.

All signal mast arms and combination mast arms shall be maintained under Article 10, the Traffic Signal System. The luminaire(s), the lighting mast arm, and cabling for the luminaire on combination mast arm poles shall be maintained under Article 7, Lighting and Sign Illumination System. Standard light poles that have traffic signals attached will be maintained under Article 7, except in some instances the poles may be under maintenance of other agencies.

10.1.1 Traffic Signals (Refer To Section 3, T-1a)

The Contractor shall maintain all traffic signal equipment located at a traffic signal installation location and the District 1 Closed Loop Monitoring System. A traffic signal installation location shall consist of all equipment controlled by one local traffic signal controller, including but not limited to the following:

- Traffic signal heads, traffic signal posts, mast arm assemblies, poles and foundations (The traffic signal heads shall consist of but not limited to signal sections, back plates, louvers, visors, aviation red obstruction lights, special signal sections with flashing white strobes, incandescent lamps, and light emitting diodes modules.)
- Pedestrian signal heads, pedestrian push button detectors, infrared detectors, audible pedestrian signals, countdown pedestrian signals and associated signs
- A pre-timed, semi-actuated, or NEMA I or NEMA II actuated controllers and cabinets (The controllers may be electrical mechanical or solid state types with volume-density features, railroad and/or fire preemption and time base coordination.)

(The railroad preemption, fire preemption and time-base coordination may be internal, a module, or external to the controller.)

- The controller cabinet with its associated equipment, system communications equipment, battery backup systems (UPS), switching units, intersection coordinators, time switches and, where applicable, control pedestal and foundation
- Emergency vehicle preemption equipment and intersection monitoring devices, where applicable (The cost of repairing or replacing the emergency vehicle preemption equipment shall be invoiced, by the Contractor, directly to the local agency, as instructed by the Signal Engineer.)
- Red light running enforcement equipment is generally located within State ROW and utilizes separate facilities than the traffic signal installation except access to field cables within the controller cabinet for signal status is permitted. Red light running enforcement equipment is not the maintenance responsibility of the State or this contract. However, if the red light running system impacts the normal operation or visibility of the traffic signals or is determined to be a safety hazard by the Signal Engineer, the cost of repairing, replacing, removing or the like shall be invoiced by the Contractor directly to the local agency as instructed by the Signal Engineer.
- Magnetic detector(s), wireless detector(s), video detector(s), cameras, detector loop(s), micro loops, preformed detector loops, microwave detector(s), and emergency vehicle detector(s) along with their related amplifiers, microprocessors, access points, relays, video decoders, relays and diodes

(The maintenance of video detection shall include all necessary modifications to programmable detection zones. Microwave Communication for Video Detection including transmitters, receivers, antennas, reflectors and other miscellaneous communication equipment either on the sending end, receiving end or in between shall be included as part of the Video Detection.)

- Illuminated regulatory signs
(The illumination shall be accomplished by incandescent lamps, fluorescent lamps, neon tubes, light emitting diodes or fiber optic lights.)
- Illuminated street name signs
(The illumination is generally accomplished by light emitting diodes. For lighted street name signs not maintained by the State, the cost of repairing or replacing any associated equipment shall be invoiced, by the Contractor, directly to the local agency, as instructed by the Signal Engineer)
- Traffic signal conduit and interconnect conduit between traffic signals
(The conduit may be in the ground or attached to structure.)
- Traffic signal handholes and interconnect handholes
- Traffic signal cable and interconnect cable including copper wire and fiber optic
- Traffic signal wireless interconnect system
- Electrical and telephone service installations
- Pan, tilt and zoom camera installations.
- Traffic adjusted master controllers with solid state features with associated equipment and where applicable, cabinet and foundation

(The associated equipment shall consist of modems, telephone jacks, switching units, interface boards for copper and fiber optic type interconnect cables, noise suppressers and all associated components for a coordinated traffic control system.)

- Railroad interconnected traffic signal equipment, conduit, wiring, and security systems
- Signal heads and conduit attached to railroad cantilever structures
- Grounding systems complete with ground rods, ground wells, and grounding cable

10.1.2 Temporary Traffic Signal (Refer To Section 3, T-1b)

The Contractor shall maintain a temporary traffic signal installation, complete.

An installation shall consist of all equipment controlled by one local traffic signal controller including signal heads, two (2) or more per approach and any number of signal sections, wood poles with down guys, span wire cable, span wire accessories, tether wires, electric cables, the service installation, pedestrian signal heads and detectors, vehicle detectors, battery back-up (UPS) and other system equipment.

10.1.3 Flashing Overhead Mount Beacons (Refer To Section 3, T-2a)

The Contractor shall maintain a signal head(s), flashing beacon, overhead mounted, flasher controller in a housing and the complete span wire installation. The signal head shall consist of one (1) or more faces with any number of signal sections. The span wire installation shall consist of two (2) or more wood poles with down guys, span wire cable, span wire accessories, electric cable, ground rods, service installation, conduit, and handholes.

10.1.4 Flashing Low Mount Beacons (Refer To Section 3, T-2b)

The Contractor shall maintain a signal head(s), flashing beacon low mount, solar powered flasher (where applicable), flasher controller in a housing, ground rods, service installation, a traffic signal post, foundation, conduits and handholes. The signal had may consist of one or more signal sections mounted on the same object.

10.2 General Maintenance Responsibilities

The Contractor shall maintain all items listed in the System Description under routine maintenance, unless otherwise stated herein. Unless specifically noted, all work required herein this Article shall be paid through routine maintenance. Also refer to general response and maintenance requirements as listed in Article 5.0. In addition the Contractor shall:

- Maintain the IDOT inventory of traffic signal equipment on Microsoft Access software
- Maintain and update the EMCMS data for all traffic signal items
- Maintain a library of repair and operation manuals for equipment in the IDOT signal inventory
- Purchase and maintain up to date licensed software to operate and maintain all Closed Loop Traffic Signal Systems, Video and Detection Systems, and related management systems
- Purchase and maintain repair and testing equipment necessary to meet the response or repair time requirements of the Contract.
- Provide technical assistance at traffic signal inspections and maintenance transfers

- Provide two week inspections of the traffic signal system through Contractor provided staff of IMSA level II technicians
- Trim vegetation to provide visibility of traffic signals
- Relamp all 135 watt and 90 watt signal sections on a two year program. Relamp all 54 watt and 150 watt lamps annually. Relamp 40 intersections with LED type signal sections annually.
- Inspect all mast arm poles yearly and provide report on damage poles
- Inspect conflict monitors once every two years
- Inspect all railroad interconnected signals on the State highway System (even those maintained by others) on a yearly basis
 (This inspection shall be coordinated with members of the Illinois Commerce Commission (ICC) and the associated railroad companies.)
- Maintain the District’s Closed Loop Traffic Signal System (CLMS) as described in detail within this article. This includes monitoring and maintenance of any signals included in the Lake County, Kane County and any other County within Region One/District One Traffic Management Center (TMC). The Contractor or County, at no cost to the Department, will supply any new software required for the TMC. The signals within the TMC network will be monitored as described in the CLMS later in this Article. The necessary computer components (use of one or more PCs is anticipated) and one or more standard phone lines required to interface with the TMC are included in the CLMS. All CLMS requirements remain in effect for all signals transferred to this system.

10.3 Response And Repair Time Requirements

The Contractor shall respond to all malfunctions of the traffic signal system in a reasonable time. In addition to the daily routine and non-routine maintenance requirements of the traffic signal system, the Contractor shall provide sufficient manpower to respond to all notification of malfunctions on a 24-hour basis, 7 days a week. The Contractor is required to keep a time and date log of each response from the time of the initial report (ticket issuance) to the time of the final permanent repair. The Contractor is required to notify the Traffic Signal Engineer when any response time is not met.

Article 5.0 discusses general work requirements of routine maintenance for all systems. The following chart lists maximum response, service restoration, and permanent repair times, the Contractor will be allowed to perform corrective action on the Traffic Signal System.

ITEM	RESPONSE TIME	SERVICE RESTORATION TIME TIME	PERMANENT REPAIR CALENDAR DAYS
FAILURE/DAMAGE (any type) TO:			
CABINET	1 HR.	24 HR.	21 DAYS
CONTROLLERS AND PERIPHERAL EQUIPMENT	1 HR.	4 HRS.	21 DAYS
SYSTEM DETECTOR LOOP	1 HR.	NA	7 DAYS
ALL OTHER DETECTORS	1 HR.	NA	21 DAYS

SIGNAL HEAD/LENSES 1 HR.		4 HRS.	7 DAYS
AVIATION RED BEACON	1 HR.	4 HRS.	7 DAYS
MAST ARM ASSEMBLY AND POLE	1 HR.	4 HRS.	* 7 DAYS
TRAFFIC SIGNAL POST 1 HR.		4 HRS.	7 DAYS
CABLE/CONDUIT	1 HR.	4 HRS.	7 DAYS
INTERCONNECT/ TELEMETRY	1 HR.	4 HRS.	7 DAYS
GRAFFITI, REMOVAL	NA	NA	7 DAYS
MISALIGNMENT OF SIGNAL HEADS	1 HR.	4 HRS.	4 HRS.
CLOSED LOOP MONITORING SYSTEM	1 HR.	24 HRS.	14 DAYS
POST & POLES PLUMB VERTICALLY	NA	NA	21 DAYS
COMPLAINTS/CALLS/ CONTROLLER OR SYSTEM ALARMS/TIMING/PHASING/ PROGRAMMING	1 HR.	4 HR.	NA
PATROL TRUCK DEFICIENCIES	24 HRS.	24 HRS.	24 HRS.

* Mast arm assembly and pole must be set within 7 days after foundation repairs are completed or after a replacement pole and/or arm assembly become available. In the case of a new pole and/or arm assembly the Contractor must furnish a copy of the signed and dated delivery receipt from the shipping company. Temporary head placement shall meet the requirements of the MUTCD for driver visibility.

10.4 Repair of Signal Lamp/Module Outages

Signal indication and internally illuminated sign lamp outages must be replaced in the following manner:

Immediate corrective action must be provided if only one (1) signal indication remains in operation on an approach. This also includes left turn and right turn arrow indications if only one (1) signal indication remains in operation. If two (2) or more signal indications remain in operation for any given phase (movement) on any approach to an intersection, the replacement of the burned-out lamp, damaged socket, or damaged cable shall be accomplished within one (1) working day for red or red arrow indications and two (2) working days for all other indications following discovery and/or notification of the outage. Immediate corrective action must be provided for burned-out pedestrian indications and internally illuminated signs. The replacement of a damaged socket or damaged cable for a pedestrian signal indication or burned-out lamps in an internally illuminated sign such that the illuminated symbol is still identifiable must be accomplished within the next working day following discovery and/or notification. At the time of replacement of a burned out lamp or lamps, the reflector and lens shall be cleaned. All

replacement lamps shall meet the requirement of Article 10, Group Relamping of flashing beacon and traffic signal locations.

10.5 Signal Damage Equipment Replacement

Damage to flashing beacons or traffic signal heads requires immediate corrective action. Refer to Article 5 for EMCMS documentation requirements.

The location of a temporary or permanent traffic signal head installation shall meet the requirements of the Manual on Uniform traffic Control Devices and the following:

- The minimum acceptable signal display is two (2) far side signal faces directed toward the through traffic movements of each approach and two (2) signal faces directed toward any separate turning movement (where provided) on each approach pending permanent repairs, except where the distance from the stop line to the far side signal exceeds 45.75m (one hundred fifty feet) which requires a near right signal face to be in place.
- Signal faces on mast arm assemblies for through traffic on any one (1) approach shall not be less than eight (8) feet apart measured horizontally between center lines of face with a minimum mounting height of seventeen (17) feet above the crown of pavement surface.
- Locations where pedestrian signal indications are present one (1) pedestrian signal head must face each direction of a pedestrian crosswalk.
- A temporary signal face shall contain the same type, number, and size of lenses as the signal face being replaced. Twelve inch sections may be used to replace eight inch or nine-inch sections. LED modules should be replaced with LED modules of the same make to minimize performance differences, unless directed otherwise by the Engineer.

10.6 Power Outages And Flashing Operation Procedures

When repairs at a signalized intersection require that the controller be disconnected and power is available, the Contractor shall place the intersection on flashing operation. If there is no flasher, the Contractor shall install a temporary flasher in the controller cabinet. The signal shall flash red for all directions unless a different flashing operation has been directed by the Engineer.

At signal installations where power is not available, due to a power failure, or a flasher must be installed, the Contractor shall install at least one stop sign, Illinois Standard Sign R1-1-30x30 on each approach to the intersection as a temporary means of regulating traffic. The Contractor when installing temporary stop signs must switch the controller to the flashing operation when responding to a power failure. If the approach flash is yellow, the Contractor is not to place a temporary stop sign unless the flashing operation is changed to red by direction of the Engineer. The Contractor shall furnish and equip all vehicles involved with the maintenance of traffic signal installations with a sufficient number of stop signs to be erected as specified herein.

10.7 New, Revised or Transferred Traffic Signal And Flashing Beacon Inspections

The Contractor shall furnish a trained representative for each traffic signal inspection that requires a new or existing traffic signal installation to be added to the Contract or the transfer of an existing traffic signal installation of this Contract to another agency or contractor. Refer also to transfer requirements in Article 5. The Contractor shall:

- Analyze all induction loop detector loops at the controller cabinet insuring that each detector loop or set of detectors conforms with the Standard Specifications for Road and Bridge Construction and the District 1 Traffic Signal Specifications.
- Analyze the controller program provided by the controller manufacturer to insure that the phase and overlap designation on the traffic signal sequence drawing is provided correctly in the controller program and cabinet wiring drawings.
- Insure that the phase timings in the traffic signal controller are those provided by the Department.
- Assist in placing the traffic signal in operation by observing the signal display and checking of the conflict monitor while all vehicle traffic is stopped, and shall report any operational discrepancies or signal outages to the Signal Engineer immediately.
- Assist the Engineer in walking all approaches of the signal installation inspecting all traffic signal items for conformance with the Departments specifications for the project and aiming of the traffic and signal heads.
- Assist in the testing and adjusting of emergency vehicle preemption equipment. The Contractor shall insure that any time railroad preemption is in operation with emergency vehicle preemption that the railroad preemption has priority over the emergency vehicle preemption equipment.
- Assist in the testing and adjusting of UPS equipment
- Insure that the locations containing railroad preemption are programmed in accordance with the approved railroad preemption program and that all special lock out devices are operating.
- Be responsible for inspecting each location to determine the completion of construction punch lists as directed by the Signal Engineer. The punch lists shall be prepared and provided by the Engineer and the Contractor shall return written verification of punch list completion or non-completion.
- Upon request, review locations proposed for loop replacement in ongoing pavement resurfacing or grinding construction contracts.

10.8 Patrol Inspections

10.8.1 General Requirements

Unless otherwise permitted or requested by the Engineer, except for emergencies, the Contractor is required to schedule the IDOT traffic signal patrol routes the first portion of each workday and on the approved route day. Emergency services required by IDOT or other agencies shall be attended to immediately, however, any incomplete daily patrol shall be completed (by others or the original patrolman) during the normal patrol work week. This may require patrols after the normal workday has ended in order to complete the normal patrol workweek.

The Engineer shall be notified on a daily basis at the end of the Patrol workday of the following:

- List of all incomplete patrols for the day
- Specific reason for each individual incomplete patrols
- Plan as to how Contractor will make-up each incomplete patrols

All repairs not completed at the time of the patrol route inspection must be logged and turned over to Contractor's area supervisor. Repairs not completed at the time of the patrol route inspection are subject to

the time limits in Article 10. All Patrol records shall be maintained and submitted to the traffic signal engineer weekly.

The Contractor shall provide a sufficient workforce and equipment to patrol all flashing beacon and traffic signal locations. Each installation shall be patrolled and inspected every two (2) weeks for proper alignment of signal heads, lamp outages, visors, backplates, alignment of posts and mast arm poles, aviation obstruction lights, special traffic signal sections with red lenses and accompanying circular white halo lamps, shielding of optically programmed faces, and general operation of the traffic signal. The Contractor shall repair or replace all worn, missing or damaged components as specified herein.

The EMC Dispatch Center is required to keep a Patrol Route Maintenance Log, which includes the following information. Every Traffic Signal Patrolmen shall notify the EMC Dispatch Center of the following:

- Patrolman Arrival Time and Approved Route Inspection Location
- Patrolman Departure Time and Approved Route Inspection Location
- Time and Reason for Patrolman Departure from Approved Route Inspection Location and Name of Municipality or Agency requesting the emergency service (Example: Accident with damage and traffic signal full outage -- Cook County requesting the Emergency Service)

10.8.2 Routine Patrol Duties and Responsibilities

The Contractor's responsibilities shall include inspecting, repairing or replacing the following items:

- Align all signal heads, traffic signal posts, controller or service installation pedestals, mast arm assemblies and poles, and astro brackets. All poles, foundations, posts and astro brackets must be straightened to be vertically plumb.
- Check all anchor bolts for mast arm poles, signal posts, controller cabinets, and, in addition, all bolts used to attach the mast arm to the pole.
- Replace missing or damaged bolt covers, mast arm shrouds and handhole access covers. Tighten screws related to signal post base plates, backplates, anchor bolt covers, handhole access covers, service installation covers and controller cabinets. Repair or replace any failed or damaged signal components including signal controllers, cabinets or peripheral equipment, signal heads or mounting hardware, posts or mast arms, illuminated signs, detectors (vehicle and pedestrian), cable, conduit and other signal appurtenances which are part of a signal installation. Electrical grounds shall be maintained in accordance with the National Electrical Code.
- The Contractor shall at all times maintain stock of sufficient materials and equipment to make temporary and permanent repairs within the limits specified in Articles 5 and 10.
- The Contractor shall provide signal operating inspection tasks upon request such as:
 1. Inspect the timing operation of a signal installation at a specific time period and provide a recommendation for improving traffic flow
 2. Program timing parameter changes
 3. Determine the phasing or operation of a signalized installation
 4. Check the condition or verify the presence of equipment at a signalized location

5. Provide a copy of timing parameters in use at a signalized location
6. Provide recommendations to improve the safety or the operation of a signalized location
7. Provide a compiled list of all locations meeting a specified criteria

10.8.3 Controller and Cabinet Inspections

The Contractor shall provide a sufficient work force and equipment to inspect all controllers and cabinets as provided below:

- Once every four (4) weeks the patrol person shall visually inspect the inside of each controller cabinet. The visual inspection will include checking all timing intervals and time base coordination programs to insure all setting are correct including that the clocks are set to the same hour, minute and second at all locations within the time base coordination system.
- All detector amplifiers shall be visually inspected once every four (4) weeks to insure that the vehicle detectors are receiving vehicle calls and the calls are being placed into the Controller. Loop detector amplifiers with automatic vehicle identification necessary for bus preemption shall be inspected to ensure they are receiving vehicular phase calls and bus preempt calls; and the calls are being placed into the controller. Pedestrian push button detectors shall be tested by pushing each detector and watching for the related walk indication to appear.
- Equipment manuals, box prints and cable logs are to be maintained in each controller cabinet.
- GPS latitude and longitude coordinates of the controller cabinet shall be recorded or verified annually for use in the District's record retention system.
- Uninterruptible Power Supply (UPS) shall be tested once every four (4) weeks to assure proper operation of the traffic signals upon loss of normal electric utility power. Manual transfer and power loss transfer shall be tested which shall not put the signal in flash. Nominal output voltage and current along with battery string voltage shall be measured and compared to manufacturer's expected values.
- Railroad preemption, emergency vehicle preemption and bus preemption shall be tested during the cabinet inspection. All program settings and each sequence of operation shall be verified to be correct during each inspection.
- Emergency Vehicle Preemption equipment shall be tested during the cabinet inspection. All costs of repairing or replacing damaged or missing emergency vehicle preemption equipment is the responsibility of the local fire district or municipality and should not be reflected in the Contractor's bid price for routine maintenance items (maintaining the light detectors, light detector amplifiers, radio transmitters and receivers, antennas, confirmation lights, cables and/or related components). The Contractor shall notify the agency immediately that their pre-emption equipment is not operating and ask if immediate repairs are requested or if an estimate of repairs is necessary before repair work is provided. A copy of all WR Tickets, correspondence and invoices shall be provided in the monthly routine maintenance work documentation book.

10.9 Site Maintenance

The Contractor shall trim trees and bushes blocking the line of sight of the traffic signal face to the motorists. Line of sight standards are established in the Manual on Uniform Traffic Control Devices for Streets and Highways. All trimmed branches shall be legally disposed of by the Contractor off the right-of-way. An annual Tree Trimming Schedule shall be prepared by the Contractor and submitted to the Engineer for approval by October 1 of the contract year. The Engineer, at any time during the contract

year, may request trimming of trees or bushes in addition to the locations scheduled. This trimming must be completed immediately.

10.10 Group Relamping of Flashing Beacon and Traffic Signal Locations

10.10.1 Schedules and Reports

The Contractor shall replace all lamps at state maintained flashing beacon and traffic signal locations as described below. This work shall be completed between April 1 and August 1 of the contract year. All 135 Watt 12" signal lamps and 90 Watt pedestrian signal lamps shall be relamped in the first year of the contract, utilizing a two year bulb as described in the lamp specifications. All remaining incandescent lamps will be relamped annually.

The Contractor shall provide a schedule of all locations to be relamped by each relamping crew. This schedule shall be approved by the engineer. If more than one crew is used, each crew is to work within a different patrol route. Each relamping crew is to be equipped with the EMC Contractors two-way radio using the same frequency that all traffic signal maintenance vehicles use. The Contractor is to notify the Engineer, in writing, of his planned starting date. On the first day of relamping through the completion of relamping the Contractor shall include on the Daily Traffic Signal Agenda the following:

- Call number of each relamping crew leader
- The relamping route number, the week of the patrol route, the day of week in the patrol route and the intersection that the crew is starting from
- Upon completion of the relamping, lens washing and reflector washing, the Contractor shall furnish to the Engineer a completion report.

The schedule for the second year relamp program shall be approved by the Traffic Signal Engineer prior to commencement. Patrolmen will not be used for group relamping until routine patrols are completed. Documentation shall be provided to the Traffic Signal Engineer on a daily basis indicating what routes will be covered in the group relamping, what personnel will be used, and must also submit a statement of completion of routine patrol.

10.10.2 Daily Reports

At the completion of each day's work each relamping crew shall furnish a report indicating all locations which were relamped that day. The report must also indicate lenses that were replaced and lenses that require replacement that the crew did not have a supply of and must be replaced later. This written report must be sent to the Traffic Signal Engineer's office by email before 7:15 AM of the next working day. The starting location of a relamping crew may be revised at the direction or approval of the Traffic Signal Engineer.

10.10.3 Lens Cleaning and Replacement

The Contractor shall as a part of the relamping wash the reflector and inside and outside of each lens. Lenses that are damaged in any manner whatsoever must be replaced. This includes lenses that have discolored areas, holes, and arrow and pedestrian lenses that are peeling and light is visible in areas other than with the prescribed arrow or "Walk or Don't Walk " area.

The Contractor is required to replace damaged lenses for any part of the signal system as needed or as directed by the Engineer, regardless of annual or bi-annual relamp schedule.

10.10.4 Special Types of Lamps Required for Special Indications

All Aviation Red Obstruction Lights on traffic signal posts or mast arm assemblies and poles shall be relamped at the same time the traffic signal installation is relamped as part of the yearly traffic signal group relamping. The lamps used in the Aviation Red Obstruction Lights shall meet or exceed the requirements for the fixture's lamp set by the manufacturer of the fixture.

Special traffic signals sections with red lenses and accompanying circular white halo strobe lamps shall be relamped.

L.E.D. lamps shall be tested each year to determine the need for replacement. Replacement of L.E.D. lamps when determined to be necessary shall be paid as non-routine work or covered by manufacturer warranty. The contractor shall record for the Traffic Signal Engineer the manufacturer, model, and serial number of each L.E.D. module needing replacement. Routine repair of L.E.D. single outages and damaged equipment will be as described for other lamps elsewhere in this article.

10.10.5 Specification of Lamps

All incandescent lamps provided for relamping must have the current calendar year placed in the area containing the lamp's rating. The 150 watt special lamps for optically programmed signals and fluorescent lamps must be dated with indelible ink. The marking shall be on the back of the 150 watt lamp and on the left end of the fluorescent lamp. The lamps provided by the Contractor shall meet the following criteria:

- Twelve inch signal sections: 135 watts, 1650 minimum initial lumens, 16,000 hour lamp life with a two year warranty, 95% Krypton gas filled clear bulb, 3 inch light center (incandescent lamp). H&H Industries 135A21 or approved equal.
- Eight inch traffic or nine inch pedestrian sections: 54 watts, 530 lumens, 8,000 hour, 3 inch light center (incandescent lamp).
- Twelve inch pedestrian signal section: 90 watts, 1000 minimum initial lumens, 16,000 hour lamp life with a two year warranty, 95% Krypton gas filled clear bulb, 2-7/16 inch light center (incandescent lamp). H&H Industries 90A19 or approved equal.
- Twelve inch optically programmable section, 150 watts, 6,000 hours (seal beam)
- Fluorescent and other replacement lamps shall be replaced with a lamp of similar characteristics and wattage's. All fluorescent lamps shall be CAW/HO type.
- Aviation Red Obstruction Light lamps are to meet or exceed the recommendations of the fixture manufacturer.
- Special traffic signal section with red lens and accompanying circular white halo strobe lamps shall meet or exceed the recommendations of the fixture manufacturer.

10.10.6 Lamp Disposal

The Contractor's crew must relamp the entire intersection on the same working day. Old lamps shall be disposed of in accordance with the manufacturer recommendations and Environmental Protection Agency and requirements in Article 5.0 as stated herein.

10.10.7 Led Relamping

The Contractor shall replace all LED displays (intersection and pedestrian signals) at forty (40) state maintained traffic signal locations annually. The locations to be relamped are intended to be designated by the Engineer prior to March 1 of the contract year. It is intended that the Contractor complete the work within the calendar year.

Each intersection shall have a consistent make and model of LED display installed. Each LED display installed shall be labeled with the month and year of installation. The LED display shall meet all ITE standards and all relevant NEMA specifications. The existing LED display shall become the Contractor's property and the unit price should reflect the salvage value of these items.

10.11 Annual Conflict Monitor Testing Program

Conflict monitors shall be tested once every two years. One-half of the system shall be tested by December 31st of each year. The Contractor shall conduct a complete test of all conflict monitors or management malfunction units. The testing method shall be pre-approved by the Engineer and shall test all the features of the monitors or units as required by the Engineer.

Unless prior approval is given by the Engineer, all the above items shall be completed by the Contractor within the same working day at a single traffic signal installation. The Contractor shall provide a schedule for this work to the Traffic Signal Engineer. Any deviation from the approved schedule shall be approved by the Engineer.

The Contractor shall provide a final completion report listing all the signal installations with the date the work was completed and verifying that each item has been completed. The Contractor will be required to provide Progress Reports at the Traffic Signal Engineer's request showing the locations which have been completed to that date.

Conflict Monitors/ Malfunction Management Units shall not be replaced at railroad interconnected intersections without prior notification of the Traffic Signal Engineer.

10.12 Annual Mast Arm Assembly and Pole Inspection

The Contractor shall inspect all mast arm assemblies, mast arm poles and astro brackets (or other types of hardware) supporting traffic signal heads or pedestrian signal heads. (Also review Contractor Advisory Inspections in Article 5.0.)

This inspection shall be completed between April 1 and August 1 of the contract year and may be concurrent with the group relamping in Article 10.11 or done separately. The Contractor shall furnish schedules for this program a minimum of one week in advance of the start of work. The inspection shall be conducted in the same manner as described in Article 10.11, which requires reporting the Daily Work Schedule and follow-up documentation of the work. The inspection shall focus on the structural elements of the mast arm assembly and must include a close-up, arms length investigation of the following elements:

Mast Arm Pole	Mast-to Pole Connection Base Plate	Anchor Bolts
------------------	---------------------------------------	--------------

The arm of the assembly should be visually inspected at all signal head connections for any defects, such as cracks or buckles. The mast arm-to-pole connection should be inspected for significant loss of section, cracks in welds or base metal, and deterioration of the connection plates. The bolts of the arm-to-pole connection should be inspected for tightness and condition.

The pole should be checked for external corrosion, impact damage, perforation by rust through, and any discernible deflection, distortion or cracking. The pole should be closely checked for corrosion near the base plate, especially if mounted on a grout bed. The welds of the pole-to-base plate connection should be checked for cracks.

The base plate should be checked for any severe section loss or deformation.

The anchor bolts of the mast arm should be inspected to verify that the existing nuts are not loose or missing. The anchor bolts should also be checked for any corrosion or bending.

Upon discovery of any buckles, significant structural defects (loose nuts, severe corrosion or dents, cracks in welds, plates or structure, etc.), the Contractor will immediately notify the Illinois Department of Transportation at (847)705-4139 and take corrective action as directed by the Signal Engineer to insure the assemblies do not pose an immediate hazard.

The Contractor's crew must inspect the entire intersection on the same working day.

The Contractor shall provide the Engineer a completed form MA-1 or MA-2 (single or double mast arm assemblies), "Annual Mast Arm Inspection Report Form" for each Department maintained traffic signal mast arm assembly and pole inspected.

10.13 Annual Railroad Interconnected Traffic Signal Inspection

The Illinois Commerce Commission will conduct an inspection of all Department traffic signal locations, which are interconnected with railroad crossing flashing signal warning devices with or without railroad gates. Locations not maintained by the Contractor but under the District 1 route jurisdiction system are also included. The inspection shall be completed on an annual basis during the calendar year. In addition to the Contractor an inspection team may consist of personnel from the Department's Bureau of Traffic, the railroad responsible for the railroad crossing warning equipment, and the Illinois Commerce Commission. The signal engineer will schedule the inspection of each railroad interconnected location based on the availability of personnel from each involved agency.

The Contractor shall be responsible for making all necessary measurements as directed by the engineer. He shall determine all signal time intervals and controller settings, which pertain to railroad preemption. The sequences of operation shall be checked and the Contractor shall conduct all necessary tests. Any deficiencies or recommendations shall be reported directly to the engineer.

The Contractor shall maintain and update individual security software and proms for the approximately 150 railroad interconnected signals in District 1. These items shall remain under strict security and be transferred back to the Department at the end of the Contract. The Contractor shall at all times provide and maintain one (1) Eagle EPAC traffic signal controller and (1) Econolite ASC-2S, at a location to be approved by the Traffic Signal Engineer, loaded with District 1 approved security software, which can be used to replace damaged equipment in the field.

10.14 Detector Loop Maintenance and Replacement

10.14.1 Traffic Signal Loop Resealing

The Contractor shall reseal all existing traffic signal detector loop wire which has become exposed or as directed by the Engineer. The Contractor will clean all debris and damaged detector loop sealer from the existing saw cut. Loop detector wire that is exposed will be reinstalled into the existing saw cut and held in place by wedges prior to the resealing of the detector loop.

10.14.2 Detector Loop Replacement

The Contractor must replace all detector loops, which become inoperable. The cost of replacing the detector loop shall be part of Traffic Signal Routine Maintenance. Detector loops that are damaged by state forces shall be replaced and paid through a Non-Routine Authorization letter. A detector loop, which is milled out during a pavement resurfacing, will be replaced as part of the Department's resurfacing contract. The Department's Electrical Maintenance Contractor will be notified by the Engineer and dispatch a patrol person to the location to disconnect the loop detector cable from its terminals and place the affected phase or phases on maximum recall. At this time the Engineer will instruct the Contractor representative as to the maximum green time that is to appear for each of the affected phases.

System Detector Loops shall be replaced throughout the entire year. Non-System Loops, at the Contractor's option, between November 30th and March 1st, may be replaced by a loop or with a temporary microwave detector at no additional cost to the Department. The microwave detector shall be installed to provide adequate detection in place of the detector loop to the satisfaction of the engineer and it shall be removed and replaced permanently by a detector loop by March 31st. If the contractor is unable to install cable for the temporary microwave detector due to frozen or full conduits, with prior approval from the Engineer, the Contractor may temporarily span the cable overhead as long as proper clearances over the roadway can be maintained. No additional compensation shall be provided for microwave detector cable or for any special installation requirements.

At locations where the Contractor deems the pavement condition to be unfit to replace an existing inoperable detector loop with a new loop due to pavement deterioration, the Contractor shall, with prior approval from the Engineer, install a video detection system. The video detection system shall be installed in accordance with the specification "Video Detection System" under Non-Routine Work. The cost of providing and installing the video detection system complete including all necessary connections, monitors, electronics handhole drilling, trench and backfill, unit duct and restoration shall be included in routine maintenance of the traffic signal installation and no extra payment shall be allowed.

10.15 Video Detection

At the beginning of the EMC 2009/2010 it is estimated that District 1 will have approximately forty (40) intersections with video detection in operation. Video detection will increase each year. The Contractor shall provide license software for each of the System Patrolmen who have video detection in their respective area. The System Patrolmen shall be fully instructed in the operation and maintenance of each video detection system.

Two (2) of the video systems have a one mile microwave communications system linked to the Schaumburg IDOT headquarters. The Contractor shall provide qualified personnel who shall be familiar with the operation and maintenance of this system.

At the beginning of the EMC 2009/2010 it is estimated that District 1 will have thirty (30) tilt/ pan/ and zoom video cameras in operation. The Contractor shall provide licensed software for each of the Systems Patrolmen, which have this video in their respective areas. The System Patrolmen shall be fully instructed in the operation and maintenance of these cameras.

10.16 Integrated Closed-Loop Traffic Signal Monitoring System (Clms)

10.16.1 Contractor Responsibilities

The Contractor will, on a daily basis, monitor, review, and maintain the District 1 closed loop monitoring system. Refer to CLMS as described in Article 10.1. The Contractor shall use a local area network (LAN) computer system, with licensed software for each brand of master controller (used in District 1) to monitor the District 1 closed loop signal system. The LAN system shall communicate with each master through individual telephone lines. The LAN shall also be programmed to compare data bases with the Department's LAN at the District Headquarters in Schaumburg. The Contractor shall provide daily and monthly reports updating the status of the CLMS. The Contractor shall also provide licensed master software for all system patrolmen laptop computers.

A copy of the Official District 1 Closed-Loop Data Base shall be supplied to the traffic signal engineer at the termination of this contract. The data base shall also be digitally transferred to the next Maintenance Contractor at the termination of this contract.

10.16.2 Department LAN and Software Support

The Department shall be responsible for maintaining all Department owned Closed Loop Monitoring hardware.

The Contractor shall provide personnel who can demonstrate competence in the proper operation of all closed loop monitoring programs currently in use by District 1. The Contractor shall provide competent personnel for LAN maintenance and repair as defined in the definition of terms under Article 4.0 for specialty service. All costs to maintain daily communication between the Contractor's LAN and the Department's LAN will be included under routine maintenance.

10.16.3 Contractor Monitoring Duties for the CLMS

Each contract year, the Contractor shall purchase one (1) notebook CLMS Field Monitor which shall become the property of the Illinois Department of Transportation.

Prior to purchasing the Field Monitor, the Contractor shall contact the Traffic Signal Engineer to ensure that the following make, model, and options are still valid and meet the requirements of this specification:

- Lenovo ThinkPad T61 (including carrying case).
 - 80 GB memory
 - CD-RW/ DVD-ROM
 - 10 Hour Use with Three Batteries
 - Microsoft Windows Vista Ultimate standard software with MS Word and Access
 - Ethernet Connection
 - Intel Core 2 Duo processor T8100 2.1 GHz
 - Modem & Cell Phone
 - 15.4 WXGA TFT screen
 - USB to serial port converter

All of the above hardware and software are to be delivered and operational to the satisfaction of the Traffic Signal Engineer before the end of the first month of the contract.

10.16.4 Responsibilities

The Contractor shall concurrently monitor all Closed Loop Traffic Control Systems maintained by him under this contract on a 24 hour per day, 7 days per week basis. The Contractor's system monitoring functions shall include, but not be limited to, the reception of telephone calls from Closed Loop System Master Controllers and the storing, displaying, and acting upon any reported events, alarms, equipment failures, operational exceptions and programmed data collection. The Contractor shall have sufficient dedicated telephone lines, his own dedicated Close Loop Monitoring System(s) with appropriate software, and qualified electrical technicians to provide for the simultaneous monitoring of all closed-loop traffic control systems being maintained by him under this contract.

The Contractor shall program all Closed Loop Systems, so that he will receive all system alarms, events, and messages on his Central Closed Loop Monitoring System(s). The Contractor shall respond to all alarms, events, and messages and provide the indicated response or corrective action within the time frame specified in the "Response and Follow-up Time Requirements" listed under Article 10.3. The EMC Dispatch Center shall be equipped with the necessary equipment to receive all alarms, events, and messages as described above. Before the end of the first month of the contract, the Contractor shall submit a list of alarms, events, or messages that each brand of Closed-Loop System is programmed to send to the Contractor's dispatch center for approval by the Traffic Signal Engineer.

The Contractor shall maintain the integrity of the timings and programming information contained in the local controllers and the master controllers. The Contractor shall maintain each Closed Loop Traffic Control System in the mode for which it has been setup and programmed (i.e., Traffic Responsive (TRAP), Time-of-Day (TODD), FREE, etc.). The Contractor shall maintain his own data base of all the local and master controller timings, settings and programming information including graphic displays for intersections and systems. This data base shall be kept by him, at his place of business, for his own use in the normal course of system maintenance. The Contractor's data base shall be the Official District 1 Closed Loop Data Base. This data base shall also include Municipal and County maintained Closed Loop Traffic Control Systems that are on IDOT maintained routes. The Contractor shall insure data base agreement by synchronizing IDOT Schaumburg Headquarters data base with the Official District 1 Closed Loop Data Base.

The Contractor shall provide an Electronic Patrol of each master controller and its local controllers (including municipal and county maintained Closed Loop Traffic Control Systems on IDOT maintained routes) at least once every day, seven (7) days a week. This Electronic Patrol shall be done in addition to any field patrols done as part of Routine Maintenance. The Electronic Patrol shall document that all equipment is working properly and the timings and programming in each system have not changed from their correct values.

In addition, this electronic patrol shall include, but not be limited to, system loop checks (failed, maximum presence, and no activity), local loop checks (phases on recall, locked detectors), loops with system outputs (volume/occupancy checks), failed, Max presence, no activity, master controllers answering, local intersections on line (telemetry checks). Any exceptions found shall be reported to the Traffic Signal Engineer via facsimile by 8:00 AM every work day and corrected within the time frame specified in the "Response and Follow-up Time Requirements" listed under Article 10.3. The format and content required for this facsimile shall be approved by the Traffic Signal Engineer. Any discrepancies shall further be reported in the Closed Loop System Status Report.

All changes to Local or Master Controller programming shall have prior approval of the Engineer. Minor temporary changes to alleviate some sporadic operational anomaly will be acceptable provided it is done by a qualified electrical technician, and reported to the Engineer as soon as practical. It is anticipated that major re-programming will only be brought about through a comprehensive traffic study, optimization of timing effort independent of this maintenance contract. However, the Contractor may be required to effect (program) such timing changes in the closed-loop system masters and/or local controllers. The Contractor shall keep records of all changes to local and master controller data bases with the dates the changes were implemented and who authorized the changes.

The Contractor shall maintain a Closed-Loop System Operational Log accumulating in it the day to day operational information for our Closed Loop Traffic Control Systems. This log shall contain a listing of all program and mode changes that have occurred in each system and any anomalies to normal operation. The Contractor shall monitor this log for any persistent and recurring deviation from normal system operating modes and he shall report them to the Engineer as soon, as is practical. In particular, repeated cycle failures, loss of coordination, excessive pre-emptions or conditions that dictate manually commanded free operation shall be reported. In addition, the Contractor shall verify (at least once a week) that program changes in our traffic responsive Closed Loop Systems are occurring at normal times. This will insure that these systems are not oscillating between programs. This check will be considered part of the operational log. The operational log shall be maintained by the Contractor for the duration of this contract. The last 6 months of this log shall be available for inspection at any time and copies shall be provided the Engineer upon request. The format, content, and method used to keep the Operational Log shall be approved by the Engineer.

The Contractor shall maintain a Closed-loop System Failure Log for all Closed Loop system alarms, events, anomalies, and reported failures. It shall further contain the date, time of occurrence, the corrective action taken, a notation as to the cause, and a record thereon as to the repair time required to correct the malfunction. The System Failure Log shall be maintained by the Contractor for the duration of this contract. The last 6 months of this log shall be available at any time for inspection by the Engineer and copies shall be provided to the Engineer upon request.

The Contractor shall prepare a Closed-loop System Status Report every two (2) weeks. Copies of the System Status Report shall be forwarded to the Signal Engineer and the Signal Systems Engineer on the 1st and 15th of every month. The System Status Report shall describe the status of each closed-loop system being maintained by the Contractor under this contract and a summary of failures and alarms occurring within each system during the two (2) week reporting period. This report shall summarize the information contained in the. The Closed-loop Operations Log and the Closed Loop Failures Log System Status Report shall in addition highlight any equipment failures that were not attended to, repaired or brought back into

operation within the required time frame specified in the Repair Time Table and the reason for failing to meet the specified response/repair time schedule. The report format shall be approved by the Engineer.

The Contractor shall not make any timing or programming changes on any Closed Loop Systems or its components except through qualified electrical technicians.

Where applicable, to insure proper system operation and alarm reporting should the master controller ever go into backup, the Contractor shall maintain a location specific backup program in the backup PROMS of each Master Controller. The backup program in PROM shall duplicate the normal controllers programming as closely as possible. The Contractor shall be responsible for maintaining the backup programming and incorporating appropriate changes whenever normal programming changes are made at a Master or when directed to do so by the Engineer. Should a Master Controller ever need to be removed or replaced, the Contractor shall make the appropriate backup PROM switch with the replacement controller.

One month prior to the contract start date, the Contractor shall supply to the Engineer for approval, his proposal for the Closed Loop Monitoring System to be located at his place of business. The proposal shall include a detailed description of the proposed Closed Loop Monitoring System and a timetable for the installation of the system and components.

The Contractor shall assist consultants who are preparing Signal Coordination and Timing (SCAT) reports for the Department. This assistance shall be limited to a one-time download by the consultant of system timings with a qualified Contractor representative at the system location at the time of the download. Occasional operational questions by the consultants may also need to be answered by the Contractor as well as any required correction of items related to the maintenance of systems. In instances beyond these such as multiple requests for assistance in downloading system timing, programming errors which result in Contractor maintenance intervention, or multiple requests for assistance in programming, the Contractor will be allowed to bill the consultant. An itemized bill, including the date and system number, as well as the reason for the bill shall be submitted to the Traffic Signal Engineer in conjunction with the actual bill being sent to the consultant.

10.17 Traffic Signal Inventory

The Contractor shall complete the form "IDOT District 1-Traffic Signal Inventory" for:

- A new traffic signal installation added to the Contractor's maintenance.
- Maintenance of an existing traffic signal installation when it is transferred from another agency to the Department.
- Maintenance of a traffic signal installation, which had been under construction when it is accepted for maintenance by the Department.
- A change in inventory at an existing signal installation.

The Contractor shall provide an updated form with a revised date for all locations being accepted for maintenance even if there is no change in inventory items on the form (the date shall reflect the acceptance of maintenance). The Bureau of Traffic reserves the right to make minor modifications to the form such as adding or deleting items or modifying the format, but without changing the overall scope of the form.

Refer to Article 5.0 for Formal Transfer of Maintenance responsibilities.

The Contractor shall also be responsible for updating and maintaining the Access data base of traffic signal equipment inventory. The inventory shall be compared to field locations and corrections noted and submitted to the Signal Engineer at least once each year.

The Contractor shall record or verify the GPS latitude and longitude coordinates of the cabinet for use in the District's record retention system.

10.18 Painting By Others On State Maintained Facilities

Other agencies will be permitted to paint traffic signal equipment, utilizing their own forces, as approved by the Engineer. The Contractor is required to inspect the location, before and after the location is painted, as part of routine maintenance. Maintenance will not be transferred. The Contractor will document dates of painting in the dispatch log. If any damages are observed to IDOT equipment as result of the painting, the Contractor will repair immediately, and recover the expenditures through 3rd party damages. (Refer to Article 5.0 for 3rd party documentation/repair requirements.)

10.19 Traffic Signal Grounding And Electrical Service Upgrade

As part of routine maintenance of the Traffic Signal System, the Electrical Maintenance Contractor shall perform a grounding and electrical service upgrade to 200 traffic signal locations annually. The locations to be modified are intended to be designated by the Engineer prior to March 1 of the contract year. It is intended that the Contractor complete the work within the calendar year. In addition to the 200 locations to be modified annually under Routine Maintenance, the Engineer may designate additional locations to be modified. Work at additional locations will be paid as Non-Routine Maintenance. The Contractor shall include a progress report in the monthly routine maintenance work documentation book.

The Contractor is responsible for scheduling the work and for coordinating with the Engineer whenever Engineer-witness functions are required. The Contractor shall also advise the Engineer when each location is complete and shall provide a written certification to that effect. The Engineer reserves the right to require a final inspection of the modification at any or all of the locations certified as complete. Should deficiencies be found upon inspection, a corrective work list will be prepared. If progress of the work is inadequate, or if errors in certified complete work are repeatedly found, the Engineer may initiate withholding of routine maintenance payment.

The traffic signal installations being modified shall be kept operational at all times except as expressly allowed herein or otherwise permitted by the Engineer. The Contractor shall be responsible for all traffic control and temporary provisions required for the work, all at no additional cost to the contract. All cable, conduit, fittings and accessories shall be new. All materials and work shall be in conformance with the requirements of applicable contract specifications and standard details, Special Provisions and Article 250 of the National Electrical Code.

The Contractor shall be responsible for coordination with the Electric Utility as necessary and shall be responsible for reporting any account modifications arising from the work to the Engineer in a timely manner. Although it is anticipated that all service agreements and accounts will remain as-is, if new agreements are required, the Contractor shall facilitate coordination between the Electric Utility and the Engineer, with the Department to sign any appropriate new agreements. Only momentary outage of a traffic signal location undergoing modification will be allowed, and the contractor shall make temporary service connections as necessary to assure continuity of operations as modifications are made.

The work will generally include:

- Replacement of the electric service entrance equipment and cables
- New grounding of the service
- New feeder conductors from the service disconnect to the controller cabinet
- Cabinet grounding modifications
- Extension of equipment ground wires to all poles, posts, handholes, etc.
- Bonding of equipment ground to all exposed metal parts
- Testing and documentation

Replace Electric Service Entrance

The work shall include the removal of the existing service disconnecting means and the service conductors and shall include the furnishing and installing a new pole-mounted service disconnecting means and new

service conductors, based on the manner of the existing service. The new electric service disconnect, cables and the service connection shall be in accordance with details included herein.

The pole-mounted electric service box provided for these installations shall be Type A1 (equipped for 240/120V, 3W service, but with space only for the lighting main breaker), figure to be furnished by the Engineer, or unless specified otherwise by the Engineer to meet special requirements of certain locations, such as the proximity of pedestrian traffic, etc.

The pedestal mounted services boxes shall be the same as the pole mounted assembly, but with the following differences:

- The Contractor may re-use (with Engineer's permission) the existing pedestal mounted enclosure, but with new internal equipment as shown in Fig. L-3A. New enclosure, if used, shall be as approved by the Engineer.
- New pedestal-mount enclosures shall be NEMA cast aluminum with integral keyed lock assembly as approved by the Engineer
- The service conductors in the pedestal shall be installed in a liquid tight flexible metal conduit, secured at both ends, with bushing at both ends

Provide New System Ground of Electric Service

The work shall include the installation of a new system ground, connected to the ground bar of the service disconnect, using one or more ground rod grounding electrodes, or other means approved by the Engineer. The system ground shall have a resistance to earth not to exceed 10 ohms without connection to the additional electrodes established at poles or other points at the traffic signal location. The system ground resistance shall be verified by a contractor test, using the fall-of potential method and witnessed and approved by the Engineer, with a record of the test entered by the Contractor and signed by the Contractor and the Engineer. Should more than one electrode be required to establish a low enough resistance, additional electrodes shall be connected to the grid, with re-testing. All ground electrode connections shall be exothermically welded. Ground rods and grounding electrode conductors shall be as specified and detailed.

The service grounded circuit conductor (which may or may not be a system neutral) shall be bonded to the system ground at the service disconnect and shall be isolated from ground throughout the remainder of the electrical distribution.

Extend New Conductors to Controller

A new ground terminal bar shall be installed at the traffic signal control cabinet and this bar shall be bonded to the cabinet enclosure. The work shall include the replacement of the existing feeder and the extension of new feeder conductors from the service disconnect to the traffic signal control cabinet. The cable will be a multi-conductor jacketed cable as specified and it shall include a green-insulated ground wire to bond the service ground bar to the controller cabinet ground bar. The contractor shall confirm the integrity of the existing feeder conduit run, and shall clean the run before installing the new feeder. If the size of the conduit is demonstrated to be inadequate for the new feeder cable or if it is demonstrated as not re-usable for some other reason and no other alternative is feasible, the Engineer will authorize a new feeder conduit run, paid as non-routine work, with all cable work remaining as the Contractor's responsibility at no additional cost to the contract.

Cabinet Grounding Modifications

The Contractor shall confirm the presence of a terminal bar, with suitable terminals, for the grounded circuit conductor (white wire) at the controller cabinet and shall assure isolation of this bar from the cabinet enclosure and other grounded parts. If the existing bar is inadequate or is not isolated properly, the Contractor shall provide a new bar or otherwise correct the installation, removing any incorrect items. Similarly, the Contractor shall confirm the presence of a ground bar, with suitable terminals, which is

bonded to the cabinet enclosure and grounded metal parts. If the existing ground bar is inadequate or is not bonded properly, the Contractor shall provide a new bar or otherwise correct the installation, removing any incorrect items.

Extension of Equipment Ground

The Contractor shall extend an equipment ground conductor from the ground bar in the controller cabinet to distributed elements of the system, bonding the equipment ground conductor to all handhole frames, handhole covers, metal poles and other enclosures, metal conduit, etc., including any existing supplemental ground rods that may be in place. The Contractor shall assure that good equipment ground continuity and a low-impedance ground return path is established throughout for all exposed metal parts of the installation.

It is not the intent of this work item to require re-cabling of the traffic signal load equipment to achieve grounding. In all cases, a green-insulated ground conductor shall be used whenever possible, and only if conduit space will not accommodate an insulated conductor will a bare conductor be allowed. A common conductor may be employed for multiple load circuit cables in a given conduit, but an equipment ground conductor shall be run with or shall encircle each set of circuit conductors extended from the controller cabinet.

Recognizing the intent to leave existing conductors in place and operational, the Contractor may choose from among identified and prioritized acceptable alternatives to affect the grounding modifications:

- If an existing conduit will accommodate the installation of a ground wire, the ground wire shall be installed within the conduit with the circuit conductors. Existing conductors should only be withdrawn from a conduit run to facilitate pulling of the ground wire if absolutely necessary.
- If an existing metal conduit will not accommodate the required ground wire, and if the Contractor can identify end-to-end electrical continuity of the conduit, the Contractor may bond to the conduit externally in an approved manner to establish ground continuity, thus using the metal conduit as the equipment ground conductor.
- If a given conduit run is demonstrated to be damaged and electrically discontinuous in the presence of the Engineer, and if no other alternative is feasible, the Engineer will authorize a new conduit run, to be paid as non-routine work, with all cable installation to remain part of the grounding modification work at no additional cost to the contract. When a new conduit is installed, an insulated ground conductor must be installed within, together with the circuit conductors, regardless of the ground continuity of the new conduit, and the new conduit shall be appropriately bonded to the equipment ground.

Bonding

The Contractor shall establish equipment ground bonding to the cover frame of every handhole with an approved connection. The Contractor shall establish equipment ground bonding at every metal pole, post, handhole cover, handhole frame, or other enclosure or device, with an approved connection. At poles or post bases, it may be possible to install washers, lugs and extra nuts where extra anchor bolt protrusion allows it. Otherwise, poles may be drilled and tapped and fitted with appropriate ground lugs. Connections at poles and other enclosures shall be pigtailed from splices whenever more than one ground conductor is connected so that ground continuity is not dependent upon ground lug connections. Splices of ground conductors (in lieu of exothermic weld connectors) will be permitted at poles and other such connection points above grade, with splices to be made using suitable copper crimp sleeves and heat-shrink insulated caps as specified.

Testing and Documentation

As noted above, the system ground resistance to earth shall be tested, in isolation from equipment ground extensions from that point. Testing shall be performed by the Contractor using the fall-of-potential method, with results recorded by the Contractor and witnessed by the Engineer. Ground continuity shall be tested using an approved low-impedance ohmmeter, to the farthest point of

each circuit extension from the controller cabinet. Results shall be recorded by the Contractor and witnessed by the Engineer.

Special Considerations

Temporary signal installations and other span-wire installations shall be included in the scope of service and grounding modifications. For span-wire installations, the messenger wire shall be employed as an equipment ground conductor and taps shall be made to this wire to extend an equipment ground connection to appropriate exposed metal parts. A service grounding electrode shall be established at the electric service disconnect and a ground rod shall be installed and connected at one pole per quadrant.

10.20 Railroad Insurance

The Contractor shall obtain railroad protective liability insurance coverage for performing non-routine work relating to the installation of new traffic signal facilities on railroad R.O.W. where the Department has no existing appurtenances, e.g., railroad interconnect, railroad structure mounted traffic devices, etc.

10.21 Non-Routine Maintenance

Refer to Section 2 to review Special Provisions for non-routine work pay items.

10.21.1 Non-Routine Work in the Railroad Right-Of Way

The Contractor shall be responsible for obtaining any necessary permits as required by the railroad for any non-routine work to be performed on the railroad Right-of-Way. The Contractor shall also be responsible to coordinate all activities between the Department and the railroad.

The Contractor shall be responsible for completing any required forms and shall coordinate all activities between the Department and the railroad. Any fees associated with obtaining the permit shall be paid by the Department in accordance with Article 109.05 of the Standard Specifications for Road and Bridge Construction, as modified and noted in Article 5.0.

10.22 Logs and Forms

A sample of logs and forms as required for this Contract will be available at the Pre-Bid Meeting.

Article 11.0 -- Extra Systems

11.1 Extra Systems Description

The Extra Systems consist of various types of equipment at various locations as described herein. The Contractor shall maintain the equipment at these locations under routine maintenance, unless specified as paid through non-routine maintenance.

11.2 Inspection Of Service Entrance And Feeder Panels

The service entrance and feeder panels, as described herein, at the District 1 facilities, which includes the Highway Maintenance yard, Rest Area and Weigh Station. The Contractor shall perform the preventive maintenance work at one (1) facility per month and complete the X-2 log sheet. The Contractor shall submit a copy of X-2 log sheet to the Engineer in the monthly routine submittal book.

- A. Clean enclosure and control equipment by blowing out with low air pressure or vacuuming
- B. Check and clean contacts, relays and timers and visually inspect for damage or out of adjustment parts. Remove all dust off of electrical devices and equipment
- C. Circuit breaker maintenance:
 - Check connections
 - Exercise breaker
 - Check trip setting
- D. Inspect wiring/conductors for overheating and discoloration
- E. Check tightness of wire terminations and connections
- F. Check for proper labeling, provide and install missing labels
- G. Check wire tags/labels, provide and install missing tags or labels
- H. Check fans for proper operation and clean filters
- I. Check fuse disconnects for proper operations, keep fuse clips clean and tight
- J. Check fuses for proper size, and overheating
- K. Test equipment ground system of the station

Create tickets for any deficiencies found on this inspection and enter the numbers on the inspection report.

11.3 Generator Inspection

The Contractor shall maintain the generator and perform scheduled inspection under routine maintenance at the Base Stations, Moveable Bridges, Fiber Optic Nodes, IDOT ComCenter, Rodenburg Yard, and Traffic System Center.

Monthly Generator, Transfer Switch and Alarm Panel Inspection

The Contractor shall inspect the engine generator once per month as described in Article 8, using log form P-10, and insert in the log book. Tickets shall be created for any problems found. The date of the inspection shall be listed on the daily agenda. The Contractor shall submit the inspections to the Engineer in the monthly routine submittal book.

Yearly Generator Inspection

The Contractor shall inspect the engine generator yearly in the month of October as described in Article 8, using log form P-10, and insert in the log book. Tickets shall be created for any problems found. The date of the inspection shall be listed on the daily agenda. The Contractor shall submit the inspections to the Engineer in the monthly routine submittal book.

11.4 Locations

The system includes the following locations:

11.4.1 Base Stations

The equipment under maintenance at the locations include: back-up generator, transfer switch, electrical service feeder cable, distribution panels, gas detector systems, doors, buildings, roofs, fencing, gates, windows, locks, flashing beacons, PS SCADA system repeater radio, AEGIS alarm systems, antenna, antenna line, back-up battery, diagnostic board, and all other equipment and appurtenances owned by the State of Illinois and under the jurisdiction of the Department. The tower and hut site maintenance shall be performed in accordance with Article 8.3, except for snow removal, which shall be handled by IDOT personnel.

Monthly Beacon Inspection

The lighting night-rider shall inspect the beacon lights on the monthly patrol. Refer to patrol procedures as found in Article 5.0. Outage repairs for the tower beacon lights shall be restored within 24 hours of notification at all base stations and Illinois State Police locations. The replacement of lamps shall be paid through non-routine maintenance pay item. The Contractor shall carry spare parts inventory on hand to restore the lighting within the specified time.

Quarterly Radio Tower Site Inspection and Maintenance

The Contractor shall inspect the radio tower for any visual defects on tower structure, guying system (where applicable), lighting and monitoring system (where applicable), antenna, co-axial lines and wave guides, grounding system, site appearance and general condition, fencing and gate as per the FCC Title 47 Sec. 17.47. Tickets shall be created for any problems found. The date of the inspection shall be listed on the daily agenda. The Contractor shall submit the inspection report using Log-X2 to Engineer in the monthly routine submittal book. The contractor shall clean the communication hut, shall keep the equipment free of dust and shall wet mop the floor with water and biodegradable cleaner. Following equipment manufacturer's recommendations, compressed air and/or soft cloths shall be used to remove the build up on the equipment. The work shall be performed in conjunction with other patrols and other inspections, but should be scheduled on the same week of the quarter for the duration of the Contract.

11.4.2 Bridge Monitoring

The equipment under maintenance at the locations include: closed circuit television cameras, monitors, generators and transfer switches, alarm panel and appurtenances, interconnecting coaxial cables, navigation lighting, highway lighting on the bridge, river traffic controls, conduit wiring, circuit breakers, incoming electrical service feeder cable and all appurtenances located on various moveable bridges in the Illinois waterway in or near to Joliet, Illinois.

The routine maintenance for CCTV equipment includes response and investigation of trouble calls, deficiencies and abnormalities of monitor and or other miscellaneous items less than \$250 each in value.

Monthly CCTV Inspection

A certified closed circuit video service technician shall perform a monthly inspection of the Bridge Monitoring CCTV and associated equipment at all locations and list problems found, or no problems found. The IDOT Moveable Bridge Office Engineer shall receive the original copy of the technician's monthly inspection, and the Contractor shall submit a copy to the Engineer in the monthly routine submittal book. The lighting night-rider shall inspect the bridge and navigation lighting on the monthly patrol, refer to patrol procedure as found in Article 5.0.

11.4.3 EMC Dispatch Center Location

The equipment under maintenance at the location include:

- Lighting SCADA System (equipment owned by IDOT):
One (1) server and monitor, all software including OS, GUI software, FIU cabinet, SCADA CPU's, dedicated line and dial-up modems, radio power supplies and back-up batteries, rocket port, printers, radio concentrators, four VHF/UHF radios, portable UPS, batteries, and all other equipment and appurtenances

- PS SCADA System (equipment owned by IDOT):

AB RSview server computer (hardware & software), dedicated lines and dial-up modems, computer monitor, printer, radio base station equipment, rocketport multi-serial board and cables, batteries and all other equipment and appurtenances

- Traffic System Conflict Monitor Alarm System
- AEGIS Alarm Equipment, IDOT or EMC owned

Repairs to EMCMS (Electrical Maintenance Contract Management System) Equipment

Refer to Article 4

Yearly Lighting SCADA Inspection

Replace the lithium battery in each CPU of the FIUs and the back-up battery pack in each FIU of the lighting SCADA system, by April 2009. Each FIU has ten CPUs. The lithium batteries are recommended to be replaced every three years and the battery packs are recommended to be replaced every two years. The Contractor shall submit catalog cuts of the replacement battery packs for Engineer's approval, prior to installation.

11.4.4 Fiber Optic Network Locations

Description

The fiber optic backbone consists of fiber optic nodes, as listed in Section 3, located along the expressway system and at other locations in District 1 for the transmission of video, data, and control signals around District 1 and to provide interconnection points to other governmental agencies. The nodes include nodal buildings and nodal cabinets. The Contractor shall maintain, under routine maintenance, fiber optic cables at each node, patch panels, fusion splices, cabinets, nodal buildings, raceway systems, and splice enclosures of the fiber optic interconnect cables located at the remote facilities. The drawings showing the various nodes and the fiber optic interconnects will be made available to the prospective bidders and to the Contractor upon request.

General Maintenance Responsibilities

The Contractor shall be responsible for record keeping of all equipment and labeling at each node. He shall maintain a log book at each node and a list of all users of the fiber optic cable at each node and update the information after each new assignment made by the Engineer. The Contractor shall insure that all fiber strands and connectors are properly tagged and labeled at each end, and shall tag that they conform to the Department's labeling scheme. Any deficiencies/abnormalities shall be brought to the attention of the Engineer and a corresponding ticket shall be generated.

Fiber Optic Cable Management System

General.

The cable management system is used to document and manage horizontal and backbone cables, hardware, assets, pathways, locations, contacts, and detail equipment connections. It facilitates the importation of test results, attach drawings, photos and documents, create a contact directory, and cable label creation.

Hardware and Software Used.

- Server: Dell Power Edge 2900
- Brady: Network Documentation and Cable Management Software
- Microsoft SQL Server 2000

Support.

Technical support for the software and the server from a manufacturer authorized and approved vendor, at no additional cost to the state, shall be provided for the entire duration of this contract and any subsequent contract extensions or renewals. The support shall include product upgrades, phone and email support. Technical Support representatives shall be available between the hours of 7:00AM and 5:00PM CDT.

Data entry.

The EMC shall perform the data entry of all changes to the existing fiber optic cable system in accordance with the D1 Standard Cable Designation Scheme which is available for review upon request.

Fiber Optic Cable Repairs

For transmission troubles found in the “live fiber” (fiber in use) during normal operation, the Contractor shall test the affected fiber, as necessary, to determine the source of the problem. In such cases, the Engineer may direct spot checking or complete checking of all fibers in the affected run, if the problem is suspected to be systemic to the run. Before testing of any live fibers, the patrolman shall coordinate with the users of the fiber run. After the completion of testing, but before leaving, the patrolman shall verify with the users that all video and telemetry data transmission is still working. The patrolmen shall not leave the nodal building until all user groups have checked the accuracy of data being received and video picture quality.

During any of the testing, if any fibers are found to have significantly degraded from original or most recent OTDR readings, the patrolman shall initiate a ticket to prompt further troubleshooting of the fiber. The Contractor shall check all optical connectors, all patch cords, fusion splices, and splice enclosures within that fiber run to determine where the degradation has occurred. The Contractor shall make necessary repairs to restore the system to its original operating parameters.

If a problem is found to be with an individual live fiber in the fiber run, the Contractor shall re-assign the user on the defective fiber to another fiber in the run upon approval by the Engineer. The Contractor shall test the defective fiber to identify the location of the problem. If it is found to be in accessible location, the Contractor shall repair/re-splice the fiber to restore to its original condition.

If connector appears to be damaged, the Contractor shall repair or replace optical connector in the following manner:

1. If it is a patch panel which has bulkheads with pre-connectorized pigtailed and its optical connector is damaged, the entire pigtail shall be replaced with a new patch cord substituted for the pigtail and fusion-spliced to the trunk cable.
2. If the patch cord optical connector is damaged, the Contractor has the option of replacing the patch cord or replacing the damaged optical connector with a new Camlite or equivalent ST connector for single-mode fiber.
3. If it is a patch panel, where the trunk cable was field-terminated with Camlite or equivalent connector, the Contractor shall replace in kind.

If the bulkhead is damaged, the Contractor shall replace the bulkhead in kind.

If the optical performance has diminished due to degrading of an existing splice, the Contractor shall replace the bad fusion splice in kind. If the fiber optic trunk cable is damaged due to a broken wall, the Contractor shall clear, determine the problem and perform temporary repairs, to restore the system affected within twenty-four hours, under routine maintenance. The Contractor shall repair or replace the damaged section of cable from nearest upstream to downstream hand hole or junction box, as directed by the Engineer, under routine maintenance. The Contractor shall submit catalog cuts of all replacement material for approval by the Engineer.

All permanent repairs shall be completed within sixty days from the date of the damage or incident, unless approved otherwise by the Engineer.

All motorist caused damage shall be recorded per requirements of Article 5.9.5. All crew documentation shall be submitted to the Engineer upon request. The Contractor shall receive partial payment for repair work where unit prices are applicable. When requested by the Engineer, the Contractor shall submit an MCHD statement prepared from the crew documentation, as an EMCMS MCHD Log is not applicable.

Monthly Testing and Inspection

The Contractor shall patrol the fiber optic network once per month and shall use log F-1, to document the following information in the log book at each termination or node:

- Fiber interconnect name
- Arrival time
- Cabinet number
- Check patch panels and ensure rubber boots are in place
- Check operation of T1 digital channel bank
- Check power supply voltages
- Record departure time

If any problems are found during the inspection, the Contractor shall generate tickets and perform repairs as described herein. The inspection reports shall be included in the monthly routine maintenance book.

Yearly Testing and Inspection

The Contractor shall annually test 10% of all, randomly chosen, “dark” fibers (fibers not in use), end-to-end, with a laser light source, a power meter and an OTDR at both 1310 and 1500 nm wavelengths. The annual testing shall be performed in spring of each year, unless approved otherwise by the Engineer. The results of the traces shall be submitted to the Engineer in the monthly routine maintenance book. The test procedure shall comply with ANSI/TIA/EIA-569-A, Annex H, “Optical Fiber Performance Testing” and with ANSI/TIA/EIA-526-7, “Method 1: Optical Power Loss Measurements of Installed Single Mode Fiber Cable Plant.”

Yearly Cleaning

The connectors of all live fibers, with data and/or video transmission, shall be cleaned with an approved alcohol cleaner. The bulkheads and fibers shall be cleaned to remove dust and dirt build-up. While the optical connector is disconnected for cleaning, the Contractor shall check each connector with a fiber optic microscope. The fiber optic microscope shall be capable of accepting ST and SC connectors. The Contractor shall check the connector for the following conditions:

1. Sever fracture (both core and cladding layers are fractured)
2. Cladding fracture
3. Light scratches and blemishes

The Contractor shall inform the Engineer prior to scheduling the test in the spring of each year. The test data shall be noted on the daily agenda. Test results shall be submitted to the Engineer in the monthly routine maintenance book.

11.4.5 Highway Advisory Radio Locations

The equipment under maintenance at the locations include: INTRAC radio receiver, FM radio transceiver, flasher/load relays and all electrical control apparatus, cabinet, conduit wiring, circuit breakers, flashing amber beacons (signal heads), HAR antennas, foundations, incoming electrical service feeder cable, and all other equipment and appurtenances.

Repairs

If a radio is found to be defective, the Contractor shall replace it with a spare radio from the Contractor’s stock, programmed to the same specifications as original radio, until the original radio is repaired by qualified Contractor or Specialty Service personnel.

Monthly Inspection

The Contractor shall inspect each H.A.R. location, once per month, in the last week of the month, to assure proper operation of their intended service. The inspection shall include checking radio equipment for clarity, proper beacon operation, verifying data burst, dusting or cleaning equipment as necessary, and/or

opening each controller and radio enclosure and cleaning if necessary. Data shall be recorded on log form X-1, H.A.R. and Ice Beacon Monthly Inspection. The date of the inspection shall be listed on the daily agenda. The Contractor shall submit a copy of the X-1 log form to the Engineer in the monthly routine submittal book. The Contractor shall create tickets for any problems found.

11.4.6 Highway Maintenance Yard Facility Locations

The equipment under maintenance at the locations include: all indoor and outdoor lighting and its control equipment, underground or aerial feeders, indoor and outdoor GFIC outlets, salt dome storage lighting, control box, motor and pump for asphalt heating tank and electrical equipment for calcium chloride spray pump.

The routine maintenance for inside electrical systems and the lighting equipment includes response and investigation of trouble calls, deficiencies and abnormalities of miscellaneous items less than \$250 each in value for materials. The labor and equipment necessary are part of the routine maintenance.

Yearly Lighting Clock Control Inspection

The Contractor shall inspect the lighting control clocks, as per Article 7.

11.4.7 Highway Rest Area Locations

The equipment under maintenance at the locations includes exterior and interior lighting (plus lighting inside public washrooms), and all panels, controls and outlets.

Monthly Inspection

The lighting night-rider shall inspect the rest areas exterior and interior lighting on the monthly patrol. Refer to patrol procedures as found in Article 5.0.

Yearly Lighting Clock Control Inspection

The Contractor shall inspect the lighting control clocks, as per Article 7.

11.4.8 Ice Beacon

The equipment under maintenance at the locations includes: SCADA radio receiver and electrical control apparatus, cabinet, conduit wiring, flashing amber beacons (signal heads), and all other equipment and appurtenances.

Monthly Inspection

The Contractor shall inspect each Ice Beacon location, once per month, in the last week of the month, to assure proper operation of their intended service. The inspection shall include checking radio equipment for clarity, proper beacon operation, verifying data burst, dusting or cleaning equipment as necessary, and/or opening each controller and radio enclosure and cleaning if necessary. Data shall be recorded on log form X-1, H.A.R. and Ice Beacon Monthly Inspection. The date of the inspection shall be listed on the daily agenda. The Contractor shall submit a copy of the X-1 log form to the Engineer in the monthly routine submittal book. The Contractor shall create tickets for any problems found.

11.4.9 IDOT Facilities

The equipment under routine maintenance at the locations includes: outdoor lighting and its control equipment, underground cable, conduits and GFIC outlets.

Traffic Operations Field Office

The equipment and appurtenances, to be maintained, include:

- Lighting SCADA Equipment
 - 1 Windows NT client computer
 - 1 Monitor

- 1 Multi Tech DED line modem
- 1 Portable UPS
- 1 GUI Software
- 2 Engineering Processors
- Software as applicable
- UPS and all other appurtenances

- EMCMS System Equipment
 - 6 Compaq Desk Pro or equivalent work station
 - 2 HP JetDirect 500x Print Server
 - 2 EPSON LQ-2550 or equivalent Dot Matrix printers
 - 1 Cisco 1700 or equivalent Router
 - 2 Cisco 1548 or equivalent Switch
 - 1 56 K Modem
 - 1 24 port interface patch panel

- Pump Station SCADA Equipment
 - 1 Dell 2000 client computer
 - 1 Monitor
 - 4 Engineering processors
 - Windows Operating systems
 - Software as applicable
 - UPS all other equipment and appurtenances

- AEGIS
 - 1 Silent Knight digital alarm receiver Model 9000
 - 1 Printer

Repair to EMCMS (Electrical Maintenance Management System)

Refer to Article 4

District 1 Headquarters/ComCenter

The equipment under maintenance at the location includes:

- The Lighting SCADA Central System
 - One server and one client computers, monitors, OS, GUI software, SCADA Application tool box (software), FIU cabinet, SCADA CPU's, lighting monitor (night-lite), dedicated lines and dial-up modems, Comtegras, radio power supplies and back-up batteries, rocket port, printers, radio concentrators, portable UPS and all other equipment and appurtenances

- Pump Station SCADA Central System
 - AB RSview (Development) server computer (hardware & software), dedicated lines and dial-up modems, computer monitor, printer, radio base station equipment, rocketport, multi-serialdigi-8 board and cables, 3Com 16 port switch, Windows Operating systems, all other equipment and appurtenances

- Dynamic Message Remote System:
 - One (1) remote status terminal, monitor, video controller including firmware (software), one (1) remote terminal with 486 CPU, modems, utilities services (including all taps, terminations, conduits, and cabling interconnect), and all other equipment and appurtenances

- ATMS Workstations in ComCenter, in Expressway Engineer office and in Oper. Eng. office.

- ComCenter Equipment:
 - 13 - Plasma Screen Monitors and appurtenances

-
Christie Video Wall Controller and Displays (and for the Christie display system at TSC in Section 9.1.4) – In addition to providing response and investigation of trouble calls/deficiencies/abnormalities, perform the following periodical maintenance, under routine maintenance, by a factory certified technician, in January and September of the first year of the contract and again in May of the second year of the contract, if renewed:

- Clean lens, cube screens, cube enclosure and events
- Replace lamps in all displays
- Realign (6 axis adjustment) after lamps are replaced
- Check and adjust color
- Check white balance and black level
- Reset lamp timers
- Check horizontal and vertical position
- Check brightness, contrast, and dither

In addition, the contractor shall replace lamps, as needed, between the scheduled group relamping dates, perform repairs and replace other items less than \$300 each in value.

7 - Dispatcher Work Stations

7 - EMCMS Work Stations

- EMCMS System Equipment
 - 1 Sun OS
 - 2 Compaq Server
 - 1 Compaq Development Work Station
 - 1 Cisco Router
 - 4 Cisco Switch
 - 1 56 K Modem
- EMCMS Equipment:
 - 10 Compaq Desk Pro work stations
 - 3 HP JetDirect 500x print server
 - 2 HP Laser Jet Printer
 - 3 Epson LQ-2550 Dot Matrix Printer
- Generator and its transfer switches, alarm panels and appurtenances
- UPS, its transfer switch, and Station Battery
- 12 VDC Station Battery and charger, RF Transmitter
- HVAC for ComCenter room:
 - Trane Air Conditioning model SWUA-2006-MAV, Type 671-0530-40A, and Serial no. L85B26255, Compressor motor, fan motor and wall thermostat

Monthly Battery and UPS Inspection

The Contractor shall inspect the batteries of the UPS Systems, and RF transmitter once per month. Water levels shall be checked, add if necessary. Connections shall be cleaned and tightened if necessary. The date of the inspection shall be listed on the daily agenda. Tickets shall be created for any problems found.

Monthly ComCenter HVAC Maintenance

The maintenance of the ComCenter HVAC equipment includes response and investigation of trouble calls and repairs/replacement of items less than \$300 in value. Repairs in excess of \$300 in value shall be paid under Article 6.1.3, upon Engineer's approval.

The service technician shall provide a list of problems found, or no problems found. The IDOT ComCenter Supervisor shall receive the original copy of the technician's monthly inspection, and the Contractor shall submit a copy to the Engineer in the monthly routine submittal book.

Yearly Lighting SCADA Inspection

Replace the lithium battery in each CPU of the FIUs and the back-up battery pack in each FIU of the lighting SCADA system, by April 2009. Each FIU has ten CPUs. The lithium batteries are recommended to be replaced every three years and the battery packs are recommended to be replaced every two years. The Contractor shall submit catalog cuts of the replacement battery packs for Engineer's approval, prior to installation.

Yearly Battery and UPS Testing

The Contractor shall employ a factory authorized service company to perform an inspection and preventive maintenance at the ComCenter on the UPS, its transfer switch, and its battery and the battery charger of the UPS Systems and RF transmitter. The comprehensive inspection shall be conducted before June of each year and shall include:

Perform initial and final voltage and current checks at each stage

System in bypass and de-energized:

- Check all components

System in bypass and energized:

- Check all alarms, measure and adjust critical setting

System energized and in normal:

- Perform short-term (2 minute) discharge to evaluate battery condition

The Contractor shall obtain a detailed service report from the service engineer. In addition to the readings the report shall note any deficiencies found and/or service recommendations. The Contractor shall submit the original service report in the monthly routine maintenance submittal book. (Any necessary repairs shall be performed through a non-routine work authorization.) Tickets shall be created for any problems found. The date of the inspection(s) shall be listed on the daily agenda.

Traffic Systems Center (Oak Park)

The equipment under maintenance at the location include:

- EMCMS System Equipment:
 - 1 Cisco Switch
 - 2 Compaq Work Station
 - 1 Print Server HP Jet Direct
 - 1 Printer
- Generator and its transfer switches, alarm panels and appurtenances
- UPS, its transfer switch, and Station Battery

Repairs to EMCMS (Electrical Maintenance Contract Management System)

Refer to Article 4.6.6

11.4.10 Weigh Station

The Weigh Station equipment under maintenance includes: electronically operated traffic control devices, traffic control flashers, height detector equipment and truck waiting warning devices, traffic signal heads, traffic signal posts, height detector poles, loop detectors, handholes, vehicle amplifiers, overheight detectors, foundations, cable, conduit, CCTV cameras, monitors, inside and outside lighting system

including lamp, cable, conduit and panel, lenses, reflectors, shields, poles, mast arms, ballasts, decals, control devices, radios, lighting cabinets, fenced enclosures, access gates, above ground cable splice boxes, exposed conduit, unit duct, breakaway devices, and appurtenances. Also included is Weigh Station “open/closed” sign equipment which consists of fiber optic message signs, interconnecting cables, controllers, including INTRAC radio, and power sources all located on various expressways. Excluded from routine maintenance are weigh scales and repair of circuit boards, relays, or cabinets associated with the weigh scales.

Monthly Inspection

The Contractor shall assign qualified personnel to inspect each weigh station installation using the WS patrol inspection log form XW-1 and perform the following:

- Replace all burned out lamps and damaged sockets
- Check lighting in scale pit
- Replace damaged, discolored, cracked or peeling signal lenses
- Repair or replace any damaged signal posts, foundations, signal heads, cable, conduit and over height vehicle detector posts from any cause whatsoever
- Check alignment of signal heads
- Check alignment of overheight vehicle detectors
- Check operation and condition of loop detectors
- Align all signal posts
- Identify vehicle detector loops in need of replacement
- Schedule loop resealing as required (create EMCMS Ticket)
- Check proper operation of the CCTV System and monitors filing washer fluid for proper camera operation. The wipers on the cameras at the WS800B Weigh Station, I-80 outbound, west of 80th Ave, require refilling twice a month.)
- Tickets shall be created for any problems found. The twice monthly log form XW-1, shall be completed and submitted in the routine maintenance monthly submittal book.

Yearly Lighting Clock Control Inspection

The Contractor shall inspect the lighting control clocks, as per Article 7.

Yearly OPEN/CLOSED Sign Relamp

The Contractor shall relamp all OPEN/CLOSED signs during the month of March under routine maintenance and submit the list of signs relamped in the monthly routine submittal book.

11.4.11 Matteson Flood Warning System

Located at Governors Hwy @ 214th St. and Governors Hwy @ 219th St.

The flood warning system consists of the following equipment:

Four (4) Solar Assisted 12 Flashing Beacons with two line message board

Two (2) High water sensor system

Two (2) Radio signal based systems

Two (2) Cellular based systems

Four (4) 64' W X 3' H Barricade gates

Two 14' Steel poles with foundation

Four (4) Mast arm assembly and pole with foundation

When notified by the Com Center or by a police agency that an incident has occurred at the location, a patrolman shall immediately be dispatched to the location by the EMC Dispatch Center. Incidents may include, but are not limited to:

:

- All motorist caused damage
- Malfunctions which suspend normal operations
- Intrusion alarms

- Power outages
- Live exposed voltage cables
- Changeable message signs
- Gates laying in roadway
- Failures of network (telephone, & radio)
- Events which pose a threat to safe, timely operations

The dispatched personnel shall arrive at the relevant system location within sixty minutes of notification of the incident, to assess and troubleshoot the system and/or to make the system operational. The defective equipment shall be permanently repaired as soon as possible, within 24 hours, unless approval is given by the Engineer.

Some situations may require hourly checks by patrolmen or a patrolman on standby time if a serious flooding situation has occurred. All labor and any equipment less than \$500 shall be paid through routine maintenance. The Department’s PS engineer shall be notified of any response by Contractor personnel.

11.5 General Maintenance Responsibilities

The Contractor shall maintain all equipment per requirements as listed in Article 5. For certain technical equipment, as noted herein, the Contractor shall contract with a Specialty Service Company for maintenance. The specialty company names and technician qualifications shall be submitted to the Engineer for approval at the Pre-Construction Meeting.

11.6 Response And Repair Time Requirements

The Contractor shall send qualified personnel to respond to all reports of malfunctions or damage to the Extra Systems equipment as specified herein unless otherwise approved by the Engineer.

LOCATIONS/EQUIPMENT	RESPONSE TIME	SERVICE RESTORATION	PERMANENT REPAIR
Base Stations	1 Hour	4 Hours	7 Working days
Base Station Beacon Outages	1 Hours	4 Hours	24 Hours
Bridge Monitoring	1 Hour	4 Hours	2 Working days
Bridge Monitoring – Lighting	1 Hour	4 Hours	5 Working days
Fiber Optic Network	1 Hour	24 Hours	60 Calendar days
Highway Advisory Radio	1 Hour	4 Hours	1 Working day
Highway Maintenance Yards	1 Hour	24 Hours	21 Working days
Highway Rest Areas	1 Hour	24 Hours	21 Working days
Ice Beacons	1 Hour	4 Hours	1 Working day
IDOT D1 & ComCenter*	1 Hour	4 Hours	24 Hours
IDOT Electrical Field Office*	1 Hour	4 Hours	24 Hours
IDOT Traffic Systems Center	1 Hour	4 Hours	24 Hours
*SCADA Equipment	1 Hour	48 Hours	2 Working days
Weigh Stations	1 Hour	4 Hours	21 Working days

11.7 Non-Routine Maintenance Pay Items

All of the non-routine maintenance pay items are applicable to work authorized by the Engineer for locations under the system and maintained by the Contractor.

11.8 Logs And Forms

A sample of logs and forms as required for this Contract will be available at the Pre-Bid Meeting.

Section 2 -- Special Provisions

Non-Routine Maintenance Pay Items for All Electrical Systems

The non-routine pay items are listed in an alphabetical order by system. Figures mentioned herein will be available upon request at the Pre-Bid Meeting

GAC1 Aerial Cable With Messenger Wire

Description. This item consists of furnishing, installing, testing and connecting aerial electric cable of the size indicated for temporary lighting or service as specified by an Engineer, and as shown on the contract drawings. The cable shall be new, unless otherwise indicated.

Materials. Section 818 and 1066 of the Standard Specifications for Road and Bridge Construction, current version, shall apply to this pay item.

Method of Measurement. The aerial electric cable will be measured in feet in place and will be taken as the length of the messenger wire. Measurement will be made in a straight line between changes in direction and to the centers of light standards and control cabinets. Sag of the aerial cable or vertical cable will not be measured for payment. When the Engineer requests the used temporary cable be replaced with new, the new cable shall be measured for payment. Used aerial cable will not be measured for payment but shall be included in the cost of the item.

Basis of Payment. This item will be paid at the contract unit price per foot for AERIAL CABLE WITH MESSENGER WIRE, 4-1/C up to NO. 2 of the size and number of conductors indicated which shall be payment in full for the work described herein.

The cost of disconnecting and abandoning in place the existing cables feeding underpass, sign, and ramp lighting and reconnecting to the temporary lighting system shall be included in the contract unit price for this item.

The cost of removing the used cable shall be included in the cost of the new cable. The rewiring to facilitate relocation of the cable due to staging or other construction requirements shall be included in the cost of this item.

GAS1 Asphalt, Remove And Replace

Description. This item shall conform to the applicable requirements of Section 408, 440, and 441 of the Standard Specifications for Road and Bridge construction. The asphalt removal and replacement shall be completed at locations shown on the plans, including necessary labor and materials, as directed by the Engineer. The base for the asphalt driveway, if required shall be prepared as per Article 358.

Basis of Payment. This work will be paid for at the contract unit price per square foot for ASPHALT, REMOVE AND REPLACE, which price includes all labor, material and equipment necessary to remove and dispose of the existing asphalt and to construct the new asphalt as specified herein. Preparation of base will be paid for according to Article 358.07.

GC01–GC06 Conduit, Galvanized Steel, Attached to Structure

Description. This item shall consist of furnishing and installing galvanized steel or PVC coated conduit, fittings and accessories attached to structure for roadway or building, as specified herein and as shown on the contract drawings. All conduit splices shall be threaded as directed by the Engineer.

These items shall conform to Sections 1088 and 811 of the Standard Specifications for Road and Bridge Construction, current version, for this pay item, with the following exceptions:

Add the following to Article 811.03(b) of the Standard Specifications: “The personnel installing the PVC coated conduit shall be certified by the conduit manufacturer for installing PVC coated conduit.”

Delete the following sentence of the third paragraph of Article 1088.01(a) (3) of the Standard Specifications: “The exterior galvanized surfaces shall be coated with a primer before the PVC coating to ensure a bond between the zinc substrate and the PVC coating.”

Conduit Wall Seals. Conduit wall seals shall be incidental to the conduit specified under this item. Conduit wall seals used in new concrete walls shall consist of a polyvinylchloride (PVC) oversize sleeve with sealing assemblies at both sides of the wall. The sealing assemblies shall be cast iron alloy or malleable iron with pressure rings and neoprene sealing grommets, membrane clamp and they shall be tightened by means of hex-head screws. Each wall seal shall accept multiple conduit sizes. The sealing assemblies’ castings shall be hot-dip galvanized.

Conduit wall seals used in cored holes in existing concrete shall consist of an assembly of an oversize outside pressure disc with membrane clamp, a neoprene sealing ring and an interior pressure disc, with the discs tightened by means of not less than three stainless steel socket head cup tightening screws with stainless steel washers. Pressure discs shall be PVC-coated steel.

Installation. These items shall conform to Sections 811 of the Standard Specifications for Road and Bridge Construction, current version, for this pay item, with the following exceptions.

Method of Measurement. Conduit shall be measured for payment in feet in place. Measurements shall be made in straight lines along the centerline of the conduit between ends and changes in direction. Vertical conduit shall be measured for payment. Liquid-tight flexible conduit shall be included in the bid price for conduit attached to structure regardless of size and type.

Basis of Payment. This work will be paid at the contract unit price per foot of CONDUIT, GALVANIZED STEEL or PVC coated, attached to structure for roadway or building, of the type, diameter, and number of raceways wide by the number of raceways high, which price shall be payment in full for furnishing and installing the galvanized steel conduit and fittings complete.

- GC01 CONDUIT, GALVANIZED STEEL, ATTACHED TO STRUCTURE, ¾ TO 1 ¼ INCH
- GC02 CONDUIT, GALVANIZED STEEL, ATTACHED TO STRUCTURE, 1 ½ TO 2 ½ INCH
- GC03 CONDUIT, GALVANIZED STEEL, ATTACHED TO STRUCTURE, 3 TO 5 INCH
- GC04 CONDUIT, GALVANIZED STEEL, ATTACHED TO STRUCTURE, PVC COATED, ¾ TO 1 ¼ INCH
- GC05 CONDUIT, GALVANIZED STEEL, ATTACHED TO STRUCTURE, PVC COATED, 1 ½ TO 2 ½ INCH
- GC06 CONDUIT, GALVANIZED STEEL, ATTACHED TO STRUCTURE, PVC COATED, 3 TO 5 INCH

GC07–GC08 Conduit, Galvanized Steel, Encased In Concrete

Description. This item shall consist of furnishing and installing raceways, fittings and accessories encased in concrete as specified herein and as shown on the contract drawings.

Materials. These items shall conform with Section 810 and 1088.01 (a), (b), and (c) of the Standard Specifications for Road and Bridge Construction, Current version, for this pay item, with the following exceptions:

Method of Measurement. Conduit shall be measured for payment in feet in place. Measurements shall be made in straight lines along the centerline of the conduit between ends and changes in direction. Vertical conduits shall be

measured for payment. Liquid-tight flexible conduit shall be included in the bid price for conduit attached to structure regardless of size and type.

Basis of Payment. This work shall be paid at the Contract unit price per foot for furnishing and installing:
GC07 CONDUIT, GALVANIZED STEEL, ENCASED IN CONCRETE, ¾ TO 2 ½”
GC08 CONDUIT, GALVANIZED STEEL, ENCASED IN CONCRETE, FROM 3” TO 5”
of the type, diameter, and number of raceways wide by the number of raceways high specified, which shall be payment in full for the work as described herein.

GC09–GC10 Conduit, Galvanized Steel, in Ground

Description. This item shall consist of furnishing and installing galvanized steel conduit, fittings and accessories in the ground, either pushed, trenched, plowed, or directionally bored with fittings complete as specified herein and as shown on the contract drawings. All conduit splices shall be solid threaded couplings as directed by the Engineer. Trenching, backfilling and restoration are incidental to this pay item in accordance with the District 1 Traffic Signal Specifications.

These items shall conform with Sections T420 and T642 of the Traffic Specifications and District 1 Traffic Signal Specifications, except as herein revised. All conduit shall be placed at a depth of thirty inches, except under railroad tracks the conduit shall be a minimum of five feet.

Add the following to Article 811.03 of the Standard Specifications: “Pavement, driveways, and curbs shall not be removed to install electrical conduits.”

Method of Measurement. Conduit shall be measured for payment in feet in place. Measurements shall be made in straight lines along the centerline of the conduit between ends and changes in direction. Vertical conduits shall be measured for payment. Liquid-tight flexible conduit shall be included in the bid price for conduit attached to structure regardless of size and type.

Basis of Payment. This work will be paid at the contract unit price per foot for CONDUIT, GALVANIZED STEEL, IN GROUND of the type, diameter, and number of raceways wide by the number of raceways high, which price shall be payment in full for furnishing and installing the galvanized steel conduit either pushed, trenched, plowed or directionally bored with fittings, complete. Trenching, backfilling and restoration are incidental in accordance with the District 1 Traffic Signal Specifications.

GC09 CONDUIT, GALVANIZED STEEL, IN GROUND, ¾ TO 2 ½ INCH

GC10 CONDUIT, GALVANIZED STEEL, IN GROUND, 3 TO 5 INCH.

GC11–GC12 Conduit, Non-Metallic, Coilable, in Ground

Description. This item shall consist of furnishing and installing coilable non-metallic, fittings and accessories in the ground, either pushed, trenched, or directionally bored with fittings complete as specified herein and as shown on the contract drawings.

Materials. These items shall conform with Sections T420 and T642 of the Traffic Specifications and District 1 Traffic Signal Specifications, except herein revised. All conduit shall be placed at a depth of thirty inches, except under railroad tracks the conduit shall be a minimum of five feet.

Also, these items shall conform with Sections 1088 and 810 of the Standard Specifications for Road and Bridge Construction, Current version, shall apply to this pay item, with the following exceptions:

The duct shall be a plastic duct which is intended for underground use and which can be manufactured and coiled or reeled in continuous transportable lengths and uncoiled for further processing and/or installation without adversely affecting its properties of performance. The duct and its manufacture shall conform to the standards of NEMA Publication TC7 and ASTM Designation D3485.

The duct shall be made of high density polyethylene which shall meet the requirements of ASTM Designation D 1248, Type III Class C and the requirements listed in table 2-1 of NEMA TC7. Submittal information shall demonstrate compliance of these requirements.

Duct dimensions shall conform to the standards listed in table 2-2 of NEMA TC7. Submittal information shall demonstrate compliance with these requirements.

As specified in NEMA TC7, the duct shall be clearly and durably marked at least every 10 feet with the material designation (HDPE for High Density Polyethylene), nominal size of the duct and the name and/or trademark of the manufacturer.

Method of Measurement. Conduit shall be measured for payment in feet in place. Measurements shall be made in straight lines along the centerline of the conduit between ends and changes in direction. Vertical conduits shall be measured for payment. Liquid-tight flexible conduit shall be included in the bid price for conduit attached to structure regardless of size and type.

Coilable nonmetallic conduit installed in excess of the limits described will not be measured for payment.

Basis of Payment. This work will be paid for at the contract unit price per foot of CONDUIT, NON-METALLIC, COILABLE, IN GROUND, of the type, diameter, and number of raceways wide by the number of raceways high, which price shall be payment in full for furnishing and installing the conduit in ground, coilable non-metallic either pushed, trenched, or directionally bored with fittings complete. Trench and backfill will be paid for separately except the restoration of ground is incidental to this pay item.

GC11 CONDUIT, NON-METALLIC, COILABLE, IN GROUND, 1 1/4 INCH

GC12 CONDUIT, NON-METALLIC, COILABLE, IN GROUND, 2 INCH

GC13 Conduit, PVC, for Buildings, 1 Inch, Schedule 40

Description. This item shall consist of furnishing and installing rigid non-metallic conduit, fittings and accessories as specified herein and as shown on the contract drawings, exposed or embedded within or upon a building structure.

Materials. Rigid non-metallic conduit shall be manufactured in accordance with U.L. Standard 651 and NEMA TC2, accessories in accordance with UL 514 and TC-3, General Service Administration (GSA) WC-1094A, NEC Article 352 (Type RNC) and shall be U.L. listed and labeled Schedule 40 PVC.

Elbows and nipples shall conform to the specifications for conduit. The cost of fittings, couplings, elbows, nipples and other such conduit appurtenances shall be included in the bid unit price for conduit.

Conduit Wall Seals. Conduit wall seals shall be incidental to the conduit specified under this item. Conduit wall seals used in cored holes in existing concrete shall consist of an assembly of an oversize outside pressure disc with membrane clamp, a neoprene sealing ring and an interior pressure disc, with the discs tightened by means of not less than three stainless steel socket head cup tightening screws with stainless steel washers. Pressure discs shall be PVC-coated steel.

Installation.

General. Rigid non-metallic conduit shall be installed in conformance with the requirements of NEC Article 352, except where more stringent requirements are specified herein.

The ends of the conduit shall be cut square and thoroughly reamed before installation. All burrs and rough edges shall be removed.

Bends of rigid nonmetallic conduit shall be so made that the conduit will not be damaged and that the internal diameter of the conduit will not be effectively reduced. Field bends shall be made only with bending equipment identified for the purpose, and the radius of the curve of the inner edge of such bends shall not be less than that shown on Table 354.24 of the National Electrical Code.

Conduit joints shall be coupled. Connection to couplings, fittings and boxes shall be with a suitable-type cement inherently resistant to atmospheres containing corrosive agents.

Conduit runs shall have no more than 270 degrees of bends (the equivalent of three 90 degree bends) between pull points. Bends shall be long radius type unless specifically approved by the Engineer. Bends may be either factory-made bends or field bends using suitable bending apparatus.

Whenever possible, conduits shall be installed so as to drain to the nearest opening, box or fitting.

Fasteners used to mount conduit supports, and other associated items attached to the structure shall be suitable for the weight supported and shall be compatible with the structure material, i.e. wood screws shall be used for solid masonry or concrete and clamps shall be used for structural steel. Expansion anchors shall not be less than ¼ inch trade size and shall extend at least 2 inches into the masonry or concrete. Power-set anchors shall not be less than ¼ inch trade size and they shall extend at least 1 ¼ inch into the masonry or concrete.

Mounting. Unless otherwise indicated or specified, surface-mounted conduits shall be held in place by one-hole clamps and clamp backs. Conduits which are mounted to steel beams or columns shall be held in place by suitable beam clamps. Conduit entering the wet well area of the pump station shall be mounted using stainless steel clamps and clamp backs. All other clamps, clamp backs and beam clamps shall be of electro-plated malleable iron.

Unless otherwise indicated, conduits suspended from the structure shall be supported by trapeze or other hangers approved by the Engineer. Trapeze hangers shall be hot-sip galvanized steel channels or angle irons with conduits held in place by heavy-duty stainless steel U-bolts, nuts and lock washers. Trapeze hangers shall be hung using threaded stainless steel rods not less than 3/8 inch diameter and appropriate anchors or by other means approved by the Engineer.

Conduit supports shall be within 3 feet of each cabinet, panel, box, compression bell fitting. The maximum distance between supports shall be 3 feet.

Method of Measurement. Conduit shall be measured for payment in feet in place. Measurements shall be made in straight lines along the centerline of the conduit between ends and changes in direction. Vertical conduits shall be measured for payment.

Basis of Payment. This work shall be paid at the Contract unit price per foot furnished and installed CONDUIT, PVC, FOR BUILDINGS, 1 INCH, SCHEDULE 40, as indicated, which shall be payment in full for the work as described herein.

GC14 Conduit, Removal

Description. This work shall consist of disconnecting, removing, dismantling and transferring off the site existing conduit, including connectors and appurtenances as herein specified and as directed by the Engineer. Except as otherwise indicated or directed by the Engineer, the existing conduit shall be deemed not salvageable upon removal and shall then be disposed of off the site.

Construction Requirements. No removal work shall be permitted without approval from the Engineer. Any damage resulting from the removal and/or transportation of the existing conduit and associated hardware, shall be repaired to its original condition, or replaced in kind, at the Contractor's own expense, to the satisfaction of the Engineer. The Engineer shall be the sole judge to determine the extent of damage.

Method of Measurement. Conduit removal shall be measured for payment in feet in place. Measurements shall be made in straight lines along the centerline of the conduit between ends and changes in direction. Vertical conduit shall be measured for payment.

Basis of Payment. This item shall be paid at the contract unit price per foot for CONDUIT REMOVAL, including connectors and appurtenances, which shall be payment in full for the work as described herein.

GCC1 Controller, Calcium Chloride Pump

Description. This item shall consist of furnishing and installing an electrical control cabinet with control devices and wiring as shown on the plan prepared by an Engineer for Calcium Chloride pump in a maintenance yard facility as specified herein.

Materials. The completed controller shall be UL approved as an industrial control panel. The cabinet shall be single door design, wall mounted type, NEMA 4X, not less than 14 gauge Type 304 stainless steel. All external hardware shall be stainless steel. The cabinet shall adequately house all required components with ample room for arrangement and termination of wiring. A 60 percent fill capacity shall be the design guideline. The controller shall have all the components as shown on the electrical plan to operate remotely and manually the calcium chloride pump, refer to the Standard Specifications for Road and Bridge Construction, current version, section 1068.(e) for detailed operating criterion.

Method of Measurement. Each calcium chloride pump controller, inspected and approved by the Engineer, shall be counted, each, as a unit for payment, furnished and installed.

Basis of Payment. This item shall be paid at the contract unit price each for CONTROLLER, CALCIUM CHLORIDE PUMP, which shall be payment in full for furnishing and installing the controller, complete, as specified herein.

GCX1 Coaxial Cable

Description. This work shall consist of furnishing materials and labor for installation of coaxial cable exposed or within conduit as specified herein and indicated by the Engineer, complete with all connectors, connector sealant, termination at radio and antenna end and testing.

Materials. Cable shall be low loss (1.5 DB/100' AT 100 m Hz) 50 ohm Helix coaxial cable with flame retardant, foam dielectric, solid inner conductor and solid outer corrugated conductor. Coaxial cable shall be Times Microwave Systems Number LMR-1200 or Engineer-approved equivalent.

Interfacing connectors shall be of the same size and type as the cable, furnished and installed as needed and indicated by the Engineer. All connectors shall be furnished with an O-ring to seal out moisture.

All connectors installed outside or exposed to weather shall be furnished with a weatherproofing kit recommended by the manufacturer.

Installation. The cable shall be carefully installed to avoid damage to the cable jacket. Cable splices will not be allowed. The cable shall not be bent to a radius less than the manufacturer's recommended bending radius, either in permanent placement or during installation.

Fasteners used to mount exposed coaxial cable shall be compatible with the mounting structure material i.e. wood screws shall be used for wood, toggle bolts shall be used for hollow masonry, expansion bolts or power-set studs shall be used for solid masonry or concrete and clamps shall be used for structural steel. Wire tie-wraps are unacceptable. Cable shall be terminated, with the appropriate connectors, at the indicated radio and antenna.

Testing. After installation, the cable shall be tested as approved by the Engineer. Cable failing to pass the test shall be replaced with new cable at no additional cost.

Method of Measurement. The cable shall be measured for payment in feet in place. Measurements shall be made in straight lines between changes in direction and to the centers of equipment. All vertical cable and permissible cable slack shall be measured for payment. A total of 2 ft.

slack shall be allowed for the end of a coaxial cable termination. Additional vertical distance for the height of conduit risers, etc., as applicable, will be measured for payment for equipment so mounted.

Basis of Payment. This work shall be paid at the Contract unit price per foot installed COAXIAL CABLE, ¾ TO 7/8 INCH, exposed or within conduit as specified, which shall be payment in full for the work as described herein.

GE01–GE02 Electric Cable Assembly

Description. This item shall consist of furnishing and installing multi-conductor power cable, suitable for direct burial, in conduit or trench, as specified herein, complete with all testing. The cable shall be an assembly of insulated power conductors, plus an insulated ground wire cabled in accordance with UL 1277 with fillers and binder tape, and with a jacket overall. The cable shall be UL Listed for direct burial use and shall be rated 90 degrees C dry and 75 degrees C wet.

Materials. Materials shall be according to Article 1076.01 and 1066.06 of the Standard Specifications for Road and Bridge Construction, current version, shall apply to this pay item.

Installation. Section 870 of the Standard Specifications for Road and Bridge Construction, Current version, shall apply to this pay item, with the following exceptions:

Add the following to Article 870.03 of the Standard Specifications:

“Bored and Pulled. A remotely steerable, fluid cutting tunneling system is to be used to install the cable assembly. The tunneling system shall be electronically detectable and shall line the tunnel with a clay lining as it tunnels. The tunneling system shall be approved by the Engineer prior to its use.”

Method of Measurement. Electric cable assembly, in conduit or trench, shall be measured, per feet.

Basis of Payment. This item shall be paid at the contract unit price per foot for :

GE01 ELECTRIC CABLE ASSEMBLY, EPR, 3/C NO. 2, 1/C NO. 6 EPR GREEN

GE02 ELECTRIC CABLE ASSEMBLY, EPR, 3/C NO. 4, 1/C NO. 6 EPR GREEN

of the size and number of conductors indicated, which shall be payment in full for furnishing, installing in conduit or trench and testing the cable as specified herein.

GE03–GE07 Electrical Cable in Conduit, EPR

Description. This work shall consist of furnishing materials and labor for installation of electric cables in conduit as shown on the contract drawings or as otherwise indicated, complete with all splicing, identification, terminating and testing.

Sections 817 and 1066 of the Standard Specifications for Road and Bridge Construction, current version, shall apply to this pay item, with the following exception(s):

Add the following to Article 1066.03(b) of the Standard Specifications:

Cable sized No. 2 AWG and smaller shall be UL listed Type RHH/RHW and may be Type RHH/RHW/USE.
Cable sized larger than No. 2 AWG shall be UL listed Type RHH/RHW/USE."

Method of Measurement. The cable shall be measured for payment in feet, in place. Measurements shall be made in straight lines between changes in direction and to the centers of equipment. All vertical cable and permissible cable slack shall be measured for payment. A total of 6 ft. slack shall be allowed for the end of a run terminating at a panel and 4 ft. will similarly be allowed when terminating at a wall-mounted panel. Additional vertical distance for the height of conduit risers, etc., as applicable, will be measured for payment for equipment so mounted.

Basis of Payment. This item will be paid at the contract unit price per foot for furnish & installation of:

- GE03 ELECTRICAL CABLE, EPR, 1/C UP to No. 6
- GE04 ELECTRICAL CABLE, EPR, 1/C No. 4 to No.1
- GE05 ELECTRICAL CABLE, EPR, 1/C from No. 1/0 to No. 2/0
- GE06 ELECTRICAL CABLE, EPR, 1/C from No. 3/0 to No. 4/0
- GE07 ELECTRICAL CABLE, EPR, 1/C from No.250 to 500 MCM

of the size, number and type of conductors indicated, which shall be payment in full for the work as described herein.

GE08 Electric Cable, Pull Or Remove

Description. This work shall consist of pulling and/or removing an existing electric cable from a conduit.

Method of Measurement. Electric cable in conduit, pull/remove, shall be counted, each, per feet.

Basis of Payment. This work will be paid for at the contract unit price per foot per electrical cable for ELECTRIC CABLE, PULL OR REMOVE, which price shall be payment in full for removing the electric cable complete. If two or more cables in a conduit are to be removed each cable will be measured for payment separately.

GE09 Electrical Cable, THWN

Description. This work shall consist of furnishing materials and labor for installation of electric cables in conduit as specified herein and indicated by the Engineer, complete with all splicing, identification, terminating and testing.

Materials. All cables shall be U.L. listed as Type THHN or THWN per Standard 83, rated for 600 volts, 90 degrees C. dry and 75 degrees C. wet. They shall be suitable for installation in wet and dry locations, expose to the weather, and shall be resistant to oils and chemicals. It shall conform to the Federal

Specification J-C-30B. The U.L. listing mark, cable voltage, insulation type and ratings, as well as the cable size shall all be clearly printed on the cable in a color contrasting with the insulation color. Conductors shall be annealed uncoated copper per UL Standard 83 or 1063 and unless otherwise indicated, shall be Class B or Class C stranded. Conductors used for general building lighting and receptacle circuits may be solid.

Each cable shall be insulated with Polyvinyl Chloride (PVC) and sheathed with nylon complying with requirements of UL Standard 83 for Types THHN or THWN. The minimum thickness at any point, of the PVC insulation, shall be not less than 90 % of the specified average thickness.

Unless otherwise indicated, cable shall be solid full color coded via insulation color. Unless specifically approved by the Engineer, color coding of neutral and ground wires shall be by means of colored insulation, except where bare ground wires are indicated.

Branch circuit from panelboards, for lighting, receptacles and similar loads shall be color coded by mean of colored wire insulation. Colors shall be as selected by the Contractor but a sufficient number of colors shall be used such that wiring in common enclosures is clearly differentiated and color combinations or runs are generally not repeated. Care shall be taken in the phasing of combined-neutral circuit runs. Switched legs shall be differentiated from un-switched legs of a circuit.

Wiring shall be color coded by means of colored wire insulation as follows:

“line”: black
neutral: white
ground: green
others: color coded using a repeating color format as approved by the Engineer. Signal cable conductor insulation shall be color coded.

Quality Control. Submittal information shall include demonstration of compliance with all specified requirements. All cables shall be new, having been manufactured within the 18 months preceding the date of delivery to the site. All cables shall be delivered to the site in full reels. Cable on the reels shall be protected from damage during shipment and handling by wood lagging or other means acceptable to the Engineer. Reels shall be tagged or otherwise identified to show the UL listing.

Installation. Wires and cables shall be carefully installed to avoid damage to insulation and cable jackets as applicable. Wire lubricant shall be used when pulling wires into conduits. The lubricant shall be no-injurious to conduits, conductors, insulations or jackets and the lubricant shall be UL listed. Each run of cable shall have sufficient slack. Where a number of wires are trained through a box, manhole or handhole, they shall be bundled using appropriate cable ties and supported to minimize pressure or strain on cable insulation. Wire and cable shall not be bent to a radius less than the manufacturer’s recommended bending radius, either in permanent placement or during installation. Cable pulling apparatus shall have no sharp edges or protrusions which could damage cables or raceways.

Wire splices will not be allowed on an SCADA system signal or control wiring. All splices must be approved by the Engineer. Splices and terminations, as required, shall be incidental to this item and shall be in conformance with Basic Materials and Methods, elsewhere herein.

All wiring shall be tagged with pre-printed, self-sticking, wrap or heat-shrink type wire markers or other markers approved by the Engineer. Hand written wire markers are not acceptable. The tagging shall be applied at each termination and splice. The tagging shall include the full circuit and wire designation. Markers shall be permanent, of a size recommended by the manufacturer for the respective wire size and shall be applied as recommended by the marker manufacturer. All wiring shall be terminated as indicated by the Engineer.

Testing. After installation, the cable shall be tested as approved by the Engineer. Cable failing to pass the test shall be replaced with new cable at no additional cost.

Method of Measurement. The cable shall be measured for payment in feet in place. Measurements shall be made in straight lines between changes in direction and to the centers of equipment. All vertical cable and permissible cable slack shall be measured for payment.

A total of six (6) feet slack shall be allowed for the end of a run terminating at a panel and four (4) feet will similarly be allowed when terminating at a wall-mounted panel. Additional vertical distance for the height of conduit risers, etc., as applicable, will be measured for payment for equipment so mounted.

Basis of Payment. This work shall be paid at the Contract unit price per foot installed ELECTRICAL CABLE, THWN, 1/C from No. 14 to No. 10 of the size and type indicated, which shall be payment in full for the work as described herein.

GE10 Electric Service Disconnect, 2 or 3 Wire, Combination

Description. This item shall consist of furnishing and installing for the Lighting and/or Traffic Signal System a service disconnect box, 2 or 3 wire mounted on a wood pole as specified below, or shown on accompanying details drawings and as directed by the Engineer.

Materials. The disconnect box shall be NEMA 4X stainless steel, nominally 12” x 16” x 8” with piano hinged door, steel back panel, fast acting stainless steel enclosure clamps, padlock provisions and door stop kit, Hoffman catalog #A-16H1208SS6LP/A-16P12/A-DSTOPK/C-PMK12, or approved equal.

Circuit Breakers shall be thermal magnetic bolt-on type with a minimum interrupt capacity of 25,000 symmetrical amperes at 240 volts. Breakers shall be lockable in the off position for lockout/tag-out compliance.

Disconnect surge protector shall be suitable for 240/120 volt single phase 60Hz. AC electrical service. Protector shall have a surge energy capability of 2160 joules or better at 8/20 microseconds, rate -40 to 60 degrees C., with LED operating indicators and shall be UL listed per UL 1449. Protector shall be a Cutler Hammer CMOV230L065XST or approved equal.

Conduit, wire, and ground rods to complete the installation of the disconnect box shall included as part of the scope of work.

Bus bars, connectors, and lugs shall be copper, insulated and isolated, and configured to prevent shorted conditions from tightening terminations. Lug and connectors shall be rated for 75 degrees C. Overall bus section shall be configured behind an insulating barrier shield which is removable for access to connections. Combination ground and neutral bar shall be configured with separate ground and neutral sections and spare terminal as indicated. The heads of grounding screws shall be painted green. The heads of neutral screws shall be painted white.

A plastic laminated layout and circuit diagram shall be affixed to the interior side of the enclosure door. A 2-color engraved plastic nameplate, attached with screws and engraved as indicated, shall be provided for each main breaker. The exact mounting height for the S.E.E.D. shall be field determined and marked by the Engineer.

Electrical service shall be of the voltage indicated. Where 120 volt service is indicated, service drop cable shall be installed accordingly and lighting main breaker and all other service appurtenances shall be included regardless of the service voltage applied to the installation.

The electric service equipment assembly shall be UL labeled, suitable for use as service equipment.

Unistrut channel shall be provided for proper installation of the disconnect, as shown on disconnect mounting detail.

Contractor shall be paid for separately for coordination of work with the Utility company.

Installation. The S.E.E.D. shall be installed as per accompanying disconnect mounting detail. Note detail drawing for installation of stainless steel straps and iron conduit straps. Disconnect shall be installed a minimum of 10 feet above final grade, as shown on electric service detail.

All work beginning to end shall be coordinated with the power utility company. Contractor shall call power utility company.

Method of Measurement. Each Service disconnect Box, 2 or 3 wire, mounted on the wood pole, for the Lighting and/or Traffic Signal Systems, installed complete as per the above specifications and as directed by Engineer, shall count as a unit for payment.

Basis of Payment. This item shall be paid for at the contract unit price each for ELECTRIC SERVICE DISCONNECT, 2 or 3 WIRE, COMBINATION, which shall be payment in full for the material and work described herein.

GE11 Electric Service Disconnect, 2 or 3 Wire, Surveillance/Traffic

Description. This item shall consist of furnishing and installing a Surveillance/Traffic System Service Disconnect Box, 2 or 3 wire, mounted on a wood pole as specified below, shown on accompanying details drawings and as directed by the Engineer.

Materials. The disconnect box shall be NEMA 4X stainless steel, nominally 12” x 16” x 8” with piano hinged door, steel back panel, fast acting stainless steel enclosure clamps, padlock provisions and door stop kit, Hoffman catalog #A-16H1208SS6LP/A-16P12/A-DSTOPK/C-PMK12, or approval equal.

Circuit Breakers shall be thermal magnetic bolt-on type with a minimum interrupt capacity of 10,000 symmetrical amperes at 120 volts. Breakers shall be lockable in the off position for lock out/tag-out compliance.

Disconnect surge protector shall be suitable for 240/120 volt single phase 60Hz. AC electrical service. Protector shall have a surge energy capability of 2160 joules or better at 8/20 microseconds, rated –40 to 60 degrees C., with LED operating indicators and shall be UL listed per UL 1449. Protector shall be a Cutler Hammer CMOV230L65XST or approved equal.

Conduit, wire, and ground rods to complete the installation of the disconnect box shall be paid for via pay items elsewhere herein.

Bus bars, connectors and lugs shall be copper, insulated and isolated, and configured to prevent shorted conditions from tightening terminations. Lug and connectors shall be rated for 75 degrees C. Overall bus section shall be configured behind an insulating barrier shield which is removable for access to connections.

Combination ground and neutral bar shall be configured with separate ground and neutral sections and spare terminals as indicated. The heads of ground screws shall be painted green. The heads of neutral screws shall be painted white.

A plastic laminated layout and circuit diagram shall be affixed to the interior side of the enclosure door.

A 2-color engraved plastic nameplate, attached with screws and engraved as indicted, shall be provided for each main breaker.

The exact mounting height of the S.E.E.D. shall be field determined and marked by the Engineer.

Electrical service shall be of the voltage indicated. Where 120 volt service is indicated, service drop cable shall be installed accordingly and lighting main breaker and all other service appurtenances shall be included regardless of the service voltage applied to the installation. The electric service equipment assembly shall be UL labeled, suitable for use as service equipment. Unistrut channel shall be provided for proper installation of the disconnect, as shown on disconnect mounting detail.

Installation. The S.E.E.D. shall be installed as per accompanying disconnect mounting detail. Note detail drawing for installation of stainless steel straps and iron conduit straps. Disconnect shall be installed a minimum of 10 feet above final grade, as shown on electric service detail. All work beginning to end shall be coordinated with the power utility company. Contractor shall call the power utility company to set up all service calls.

Method of Measurement. Each Service Disconnect Box, 2 or 3 wire, mounted on a wood pole for the Surveillance/Traffic System, installed as per the above specifications and as directed by Engineer, shall count as a unit for payment.

Basis of Payment. This item shall be paid for at the contract unit price each for ELECTRIC SERVICE DISCONNECT, 2 OR 3 WIRE, SURVEILLANCE/TRAFFIC, which shall be payment in full for the material and work described herein.

GE12–GE13 Electric Service

Description. This work shall consist of the installation of an Electric Service Installation, Type C, or E, which shall meet the requirements of Sections 804, 805, and 1065 of the Standard Specifications for Road and Bridge Construction and District One Traffic Signal Specifications. This item shall consist of all material and labor required to extend, connect or modify the electric services, as indicated or specified, which is over and above the work performed by the utility. The charges by the utility company will be paid separately under vendor letter.

Installation. The Contractor shall notify the electric utility marketing representative a minimum of 15 working days prior to the anticipated date of hook-up. This 15 day advance notification will begin only after the electric utility marketing representative has received service charge payments from the Contractor. The Contractor shall ascertain the work being provided by the electric utility and shall provide all additional material and work required to complete the electric service work in complete compliance with the requirements of the utility. No additional compensation will be allowed for work required for the electric service, even though not explicitly shown on the Drawings or specified herein. Service cable shall be paid for via separate pay item elsewhere herein.

Basis of Payment. This work will be paid for at the contract unit price each for:

GE12 ELECTRIC SERVICE, PEDESTAL OR POLE MOUNTED, COMPLETE

GE13 ELECTRIC SERVICE, RELOCATE

which shall be payment in full for furnishing and installing the service installation complete. Any charges by the utility company to provide electrical services to the service installation will be paid for in accordance with the Standard Specifications for Road and Bridge Construction.

GF01 Fiber Optic Trunk/Distribution/Lateral Cable Single Mode Up To 96 SM

Description: This item shall consist of furnishing, installing, and testing a loose tube, single-mode, fiber-optic cable of the type, size, and number of fibers specified, at the locations shown on the plans and shall be in counts of 12, including all splices, splice enclosures, ST or SC connectors, as specified by the Engineer, patch panels and other miscellaneous equipment to make a complete and operating system.

Materials: The single-mode, fiber optic cable shall incorporate a loose, buffer-tube design. The cable shall be qualified to the requirements of RUS 7 CFR 1755.900 (PE-90) for a single sheathed, non-armored cable, and shall be new, unused and of current design and manufacture.

The cables shall use dispersion unshifted fibers. The optical and physical characteristics of the un-cabled fibers shall include:

Core Diameter	8.3µm (nominal)
Numerical Aperture	0.14
Zero Dispersion Wavelength	1300-1322 nm
Zero Dispersion Slope	0.092 ps/(nm ² *km)(maximum)
Cladding Diameter	125.0 ± 0.7 µm
Core-Clad Concentricity	0.05 µm maximum
Cladding Non-Circularity	1% maximum
Coating Diameter	245 ± 10 µm
Coating-Cladding Concentricity	12 µm maximum
Mode Field Diameter	9.2 µm ± 0.4 µm at 1310 nm
Mode Field Diameter	10.4 µm ± 0.5 µm at 1550 nm
Dispersion	18.0 ps/(nm*km) maximum at 1550 nm

The number of fibers in each cable shall be as specified on the plans.

For cables with more than 12 fibers, the core construction shall consist of individual buffer tubes, each containing 12 fibers. These buffer tubes shall be stranded around a dielectric central strength member using a reverse oscillation process. For cables containing 12 fibers or less, the core shall use a unitube construction with either 6 or 12 fibers in a single tube.

The individual fibers and buffer tubes shall be identifiable by means of a color-coding scheme as specified in TIA/EIA-598.

The maximum attenuation of any cabled fiber shall not exceed 0.4 dB/km at 1310 nm and shall not exceed 0.3 dB/km at 1550 nm.

The cable shall be capable of withstanding a minimum-bending radius of 20 times its' outer diameter during installation and 10 times its' outer diameter during operation without changing the characteristics of the optical fibers.

The cable shall meet all of specified requirements under the following conditions:

Shipping/storage temperature -58° to F to +158° F (-50° C to +70° C)

Installing temperature: -22° F to + °158 F° (-30° C to +70° C)

Operating temperature -40° F to + °158 F° (-40° C to +70° C)

Relative humidity from 0% to 95%, non-condensing

Fiber Optic Splice

The Contractor shall splice optical fibers from different cable sheaths and protect them with a splice closure at the locations shown on the Plans. Fiber splicing consists of in-line fusion splices for all fibers described in the cable plan at the particular location.

Materials

Splice Closures

Splice Closures shall be designed for use under the most severe conditions such as moisture, vibration, impact, cable stress and flex temperature extremes as demonstrated by successfully passing the factory test procedures and minimum specifications listed below:

Physical Requirement: The closure shall provide ingress for up to four cables in a butt configuration. The closure shall prevent the intrusion of water without the use of encapsulates.

The closure shall be capable of accommodating splice organizer trays that accept mechanical or fusion splices. The splice closure shall have provisions for storing fiber splices in an orderly manner, mountings for splice organizer assemblies, and space for excess or un-spliced fiber. Splice organizers shall be re-enterable. The splice case shall be UL rated.

Closure re-entry and subsequent reassembly shall not require specialized tools or equipment. Further, these operations shall not require the use of additional parts.

The splice closure shall have provisions for controlling the bend radius of individual fibers to a minimum of 38 mm (1.5 in.).

Factory Testing

Compression Test: The closure shall not deform more than 10% in its largest cross-sectional dimension when subjected to a uniformly distributed load of 1335 N at temperature of -18° and 38°C (0 and 100° F). The test shall be performed after stabilizing at the required temperature for a minimum of two hours. It shall consist of placing an assembled closure between two flat parallel surfaces with the longest closure dimension parallel to the surfaces. The weight shall be placed on the upper surface for a minimum of 15 minutes. The measurement shall then be taken with weight in place.

Impact Test: The assembled closure shall be capable of withstanding an impact of 28 N-M at temperatures of -18° and 38°C (0 and 100° F). The test shall be performed after stabilizing the closure at the required temperature for a minimum of 2 hours. The test fixture shall consist of 9 kg (20 lb) cylindrical steel impacting head with a 50 mm (2in) spherical radius at the point where it contacts the closure. It shall be dropped from a height of 305 mm (12 in.) The closure shall not exhibit any cracks or fractures to the housing that would preclude it from passing the water immersion test. There shall be no permanent deformation to the original diameter or characteristic vertical dimension by more than 5%.

Cable Gripping and Sealing Testing: The cable gripping and sealing hardware shall not cause an increase in fiber attenuation in excess of 0.05 dB/fiber at 1550 nm when attached to the cables and the closure assembly. The test shall consist of measurements from six fibers, one from each buffer tube or channel, or randomly selected in the case of a single fiber bundle. The measurements shall be taken from the test fibers before and after assembly to determine the effects of the cable gripping and sealing hardware on the optical transmission of the fibers.

Vibration Test: The splice organizers shall securely hold the fiber splices and store the excess fiber. The fiber splice organizers and splice retaining hardware shall be tested per EIA Standard FOTP-II, Test Condition 1. The individual fibers shall not show an increase in attenuation in excess of 0.1 dB/fiber.

Water Immersion Test: The closure shall be capable of preventing a 3 m (10 ft) water head from intruding into the splice compartment for a period of 7 days. Testing of the splice closure is to be accomplished by the placing of the closure into a pressure vessel and filling the vessel with tap water to cover the closure. Apply continuous pressure to the vessel to maintain a hydrostatic head equivalent 3 meters (10 ft.) on the closure and cable. This process shall be continued for 30 days. Remove the closure and open to check for the presence of water. Any intrusion of water in the compartment containing the splices constitutes a failure.

Certification: It is the responsibility of the Contractor to insure that either the manufacturer or an independent testing laboratory has performed all of the above tests, and the appropriate documentation has been submitted to the Department. Manufacturer certification is required for the model(s) of closure supplied. It is not necessary to subject each supplied closure to the actual tests described herein.

Construction Requirements

The closure shall be installed according to the manufacturer's recommended guidelines. For mainline splices, the cables shall be fusion spliced 45 days prior to start of the fiber optic cabling installation. The Contractor shall submit the proposed locations of the mainline splice points for review by the Department.

The Contractor shall prepare the cables and fibers in accordance with the closure and cable manufacturers' installation practices. A copy of these practices shall be provided to the Engineer 21 days prior to splicing operations.

Using a fusion splicer, the Contractor shall optimize the alignment of the fibers and fuse them together. The Contractor shall recoat the fused fibers and install mechanical protection over them.

Upon completing all splicing operations for a cable span, the Contractor shall measure the mean bi-directional loss at each splice using an Optical Time Domain Reflectometer. This loss shall not exceed 0.1 dB.

The Contractor shall measure the end-to-end attenuation of each fiber, from connector to connector, using an optical power meter and source. This loss shall be measured from both direction and shall not exceed 0.5 dB per installed kilometer of single mode cable. Measurements shall be made at both 1300 and 1550 nm for single mode cable. For multimode cable, power meter measurements shall be made at 850 and 1300 nm. The end-to-end attenuation shall not exceed 3.8 dB/installed kilometers at 850nm or 1.88 dB per installed kilometer at 1300 nm for multimode fibers.

As directed by the Engineer, the Contractor (at no additional cost to the Department) shall replace any cable splice not satisfying the required objectives.

The contractor shall secure the Splice Closure to the side of the splice facility using cable support brackets. All cables shall be properly dressed and secured to rails or racks within the manhole. No cables or enclosures will be permitted to be on the floor of the splice facility. Cables that are spliced inside a building will be secured to the equipment racks or walls as appropriate, and indicated on the Plans.

Optical Patch Cords and Pigtails:

Optical patch cords and pigtails shall comply with the following:

- The optical patch cords furnished under this contract shall consist of a section of single fiber, jacketed cable, equipped with optical connectors at both ends.

- The factory installed connector furnished as part of the optical patch cords and pigtails shall meet or exceed the requirements for approved connectors specified herein.
- The fiber portion of each patch cord and pigtail shall be a single, jacketed fiber with optical properties identical to the optical cable furnished under this contract.
- The twelve fiber single-mode fiber optic cable shall be installed as a pigtail with factory installed ST compatible connectors.
- The patch cords shall comply with Telcordia GR-326-CORE

Connectors:

The optical connectors shall comply with the following:

- All connectors will be factory installed ST compatible connectors. Field installed connectors shall not be allowed.
- Maximum attenuation 0.4dB, typical 0.2dB
- No more than 0.2dB increase in attenuation after 1000 insertions
- Attenuation of all connectors will be checked and recorded at the time of installation with an insertion test minimum 5 times checked with an OTDR
- All fibers shall be connectorized at each end
- All fibers shall terminate at a fiber patch panel
- Unused fibers will be protected with a plastic cap to eliminate dust and moisture
- Termination shall be facilitated by splicing factory OEM pigtails on the end of the bare fiber utilizing the fusion splicing method. Pigtails shall be one meter in length.

Installation

Fiber optic cable may be installed in 4-inch surveillance duct existing in the foundation of the barrier wall along the expressway. Cable connecting the barrier wall with remote houses or control cabinets will be pulled through 4-inch GS conduit along with an additional 1-C No. 10 insulated cable for locating purposes. Cable will be installed in the longest continuous lengths supplied by the manufacturer. A suitable cable feeder guide shall be used between the cable reel and the face of the duct and conduit to protect the cable and guide it into the duct off the reel. It shall be carefully inspected for jacket defects. If defects are noticed, the operation shall be stopped immediately and the Engineer notified. Precautions shall be taken during installation to prevent the cable from being “kinked” or “crushed”. A pulling eye shall be attached to the cable and used to pull the cable through the duct and conduit system. A pulling swivel shall be used to eliminate twisting of the cable.

As the cable is played off the reel into the cable feeder guide, it shall be sufficiently lubricated with a type of lubricant recommended by the cable manufacturer. Dynamometers or breakaway pulling swing shall be used to ensure that the pulling line tension does not exceed the installation tension value specified by the cable manufacturer. The mechanical stress placed on a cable during installation shall not be such that the cable is twisted or stretched. The pulling of cable shall be hand assisted at each controller cabinet. The cable shall not be crushed, kinked or forced around a sharp corner. If a lubricant is used, it shall be of water-based type and approved by the cable manufacturer. Sufficient slack shall be left at each end of the cable to allow proper cable termination. 40 feet of additional slack cable shall be left in each junction box and 100 feet at each hand hole or as directed by the Engineer. Storage of additional slack cable in junction boxes and hand holes shall be coiled. The slack coils shall be bound at minimum of 3 points around the coil perimeter and supported in their static storage positions. At each junction box and hand hole the cable shall be visibly marked/tagged as “CAUTION-FIBER OPTIC CABLE”. Maximum length of cable pulling tensions shall not exceed the cable manufacturer’s recommendations.

During cable pulling operations, the Contractor shall ensure that the minimum bending of the cable is maintained during the unreeling and pulling operations. Entry guide chutes shall be used to guide the cable into the hand hole conduit ports. Lubricating compound shall be used to minimize friction. Corner rollers (wheels), if used, shall not have radii less than the minimum installation-bending radius of the cable. A series array of smaller wheels can be used for accomplishing the bend if the cable manufacturers specifically approve the array.

The pulling tension shall be continuously measured and shall not be allowed to exceed the maximum tension specified by the manufacturer of the cable. Fuse links and breaks can be used to ensure that the cable tensile

strength is not exceeded. The pulling system shall have an audible alarm that sounds whenever a pre-selected tension level is reached. Tension levels shall be recorded continuously and shall be given to the Engineer upon request.

The fiber optic cable may be installed in conduits already populated with copper telecommunication cable, 50 pair #19 or 100 pair #19. The telecommunications cable shall be removed and new cable installed with the fiber optic cable. Removal of the existing 50 pair or 100 pair #19 cable shall be included in contract unit price for fiber optic cable type, size, and number of conductors as specified.

Splices will be performed using approved fusion splicing equipment. A stainless steel rod, and shrink sleeve will be used to protect each splice. After each splice is performed, the attenuation will be checked and recorded. Splices will then be put into a splice tray, and all splice trays installed inside of an approved splice enclosure.

Installation of the fiber optic cable will require traffic control, which will involve lane closures with restrictive times that the Contractor will be allowed on the freeway. The majority of work involved for the installation will have to be done during nighttime operations or on weekends.

Traffic control will be paid for separately but the Contractor shall reflect the premium labor costs incurred due to restrictive working hours in this contract unit price. The Contractor will not be allowed additional compensation for premium work time incurred under this item.

Pigtails with ST or SC, as specified by the Engineer, compatible connectors shall be spliced and then be terminated in a fiber patch panel or termination panel.

As-built documentation: After the fiber optic cable plant has been installed, ten (10) complete sets of as-built documentation shall be provided. The documentation shall, as a minimum, include the following:

- Complete and accurate as-built diagrams showing the entire fiber optic cable plant including locations of all splices.
- Final copies of all approved test procedures.
- Complete performance data of the cable plant showing the losses at each splice location and each terminal connector.
- Complete parts list including names of vendors.

Testing Requirements: The Contractor shall submit detailed test procedures for approval by the engineer. All fibers shall be tested bi-directionally at both 1310 nm and 1550 nm with both an Optical Time Domain Reflectometer (OTDR) and a power meter and optical source. For testing, intermediate breakout fibers may be concatenated and tested end-to-end. Any discrepancies between the measured results and these specifications will be resolved to the satisfaction of the Engineer.

The Contractor shall provide the date, time and location of any tests required by this specification to the engineer at least 5 days before performing the test. Upon completion of the cable installation, splicing, and termination, the Contractor shall test all fibers for continuity. Events above 0.1 dB and total attenuation of the cable. The test procedure shall be as follows:

A Certified Technician utilizing an Optical Time Domain Reflectometer (OTDR) and Optical Source/Power Meter shall conduct the installation test. The Technician is directed to conduct the test using the standard operating procedures defined by the manufacturer of the test equipment. All fibers installed shall be tested in both directions.

The method of connectivity between the OTDR and the cable shall be a factory patch cord of a length equal to the “dead zone” of the OTDR. Optionally, the Technician can use a factory “fiber box” of 328 ft (100m) minimum with no splices within the box. The tests shall be conducted at 1310 and 1550 nm for all fibers.

At the completion of the test, the Contractor shall provide two copies of documentation of the test results to the Project Engineer. The test documentation shall be submitted as both a bound copy and a CD Rom and shall include the following:

- Cable & Fiber Identification:
- Cable ID

Cable Location-beginning and end point
Fiber ID, including tube and fiber color
Operator Name
Date & Time
Setup Parameters
Wavelength
Pulse width (OTDR)
Refractory index (OTDR)
Range (OTDR)
Scale (OTDR)
Setup Option

Test Results:

A.) OTDR Test
Total Fiber Trace
Splice Loss/Gain
Events>0.10 dB
Measured length (Cable Marking)
Total Length

The OTDR test results file format must be Bellcore/Telcordia compliant according to GR-196-CORE issue 2, OTDR Data Standard.

-GR 196, Revision 1.0
-GR196 Revision 1.1
-GR 196, Revision 2.0 (SR-4731)

B.) Optical Source/Power Meter
Total Attenuation
Attenuation (dB/km)

These results shall be provided in tabular form. The following shall be the criteria for the acceptance of the cable:

The test results shall show that the dB/km loss does not exceed +3% of the factory test or 1% of the cable's published production loss. However, no event shall exceed 0.10 dB. If any event is detected above 0.10 dB, the Contractor shall replace or repair the fiber including that event point.

The total loss of the cable (dB) less events shall not exceed the manufacturer's production specifications as follows: 0.5 dB/km at both 1310 and 1550 nm.

If the total loss exceeds these specifications, the Contractor shall replace or repair that cable run at the Contractor's expense, both labor and materials. Elevated attenuation due to exceeding the pulling tension during installation shall require the replacement of the cable run at the Contractor's expense, including labor and materials.

Label the destination of each run or distribution cable onto the cable in each hand hole, vault or cable termination panel.

Slack Storage of Fiber Optic Cables

As part of these items, slack fiber shall be supplied as necessary to allow splicing the fiber optic cables in a controlled environment, such as a splicing van or tent. After splicing has been completed, the slack fiber shall be stored underground in hand holes or in the raised base adapters of ground mounted traffic controller cabinets.

Where identified on the plans, or as directed by the Engineer, additional lengths of fiber shall be stored, as maintenance coils. The aggregate lengths of the maintenance coils and the slack fiber will be used to repair and maintain the fiber optic cable.

Fiber optic cable shall be tagged inside hand holes with yellow tape containing the text “CAUTION – FIBER OPTIC CABLE.” In addition, permanent tags, as approved by the engineer, shall be attached to all cable in a hand hole or other break-out environment. These tags shall be stainless steel, nominally 0.75” by 1.72”, and permanently embossed. These tags shall be attached with stainless steel straps, and shall identify the cable number, the number of fibers, and the specific fiber count. Tags and straps shall be Panduit or approved equal.

Method of Measurement The fiber optic cable of the number of fibers specified will be measured for payment as the number of feet (meters) of cable, including lengths stored as splicing slack and maintenance coils, actually furnished installed and tested.

Basis of Payment: FIBER OPTIC CABLE of the number of fibers specified shall be paid for at the contract unit price per foot, which cost shall include the cost of furnishing all labor, material, documentation, tools and equipment to install and test the fiber optic cable.

Fiber optic termination panels, splice closures, connectors, splice vaults and hand holes will be supplied and paid for under other contract items.

GF02 Fiber Optic Lateral Installation SM

Description: Work under this item shall consist of furnishing and installing a fiber optic termination panel, 12 SM fiber optic cable, splice closure, pigtails and patch cords, testing, and documentation to connect a surveillance cabinet or pump station to the trunk or distribution cable.

Materials, Construction Requirements, and Installation:

- Fiber optic cable refer to GF01 requirements
- Fiber optic termination panel refer to GF04 requirements
- Splice Closure, refer to GF01 requirements
- Pigtails, patch cords, testing and documentation, refer to GF01 requirements

Method of Measurement: The fiber optic lateral installation single mode shall be measured for payment at the contract unit price each which cost shall include the cost of furnishing all labor, materials, documentation, tools and equipment to install, test, and make the location operational.

Basis of Payment: This work will be paid for at the contract unit price per foot for Fiber Optic Lateral Installation SM, which price shall include furnishing and installing the 12 SM fiber optic cable, splice closure, pigtails and patch cords, testing, and documentation to connect a surveillance cabinet or pump station to the trunk or distribution cable, as directed by the Engineer.

GF03 Fiber Optic Cable, Hybrid 12 MM And 12 SM

Description: This work shall conform with Section 871 of the Standard Specification for Road and Bridge Construction and District Traffic Signal Specifications as directed by the Signal Engineer.

Method of Measurement: The Fiber Optic Cable, Hybrid 12 MM and 12 SM, shall be measured for payment at the contract unit price each which cost shall include the cost of furnishing all labor, materials, documentation, tools and equipment to install, test, and make the location operational.

Basis of Payment: This work will be paid for at the contract unit price per foot for Fiber Optic Hybrid 62.5/125 multimode (MM) 12 fiber and single mode 12 fiber, which price shall include furnishing and installing the fiber optic cable, necessary slack, cable termination and testing, distribution, enclosures, breakout kits, connectors,

lashing wire, messenger wire, splices, pigtail assemblies and all other materials, hardware, and labor necessary to complete the installation as directed by the Signal Engineer. The single mode fiber shall comply with the requirements in GF01. In addition to traffic signal use, this item may also be used at pumping stations and other highway systems.

GF04 Fiber Optic Termination Panel, 12F or 24F

Description: Work under this item shall consist of furnishing and installing a fiber optic termination panel, type and size as specified on the plans and described herein. This equipment will be used to link field equipment using single-mode fiber optic cable.

Materials: The fiber optic termination panel shall comply with the following requirements:

- The fiber optic termination panel shall be rack mountable or wall mounted
- Rack mounted termination panels shall be installed in 19” racks inside of ITS or 334 Type Cabinets or Pump Houses w/19” racks
- The fiber patch panel shall terminate pigtail fibers as called out on the Plans.
- The fiber optic termination panel shall allow termination of a fiber patch cord to interconnect outside plant fibers to fiber optic communication equipment
- Shall be supplied with optical splice tray and holder
- Wall mounted termination panels shall be installed in Pump Station, Type III, Type IV, or Type V control Cabinets
- Wall-mounted termination panels shall be made out of solid steel construction, shall be powder coated, and feature top or bottom cable entry w/dust resistant grommets.
- Rack-mounted units shall be aluminum material per ATSMB 209, powder coated, and modular design.
- The approved type optical connectors on the end of each pigtail shall screw into a sleeve securely mounted to a patch panel within the controller cabinet. The maximum optical loss across the connection shall not exceed 0.25 dB.
- The fibers with the optical connectors on the pigtail cable shall be routed through and secured in the fiber optic termination panel as directed by and to the satisfaction of the Engineer.
- The bulkheads or single-mode adapter types shall be single-mode ST compatible, ceramic, unless a substitute is approved by the Engineer.

Construction Requirements

The Fiber Optic Termination Panel shall be installed in the Traffic Signal, surveillance cabinets or pump stations as specified on the Plans. The panels shall come with cable strain relief hardware and pull out label for administrative documentation. All work shall be neat and in a workmanlike manner. Particular care shall be taken as to not crush or kink the fiber optic cable. If in the opinion of the engineer the cable has been crushed or kinked, the entire cable span shall be removed and replaced at the Contractor’s expense.

The approved type of single-mode connectors on the end of each pigtail must screw into a sleeve securely mounted to the termination panel within the fiber termination panel enclosure. The panel must be provided with pre-connectorized and pre-wired port modules.

Method of Measurement: The fiber optic termination panel, 12 F or 24F, shall be measured for payment at the contract unit price each which cost shall include the cost of furnishing all labor, materials, documentation, tools and equipment to install, test, and make the location operational.

Basis of Payment: Fiber Optic Termination Panel, 12F or 24F will be paid for at the Contract unit price each. This price shall be payment for furnishing and installing the Fiber Optic Termination Panel, 12F or 24F along with any necessary fiber optic patch cords and any other materials, hardware, and labor necessary to complete the installation.

GF05 Fiber Optic Patch Panel 96 SM

Description: This item shall consist of furnishing and installing a 96 port, ST or SC style, rack or wall mounted, patch panel for single mode fiber. The hardware shall include label holders, numbered ports, front and rear cable management rings. Splicing shall be as described in GF01. Materials shall be as described in GF04.

Method of Measurement: The fiber optic patch panel, 96 SM, shall be measured for payment at the contract unit price each which cost shall include the cost of furnishing all labor, materials, documentation, tools and equipment to install, test, and make the location operational.

Basis of Payment: The work will be paid for a the Contract unit price each for Fiber Optic Patch Panel 96 SM, which shall be payment in full for furnishing, delivering, installing, trimming, and organizing fiber optic cable and testing, supplying optical pigtailed and patch cords and all other materials and labor necessary to complete the installation.

GF06 Fiber Optic Splice Closure

Description: Work under this item shall consist of furnishing and installing a Fiber Optic Splice Closure as described in pay item GF01. Splicing shall be as described in pay item GF01.

Method of Measurement: The fiber optic solice enclosure, shall be measured for payment at the contract unit price each which cost shall include the cost of furnishing all labor, materials, documentation, tools and equipment to install, test, and make the location operational.

Basis of Payment: The work will be paid for at the contract unit price for Fiber Optic Splice Closure, which shall be payment in full for furnishing, delivering, installing, trimming, and organizing the fiber optic splice, testing, and all other materials and labor necessary to complete the installation.

GF07 Fiber Optic Innerduct, up to 1 1/2”

Description: The Contractor shall provide a continuous Spiral smooth innerduct installed in the 4” surveillance PVC duct system installed within the median barrier wall. The Polyethylene Plastic Duct shall conform to the following industry standards.

ASTM D3035 - Polyethylene plastic duct (SDR-PR) sized by controlled outside diameter.

ASTM D2247 - Standard specification for polyethylene plastic duct schedules 40 & 80 and sized by controlled outside diameter.

ASTM D1248 - Polyethylene plastics extrusions and molding materials.

The Spiral Ribbed Duct shall be orange in color unless otherwise specified elsewhere in the plans or by the Engineer.

Materials: The high density polyethylene used shall be consistent with PE334420 E/C as described in ASTM D 3350 as per Table 1. The resin properties shall meet or exceed the values set forth below for high density Polyethylene (HDPE).

Table 1 - Resin Properties

<u>ATSM TEST</u>	<u>Description</u>	<u>Valves HDPE</u>
D-638	Tensile Strength at yield PSI	3200min

D638	% Ultimate Elongation Value	400 min
D-746	Brittleness Temp.	-75°C max
D-256	Impact per inch of notch	3.4ft lb/in
D-1238	Melt index, g/10 min. Condition E	.4 max
D-1505	Density g/CM ³	.941-.959
D-1693	Environmental Stress Crack Resistance Condition B, F ₂₀	48 hrs.

Nominal Duct Size	Nominal Inside Diameter	Minimum Wall Thickness	Nominal Outside Diameter	Min Sup. Bend Radius
25mm (1")	28mm (1.101")	2.5mm (.097")	33mm (1.315")	300mm (12")
38mm (1.5")	39mm (1.534")	4.4mm (.173")	48mm (1.900")	432mm (17")

The ribbed duct shall have internally and externally designed longitudinal ribs for reduced pulling frictions and increased lubrication effectiveness.

A pre-lubricated pull tape shall be installed in the innerduct with a minimum tensile strength of 568 Kg or as recommended by manufacturer. The pull tape shall have accurate printed meter markings.

Installation: The Contractor shall install the ribbed duct in the 4" Surveillance PVC duct in the lower portion of the median barrier wall. The Contractor shall insure the ribbed duct is continuous with no breaks from one junction box or cross connect terminal to another and to the surveillance installation. Crushed or deformed ribbed inner duct shall not be used or accepted for use on the job.

Innerduct which passes through junction boxes shall have a termination approximately 2" beyond the terminal end of the 4" PVC duct terminated in the Junction Box.

Innerduct which passes through cabinet foundations shall have an upper termination approximately 2" above the top of the foundation. Ribbed inner duct shall be capped to prevent water and other contaminants from entering during construction operations. The duct shall be swabbed and blown clean of any debris before installation of cable.

Method of Measurement: The unit duct will be measured for payment in feet in place. Measurements will be made in straight lines between changes in direction and to the centers of equipment and boxes access points. 10 feet will be allowed when terminating cable at a controller. 3' of slack will be allowed at light pole, handholes, pull boxes, junction boxes, and similar locations.

All vertical unit duct will be measured for payment. The vertical distance required for breakaway devices, barrier walls, concrete pedestals, etc., and the depth of any burial will be measured. Changes in direction shall assume perfect straight line runs, ignoring actual raceway sweeps.

Basis of Payment: This item will be paid at the contract unit price per lineal feet of FIBER OPTIC INNERDUCT, UP TO 1 1/2". The price will be payment in full for furnishing the specified size duct in place and connected at its terminal.

GF08 Fiber Optic Cable, Install Only

Description: This item shall consist of retrieving from the owner's storage facility, installing and testing a single mode fiber optic cable of the type, size, and number of fibers specified, at the locations shown in the plans. Splicing, testing, splice closures, documentation and all other miscellaneous equipment to make a complete and operational system shall be as described in GF01, termination and or patch panels, shall be as described in GF04 or GF05, fiber optic splice closure shall be as described in GF06.

Pre-Installation Testing at the Owners' Storage Facility: An optical domain reflectometer (OTDR) shall be used to evaluate the length and quality of cable reels prior to their use on the project. Testing shall be done as described in GF01. Cable which does not meet the requirements set forth in GF01 shall not be installed on the project. It is the Contractor's responsibility to ensure that the fiber is suitable for installation. If cable which does not meet GF01 and is installed, the Contractor shall remove said cable at this/her own expense. Contractor shall make the Engineer aware of the cable which does not meet the Specification. The Engineer will assign an alternate reel or length of cable for installation on the project. The Contractor will be responsible for testing all cable assigned for install under this pay item. The Contractor shall not be entitled to extra compensation for testing multiple cable reels or cable lengths.

Method of Measurement: The fiber optic cable shall be measured for payment at the contract unit price each which cost shall include the cost of furnishing all labor, materials, documentation, tools and equipment to install, test, and make the location operational.

Basis of Payment: The installation of fiber optic cable shall be measured in feet of cable actually installed between controllers. This work will be paid for at the contract unit price per foot for fiber optic cable installed only of the type, size, and number of conductors specified, which price shall include retrieving, loading, transporting, installing, and all necessary slack to connect between controllers. Patch panels, inner duct, termination panels, and splice closures shall be paid for separately.

GFC1 Foundation, Concrete, Type 1

Description

Concrete foundations shall be constructed to support ITS equipment cabinets (Type 1 foundations) at locations as indicated on the Plans. This work shall include installing any necessary hardware (entering conduits, bolts, anchor rods, grounding, etc.) as shown on the Plans. This work shall also include any topsoil, fertilizing, seeding, and mulching of the distributed areas in accordance with Sections 211, 250, and 251 of the Standard Specifications.

Materials

Type 1 concrete foundations shall be according to materials defined in Article 835.02 of Section 836 of the Standard Specifications. All anchor bolts shall be in accordance with Section 1006.09 of the Standard Specifications except that all anchor bolts shall be hot dipped galvanized full length of the anchor bolt including the hooks. Anchor bolts shall provide bolt spacing as shown in the Plans and as required by the cabinet manufacturer.

The Type 1 concrete foundations shall also be fabricated in accordance with Section 1070 of the Standard Specifications. These concrete foundations shall be fabricated from material new and unused in any previous application. The manufacturer shall provide a Certificate of Compliance that the materials are new and meet the specified requirements in accordance with the Standard Specifications and as shown on the Plans.

Construction Requirements

The Engineer will determine the final placement of the Type 1 concrete foundations. Type 1 concrete foundation dimensions shall be in accordance with those dimensions shown in the Plans on the detail sheet "Concrete Foundation Type 1 (Model 334 Cabinet) Detail". The foundation shall be located as required in order to avoid existing and relocated utilities. The top of the foundation shall be finished level. Shimming of the appurtenance to be attached will not be permitted.

Prior to pouring the foundation, the Contractor shall check the Plans for the specific number, size, and direction of conduit entrances required at the given location. All conduits in the foundation shall be installed rigidly in place before concrete is deposited in the form. Bushings shall be provided at the ends of the conduit. Anchor rods and ground rod shall be set in place before the concrete is deposited by means of a template constructed to space the anchor rods according to the pattern of the bolt holes in the base of the appurtenance to be attached. The appurtenances shall not be erected on the foundation until the bases have cured for at least (7) days. The Concrete shall cure according to Article 1020.13 of the Standard Specifications.

Method of Measurement

Concrete foundations shall be measured for payment, in feet of the concrete foundation in-place installed in accordance with the total length of concrete foundation required for Type 1 foundations as indicated on the Plans and as directed by the Engineer. Extra foundation depth, beyond the directive of the Engineer, will not be measured for payment.

Basis of Payment

Payment will be paid for at the Contract unit price, per foot of FOUNDATION, CONCRETE, TYPE 1, of the diameter and length indicated. The price shall include payment in full for all necessary excavation, backfilling, disposal of unsuitable material form work, furnishing, installing, and testing all materials (entering conduits, bolts, anchor rods, grounding, etc.) within the limits of the foundation. Any topsoil, fertilizing, seeding, and mulching of the distributed areas as well as all associated labor is to be included in this Contract unit price.

GFR1 Foundation Removal

Description. This item shall consist of removing a metal foundation or concrete foundation to a level at least three feet below the adjacent grade, disposing of the foundation outside the right-of-way, backfilling the excavated areas with approved material and reconstructing the surface to match the adjoining area. If the concrete foundation is located in the sidewalk area, the entire sidewalk square or squares where the concrete foundation is located shall be replaced with new sidewalk.

This item shall conform with Section 444 of the Traffic Specifications and as required by the Engineer.

General. Concrete foundations shall be removed to at least 2 ft. below grade with removed material disposed of off the site. The metal foundations shall be removed completely from the ground. The removal shall extend deeper where required to facilitate roadway construction at no additional cost. Underground conduits and cables shall be separated from the foundation at 2-1/2 ft. below grade and shall be abandoned or re-used as indicated.

The space caused by the removal of the foundations shall be back-filled with trench backfill in accordance with Section 208 of the Standard Specifications.

The removal of an existing concrete foundation shall meet the requirements of Section T444 of the Traffic Specifications.

The removal of a concrete foundation three feet or less in depth below grade shall be removed completely and disposed of outside of the right-of-way. A concrete foundation greater than three feet in depth shall have the first three feet below grade removed and disposed of outside of the right-of-way.

The area where the foundations have been removed shall be backfilled and restored to meet the existing grade and terrain.

Basis of Payment. This item shall be paid at the contract unit price each for FOUNDATION REMOVAL, which shall be payment in full for the removal and disposal of a foundation as specified herein.

GGR1 Ground Rod

Description. This item shall consist of furnishing, installing and connecting ground rods for the grounding of service neutral conductors and for supplementing the equipment grounding system via connection at poles or other equipment throughout the system. Ground wires and connection of ground rods at poles shall be included in this pay item. All materials and work shall be in accordance with Article 250 of the NEC.

Articles 806, and 1087.01 of the Standard Specifications for Road and Bridge Construction, Current version, shall apply to this pay item.

For Traffic Signal Applications, the District 1 Traffic Signal Specifications and the District 1 Standard Traffic Signal Design details shall apply to this item.

Materials. Materials shall be according to the following Articles of Section 1000 - Materials

<u>Item</u>	<u>Articles/Section</u>
(a) Ground Rod	1087.01
(b) Copper Ground Wire	1066.02

Installation. All connections to ground rods, structural steel or fencing shall be made with exothermic welds. Where such connections are made to insulated conductors, the connection shall be wrapped with at least 4 layers of electrical tape extended 152.4 mm (six inches) onto the conductor insulation.

Ground rods shall be driven so that the tops of the rod are 24 inches below finished grade. Where indicated, ground wells shall be included to permit access to the rod connections. Where indicated, ground rods shall be installed through concrete foundations. Where ground conditions, such as rock, preclude the installation of the ground rod, the ground rod may be deleted with the approval of the Engineer.

Where a ground field of electrodes is provided, such as at control cabinets, the exact locations of the rods shall be documented by dimensioned drawings as part of the Record Drawings.

Ground rod connection shall be made by exothermic welds. Ground wire for connection to foundation steel or as otherwise indicated shall be stranded uncoated bare copper in accordance the applicable requirements of ASTM Designation B-3 and ASTM Designation B-8 and shall be included in this item. Unless otherwise indicated, the wire shall not be less than No. 2 AWG. Where connections are made to epoxy coated reinforcing steel, the epoxy coating shall be sufficiently removed to facilitate the exothermic weld.

Method of Measurement. Ground rods shall be counted, each, furnished and installed.

Basis of Payment. This item shall be paid at the contract unit price each for a GROUND ROD, which shall be payment in full for furnishing and installing the materials and work specified herein.

GH01–GH04 Handhole

Description. This item shall consist of furnishing and installing a handhole at the location shown on the plans or as diverted by the Engineer.

Material. Materials shall be according to Section 814 of the Standard Specifications for Road and Bridge Construction, current version, shall apply to this pay item. The outside cover shall contain a legend “IDOT TSC”, or “IDOT TRAFFIC”, or “IDOT LIGHTING” as directed by the engineer.

Installation. The installation of a handhole shall meet the requirements of Section T428 of the Traffic Specifications, except as follows: All concrete handholes are to be cast in place against undisturbed earth. No precast concrete handholes will be accepted. All conduits will enter the handhole at a depth of 30 in. except for the conduits between the curb and first handhole for detector loops when the handhole is less than 5 ft. from the detector loop.

Basis of Payment. This work will be paid for at the contract unit price each for:

GH01 HANDHOLE

GH02 HANDHOLE, FIBER OPTIC

GH03 HANDHOLE, HEAVY-DUTY (SURVEILLANCE, TRAFFIC, LIGHTING)

GH04 HANDHOLE, HEAVY-DUTY, DOUBLE

which price shall be payment in full for all necessary excavating, backfilling, disposal of unsuitable materials, and furnishing all materials within the limits of the handhole.

GH05 Handhole, Heavy Duty, Special

Description. This item shall consist of constructing a heavy-duty handhole, special extra large cast in place, complete with heavy duty frame and cover and in accordance with the following requirements and conforming in all respects to the lines, grades, and dimensions shown on the plans or as directed by the Engineer. All handholes shall be installed in accordance with the Standard Specifications for Road and Bridge Section 814 and TSC Typical TY-1TSC-400#15.

Materials. All materials shall conform to Section 1088.05 and 1088.06 of the Standard Specifications for Road and Bridge. All handholes shall be constructed of Class S1 concrete meeting the requirements of the Standard Specifications for Road and Bridge construction Article 1020.

Construction Details. Handhole of the type specified shall be constructed in accordance with the details shown on the plans and conform to the following requirements:

Concrete. Concrete construction shall be done in accordance with the provisions of Concrete for Structures and incidental Construction contained in the Standard Specifications for Road and Bridge Construction, Section 503

Placing Castings. Castings shall be set accurately to the finished elevation so that no subsequent adjustment will be necessary. Castings shall be set flush with a sidewalk or pavement surface. When installed in an earth shoulder away from the pavement edge, the top surface of the casting shall be 25.4 mm (1 inch) above the finished surface of the ground.

Backfilling. Any backfilling necessary under a pavement, shoulder, and sidewalk or within 60 cm (2 feet) of the pavement edge shall be made with sand or stone screenings.

Forming. Forms will be required for the inside face of the handhole wall, and across all trenches leading into the handholes excavation. The ends of conduits leading into the handhole shall fit into a conduit bell which shall fit tightly against the inside form and the concrete shall be carefully placed around it so as to prevent leakage. Handhole walls shall be 10 inches.

French Drain. A French drain conforming to the dimensions shown on the plans shall be constructed in the bottom of the handhole excavation.

Steel Hooks. Each handhole shall be provided with four galvanized steel hooks of appropriate size, one on each wall of the handhole.

Frame and Cover. The outside of the cover shall contain a Type “G” handle for lifting and a legend “IDOT” “TSC” cast in. Frame shall be HD F&C 184 Kg (405 lbs.)

Hinges. Type “T” hinges required only on heavy duty special only.

Cleaning. The handhole shall be thoroughly cleaned of any accumulation of silt, debris, or foreign matter of any kind, and shall be free from such accumulations at the time of final inspection.

Basis of Payment. This work will be paid at the contract unit price each for a HANDHOLE, HEAVY DUTY, SPECIAL, for Surveillance, which price shall be payment in full for all necessary excavating, backfilling, disposal of surplus material and form work, frame and cover, and furnishing all materials within the outside limits of the handhole:

GH06 Handhole, Remove

Description. This work shall consist of removing the frame and cover of an existing handhole, breaking off the top section of the handhole wall to a minimum depth of 6 inch below the surrounding grade, or as specified, disposing of the concrete debris outside the right-of-way, backfilling the hole with approved material, reconstructing the surface to match the adjoining area, and disposing of the frame and cover as directed by the Engineer. If the handhole is located in the sidewalk area, the entire sidewalk square or squares where the handhole is located shall be replaced with new sidewalk per applicable contract pay items.

Method of Measurement. Remove handhole shall be counted, each.

Basis of Payment. This work will be paid for at the contract unit price each for HANDHOLE, REMOVE which price shall be payment in full for all labor and materials necessary to complete the work as described herein.

GH07 Handhole, Rebuild

Description. This item shall consist of rebuilding and bringing to grade a handhole at a location shown on the plans or as directed by the Engineer.

General. The work shall consist of removing the handhole frame and cover and the wall of the handhole to a depth of 203.2 mm (8 in.) below the finished grade. Upon completion, four (4) holes, 101.6 mm (4 in.) in depth and, 12.7 mm (1/2 in.) in diameter, shall be drilled into remaining concrete; one hole centered on each of the four handhole walls. Four (4) #3 steel dowels, 203.2 mm (8 in.) in length, shall be furnished and shall be installed in the drilled holes with a masonry epoxy.

All concrete debris shall be removed from State right-of-way to a location approved by the Engineer.

The area adjacent to each side of the handhole shall be excavated to allow forming. All steel hooks, handhole frame, cover, and concrete shall be provided to construct a rebuilt handhole according to applicable portions of Section 814 of the Standard Specification for Road and Bridge Construction. (The existing frame and cover shall be replaced if it was damaged during removal or as determined by the Engineer.)

Method of Measurement. Each handhole, which is rebuilt, shall be counted as a unit of payment.

Basis of Payment. This work will be paid for at the contract unit price each for HANDHOLE, REBUILD, which price shall be payment in full for all labor, materials, and equipment necessary to complete the work described above and as indicated on the drawings.

GH08 Handhole, Rebuild Existing Handhole To Heavy-Duty

Description. This item shall consist of partial removal of an existing concrete traffic single handhole, reconstruction to the specifications of heavy duty handhole including new frame and cover, at location(s) shown in the plans or as directed by the Engineer.

General. The work shall consist of removing the existing handhole frame and cover and the wall of the handhole to a depth of 381 mm (15 in.) below the finished grade. Upon completion, four (4) holes, 101.6 mm (4 in.) in depth and, 12.7 mm (1/2 in.) in diameter, shall be drilled into the top of the remaining concrete; one hole centered on each of the four handhole walls. Four (4) #3 steel dowels, 203.2 mm (8 in.) in length, shall be furnished and shall be installed in the drilled holes with a masonry epoxy. All concrete debris shall be removed from State right-of-way to a location approved by the Engineer. Any pavement or asphalt surface removal required to install the new concrete shall have straight and neat edges using a method approved by the Engineer. Care shall be taken to protect the existing traffic signal cable. Any cable damage shall be reported immediately and repaired as directed by the Area System Engineer.

All steel hooks, handhole frame, cover, and concrete shall be provided to construct a rebuilt heavy duty handhole according to applicable portions of Section 814 of the Standard Specification for Road and Bridge Construction.

Method of Measurement. Each existing handhole, which is partially removed and reconstructed to a heavy-duty handhole, complete, shall be counted as a unit payment.

Basis of Payment. This work will be paid for at the contract unit price each for HANDHOLE, REBUILD EXISTING HANDHOLE TO HEAVY-DUTY TYPE, which price shall be payment in full for all labor, materials, and equipment necessary to complete the work described above and as indicated on the drawings.

GIG1 Inspection, Standby Generator

Description. The Contractor shall furnish a factory trained service representative to complete a comprehensive generator inspection, as specified herein, at designated locations.

Locations. This work shall apply to generators at the Pump Stations, Base Stations, Traffic Systems Center (TSC) Moveable Bridges (Extra Systems) and two (2) in state stock.

Work Description. The inspection shall consist of, but not limited to the following items, which are described on form GIG1.

- 1) Cooling System
- 2) Fuel System
- 3) Air Induction and Exhaust System
- 4) Lube Oil System
- 5) Starting System
- 6) Engine Monitors and Safety Controls
- 7) Generator Accessories
- 8) Control Panel
- 9) Gas Engine
- 10) Megometer Test
- 11) Load Bank Test
- 12) Switch Gear Inspection

Method of Measurement. Each inspection that is completed according to form GIG1 and the inspection report submitted and approved by the Engineer shall be counted as unit for payment.

Basis of Payment. This item shall be paid at the contract unit price, each, for INSPECTION, STANDBY GENERATOR, which shall be payment in full for the work described herein.

Generator Inspection Service List

AGREEMENT NO.	CUSTOMER (NAME AND ADDRESS)	ACCOUNT NO.
GENERATOR SET LOCATION		CONTRACT
TELEPHONE NO.		
ENGINE MODEL	SERIAL NO.	SERVICE METER
DATE		
GENERATOR MODEL	SERIAL NO.	VOLTS
KILOWATTS		

SERVICE ITEMS	SATIS-FACTORY	UNSATIS-FACTORY	COMMENTS
COOLING SYSTEM			
1. RADIATOR/HEAT EXCHANGER	<input type="checkbox"/>	<input type="checkbox"/>	
2. COOLANT	<input type="checkbox"/>	<input type="checkbox"/>	
3. HOSES AND CONNECTORS	<input type="checkbox"/>	<input type="checkbox"/>	
4. FAN DRIVE PULLEY AND FAN	<input type="checkbox"/>	<input type="checkbox"/>	
5. FAN BELTS	<input type="checkbox"/>	<input type="checkbox"/>	
6. JACKET WATER HEATER	<input type="checkbox"/>	<input type="checkbox"/>	
7. WATER PUMP	<input type="checkbox"/>	<input type="checkbox"/>	
8. THERMOSTATS	<input type="checkbox"/>	<input type="checkbox"/>	
FUEL SYSTEM			
9. FUEL TANK	<input type="checkbox"/>	<input type="checkbox"/>	
10. WATER TRAP SEPARATOR	<input type="checkbox"/>	<input type="checkbox"/>	
11. FUEL LINES & CONNECTORS	<input type="checkbox"/>	<input type="checkbox"/>	
12. GOVERNOR & CONTROLS	<input type="checkbox"/>	<input type="checkbox"/>	
13. FUEL FILTERS-PRIM./SEC.	<input type="checkbox"/>	<input type="checkbox"/>	
14. FUEL PRESSURE	<input type="checkbox"/>	<input type="checkbox"/>	
AIR INDUCTION AND EXHAUST SYSTEM			
15. AIR FILTER	<input type="checkbox"/>	<input type="checkbox"/>	
16. AIR FILTER SERVICE INDICATOR	<input type="checkbox"/>	<input type="checkbox"/>	
17. AIR INLET SYSTEM	<input type="checkbox"/>	<input type="checkbox"/>	
18. TURBOCHARGER	<input type="checkbox"/>	<input type="checkbox"/>	
19. EXHAUST MANIFOLD	<input type="checkbox"/>	<input type="checkbox"/>	
20. EXHAUST SYSTEM	<input type="checkbox"/>	<input type="checkbox"/>	
21. VALVES & VALVE ROTATORS	<input type="checkbox"/>	<input type="checkbox"/>	RECOMMEND LOAD BANK <input type="checkbox"/> YES <input type="checkbox"/> NO
LUBE OIL SYSTEM			
22. OIL	<input type="checkbox"/>	<input type="checkbox"/>	
23. OIL FILTERS	<input type="checkbox"/>	<input type="checkbox"/>	
24. OIL PRESSURE	<input type="checkbox"/>	<input type="checkbox"/>	
25. CRANKCASE BREATHER	<input type="checkbox"/>	<input type="checkbox"/>	
26. S-O-S	<input type="checkbox"/>	<input type="checkbox"/>	
STARTING SYSTEM			
27. BATTERIES	<input type="checkbox"/>	<input type="checkbox"/>	
28. BATTERIES-SPECIFIC GRAVITY	<input type="checkbox"/>	<input type="checkbox"/>	
29. BATTERY CHARGER	<input type="checkbox"/>	<input type="checkbox"/>	
30. STARTING MOTOR	<input type="checkbox"/>	<input type="checkbox"/>	
31. ALTERNATOR	<input type="checkbox"/>	<input type="checkbox"/>	
ENGINE MONITORS AND SAFETY CONTROLS			
32. GAUGES	<input type="checkbox"/>	<input type="checkbox"/>	
33. SAFETY CONTROLS	<input type="checkbox"/>	<input type="checkbox"/>	
34. REMOTE ANNUNCIATORS/ALARMS	<input type="checkbox"/>	<input type="checkbox"/>	

Generator Inspection Service List (CONT.)

SERVICE ITEMS	SATIS-FACTORY	UNSATIS-FACTORY	COMMENTS
GENERATOR			
35. BEARINGS	<input type="checkbox"/>	<input type="checkbox"/>	
36. SLIP RINGS & BRUSHES	<input type="checkbox"/>	<input type="checkbox"/>	
37. SPACE HEATERS	<input type="checkbox"/>	<input type="checkbox"/>	
38. VIBRATION ISOLATORS	<input type="checkbox"/>	<input type="checkbox"/>	

CONTROL PANEL			
39. START CONTROLS-MAN./AUTO	<input type="checkbox"/>	<input type="checkbox"/>	
40. VOLTMETER	<input type="checkbox"/>	<input type="checkbox"/>	
41. AMMETER	<input type="checkbox"/>	<input type="checkbox"/>	
42. FREQUENCY METER	<input type="checkbox"/>	<input type="checkbox"/>	
43. CIRCUIT BREAKER	<input type="checkbox"/>	<input type="checkbox"/>	
44. AUTO TRANSFER SWITCH	<input type="checkbox"/>	<input type="checkbox"/>	

GAS ENGINE			
45. GAS LINES & CONNECTORS	<input type="checkbox"/>	<input type="checkbox"/>	
46. CARBURETOR & LINKAGE	<input type="checkbox"/>	<input type="checkbox"/>	
47. MAGNETO/DISTRIBUTOR	<input type="checkbox"/>	<input type="checkbox"/>	
48. IGNITION SYSTEM	<input type="checkbox"/>	<input type="checkbox"/>	
49. SPARK PLUGS	<input type="checkbox"/>	<input type="checkbox"/>	

MEGOHMETER TEST			
50. MAIN STATOR	<input type="checkbox"/>	<input type="checkbox"/>	
51. MAIN ROTOR	<input type="checkbox"/>	<input type="checkbox"/>	
52. EXCITER STATOR	<input type="checkbox"/>	<input type="checkbox"/>	
53. EXCITER ROTOR	<input type="checkbox"/>	<input type="checkbox"/>	

LOAD BLANK TEST			
54. REGULATOR MFG. _____			
55. EACH OF THE SPECIFIED LOADS SHALL BE TESTED FOR A HALF HOUR.			
56. REGULATOR MODEL _____			
57. HOUR METER START _____ STOP _____			
58. RACK SETTING _____			
59. VOLTAGE STABILITY _____			

60. PERCENT OF LOAD	0%	25%	50%	75%	100%					
61. KW METER										
62. VOLTMETER L1 TO L2										
63. VOLTMETER L2 TO L3										
64. VOLTMETER L3 TO L										
65. AMMETER L1										
66. AMMETER L2										
67. AMMETER L3										
68. FREQUENCY METER-HZ										
69. ELAPSED TIME METER-HOURS										
70. ENGINE SPEED-RPM										
71. LUBE OIL PRESSURE-PSI										
72. WATER TEMPERATURE (F)										
73. FUEL OIL PRESSURE-PSI										
74. AMBIENT TEMPERATURE (F)										
75. LUBE OIL TEMPERATURE-IN										
76. LUBE OIL TEMPERATURE-OUT										

COMMENTS/RECOMMENDATIONS:

 SERVICE TECHNICIAN DATE CUSTOMER REPRESENTATIVE DATE

Generator Inspection Service List (CONT.)

Switchgear Inspection Check

Automatically start engine and transfer load.

(record time it takes to start engine.)

Run engine for ½ hour and take following readings:

1. Amps
2. Volts
3. Oil Pressure
4. Water Temperature
5. Fuel Pressure
6. Frequency
7. Kilowatts
8. R.P.M.
- 9.
- 10.

Automatically stop engine and observe for proper shutdown.

- | | |
|--------------------------------|----------------------|
| 1. Automatic Transfer Switches | Observe, Work, Clean |
| 2. Contacts | Observe, Work, Clean |
| 3. Relays | Observe, Work, Clean |
| 4. Timers | Observe, Work, Clean |
| 5. Indicators | Observe, Work, Clean |

Automatic start and Load Transfer

- | | | |
|-------------------------------------|-------|---------|
| 1. Time delay for start signal | _____ | seconds |
| 2. Time engine to start and pick-up | _____ | seconds |
| 3. Total | _____ | seconds |

Automatic Load Retransfer and engine stop signal

- | | | |
|--|-------|---------|
| 1. Time for normal restoration to retransfer | _____ | minutes |
| 2. Unload running time | _____ | minutes |
| 3. Total | _____ | minutes |

Comments: _____

Description. This work shall consist of furnishing equipment, materials and labor for a thermo graphic inspection of electrical systems, including the main service entrance panel, and sub panels at the maintenance yards and other facilities in District 1, as specified by the Engineer. The testing must be performed by a qualified company, with prior experience in such type of testing, and shall be approved by the Engineer. An inspection report, including thermo graphs of the equipment tested and deficiencies noted, shall be furnished.

Method of Measurement. Each inspection that is completed, and report submitted and approved by the Engineer, shall be counted as unit for payment.

Basis of Payment. This work shall be paid at the Contract unit price each, for INSPECTION, THERMO GRAPHIC, of the facility specified, which shall be payment in full for the work as described herein.

GJ01 Junction Box And All Appurtenances, Remove

Description. This work shall consist of completely removing an existing junction box and all appurtenances, being careful not to damage those existing conduits which will be re-used in the system. In case of an existing conduit being damaged, a new conduit will be furnished in place. The repair work will not be paid for separately, but will be incidental to this bid item. The junction box and cover will be disposed of as directed by the Engineer and all debris removed beyond the right-of-way.

Method of Measurement. Each junction box, which is removed including all appurtenances, shall be counted as a unit of payment.

Basis of Payment. This work will be paid for at the contract unit price each for JUNCTION BOX AND ALL APPURTENANCES, REMOVE, which price shall be payment in full for all labor and material necessary to complete the work as described above.

GJ02 Junction Box, Inline Connectors and Termination

Description. This item shall consist of furnishing and installing U1B inline connectors and U1Y bridging inline connectors in a junction box type "J" in the expressway median barrier wall as directed, in writing, by the Engineer.

Installation. There is an existing 100C - No. 19 telecommunication cable in the expressway median barrier wall. This cable is "spliced" in junction box type "J" at each surveillance installation and every 1500 ft. in the barrier wall. In the junction box type "J", the Contractor shall remove the existing S66 telephone type terminal blocks and the Plate bracket. The Contractor shall re-terminate the 100C-No. 19 cable with the incoming 6C - No. 19 cable installation using Scotchlok Brand U1B inline, sealed, moisture resistant four wire (1 full pair) connector for solid copper (16-19 AWG) cable. The 100C - No. 19 cable shall be joined bundle for bundle, cable pair for cable pair in the junction box type "J" with the U1B and U1Y connectors. A special crimping tool shall be required for installing the Scotchlok inline connectors. All cabling shall be tied and placed in the "J" box in a neat workmanlike manner. The Contractor shall clean the interior of the "J" box ensuring it is free of debris, water and any corrosion. The Contractor shall ensure that the shielding of both incoming cables are properly bonded together with 10 AWG wire and stainless steel clamps. Contractor shall be responsible for the cost of any and all expressway lane and/or shoulder closures required to complete the work in the median barrier wall. Miscellaneous hardware shall not be paid for separately but considered as incidental to the cost of this item.

Method of Measurement. Electric cable inline connectors, shall be counted, each.

Basis of Payment. This work shall be paid at the contract unit price each, JUNCTION BOX, INLINE CONNECTORS AND TERMINATION, which shall be payment in full for the work as described herein.

GJ03–GJ04 Junction Box, Stainless Steel

Description. This item shall consist of furnishing and installing a stainless steel junction or pull box of the size indicated in locations shown on the contract drawings and as directed by the Engineer.

Section 813 and 1088 of the Standard Specifications for Road and Bridge Construction, Current version, shall apply to this pay item with the following exceptions: Revise the second sentence of the third paragraph of Article 1088.04 of the Standard Specifications to read: "The gasket shall be extruded directly onto the junction box cover."

Basis of Payment. This work shall be paid for at the contract unit price each for:
GJ03 JUNCTION BOX, STAINLESS STEEL, UP TO 6 INCH DEPTH
GJ04 JUNCTION BOX, STAINLESS STEEL, 8 INCH DEPTH
of the size indicated, which shall be payment in full for the work as described herein.

GMR1 Median, Remove and Replace

Description. This work consist of removing and disposing of the existing concrete or asphalt median and the replacement with new materials of a type similar to that which is existing, in accordance with the applicable portions of Sections 402, 442, 701 and 1001 of the Standard Specifications for Road and Bridge Construction.

Materials. The replaced median surface shall be of similar material and thickness as the median surface removed under this item.

If the median is partially removed, the Contractor shall machine-saw a perpendicular clean joint between that portion of the median to be removed and that which is to remain in place. The depth of removal shall be as directed by the Engineer to accommodate the proposed cross-section of the median replacement material. If the Contractor removes or damages any median or pavement outside the limits of designated remove, he shall remove and replace that portion at his own expense to the satisfaction of the Engineer. Asphalt surface repair shall require saw cutting and removal of the damaged area to provide a straight vertical edge prior to the replacement of surface material.

Installation. Where the existing median to be removed is on top of existing pavement, the Contractor shall remove loose or spilled concrete and clean the pavement surface prior to the placement of the new median or resurfacing. If the median to be removed was doweled to the existing pavement, the Contractor shall remove the dowels by cutting off flush with the pavement surface or removing entirely. Any holes caused by the removal of dowel bars shall be filled with grout.

The limits of the removal and replacement indicated on the drawings are approximate only. Removal and replacement shall take place up to an existing joint in PCC medians, or as directed by the Engineer. If the Engineer directs removal of the median surface other than at an existing joint, the Contractor shall saw cut the median surface at the points of removal.

Method of Measurement. Median removal and replacement shall be measured for payment by square foot in place. Measurements shall be made at the limits of designated removal and depth as directed by the Engineer.

Basis of Payment. This work shall be paid for at the contract unit price per square foot to MEDIAN, REMOVE AND REPLACE, which price includes all labor, material and equipment necessary to remove, dispose of, and replace the existing concrete or asphalt median regardless of its depth, as specified herein.

GPC1 Pump, Calcium Chloride

Description. This item shall consist of removing, furnishing and installing a stainless steel 1 HP, centrifugal pump for calcium chloride spray as specified herein.

Materials. The stainless steel pump shall be extremely resistant to corrosion and able to handle acids, caustics, chemicals. The motor shall be rated for continuous duty, totally enclosed fan cooled and generates at least 3450 rpm with a closed impeller. The motor shall be UL listed and CSA certified.

Installation. The Contractor shall remove the existing pump, if applicable, for calcium chloride spray at the maintenance yard and replace with the stainless steel pump as specified herein. It shall be wired as per NEC requirement. The cable and conduit if corroded shall be replaced during the installation. It shall be paid separately using non-routine pay items.

Method of Measurement. Stainless steel centrifugal pump of HP as indicated, furnish and install complete with wiring, shall be counted, each.

Basis of Payment. This work shall be paid at the contract unit price to furnish and install STAINLESS STEEL CENTRIFUGAL PUMP, up to 1 HP, which price includes all labor, material and equipment necessary to remove, dispose of, and replace the existing pump, as specified herein.

GRB1 Radio Tower Beacon, Relamp

Description. This item shall consist of furnishing the parts, labor and equipment to restore flashing beacon light and group relamp the remaining lights at that elevation on a District 1 communication microwave tower, within 24 hours of notification, as specified herein by the Engineer.

General. The District 1 has radio towers located in six counties listed in Section 3 that have flashing beacon lights manufactured by Honeywell or an equivalent, for lighting and other obstructions to aerial navigation as specified by the FAA, FCC. The optical system is designed to provide a definite 360 degrees horizontal beam. The beacon must be used with a beacon flasher or tower lighting control installed inside the control room to achieve the proper flash rate.

The beacon light has either a mechanical flashers, immune to AM tower RF frequencies, or an electronic lighting controls to flash several lights on tower, including a photocell for automatic day/ night operation.

Outage. The outage is reported by the night outage patrolman, regular patrolman or called in by District 1 ComCenter to the contractor's dispatch center. The contractor should dispatch immediately and respond to the call to check for the outage. The patrolman shall inspect beacon light to isolate the problem by checking breaker, flasher circuit and associated controls. The defective component shall be reported within one (1) hour to District 1 ComCenter.

The defective lamp and the remaining lamps at that elevation shall be replaced within 24 hours of notification to restore the beacon lighting of the tower. If it needs a new or different flashing control board, the contractor should order the part by over night delivery or furnish temporary lighting to restore beacon lighting within 24 hours at no extra cost to this pay item.

Method of Measurement. Microwave tower flashing beacon light restored, and group relamp of remaining lights at that elevation, shall be counted, each.

Basis of Payment. This work shall be paid at the contract unit price each for a RADIO TOWER BEACON, RELAMP, which price shall be payment in full for furnishing parts, labor and equipment to restore a beacon light and relamp the remaining lights at that elevation, as specified herein.

GRT1 Radio Tower, Budgetary Allowance

Description: This item is to establish a budget account to allocate funds for furnishing and installing a Radio Tower, at a location and of the type and height specified by the Engineer.

Basis of Payment: For the tower installation, the Engineer will assess the need, obtain FCC license, seek and evaluate bids and initiate authorizations accordingly. The estimated amount of the annual expenses for Radio Tower, furnished and installed as specified by an Engineer, which will be paid under Article 109.05 of the Standard Specifications for Road and Bridge Construction, is \$100,000. This amount shall be used for bidding purposes for pay item GRT1.

GRT2 Radio Tower, Inspection And Report

Description. This item shall consist of inspection, testing and reporting on District 1’s communication radio tower, as specified by the Engineer, by a factory approved service company, as described herein.

Materials. The specialty company shall furnish the necessary labor, equipment and tools to inspect and test radio tower, located in six (6) counties (refer to Section 3 for list of locations), as outlined on the “Tower Condition Report”. The specialty contractor shall be equipped with all recommended test equipment and provide the accompanying report data.

Work Description. The tower maintenance and inspection procedures shall be as per ANSI/TIA 222-G. Information on this document (including how to obtain a copy) can be found at “www.tiaonline.com/standards/catalog”. The copy can be accessed at: “www.nationwide.com/codes/codes/tia/Annexes/e_1.htm”

Reporting. The contractor shall submit a report of data for all items stated on the form. The report shall also include any pertinent changes made or required to the radio tower.

Method of Measurement. Each inspection of a radio tower location including submittal of its report and approved by the Engineer shall count as a unit for payment.

Basis of Payment. This work shall be paid at the contract unit price each for a RADIO TOWER, INSPECTION AND REPORT, which price shall be payment in full for submitting the report as specified herein.

GSD1 Sidewalk, Remove And Replace

Description. This work consist of the removal and disposal of existing sidewalk and the construction of new sidewalk at locations shown on the plans, in accordance with Sections 424 and 440 of the Standard Specifications for Road and Bridge Construction and as directed by the Engineer.

Method of Measurement. Sidewalk removal and replacement shall be measured for payment in place and the area computed in square feet.

Basis of Payment. This work will be paid for at the contract unit price per square feet for SIDEWALK, REMOVE AND REPLACE, which price includes all labor, material and equipment necessary to remove and dispose of the existing sidewalk and to construct the new sidewalk as specified herein.

GSO1 Sodding

Description. This item shall conform to applicable requirements of Section 252 of the Standard Specifications for Road and Bridge construction. The Contractor shall prepare the ground surface, furnish, transport and install sod including labor and other materials required, as directed by the Engineer.

This item shall conform to Section T252 of the Standard Specifications.

Locations that are to be sodded will be shown on the plans or as directed by the Signal Engineer.

Basis of Payment. This work will be paid for at the contract unit price per square foot of SODDING, which price includes all labor, material and equipment necessary to furnish and place the sod, including sod watering as specified herein. Removal and disposal of the existing sod shall be incidental to the contract unit price.

GTC1 Traffic Control

Description. This item of work shall include furnishing, installing, maintaining, replacing, relocating and removing all traffic control devices used for the purpose of regulating, warning or directing traffic during maintenance or construction activities throughout this contract.

The Contractor shall contact the District One Bureau of Traffic at least 72 hours in advance of beginning work.

Basis of Payment. This work will be paid for at the contract unit price per each for TRAFFIC CONTROL of the closure type indicated, which price shall be payment in full for all labor to install, maintain, replace, relocate and remove all traffic control devices indicated in the plans, specifications, or authorizations.

Delays to the Contractor caused by complying with these requirements will be considered incidental to the item for traffic control and no additional compensation will be allowed for daytime or nighttime closures (or for traffic lanes or ramp closure) on the expressway.

GTR1 Trench and Backfill with Warning Tape

Description. This item shall consist of constructing and backfilling a trench for the accommodation of cables, duct or conduit as described in Section 819 of the Standard Specifications for Road and Bridge Construction, Current version, with the following exception: Delete the third paragraph of Article 819.03(a) except otherwise specifically directed by the Engineer

Method of Measurement.

- (a) Contract Quantities. The requirements for the use of contract quantities shall be according to Article 202.07 (a).
- (b) Measured Quantities. This work will be measured in feet along the centerline of the trench. Trench and backfill will not be measured for payment for conduit which is pushed. Where separate circuit runs are placed in a common trench, only one run will be measured for payment along the centerline of the parallel portion.

Basis of Payment. This work will be paid for at the contract unit price per feet for TRENCH AND BACKFILL WITH WARNING TAPE, of the depth specified. Excavation in rock will be classified and paid for as specified in Section 502.

GU01–GU03 Uniduct

Description. This item shall consist of furnishing, installing splicing, connecting, and testing of electric cable in unit duct of sizes specified herein and as shown on the contract drawings. The unit duct shall be an assembly of insulated conductors, which are factory pre-installed in a continuous flexible plastic duct.

The unit duct shall be manufactured and installed in accordance with NEC Article 354.

As stated in NEC Article 354.12, the unit duct shall not be used in exposed locations, and inside buildings except for termination purposes, and in hazardous (classified) locations.

Section 816 of the Standard Specifications for Road and Bridge Construction, current version, shall apply to this pay item.

Method of Measurement. The unit duct will be measured for payment in feet in place. Measurements will be made in straight lines between changes in direction and to the centers of equipment and boxes access points. 10 feet will be allowed when terminating cable at a controller. Three feet of slack will be allowed at light pole, handholes, pull boxes, junction boxes, and similar locations.

All vertical unit duct will be measured for payment. The vertical distance required for breakaway devices, barrier walls, concrete pedestals, etc., and the depth of any burial will be measured. Changes in direction shall assume perfect straight line runs, ignoring actual raceway sweeps.

Basis of Payment. This item will be paid at the contract unit price per linear feet for:

GU01 UNIDUCT, WITH EPR INSULATED CABLES, 3/C NO.6 & 1/C NO.8 GREEN, 1 INCH

GU02 UNIDUCT, WITH EPR INSULATED CABLES, 3/C NO.4 & 1/C NO.6 GREEN, 1 ¼ INCH

GU03 UNIDUCT, WITH EPR INSULATED CABLES, 3/C NO.2 & 1/C NO.6 GREEN, 1 ½ INCH

of the size of duct as indicated, which shall be payment in full for all material and work as specified herein.

GU04 Uniduct, Install Only

Description. This item shall consist of retrieving from Owner's storage facility, loading and installing, splicing, connecting, and testing of electric cable in unit duct of sizes specified herein and as shown on the contract drawings. The unit duct shall be an assembly of insulated conductors, which are factory pre-installed in a continuous flexible plastic duct.

As stated in NEC Article 354.12, the unit duct shall not be used in exposed locations, and inside buildings except for termination purposes, and in hazardous (classified) locations.

Section 816 of the Standard Specifications for Road and Bridge Construction, current version, shall apply to this pay item.

Method of Measurement. The unit duct will be measured for payment in feet in place. Measurements will be made in straight lines between changes in direction and to the centers of equipment and boxes access points. 10 feet will be allowed when terminating cable at a controller. Three feet of slack will be allowed at light pole, handholes, pull boxes, junction boxes, and similar locations.

All vertical unit ducts will be measured for payment. The vertical distance required for breakaway devices, barriers wall, concrete pedestals, etc., and the depth of any burial will be measured. Changes in direction shall assume perfect straight line runs, ignoring actual raceway sweeps.

Basis of Payment. This item will be paid at the contract unit price per linear feet for UNIDUCT, INSTALL ONLY, of the size of cut as indicated, which shall be payment in full for installing the item as specified herein.

GV01 EMCMS

Description. This item is to establish a budget account to allocate funds for hardware and software upgrades to obtain continued maintenance support from the software and hardware vendors of the Electrical Maintenance Contract Management System (EMCMS), if necessary, and as approved by the Engineer.

Basis of Payment. The required upgrades are described in Article 4.6.6. The estimated cost, which will be paid under Article 109.05 of the Standard Specifications for Road and Bridge Construction, is \$30,000. This amount shall be used for bidding purposes for pay item GV01.

GV02 Operational Support

Description. This item is to establish a budget account to allocate funds for the payment of EMCMS operational support maintenance, repairs, etc., in the EMCMS, as approved by the Engineer.

Basis of Payment. The Engineer will initiate authorizations accordingly. The total estimated amount of the annual expenses for operational support, which will be paid under Article 109.05 of the Standard Specifications for Road and Bridge Construction, is \$10,000. This amount shall be used for bidding purposes for pay item GV02.

GWR1–GWR2 Welding Receptacle And Plug

Description. Furnish and install welding receptacles and mating plug, 30 Amp or 60 Amp, 3 Poles, 208 Volts, or 2 poles, 240 Volts, complete with interlocked fusible disconnect switch, at the Maintenance Yards, Sign Shops and other Department facilities in District 1, as directed by the Engineer.

Installation. The installation shall include all hardware, junction box and other appurtenances. Removal of the existing receptacle and plug, if necessary, shall be included in this work. Conduit and wire installation shall be paid through other pay items, where needed.

Method of Measurement. Welding Receptacle and mating plug of the amperage and number of poles specified, furnished and installed shall be counted, each.

Basis of Payment. This work shall be paid for at the contract unit price each for WELDING RECEPTACLE AND PLUG, furnish and install, of the rating and number of poles specified by the Engineer, which price shall be payment in full for furnishing, delivering, storing, installing and connecting the receptacle, complete.

GWR1 Welding Receptacle, 30 Amp, Furnish and Install
GWR2 Welding Receptacle, 60 Amp, Furnish and Install

Lighting and Sign Illumination System Non-Routine Pay Items

LA01 Arm, or Twin Arm with Luminaire, Install Only

Description. This item shall consist of retrieving from Owner's storage facility, loading, and installing, one or two mast arms or twin arm with luminaires(s) and associated hardware on one light pole, as specified herein, at locations designated by the Engineer. Furnished arm(s) and/or luminaire(s) shall be paid separately.

Installation. Installation shall be in accordance with Article 830 of the Standard Specifications for Road and Bridge Construction, Current version.

The mast arm or arms shall be set at right angles to the centerline of the pavement, unless otherwise shown on the plan.

Each arm shall be mounted as indicated and as required for the permanent installation, or temporary lighting on wood pole installation.

This item shall be coordinated with the applicable luminaire (with pole wire and fusing), foundation and anchor bolts, breakaway device (if applicable) which shall be provided under separate pay items, as applicable.

The installation shall be complete with pole wire, fusing and connection to the applicable lighting feeder circuits, all incidental to this item.

Arms shall not be installed until luminaires are available for installation, which shall be at the same time the pole is installed. This item shall not be paid unless the coordinated assembly of the pole and luminaire is installed, complete.

The manufacturer's recommendations shall be followed during the installation process. The wiring connections shall be made in accordance with the National Electric Code. The Contractor shall energize the system to assure that all the components are working in accordance with their specifications and carrying rated load.

Method of Measurement. Arm, or twin arm, with luminaire(s), on light pole, shall be counted, each, installed.

Basis of Payment. This item shall be paid at the contract unit price each for **ARM, OR TWIN ARM WITH LUMINAIRE, INSTALL ONLY**, which shall be payment in full for installing the item as specified herein.

LB01 Breakaway Device, T-Base, Furnish and Install

Description. This item shall consist of furnishing and installing a breakaway device, transformer base, height specified, for standard, davit, or painted davit light pole, with all associated hardware, as specified herein.

Materials. Materials shall be according to Article 1070.04 of the Standard Specifications for Road and Bridge Construction, Current version, except that certification shall be submitted from the supplier that the device used under the conditions of the particular design meets the 1985 AASHTO breakaway specification.

Breakaway device, transformer base, information submitted for approval shall include any recommendations of the Manufacturer for storage as provided under this contract.

The packaging of the breakaway devices, transformer bases, shall incorporate the provisions recommended by the Manufacturer to accommodate storage.

Revise the second sentence of Article 1070.04(a)(1) of the Standard Specifications to read:

“Certification shall be submitted from the supplier that the device used under the conditions of the particular design meets the 1985 AASHTO breakaway specification.”

The breakaway device, transformer base for a painted davit light pole is normally installed on the Kennedy Expressway at Power Center C & D. The height, top and bottom bolt circle as specified on the plan submitted shall be used as part of this pay item.

Materials for Painted Davit Light Poles Only:

Preparation. Components shall receive a mild etch solvent cleaning.

Primer. Components shall receive two (2) coats of epoxy primer. The primer shall be a polyamide white epoxy primer with a corrosion inhibitor having a solid content, by volume, of not less than 65% (+/3%). Each coat shall be applied in a 3-5 dry MIL thickness.

Finish Coat. Components shall receive one finish coat of aliphatic urethane enamel having a solid content, by volume, of not less than 58% (+/3%). The finish coat shall have a dry MIL thickness of 1.5-2.5 mils. The color of the finish paint shall match that of the existing State owned davit poles which is Benjamin Moore Iron Clad Bronzitone No. 16360. A sample of the proposed paint color shall be submitted for approval to the Engineer.

General. The cleaning and finish work shall be performed indoors, under conditions of controlled temperature, humidity and dust in full conformance with the paint manufacturer’s recommendations, and in the presence of an authorized representative of the paint manufacturer.

The paint manufacturer shall certify, in writing that the preparation and finishing of the breakaway transformer base housings has been done properly and in conformance with the Manufacturer’s recommendations, and will furnish this certification, together with its standard warranty in triplicate, when the finishing is complete.

A certification from the paint manufacturer, attesting the intent to witness the finishing operation and to provide the above-referenced certification together with a copy of the paint manufacturer’s standard warranty shall be included with the pole submittal information.

Installation. Installation shall be in accordance with Section 838 of the Standard Specification for Road and Bridge Construction, Current version.

Manufacturer’s recommendations shall be followed during the installation process.

Add the following to Article 838.03(a) of the Standard Specifications:

“All nuts, bolts, washers, and lock washers required for the installation of the transformer base to the pole shall be included as a part of this item.”

Method of Measurement. Breakaway device, transformer base of the height, top and bottom bolt circle diameter specified for standard, davit, or painted davit light pole, shall be counted, each, furnished and installed.

Basis of Payment. This item shall be paid at the contract unit price each for BREAKAWAY DEVICE, T-BASE, FURNISH AND INSTALL, with all associated hardware, of the bolt circle and height as specified, which shall be payment in full for furnishing the item as specified herein.

LBB1 Breaker, Branch 20A to 70A

Description. This item shall consist of furnishing and installing a circuit breaker, regular or GFI type, of the amperage and number of poles specified, with all associated hardware, for overload and short circuit protection for conductors and connected apparatus, as specified herein, as shown on the plans, (where applicable), or as directed by the Engineer.

General Requirements. All feeders, branch circuits, and auxiliary and control circuits shall have overcurrent and short circuit protection for conductors and connected apparatus. Unless otherwise indicated, the overcurrent protection shall be by means of circuit breakers.

Material. Unless otherwise indicated, circuit breakers shall be standard UL-listed molded case, thermal-magnetic bolt-on type circuit breakers with trip-free indicating handles.

Unless otherwise indicated, circuit breakers shall have a UL-listed interrupting rating of not less than 10,000 rms symmetrical amperes at rated circuit voltage for which the breaker is applied.

All breakers shall be equipped with auxiliary dry contacts. These contacts may be on the breaker body or off a breaker-attached device. Contacts shall be in a normally open configuration.

Unless otherwise indicated, circuit breakers shall be of industrial grade with a high interrupting capabilities up to 65 KA @ 480 V AC.

Installation. The branch breaker shall be installed into the panel in accordance with the manufacturer's recommendation and in accordance with the National Electrical Code, as indicated on the plan drawing (if applicable) or as directed by the Engineer. All the connections shall be tight to prevent any arcing.

The branch breaker shall be labeled to indicate circuits. The auxiliary contact switch, if used, shall be wired as directed by the Engineer.

Method of Measurement. Breaker, branch, shall be counted, each, as a unit of payment, furnished and installed.

Basis of Payment. This item shall be paid at the contract unit price each for a BREAKER, BRANCH, 20A to 70A, of the amperage and number of poles specified, which shall be payment in full to provide an installation, complete and operating.

LBB2–LBB3 Breaker, Main

Description. This item shall consist of removing (if upgrading), furnishing, and installing a main breaker, amperage and number poles as per plan or specified for overload and short circuit protection for conductors and connected apparatus as specified herein. All feeders, branch circuits, auxiliary, and control circuits shall have overcurrent and short circuit protection for conductors and connected apparatus. Unless otherwise indicated, the overcurrent protection shall be by means of circuit breakers.

Material. Unless otherwise indicated, main breakers shall be standard UL-listed molded case, for reverse feed applications, thermal-magnetic bolt-on type circuit breakers with trip-free indicating handles. Unless otherwise indicated, main breakers shall have a UL-489 interrupting rating of not less than 35,000 rms symmetrical amperes at 480 volts and 65,000 rms symmetrical amperes at 240 Volts. Multi-pole main breakers larger than 100 amps size shall have instantaneous adjustable magnetic trip settings. The main breaker shall be equipped with auxiliary contacts

Removal. Prior to the removal of any equipment, the Contractor shall arrange an inventory inspection with the Engineer. All equipment shall be inspected and logged as to type, size and condition. No removal work shall be permitted without approval from the Engineer. Any damage resulting from the removal and/or transportation of the main breaker shall be repaired, to its original condition, or replaced in kind, at the Contractor's own expense, to the satisfaction of the Engineer.

Installation. Unless otherwise indicated, power wiring shall be of the size specified for the corresponding service conductors and shall be rated RHH/RHW, 600 volts and tagged with the self-sticking cable markers. The labor and

material to make the appropriate terminal connections in the cabinet as directed by the Engineer shall be incidental to this pay item.

The manufacturer's recommendations shall be followed during the installation process. The wiring connections shall be made in accordance with the National Electric Code. The Contractor shall energize the system to assure that all the components are working in accordance with their specifications and carrying rated load. The main lugs shall be secured in line with Underwriters' Laboratories standards to prevent lugs from turning or loosening when incoming cables are installed. The current carrying parts shall be secured in place to prevent flexing and loosening or damage during and after installation. At the branch circuit, breakers and associated wiring shall be labeled to identify the location of equipment and/or loads used. The auxiliary contact switch, if used, shall be wired as directed by the Engineer.

Method of Measurement. Main breaker shall be counted, each, furnished and installed.

Basis of Payment. This item shall be paid at the contract unit price each of MAIN BREAKER, of the type and size indicated below, which shall be payment in full for furnishing and installing a main breaker as shown on the plan and as specified herein, with all related hardware necessary to provide a complete installation.

LBB2 BREAKER, MAIN 60A TO 100A
LBB3 BREAKER, MAIN 125A TO 175A

LBT1 Buck-Boost Transformer

Description. This item shall consist of furnishing and installing a single-phase buck-boost transformer of KVA specified complete with all the appurtenances and all required hardware, connecting cables and terminal connections as specified herein and as directed by the Engineer. The unit(s) may be installed on a sign structure or on a bridge structure or in a lighting control cabinet or at a location specified by the Engineer. Units are single-phase but can be installed as a three-phase bank.

General Requirements. The buck-boost transformer is used as an auto-transformer for slight upward (boost) or downward (buck) adjustments in voltage. Buck-boost transformers are encapsulated designs with totally enclosed, non-ventilated enclosures. In an auto-transformer, the primary and secondary are electrically and mechanically connected together. Auto-transformers can be used only where local electrical codes permit and isolation of the two circuits are not required.

Material. The transformers shall be UL listed and/or CSA approved to meet or exceed all applicable NEMA, ANSI, UL, OSHA, and CSA requirements. The enclosure shall be NEMA 3R suitable for indoor/outdoor applications, coated with a UL approved ASA-61 gray finish. The transformer shall be encapsulated with electrical grade epoxy and silica sand to completely seal the core and coil from moisture and contaminants. It shall be tested in accordance with the latest issue of UL 506 and CSA C22.2 No. 47. The conductor material shall be copper, and the insulation shall be rated for class 180 degrees Celsius.

Installation. Unless otherwise indicated, power wiring shall be of the size specified for the corresponding service conductors and shall be rated RHH/RHW, 600 volts and tagged with the self-sticking cable markers. The labor and material to make the appropriate terminal connections in a junction box as directed by the engineer shall be incidental to this pay item.

The manufacturer's recommendations shall be followed in the installation. The wiring connections shall be made in accordance with the National Electric Code. The Contractor should energize the system to assure that all the components are working in accordance with their specifications and carrying rated load. The Contractor shall provide the electrical data as specified and directed by the Engineer.

Method of Measurement. Buck-Boost transformer shall be counted, each, as specified, furnished and installed.

Basis of Payment. This item shall be paid at the contract unit price each for a single-phase BUCK-BOOST TRANSFORMER, of the KVA specified, which shall be payment in full for furnishing all labor, materials and

equipment to install the transformer(s) and related appurtenances necessary to provide a complete and operational installation.

LC01 Controller, Duplex Console, with Radio

Description. This item shall consist of furnishing and installing a roadway lighting controller, duplex console type with radio control and associated wiring for control of highway lighting and delivering to storage a lighting controller, as specified herein. All work shall be according to the Article 7 – Lighting, navigation and sign illumination system in Volume 1.

Method of Measurement. Each lighting controller, duplex console type, with radio control, inspected and approved by the Engineer, shall be counted, each, as a unit for payment, furnished and installed.

Basis of Payment. This item shall be paid at the contract unit price each for CONTROLLER, DUPLEX CONSOLE TYPE, WITH RADIO, which shall be payment in full for furnishing and installing the lighting controller, complete, as specified herein.

LC02 Controller, Duplex Console, without Radio

Description. This item shall consist of furnishing and installing a roadway lighting controller, duplex console type, without radio control, including associated wiring, for the control of highway lighting, as specified herein. All work shall be according to the Article 7 – Lighting, navigation and sign illumination system in Section 1.

Method of Measurement. Lighting controller, duplex console type, without radio, shall be counted, each, as a unit for payment, furnished and installed.

Basis of Payment. This item shall be paid at the contract unit price each for CONTROLLER, DUPLEX CONSOLE, WITHOUT RADIO CONTROL, which shall be payment in full for furnishing and installing the lighting controller, complete, as specified herein.

LC03 Controller, Lighting, Install Only

Description. This item shall consist of retrieving from Owner's storage facility, loading, transporting and installing a lighting controller complete with all the appurtenances and all required hardware as specified herein, at locations designated by the Engineer. The lighting controller and foundation shall be paid separately. The Contractor shall transport, handle and store (as applicable) the lighting controller in complete conformance with the manufacturer's recommendations and as directed by the Engineer.

Installation. The lighting controller shall be installed as shown on the contract plans or as directed by the Engineer. The installation work shall be in accordance with Section 825 of the Standard Specifications for Road and Bridge Construction, current version, except the foundation will be paid separately.

Manufacturer's recommendations shall be followed during the installation process. The wiring connections shall be made as shown on the drawings and in accordance with the National Electrical Code. The Contractor shall energize the lighting controller to assure that all the components are working in accordance with their specifications and carrying rated load.

Method of Measurement. Lighting controller shall be counted of the type specified, each, installed.

Basis of Payment. This item will be paid at the contract unit price each for CONTROLLER, LIGHTING, INSTALL ONLY, of the type specified, which shall be payment in full for the complete installation as specified herein.

LC04 Controller, Lighting, Remove and Salvage

Description. This item shall consist of disconnecting, completely removing, transporting to the Owner's storage facility, unloading as salvage and stacking or boxing if necessary, and all types of existing lighting controller or designated components thereof, as specified herein. Proper documentation of Owner's salvage is required in this pay item.

General. Prior to the removal of any equipment, the Contractor shall arrange an inventory inspection with the Engineer. All equipment shall be inspected and logged as to type, size and condition.

No removal work shall be permitted without approval from the Engineer. Direct buried underground electric cables need not be removed. Cables which are abandoned shall be cut one foot below ground level. Cables in unit duct shall be removed from the duct, or as designated by the Engineer. Duct shall be abandoned and cut one foot below ground level.

Except as otherwise indicated, the cabinet, control equipment, and all associated hardware and appurtenances shall remain the property of the Owner and shall be delivered to the Owner or the Owner's electrical maintenance facility.

Unless otherwise directed by the Engineer, the concrete foundation shall be removed to at least two feet below grade and disposed of off the job site. The underground conduits and cables shall be separated from the foundation at 2.5 feet below grade and abandoned. The space caused by the removal shall be backfilled with trench backfill in accordance with Section 815 of the Standard Specifications.

Any damage resulting from the removal and/or transportation of the controller, control equipment, and associated hardware, shall be repaired to its original condition, or replaced in kind, at the Contractor's own expense, to the satisfaction of the Engineer. The Engineer shall be the sole judge to determine the extent of damage.

Method of Measurement. Each lighting controller, and all associated control equipment, which is removed, delivered to storage, unloaded, inspected, stacked and documented properly, shall be counted as a unit for payment.

Basis of Payment. This item shall be paid at the contract unit price each for existing CONTROLLER, LIGHTING, REMOVE AND SALVAGE, which shall be payment in full for the work specified herein.

LC05 Controller, Single Door, Console, Without Radio

Description. This item shall consist of furnishing and installing a roadway lighting controller, single door, console type, without radio control, including associated wiring, for the control of roadway lighting, as specified herein. All work shall be according to the Article 7 – Lighting, Navigation and Sign Illumination System in Volume 1.

Method of Measurement. Lighting controller, single door enclosure, console type, without radio control, shall be counted, each, as a unit for payment, furnished and installed.

Basis of Payment. This item will be paid at the contract unit price each for CONTROLLER, SINGLE DOOR, CONSOLE, WITHOUT RADIO, which shall be payment in full for furnishing and installing the controller, as specified herein.

LC06 Controller, Combination Lighting

Description. This item shall consist of furnishing and installing a roadway lighting controller, mounted on traffic signal cabinet for combination lighting and associated wiring as specified herein.

Material. The lighting controller shall be as follows:

Enclosure: The completed controller shall be an industrial control panel NEMA 4X with an overall dimension of 20" X 16" X 8", and shall comply with UL 508 standards. The enclosure shall be made out of molded fiberglass polyester with gray finish and enhanced with UV inhibitors to protect against outdoor weathering. The door fasteners shall be stainless with butterfly type twist lock including a provision for padlocking.

Electrical components; Refer to the figure L-21 for cabinet wiring diagram and list of components. Article 1068 (d), and (e) of the Standard Specification for Road and Bridge Construction, current revision shall apply to this pay item.

Installation. The lighting controller installation shall be according to the details, location, and orientation shown on the plan.

Method of Measurement. Each lighting controller, combination type, inspected and approved by the Engineer, shall be counted, each, as a unit for payment, furnished and installed.

Basis of Payment. This item shall be paid at the contract unit price each for CONTROLLER, COMBINATION TYPE, which shall be payment in full for furnishing and installing the lighting controller, complete, as specified herein.

LCL1 Clock, Digital Astronomical

Description. This item shall consist of furnishing, removing and installing, a solid state digital astronomical time clock with necessary contactors for control of lighting, as specified herein. All boxes required for proper storage shall be included in this item.

Materials. Article 1068.01(e)(1) of the Standard Specifications for Road and Bridge Construction, Current version, shall apply to this pay item. The timing of the unit shall be synchronous with the 60-Hertz power line frequency.

Installation. The Contractor shall transport and handle the digital time switch in complete conformance with the manufacturer's recommendations. Manufacturer's recommendations shall be followed during the installation process.

The contact rating of the time switch shall be sufficient to energize the contactor. If an external relay is needed to energize the contactor, then the relay, wiring, and installation shall be incidental to this pay item.

The digital astronomical time switch shall be installed inside the lighting controller or as indicated on the plan drawing and wired accordingly. It shall be programmed to set time of the day and set other functions to operate the lighting.

Method of Measurement. Digital astronomical clock, furnished, removed and installed shall be counted each for payment.

Basis of Payment. This item shall be paid at the contract unit price each for a CLOCK, DIGITAL ASTRONOMICAL, which shall be payment in full for furnishing and installing as specified herein.

LCN1–LCN2 Contactor

Description. This item shall consist of furnishing and installing a lighting contactor, with number of poles, with or without an auxiliary switch contact, as per plan and wiring for control of highway lighting as specified herein.

Material. Article 1068.01(e)(4) of the Standard Specifications for Road and Bridge Construction, Current version, shall apply to this pay item with the following exception: Revise the first sentence of Article 1068.01(e)(4) of the Standard Specifications to read:

"Contactors shall be electrically operated, mechanically held as specified, with the number of poles required for the service and with operating coil voltage as indicated."

Ampere rating of contactors shall be not less than that required for the duty shown and shall otherwise be rated as indicated.

Contactors shall come equipped with normally open, dry, auxiliary contacts. A device attached to the CAM of the contactor may provide these contacts. Unless otherwise indicated, the contactor-operating coil shall operate at 240 volts, single phase and contactors furnished under this specification shall be with continuous rating as specified per pole at 480 Volts AC.

Installation. The lighting contactor shall be carefully installed in accordance with the manufacturer's recommendation and in accordance with the design requirements represented on the plans. The wire sizes listed on the manufacturer's catalog shall be utilized and it must meet the National Electrical Code. The proper electrical clearance between the live metal parts and grounded metal shall be maintained. The proper size wire shall be used for control circuit connections designated "L", "O" and "C" supplied with clamp type terminals. The auxiliary contact, if used, shall be wired as directed by the Engineer.

Method of Measurement. Lighting contactor shall be counted, each, as a unit of payment, furnished and installed.

Basis of Payment. This item shall be paid at the contract unit price each for LIGHTING CONTACTOR, of the amperage indicated below, which shall be payment in full for furnishing and installing the lighting contactor, complete, as specified herein.

LCN1 CONTACTOR, 125A TO 225A
LCN2 CONTACTOR, 30A TO 100A

LD01–LD04 Decal Set, Lighting Unit

Description. This item shall consist of furnishing and installing, a lighting unit identification decal set for a pole or underpass, a lighting unit identification decal set including bracket for underpass mounting, a lighting unit identification decal set for a light tower with painted surface only, or a light tower which has a camera mounted on the luminaire ring, at installations and at heights as designated by the Engineer. This work shall also include the removal of all existing decals as necessary to complete the installation in a neat and aesthetically pleasing manner.

Materials. Article 1069.06 of the Standard Specifications for Road and Bridge Construction, current version, shall apply to this pay item.

Installation. Underpass luminaires, including appurtenances, identification brackets and conduit, and associated anchors, shall not be attached and/or drilled into precast, prestressed concrete beams. However, existing anchors, which have been installed improperly, shall be left in place. (Removal of such, would cause more damage to the beam, than leaving the anchors in place).

Articles 830.03, 835.02, and 844.03 of the Standard Specifications for Road and Bridge Construction, current version, shall apply to this pay item.

Method of Measurement. Lighting unit identification decal set shall be counted each, furnished and installed.

Basis of Payment. This item shall be paid at the contract unit price each for furnishing and installing an IDENTIFICATION (ID) DECAL SET, of the size per maximum character mounting as described below, which shall be payment in full for the work as specified herein.

LD01 DECAL SET, LIGHTING UNIT, POLE, 4 INCH, MAX 10 CHARACTERS
LD02 DECAL SET, LIGHTING UNIT, TOWER, 8 INCH, MAX 10 CHARACTERS
LD03 DECAL SET, LIGHTING UNIT, TUNNEL OR UNDERPASS WITH BRACKET, 4 INCH, MAX 10 CHARACTERS
LD04 DECAL SET, LIGHTING UNIT, TOWER WITH CAMERA, 4 INCH, MAX 10 CHARACTERS

LD05 Decal Set, Sign Unit, Truss Or Cantilever

Description. This item shall consist of furnishing and installing identification decals for sign lighting, one set of up to 4, 8” characters, as specified by the Engineer.

Materials. Article 1069.06 of the Standard Specifications for Road and Bridge Construction, current version.

Installation. The methods, type and mounting location for sign lighting shall be coordinated in accordance with the Basic Materials and Methods described in the standard specifications for Road and Bridge Construction, current version.

Method of Measurement. Each set of 2-4 characters, sign identification decals, shall be counted each, furnished and installed.

Basis of Payment. This work will be paid at the contract unit price each for furnishing and installing a DECAL SET, SIGN UNIT, TRUSS OR CANTILEVER, one set of up to four, 8 inch characters, which shall be payment in full for the work described herein.

LD06 Decal Set, Sign Unit, Bridge Facia with Bracket

Description. This item shall consist of furnishing and installing a decal set, sign identification decal with bracket on bridge facia as specified and directed by the Engineer.

Materials. The letters and numerals for bridge mounted signs shall be done using identification brackets. The brackets shall be fabricated from one-eighth (1/8) inch aluminum alloy sheet according to the dimensions shown on the plans. The bracket shall be attached to concrete walls with three (3) 1/4 inch, self drilling, snap-off type galvanized steel concrete anchors set flush with the wall, or power driven fasteners approved by the Engineer. The brackets shall be offset from the wall with 1/2 inch aluminum bushings. The luminaire identification numbers shall be applied to the bracket using the method described for identification applied to signs.

Installation. The location of the bracket shall be coordinated in accordance with the Basic Materials and Methods described in details shown in Figure S-10.

Method of Measurement. Each sign identification decal bracket on bridge facia, which is furnished and installed, shall be counted as a unit for payment.

Basis of Payment. This work shall be paid at the contract unit price each for furnishing and installing a DECAL SET, SIGN UNIT, BRIDGE FACIA WITH BRACKET, which shall be payment in full for the work described herein.

LDS1 Disconnect Switch

Description. This item shall consist of removing, furnishing and installing a disconnect switch, as directed by the Engineer.

Materials. The disconnect switch shall be 600 volt, 2-pole or 3-pole, up to 60-ampere, fusible, with solid neutral in a NEMA 4X stainless steel enclosure, complete with 20 ampere, 600 volt, dual element, time delay 4L, Class R fuses, having a UL listed interrupting rating of not less than 200,000 rms symmetrical amperes at rated voltage and suitable for use as service equipment for building.

Fuse holders shall be standard type fuse holders complete with fuses. All electrical materials shall conform to Article 1065, latest version of Standard Specification for Road and Bridge Construction. Raceways shall be as

detailed on the plans. Wire from the base fuse to the disconnect switch and to the sign luminaires shall be as specified for pole wire.

The fuse at the base of the sign structure shall be 30 ampere with a solid neutral assembly.

Removal. Prior to the removal of any equipment, the Contractor shall arrange an inventory inspection with the Engineer. All equipment shall be inspected and logged as to type, size and condition.

No removal work shall be permitted without approval from the Engineer.

Any damage resulting from the removal and/or transportation of the controller, control equipment, and associated hardware, shall be repaired to its original condition, or replaced in kind, at the Contractor's own expense, to the satisfaction of the Engineer.

Installation. The Contractor shall provide all equipment, transportation and labor necessary to install the equipment as specified. New wiring, conduit and luminaires will be paid by separate pay items specified elsewhere herein.

Manufacturer's recommendations shall be followed during the installation process. The wiring connections shall be made as shown on the drawings and in accordance with the National Electrical Code. The Contractor shall energize the disconnect switch to assure that all the components are working in accordance with their specifications and carrying rated load.

Method of Measurement. Removing, furnishing and installing each Disconnect Switch for a sign unit, as specified above, and approved by the Engineer, shall be counted as a unit for payment.

Basis of Payment. This work shall be paid at the contract unit price each for removing, furnishing and installing a DISCONNECT SWITCH, which shall be payment in full for the work specified herein.

LE01 Electrical Outlet, GFCI Type

Description. This item shall consist of furnishing and installing a ground fault interrupter, (GFCI) with an indicator visual or audible, and all required hardware as specified herein. All required hardware is incidental to this pay item, however, the circuit breaker for the GFI outlet, shall be paid under a separate pay item.

Materials. The box and cover shall be made out of a heavy-duty die cast aluminum, 0.094 in. thick for damp or wet locations and shall be in compliance with the NEC Article 406-8(B). The box shall be UL listed and comply with Federal Spec. W-C586C. The ground fault interrupter shall be of specification grade, NEMA 3 configuration and comply with applicable UL, CSA and Federal Standards. The cover shall be UL listed for wet locations and comply with UL Standard 514.

The GFCI shall have a light indicator when it is energized. The GFCI receptacle shall have an end of life provision when it is incapable of passing its internal test function (can no longer provide ground fault protection), it will either render itself incapable of delivering power, or indicate by visual or audible means that the device must be replaced. The GFCI shall be capable of reverse line-load mis-wire so that it will deny power to the receptacle face if it is mis-wired.

Transportation. The Contractor shall transport, handle and store (as applicable) the GFI outlets in complete conformance with the manufacturer's recommendations.

Installation. Each GFCI shall be mounted as indicated on the contract drawing or as directed by the Engineer. The installation shall be complete with necessary cable (paid under separate pay item) and connected to the applicable feeder circuit. The circuit breaker shall be labeled for the appropriate GFI.

Method of Measurement. A ground fault interrupter (GFI), shall be counted, each, furnished and installed.

Basis of Payment. This item shall be paid at the contract unit price each for furnishing and installing an ELECTRICAL OUTLET, GFCI TYPE which shall be payment in full for the item specified herein.

LE02 Convenience Receptacle, 120 Volts

Description. Furnish and install convenience receptacles, 20A, 120 Volt, at the Maintenance yards, Sign Shops and other Department facilities in District 1, as directed by the Engineer. Installation shall include all hardware, junction box, and other appurtenances. Removal of the existing receptacle, if necessary, shall be included in this work. Conduit and wire installation shall be paid through other pay items, where needed.

Method of Measurement. Electrical convenience receptacle, 120 volts, shall be counted, each, furnished and installed.

Basis of Payment. This work shall be paid at the contract unit price each for CONVENIENCE RECEPTACLE, 120 VOLTS, which price shall be payment in full for furnishing, delivering storing, installing and connecting the receptacle complete.

LF01 Foundation, Light Pole

Description. This item shall consist of the construction of a steel reinforced concrete light pole foundation, up to 30" diameter, of the diameter specified, complete with raceways, as specified herein. The foundation depth shall be as indicated in the Foundation Depth Table on the plans (where applicable) or as directed by the Engineer.

The foundation shall include soil testing, excavation, reinforcement, concrete, anchor bolts, nuts, washers and raceways as well as clean-up and restoration of the location when such work is not provided under other paid items. Sections 836, 1020, 1070 and also Articles 1006.10, 1088.01, of the Standard Specifications for Road and Bridge Construction, current version, shall apply to this pay item with the following:

Anchor bolts for light poles shall be heat-treated. Therefore, an exothermic ground wire connection shall not be made to the anchor bolt. Instead, a mechanical connection of the ground wire shall be made to the anchor bolt. However, the cable connections to the ground rod and the rebar cage shall be exothermic.

Method of Measurement. Light pole foundation of the diameter and depth specified shall be counted, per linear foot , furnished and installed.

Basis of Payment. This item shall be paid at the contract unit price for soil testing, furnishing and installing per linear foot for FOUNDATION, LIGHT POLE of the diameter specified, of the depth indicated, which shall be payment in full for the work as specified herein.

LF02 Foundation, Light Pole, Metal

Description. This item shall consist of furnishing and installing a metal foundation of the diameter specified for a light pole, consisting of a helix type screw base, baseplate, pilot point and hardware for supporting a light pole as specified herein. Excavation in rock will be paid as specified in Section 502.12 for Excavation for Structures.

Materials. Article 1070.01 of the Standard Specifications for Road and Bridge Construction, current version, shall apply to this pay item.

Installation. Installation shall conform to Article 836.03 (b) of the Standard Specifications for Road and Bridge Construction, current version .

Method of Measurement. Light pole foundation of the diameter specified shall be counted each, furnished and installed.

Basis of Payment. This item shall be paid at the contract unit price each for a FOUNDATION, LIGHT POLE, METAL, of the diameter, specified, which shall include all excavation or drilling except excavation in rock, backfilling, disposal of unsuitable material, form work and furnishing all materials within the limits of the foundation.

LF03 Foundation, Light Tower, Up To 48 Inch Diameter

Description. This item shall consist of the construction of a steel reinforced concrete light tower foundation, up to 48 inch in diameter, complete with raceways, as specified herein. The foundation depth shall be as indicated in the Foundation Depth table on the plans (where applicable) or as directed by the Engineer.

The foundation shall include excavation, reinforcement, concrete, anchor bolts, nuts, washers and raceways as well as clean-up and restoration of the location when such work is not provided under other pay items. Excavation in rock shall be paid according to Section 502.05 and 502.12 of the Standard Specifications for Road and Bridge construction, current version.

Sections 837 of the Standard Specifications for Road and Bridge Construction, current version, shall apply to this pay item with the following.

Method of Measurement. Light tower foundation, up to 48" in diameter, shall be counted, per linear foot depth, furnished and installed.

Basis of Payment. This item shall be paid at the contract unit price for furnishing and installing per linear foot for FOUNDATION, LIGHT TOWER, UP TO 48 INCH DIAMETER, of the depth indicated, which shall be payment in full for the work as specified herein.

LF04 Foundation, Lighting Controller

Description. This item shall consist of furnishing and installing a concrete foundation for a lighting controller cabinet as specified herein, shown on the plans, or as directed by the Engineer. The material and labor for the ground field shall be paid under a separate pay item.

Materials. Concrete shall be Class SI complying with Section 1020 of the Standard Specifications, current version.

The anchor bolts shall comply with ASTM A576. The entire length of the anchor bolts shall be hot dipped galvanized steel according to ASTM 153. The nuts, lock washers, and flat washers shall be galvanized also.

The foundation shall include a 1 inch diameter galvanized steel raceway for the ground field connection.

Conduit raceways shall be heavy wall rigid polyvinylchloride (PVC) conduit, (Schedule 40) UL listed and in conformance with NEMA TC2 and Federal Specifications WC-1094A. Raceways shall be of the number and size as indicated on the drawing.

The foundation shall include a ground field of (3) 5/8 inch X 10 ft. copper-clad steel ground rods connected via 2/0 bare copper wire. All connections shall be made with exothermic welds. The ground wire shall be stranded, uncoated, bare copper in accordance with the applicable requirements of ASTM Designation B-3 and B-8.

Installation. Installation shall comply with Section 825 of the Standard Specifications for Road and Bridge Construction, current version.

The foundation shall have a depth and size as shown on the contract drawing. The top of the foundation shall extend twelve inches from the surrounding finished grade and the edges shall be beveled. A poured, 4-inch thick concrete pad, 4 feet wide X 4 feet shall be provided in front of the cabinet with an expansion joint. Exact concrete pad dimensions and location shall be confirmed with the Engineer, prior to installation. The ground field shall be a 10 feet triangle as shown on the drawing. Each ground rod shall be within a ground well as detailed on the drawing. No ground well shall be placed in the concrete pad in front of the controller. The cabinet shall be caulked at the base. All the conduit entrances into the cabinet shall be sealed with a pliable waterproof material.

Method of Measurement. Lighting Controller, console type, foundation shall be counted each, furnished and installed.

Basis of Payment. This item shall be paid at the contract unit price each, for furnishing and installing FOUNDATION, LIGHTING CONTROLLER, which shall be payment in full for the work as specified herein.

LF05 Foundation, Modification for Concrete or Metal

Description. This item shall consist of furnishing the necessary labor, equipment, and materials to modify and adjust an existing light pole foundation, concrete or metal, to an elevation as specified herein and as indicated by the Engineer, and the re-installation of the existing light pole upon the modified light pole foundation.

General. This work shall include removing an existing light pole, opening the unit duct, exposing the cable, and pulling the cable out of the foundation in order to adjust foundation, concrete or metal, to an acceptable elevation. The existing unit duct shall be opened in a manner as to minimize bends and not damage the existing electric feeder cable into the adjusted foundation. This work shall meet the requirements of Section 844 of the Standard Specifications for Road and Bridge Construction, current version.

The existing raceway wiring slots are 180 degrees apart, thus in the process of lowering the existing metal foundation, rotation should be in multiples of 180 degrees to assure existing raceway cables can be reused. The foundation shall be lowered with its axis plumb so that the light pole may be reinstalled without the use of shims, grout or other leveling devices.

The foundation shall be adjusted vertically and the base plate shall be level. Extreme care shall be used to achieve the proper final elevation of the top of the foundation with respect to the existing grade. The base plate shall be level and not more than 1" above the highest point of adjacent existing grade.

This work shall include installing a unit duct sleeve, which is the next larger diameter unit duct with respect to the existing unit duct diameter, together with the installation of unit duct compression coupling in line splice on both ends to create a water tight seal. The cable shall be reinstalled and respliced as specified. The hollow foundation shall be filled with densely packed sand. The breakaway couplings or breakaway device and/or hardware, shall not be used to align and reset the pole.

All work shall be performed in a safe manner, include necessary area restoration and shall meet the requirements of Articles 836.03(d) and 1070.01 of the Standard Specifications for Road and Bridge Construction, current version.

Method of Measurement. Foundation, modification of concrete or metal, shall be counted, each, modified.

Basis of Payment. This item will be paid at the contract unit price per each for FOUNDATION, MODIFICATION FOR CONCRETE OR METAL, which shall be payment in full for the work as described herein.

LGF1 Ground Field

Description. This item shall consist of furnishing materials and labor for the installation of a ground field, which shall consist of 3 (three)-ground rod access wells in a 10ft. triangle connected via bare copper wire as specified herein, at locations indicated by the Engineer.

Section 806 and Article 1087.01 of the Standard Specifications for Road and Bridge Construction, current version, shall apply to this pay item.

Materials. Each of the 3 (three) ground rod access wells shall consist of a 5/8 in. X 10' copper clad ground rod in a 12 in. minimum diameter PVC enclosure with fiberglass flush covers.

Installation. The 3 (three) ground rod access wells shall be installed in a typical 10FT. triangle connected via 2/O bare copper wire by exothermic welds. No ground well shall be placed in the concrete pad in front of the lighting controller.

The removable flush cover shall be attached to the PVC enclosure via stainless steel hexhead screws.

The ground rods shall be buried 12 in. below grade and the access well shall be filled with crushed stone to point 36 in. below grade.

The 2/O bare copper wire leaving the ground rod access well closest to the lighting controller cabinet, shall be exothermically welded and enter the lighting controller cabinet foundation via a 1 in. diameter rigid steel conduit.

Method of Measurement. Ground field shall be counted each, furnished and installed.

Basis of Payment. This item shall be paid at the contract unit price each for GROUND FIELD, which shall be payment in full for furnishing and installing the item as specified herein.

LP01 Light Pole, Kit

Description. This item shall consist of removing existing damaged basic materials, and furnishing and installing new basic materials such as fuses, fuse holder, decal, pole wire, pole cap, or photocell if specified, hardware, nut covers, hand hole door and grommets in conjunction with the use of a light pole from State's storage facility, and utilizing one or two mast arms and luminaires. This item shall also include the removal of old decals, accident reference markers and graffiti from used poles prior to installation at new locations.

Materials. Materials shall be in accordance with Section 1065 and 1066 of the Standard Specifications for Road and Bridge Construction, Current version.

Installation. Installation shall be in accordance with Section 830 of the Standard Specifications for Road and Bridge Construction, Current version.

Method of Measurement. Light pole kit for state stock light pole, shall be counted, each, furnished and installed.

Basis of Payment. This item shall be paid at the contract unit price each for LIGHT POLE, KIT which shall be payment in full for removing damaged materials, and furnishing and installing all new materials including the necessary hardware as specified herein.

LP02 Light Pole Unit, Install Only

Description. This item shall consist of retrieving from State's storage facility (if required), loading, transporting and installing an aluminum light pole unit which is a standard, davit, or painted davit light pole with (all sizes) mast arm or twin mast arm, and (all types) luminaire(s), complete with appurtenances, length of 10 to 60 feet and all required hardware including bolt covers as specified herein.

Installation. Installation shall be as described in Section 830, except that the light pole shall be set plumb on the foundation without the use of shims, grout or any other leveling devices under the pole base. The mast arm or arms shall be set at right angles to the centerline of the pavement. (The leveling area of the luminaire shall be set in a plane parallel to the roadway taking into consideration the upgrade or downgrade and the super-elevation of the roadway).

The Contractor shall transport, handle and store (as applicable) the metal light pole in complete conformance with the manufacturer's recommendations.

This item shall include the applicable luminaire (with pole wire and fusing), foundation, anchor bolts, and breakaway device which shall be provided under separate pay item.

Poles shall not be installed until luminaires are available for installation which shall be at the same time the poles are installed. Poles shall not be installed and left standing without a coordinated installation of mast arm and luminaire.

Method of Measurement. Light pole unit, shall be counted, each, installed.

Basis of Payment: This item shall be paid at the contract unit price each for LIGHT POLE UNIT, INSTALL ONLY, of the length and mounting height as indicated by the Engineer, which shall be payment in full for the work as specified herein. This item shall not be paid unless the coordinated assembly, including mast arm, luminaire, and breakaway device if specified, is complete.

LP03 Light Pole Unit, Removal And Salvage

Description. This item shall consist of the disconnection, removal, dismantling, and transportation to the State's storage facility and unloading as salvage, a light pole unit, which is a standard, davit, or painted davit light pole with (all sizes) arm or twin arm, and (all types) luminaire(s), complete with appurtenances, as specified herein and as directed by the Engineer. Removal of the associated conduit, wire and junction boxes shall be included in this item. This pay item shall also include all storage documentation as required by the Engineer.

General. Light pole removal shall be in accordance with Section 842 of the Standard Specifications for Road and Bridge Construction, current version. Proper documentation of owner salvage is required. Prior to the removal of any equipment, the Contractor shall arrange an inventory inspection with the Engineer. All equipment shall be inspected and logged a to type, size and condition.

No removal work shall be permitted without approval from the Engineer.

Any damage resulting from the removal and/or transportation of the light pole shall be repaired, to its original condition, or replaced in kind, at the Contractor's own expense, to the satisfaction of the Engineer.

Method of Measurement. Each light pole unit, which is removed, delivered to storage, unloaded, inspected, and documented properly, shall be counted as a unit for payment.

Basis of Payment. This item shall be paid at the contract unit price each for LIGHT POLE UNIT, REMOVAL, SALVAGE, which shall be payment in full for the removal and disposition of light pole as specified herein.

LP04 Wood Pole Unit, Install Only

Description. This item shall consist of retrieving from State's storage, loading, transporting and installing a wood pole with mast arm(s) and luminaire(s) complete with appurtances of the mounting height as specified herein, including all necessary hardware and accessories required. The wood light pole unit shall be paid separately.

Installation. Installation shall be in accordance with Section 830.03 (c) of the Standard Specifications for Road and Bridge Construction, current version.

The Contractor shall be paid separately for CCTV and Traffic Signal installation using the non-routine pay items if the wood pole is used for CCTV on Traffic Signal.

The Contractor shall transport and handle the light pole in complete conformance with the manufacturer's recommendation.

"Mechanical Damage. Poles are not acceptable if they contain indentations attributed to loading or handling slings that are 1/4 inch or more deep over 20% or more of the pole circumference, or more than 1/2 inch deep at any point. Other indentations or abrasions, for example, forklift damage, chain-saw damage, etc., shall not be more than 1/10 the pole diameter at the point of damage up to a maximum of 1 inch. Such damage is permitted in an oversized section, where the excess of wood shall be taken into consideration in evaluating the effects of the damage. In any case, the circumference for a given class is still required to be not less than the specification minimum."

Method of Measurement. Wood pole unit of the mounting height as specified, complete with necessary hardware shall be counted, each, installed.

Basis of Payment. This item shall be paid at the contract unit price each for WOOD POLE UNIT, INSTALL ONLY, of the mounting height up to 90', shall be payment in full for installing a wood pole unit with necessary appurtenances as specified herein.

LP05 Wood Pole Unit, Removal and Salvage

Description. This item shall consist of disconnecting, completely removing, dismantling, transporting to the State's storage, and unloading as salvage, a wood pole with mast arm(s) and luminaires(s) complete with appurtenances, as specified herein. Removal of the CCTV and Traffic Signal, associated conduit, wire and junction boxes shall be included in this item. Proper documentation of the owner's salvage is required with this pay item.

General. Prior to the removal of any equipment, the Contractor shall arrange an inventory inspection with the Engineer. All equipment shall be inspected and logged as to type, size and condition. No removal work shall be permitted without approval from the Engineer. Any damage resulting from the removal and/or transportation of the light pole unit shall be restored, to its original condition, or replaced in kind, at the Contractor's own expense, to the satisfaction of the Engineer.

Method of Measurement. Each wood pole unit, complete with CCTV, Traffic Signal, Arm and Luminaire which is removed, delivered to storage, unloaded, inspected, and documented properly, shall be counted as a unit for payment.

Basis of Payment. This item shall be paid at the contract unit price each for WOOD POLE UNIT, REMOVAL AND SALVAGE, complete with CCTV, Traffic Signal, Arm and Luminaire, which shall be payment in full for the removal and disposition as specified herein.

LPN1 Panel, Distribution

Description. This item shall consist of removing (if upgrading) furnishing and installing, a lighting and distribution panel of the amperage (up to 400 Amps) and number of poles (up to 42) specified for lighting and/or equipment with branch breakers as specified by the Engineer.

General Requirements. The panel with all of its electrical components and parts shall be assembled in a neat orderly fashion. All of the electrical cables shall be installed in a trim, neat, professional manner. The cables shall be trained in straight horizontal and vertical directions and be parallel, next to, and adjacent to other cables whenever possible. The

completed controller shall be UL listed as an industrial control Panel under UL 508 and UL 98, service entrance rated panel.

If the enclosure of the existing service or distribution panel is in good condition, the Contractor may use the existing enclosure and replace only the panel board upon approval by the Engineer.

Materials. The panel board shall be test-verified by, and listed with, Underwriters Laboratories, Inc. and shall meet all NEMA standards for panelboards. Panel board shall be designed for sequence phase connection of branch circuit devices to allow complete flexibility of circuit arrangement (1,2 or 3 poles) to evenly balance the electrical load on each phase. Main lugs shall be mechanical, solderless type, and approved for Cu or Al conductors. The chassis shall be sturdy, rigid and shall assure accurate alignment of interior with panel front. The fronts (trims) and flush-type lock/latch handle assembly shall have an appearance equivalent to an ANSI-61 light gray finish. Wiring gutters shall be furnished in accordance with Underwriters' Laboratories Inc. standards.

Main Breaker (Omit if main lug only panel). The main breaker shall be of the same manufacturer as the lighting or distribution panel. The electrical requirement shall be of the voltage, phase and ampacity of the lighting or distribution panel. The lugs of the main breaker shall be sized to handle the required cable size of the incoming cable.

Unless otherwise indicated, main breakers shall be standard UL-listed molded case, thermal-magnetic bolt-on type circuit breakers with trip-free indicating handles. Unless otherwise indicated, main breakers shall have a UL-489 interrupting rating of not less than 35,000 rms symmetrical amperes at 480 volts and 65,000 rms symmetrical amperes at 240 Volts. Multi-pole main breakers larger than 100 amps size shall have instantaneous adjustable magnetic trip settings. The main breaker shall be equipped with auxiliary contacts.

The interrupting capacity shall be capable of removing a fault at the applied voltage without damage to the breaker. The breaker may be a fixed trip or interchangeable trip as specified by the engineer. The breaker shall be specified as "fully rated" unless noted otherwise. The main breaker shall be a thermal magnetic trip breaker unless noted otherwise.

Top feed or bottom feed should be as specified. The "on/off" position shall be clearly visible and designed to operate in a vertical plane "on" up, "off" down. A tripped indicated of the breaker shall be clearly visible. Lugs on the breaker shall be suitable for 75 degrees Celsius wire. The breaker shall be UL listed for use in lighting and distribution panels.

Circuit Breakers. All feeders, branch circuits, and auxiliary and control circuits shall have overcurrent protection. Unless otherwise indicated, the overcurrent protection shall be by means of circuit breakers.

Unless otherwise indicated, circuit breakers shall be standard UL-listed, molded case, thermal-magnetic, bolt-on-type circuit breakers with trip-free indicating handles.

Unless otherwise indicated circuit breakers shall have a UL-listed interrupting rating of not less than 10,000 rms symmetrical amperes at rated circuit voltage for which the breaker is applied.

The number of branch circuit breakers shall be as indicated on the control cabinet detail drawings or lighting system wiring diagram, which ever is greater, plus two (2) spare circuit breakers.

Ground & Neutral Bus Bars. Separate ground and neutral bus bars shall be provided. The ground bus bar shall be copper, mounted on the equipment panel, fitted with 22 connectors of the type as shown on the plans, as a minimum. The neutral bar shall be similar. The heads of connector screws shall be painted white for neutral bar connectors and green for ground bar connectors.

Standards. The panel boards shall meet the following applicable industry standards, except where noted:

1. Underwriters' Laboratories, Inc.
 - a. Panelboards: UL67
 - b. Cabinets and boxes: UL50Note: Only panelboards contain UL listed devices can be UL labeled.

2. National Electrical Code – Article 408 and 409
3. NEMA Standards: PB1
4. Federal Specifications
 - a. Panelboards: W-P-115c
 - b. Molded case breakers W-C-375a,b
 - c. Fusible Switches: W-S-865c
 - d. NFPA: 79

Removal. Prior to the removal of any equipment, the Contractor shall arrange an inventory inspection with the Engineer. All equipment shall be inspected and logged as to type, size and condition.

No removal work shall be permitted without the approval of the Engineer.

Any damage resulting from the removal and/or transportation of the lighting distribution panel, of the size as specified, shall be repaired to its original condition, or replaced in kind, at the Contractor's own expense, to the satisfaction of the Engineer.

Installation. Service entrance equipment NEC Article 230 and UL, require that a panel used as service entrance equipment must be located near the point where the supply conductors enter the building.

A disconnectable electrical bond must be provided between the neutral and ground.

A service-entrance-type UL label must be factory installed.

The main lugs shall be secured in line with Underwriters' Laboratories standards to prevent lugs from turning or loosening when incoming cables are installed.

The current carrying parts shall be secured in place to prevent flexing and loosening or damage during and after installation.

At the branch circuit, breakers and associated wiring shall be labeled to identify the location of equipment and/or loads used.

The manufacturer's recommendations shall be followed during the installation process. The wiring connections shall be made in accordance with the National Electric Code. The Contractor shall energize the system to assure that all the components are working in accordance with their specifications and carrying rated load.

Method of Measurement. Lighting and distribution panel removed, furnished and installed shall be counted, each,

Basis of Payment. This item shall be paid at the contract unit price each for PANEL, DISTRIBUTION, of the amperage (up to 400 Amps) and number of poles (up to 42) of the amperage and number of poles specified, which shall be payment in full for removing, furnishing and installing the distribution panel, as specified herein.

LS01 SCADA, Lighting, Radio Control Equipment

Description. This item shall consist of furnishing and installing a SCADA Lighting Radio Control RTU unit, including all associated wiring and connectors as specified herein and as directed by the Engineer.

Materials. Refer to Article 7, Lighting System, for detailed equipment listing and construction requirements.

Method of Measurement. Each full LIGHTING SCADA radio unit that is furnished and installed as per the specifications herein, and approved by the Engineer shall be counted as an unit of payment.

Basis of Payment. This work shall be paid at the contract unit price each for SCADA, LIGHTING, RADIO CONTROL EQUIPMENT which shall be payment in full for furnishing and installing the LIGHTING SCADA radio unit, as specified herein.

LS02 SCADA, Lighting, Radio Inspection

Description. This item shall consist of the contractor furnishing a manufacturer approved factory sales and service company to inspect the SCADA Lighting radio system for a designated power center as described herein.

Materials/Equipment. The specialty contractor shall be equipped with all recommended test equipment (see SCADA System Planner) to test the SCADA and SCADA radio systems, including a Motorola R2600A Communication system analyzer. The factory sales and Service Company shall provide all tools and manufacturer's test sets to complete all work specified herein.

Work Description. All radios, antennas, antenna line, and connectors, surge suppressers, power supplies, batteries and all appurtenances shall be tested for the site-specific radio system for each location The factory sales and Service Company shall perform the following:

1. Inspect and correct radio AFC and CTS operating parameters.
2. Visual inspection of antenna, feedline and connectors.
3. Visual inspection of interconnection between SCADA device and any controller or slave that is being used with them.
4. Check frequency, soft carrier delay, time-out timer length and status of squelch tail eliminator.
5. Check Tx/Rx audio levels and calibrate as the system requires.
6. Checks receive dbm level.
7. Terminate a service monitor to the antenna system to check for any outside harmful RF emissions, especially at those sites that have been marginal in response.
8. Check radio system Octal addressing for proper system On/Off operation.
9. Check status of battery, power supply and replace, if necessary.
10. Check VSWR of the antenna cable.

Reporting. The factory sales and service company shall submit a report consisting of data for all items stated above, the methods/means used to test and record consisting or all data values recording during the last inspection (for comparison purposes). The report shall also include any pertinent changes made or required to the system.

Method of Measurement. Each inspection of lighting controller SCADA system radio equipment including submittal of the report and approval by the Engineer shall count as a unit for payment.

Basis of Payment. This work shall be paid at the contract unit price each for SCADA, LIGHTING RADIO INSPECTION.

LS03 SCADA, Lighting, RTU Terminal Configuration

Description. This work shall consist of configuring, integrating and testing a new SCADA RTU on the central lighting SCADA system for control and monitoring of the RTU through all four existing system terminals. The software integration shall be performed by a qualified systems integrator with prior experience in the integration of SCADA equipment

Work.

SCADA SERVE/CLIENT WONDERWARE PROGRAMMING FOR EACH SYSTEM TERMINAL:

6. Add the new RTU to the existing Wonderware GUI application. The individual site screen for the RTU shall be in a similar format to the existing individual site screens within the application
7. Configure Wonderware application to poll SCADA RTU CPU as well as system FIU for tag data points regarding the specific RTU.
8. Setup servers and clients for alarm notification, database and event history for that specific RTU.

SCADA FIU CPU PROGRAMMING (at Schaumburg and EMC):

1. If RTU exists as an Intrac site in the FIU, change it to be a SCADA site (SCADA CPU). If RTU is a new site, configure as a new SCADA site. This applies to both of the FIU's within the system.
2. Configure SCADA FIU's within the IDOT lighting system to poll the new RTU during the respective polling cycle.

Staging. All central configuration programming shall be completed prior to the initial check out/PM of the SCADA unit in the field. This is to assure/confirm 2 way radio communications from the field RTU the Central. Prior to commencing the software work, the integrator shall obtain from IDOT the latest copy of their application. It is the responsibility of the integrator to assure that is done and the new RTU is configured on that application. Upon completion of the updated application the Integrator shall notify IDOT that the work is complete and ready to be installed on the IDOT Lighting SCADA system. This update shall be implemented on all system computers by the software integrator. When all system updates are complete, IDOT shall be supplied a copy of all computer terminal applications on a single CD.

Testing. A checklist consisting of testing all physical I/O points and COS alarm reporting shall be submitted to the Engineer. This testing shall confirm all I/O messaging in the field is being received at the Central. In conjunction, Central system must be checked for receiving of appropriate alarms triggered in the field.

Acceptance Transition. After the appropriate testing has been completed and approved by the Engineer, the new SCADA shall be monitored for up to 2 weeks for proper operation. If any problems are to arise, all changes shall be completed at no extra cost.

Method of Measurement. Each SCADA RTU that is configured, tested, and implemented to the Lighting SCADA system as specified herein, and approved by the Engineer shall be counted as an unit of payment.

Basis of Payment. This work shall be paid at the contract unit price each for SCADA, LIGHTING RTU TERMINAL CONFIGURATION which shall be payment in full for configuring the RTU, as specified herein.

LT01–LT02 Light Tower

Description. This item shall consist of furnishing, delivering to State's storage facility and unloading, as specified, and installing a light tower including a lowering device with ring, luminaires and lamps, as specified herein. The tower foundation shall be provided under separate pay items. The specifications for this item shall be fully coordinated with the lowering device, ring, luminaire, and foundation requirements.

Materials. Materials shall be in accordance with Article 1069.08 of the Standard Specifications for Road and Bridge Construction, current version with the following exceptions:

Revise the sixth and eighth paragraphs of Article 1069.08(a) of the Standard Specifications to read:

The handhole shall have a door with a full collar of similar material that extends over the handhole frame to exclude liquids and contaminants when closed against the flange and gasketed handhole opening. The door shall be mounted with a full-height stainless steel piano hinge or not less than two stainless steel hinges or other hinge arrangement acceptable to the Engineer. A bolt through a door and frame eyelet shall not constitute an acceptable hinge. Hinges shall be heavy duty, suitable for the weight of the handhole door. Hinges shall be welded to the handhole frame and shall be welded or attached with stainless steel nuts, bolts, and lock washers (5 minimum) to the handhole door. Rivets will not be allowed to attach any hardware. The door/opening shall be gasketed in a manner, which will prevent the entry of water into the pole, and the door shall have a tight compressive seal employing a tubular gasket with a flexible

wire core. The gasket shall have a mechanical gripping action and be mounted on a metal edge inside the handhole door. The door shall be held closed with 12 gauge captive stainless steel clamps. The clamps shall be held closed with spring loaded captive clamps. The clamps shall have a depth stop feature to insure uniform sealing pressure at all clamp points. A minimum of four (4) clamps shall be used around the non hinged sides of the door assembly. A stainless steel padlock hasp and staple shall be provided for locking the door. Door hardware shall be stainless steel. The door shall be equipped with an integral door stop mechanism.”

Revise the last paragraph of 1069.08 (b), (2) Inspection, to read:

“The independent welding inspector shall send the test results directly to the Engineer at the following address:

Illinois Department of Transportation
Division of Highways, District 1
Attn: Bureau Chief of Electrical Operations
201 West Center Court
Schaumburg, Illinois 60196-1096

The cost for all independent welding inspections shall be included in the unit price for the bid item.”

Add the following to Article 1069.08(c) of the Standard Specifications:

“The primer paint shall be white polyamide epoxy, with minimum solids by volume 65%. The primer shall be applied in two coats to a total thickness of 6-8 mils dry film thickness following manufacturer's method of application. The two primer coats shall be of different colors.

The finish paint shall be silicone-alkyd resin type paint poly-silicone enamel, minimum solids by volume 53%. The finish paint shall be applied in one coat to a 2-3 mils dry film thickness following manufacturer's method of application. The finish paint shall be applied to the outside surface only.”

Revise the second and third paragraphs of Article 1069.08(p) of the Standard Specifications to read:

“A flexible UL Listed Class II conductor shall be installed between the lightning rod and the grounding lug on the top of the tower shaft. The conductor shall be a rope lay cable consisting of 28 strands of No. 14 AWG cooper wire. The cable shall have a minimum outside diameter of 7/16”, a cross sectional area of 58 mm², and a net weight of 1668 N per 375 pounds per 1000 ft. The same conductor shall be attached with studs and exothermic welds at tower shaft sections. The grounding conductor terminations shall be UL Listed.”

Installation. Installation and shipment shall be in accordance with Article 835.04 of the Standard Specifications for Road and Bridge Construction, current version.

Method of Measurement. Light tower shall be counted, each, furnished, and installed complete.

Basis of Payment. This item shall be paid at the contract unit price each for LIGHT TOWER, of the length as specified below, which shall be payment in full for furnishing and installing complete as specified herein. The tower foundation shall be paid under separate pay item.

LT01 LIGHT TOWER, 110 FT. OR LESS IN LENGTH
LT02 LIGHT TOWER, 111 FT. OR MORE IN LENGTH

LT03 Light Tower, in Place, Clean and Paint

Description. Paint a complete light tower structure, luminaire ring assembly and hood, including spot abrasive blast cleaning of various rusted surface areas of the structure up to a maximum of 15% of the shaft surface area and all at various installations as directed by the Engineer.

General. Under this item, for a unit price per linear feet as shown in the Schedule of Prices and when directed by the Engineer in writing, the Contractor shall prepare the existing deteriorated surfaces and paint all designated surfaces of the various components of the light towers with coatings specified by the Engineer.

All identification decals shall be retained or removed, as directed by the Engineer. Replacement of decals will be paid separately. Removal of all designated decals shall be incidental to this pay item.

Dependent upon lane closure requirements at each light tower location, traffic control and protection may be paid separately.

The work involves the surface preparation and application of coating materials on existing steel light towers greater than 80 ft. high.

The work includes, but is not limited to, the surface preparation and coating application work for the following: Structural Steel as defined in Section 2.1 of the AISC "Code of Standard Practice for Steel Buildings and Bridges" and Other Steel or Metal Items as defined in Section 2.2 of the AISC "Code of Standard Practice for Steel Buildings and Bridges."

The Contractor shall provide all management, supervisory, administration, clerical, quality control personnel, labor forces and all other services required to carry out his surface preparation work, coating and coating related operations, including the furnishing, handling and removal of spent abrasive material, if required and all testing and reporting as specified herein.

Decal Replacement Work. All decals, which are found to be worn, torn, cracked, partially missing, etc., shall be removed. Decals, which appear to be in good condition and fully readable, may remain in place. The Engineer will make the final decision regarding any question relative to the removal and/or replacement of decals. Decals, which are determined by the Engineer to remain in place, shall be covered (masked) prior to new coatings being applied.

Tower Number and Luminaire Quantity Decals. Following sufficient curing of the finish coat, new tower number and luminaire quantity decals 8 inch x 9 inch shall be affixed to poles at locations where the existing decals were removed during the surface preparation process. The Engineer will determine when the decal may be replaced after the finish coat has had sufficient time to cure. Normally, the waiting period will be about 4 to 6 months. The Contractor will be paid separately for the furnishing and reinstalling new decals.

Accident Reference Marker Decals. Accident Reference Marker decals which have been removed shall be replaced within one (1) month following the placement of the final coat. This work will be paid separately.

Responsibilities. The Contractor shall be responsible for:

The planning and performance of all scaffolding work, ventilation, enclosures, protective covers, and utilization of labor and equipment.

Supplying and maintaining of tools, test equipment, enclosures, scaffoldings, etc.

Purchasing and/or requisitioning of supplies.

Performing tests to assure proper lasting equipment performance and required dry film thickness of coatings.

Relocating and/or removing all temporary equipment, enclosures, scaffolding, etc. at the completion of the work, or as directed by the Engineer throughout the course of the job schedule to permit the work of others.

Providing the testing and inspection, equipment, and services for all surface preparation and material application.

Protecting all existing equipment, piping, ducts, etc. and complete coated areas from damage resulting from blasting work and/or misapplied coating materials.

The quality and appearance of the finished work. He/she shall carefully examine this specification and shall be thoroughly familiar with the physical makeup of the areas to be painted and the established schedule and completion date.

Storage Conditions on Site. Extreme care must be exercised in the handling and storage of all materials to insure that the specified coating systems can be properly applied.

Prior to use on the structure, materials, equipment, scaffolding, etc. furnished by the Contractor may require storage for limited periods as approved by the Engineer. Any outdoor storage of materials shall be protected by the Contractor against any kind of damage. The Contractor shall also provide a safe, secure area for this equipment away from the general public.

Health and Safety. The Contractor shall observe all OSHA, State and local laws, ordinances and regulations pertaining to health and safety. The precautions indicated on the paint containers with regard to fire and safety, as well as the laws of the State of Illinois, shall be observed.

The Contractor shall conform to all the requirements of OSHA 29 CFR 1910.1200 pertaining to the communication of information regarding hazards involved in the work.

The importance of safety to all workers on the project shall be recognized, and accident prevention shall be integral part of the Contractor's operations. The Contractor shall cooperate with the Illinois Department of Transportation safety programs.

Material Safety Data Sheets shall be provided by the manufacturer for each product and shall be conspicuously posted.

The Contractor shall handle all wastes from the operation in accordance with the Resource Conservation and Recovery Act (RCRA) located in 40 CFR Parts 260-266 of the Code of Federal Regulations.

The Contractor shall maintain the premises free from rubbish at all times and upon completion, shall carefully clean up all dirt and rubbish left or resulting from the work, and dispose of it in such place and manner as directed by the Engineer.

General Work Provisions. All coating work shall be done in a careful workmanlike manner using the materials specified herein in strict accordance with this Specification.

Surface preparation and coating application shall be in accordance with the Coating Schedule contained herein. The manufacturer's specifications regarding the mixing, thinning, application, drying and general handling of the various materials shall be followed as being supplementary to this Specification.

Any false work (scaffolding, ladders, etc.) required for surface preparation and/or painting shall be designed by the Contractor for loads not less than those established by the State of Illinois, local building codes and (OSHA) 29 CFR 1910 and 29 CFR 1926.

Prior to initial application of coatings, the Contractor or his agent will inspect representative areas to assure conformance with his requirements. The Contractor will perform additional inspections to assure that all coating application is in accordance with his Specification.

All coatings shall be applied as recommended by the manufacturer. Thinning shall be done only as recommended by the manufacturer for a particular application.

The surfaces to be coated shall be dry. No coating work shall be done in damp weather (rain, fog, mist, dew, etc.) which might cause a slight amount of moisture to collect or condense on the surface. No coating work shall be done when the ambient air temperature is below 50 degrees Fahrenheit or above 100 degrees Fahrenheit. No coating work shall be done if the relative humidity exceed 85% or if the substrate temperature is not at least 5 degrees Fahrenheit above the dew point.

Coatings shall be applied in a workmanlike manner by skilled applicators. All coatings must be evenly spread and smoothly flowed on and shall be free from runs and sags. Care shall be taken to apply a film of uniform thickness that completely covers all surfaces required to be coated and avoids local thin spots.

All coating materials shall be as manufactured by Keeler & Long, Inc., or equivalents approved in writing by the Engineer, and shall be as specified in the Coating Schedule contained herein. Intermixing of materials from different manufacturers will not be permitted.

All coating materials delivered to or received at the job site shall be in original unopened and sealed containers bearing manufacturer's name, type of designation, batch number and shelf life. All coatings shall be mixed in strict accordance with the manufacturer's written instructions, and thinning will not be permitted unless specified in those instructions.

All containers of coatings shall remain unopened until ready for use. The oldest of each kind of coating shall be used first. Containers, which have been opened, shall be used first.

Any coating material found not be in conformance with the specification shall be removed from the site, and from the structure, if already applied, at the Contractor's expense. If reapplication to a formerly coated surface is required, it shall be treated as if it had never been coated insofar as this Specification is concerned.

All coatings shall be stored in an area that is well-ventilated and free from excessive heat, sparks, flame, or the direct rays of the sun. The ambient temperature of the storage areas shall be maintained within the range specified in the Coating manufacturer's printed instruction, unless otherwise specified.

Coatings, which have livered, gelled, exceeded manufacturer's recommended shelf life, or otherwise deteriorated during storage shall not be used, and shall be removed promptly from the site.

Mixing of coatings shall be done in accordance with manufacturer's printed instructions. Power mixers may be used, but it should be noted that the heat generated could shorten the pot life of the coating.

Catalysts and/or thinners shall be added to the coatings strictly in accordance with the manufacturer's printed instructions. Uniform mixing shall be assured by checking for consolidated pigment remains.

If the coatings became thick in cool weather, they shall preferably be heated in the container by the use of paint heaters and not thinned by the addition of solvents. Deviations from manufacturers recommended storage temperature ranges will not be permitted without manufacturer's approval. The Contractor shall furnish, to the Engineer, all information on materials and supplies utilized by the Contractor.

Surface Preparation. The Contractor shall be wholly responsible for finish of his work, and shall not commence any coating work until the surface to be coated has been properly prepared in accordance with the surface preparation portion of the Coating Schedule contained herein. Chemical contamination shall be removed by washing with clean water, steam, neutralizing solutions, detergents, or other methods recommended by the Coating manufacturer.

Each designated surface area of each light tower to be painted shall be thoroughly washed clean using a sufficient number of cleaning cloths. The cloths shall be changed frequently to avoid using contaminated cleaning materials.

7. Application of Coating Materials. Coatings may be applied by brushes, roller, or paint mitt. All methods of application shall be in accordance with the best practice as recommended by the manufacturer.

When coatings are applied by brushing or rolling, the surface shall be cross-brushed or cross-rolled to secure uniformity of surface and the specified paint film thickness.

Coating Applicators:

Based upon the method of application selected, the proper applicator may be obtained from Best Libel, Philadelphia, PA. 19148, or Fond du Lac, WI. 54935

Brushes: 3 inch x 1 1/16 inch x 3-5/8 inch
Model: Beauty # 0-10015-00

Pipe Painter: 7 inch x 7/8 inch
(Roller) complete with cover, # 0-94580-00

Mitts: Lambskin PM-1 #0-94500-00
or
Synthetic PM-4 #0-94520-00

All surfaces shall be primed the same day as they are prepared. Finish coats shall be applied as soon as practicable after cleaning. If the surface becomes contaminated in the interim, it shall be refinished to the original cleanliness requirements.

Adequate ventilation must be assured, at all times, for proper drying.

Film thickness of the coating being applied shall be periodically checked using a wet film thickness gauge. Dry film thickness shall be calculated from wet film thickness and volume solids and as recommended by the coating manufacturer. In addition, each coat shall have been visually inspected for holes and thin spots before the next coat is applied.

Surfaces, which have been coated, shall not be handled, worked on, or otherwise disturbed until the coating is completely set. Sufficient time shall elapse between coats to permit them to dry hard. All layers of coated surfaces shall be unscarred and completely integral at the time of application of all succeeding coats.

Each coat shall follow the preceding coat within the time limits set by the manufacturer.

After the application of the scheduled number of coatings, the total dry film thickness (DFT) shall be within the range of the sum of the thickness of the coats as specified. The Contractor shall apply enough paint to adequately cover and to fulfill the DFT as specified in the Coating Schedule continued herein no matter how many coats are necessary.

All finished coating surfaces shall be uniform texture, free of any runs, drips, sags or other detrimental defects, and acceptable to the Owner.

Misplaced coating materials shall be promptly removed and the surface shall be made thoroughly clean and satisfactory to the Engineer.

Copies of manufacturer's application guides or printed instructions shall be conspicuously posted wherever materials are being prepared for application.

Cloths, cotton and waste material which might constitute a fire hazard, shall be placed in closed metal containers or removed from the working area at the end of each day's work.

The Contractor shall provide portable fire extinguishers of suitable type and sufficient number to permit placing at least one (1) extinguisher in any areas where coating with fume-creating or flammable products is in progress, and where coatings are stored and mixed. No smoking shall be permitted in these areas and the Contractor shall be responsible for policing the work.

All protective covers shall be removed upon completion of paint application.

Applicable Documents. The following codes, specifications and standards shall be considered integral parts of this specification. The latest issue of these codes and standards, and other tests and standards incorporated therein as applicable, in effect during the term of this contract, shall apply, unless otherwise noted.

Steel Structures Painting Council (SSPC) Pittsburgh, Pennsylvania 15213

Illinois Department Of Transportation
Electrical Maintenance Contract # 60E15
Section 2 – Special Provisions
Steel Structures Painting Manual, Volume 1, Good Painting Practice

Various Routes
Section 2008-002TS
Various Counties

Steel Structures Painting Manual, Volume 2, Systems and Specifications

SSPC-Vis.-1 No. 1 Pictorial Surface Preparation Standards for Painting Steel Structures.
Pay item LTP1 continued:

U.S. Department of Labor, Occupational Safety and Health Administration (OSHA) Washington, DC 20210

Title 29 Code of Federal Regulations, Occupational Safety and Health Act of 1970.
29 CFR 1910, 29 CFR 1926

Code of Federal Regulations, Resource Conservation and Recovery Act (RCRA)
40 CFR Parts 260-266

Coating Application Daily Log. The Contractor shall furnish all necessary test instruments to complete the information required on Log Form L-DA. The completed reporting logs shall be faxed to the Engineer as a record of each days work progress. A separate log shall be completed for each tower worked upon by the Contractor. Refer to Log Form L-DA at the end of this section.

Test Equipment:

The test equipment may be obtained from KTA-TATOR Co., Pittsburgh, PA. 15275
Telephone: 1-800-KTA-GAGE.

1. Surface Temperature Thermometer
Part # PTC 312F
2. Sling Psychrometer
Part # 127012
3. Weather Psychometric Tables
Part # WB235
4. Dry and Wet Film Thickness Gauges

Project Status Summary Log - Form L-TP

In addition to the Coating Application Daily Log, the Contractor shall submit a Daily Project Status Summary Log Form L-TP, showing the status of each light tower to be painted on the overall project. This information shall include the specific stage of operations at each light tower. Refer to Log L-TP at the end of this section.

Scope of Work:

LIGHT TOWER SHAFT

Surface Preparation. The tower shall be spot abrasive blasted as required in accordance with SSPC SP-6 Commercial Blast Cleaning and/or Power Tool Cleaned to SSPC SP-3, depending on overall condition. The remaining surface shall then be hand tool cleaned in accordance with SSPC SP-2 to remove all loose corrosion and existing paint. All oil, grease, dirt, salt and other surface contaminants shall be removed in accordance with Steel Structures Painting Council's SSPC SP-1 Solvent Cleaning Specification.

Coating System.

Prime Coat. The primer shall be applied to the entire designated area of each tower and be a two component, polyamide epoxy with the following characteristics:

Solids by Volume	66% ± 3%
Dry Film Thickness	4.0 - 6.0 mils
Color	Light Gray or White
VOC Content	2.6 Pounds/Gallon (or less)
Weight/Gallon	13.6 ± 0.5 (pounds)
Shelf Life	2 Years (minimum)
Flash Point	85 degrees F ± 2 degrees F (Pensky-Martens)

Finish Coat. The finish shall be applied to the entire designated area of each tower and be a single component co-polymerized silicone-alkyd with 20% - 30% silicone content, and shall have the following characteristics:

Solids by Volume	- 53% ± 3%
Dry Film Thickness	- 1.5 - 2.5 mils
Color	White or Hansford Gray
VOC Content	3.0 Pounds/Gallon (or less)
Weight/Gallon	9.0 ± 0.3 (pounds)
Shelf Life	2 Years (minimum)
Flash Point	105 degrees F ± 2 degrees F (Pensky-Martens)

LUMINAIRE RING ASSEMBLY AND HOOD

Surface Preparation. All oil, grease, dirt, salt and other surface contaminants shall be removed in accordance with Steel Structures Painting Council's SSPC Sp-1 Solvent Cleaning. The surface shall then be Hand Tool Cleaned in accordance with SSPC SP-2 to remove all loose corrosion and existing paint.

Coating System. Same as finish coat listed above.

CLEATS, WELDS AND HAND HOLE DOOR HARDWARE SURFACES

Surface Preparation. Prepare surfaces using the SSPC SP-11 power tool cleaning to bare metal to remove all rust and existing coating.

Coating System.

Prime Coat. The prime coat shall be the same as the shaft prime coat described above.

Finish Coat . The finish coat shall be the same as the shaft finish coat described above.

Method of Measurement. The light tower length for payment of all work described herein shall be measured, in feet, in place, and shall be measured as the distance in feet from the top of the head frame assembly to the shaft's base plate, spot blast clean and paint.

Basis of Payment. This item shall be paid at the contract unit price, per foot, of tower length for LIGHT TOWER, IN PLACE, CLEAN AND PAINT (GRAY OR WHITE), which shall be payment in full for all labor, materials and equipment required to complete the work as described herein.

LT04 Light Tower, Remove And Re-Erect

Description. This item shall consist of removing an existing light tower for inspection and/or retrofitting, and reinstalling the tower on foundation all during the same work day as designated by the Engineer. All appurtenant materials and work required for removing and reinstalling shall be included as part of this item. The retrofitting work as specified by the Engineer will be paid separately.

General. The existing light tower shall be disconnected and removed from the existing foundation by way of removing the anchor bolt nuts and lifting the light tower from the foundation.

Any damage sustained to the light tower during removal operations shall be repaired, or replaced in kind, to the satisfaction of the Engineer at Contractor's own expense.

Unless otherwise indicated, the light tower shall be reinstalled immediately after inspection and/or modification work the same day on the foundation. The electric power cables shall be reconnected so that tower becomes operational that evening without interruption.

All components shall be replaced upon re-installation of the tower. The anchor nuts shall be repainted. The nuts shall be tightened in compliance with torque specifications recommended by the manufacturer of the lighting unit.

As applicable, recently calibrated dynamometers shall employed by the Contractor for measuring the applied force during final assembly.

The Contractor shall remove the stainless steel screening at the base of the tower, prior to the removal of the tower, and after re-erecting and plumbing the tower, shall reinstall the screening and tighten all anchor bolt nuts, to the satisfaction of the Engineer. The Contractor shall exercise care in the removal of the screening so it remains in a serviceable condition. Replacement screening shall be included in this pay item.

A penetrating oil shall be applied to all anchor bolt nuts prior to removing. The Contractor shall exercise extreme care in the removal of the anchor bolt nuts so that no damage occurs to the anchor bolt threads. If an anchor bolt nut cannot be easily removed, the Contractor shall consult the Engineer to determine the best method to be used to remove the anchor bolt nut.

Any anchor bolt nuts damaged in the removal process or which the Engineer determines should not be reused, shall be replaced with anchor bolt nuts meeting the requirements of Article 1070.03 of the Special Provisions for Road and Bridge Construction, current version, for Light Towers.

Method of Measurement. Light tower shall be counted, each, remove and re-erect.

Basis of Payment. This item shall be paid at the contract unit price each for LIGHT TOWER, REMOVE AND RE-ERECT, which shall be payment in full for performing the work as specified herein.

LT05 Light Tower, Install Only

Description. This item shall consist of erecting a light tower as specified herein and as directed by the Engineer. Luminaire, lamp, lowering device and foundation shall be provided under separate pay items. This item shall be fully coordinated with the luminaire, lowering device, and foundation requirements. The light tower shall be paid separately.

Installation. Installation and shipment shall be in accordance with Article 835.04 of the Standard Specifications for Road and Bridge Construction, current version.

Method of Measurement. Light tower shall be counted, each, installed.

Basis of Payment. This item shall be paid at the contract unit price each for LIGHT TOWER, INSTALL ONLY, which shall be payment in full for installing the item as specified herein.

LT06 Light Tower, Lowering Device for Retrofit

Description. This item shall consist of removing, furnishing and installing a light tower lowering device for retrofit with 6, 8, or 12 luminaire ring, as specified herein. The lowering device shall be an equivalent to the existing lowering device. The drive mechanism, including an internally mounted torque limiter, shall be compatible with other existing towers in the same power center location that have previously been retrofitted.

Materials. Materials shall be in accordance with Article 1069.08 (e) of the Standard Specifications for Road and Bridge Construction, current version, except the motor as described under Article 1069.08 (k) shall be omitted.

Removal. Prior to the removal of any equipment, the Contractor shall arrange an inventory inspection with the Engineer. All equipment shall be inspected and logged a to type, size and condition. No removal work shall be permitted without approval from the Engineer.

Any damage resulting from the removal and/or transportation of the light tower shall be repaired, to its original condition, or replaced in kind, at the Contractor's own expense, to the satisfaction of the Engineer.

Transportation. The Contractor shall transport, handle and store (as applicable) the light tower in complete conformance with the manufacturer's recommendations. The Contractor shall make arrangements to transfer the material from the State's storage facility or directly from the manufacturer's facility to the job site.

Inspection and Acceptance. The Contractor shall examine the light tower in the presence of the Engineer and after acceptance shall be held responsible for preservation of the condition of the light tower, as it was at the time of acceptance, until the Final Acceptance Inspection.

Installation Procedure. The installation shall be in accordance with applicable articles of Section 835 of the Standard Specifications for Road and Bridge Construction, current version, and the following:

The Contractor shall remove existing luminaires, ring, fixtures and complete winch assembly, and install a complete new lowering device without any field welding or structural alterations of the handhole frame or doors. The pole shall be readied for the installation of new fixtures including the required counter weights.

Raising and Resetting the Tower. After the tower is reset, the tower assembly shall be inspected and checked for satisfactory operation through a full cycle. After the operation of the full cycle, make final adjustments. Work shall be completed as required, with no more than one night of down time per tower.

Method of Measurement. Light tower lowering device for retrofit with 6, 8, or 12 luminaire ring removed, furnished and installed shall be counted, each.

Basis of Payment. This item shall be paid at the contract unit price each for removing, furnishing and installing LIGHT TOWER LOWERING DEVICE FOR RETROFIT, for 6, 8 or 12 luminaire ring which shall be payment in full for the item as specified herein.

LT07 Cable, Combination Cctv & Lighting, Install

Description: This item shall consist of removing the existing power cable and installing a combination CCTV and power cable in a high mast tower, as specified by the Engineer. In addition, the Contractor shall coordinate with the Department's Advanced Systems Maintenance Contract (ASMC) contractor to install a camera mount, a camera and terminate the CCTV cable on the high mast tower, as designated by the Engineer. All appurtenant materials and work required for removing the old cable, reinstalling the new cable, splitting the cable at both ends and securing the CCTV and power cables, in an approved manner, with heat-shrinkable tubing; terminating the power cable for lighting shall be included as part of this item. The camera installation and its terminations, as specified by the Engineer, will be paid separately under ASMC

Removal: Prior to the removal of power cable, the Contractor shall conduct a thorough inspection with the Engineer, and shall log as to its type, size and condition.

No removal work shall be permitted without the approval of the Engineer. Any damage resulting from the removal of the lighting power cable, as specified, shall be repaired to its original condition, or replaced in kind, at the Contractor's own expense, to the satisfaction of the Engineer.

Materials: The Contractor shall use the combination CCTV and lighting cable from State Stock purchased under a separate non-routine pay item and stored at the warehouse.

Transportation: The Contractor shall transport and handle (as applicable) the combination CCTV and lighting cable in complete conformance with the manufacturer's recommendations.

Installation: The Contractor shall remove the old power cable in the tower by lowering the ring down and replace with a combination CCTV and power cable. The power cable shall be terminated in the junction box on the ring and to the four pin connector at the hand hole of the tower. The CCTV cable shall be fed through the ring to the tenon arm and to the camera mount by the Contractor, for terminations by the ASMC contractor. If the power cable and/or CCTV cable are damaged during the installation, the Contractor shall repair or replace the cable, as directed by the Engineer.

Unless otherwise indicated, the removal of lighting power cable and replacement of combination CCTV and lighting cable shall be coordinated with ASMC personnel to install the camera and terminate the CCTV cable to the camera at the same time. The electric power cables shall be reconnected so that tower becomes operational that evening without interruption in service.

Method of Measurement: Removal of power cable and installing a combination CCTV and lighting cable with terminations complete, as approved by the Engineer, shall be counted, each as a unit for payment.

Basis of Payment: This work shall be paid at the contract unit price each for COMBINATION CCTV AND LIGHTING CABLE, INSTALL, as described above, which price shall be payment in full for all work as described herein and as directed by the Engineer.

LU01 Luminaire, Fluorescent, For Building

Description. This item shall consist of furnishing and installing a fluorescent luminaire for building, with lamps, of the wattage and operating voltage as specified herein.

Materials. The housing shall be one piece and refractor made out of durable polycarbonate to reduce vandalism. The luminaire shall be designed and constructed in accordance with the requirements of UL. The mounting accessories, hardware and brackets, shall be made out of steel for environmental conditions.

The cover-reflector and socket-reflector junctions shall be sealed against the entry of moisture, dirt and insects with a thick, high density Dacron felt gasket, securely attached by mechanical means, such as a retaining lip, or by a wide-temperature permanent adhesive in a manner acceptable to the Engineer.

A decal, complying with the ANSI standard, shall be factory attached permanently to the luminaire. The information contained in the decal shall enable a viewer, from the ground level, to identify the lamp wattage and type of luminaire distribution.

Luminaire information submitted for approval shall include any recommendations of the manufacturer for storage as provided under this contract.

The packaging of the luminaires shall incorporate the provisions recommended by the manufacturer for storage.

Installation. The luminaires shall be installed in accordance with the plans or in pump stations or in the maintenance yard facilities, as specified by the Engineer

Method of Measurement. Luminaire shall be counted each, furnished and installed.

Basis of Payment. This item shall be paid at the contract unit price each for furnishing and installing a LUMINAIRE, FLUORESCENT, FOR BUILDING, of the type indicated, wattage and operating voltage indicated or shown on the plan, which shall be payment in full for the item as specified herein.

LU02 Luminaire, Fluorescent, for Wet Locations

Description. This item shall consist of furnishing and installing, a fluorescent luminaire for the weigh station pit area or wash bay at the maintenance yard, as specified herein, at the wattage and at locations as designated by the Engineer.

Materials. The housing shall be one piece and refractor made out of durable polycarbonate to reduce vandalism. The luminaire shall be UL listed for wet locations.

The cover-reflector and socket-reflector junctions shall be sealed against the entry of moisture, dirt and insects with a thick, high density Dacron felt gasket, securely attached by mechanical means, such as a retaining clip, or by a wide-temperature permanent adhesive in a manner acceptable to the Engineer.

A decal, complying with the ANSI standard, shall be factory attached permanently to the luminaire. The information contained in the decal shall enable a viewer, from the ground level, to identify the lamp wattage and type of luminaire distribution.

The packaging of the luminaires shall incorporate the provisions recommended by the manufacturer to accommodate storage. The submittal shall include these recommendations.

Installation. Manufacturer's recommendations shall be followed during the installation process. The wiring connections shall be made as shown on the drawings and in accordance with the National Electrical Code. The Contractor shall test the luminaires with the lighting controller energized to assure that all the components are working in accordance with their specifications and carrying rated load.

Wall mounted luminaires shall be either attached to structures, such as a wall, as indicated on the plans or as directed by the Engineer.

All mounting hardware shall be corrosion resistant and shall be stainless steel unless otherwise indicated.

Method of Measurement. Luminaire, fluorescent, shall be counted each, furnished and installed.

Basis of Payment. This item shall be paid at the contract unit price each for furnishing and installing a LUMINAIRE, FLUORESCENT, FOR WET LOCATIONS, of the type and wattage indicated by the Engineer, which shall be payment in full for the item as specified herein.

LU03 Luminaire, HPS, for Building Roof

Description. This item shall consist of furnishing and installing, a HPS, luminaire, with lamp and photocell, if specified, for flood lighting or roof mount, as specified herein. All boxes, recommended by the manufacturer for proper storage, shall be included in this item.

Materials. The housing shall be heavy duty, made of die cast aluminum. The luminaire shall meet NEMA specifications, high pressure sodium lamp, of specified wattage and voltage. The shield and other mounting accessories, as specified on the contract drawing, shall be included with the luminaire.

When closed, the optical assembly shall be sealed with a gasket against the entry of moisture, dirt and insects. The cover-reflector and socket-reflector joints shall be sealed against the entry of moisture, dirt and insects with a thick, high density Dacron felt gasket, securely attached by mechanical means, such as a retaining lip, or by a wide-temperature permanent adhesive in a manner acceptable to the Engineer. Submittal information shall include data

relative to gasket thickness and density and the means of securing it in place. Any alternative gasket material may be approved by the Engineer. There shall be a provision for thermal breathing. A charcoal filter may be used, subject to approval by the Engineer.

A decal, complying with the ANSI standard, shall be factory attached permanently to the luminaire. The information contained in the decal shall enable a viewer, from the ground level, to identify the lamp wattage and type of luminaire distribution.

Installation. The installation shall be as indicated on the plans, or as directed by the Engineer. All mounting hardware shall be corrosion resistant and shall be stainless steel unless otherwise indicated.

Method of Measurement. Luminaire shall be counted each, furnished and installed.

Basis of Payment. This item shall be paid at the contract unit price each for furnishing and installing a LUMINAIRE, HIGH PRESSURE SODIUM, FOR BUILDING ROOF, of the wattage and operating voltage specified, which shall be payment in full for the item as specified herein.

LU04 Luminaire, HPS, for Building Wall

Description. This item shall consist of furnishing and installing, a wall mounted luminaire, with lamp, as specified herein. All boxes, recommended by the manufacturer for proper storage, shall be included in this item.

Materials. The housing shall be of aluminum construction consisting of a single piece extruded main frame and flat sheet back panel. Heavy-duty cast aluminum doorframe shall be hinged and latched by means of a single screw. The optical system shall be adjustable, with “sharp cutoff”, reflector optical assembly consisting of a hydroformed, specular Alzak main reflector with both parabolic and cylindrical reflecting surfaces, auxiliary reflecting elements, and a support frame. Optical elements may be rotated to permit adjustment of cutoff over a range from 70 degrees through 86 degrees. The refractor shall be vandal resistant, injection molded, polycarbonate lens, UV stabilized, and complete with special UV inhibiting coating. The luminaire shall be UL listed for wet locations. The mounting accessories, hardware and brackets, shall be stainless steel, unless indicated otherwise.

The cover-reflector and socket-reflector junctions shall be sealed against the entry of moisture, dirt and insects with a thick, high density Dacron felt gasket, securely attached by mechanical means, such as a retaining lip, or by a wide-temperature permanent adhesive in a manner acceptable to the Engineer. It shall be an equivalent or better than the Paracyl luminaire.

A decal, complying with the ANSI standard, shall be factory attached permanently to the luminaire. The information contained in the decal shall enable a viewer, from the ground level, to identify the lamp wattage and type of luminaire distribution.

Luminaire information submitted for approval shall include any recommendations of the manufacturer for storage as provided under this contract.

The wattage and operating voltage as specified on the plan submitted shall be used as part of this pay item.

Installation. Wall mount luminaires shall be either attached to structures, such as a wall, as indicated or implied by the configuration on the plans, or as directed by the Engineer.

Method of Measurement. Luminaire shall be counted, each, furnished and installed.

Basis of Payment. This item shall be paid at the contract unit price each for furnishing and installing a LUMINAIRE, HIGH PRESSURE SODIUM, FOR BUILDING WALL, of the wattage and operating voltage specified, which shall be payment in full for the item as specified herein.

LU05 Luminaire, Keeper

Description. This item shall consist of furnishing, delivering and installing a luminaire keeper of the type and construction, as shown in figure L-22, to secure the luminaire to the mast arm or davit arm in case of a failure of the luminaire mounts.

Materials. The cable used for the luminaire keeper shall be 3.18 mm (0.0125”) stainless steel aircraft cable. The cable shall be secured at both ends, as shown on the drawing.

Method of Measurement. Luminaire keeper, shall be counted, each, furnished and installed.

Basis of Payment. This item shall be paid at the contract unit price each for furnishing and installing one, LUMINAIRE KEEPER, of the type and construction as specified, which shall be payment in full for the item specified herein.

LU06 Luminaire, Navigation LED

Description. This item shall consist of furnishing and installing a navigation LED light fixture including LED lamp, of the wattage as specified, conduit connection, wiring and all appurtenances mounted on fixed and moveable bridges, piers, abutment walls and dolphins.

Materials. The existing navigation light fixtures currently installed on the Department structures meet U.S. Coast Guard Bridge Lighting Regulations. Refer to Section 822 of the Standard Specifications for Road and Bridge Construction, current version. Replacement fixtures of equipment required under this contract shall:

- Meet current U.S.C.G. regulations.
- Be mounted in the same location and manner as the original units.
- Match the Fresnel lens color and degree spread (either 180 degrees or 360 degrees) as the existing units.
- Be equipped with a shielding device for protection from flying debris and other spurious objects.

The existing equipment was manufactured by Security Products Division of Federal Signal Corporation and identified as follows:

TYPE	DESCRIPTION
Type 1 Pier light	180 Degree red lens, cast aluminum housing
Type 1-A Pier light	180 Degree red lens, cast aluminum housing
Type 1-P Pivot type Channel or Pier light	180 Degree red lens, cast aluminum housing
Type 2 Pivot type Bridge Light	1 Green and 1 Red 180 Degree lenses, cast aluminum housing
Type 6 Channel Marker	360 Degree green or red lens, cast aluminum housing
Type 6 PSU Pivot type Channel light	360 Degree green or red lens, cast aluminum housing
Type 11 Channel light	2-360 Degree green or red lenses, cast aluminum housing

Installation. The Contractor shall provide all equipment, transportation and labor necessary to furnish and install the equipment as specified. New wiring and conduit will be paid under separate contract pay items.

Method of Measurement. Furnishing and installing each Navigation LED luminaire, as specified above and approved by the Engineer, shall be counted as a unit for payment.

Basis of Payment. This work shall be paid at the contract unit price each for LUMINAIRE, NAVIGATION LED, which shall be payment in full for furnishing and installing, specified herein and as directed by the Engineer.

LU07 Luminaire, Removal and Salvage

Description. This item shall consist of disconnecting, completely removing and transporting to the State's storage facility, and unloading as salvage, a luminaire mounted on a wall, roof, or ceiling, in a weigh station pit, light pole, light tower, underpass, tunnel sign structure or navigation light fixture as specified herein. This pay item shall also include removal of the associated conduit, wire and junction boxes. Proper documentation of the State's salvage is required with this pay item.

General. Luminaire removal shall be in accordance with Section 841 of the Standard Specifications for Road and Bridge Construction, current version.

Prior to the removal of any equipment, the Contractor shall arrange an inventory inspection with the Engineer. All equipment shall be inspected and logged as to type, size and condition. No removal work shall be permitted until approved by the Engineer.

Unless otherwise indicated, luminaires shall be removed, boxed in containers approved by the Engineer and delivered and unloaded at the storage facility of the State, or as designated by the Engineer.

Any damage resulting from the removal and/or transportation of the luminaire shall be repaired to its original condition, or replaced in kind, at the Contractor's own expense, to the satisfaction of the Engineer.

Existing anchors for underpass or tunnel lighting fixture which have been attached improperly shall be left in place as removal would cause more damage to the beam than leaving the anchors in place.

Method of Measurement. Each luminaire, which is removed, boxed as approved, delivered to storage, unloaded, inspected, and documented properly, shall be counted as a unit for payment.

Basis of Payment. This item shall be paid at the contract unit price each for LUMINAIRE, REMOVAL AND SALVAGE, which shall be payment in full for the luminaire location as specified herein.

LU08 Luminaire Shield, Pole

Description. This item shall consist of furnishing, delivering and installing a luminaire shield, for highway luminaires on light poles at locations, as directed by the Engineer, to minimize off-highway light infringement.

Materials. The luminaire shields shall be GE Lighting Systems Model ELSHS-M4AC, off-highway side luminaire shield, or approved equal. Highway side shields shall not be used.

Method of Measurement. Luminaire shield, pole, shall be counted, each, furnished and installed.

Basis of Payment. This item shall be paid at the contract unit price each for furnishing and installing one, LUMINAIRE SHIELD, POLE, of the type and construction as specified, which shall be payment in full for the item specified herein.

LU09 Luminaire Shield, Tower

Description. This item shall consist of furnishing, delivering and installing a luminaire shield, for highway luminaires on light towers, at locations, as directed by the Engineer, to minimize off-highway light infringement.

Materials. The luminaire shields shall be 15” high, curved shield, GE Lighting Systems Model ELS-HMAA060, off-highway side luminaire shield, or approved equal. Highway side shields shall not be used.

Method of Measurement. Luminaire shield, tower, shall be counted, each, furnished and installed.

Basis of Payment. This item shall be paid at the contract unit price each for furnishing and installing one, LUMINAIRE SHIELD, TOWER, of the type and construction as specified, which shall be payment in full for the item specified herein.

LU10 Luminaire, Tower, Install Only

Description. This item shall consist of retrieving from State’s storage facility, loading, transporting and installing a luminaire on a light tower, complete with new lamp, of the wattage as specified by the Engineer, and all required hardware as specified herein. The luminaire and new lamp shall be paid separately.

Installation. Installation shall be as described in Section 821.05 of the Standard Specifications for Road and Bridge Construction, current version and with the Special Provisions, attached at the end of the luminaire pay items.

Method of Measurement. Luminaires shall be counted each, installed.

Basis of Payment. This item will be paid at the contract unit price each for LUMINAIRE, TOWER, INSTALL ONLY, which shall be payment in full for the complete installation as specified herein.

LU11 Luminaire, Two Lamp Fluorescent, Install Only

Description. This item shall consist of retrieving from State’s storage facility, loading, transporting, installing, connecting, and adjusting ready for operation as a sign lighting luminaire, suitable for lighting expressway guide signs, as specified herein and as shown on the plans.

Installation. The installation shall conform to Article 821.07 of the Standard Specifications for Road and Bridge Construction, current version. The Contractor shall provide all equipment, transportation and labor necessary to install the equipment as specified. Splices, where the Engineer shall approve necessary. All wiring, terminal blocks, and ballast shall be fully enclosed within the fixture so that none of the above parts are exposed when relamping. The mounting hardware, including the U-channel, is incidental to this pay item.

Method of Measurement. Installing each luminaire, complete in place, with integral ballast and lamps as specified and as shown on the plans, as provided for installing at a highway sign, at the pay item specifications stated above, and approved by the Engineer, shall be counted as a unit for payment.

Basis of Payment. This work shall be paid at the contract unit price each for LUMINAIRE, TWO LAMP FLUORESCENT, INSTALL ONLY, complete in place, which shall be payment in full for the work as described herein.

LU12 Luminaire, Wall, Underpass or Tunnel, Install Only

Description. This item shall consist of retrieving from Owner’s storage facility, loading, transporting, and installing a wall, underpass or tunnel luminaire, complete with new lamp, of wattage as specified by the Engineer, and all required hardware, as specified herein. The luminaire and new lamp shall be paid separately, if furnished.

Installation. Installation shall be as described in Section 821.06 of the Standard Specifications for Road and Bridge Construction, current version and with the Special Provisions, attached at the end of the luminaire pay items.

Unless otherwise indicated, attachment of underpass lighting appurtenances, including the placement of associated anchors, but not limited to underpass luminaires, identification brackets and conduit shall not be attached and/or drilled into precast, prestressed concrete beams. However, existing anchors, which have been installed improperly, shall be left in place, as removal may cause more damage to the beam than leaving it in place.

Method of Measurement. Luminaire shall be counted each, installed.

Basis of Payment. This item will be paid at the contract unit price each for LUMINAIRE, WALL, UNDERPASS OR TUNNEL, INSTALL ONLY, which shall be payment in full for the complete installation as specified herein.

LU13 Emergency Light Fixture

Description. Furnish and install one emergency light fixture at the Maintenance Yards, Sign Shops, and other Department facilities in District 1, as directed by the Engineer. The fixture shall be a 2-lamp, 120 V, with a minimum two hour battery back up, totally enclosed industrial type fixture. Installation shall include all hardware, hangers, junction box and other appurtenances. Removal of the existing fixture, if necessary, shall be included in this work. Conduit and wire installation shall be paid through other pay items, where needed.

Method of Measurement. Furnishing and installing, removing old fixture if necessary, as specified above and approved by the Engineer, shall be counted as a unit of payment.

Basis of Payment. This work shall be paid at the contract unit price each for EMERGENCY LIGHT FIXTURE, which shall be payment in full for furnishing, delivering storing, installing and connecting the fixture, complete.

LU14 Luminaire, Metal Halide

Description. This item shall consist of removing the old fixture and furnishing and installing, a Metal Halide light fixture of the wattage specified, conduit connection wiring, and all appurtenances, mounted on location as specified by the Engineer, in facilities in District 1.

Materials. Materials shall be in accordance with Section 1067 of the Standard Specification for Road and Bridge Construction, current version, and with the Special Provisions, attached at the end of the luminaire pay items.

The wattage and operating voltage as specified on the plan submitted shall be used as part of this pay item.

Installation. The Contractor shall provide all equipment, transportation and labor necessary to furnish and install the Metal Halide light fixture as specified. New wiring and conduit up to 20' shall be included under this contract pay item, and will not be paid separately.

Method of Measurement. Removing an old fixture, furnishing and installing each Metal Halide Light Fixture, as specified above and approved by the Engineer, shall be counted as a unit for payment.

Basis of Payment. This work shall be paid at the contract unit price each for LUMINAIARE, METAL HALIDE, which shall be payment in full for the work, specified herein and as directed by the Engineer.

SPECIAL PROVISIONS FOR LUMINAIRES

These special provisions apply to the preceding luminaire pay items.

Revise the second paragraph, Article 1067.01(c) of the Standard Specifications:

“The reflector, the refractor or lens, and the entire optical assembly shall not develop any discoloration over the normal life span of the luminaire. An extended warranty over and above the normal warranty, shall be furnished by the manufacturer pertaining to the above said discoloration. The extended warranty shall be furnished in writing guaranteeing replacement, including cost of labor and shipment, free of charge to this contract and to the Owner, of any optical assembly, or any component parts thereof, which, as determined by the Engineer, would develop the aforesaid discoloration. The extended warranty shall accompany submittal information.”

Add the following to Article 1067.01(e). of the Standard Specifications:

“The ballast shall be a high power factor, low-loss, auto regulator type ballast.”

Delete Article 1067.01(e)(1) High Pressure Sodium Reactor ballast of the Standard Specifications

Revise Article 1067.01(e)(1) of the Standard Specifications to read:

“High Pressure Sodium Regulator. That ballast shall be a high power factor, constant wattage auto-regulator, lead type (CWA). The ballast shall be designed to furnish proper electrical characteristics for starting and operating a high pressure sodium vapor lamp of the specified rating at ambient temperatures of -29 degrees to +40 degrees C. The ballast windings shall be adequately impregnated and treated for protection against the entrance of moisture, insulated with Class H insulation, and able to withstand the NEMA standard dielectric test. The ballast shall include an electronic starting assembly.

The starting assembly shall be comprised of solid state devices capable of withstanding ambient temperatures of 85 degrees C. The starter shall provide timed pulsing with sufficient follow-through current to completely ionize and start all lamps. Minimum amplitude of the pulse shall be 2,500 volts, with a width of one (1) microsecond at 2,250 volts, and shall be applied within 20 electrical degrees of the peak of the open circuit voltage wave with a repetition rate as required by the lamp in accordance with ANSI for the 60 cycle wave. The lamp peak pulse current shall be a minimum of 0.2 amperes. Proper ignition shall be provided over a range of input voltage from 216 to 264 volts. The starter component shall be field replaceable and completely interchangeable with no adjustment necessary for proper operation. The starter component shall have push-on type electrical terminations to provide good electrical and mechanical integrity and ease of replacement. Terminal configuration shall preclude improper insertion of plug-in components. The starter circuit board shall be treated in an approved manner to provide a water and contaminant-resistant coating.

The ballast shall have an overall power factor of at least 0.9 when operated under rated lamp load. The ballast shall withstand a 2,500 volt dielectric test between the core and windings without damage to the insulation. The ballast shall not subject the lamp to a crest factor exceeding 1.8 and shall operate the lamp without affecting adversely the lamp life and performance.

The ballast shall be designed to ANSI Standards and shall be designed and rated for operation on a nominal 240 volt system. The ballast shall provide positive lamp ignition at the input voltage of 216 volts. It shall operate the lamp over a range of input voltages from 216 to 264 volts without damage to the ballast. It shall provide lamp operation within ANSI lamp specifications for rated lamp life at input design voltage range. All measurements shall be taken using a seasoned reference lamp conforming to ANSI test procedures. The reference lamp wattage shall not vary more that +/- 2% from the nominal wattage rating of the reference lamp.

Operating characteristics shall produce output regulation not exceeding the following values:

Nominal Ballast Wattage	Maximum Ballast Regulation
750	25%

400	25%
310	26%
250	22%
150	22%

For this measure, regulation shall be defined as the following:

$$\text{Percentage Ballast Regulation} = \frac{W_{LampH} - W_{lampL}}{W_{lampN}} \times 100$$

where: W_{LampH} = lamp watts at +10% line voltage (264v)
 W_{LampL} = lamp watts at - 10% line voltage (216v)
 W_{lampN} = lamp watts at line voltage (240v)

Ballast losses, based on cold bench tests, shall not exceed the following values:

Nominal Ballast Wattage	Maximum Ballast Losses
750	16.0%
400	16.0%
310	19.0%
250	17.5%
150	26.0%

Ballast losses shall be calculated based on input watts and lamp watts at nominal system voltage as indicated in the following equation:

$$\text{Percentage Ballast Losses} = \frac{W_{line} - W_{lamp}}{W_{lamp}} \times 100$$

where: W_{line} = line watts at 240v
 W_{lamp} = lamp watts at 240v

Revise the eighth paragraph of Article 1067.01 of the Standard Specifications to read:

“The testing performed shall include photometric and electrical testing. Photometric testing shall be in accordance with IES recommendations, in addition that the selected luminaire(s) shall be tested as manufactured without any disassembly or modification and, as a minimum shall yield an isofootcandle chart, with maximum candela point and half candela trace indicated, an isocandela diagram, maximum plane and cone plots of candela, a candlepower table (house and street side), a coefficient of utilization chart, a luminous flux distribution table, and complete calculations based on specified requirements and test results.”

Add the following to Article 1067.02(a)(1) of the Standard Specifications:

“The luminaire shall slip-fit on a two inch pipe arm, and shall have a barrier to limit the amount of insertion. The mounting clamp shall be concealed in the housing and provide a +5 degree vertical leveling adjustment. The slip-fit pipe entry shall be made by means of a flange internal to the cylinder and a round guide tube or other approved means which will provide a seal of the housing and minimum disruption of a smooth outside surface of the luminaire which will be compatible with the mounting arm.”

Add the following table(s) to Article 1067.01 of the Standard Specifications:

IDOT DISTRICT 1 LUMINAIRE PERFORMANCE TABLE

GIVEN CONDITIONS			
ROADWAY DATA	Pavement Width	m	(ft)
	Number of Lanes		
	I.E.S. Surface Classification	R3	
	Q-Zero Value	.07	
LIGHT POLE DATA	Mounting Height	m	(ft)
	Mast Arm Length	m	(ft)
	Pole Set-Back From Edge of Pavement	m	(ft)
LUMINAIRE DATA	Lamp Type	HPS	
	Lamp Lumens		
	I.E.S. Vertical Distribution	Medium	
	I.E.S. Control Of Distribution	Cutoff	
	I.E.S. Lateral Distribution	Type I	
	Total Light Loss Factor		
LAYOUT DATA	Spacing	m	(ft)
	Configuration	Single Sided	
	Luminaire Overhang over edge of pavement	m	(ft)

NOTE: Variations from the above specified I.E.S. distribution pattern may be requested and acceptance of variations will be subject to review by the Engineer based on how well the performance requirements are met.

PERFORMANCE REQUIREMENTS			
--------------------------	--	--	--

NOTE: These performance requirements shall be the minimum acceptable standards of photometric performance for the luminaire, based on the given conditions listed above.

ILLUMINATION	Average Horizontal Illumination, E_{AVE}	Lux	
	Uniformity Ratio, E_{AVE}/E_{MIN}		
LUMINANCE	Average Luminance, L_{AVE}	Cd/m ²	
	Uniformity Ratio, L_{AVE}/L_{MIN}		
	Uniformity Ratio, L_{MAX}/L_{MIN}		
	Max. Veiling Luminance Ratio, L_V/L_{AVE}		

LW01–LW02 Wash Luminaires

Description. The Contractor shall group wash luminaires, specified reflectors, and lenses for units of the highway lighting system. The exact quantities and locations where cleaning work is to be authorized each year will be determined by the Engineer. Submittals and work procedures will be discussed at a Contractor and Department procedures meeting.

As part of this item, the Contractor shall wash pole identification decals and accident reference markers. If any decals are torn or missing including the mounting bracket, they shall be replaced as part of this item.

General. A mild soap or detergent which is essentially neutral (pH approximately 6 to 8), nonabrasive and contains no chlorinated hydro-carbons shall be used for washing, with a clean, soft cloth, or brush if necessary.

Protect all surrounding painted surfaces and foliage to avoid damage from contact with washing solutions. Avoid wind drift onto passersby, vehicles or adjacent properties. Protect and/or divert pedestrian and auto traffic from the work area.

Pole and Tower Mounted Fixtures. All glassware shall be washed, rinsed and wiped dry, inside and out.

Underpass and Tunnel Fixtures and Tube Lighting. Wash, rinse and wipe dry both sides of the glassware and remove any dirt and debris from on or around the fixture.

Method of Measurement. Luminaires shall be counted, each, washed and cleaned.

Basis of Payment. This item shall be paid at the contract unit price each for LUMINAIRES, WASH, for the units of the highway lighting system as listed below, which shall be payment in full for all work specified herein.

LW01 WASH LUMINAIRES, LIGHT POLES

LW02 WASH LUMINAIRES, UNDERPASSES OR TUNNELS (incl. tube lighting)

LW03–LW05 Wash Tunnel Walls

Description. The tiled tunnel walls at highway lighting locations L0883, (Hubbard’s cave), L1325 (Post Office tunnel and piers), and L0903 (99th St. tunnel) shall be steam washed per paint and grout manufacturers’ recommended pressure and temperature. Both I/B and O/B sides shall be washed to remove dirt, dust or other foreign material. The Contractor shall inspect locations prior to bidding this item.

Hubbard’s cave approximate dimensions

Maximum Height: 14’

Length (4 sides): 741’, each side

Tile manufacturer: Buchtal

Grout: Epoxy coated latex modified according to ANSI Standard A118.6.

Post Office approximate dimensions:

Maximum Height: 14’

Length (2 sides): 270’, each side

99th Street tunnel approximate dimensions:

Maximum Height: 14’

Length (2 sides): 400’, each side

General. Protect all surrounding painted surfaces and foliage to avoid damage from contact with washing solutions. Avoid wind drift onto passersby, vehicles or adjacent properties. Protect and/or divert pedestrian and auto traffic from the work area. Use a soft bristled brush or broom for washing, and rinse with sponge and water. Pressure water rinsing may improve cleaning results, but is not required.

Materials. The detergent, used for the April washing, shall be Riptide (DL 2630), made by Drummond American, or equal. The Contractor shall follow all manufacturer instructions for application and use of the product.

The technical data is as follows:

Appearance:	Clear liquid	Specific Gravity:	0.991
Color:	Orange	Solubility in Water:	complete
Odor	Orange/citrus	Biodegradable:	100%
Flash Point:	130 degrees F.		

Test each type of surface before overall application to ensure suitability and desired results. Apply test areas according to the manufacturer's recommendations.

Method of Measurement. Tiled tunnel walls, each installation, washed.

Basis of Payment. This item shall be paid at the contract unit price, each, for TILED TUNNEL WALLS, WASH, at the locations specified below, which shall be payment in full for all work specified herein.

LW03 WASH TUNNEL WALLS (HUBBARD'S CAVE)

LW04 WASH TUNNEL WALLS (99TH STREET TUNNEL)

LW05 WASH TUNNEL WALLS AND PIERS (OLD POST OFFICE TUNNEL)

LWR1–LWR6 Wash and Relamp, Luminaires

Description. The Contractor shall wash lens in accordance with the luminaire manufacturer specifications, remove existing lamp and replace with new lamp, at highway and facility yard lighting locations as designated by the Engineer. This item shall include the price of the new lamp. The Engineer will determine the quantities and locations where re-lamp work is to be authorized each year. Work shall be documented on Log Form L-LR. Submittals and work procedures will be discussed at a Contractor and Department procedures meeting.

The fixture reflector shall not be handled when washing glass or replacing lamp. Each fixture opened for washing shall be securely re-locked. If any decals are torn or missing, including the mounting bracket, they shall be replaced as part of this program.

Pole and Tower Mounted Fixtures. All glassware shall be washed, rinsed and wiped dry inside and out.

Sign Mounted Fixtures. The Contractor shall perform the luminaire washing, relamping and safety inspections for approximately 1/3 of the Sign Lighting System luminaires in March/April and again in September/October for each contract year. Refer to Table S-1 for specific location information and approximate lamp quantities for each highway section and program period.

- The Engineer shall issue an authorization letter for each yearly program by February 1st and August 1st.
- The Contractor shall provide an overall program work schedule for each period.
- Upon receipt of an authorized letter for an individual program, and prior to the beginning of work, the EMC shall provide documentation of the requisition of the lamps and the vendor invoice. The invoice should refer to the EMC Contract year.
- The Contractor (or Sub-Contractor) shall list all work scheduled for specific locations on the Daily Agenda.
- The Contractor shall obtain lane closure and work approval from the IDOT Bureau of Traffic Operations for expressway locations scheduled on the Daily Agenda. The Engineer may suspend work operations should a required lane or shoulder closure not be obtained, or if proper traffic plan control is not used.
- A work crew person shall use Form S-1 to record required information at each site location at the time of work. Re-compiled or summarization of the original sheets in the office will not be accepted.
- After completing the FIRST DAY'S work on a new SECTION of highway lighting, the Foreman shall fax Form S-1 to the BTO Field Office for Engineer approval.
- The IDOT inspectors will randomly inspect work in progress and sign the ORIGINAL Log, Form S-1.

- The work crew foreman shall notify the IDOT Engineer on the day, when the work will be completed for a section of the highway; Ike, Kennedy, etc. The Foreman shall fax the copy of the S-1 log, for the last location in that section, to the Engineer, advising the completion of that section and being ready for inspection.
- Wash and relamp work on a section of highway sign lighting must be completed, and approved by the Engineer before the Contractor can begin a new section.
- While performing the wash and relamp work, the crew shall also conduct an overall inspection of each installation to ensure that each installation is maintained in a safe and proper operating condition as originally designed or as subsequently modified by the Department. Items to be inspected include: the general condition of the fixture (i.e., mounting and ballast) lamp lenses and hinges, disconnect switch, conduit and decals. All observed deficiencies shall be recorded on Log Form S-1. All signed original log forms shall be submitted with the respective invoice(s).
- The IDOT Inspector will approve work or prepare a corrective work list, noting work deficiencies that must be corrected prior to invoicing.
- It is estimated that a quantity of over 5000 of this pay item may be authorized per year.

SIGN LIGHTING GROUP WASH AND RELAMP PROGRAM					
SEC	LOCATION	MAR - APR 2009	SEPT - OCT 2009	MAR - APR 2010	SEPT - OCT 2010
01	I-55 STEVENSEN (COOK)		668		
02	I-55 (DuPage)		236		
03	I-55 (WILL)		220		
04	I-57 (COOK)	432			432
05	I-57 (WILL)	6			6
06	I-80 (COOK)	92			92
07	I-80 (WILL)	344			344
08	KENNEDY			1296	
09	DAN RYAN		430		
10	BISHOP FORD		318		
11	EDENS (LAKE)		38		
12	EDENS (COOK)	342			342
13	EISENHOWER (COOK)			928	
14	I-290 (DuPage)	604			604
15	I-290 (COOK)				416
16	N. COOK CO.	44			
17	C. COOK CO.		212		
18	S. COOK CO.		50		
19	DuPage CO.	248		248	
20	KANE CO.		68		
22	LAKE CO.	228			228
24	WILL CO.			19	
25	ELGIN O'HARE (COOK)		116		
26	ELGIN O'HARE (DuPage)		104		
27	Will County (X System)	32			32
	TOTAL QUANTITIES	2372	2460	2491	2496

- The Contractor shall complete all site work and documentation for the spring program by May 31st and the fall program by November 30th of each contract year.

Underpass, Wall and Roof Mounted Fixtures: Wash, rinse and wipe dry both sides of the glassware and clean any dirt and debris from on or around the fixture.

Navigation Lighting Fixtures: Wash, rinse and wipe dry both sides of the glassware and clean any dirt and debris from on or around the fixture.

Materials. All fixtures scheduled for group wash and relamping all have lamps replaced with a new lamp of the same type and wattage. All lamps used for group replacement shall be subject to approval by the Engineer.

Work Description. Luminaire Cleaning. Wash, rinse and wipe dry both sides of the reflector and clean any dirt and debris from on or around the fixture. Do not wash or tamper with the fixture refractor when washing the luminaire.

Lamp Replacement. Replace lamps in all fixtures with new lamps of the same type and wattage or an approved replacement. Close and lock each fixture after washing and lamp replacement.

Disposal. All used lamps shall be disposed of in accordance with the U.S. Environmental Protection Agency (EPA) directives and through a certified EPA disposal company. The old lamps shall be collected and boxed according to the disposal agency's recommendations. The Contractor shall provide all documentation necessary for submittal to all applicable agencies for the disposal of the various type of lamps and their quantities.

Method of Measurement. Luminaires shall be counted, each, fixture washed, old lamp removed and new lamp replaced.

Basis of Payment. This item shall be paid at the contract unit price each for LUMINAIRE, GROUP WASH AND REPLACE LAMP, which shall be payment in full for the types of lamps listed below, and all work specified herein.

LWR1 FLOURESCENT AND CFL
LWR2 HIGH PRESSURE SODIUM VAPOR
LWR3 INCANDESCENT
LWR4 LOW PRESSURE SODIUM VAPOR
LWR5 METAL HALIDE
LWR6 LED

LWR7–LWR8 Wash and Relamp Tube Lights

Description. The Contractor shall wash luminaire reflectors and lenses in accordance with the luminaire manufacturer specifications, remove existing lamp and replace with new lamp, at locations as designated by the Engineer. This item includes the price of the new lamp. The Engineer will determine the exact quantities and locations where re-lamp work is to be authorized each year. Work shall be documented on Log Form L-2. Submittals and work procedures will be discussed at a Contractor and Department procedures meeting. If any decals are torn or missing, including the mounting bracket, they shall be replaced as part of this program.

Materials. All fixtures scheduled for group wash and relamping all have lamps replaced with a new lamp of the same type and wattage. All lamps used for group replacement shall be subject to approval by the Engineer.

Relamping. Power shall be disconnected to the light injector before attempting to relamp or service. Failure to disconnect power before servicing may result in death or injury. Do not use flood lamps or any lamp with a beam wider than ten degrees. To replace a lamp, disconnect power to the lighting system. Remove three hex screws from the back of the lamp housing. Pull back cover straight back from lamp housing, exposing lamp. Remove lamp and install new lamp. Replace back cover making sure the back cover O-ring is in place.

Cleaning and Inspection. Clean with medium-pressure water spray and a mild detergent, or using a sponge or soft cloth in solution of water and mild detergent.

Safety/Mechanical Integrity Inspection. Inspect the rubber sleeve portion of each tube coupling in the system. The sleeve should be flat against the tube, and should be free of buckles or wrinkles. If the sleeve is cracked or ripped, replace the tube coupling.

Inspect (visually) the inside of each section of light tube for signs of moisture or dirt. Check for correct tube seating by applying pressure at each end of the section. If the tubes are NOT correctly seated, they will slide farther into the couplings. After all tubes are correctly seated, readjust the bracket mounting straps as required.

The optical performance of the tube lighting can be greatly affected by improperly-seated tube couplings as well as any openings to the outside environment that allow moisture or dirt to enter the tube. Tube couplings shall be inspected to ensure that the tubes are properly seated in the coupling and the rubber seal is intact.

Disposal. All used lamps shall be disposed of in accordance with the U.S. Environmental Protection Agency (EPA) directives and through a certified EPA disposal company. The old lamps shall be collected and boxed according to the disposal agency's recommendations. The Contractor shall provide all documentation necessary for submittal to all applicable agencies for the disposal of the various types of lamps and their quantities.

Method of Measurement. Luminaires shall be counted, each, fixture washed, old lamp removed and new lamp replaced.

Basis of Payment. This item shall be paid at the contract unit price each for LUMINAIRES, WASH AND RELAMP TUBE LIGHTS, which shall be payment in full for the types of lamps listed below, and all work specified herein.
LWR7 HIGH PRESSURE SODIUM VAPOR
LWR8 METAL HALIDE

Pump Station System – Non Routine Pay Items:

PA01 Alarm, Intrusion Override Key Switch

Description. This item shall consist of furnishing, installing and interfacing an intrusion override key switch to the SCADA panel and existing intrusion alarm system as specified herein and indicated by the Engineer into an existing pumping station.

Materials. The pumping station existing intrusion override key switch shall be replaced with a new intrusion override key switch that provides a contact closure to the SCADA panel and a contact closure to the existing intrusion alarm system when the intrusion alarm system is armed. Only the "barrel" of the existing override key assembly shall be replaced. The override key switch shall be from Chicago Lock Corporation, Ace II switch lock type with the key being compatible to the existing IDOT standard. The Contractor shall be responsible for coordinating IDOT authorization for the lock revisions.

All equipment furnished and installed under this item shall be appropriately identified with nameplates as specified under Basic Materials and Methods, elsewhere herein.

Installation. All intrusion override switches shall be mounted as indicated or directed by the Engineer, anchored as required and in conformance with the applicable specifications for Basic Materials and Methods, elsewhere herein.

Method of Measurement. Each intrusion override key switch as furnished, installed and approved by the Engineer shall be counted as a unit for payment.

Basis of Payment. This work shall be paid at the Contract unit price each for ALARM, INTRUSION OVERRIDE KEY SWITCH which shall be payment in full for the work as described herein.

PC01 Coating, Anti Graffiti

Description. This item shall consist of furnishing and applying coating to exterior concrete and/or glazed brick as specified herein and designated by the Engineer per pump station.

Materials. The coating shall be a single component, moisture curing aliphatic urethane that is chemical and graffiti-resistant, similar to Keeler & Long Mc-Antigraffiti Clear or Engineer approved equivalent.

Application. The contractor shall furnish a paint manufacturer approved painting contractor. The painting contractor shall assure that all surfaces are clean and free from grease, dirt, wax, or concrete sealers prior to application. A brush, roller, or sprayer may be used as long as the application complies with the manufacturers' application guide. If required, the paint contractor may have to apply multiple coats to obtain manufacturers' recommended thickness of 2.0 to 3.0 mils DFT.

Method of Measurement. A square feet of coating applied to a pump station in accordance with manufacturer's specifications, complete with clean up and approval of the Engineer, shall count as a unit for payment.

Basis of Payment. This work shall be paid at the contract unit price square feet for COATING, ANTI-GRAFFITI, which shall be payment in full for the work described herein.

PC02 Coating, Concrete Surface

Description. This item shall consist of furnishing and applying paint coating to exterior and interior concrete surfaces and all attached conduits and fittings as specified herein.

Materials. The concrete and conduit surface will receive one coat of polyamide epoxy primer 2.5 to 6 MILS DFT (Dry Film Thickness) and one coat of urethane enamel 2 to 4 MILS DFT. Unless the moisture content is above 3 LB/SF use a acrylic latex paint 2-4 MILS DFT with an approved primer 1/1/2 – 2/1/2 MILS DFT.

Application. The concrete surfaces shall be prepared to SSPC SP-2 hand tool clean or SSPC SP-3 power tool clean to remove any peeled or failed coatings. A solvent cleaning and scraping necessary to remove dirt, grease and peeling paint shall be used to prepare the floor. A moisture content test shall be performed and results provided to the IDOT Engineer. All conduits, fittings, boxes and switches attached and or within one foot of the concrete surfaces shall be cleaned properly and painted. The contractor may have to apply multiple coats to obtain manufacturer's recommended thickness.

Method of Measurement. A square foot of coating applied to a pump station in accordance with manufacturer's specifications, and clean up of work site, as approved by the Engineer, shall be counted as a unit for payment.

Basis of Payment. This work shall be paid at the contract unit price in square feet, for COATING, CONCRETE SURFACE, which shall be payment in full for the work described herein.

PC03 Coating, Steel Surface

Description. This item shall consist of furnishing, cleaning and applying a primer and final paint coating to steel surfaces as specified herein.

Materials. The coating shall be a tri-polar oil-alkyd primer 2-4 MILS DFT (Dry Film Thickness) and one finish coat of 20%-30% Copolymerized polysilicone enamel 1½ - 2 ½ MILS DFT. Steel located in dry pit or wet pits, where high humidity is present use Aluminum aromatic moisture cured urethane.

Application. The steel shall be prepared to SSPC SP-2 hand tool clean or SSPC SP-3 power tool clean to remove any rust, peeled or failed coatings.

Method of Measurement. A square foot of primer with final coating applied to a surface shall be counted as a unit for payment.

Basis of Payment. This work shall be paid at the contract unit price in square feet, for COATING, STEEL SURFACE, which shall be payment in full for the work described herein.

PD01 Detection System, Fire

Description. This work shall consist of furnishing labor, equipment and material to install a wall mounted fire alarm panel, and associated devices as specified herein and indicated by the Engineer.

Materials. Furnish a four zone fire alarm panel, class B/A with three photoelectric smoke detector with thermal, and two 12Volt @ 7 A.H. Gel battery.

Work Description. The contractor shall Install, commission, and perform testing on the fire alarm panel and associated devices. Commissioning shall be done by a qualified Fire Alarm Service Representative. The representative shall identify the location of the smoke and head detectors prior to installation. The output signal shall be connected to the SCADA and Aegis system. All conduit and wire necessary for complete installation in the pump station shall be paid under their respective pay items for conduit and wire. Submit all catalog cuts, shop drawings and pump station layout showing location of all devices for IDOT approval.

All equipment furnished, installed or mounted for this pay item shall conform to the applicable specifications for Basic Materials and Methods, elsewhere herein. The Contractor shall provide all submittals as specified above in this pay

item including catalog cuts, design drawings and product data sheets for the Engineers approval prior to installation. Three complete sets of record drawings, catalog cuts and O&M manuals shall be provided upon completion for Engineers approval

Method of Measurement. Each Detection System, Fire, that is inspected, tested, and certified shall be counted as a unit for payment.

Basis of Payment. This work will be paid at the contract unit price, each, for DETECTION SYSTEM, FIRE, which will be payment in full for the work described herein.

PF01–PF02 Fence, Gate, Remove and Replace

Description. The Contractor shall provide all personnel, equipment and material necessary to replace existing fence and gates as specified herein.

Materials. The Contractor shall furnish eight (8) foot chain link fence with three strands of barbed wires, galvanized steel fabric 2 in. mesh 9 gauge. With 1 5/8 in. top rail, 2 3/8 in. line posts, 1 5/8 in. brace rail, 2 7/8 in. corner posts, 2 7/8 in. end posts, 4” gate posts, 2 3/8 in. gate frame, truss rods, tension bands, tension bars, ground wire, ground rods and all fittings and accessories necessary to provide a complete fence and swing gate installation. All posts shall be galvanized by hot-dip process as specified herein and approved by the Engineer.

Work Description. The Contractor shall remove existing fence and gate including concrete footings and associated material. The material shall become the property of the Contractor and shall be disposed in a lawful manner. The new gate shall be fitted with a bar latch and two padlocks to enable either padlock to open latch. Install the gate plumb, level and secure for full opening without interference. The new fence shall be installed in-place of the existing fence. The above Materials specified shall be furnished and installed in accordance with the standard Specifications for Road and Bridge Construction Section 664.01. The chain link fence shall also adhere to the Standard 664001.

Method of Measurements. Chain link fence will be measured for payment in feet of the respective height of fence. The length paid for will be the overall length along the top of the fence from center to center of the end posts. Chain Link Gate will be measured for payment in feet of the respective height of gate. The length paid for will be the overall length along the top of the gate from center to center of the gateposts. Complete operational system that is furnished, installed approved by the Engineer shall be counted as a unit for payment.

Basis of Payment. This work shall be paid at the Contract unit price feet of
PF01 FENCE, REMOVE AND REPLACE
PF02 FENCE GATE, REMOVE AND REPLACE
which shall be payment in full for the work as described herein..

PG01 Gas Sensor, Remove and Replace

Description. This item shall consist of the removal, Installation, calibration and function test of a new gas sensor by a factory trained sales and Service Company. The transmitter and controller shall remain in place and functional with only the gas sensor being replaced.

Locations. The list of pump stations with their corresponding gas detector system manufacturer, number of sensors and their respective locations is listed under pay item PGS1.

Materials. The furnished gas sensor shall be equivalent or superior in quality to the existing gas sensor and be rated and approved for its intended use by the national FM and CSA standards. The furnished gas sensor shall have the same sensing element as the existing SCOTT, MSA or Rexnord gas sensors to be replaced.

Work Description. The factory trained sales and Service Company, such as Automatic Suppression Systems Inc., or Engineer approved equivalent shall execute this work in conjunction with Pay Item PG6 Gas Detector System Inspection. The removal and reinstallation of the sensor shall comply with manufacturer specifications.

Method of Measurements. Each gas sensor that is furnished, installed, calibrated, tested and approved by the Engineer shall be counted as a unit for payment.

Basis of Payment. This work shall be paid at the contract unit price each for GAS SENSOR, REMOVE AND REPLACE, which shall be payment in full for the work described herein.

PI01 Inspection, Automatic Bus Transfer System

Description. The contractor shall supply a factory trained field service technician to perform preventive maintenance testing and inspection of the automatic bus transfer scheme at PS #22, 23, 26,35. A service sheet shall be filled out listing both the “as found” and “as left” condition of the system. Equipment for the preventive maintenance, testing and inspection, include Main-Tie-Main transfer scheme, with associated circuit breakers, controls and devices.

Scope of Work.

1. Physical inspection will include:
 - Overall enclosure inspection for structural integrity
 - Verification of proper door swing, hinge operation, latching and door interlocking
2. Insure proper operation of:
 - Pilot devices such as selector switches and pushbutton
 - Control and timing relays
 - Protective devices
 - Auxiliary electrical contacts
 - Circuit breakers and switches
 - Operating mechanisms and interlocks
 - Other safety interlocks and mechanisms
 - Review of all power cable terminations for tightness. Conductor fraying and clearances
3. Electrical inspection will include:
 - Inspection of control wiring terminations
 - Pull apart terminal blocks engagement
 - Wiring conformance to factory schematics
 - Compare instrument transformer ratios to meter scales
 - Electrical operation of all components
 - Main, tie, and main circuit breaker inspection and
 - Testing in accordance with air circuit breaker test report, P-7.
4. Installation conformance to specifications:
 - Ensure physical arrangement conforms to factory drawings
 - Ensure supplied features and options conform to factory drawings
 - Ensure all wiring conforms to factory specifications
 - Adherence to State and local codes
5. Record of inspection and test results will be kept. A check-off list will be used; detailing work performed and results obtained. The formal report produced will list equipment as found, technical service/assistance rendered final equipment settings and recommendations. A report copy shall be submitted.

This pay item includes simulating a power failure to see if the Automatic Transfer System main tie main will properly switch over and switch back to normal upon power restoration. The breakers shall be inspected to look

for signs of arcing or pitting of the arcing contacts, and for uneven or premature wearing of the main contacts. All timing circuits will be tested and all connections will be checked for tightness.

The Electrical Maintenance Contractor shall be responsible for operation of the overall system and application. It is expected that the Contractor will have qualified personnel available with the necessary knowledge and authority regarding performance of the overall system and application so that the controller may be adjusted for optimum performance.

Method of Measurement. Each Service Automatic Bus Transfer System of each Pump Station as approved by IDOT Engineer shall be counted as a unit for payment.

Basis of Payment. This work shall be paid at the contract unit price each for INSPECTION, AUTOMATIC BUS TRANSFER SYSTEM, which shall be payment in full for the work described herein.

PI02 Inspection, Auto Transfer Switch

Description. The Contractor shall provide a factory trained service representative and shall use factory authorized testing equipment for all testing procedures to complete a comprehensive transfer switch inspection. The inspection, testing and maintenance shall be as recommended by the Manufacturer.

Scope of Work. The Inspection shall consist of the following work:

1. Verify that all cabled connections are on the proper terminals and torque to the proper specifications
2. Inspect unit for debris and clean
3. Check and adjust all voltage and current sensors as necessary
4. Check phase rotation of both sources
5. Check all auxiliary contacts and accessories are connected properly and adjust to the proper specifications
6. Inspect main contacts
7. Check integrity of electrical hardware of control panel
8. Perform milli-volt drop test
9. Test all light bulbs and replace if necessary
10. Inspect all mechanical interlocks
11. Inspect all electrical interlocks
12. Lubricate necessary moving parts
13. Inspect all limit switches
14. Coordinate with Generator Inspection load test for generator output and timer settings and verify with, specifications
15. Exercise timer operation and control.
16. Test unit and insure proper operation of all components

A report shall be submitted that includes the following:

1. Recorded values of all measurements taken such as voltage, amperage, frequency, milli-volt, etc.
2. Any adjustments made will be noted
3. Recommendations relative to repairs or upgrades
4. Note all options or features
5. Note the following per manufacturer recommendations:
 - “How to bypass unit”
 - “How to test unit”
 - “How to set times”

A record of inspection and test results will be kept. A check off list will be used detailing work performed and results obtained. The formal report produced will list equipment as found and final equipment settings and recommendations. The Contractor shall be responsible for operation of the overall system and application. It is expected that the Contractor will have qualified personnel available with the necessary knowledge and authority regarding performance of the overall system and applications so that the controller may be adjusted for optimum performance.

Method of Measurement. Each, for the Auto Transfer Switch Inspection of each pump station as approved by the Engineer shall be counted as a unit for payment.

Basis of Payment. This work shall be paid at the contract unit price, each for INSPECTION, AUTO TRANSFER SWITCH, which shall be payment in full for the work described herein.

PI03 Inspection, Gas Detector System

Description. This item consists of furnishing a manufacturer approved factory-trained sales and Service Company to test and calibrate a gas detector system as specified herein for a pumping station.

Locations. The following is a list of pump stations with their corresponding gas detector system manufacturer, number of sensors and their respective locations.

P.S.	Manufacturer	# of sensors	Locations
2	MSA Model 5100	2	1-motor control room 1-wet pit area
3	MSA Model 5100	2	1-motor control room 1-wet pit area
9	Bachrach	1	1-Motor control Room
10	MSA Model 5100	2	1-dry pit area 1-wet pit area
17	MSA	2	1-Dry pit 1-Wet pit
20	Rexnord 820	2	1-motor control room 1-wet pit area
21	SCOTT	4	1-motor control room 3-wet pit area
22	Detronics 2000	6	2-motor control room 4-wet pit area
23	Detronics 2000	6	2-motor control room 4-wet pit area
28	MSA Model ULTIMA	3	
30	MSA Model ULTIMA	3	
31	MSA Model 5100	1	1-wet pit area
34	MSA Model 5100	2	1-motor control room 1-wet pit area
39	Scott 2-channel Quadraflex	2	1-motor control room 1-wet pit area
41	MSA	2	1-Dry pit 1-Wet pit
42	Scott 2-channel Quadraflex	2	1-motor control room 1-wet pit area
43	MSA	2	1-Dry pit 1-Wet pit
44	MSA Model ULTIMA	2	1-Dry pit 1- Wet pit
46	MSA Model 5100	2	1-motor control room 1-wet pit area
47		1	1-motor control room
51	MSA Model 5100	2	2-wet pit area

52 MSA Model ULTIMA 2 1-dry pit
1-Wet pit

Pump Station 4, 7, 8, 9, 11, 12, 13, 15, 16, 18, 19, 24, 25, 26, 27, 29, 32, 33, 35, 36, 37, 38, 40, 48
Will have two sensors each a MSA ULTIMAX PCB/XP/MODBUS/LED and ULTIMAX IR. One in dry pit and one in the wet pit.

Work Description. The factory trained sales and Service Company shall furnish all tools and test equipment to complete the work as specified herein. The service company personnel shall be OSHA certified and equipped with proper safety equipment to enter areas where hazardous gases might be present. The Contractor shall provide access to the pumping station for the Service Company and assistance in reaching any difficult locations within the pumping station.

The Service Company shall complete the following procedures.

- 1) Clean all detectors and hydrophobic filters.
- 2) Check calibration of all detectors and adjust each, if required
- 3) Replace sensing element if calibration can no longer be properly performed. This work shall be completed at the time of testing but will be paid under separate contract unit price specified elsewhere herein.
- 4) Actual alarms of the detectors and sensors to ensure reliability.
- 5) Check gas detector internal and power supply wiring for grounds and shorts.
- 6) Check AEGIS and SCADA system for alarm acknowledgment.
- 7) Check all fans and dampers for start-up and/or shut down.

Report. A written report shall be submitted to the Engineer, which shall contain any pertinent recommendations for the system.

Method of Measurement. Each detector system that is tested, calibrated and has its accompanying report submitted and approved by the Engineer shall count as a unit for payment.

Basis of Payment. This work shall be paid at the contract unit price each for INSPECTION, GAS DETECTOR SYSTEM, which shall be payment in full for the work described herein.

PI04 Inspection, Switchgear System

Description. This item shall consist of furnishing of services and equipment to inspect the 600-Volt class switchgear, including the circuit breakers, bus, structure, instrument transformers and other devices, at a pump station. The services shall be provided by a factory trained field service technician.

Scope of Work. Preventative maintenance testing and inspection shall be performed according to the following inspection and test procedures.

Switchgear and Switchboard Assemblies:

1. Visual and Mechanical Inspection
 - Inspect the assemblies for physical damage
 - Inspect bussing compartment. Check tightness of accessible bolted bus joints by torque wrench method. Check insulators for cracks and contamination.
 - Verify all electrical, Key, and mechanical interlock systems for correct operation
 - Make closure attempt on locked open devices. Make opening/withdrawal attempt on locked closed devices
 - Check mechanical operations of circuit breaker in cell and activate auxiliary devices
 - Check ease of operation, proper grounding and interlock
 - Inspect circuit breaker for contamination, physical damage
 - Verify all LED's are working when the system is operating
2. Electrical Tests

- Insulation resistance of each bus section is measured phase to phase and phase to ground
- Electrical operation of the circuit breaker is checked in the test and connected position
- The control power source is checked
- The circuit breaker control scheme is tested
- A phasing check is made on double-ended and/or emergency source switchgear at tie points to ensure correct bus phasing.

Circuit Breakers:

1. Visual and Mechanical Inspection
 - Check mechanical operation
 - Cell fit and element alignment are checked
 - Check bolt torque levels are in accordance with manufacturers or U.S. Standards specifications
 - Check arc chutes for foreign matter, cracks and secure Installation
 - Clean primary contact surfaces and lubricate if required
2. Electrical Tests
 - Measure contact resistance
 - Check Insulation resistance at 1000 volts D.C. for one (1) minute from pole to pole and from each pole to ground and across open contacts for each phase.
 - Determine minimum long-time pick-up current and delay time at 300% of pick-up by secondary injection
 - Determine short-time pick-up and time delay by secondary injection
 - Determine instantaneous pick-up current by secondary injection
 - Determine ground fault pick-up current and time delay by secondary injection
 - Trip unit reset characteristics are verified
 - Final settings are made in accordance with Engineer's prescribed settings.
 - Auxiliary devices, such as under voltage relays, blown main fuses detector, shunt close, shunt trip, spring charging motor and auxiliary contacts are activated to ensure operation as applicable
 - All functions of the trip units shall be tested with test kits

Metering and instrumentation:

- Verify meter connections in accordance with single line meter and relay diagram
- Inspect for physical damage
- Electrical tests
- Ammeter accuracy is checked using current injection.
- Voltmeter accuracy is checked

SY/MAX 50PLC:

- Visual and mechanical inspection
- Inspect programmable controller Installation for physical damage
- Inspect for proper grounding
- Check for power wiring
- Check all terminal wiring
- Check all I/O wiring
- Check LI/RI wiring
- Verify correct switch settings on all modules
- Electrical tests
- Inspect sequence of operation
- Verify power supply voltages
- Verify operation of selected I/Os
- Verify resistance of LI/RI cable
- Verify input voltages
- Verify resistance of system ground

Record of inspection and test results will be kept. A check-off list will be used, detailing work performed and results obtained. The formal report produced will list equipment as found, technical service/assistance rendered final equipment settings and recommendations. A report copy shall be submitted to IDOT engineer.

Method of Measurement. Lump sum for Switchgear System Inspection approved by IDOT Engineer for the pump station shall be counted as a unit for payment.

Basis of Payment. This work shall be paid at the contact unit price lump sum for INSPECTION, SWITCHGEAR SYSTEM, which shall be payment in full for the work described herein.

PI05 Inspection, Motor Starter, Soft Start Type

Description. The contractor shall supply a factory trained field service technician to perform preventive maintenance testing and inspection of the soft start type motor starter at PS #22. A service sheet for each starter shall be filled out listing both the “as found” and “as left” condition of the starters. All starters shall be inspected and tested under this pay item. Equipment included in the preventive maintenance, testing and inspection five (5) Soft start buckets with associated controls including devices associated with the transfer scheme.

Scope of Work.

1. Physical inspection will include:
 - Overall enclosure inspection for structural integrity
 - Verification of proper door swing, hinge operation, latching and door interlocking
2. Insure proper operation of:
 - Pilot devices such as selector switches and pushbuttons
 - Soft starters
 - Control and timing relays
 - Overload and protective devices
 - Auxiliary electrical contacts
 - Circuit breakers and switches
 - Operating mechanisms and interlocks
 - Other safety interlocks and mechanisms
 - Review of all power cable terminations for tightness. Conductor traying and clearances
3. Electrical inspection will include:
 - Inspection of control wiring terminations
 - Pull apart terminal blocks engagement
 - Wiring conformance to factory schematics
 - Compare instrument transformer ratios to meter scales
 - Electrical operation of all components
4. Installation conformance to specifications:
 - Ensure physical arrangement conforms to factory drawings
 - Ensure supplied features and options conform to factory drawings
 - Ensure all wiring conforms to factory specifications
 - Adherence to State and local codes
5. Record of inspection and test results will be kept. A check-off list will be used, detailing work performed and results obtained. The formal report produced will list equipment as found, technical service/assistance rendered final equipment settings and recommendations. A report copy shall be submitted.
6. Servicing the Motor Soft starters includes final controller adjustments to ensure maximum performance, efficiency and conformance to system limitations. Adjustments include current limit, current trip, minimum and maximum voltage, and controller stability settings as described in the instructions manual. If the adjustable voltage ramp option is provided, initial torque, and ramp times settings are adjusted. Operational features, such

as jam/underload, extended start time and smooth stop, are checked and adjusted. The current calibration switch is checked for proper settings.

The Electrical Maintenance Contractor shall be responsible for operation of the overall system and application. It is expected that the Contractor will have qualified personnel available with the necessary knowledge and authority regarding performance of the overall system and application so that the controller may be adjusted for optimum performance.

Method of Measurement. Each for Servicing a Motor Starter, Soft Start Type, Inspection as approved by IDOT Engineer shall be counted as a unit for payment.

Basis of Payment. This work shall be paid at the contract unit price, each for INSPECTION, MOTOR STARTER, SOFT START TYPE, which shall be payment in full for the work described herein.

PI06 Inspection, Scada Radio Equipment

Description. This item shall consist of the Contractor providing a manufacturer approved factory sales and service company to inspect the IDOT SCADA radio system as described herein for the Hillside repeater, Central and Satellite radio as described herein.

Equipment. All radios, antennas, antenna line and connectors, surge suppressor, power supplies, batteries and all appurtenances for the site specific radio system for each location.

Materials. The factory sales and Service Company shall provide all necessary tools and manufacturer's test sets to complete this work.

Work Description. The Contractor shall assist the factory sales and Service Company, if required, to complete this inspection.

The factory Service Company's inspection shall include but not be limited to the following items:

Verification of transmit frequency, transmit power, voltage standing wave ratio (VSWR), transmit deviation, receive frequency, receiver sensitivity, receive audio with signal, receive audio without signal, forward/reflected power ratio levels, a printed time domain reflectometer (TDR) line trace and the antenna signal. All values for the above items shall be corrected, if required.

Test for 1/2 hour battery back-up power and replace battery, if required.

Reporting. The Service Company shall submit a report consisting of all data values for items stated above, the methods/means used to test and record the data values and the previous data values recorded during the last inspection (for comparison purposes). The report shall also include any pertinent changes made or required to the system.

Method of Measurement. The total inspection as provided for the Hillside repeater, Central and Satellite radios system including accompanying report and approval of the Engineer shall be counted as a lump sum unit for payment.

Basis of Payment. This work shall be paid at the contract unit price lump sum for INSPECTION, SCADA RADIO EQUIPMENT, which shall be payment in full for the work described herein.

PI07 Inspection, Scada Radio

Description. This item shall consist of the Contractor furnishing a manufacturer approved factory sales and service company to inspect the SCADA radio system for a designated pump station as described herein.

Equipment. All radios, antennas, antenna line, and connectors, surge suppressers, power supplies, batteries and all appurtenances for the site specific radio system for each location.

Materials. The factory sales and Service Company shall provide all tools and manufacturer's test sets to complete all work specified herein.

Work Description.

The factory sales and Service Company shall complete the following list of items.

1. Inspect and correct radio AFC and CTS operating parameters.
2. Check frequency, soft carrier delay, time-out timer length and status of squelch tail eliminator.
3. Check real forward RF power, VCO lock voltage, transmit power output, received signal strength, supply voltage of radio, regulator voltage and VSWR at antenna connector.
4. Check receiver sensitivity, forward/reflected power ratio levels and correct any deviation.
5. Check status of battery, power supply and diagnostics board and replace, if necessary.

Print a time domain reflectometer (TDR) line trace and submit with report

Reporting. The factory sales and service company shall submit a report consisting of data for all items stated above, the methods/means used to test and record consisting of all data values recorded during the last inspection (for comparison purposes). The report shall also include any pertinent changes made or required to the system.

Method of Measurement. Each inspection of pump station SCADA radio equipment including submittal of its report and approval by the Engineer shall count as a unit for payment.

Basis of Payment. This work shall be paid at the contact unit price each for INSPECTION, PUMP STATION SCADA RADIO, which shall be payment in full for the work, described herein.

PI08 Inspection, Backflow Preventer

Description. This work shall consist of inspecting, and testing the backflow preventer as specified at Pump Station 10, 17, 23, 31, 39, 44, 46, and 52.

Work Description. Inspection, testing, and certification of the backflow preventer shall be performed in accordance with: State of Illinois, Rules and Regulations; Title 35: Environmental Protection; Subtitle F: Public Water Supplies; Chapter II: Environmental Protection Agency; Part 653: Design, Operation and Maintenance Criteria; Subpart H: Cross-Connections. After the inspection and testing are complete, records of the test shall be submitted to the local community public works department and the Engineer. In addition, the Contractor shall provide the Engineer with documentation of the receipt of the test records by the local community public works department.

Method of Measurement. Each backflow preventer device that is inspected, tested, and certified shall be counted as a unit for payment.

Basis of Payment. This work will be paid at the contract unit price, each, for INSPECTION, BACKFLOW PREVENTER, which will be payment in full for the work described herein.

PM01 Pump Motor Balancing

Description. This pay item consists of furnishing labor, material and equipment to balance a motor as specified herein and indicated by the Engineer at a designated pumping station.

Materials. Contractor shall provide all instruments for testing the motors and balancing. The instruments and equipment shall be calibrated before testing. Proof of calibration shall be presented at each pumping station prior to testing.

Work Description. This item shall consist of balancing a motor of a specified horsepower. The balancing shall be done in conjunction with the motor inspection tests. The Contractor shall record all test readings as identified in the motor inspection before and after balancing and with coupled and uncoupled drive shaft.

Method of Measurement. Each motor of a specified horsepower that is balanced in accordance with manufacturer's recommendations and approved by the Engineer shall be counted as a unit for payment.

Basis of Payment. This work shall be paid at the contract unit price each for PUMP MOTOR BALANCING which shall be payment in full for the work described herein.

PUMP REBUILD PROGRAM

Scope Of Work. There are six types of pump rebuilds. After the Engineer and Pump Station Specialist have analyzed the condition of each selected pump and agreed to the type of rebuild and work schedule, the Engineer will issue an authorization for that specific type of rebuild. The Electrical Maintenance Contractor shall provide all the services as required during each calendar year of the Contract. The rebuild program locations are based upon site inspection and operational data including historical data of the pump capacity and vibration analysis. The Contractor is advised that the Engineer may change the proposed list of locations for rebuild as circumstances warrant during the contract year(s). The Electrical Maintenance Contractor shall submit the recommendations for pump repair or replacement any time during each calendar year.

Pump Station Specialist Requirements. The Pump Station Specialist is responsible to oversee the work on each pump, including removal, disassembly, and re-Installation. The Specialist will be required to provide documentation on a detailed inventory which includes test measurements such as micrometer measurement of the shafts, bearings, total indicator readings, threads per inch, shaft length and size, shaft stick-up, impeller settings, and end play. He is responsible for properly identifying all existing IDOT inventory and any removed or replaced parts. All inventories shall be properly tagged to IDOT specifications. The Specialist shall also perform inspections on repaired or new equipment, record any discrepancies, and provide recommendations on any/all aspects of the pump rebuild program.

Specialty Pump Repair Service Company. A minimum of six potential vertical/submersible service repair companies, within the tri-state area of Illinois/Indiana/Wisconsin shall be submitted during the pre-construction meeting, for review and approval of the Engineer. The Contractor shall be responsible to provide repair quote from approved vendors. Transportation of pump equipment in the tri-state area is included in each of the pay items. Cost of transportation outside this region will be discussed with the Engineer and can be paid as a separate item.

Specialty Pump Removal and Replacement Service Co. The Electrical Maintenance Contractor shall contract with a Specialty Pump Removal and Replacement Service Company, to establish a contractual arrangement for selected on call services for the pump rebuild program as specified in Pay Items Types 1, 2, and 3. The Specialty Pump Service Contractor is necessary to supplement the contractor's forces for certain projects involving the rebuild of certain select pumps where because of the type of rebuild, factory trained personnel having special technical qualifications would be desirable to facilitate certain rebuild projects. The Service Co. also shall provide quality control and quality assurance for work performed on selected vertical axial flow pumps. The Service Co. shall furnish factory trained or certified personnel with a minimum of 15 years experience and expertise in the removal and replacement of vertical mixed flow pumps. This Service Co. shall adhere to the above described Specialty Pump Repair Service Company requirements when providing a quote for repair or replacement and shall follow General pump rebuilding program procedures.

The Electrical Maintenance contractor's personnel shall coordinate with the Service Co.'s personnel on scheduling and performing removal, replacement, energizing, de-energizing and disconnection of any motor electrical splices at the junction boxes.

The following are the procedures by which a pump rebuild is executed. Charges for these items shall be paid through the following pay items:

- PRB1 Pump Rebuild Type 1**
- PRB2 Pump Rebuild Type 2**
- PRB3 Pump Rebuild Type 3**
- PRB4 Pump Rebuild Type 4**
- PRB5 Pump Rebuild Type 5**
- PRB6 Pump Rebuild Type 6**

Pump Rebuild Program Procedures. The pump rebuild program is primarily developed using operational data received by testing and inspecting pumps via various routine maintenance programs and periodic inspections. Each pump rebuild is normally executed when spare part(s) are available in State Stock. Following is a step by step procedure for this program:

General Procedures:

- Pump is selected for the rebuild program.
- The Specialist is scheduled to be present for removal and reinstallation of the pump.
- An inspection report of the removal is completed and submitted to IDOT by the PS Specialist with their recommendations.

Case A: If pump/pump part is to be repaired:

1. The pump or its part shall be sent to the service Repair Company to be inspected.
2. The service co. shall solicit and obtain a quote(s) for pump repair(s).
3. The quote(s) are analyzed by the IDOT Engineer to determine which company shall be authorized to do the repair. The service co. shall be responsible to transport the pump (if necessary) to the selected company's facility for the repair as specified in the following pump rebuild pay items.
4. Following the repair(s) the pump/part(s) shall be inspected and approved by the PS Specialist. Before assembly by the repair facility, the PS Specialist for review and approval shall submit a corresponding inspection report to the Engineer.
5. The Engineer shall review the repair report and final re-assembly, and if found satisfactory shall approve the subsequent return of the repaired materials to the designated Pump Station.

Case B: If State Stock Pump/Pump Part(s) are to be used as a replacement:

1. The state stock pump/pump part(s) shall be disassembled and inspected by the Engineer and the PS Specialist to determine satisfactory condition.
2. If the spare part(s) are determined (or suspected) to need reconditioning they shall be sent to a service company. The same procedure(s) should then be followed as in Case A above.

Case C: If Pump/Pump Part(s) are to be replaced:

1. The PS Specialist shall submit a report to the Engineer indicating the type, make, model and material specification for the pump replacement parts.
2. The PS Specialist and the Engineer shall review the manufacturer's pump/pump part(s) literature and test data.
3. The Engineer shall make arrangements to procure the selected pump/pump part(s) for replacement.

4. Following delivery of the new equipment, the PS Specialist shall inspect it and submit a report to the Engineer for approval.

PRB1 Pump Rebuild, Type 1

Description. This item shall consist of providing transportation within the Tri-State area, removal and re-Installation of a complete mixed flow pump assembly as a single unit not including the motor. The Pump Removal and Replacement Service Co. shall remove and install the pump as specified herein and conform to PR496. The service co. shall procure quotes for the pump repair as directed by the Engineer. The Engineer will evaluate the specialty service quotations and authorize work according to account PV. This type of work would be applicable for Pump Stations 7, 25, 26 and 47.

Work Description. As part of removal and re-installation the service co. shall provide all labor, tools, transportation and the use of a crane.

The work shall include but not be limited to the following items:

- 1) De-coupling and removing the motor drive from the pump assembly.
- 2) Complete removal of the pump assembly including the discharge column, drive shafting, enclosing tube and bowl as a complete unit.
- 3) Loading and unloading of the complete unit on a flatbed truck.
- 4) Transportation of the complete pump assembly to the approved service company shop for repairs and delivery of the pump back to the station upon completion of work.
- 5) Re-Installation of the complete pump assembly includes the motor.
- 6) Provide all services for start-up and testing prior to putting the pump back in service.
- 7) All work shall be accompanied with its respective warranties and guaranties.
- 8) If test results are unsatisfactory, the Contractor shall be responsible for analyzing all operational problem(s) and resolving it to the Engineer's satisfaction.

The above information is for removal and for information only. Exact procedure necessary for removal and re-Installation of a complete operational pump is the responsibility of the Service co.. This item shall also include the loading and unloading of pump parts and equipment.

Pump capacity, vibration tests, motor current and voltage readings shall be taken upon Installation of pump. The readings and tests shall conform to the pump and motor specifications, or be approved by the Engineer.

Method of Measurement. Each removal and re-Installation of a complete mixed flow pump assembly as a single unit including all connections and transportation as specified herein and approved by the Engineer shall be counted as a unit for payment.

Basis of Payment. This work shall be paid at the contract unit price each for PUMP REBUILD, TYPE 1, which shall be payment in full for the work described herein.

PRB2 Pump Rebuild, Type 2

Description. This item shall consist of providing transportation within the Tri-State area for, removal and reinstallation of a pump bowl from the complete pump assembly as a single unit not including the motor. The pump removal and replacement service company. Shall remove and install the pump as specified herein and in conformance with PR496. The Service Company shall procure quotes for the pump repair as directed by the Engineer. The Engineer will evaluate the specialty service quotations and authorize work according to account PV. This type of work shall be applicable for Pump Stations 2, 3, 4, 24, 27, 29, 33, 35 and 47.

Materials. This item shall require the furnishing of stainless steel bolts and oil for lubrication.

Work Description. The work within this item shall require the use of a crane and chain falls. The Service Company shall provide all equipment, transportation and labor necessary to work as described herein. The work shall include but not be limited to the following items:

- 1) Disconnect breaker
- 2) Uncouple motor coupling
- 3) Lift motor and set aside
- 4) Remove dresser coupling
- 5) Set up chain fall on top of hatch or use a crane if required
- 6) Lift pump and column assembly to allow space for removal of bowl assembly from bottom of column pipe. (That contains the discharge pipe, bowl and oil tube assembly including the shaft and motor stand.)
- 7) Brake loose tube tension unit.
- 8) Disconnect grease line from the assembly
- 9) Drop bowl assembly
- 10) Break loose the oil tube and shaft coupling
- 11) Remove bowl
- 12) Take out shafting and oil tube assembly

The above information is for removal and for information only. Exact procedure necessary for removal and re-Installation of a complete operational pump is the responsibility of the Service company. This item shall also include the loading and unloading of pump parts and equipment.

Pump capacity, vibration, motor current and voltage readings shall be taken upon Installation of pump. The readings and tests shall conform to the pump and motor specifications or be approved by the Engineer.

Method of Measurement. Each bowl that is removed and reinstalled per pump as described herein and approved by the Engineer shall be counted as a unit for payment.

Basis of Payment. This work shall be paid at the contract unit price each for PUMP REBUILD, TYPE 2, which shall be payment in full for the work described herein.

PRB3 Pump Rebuild, Type 3

Description. This item shall consist of providing transportation within the Tri-State area for, removal and reinstallation of a complete mixed flow pump assembly in stages and disassembly of the complete unit on pump station grounds. The pump removal and replacement Service Company shall remove and install the pump as specified herein and conform with PR496. The Service Company shall procure quotes for the pump repair as directed by the Engineer. The Engineer will evaluate the specialty service quotations and authorize work according to account PV. This type of work will be applicable for Pump Stations 2, 3, 4, 26, 27, 29, 33 and 35.

Work Description. The service company shall furnish all equipment, labor, transportation and material, including lifting crane to perform the work as specified herein. This work shall include but not be limited to the following items:

Disassembly of the pump into the following parts: motor, oil tube sections, shafting, coupling, bearing, bowl assembly, column pipes in sections, motor stand, and set-up for inspection by a service manufacturer for service and repairs and loading and unloading of equipment that requires inspection and repair.

The above information is for removal and for information only. Exact procedure necessary for removal and reinstallation of a complete operational pump is the responsibility of the Service Co.. This item shall also include the loading and unloading of pump parts and equipment.

Pump capacity, vibration tests, motor current and voltage readings shall be taken upon Installation of pump. The readings and tests shall conform to the pump and motor specification, or be approved by the Engineer.

Method of Measurement. Each pump that is removed and reinstalled per pump station, including all equipment, labor, transportation and approval of the Engineer shall be counted as an unit for payment.

Basis of Payment. This item shall be paid at the contract unit price each for PUMP REBUILD, TYPE 3, which shall be payment in full for the work described herein.

PRB4 Pump Rebuild, Type 4

Description. This item shall consist of providing transportation within the Tri-State area for, removal of wetpit/drypit submersible and side volute discharge pumps and their rotating assembly for service, repair and reinstallation. The Contractor shall remove and install the pump as specified herein and conform with PR496. The Contractor shall procure quotes for the pump repair as directed by the Engineer. The Engineer will evaluate the specialty service quotations and authorize and pay for work according to account PV. This type of work will be applicable for Pump Stations 2, 3, 5, 8 - 23, 25, 27 - 32, 34, 36 - 44, 46 - 48, 50 and 51.

Work Description. The service company shall furnish all equipment, transportation and labor necessary to perform the work as specified herein. This work shall include but not be limited to the following items:

- 1) Setting up for removal
- 2) Disconnecting the drive shaft from the rotating assembly
- 3) Close gate valve and provide a blind flange if necessary to stop water leaks
- 4) Loosening the bolt of the rotating assembly from the volute
- 5) Remove rotating assembly out from pump station
- 6) Loading and unloading of equipment that requires inspection and repair.

This work will consist of removing and installing the open shaft and rotating assembly and setting up inspection for manufacturer's sales and service companies for service and repairs.

The above information is for removal and for information only. Exact procedure necessary for removal and reinstallation of a complete operational pump is the responsibility of the service company. This item shall also include the loading and unloading of pump parts and equipment.

Pump capacity, vibration tests, motor current readings shall be taken upon Installation of pump. The readings and tests shall conform to the pump and motor specifications or be approved by the Engineer.

Method of Measurement. Each side volute discharge pump and its rotating assembly that is removed and reinstalled as described above and approved by the Engineer shall be counted as a unit for payment.

Basis of Payment. This work shall be paid at the contract unit price each for PUMP REBUILD, TYPE 4, which shall be payment in full for the work described herein.

PRB5 Pump Rebuild, Type 5

Description. This item shall consist of removal of an existing side volute discharge pump and motor assembly and replace with a dry pit submersible pump as furnished elsewhere herein. This item will be applicable for Pump Stations 32.

Materials. The pump removal and replacement Service Company shall replace the gate valve of the removed pump and replace with a gate valve that is specified below.

- 1) Gate valves shall have a CWP non-shock rating of 150 psi
- 2) Gate valves shall be metal seated type, round, port design for high flow capacity.

- 3) Gate valve body shall be constructed of cast iron with an inner stainless steel lining. All wetted parts of the body, chest area and packing chamber shall be constructed of type 316 stainless steel for maximum corrosion resistance.
- 4) The body shall be a wafer face-to-face design with supporting ribs between the raised face flange to provide additional valve strength. Flange bolt holes shall be drilled for through bolting, except where tapped as required in the chest area, to the ANSI class 125/150 standard.
- 5) The gate shall be constructed of stainless steel and finish ground on both sides. The gate shall have a beveled, knife-like edge.
- 6) The valve stem shall be constructed of stainless steel and shall have double-pitch threads. Gate guides and jams shall be provided for proper support and positive seating of the gate against a raised face seat.
- 7) The gate valve packing shall be plastic coated for corrosion resistance. The packing chamber shall have a smooth-surface liner of uniform chamber width that shall accept extra ring type layers of packing material. Packing gland adjusting bolts shall be easily accessible.
- 8) The gate valve superstructure shall be fabricated, angular steel. A bronze yoke sleeve shall be provided as part of the superstructure for ease of valve operation.
- 9) Non-motorized gate valves shall be provided with bevel gear actuators to provide vertical mounting for a chain wheel actuator. The chain wheel actuator shall be as specified elsewhere herein.
- 10) The gate valve shall be provided with chain wheel actuator for manual operation. The chain wheel shall be provided with rust-resistant chrome-plated operating chain of sufficient length to allow floor operation. The chain wheel shall be positioned 90 degrees relative to the valve/pipe center-line to assure floor operation.
- 11) The gate valve shall be Dezurick Series L, ITT Fabri, or approved equal.

Installation. All equipment furnished, installed or mounted for this pay item shall conform with the applicable pump station reference specifications detailed elsewhere herein.

The Contractor shall furnish the labor to remove and install all electrical wiring, conduits, relays, fuses, circuit breakers, knife switch disconnects, starters, timers, and any other electrical appurtenances required. The electrical schematic diagram and piping layout shall be submitted for approval by the Engineer.

The pumps shall be installed in compliance with the manufacturer's recommendations.

The pump shall be removable through the pump access hatch. Provide a means to guide the draw-down pump into place when the pump is lowered into the dry pit through the pump hatch. Submit details to the Engineer for approval prior to Installation.

Each installed pump shall be complete with an inlet stand assembly, including anchoring flanges and an integral port suction elbow and clean out port with removable cover, this shall be indicated on submitted drawings.

Each installed pump shall be installed on a steel base support of the pump manufacturer's design and recommendation, designed to straddle the pump inlet port area for access to the pump suction pipe.

The base shall be of adequate strength and rigidity to prevent harmful vibration or deflection of the pump piping from the forces involved in the application. Data submitted for approval shall include calculations supporting an included manufacturer's certification of the adequacy of the base design. The base may be a combination of a steel frame and concrete pad, as required to properly join the pump with the new and/or existing piping as approved by the Engineer.

After assembly and Installation on the foundation, the pumping units shall be leveled, aligned, wedged in place and grouted with a non-shrink grout. Grouting shall not take place until after the initial fitting and alignment.

The manufacturer shall inspect the pump Installation and shall certify that the pumps have been installed properly. Information submitted for approval shall include a letter of intent to provide this certification.

In addition, the services of a qualified representative of the manufacturer shall be provided to supervise the testing of the equipment, make any necessary adjustments, place it in initial trouble-free operation, and instruct the operating personnel in its operation and maintenance.

Testing. After Installation of the pumping units and all accessory equipment, the units shall be subjected to running tests under actual operating conditions. The tests shall be made at the expense of the Contractor and conducted in the presence of the Engineer and the State of Illinois. The following items shall be specifically checked:

- The units are installed according to plans and specifications and the manufacturer's instructions:
- There is no pipe strain on the pump units.
- The units are properly aligned.
- Vibration limits are with Hydraulic Institute Standards.
- There is no over heating of bearings or other parts.
- The full load current is not exceeding the nameplate rating.
- The units are properly grouted and secured.

The tests shall include a timed pump run and a field capacity check. If, in the judgment of the Engineer, pump performance, as measured in the field test, is not substantially true to published characteristics, modification, adjustment or replacement of the equipment shall be made to achieve specified performance results.

Due to the required continuous operation of the station the pumps may be installed and field tested progressively, as approved by the Engineer.

Clean-Up and Safety. The work site shall be maintained in a clean condition, free of hazards, all in conformance with the requirements of Article 107 of Standard Specifications. Special care shall be taken to assure that electrical systems are not left in an exposed or otherwise hazardous condition. All electrical boxes, cabinets, pole handholes, etc., which contain wiring either energized, or non-energized, shall be closed or shall have their covers in place and shall be locked when possible during off-work hours.

Method of Measurement. Each side volute discharge pump and motor assembly that is removed and replaced with a dry pit submersible pump as specified herein and approved by the manufacturer and the Engineer shall be counted as a unit for payment.

Basis of Payment. This work shall be paid at the contract unit price each for PUMP REBUILD, TYPE 5, which shall be payment in full for the work described herein.

PRB6 Pump Rebuild, Type 6

Description. This item shall consist of furnishing all material, transportation, labor and equipment for the removal of an existing side volute discharge pump and motor assembly and replace with a dry pit submersible pump as furnished elsewhere herein. This item will be applicable for Pump Station 14. This work includes the replacement of the pump discharge pipe to the first manhole about 16' away from the pump station.

Materials. The pump removal and replacement Service Company shall replace the gate valve of the removed pump and replace with a gate valve that is specified below.

- 1) Gate valves shall have a CWP non-shock rating of 150 psi
- 2) Gate valves shall be metal seated type, round, port design for high flow capacity.
- 3) Gate valve body shall be constructed of cast iron with an inner stainless steel lining. All wetted parts of the body, chest area and packing chamber shall be constructed of type 316 stainless steel for maximum corrosion resistance.
- 4) The body shall be a wafer face-to-face design with supporting ribs between the raised face flange to provide additional valve strength. Flange bolt holes shall be drilled for through bolting, except where tapped as required in the chest area, to the ANSI class 125/150 standard.
- 5) The gate shall be constructed of stainless steel and finish ground on both sides. The gate shall have a beveled, knife-like edge.
- 6) The valve stem shall be constructed of stainless steel and shall have double-pitch threads. Gate guides and jams shall be provided for proper support and positive seating of the gate against a raised face seat.

- 7) The gate valve packing shall be plastic coated for corrosion resistance. The packing chamber shall have a smooth-surface liner of uniform chamber width that shall accept extra ring type layers of packing material. Packing gland adjusting bolts shall be easily accessible.
- 8) The gate valve superstructure shall be fabricated, angular steel. A bronze yoke sleeve shall be provided as part of the superstructure for ease of valve operation.
- 9) Non-motorized gate valves shall be provided with bevel gear actuators to provide vertical mounting for a chain wheel actuator. The chain wheel actuator shall be as specified elsewhere herein.
- 10) The gate valve shall be provided with chain wheel actuator for manual operation. The chain wheel shall be provided with rust-resistant chrome-plated operating chain of sufficient length to allow floor operation. The chain wheel shall be positioned 90 degrees relative to the valve/pipe center-line to assure floor operation.
- 11) The gate valve shall be Dezurick Series L, ITT Fabri, or approved equal.

The Contractor shall remove existing check valve at Pump Station 14. The Contractor shall furnish and install a TightFlex check valve or equivalent.

Quantity	Size
1	16 inch – TideFlex Series 39 Flanged Check Valve
1	14 inch – gate valve 125# flanged
1	Pump Section Elbow Flanged 20 ¾ inches Face to Face
1	16” 150# Flange X Plain end Ductile Iron Spool, 16’ pipe
1	16” x 12” Concentric pipe Reducer
1	12 inch base elbow
1	16 inch Schedule 40 LR Elbow Flanged
2	16” Schedule 40, 10’ pipe

The above quantities and lengths are approximate and are listed for information only. Exact quantities, dimensions and all other materials that may be necessary to render the new Installation complete for operation is the responsibility of the Service Company.

Installation. All equipment furnished, installed or mounted for this pay item shall conform to the applicable pump station reference specifications detailed elsewhere herein.

The Contractor shall furnish the labor to remove and install all electrical wiring, conduits, relays, fuses, circuit breakers, knife switch disconnects, starters, timers, and any other electrical appurtenances required. The electrical schematic diagram and piping layout shall be submitted for Engineer’s approval.

The pumps shall be installed in compliance with the manufacturer's recommendations.

The pump shall be removable through the pump access hatch. Provide a means to guide the draw-down pump into place when the pump is lowered into the dry pit through the pump hatch. Submit details to the Engineer for approval prior to Installation.

Each installed pump shall be complete with an inlet stand assembly, including anchoring flanges and an integral port suction elbow and clean out port with removable cover, this shall be indicated on submitted drawings.

Each installed pump shall be installed on a steel base support of the pump manufacturer's design and recommendation, designed to straddle the pump inlet port area for access to the pump suction pipe.

The base shall be of adequate strength and rigidity to prevent harmful vibration or deflection of the pump piping from the forces involved in the application. Data submitted for approval shall include calculations supporting an included manufacturer's certification of the adequacy of the base design. The base may be a combination of a steel frame and concrete pad, as required to properly join the pump with the new and/or existing piping as approved by the Engineer.

After assembly and Installation on the foundation, the pumping units shall be leveled, aligned, wedged in place and grouted with a non-shrink grout. Grouting shall not take place until after the initial fitting and alignment.

The manufacturer shall inspect the pump Installation and shall certify that the pumps have been installed properly. Information submitted for approval shall include a letter of intent to provide this certification.

In addition, the services of a qualified representative of the manufacturer shall be provided to supervise the testing of the equipment, make any necessary adjustments, place it in initial trouble-free operation, and instruct the operating personnel in its operation and maintenance.

This work shall also include removing the discharge pipe and replacing it with an approved 16" discharge pipe at PS 14, coring of the wet pit concrete wall. Also installing a wall pipe leak seals shall be included as a part of the scope of work.

The Contractor shall coordinate Installation of the pump which includes Installation of the pump which includes the check valve, gate valve and appurtenances. Restoration of location to the original status is required before final acceptance.

Testing. After Installation of the pumping units and all accessory equipment, the units shall be subjected to running tests under actual operating conditions. The tests shall be made at the expense of the Contractor and conducted in the presence of the Engineer and the State of Illinois. The following items shall be specifically checked:

- The units are installed according to plans and specifications and the manufacturer's instructions.
- There is no pipe strain on the pump units.
- The units are properly aligned.
- Vibration limits are with Hydraulic Institute Standards.
- There is no over heating of bearings or other parts.
- The full load current is not exceeding the nameplate rating.
- The units are properly grouted and secured.

The tests shall include a timed pump run and a field capacity shock. If, in the judgment of the Engineer, pump performance, as measured in the field test, is not substantially true to published characteristics, modification, adjustment or replacement of the equipment shall be made to achieve specified performance results.

Due to the required continuous operation of the station the pumps may be installed and field tested progressively, as approved by the Engineer.

Clean-Up and Safety. The work site shall be maintained in a clean condition, free of hazards, all in conformance with the requirements of Article 107 of Standard Specifications. Special care shall be taken to assure that electrical systems are not left in an exposed or otherwise hazardous condition. All electrical boxes, cabinets, pole handholes, etc., which contain wiring either energized, or non-energized, shall be closed or shall have their covers in place and shall be locked when possible, during off-work hours.

Method of Measurement. Each side volute discharge pump and motor assembly that is removed and replaced with a dry pit submersible pump as specified herein and approved by the manufacturer and the Engineer shall be counted as a unit for payment.

Basis of Payment. This work shall be paid at the contract unit price each for PUMP REBUILD, TYPE 6, which shall be payment in full for the work described herein.

PS01 Pump, Scada Equipment, Furnish and Install

Description. The Contractor shall furnish, deliver, and install new SCADA equipment to replace the existing with required software and development. The existing equipment and devices shall be removed and relocated as directed by the engineer. This work shall be done at pump station 2, 4, 20, 21, 26, 27, 30, and 35. A different set of pump stations will be provided for next contract year.

When directed by the Engineer in writing, the Contractor shall furnish where indicated and applicable, all materials, equipment and labor, to perform work as specified and otherwise in accordance with specification. All materials and work not expressly specified but necessary for the proper completion in a neat, workmanlike manner shall be considered incidental and shall be included under this pay item.

The District has in place a Supervisory, Control And Data Acquisition (SCADA) system to remotely monitor, alarm and control its un-manned storm water pumping stations. These stations are to be considered critical systems that must remain operational at all times.

The SCADA system central equipment is in place, operational and several stations, as noted elsewhere herein, have been equipped with the required remote terminal units (RTU's) and interfacing transducer sets. The system has become part of the District's standard for storm water pumping stations, but not all stations have been equipped. Maintenance under this contract includes the prosecution of work to include additional stations in the system's coverage.

For compatibility with the District's existing system equipment, the Pump Station SCADA equipment shall be a RSView/Contrologix system, as programmed and configured for IDOT District One, as manufactured by Rockwell Automation. Information on the system and local service is available from:

Meade Electric Company Inc.
9550 W. 55th Street Suite A
McCook, IL 60525
Phone: (708) 588-2515
Fax: (708) 588-2501

Englewood Electrical Supply
41 N. Lively Boulevard
Elk Grove Village, IL. 60007
Phone: (847) 640-2500
Fax: (847) 640-2525

Contact: Scott Myers

Contact: Jeffrey P. Barrett

Other work, including various appurtenant items for the SCADA system, shall be performed by the Contractor. Including but not limited to the mounting of the SCADA equipment, the furnishing and installing of Software and Hardware and all interconnecting wiring between the SCADA equipment and these devices

Materials.

SCADA Equipment PLC

The Contractor shall furnish a Supervisory, Control And Data Acquisition (SCADA) PLC complete with programmable logic controller (PLC), ControlLogix processor A/B model 1756 L61 with 2 Mbytes memory, interface hardware, MMI, communication modems and programming as specified herein and indicated by the Engineer

All furnished equipment shall be UL listed and shall be appropriately labeled as such.

Equipment catalog information shall be submitted to the Engineer for approval (as specified elsewhere herein).

All panel wiring diagrams and programming shall be submitted and approved by the Engineer before the equipment is furnished.

All equipment shall be installed in the SCADA enclosure unless directed otherwise by the Engineer.

The PLC and Versaview 200R shall be mounted inside of the SCADA panel. Install 15" flat panel display in existing cut out. The MMI hardware shall be pre-programmed with the IDOT Universal RSView screen file and shall be configuration and developed for the pump station/location it is installed. The MMI shall come pre-wired for power and integration to the PLC, as per IDOT standard configuration. The enclosure door shall be reinforced to provide rigidity when a MMI key is pressed (no deflection shall be experienced when PLC keys are pressed). The controlLogix chassis

shall be mounted inside the SCADA panel, below the 15” monitor on the door. However a more suitable location inside the panel is acceptable.

All equipment furnished shall be wired, installed and interfaced to the PLC within the enclosure.

Pump Manual Lock-Out Button

The button shall be used for disconnecting all PLC pump controls when pressed in (Lock-out). However, the manual lock-out shall not alter the operation of other control systems. This button is round, red, mushroom push-pull type button with one pulled position contact (normally open) and two pushed positioned contacts (normally closed).

Alarm Light

The alarm light shall be lit by the PLC when an alarm condition is detected.

Manual Purge Button

The button shall activate the purge sequence on the SCADA system reactive air system when pushed.

Panel Power Supply System

The power supply system shall be capable of providing power to all equipment internal to the SCADA panel. The PLC, alarm light and reactive air system shall be powered by a self charging, automatic battery back-up system

I. Hardware for Each Pump Station

A) PLC/Computer Panel

- Panel Sized to Fit Hardware (12” H x 24” W estimated)
- Input 115VAC Circuit Breaker
- PLC Chassis
 - 4 Slot ControlLogix Chassis (1756-A4)
 - Power Supply (1756-PA72)
 - Logix Processor with 2MB Memory (1756-L61)
 - EtherNet Bridge Module (1756-ENBT)
 - Modbus Master/Slave Communication Interface Module (MVI56-MCM)
 - (1) Empty Slot Fillers (1756-N2)
- EtherNet Switch (Hirschman Spider 8TX)
 - 8 Port Unmanaged
- Industrial Computer – VersaView 200R (6155R-NPXP)
 - 1GHz Processor
 - 8GB Solid State Hard Drive
 - Windows XP Professional Operating System
 - (2) Serial Ports, (1) PS/2 Port, (1) Parallel Port, (2) Enet Ports, (1) VGA Port, (4) USB Ports

B) Flex I/O Bracket(s)

- Each racket Sized to Replace (1) Tesco Module
- “T2” Replacement Bracket
 - Power Supply (1794-PS123)
 - EtherNet Adapter Module (1794-AENT)
 - (1) Input Module – 32 Point, 24VDC (1794-IB32 with 1794-TB32 Base)
 - (2) Anlog Combination Modules – 4 Input, 2 Outputs (1794-IE4XOE2 with 1794-TB3 base)
 - Spare Terminal Blocks (used if some wires are not long enough to terminate directly on I/O module)
- “T21” Replacement Bracket
 - Power Supply (1794-PS13)
 - EthernNet Adapter module (1794-AENT)

- (2) Input Module – 32 Point, 24VDC (1794-IB32 with 1794-TB32 Base)
- (3) Analog Input Modules – 8 Inputs (1794-IE8 with 1794-TB3 Base)
- Spare Terminal Blocks (used if some wires are not long enough to terminate directly on I/O module)
- “T22” Replacement Bracket
 - Power Supply (1794-PS13)
 - Ethernet Adapter module (1794-AENT)
 - (2) Input Module – 32 Point, 24VDC (1794-IB32 with 1794-TB32 Base)
 - (3) Analog Input Modules – 8 Inputs (1794-IE8 with 1794-TB3 Base)
 - Spare Terminal Blocks (used if some wires are not long enough to terminate directly on I/O module)
- “T23” Replacement Bracket
 - Power Supply (1794-PS13)
 - Ethernet Adapter module (1794-AENT)
 - (2) Input Module – 32 Point, 24VDC (1794-IB32 with 1794-TB32 Base)
 - (3) Analog Input Modules – 8 Inputs (1794-IE8 with 1794-TB3 Base)
 - Spare Terminal Blocks (used if some wires are not long enough to terminate directly on I/O module)
- “TBD0” Replacement Bracket
 - Power Supply (1794-PS13)
 - Ethernet Adapter module (1794-AENT)
 - (4) Digital Contact Output Modules - 8 point (1794-OW8 with 1794-TB3 Base)
 - Spare Terminal Blocks (used if some wires are not long enough to terminate directly on I/O module)

C) Touchscreen Monitor

- Industrial Monitor – VersaView (6186-M15ALTR)
 - 15” Flat Panel Display
 - Resistive Touchscreen
 - 1024 x 768 Resolution

The contractor shall furnish all listed equipment, any equipment/device that is not installed shall become IDOT spare parts and stored in a location designated by the Engineer.

Man-Machine Interface (MMI)

The front of the SCADA panel shall be implemented with an industrial 15” Touch screen Monitor, A VersaView 200R (6155F-NPXP) shall be furnished and installed with the latest Pump Station SCADA RTU GUI application. This work shall include software configuration for communication to the PLC rack. The following software shall be furnished, configured, installed and interfaced with SCADA system: RSVIEW 32 Runtime with 300 tags, Windows 2000 or XP operating system, RSLinx communication driver and Microsoft Access data base. The equipment will be tested for proper performance during acceptance testing. The Contractor shall pay for any corrections required making the system fully operational. The contractor shall develop and install a universal RSView Screen file which shall be configured for each location based on the pump station equipment I/O.

Software installation and Screens Development

The pump station PLC application file and RSView Screen File shall be programmed and configured by the Contractor, to communicate, monitor, archive, control and alarm all I/O points in the existing pump station. The PLC shall be installed in the pump station and shall communicate over all communication media with remote processors at Schaumburg and the Contractor Dispatch Center. The PLC program shall include all set points related to software (internally and externally) triggered alarms. The Remote processors, Satellite and pump station HMI screens shall be identical such as the pump station information screen, control screen, main pump station screen and status screen are the same that will show all devices in the pump station properly controlled, monitored and archived.

Communication

The PLC data communicator shall be both a dialup telephone network and point multi-point radio system by furnishing and installing 56K external modem US Robotics part # USR 5686D, serial modem cable Belkin part # F2L088-06,

Ethernet hub NetWare part # DS10, Hirschman Spider 8TX shall be furnished and installed at pump stations with fibre optic connections.

Miscellaneous equipment

The contractor shall furnish and install in addition to the above equipment wire, wire-way, nameplates, fuses, circuit breaker 20 Amp 120/240V one (1) pole 10,000 AIC Cutler hammer QC1020, as required to make a complete and operational system.

All components shall be labeled with a rigid, two-color laminated, plastic nameplate indicating the enclosed contents. The lettering shall be engraved, at least one-half inch high, and highly contrast with its back-ground. The labels shall be permanently affixed to the cabinetry with stainless steel screws or rivets. All wiring shall be uniquely color coded with its color shown on the associated system documentation. A permanent tag affixed within three (3) inches of every termination shall indicate the function and placement of all connectors. All terminals shall be labeled and identified on the associated system documentation. The interior cabinet door housing the PLC shall have the procedures laminated and posted for replacing any processor equipment and replacing it with a rotating spare; downloading the PLC programs from the other system processors, interrogating the PLC to obtain specific levels of information in registers, and set points. The initial set points for alarms and controls shall be posted. Other abbreviated maintenance and user procedures shall be created, laminated, and posted in appropriate areas, as determined by the Engineer. Samples of all materials and the attachment procedures shall be submitted for approval/revision to the Engineer before Installation.

Documentation

SCADA System Operations and Maintenance Manual shall be modified to show the replaced equipment with new. A SCADA system operations and maintenance manual will be provided. This manual shall be have complete documentation of all equipment and software installed for an individual pumping station under these specifications. It shall serve as maintenance, trouble shooting and operations guide for the Electrical Maintenance Contractor who is responsible for maintaining the Departments pumping stations. . The manual shall include but not be limited to the following items:

Table of Contents

- SCADA system Description
- PLC operation, maintenance and programming Manual
- Set point table listing all programmable set point values
- PLC input/output designation table
- Telemetry, control and alarm message specifications
- List of materials supplied
- All supplied equipment catalog cuts
- Copies of all station labeling
- Full size wiring diagrams (as described herein)
- Cumulative storage curves and calculations
- back-up control operations and elevations
- PLC field replacement procedures

Three (4) copies of these manuals shall be furnished.

Diagrams

All circuit, system, wiring, block and interfacing diagrams shall be modified to show all new equipment and devices. The complete set of diagrams provided shall completely illustrate all wiring and equipment installed under these specifications including: termination points, equipment labeling, mounting and Installation dimensions and wiring. Seven four (4) copies of each of these diagrams shall be provided prior to the beginning of the final acceptance testing. Each diagram shall be stamped record drawing and shall reflect all final wiring and Installations. A minimum of the following diagrams shall be provided:

- PLC I/O wiring diagram (drawing)
- Pumping station network diagram that will show communication interface
- Telemetry panel diagram (control panel Drawing)
- A complete block diagrams of all telemetry and control equipment installed

Remote radio and phone line wiring and block diagram

PLC Programming Documentation

All PLC program documentation shall be furnished to the Engineer on a CD .

The PLC shall be used as the primary, secondary or tertiary control system as determined by the Engineer for the pumping station. As a control system in the pumping station, the PLC shall have the capabilities of controlling all pumping station operations including control of pumps, fans, vents, greasers, pneumatic air systems and emergency power supplies independent of all other control systems. The PLC program shall be internally stored within the PLC's non-volatile memory. It shall be a completely independent program, which will not require any communications with any other system processor for operations. The PLC shall include all I/O noted by the Engineer on the SCADA I/O checklist. Inputs and outputs shall be wired to their corresponding high states noted on the checklist. PLC software shall include all set points related to software (internally) triggered alarms. This list shall be included as part of the software submittal.

Local Control

The PLC shall operate the pumping station as a completely independent primary, secondary or tertiary control system. It shall operate on dynamic or step control pumping logic as determined by the Engineer. No communications with any of the other system processors shall be needed by the PLC for control and operation of the pumping station. Care shall be taken during SCADA panel Installation and equipment interfacing to ensure that the PLC is totally independent of all other control systems and no common failure point exists prior to the motor start contactor.

Primary Control

If the Engineer determines the PLC as the primary control system", the PLC shall be the governing control system for pumping station control and operations based on its own internally stored program.

Secondary or Tertiary Control

If the Engineer determines the PLC as the secondary or tertiary control system, the PLC shall be the back-up control system for pumping station control and operations. As a back-up" control system the PLC shall monitor primary, or if acting as the tertiary control system, primary and secondary control systems for failure. When failure of all other preceding control systems is detected, the PLC shall assume control of the pumping stations operations based on its own internally stored program. It shall be ensured that there is absolute isolation of the PLC's control circuits from all other control systems control circuits. Each control system shall operate independently of one another.

Dynamic Pump Control

If the Engineer determines the PLC shall operate on dynamic pump control logic, the PLC shall determine pumping requirements based on a calculated Control Curve and set pointed benchmark control elevations.

Control Curve Calculation

The PLC shall continuously construct and evaluate a wetpit depth verses time curve (Control Curve) as part of the dynamic pump control logic. The slope ratio of the Control Curve shall be based on the vertical axis being wetpit depth in feet and the horizontal axis being time in minutes. A slope ratio of 1:1 means the water has risen one (1) foot in the last minute. A ratio of 2:1 means the water has risen two (2) feet in the last minute. Control decision points shall occur: at set pointed benchmark elevations; when the slope of the control curve changes direction and maintains that direction for a set pointed time interval; when the slope significantly changes magnitude and stays within that range for a set pointed time interval; and when a set pointed time interval has expired since the last control command. The curve shall be calculated continuously by the PLC with averaging and/or filtering used to compensate for wave action and other discontinuities. The dynamic pump control logic presently being used on State pumping stations shall be incorporated on future dynamic control stations.

Step Pump Control

If the Engineer determines the PLC shall operate on step pump control logic, the PLC shall determine pumping requirements based on set pointed benchmark control elevations. The number of set pointed benchmark control elevations needed will be specified by the Engineer.

While the pumping station PLC acts independently on a real-time basis, all system processors shall be capable of establishing a communications link between it and any system PLC. Once a communications link is established, the system processor will have the capability of remotely controlling and monitoring the PLC it has a communication link established to. Remote control and monitoring of the PLC shall include, but not be excluded to, controlling of pumps, changing of set pointed values, downloading/uploading of PLC programming and monitoring current pumping station operations.

If during remote testing the elevation in the wetpit reaches the all pumps stop elevation, the PLC will turn off the operating pumps.

The PLC shall have remote uploading and downloading capabilities. Any system processor shall have the capability of remotely loading programming to the PLC via telephone, radio or PLC maintenance port.

This shall include provisions so that when a PLC fails, a spare unit can be installed and the individualized PLC programming for that particular pumping station can be downloaded from any system processor via telephone line and radio communications. Remotely uploading all programming from the PLC to any of the system processors in the same manner as the downloading procedure.

Alarms

Any change of PLC digital input, digital output or register status (externally imputed or internally calculated) shall be considered an alarm and/or alarm conditions as herein these specifications. All alarms shall be sent to the central processor by the PLC.

The PLC shall receive pumping station status information from all of the telemetry and control equipment interfaced to it. The processor shall constantly scan the input information and determine (based on its internally stored software logic) if the station has an alarm condition. When an alarm condition is detected the associated processors shall be called and advised using the remote radio or dial-up telephone network (if failure of the remote radio is detected by the PLC). When the alarm condition ceases, an additional notification shall be made by the PLC. The PLC shall be configured in accordance with and as directed by the Engineer. The PLC shall operate the common alarm light (as specified elsewhere herein) based upon alarm conditions detected by its internal programming. All PLC alarms shall be capable of being acknowledged by the alarm acknowledgment button (as specified elsewhere herein).

All alarm conditions generated by the PLC and I/O changes in state shall be received by the central computer via polling. The SCADA system is a poll only system and no I/O changes in state shall trigger any report by exception telemetry. When an alarm condition is corrected, the corresponding message will be sent to the central processor the next time the pump station is polled. All data sent/received by the pump station shall be the same format. All communications shall be routed to the designated processor using radio system and/or dial-up telephone network facilities located at each facility. Radio shall be the telecommunications media of choice. A failure to contact a processor by radio shall imitate a call by dial-up telephone network. When a telecommunications media fails, the PLC shall send an alarm on the other available media indicating the failure. The PLC shall automatically re-send the initial alarm if the associated condition has not been corrected within a set point time interval beginning from the time the alarm condition was detected. In the event of failure to establish a useable telecommunications radio pathway the PLC will retry calling each processor a set pointed number of times after which, if failure still occurs, the PLC shall then call by telephone. It shall be ensured that any change of the PLC's digital input, digital output or register status (externally inputted or internally calculated) is sent to the receiver by the central processor.

Programming in the PLC shall be non-volatile. Volatile memory using lithium battery back-up shall be permitted. Permanently embedded programming shall be held in PROM chips. Operational and control programming subject to revision shall have battery back-up sufficient to sustain memory for a minimum of five (5) years without external power.

As the timing and power parameters inherent in a pumping station conflict with those typical of a microprocessor all necessary buffering, filtering, surge protection and time delays shall be incorporated in the hardware and programming of the PLC.

Central and Engineering Processor Programs. The SCADA system consists of three (3) central processors (IDOT Schaumburg, IDOT electrical maintenance office and EMC) and six (6) engineering processors.

Each processor in the system shall be configured, by the Contractor, to communicate, monitor, archive all I/O points, control and alarm each additional PLC installed in a pumping station over all communication media.

Software revisions or modifications required to integrate additional PLC's into the existing processor shall be provided by the Contractor. Processor functionality and integrity shall be maintained with each added PLC.

All mounting apparatuses necessary to rigidly mount the SCADA panel. Conduits, wiring and fittings as required for a complete operational system is included in this pay item.

All equipment furnished and installed under this item shall be appropriately identified with nameplates as specified under Basic Materials and Methods, elsewhere herein.

Removal and Installation. The Engineer shall designate the Pumping Station to facilitate the removal and installation of SCADA PLC. No splicing.

The Contractor shall maintain the operation of the pumping station. All operations shall be subject to approval of the engineer.

The Contractor shall protect adjacent material, equipment and areas during process of removal and replacement of SCADA panel operations from all dirt, dust, debris or damage of any kind.

The SCADA equipment shall be rigidly mounted with an Engineer-approved mounting means. The Flex I/O shall be installed on a Custom Bracket design as approved by the engineer.

All software shall be configured, installed and interfaced with existing SCADA system at the pumping station and at both central and satellite location to provide a complete and operational system

All equipment furnished, installed or mounted for this pay item shall conform to the NEC and applicable specifications for Basic Materials and Methods, elsewhere herein.

The Contractor shall submit catalog cuts, design drawings and product data for the Engineers approval prior to installation including all software as specified elsewhere herein. Three complete sets of record drawings, catalog cuts and O&M manuals shall be provided upon completion for Engineers approval.

All equipment needed and recommended by the manufacturer to ensure system warranty shall be furnished, including miscellaneous mounting apparatuses.

Startup / Training (on-site)

A minimum of eight hours of on site support shall be included for each pump station for start-up and training.

Method of Measurement. Each furnished and installed SCADA EQUIPMENT and removal of existing SCADA PLC with associated devices as specified above and approved by the Engineer shall be counted as a unit for payment

Basis of Payment. This work shall be paid at the Contract unit prices each for PS01 PUMP, SCADA EQUIPMENT, FURNISH AND INSTALL Which shall be payment in full for the work as described herein.

PS02 Pump, Vibration Testing and Analysis

Description. The Contractor shall provide a Vibration and Analysis Testing Consultant who is a data analyst with a minimum of two years experience in vibration data collection and spectrum analysis, and shall have a Level II certification by a vibration institute or equivalent.

The Consultant shall conduct the testing and start-up on all the pumps and including new and/or rebuild. The Consultant shall provide recommendations for pump motor inspection, balancing, repair or replacement of pumps and motors, maintenance and troubleshooting of all associated equipment. A strobe tachometer should also be used to verify motor speed.

The Contractor shall provide the Consultant with records of the type of pump, head design, manufacturer's performance curve, moisture resistance and megger test results and other pertinent data to the pump operation prior to start up of the above inspections and testing.

The Contractor shall conduct the first vibration test with the capacity test.

The Consultant shall be equipped with required tools, transportation, equipment, instrumentation and supplies to perform the Pump Vibration and Analysis Testing Inspection.

The Vibration and Analysis Testing Consultant shall perform vibration analysis on all pumps, utilizing a Smart Meter Plus, Model 1330F or better which will include a copy of the associated software for IDOT and the electrical maintenance contractor use for the duration of the contract. The Electrical Maintenance Contractor shall calibrate and maintain the IDOT vibration meter including all software and accessories. The first Testing shall be conducted at the same time as the Yearly Pump Station Inspection and Pump Capacity Test. The 2nd Testing shall be due November 30 of each contract year. All results shall be entered into the Log Book for each station, in Chart Z. Each inspection report shall be entered into the EMCMS System. Any deficiencies found on this inspection shall have appropriate EMCMS Tickets issued, and the numbers shall appear on the inspection report, Form P-5. A start-up testing on the Pump repair/replacement work shall be scheduled by the Consultant following completion of any necessary repair/replacement work.

The Consultant shall provide testing, analysis, database development, baseline data acquisition and problem identification and reporting, for all the pumping station equipment.

Full vibration signatures shall be acquired for all mechanical equipment included in the program. the baseline data is to be analyzed to determine baseline condition of all equipment. The analysis will result in a series of reports that:(1) identify specific problems, (2) provide specific corrective actions, and (3) establish a priority (based on the problem severity) for maintenance actions.

Monitoring and analysis of the operating condition of the pumps is an absolute requirement of the predictive maintenance program. Therefore, all pumps will be monitored twice per year, additional tests are required for the pumps that indicate potential problems.

Problem Identification and Reporting:

A report will be prepared each month that defines specific maintenance tasks that are required to correct incipient problems identified by the monthly data acquisition and analysis program. These reports will be submitted within five (5) working days following completion of the data acquisition. The format of the report should be designed to reduce the amount of paper work necessary to properly maintain accurate communication between the Consultant and IDOT. Each report is to provide a prioritized list of specific maintenance or inspection tasks that are required to verify or correct developing problems.

The Consultant shall notify IDOT and the Electrical Maintenance Contractor immediately when any deficiency is noted that could jeopardize equipment operation or personnel safety. Written reports will address all monitoring points, but will place a priority on "exception" reports describing problems that have been identified including a detailed evaluation of pump status and recommended maintenance actions.

- a. Tests must be conducted with a flooded suction so not to cause vortexing or cavitation. For data history purpose each test should be conducted with about the same amount of pump submergence as the previous test for that pump. The Electrical Maintenance Contractor shall store or provide water in order to conduct the proper test in accordance with normal operation of the pumps. Two vibration readings shall be taken at the thrust end of the motor (one should be parallel to the discharge pipe and one perpendicular to the discharge pipe), and two readings shall be taken at the coupling end of the motor and should be in the same plane. Finally an axial reading should be taken. The transducer location shall be marked with different colors which will correspond to x and y-axis.
- b. The results of the tests shall be saved on intelli-cards or 3.5 inch floppy showing the velocity in inches per second (ips). In the event that the vibration exceeds 0.3 ips the Engineer may require that the motor be uncoupled from the pump and another test be conducted. Where motor speed is below 1000 RPM, the 0.3 ips velocity "evaluation point" shall be decreased by 10% for each 100 RPM below one-thousand. The worst case reading shall be assumed to be the "true" reading.
- c. Readings shall be considered "abnormal" when the vibration exceeds 0.3 ips. The test card data shall be entered into the EMCMS System for each station, no later than 48 hours after the completion of the inspection of each station, with the entire inspection report and test cards to be received by the Engineer by June 30th and November 30th of each contract year. Note the location axis of the transducer, the pump manufacturer, model number and serial number of the associated pumps must be specified for each station. Any deficiencies found on this inspection shall have appropriate Tickets issued, and the numbers shall appear on the inspection report, Form P-5.

Coordination with PS Specialist

The Vibration and Analysis Testing Consultant shall coordinate with the PS Specialist Consultant on all findings and results to develop an overall condition of the equipment.

Method of Measurement. This work shall be measured and paid on the basis of each pump tested in a pump station and analysis of results and reports delivered, as well as all labor costs, travel expenses, miscellaneous expenses, as specified in this pay item for each pumping station inspected.

Basis of Payment. This item shall be paid at the contract unit price each for PUMP, VIBRATION TESTING AND ANALYSIS of a pump that shall be payment in full for the work described herein.

PSR1 Roof, Remove and Replace

Description. The Contractor shall provide the personnel, material and equipment to replace existing roofs at pump stations 27 and 35. This removal and replacement shall include the disposal of, but is not limited to built-up roofing, roof hatch covers, metal fascia, sheet metal, exhaust fans, louvers, and insulation. The Contractor shall provide an approved submittal for roof replacement by March 1, 2009 and shall start work by June 1, 2009. The work shall be completed by September 15, 2009.

Scope of Work. The contractor shall provide labor, equipment and material as specified for demolition, roofing removal and replacement including sheet metal work removal and replacement. All flat roof installation shall be sloped 1/8 inch per foot towards the drains or gutters.

Fill concrete surface honeycomb and variations with latex filler. Assure the concrete deck is clean and smooth, free of depressions, waves, or projections, and properly sloped to drains. Assure concrete surface is dry and free of debris.

The extent and location of the demolition works shall be as specified herein. The Contractor shall become familiar with the quantity and character of all materials to be demolished and removed, prior to the start of work. The work

includes the requirements for the removal, wholly or in part, and satisfactory disposal of all materials, off of the IDOT site. All demolished materials shall become the property of the Contractor.

It is important to note that the facilities shall remain in operation during the work and, therefore, the pump station equipment shall be protected from dirt, dust, debris or damage of any kind. Materials that are damaged by the contractor due to his operations shall be replaced at no additional cost to the state.

At the completion of construction, all surfaces, including interior and exterior concrete and masonry, shall be cleaned of all dirt and dust.

ROOFING

1. General:

This Section shall include all work required for the furnishing and installing all roofing and appurtenances as indicated on the Drawings and as specified herein.

Only a qualified roofing-contracting firm shall install Work, which has been in business for not less than five years. Evidence of compliance with this requirement shall be submitted for approval.

The work shall include all roofing appurtenant work such as flashing and trim work as specified herein.

It is important to note that the facility shall remain in operation during the work and therefore the pump station equipment shall be protected from damage. The pump station shall be protected from all weather including rain by temporary means, as approved by the Engineer as the roofing work is accomplished. The roofing work shall be sequenced so as to minimize the need for temporary protection.

Submittal:

The Contractor shall submit general roof plan showing tapered insulation plan, which includes all valleys, ridges, slopes, saddles and crickets, and general drainage pattern based on tapered insulation. The Contractor shall also submit shop drawings detailing base flashings, roof edge termination flashings, reglets, membrane terminations, roof drains, roof projection flashings, roof hatch flashings.

1.1 Warrantee:

Provide 20-year warranty, Warranty shall be in writing and shall include the data specified herein.

Manufacturer's warranty for all materials, the compliance of such materials with the Specifications shall be submitted. The Contractor shall provide certification that all workmanship complied with the requirements of the Specifications and of the manufacturer. Statement of all limitations, required maintenance, and similar conditions of the warranty. The State will not be bound to accept any limitations that were not filed with request for approval of material.

Warranty shall be included with material information submitted for approval.

1.2 Roofing Deck Preparation

The existing roofing, cants, nailers, coping, gravel stop, flashing and associated appurtenances shall be removed as specified herein. The work includes the requirements for removal, wholly or in part and satisfactory disposal of all materials except materials approved by the engineer may be reused in the work.

The contractor shall become familiar with the quantity and character of all materials to be removed. The Contractor agrees that the premises were made available prior to deadline for submission of Bids for whatever inspection and tests the Contractor deemed appropriate. The Contractor assumes full responsibility for the proper disposal of all demolition materials.

Deck and curb surfaces to receive new roofing and flashing shall be properly prepared, thoroughly dry, smooth, clean, and free from projections above or depressions in the surfaces covered. Correct any defects considered detrimental to the installation of the work. Applications of the work included herein will be considered as an unqualified acceptance of the surfaces as constructed. If defective work is covered, both removal and replacement of the work shall be done at no additional cost to the State.

All cracks, holes, voids, and open areas shall be wetted with clean water and carefully filled with Portland Cement Mortar, struck flush and permitted to dry before new roofing work is started.

Debris resulting from removal work shall be cleaned up daily.

1.3 Roofing Materials and Appurtenances:

Roofing system shall consist of 60mil thick, black, non-reinforced EPDM membrane system, mechanically fastened to the roof deck every 2 square feet and all in accordance with the approved manufacturer's standard specifications and instructions. Roofing shall be as produced by on of the following manufacturers:

1. Sure-Seal Design "A" Adhered Roofing System by
Carlisle Syntec Systems
Carlisle, Pennsylvania
2. Manville SPM Single Ply Roof System
Manville Roofing System Division
Denver, Colorado
3. Firestone Rubber Gard Roofing System
Firestone Building Products Company
Carmel, Indiana
4. Genflex Roofing Systems
GenCorp Polymer Products
Maumee, Ohio

This specification is based upon products as manufactured by Carlisle. Equal Products of the specified manufacturers will be acceptable, subject to compliance with approved manufacturer's the Specification requirements.

An acceptable ½" thick board mechanically fastened to the concrete roof deck every 2 square feet and the SPDM membrane is fully adhered to the board with 90-8-30A Bonding Adhesive.

Board shall be ½" thick Sure-Seal HP Recovery Board or approved equal.

Fastener types will be determined by job conditions and the concrete roof to meet FM requirements. The use of Sure-Seal fasteners is required. The performance or integrity of products by others is not covered by the Carlisle warranty. Refer to manufacturer specifications for acceptable fasteners and the corresponding deck type.

Walkway pads shall be 12" X 24" X ½" performed homogenous, non-laminated, skid-resistant asphalt plank equal to J-walk as manufactured by Manville and planks shall be adhered to roof membrane with a bonding adhesive as recommended by roof membrane manufacturers.

One-way roof vents shall be molded black-pigmented ABS plastic resin body, with integral deck flange, weatherproof cap and silicon one-way diaphragm equals FP – 10 One Way Roof Vent and manufactured by Manville. Install one vent per 250 square foot of roof area, unless otherwise recommended by roofing manufacturer, for venting to permit construction below roof membrane to breath without moisture reentry through vent.

Other materials shall be as recommended by roof membrane manufacturers and shall include, but not be limited to, the following:

1. Cleaners
2. Cement, sealants, and adhesives
3. Flashing
4. Strips
5. Plates
6. Sealers
7. Clamping ring drains

1.4 Execution

The installations of the roof membrane system shall be in accordance with the manufacturers standard specifications, FM requirements, and as follows:

Ensure that water does not flow beneath any completed sections of the membrane system. This will include completion of all flashings, terminations and daily seals. It is recommended to begin the installation at the highest point of the project area and work to the lowest point to prevent water infiltration.

Execute work so the completed splices and seals will not buck water. Daily seals are completed with Nite-Seal and Lay Flat Tubing.

Position sure – Seal .060 inch thick non-reinforced EPDM membrane over the acceptable substrate without stretching.

Allow membrane to relax approximately one-half hour prior to bonding.

Fold sheet back 5 feet so that half of the underside of the sheet is used. Sheet fold shall be smooth without wrinkles or buckles.

Stir bonding adhesive and apply evenly without globs or puddles. Roll the adhesive with a 9-inch-wide plastic core short nap paint roller to both the sheet and the substrate to achieve 100% coating of both surfaces at a coverage rate of approximately 60 square feet per gallon on completed adhered sections.

Allow adhesive to dry until it is tacky by will not string or stick to a dry finger touch.

Roll the coated membrane into the coated substrate while avoiding wrinkles.

Brush down the bonded half of the sheet, immediately after rolling the sheet into the adhesive, with a soft bristle push broom to achieve maximum contact.

Fold back the unbonded half of the sheet and repeat the bonding procedure.

Install adjoining sheets in the same manner, lapping edges a minimum of 3 inches.

Additional membrane attachment is as follows:

Securement shall be provided at the perimeter of roof section, curb flashing, skylight, etc., at any inside angle changes where slope or combined slopes exceed 2 inches in one horizontal foot, and at other penetrations in accordance with Carlisle's details.

Securement shall be as follows:

Rubber Fastening Strips (RFS) shall be mechanically fastened into the structural substrate, as shown on Carlisle's standard details, with an accepted fastener. Refer to attachment to manufacturer's specifications.

Flashing: Shall be stainless steel: ASTM A240, Type 304, 20 gauge, architectural grade alloy, finish to be 2B. Fastener shall be same material as the flashing metal with soft neoprene washer at exposed fasteners.

1.5 Installation

All roofing work shall be done in dry weather in temperature not lower than 35 degrees F.

Verify roof openings, pipes, or vents through roof are solidly set , nailing strips located, roofing termination and base flashing is in place, sealed, and secure.

The work shall be coordinated for use of the existing roof drains and coordinated with any curbs. Membrane roofing shall be carried over curbs and flashing.

Install one-way roof vents according to roofing manufacturer's recommendations and include work to cutting down to the top of the insulation to ensure ability of the moisture to breath through the vents.

Flashing and all other connection of roofing with other work shall be completed with application of roof membrane system. Fit flashing tight in place. Make corners square, surface true and straight in planes, and lines accurate to profile. Seal metal joint water tight.

Coordinate work with sheet metal work.

Bed all metal flashings, gravel stops, and similar items as recommended by roofing manufacturer and as approved by the Engineer.

Weather tightness, roofing and base flashing shall be weather tight and water tight.

Avoid defacement of any other work and material.

1.6 Cleanup

The contractor shall exercise care to avoid defacing any part of the structure with drippings and he will be held entirely responsible for cleaning any such spots, should they occur, to the complete satisfaction of the Engineer or his representative.

SHEET METAL WORK

1. General

This section shall include all work required for removal of existing, furnishing and installing all new sheet metal work as indicated on the Drawings and as specified herein.

Quality Assurance:

Fabricator: A firm which has not less than 3 years of successful experience in the fabrication of sheet metal for roofing applications.

Installers shall be workmen thoroughly trained and experienced in the installation of sheet metal used for roofing applications.

1.2 Material

Aluminum fascia plus aluminum extensions shall be equivalent to Snap-Lox Fascia II 'Low – Pro' as manufactured by MM Systems Corporation, Tucker, Georgia. Units shall be extruded aluminum of 6063-T5 aluminum alloy. Furnish and install all accessories including but not limited to, fastening hardware, shop-mitered corners and all other accessories as required. Finish shall be clear anodize.

Bituminous Paint: ASTM D1187, Type A.

Fasteners and Other Accessories: Manufacturers' recommended product for rivets, bolts, and nuts, screws, nails, anchors, spikes, and ferrules.

For use with copper based metal: Bronze, brass, or copper.

For use with all other metals: stainless steel.

Do not use ferrule shells.

Nailing Strips: Wood, pressure treated in accordance with AWPA Standard LP 22.

1.3 Fabrication:

General:

Fabricate all sheet metal items in maximum lengths practicable, and with no unnecessary joint. Fabricate in a manner to produce sharp and true line, rises and angles. Machines fit and connect joints and corners, and match components to produce continuity of line and design. Hem all exposed edges ½ inch. Conceal reinforcement within the finished assembly and conceal fastenings, except as otherwise indicated. Rivet all soldered seams and connections. Fascia sections shall be fabricated in ten-foot lengths or multiples thereof, with filler pieces of other length only as required.

Protect aluminum in contact with other metals, other than stainless steel, from electrolytic action with bituminous paint. Coat concealed metal surfaces that will be in contact with roofing materials with bituminous paint.

Clean and tin non-ferrous metals prior to soldering. Make soldering on finish surfaces full flowing and smooth. Remove acid flux on surfaces by washing with a soda solution after soldering.

Expansion and Contraction: Form and fabricate sheet metal in a manner which will allow for thermal expansion and contraction and structure movement. Make lock seams work flat, true to line, and full of solder except where installed to permit expansion and contraction. Lap flat lock seams, and lap seams where soldered, according to pitch but in no case less than three inches; make laps in direction of flow. Make sheet metal work weather tight throughout.

1.4 Preparation:

Examine surfaces to receive sheet metal work for defects that would adversely affect the installation.

Do not commence installation until defective surfaces have been corrected.

1.5 Installation:

Procedures and methods of installation shall be in accordance with this Section and with the applicable details and methods shown and described in the Sheet Metal and Air Conditioning Contractors National Association, Inc.'s Architectural Sheet Metal Manual known as the SMACNA Manual.

Coordinate the installation of flashing and sheet metal work with the work of other trades. Do all cutting, fitting, and drilling and other operations in connections with sheet metal work to accommodate the work of other trades.

Provide all necessary accessories, incidentals, and other items essential to properly complete the sheet metal installation.

Erect all sheet metal work to perform satisfactorily in a manner which will allow for thermal expansion and contraction and structural movement; and in a manner which will not over-stress the sheet metal, break connections, or produce wrinkles and distortions in finished surfaces. Where sheet metal abuts or protrudes into adjacent materials, execute the juncture in a manner to provide weather tight construction.

Isolate contracting dissimilar metals from electrolytic action with bituminous paint, which shall not be visible after the products have been installed.

All equipment furnished, installed or mounted for this pay item shall conform to the applicable specifications for Basic Materials and Methods, elsewhere herein. The Contractor shall provide all submittals as specified above in this pay item including catalog cuts, design drawings and product data sheets for the Engineers approval prior to installation. Three complete sets of record drawings, catalog cuts and O&M manuals shall be provided upon completion for Engineers approval

Method of Measurement. The square foot area specified herein, for roof, removed and replaced, inspected and approved by the Engineer, shall be counted as a unit for payment.

Basis of Payment. This work shall be paid at the Contract unit price square feet for ROOF, REMOVE AND REPLACE, which shall be payment in full for the work described herein.

PV01–PV03 Vendor Budgetary Allowance

Description. This item is to establish a budget account to allocate funds for the payment of various types of repair services including replacement pumps, appurtenances, and miscellaneous system equipment required for the ongoing pump station system maintenance program but which are not accurately or completely identifiable at the time of bidding. When mentioned herein, Article 109.05 is modified whereas the Contractor shall be paid an administrative costs of an amount equal to five (5) percent of the first \$10,000, and the Department shall allow an additional one (1) percent of any amount over \$10,000 of the total approved costs, on an individual work authorization.

Following is detailed information concerning each major category of work, which requires the allocation of funds for certain expenses:

1. Pump Repair Services

The annual pump rebuilding program involves many repairs for which the costs cannot be estimated or determined until the pumps are removed from operation and disassembled for examination. Most pump repairs cannot be performed by the General contractor's forces, and it is therefore necessary to have various service and/or pump manufacturing companies perform the necessary specialty service work. Specifically, the work consists of the repair of pump bowl assemblies, discharge column repairs, shafting and oil tube assembly overhaul, and other miscellaneous services.

The Engineer will evaluate the specialty service quotations and authorize work accordingly. The total estimated amount of the annual expenses incurred for the services performed by others, which will be paid under Article 109.05 of the Standard Specifications as herein modified in Article 5.0, is \$100,000.00 as indicated for Pay Item PV01. For bidding purposes, this amount shall be used.

2. Pump Bowl Replacement

The annual pump rebuilding program involves the necessity to replace certain major parts of the pump assembly called the pump suction bowl. Until the pumps are removed from operation, it is not known whether pumps suction bowl will need to be replaced with a completely new unit. When it becomes known, after disassembly of the pump that the pump bowl cannot be repaired, the Contractor is directed by the Engineer to obtain quotations for a new replacement unit.

The Engineer will evaluate the specialty service quotations and authorize work accordingly. The total estimated amount of the annual expenses for the purchase of replacement bowl assemblies, which will be paid under Article 109.05 of the Standard Specifications, and as herein modified in Article 5.0, is \$150,000.00 as indicated for Pay Item PV02. For bidding purposes, this amount shall be used.

3. Complete Pump Replacement

The annual pump rebuilding program involves the need to replace complete pump assemblies at certain pump stations because of the extent of their deteriorated conditions found at the time of removal. For these cases, the Contractor must obtain quotations for direct replacements from the same manufacturer and also sometimes from other pump manufacturers.

The Engineer will evaluate the quotations and authorize procurement accordingly. The total estimated amount of the annual expenses for the purchase of complete pump assemblies, which will be paid under Article 109.05 of the Standard Specifications and as herein modified in Article 5.0, is \$150,000.00 as indicated for Pay Item PV03. For bidding purposes, this amount shall be used.

PW01 Wet Pit, Cleaning

Description. This item shall include the removal of all debris from the designated pump station wet pit as described herein.

Work Description. The method by which the debris is removed from the wet pit shall include any traffic control, safety, transportation, and vacuum equipment and shall require the approval of the Engineer.

All removed material shall be disposed of outside the State right-of-way and in accordance with the local EPA rules and regulations.

Areas outside the bar screen(s)/trash rack(s) up to the inlet sewer shall be cleaned at the same time in accordance with Article 8.

Method of Measurement. Each square yard area of wet pit silt material that is cleaned and all refuse disposed of in accordance with the above specifications and approved by the Engineer shall be counted as a unit for payment.

Basis of Payment. This item shall be paid at the contract unit price per square yard for WET PIT, CLEANING, which shall be payment in full for the work described herein.

PW02 Wet Pit, Power Wash

Description. This item shall consist of providing all labor, material, and equipment to power wash and clean IDOT pumping station wet pits, walls, floors, beams, grating, railings, piping, ladders, and stairs. This work will be authorized in conjunction with pumping station wet pit cleaning paid under a separate pay item elsewhere herein.

Equipment. 10,000 PSI water blaster

Method of Measurement. Each power wash hour as approved by the Engineer shall be counted as a unit for payment.

Basis of Payment. This work shall be paid at the contract unit price for each hour of WET PIT, POWER WASH, which shall be payment in full for the work described herein.

PUMPING STATIONS - Referenced Specifications

Equipment specified herein is intended for application at Pump Station Installations, either for use as part of routine repairs and replacement or as part of non-routine work, including specific separately paid work such as low flow pump Installations. Although not repeated here; specifications for other items, such as rigid steel conduit, shall apply equally here.

1. Safety Switches

Safety switches shall be heavy-duty type, UL listed as suitable for use as service entrance equipment and shall be in conformance with NEMA Standard KSI-1983 for type HD and with Federal Specification W-S-865c for heavy duty switches. Switches used as service entrance equipment shall have a factory-installed solid neutral and other switch shall have a factory-installed grounding kit unless otherwise indicated.

The switches shall have a quick-make, quick-break mechanism, full cover interlock to prevent opening the cover with the switch in the closed position and a position-indicating operating handle. The operating handle shall be well insulated from the current carrying parts of the switch.

Unless otherwise indicated, switches shall be rated 600 volts, and when used with UL listed Class R fuses, shall have a UL listed short circuit withstand rating of 200,000 RMS symmetrical amperes.

Unless otherwise indicated, safety switches shall be un-fused. Where fused switches are indicated, they shall be provided complete with US Class K-5 current limiting fuses.

Unless otherwise indicated, safety switches installed below grade or exposed to the weather shall have NEMA 4 stainless steel enclosures. Safety switches installed indoors above grade shall have NEMA 12 enclosures. Safety switches in explosion-proof hazardous locations shall be in enclosures suitable for the location.

2. Transformers

Unless otherwise indicated, transformers shall be General purpose dry type, 2-winding of the capacities and voltage indicated.

Transformers 15 KVA and below shall be indoor/outdoor type and those above 15 KVA shall be indoor type unless otherwise indicated.

Unless otherwise indicated, transformers 3 KVA and above shall have not less than four 2-1% taps in the high voltage winding, two above and two below rated primary volts.

Transformers shall be UL listed and shall meet all applicable NEMA, ANSI, UL, and IEEE Standards. Unless otherwise indicated, transformers shall have 220 degrees C Class insulation but shall be designed for a maximum temperature rise of 115 degrees C, over an ambient temperature of 40 degrees C.

3. Manual Motor Starter Switches

Manual motor starter switches shall be complete with melting alloy type thermal overload protection, which shall be trip-free and resettable. The exact size of the overload element shall be coordinated for the specific respective motor.

The switches shall be rated not less than one horsepower at 115 and 230 volts single phase. The switches shall be single poles unless otherwise indicated.

Where indicated, the switches shall be equipped with a pilot light and/or a hand-off-automatic selector switch.

Unless otherwise indicated, the manual motor starter switches shall be equipped with NEMA 4 cast enclosure. Switches, which are flush mounted, shall be mounted with the flush box and shall have a suitable flush-mount plate.

4. Circuit Breakers

This specification shall apply to all circuit breakers furnished under this Division which are not integral to panelboards or motor control center equipment.

Circuit breakers shall be UL listed, molded case, thermal-magnetic, manually operated circuit breakers of the trip ratings shown or indicated.

Unless otherwise indicated, circuit breakers shall be 3-pole.

Unless otherwise indicated, circuit breakers shall be rated for use on 480 volt circuits.

Multi-pole circuit breakers shall have a common trip and single operating handles. Handles shall be trip free. Circuit breakers in 250 ampere frames and above shall have an adjustable magnetic trip setting.

The circuit breakers shall indicate "ON", "OFF", and "TRIPPED" conditions.

Unless otherwise indicated, circuit breakers shall have a UL listed interrupting rating of not less than 25,000 RMS symmetrical amperes at 480 volts.

Unless otherwise indicated, circuit breakers installed below grade or exposed to the weather shall have NEMA 4 stainless steel enclosures and circuit breakers installed indoors above grade shall have NEMA 12 enclosures. All circuit breakers shall have external position-indicating operating lever handles with padlock provisions.

Where indicated or where required for indicated functions, circuit breakers shall be equipped with accessories such as shunt trips, auxiliary switches, and under voltage release.

5. Motor Starters

This specification shall apply to all motor starters, which are provided under this Division.

Unless otherwise indicated, motor starters shall be of the combination type with integral motor circuit short circuit protection mounted in a common enclosure with the starter and control components for control of circuit as indicated. Unless otherwise indicated, motor circuit short circuit protection shall be motor circuit protectors. Motor circuit protectors shall be manually operated and shall have a magnetic trip level adjustment. Trip ratings shown on the Drawings are approximate and the trip rating provided shall be as recommended by the device manufacturer for the characteristics of each respective motor. The Contractor shall coordinate device selection with motors provided under other Divisions.

Motor starters shall not be smaller than NEMA Size 1.

As a minimum, each starter shall be equipped with two normally open (NO) auxiliary contacts in addition to a starter seal-in (holding) contact. Unused contacts shall be spare.

Unless otherwise indicated, control circuits shall operate at 120 volts derived from a control transformer integral to the combination starter. The control transformer shall have a fused secondary and shall be sized adequately for the starter and all connected control devices but in no case shall the transformer be sized less than 50 volt-amperes over the capacity required to operate the starter.

6. Control Devices

Control devices shall be provided as part of motor starters, and also for control stations remote from motor starters and as otherwise indicated.

Unless otherwise specifically indicated, push buttons, selector switches, indicating lights and other control devices shall be of the heavy duty oil tight type.

Contact blocks for push buttons and selector switches shall have not less than one double pole double throw (DPDT) contact.

Indicating lights shall have built-in transformers, 6-volt miniature bayonet base incandescent lamps and lenses of the colors indicated. Unless otherwise indicated, indicating lights shall be push-to-test type.

Legend plates shall be provided on all oil tight control devices. Unless otherwise indicated, green indicating lights shall have "RUNNING" legend plates and legend plates for other indicating lights shall be as indicated or as selected by the Engineer.

Unless otherwise indicated, enclosures for control stations (control devices which are remote from motor starters or other equipment) which are located below grade or exposed to the weather shall be NEMA 4 stainless steel and enclosures for control stations located indoors above grade shall be NEMA 12.

7. Float Control System

The float control system shall include floats, interconnecting integral cable of a length required, and control logic for the functions indicated. Except as otherwise indicated, float control systems shall conform to the specifications elsewhere herein for float switch Installation.

Floats shall consist of sealed mercury switches sealed in stainless steel spherical floats, with integral neoprene jacketed cable.

The system shall be intrinsically safe for Installation in the wet well.

The system shall be complete with control logic to produce the contact control and alarm functions indicated or furnished by the Engineer.

Float control systems furnished as part of separately-paid float pumps shall be equipped with 2 control points via individual floats.

The system shall be complete with all required mounting hardware and accessories.

The float system shall be complete with mounting arrangement with a stilling well of adequate size, or by other means approved by the Engineer, to forestall the attachment of large sections of ice to the floats during cold weather which could then disturb the system mounting. The mounting arrangement shall permit easy removal of the floats and easy realignment when replaced. Submit details for approval by the Engineer prior to Installation.

8. Meters and Instruments

Meters and instruments applied to mains or panels as a whole, such as ammeters and voltmeters shall be switchboard type, black on white, approximately 114mm (4.5 inches) square with 1% accuracy zero adjustment and 250-degree scales. Where scale ranges are not indicated, scales shall be selected such that full scale is adequate for the range of readings possible and nominal expected readings will be at roughly half of full scale.

Ammeters for individual compartments shall be nominally 63.5mm (2.5 inches) square or round, analog meters with accuracy of 2% or better, with scale ranges matched to the starter current. Damping shall be appropriate for current. Where indicated, ammeters shall be of the meter relay type with at least one adjustable set point. Meter cases shall be compatible with motor control center construction specified.

Meter and instrument transfer switches shall be instrument-grade, multi-position, control switches having pistol-grip handles. Voltmeter selector switches shall be 7-position. Ammeter selector switches shall be 4-position. All switches shall have an off position.

Elapsed time meters shall be approximately 63.5mm (2.5 inches) square or round with suitable flush mounting flange, reading in hours and tenths of hours. The meters shall be non-reset type.

Potential transformers and current transformers for meters and instruments shall be fully compatible with associated instrument scales and accuracy. When no other indication is given, 3 potential transformers shall apply for voltage metering. A single phase current transformer may be used for individual starter compartment ammeters, with the output also suitable for a connection as a single input to the telemetry system

Control relays shall be hermetically sealed, with convertible, high reliability contacts rates not less than 5 amperes resistive.

Synchronous motor driven, time delay relays shall have a nominal 102mm (4 inch) square face, shall be "on-delay" or "off-delay" as indicated and shall be of the range indicated. They shall be suitable for flush panel mounting. Each relay shall plug into a permanently wired molded case assembly. Time shall be set by turning a knob with a pointer on the face of the relay. The relay shall have a cycle progress pointer which will advance clockwise from the setting back to zero during timing. The relays shall have instantaneous and delayed contacts as required for the functions indicated. Unless otherwise indicated, the relays shall be for 120-volt operation.

Solid state time delay relays shall be "on-delay" or "off-delay" as indicated or may be of the convertible operation type. The relays shall have the dial range indicated and shall be complete with a permanently wired plug-in base. Where indicated, they shall be suitable for flush panel mounting, and shall then be complete with cycle progress pointer. When not indicated as being for flush panel mounting, the relays shall be suitable for internal mounting and they shall then be equipped with retaining clips to keep them secure in their plug-in sockets. They shall have contacts, as required, for the functions indicated. Unless otherwise indicated, the relays shall be for 120-volt operation.

9. **Wiring Identification**

All wiring shall be identified by means of color coding and wire markers as specified herein. Circuit identification shall include all color coding requirements of the NEC, with particular attention directed to Article 210-5.

All wiring shall be tagged with self-sticking wire markers or other markers approved by the Engineer. The tagging shall be applied at each termination and splice. The tagging shall also be applied at other locations, where indicated on the Drawings. Designations shall include the full circuit and wire designation except for terminations at a panel for which the panel portion of the circuit designation may be omitted. Markers shall be permanent, of a size recommended by the manufacturer for the respective wire size and shall be applied as recommended by the manufacturer.

Unless specifically approved by the Engineer, color coding of neutral and ground wires shall be by means of colored insulation, except where bare ground wires are indicated.

Branch circuit wiring smaller than No. 6, from panelboards, for lighting, receptacles and similar loads shall be color coded by means of colored wire insulation. Colors shall be as selected by the Contractor but a sufficient number of colors shall be used such that wiring in common enclosures is clearly differentiated and color combinations of wiring runs are Generally not repeated. Care shall be taken in the phasing of combined-neutral circuit runs. Switched legs shall be differentiated from unswitched legs of a circuit.

Control circuit wiring shall be color coded by means of colored wire insulation as follows:

"line" :	black
neutral :	white
ground :	green
others :	red, or as otherwise indicated on the drawings

Except as otherwise specified herein, wire color coding may be by means of colored insulation or colored tape, applied at each termination, splice and pull box.

10. Rigid Steel Conduit

Rigid steel conduit shall be manufactured to conform to Federal Specification WWC-58I, NEC Article 346, ANSI Specification 680.1, and UL labeled.

All surfaces, including factory-made threads shall be protected from corrosion by hot-dip or electro-galvanizing after threading. Factory threads shall be protected plastic and caps.

11. Flexible Metal Conduit

Flexible metal conduit shall be liquid-tight flexible metal conduit as defined by NEC Article 351 and shall be UL listed for wet location use.

Flexible metal conduit shall have nylon insulated throats.

Sizes through 31.8mm (1-1/4 inch) shall have a built-in copper grounding conductor, UL listed as such.

12. Rigid Nonmetallic Conduit

Rigid nonmetallic conduit shall be manufactured to conform to Federal Specification WC-I094A NEMA specification TC-2 and NEC Article 347 and shall be UL listed for exposed, encased and underground applications.

The conduit shall be "Schedule 40" with minimum wall thickness as follows:

Nominal Diameter		Minimum Wall	
MM	Inches	MM	Inches
25.4	1	3.38	.133
31.8	1-1/4	3.56	.140
38.1	1.5	3.68	.145
50.8	2	3.91	.154
63.5	2.5	5.16	.203
76.2	3	5.49	.216
88.9	3.5	5.74	.226
101.6	4	6.02	.237
127.0	5	6.55	.258

13. Conduit Fittings

Conduit couplings, elbows and nipples shall conform to the fitting specifications corresponding to their respective conduit specifications.

Locknuts, bushings, reducers, conduit plugs and similar fittings shall be galvanized or cadmium plated and shall conform to Federal Specification W-F-408.

Conduit bodies, such as used for pulling fittings or for avoiding sharp bends shall be hot dip galvanized and shall be complete with covers having self-retaining screws. Unless otherwise indicated, conduit bodies shall be cast iron alloy or malleable iron, with gaskets and matching cast metal or malleable iron.

Insulated bushings shall be malleable iron or steel complete with plastic inserts or shall be high impact resistance plastic. They shall be UL listed with a rating not less than 150 degrees C. and they shall be equipped with ground lugs where required.

Conduit hubs which are not integral to a box or fitting shall be malleable iron or stainless steel and shall have nylon-insulated throats, neoprene o-rings, and shall be positively grounded and watertight.

14. Pull Boxes

Boxes shall be cast boxes or sheet steel boxes as indicated or specified. Each box shall be complete with a cover of the same type and material as the box except that flush-mounted sheet steel boxes for switches and receptacles shall have Type 302 satin finish stainless steel plates. Boxes shall be hot-dip galvanized. Sizes of boxes shall not be less than shown on the Drawings, and shall otherwise conform to NEC requirements as a minimum except that boxes shall not be less than 101.6mm (4-inches) square by 50.8mm (2 inches) deep.

15. Cast Boxes

Cast metal boxes shall be gray-iron alloy free from defects such as voids and shrinkage cracks, complete with covers having neoprene gaskets. Cast aluminum boxes shall not be used.

16. Raceway Installation

Except where otherwise indicated or specified, raceways shall be rigid steel conduit.

No conduit smaller than 19.1mm (3/4-inch) diameter trade size shall be used unless specifically indicated. Wherever no conduit size is shown on the Drawings, the conduit size shall be taken to be 19.1mm (3/4-inch) diameter.

Conduit runs shall have no more than 270 degrees of bends (the equivalent of three 90 degree bends) between pull points. Bends may be either factory-made bends or field bends using suitable bending apparatus.

Wherever possible, conduits shall be installed with a slight pitch to drain to the nearest box or fitting.

Threaded raceway joints shall be made with a conductive compound applied to the male threads. Threads shall be made to avoid butting and to avoid exposed threads. In no case will running threads be allowed.

Conduit reducers shall be provided as required for conduit terminations at equipment.

Myer's hub or equivalent type as specified by the Engineer shall be used for all conduits terminating into the junction box.

17. Flexible Conduit

Unless otherwise indicated all flexible conduit shall be liquid-tight flexible metal conduit as specified herein.

Flexible conduit shall be used for raceway terminations where vibration will be present, such as at motors, limit switches, electric damper motors, solenoid valves and the like and the length of these flexible conduit terminations shall not exceed .91M (3 feet).

All fittings used with flexible conduit shall be suitable for the conduit in conformance with the conduit manufacturer's requirements.

Flexible conduits larger than 31.75mm (1-1/4 inch) trade size shall be installed complete with suitable terminating fittings at each end.

18. Wire and Cable

The terms wire and cable as used herein and in the Drawings shall be interchangeable and shall refer to electric wire and cable conductors in conformance with the NEC.

Unless otherwise indicated, all wire and cable shall be insulated conductors as defined by the NEC.

Wire and cable shall be UL listed, new, and delivered to the site in full reels or boxes. The reels or boxes shall have tags or imprint showing the UL listing.

No wire size smaller than No. 12 shall be used unless specifically indicated.

19. Conductors

Unless otherwise specifically indicated all wire and cable shall have copper conductors conforming to ASTM B-3 or ASTM B-8 with Class B stranding.

Conductors who are No. 8 and larger shall be stranded. Conductors smaller than No. 8 may be solid or stranded.

Conductors sized No. 8 and larger shall be coated in accordance with ASTM B-33 or B-189.

20. Insulation

Wire and cable insulation shall be suitable for the conditions of the Installation and the voltage of the respective system and, unless otherwise specifically specified, all wire and cable for system operating at 480 volts or less shall be insulated for 600 volts AC and shall be rated at not less than 90 degrees C dry and 75 degrees wet.

All 600-volt wire and cable sized No. 8 and larger shall be UL listed as Type USE and RHH and RHW, VW-1, with insulation of heat and moisture ethylene-propylene rubber (EPR) resistant compound.

All 600-volt wire and cable smaller than No. 8 shall be UL listed as Type THW or THWN, with insulation of heat and moisture resistant polyvinylchloride (PVC) thermoplastic and a nylon jacket or Type XHHW with insulation of cross-linked polyethylene compound, except that all such writing on the project shall be of the same type.

21. Wire and Cable Installation

Wires and cables shall be carefully installed to avoid damage to insulation and cable jackets.

Wire lubricant shall be used when pulling wires into conduits. The lubricant shall be non-injurious to conduits, conductors, insulations or jackets and the lubricant shall be UL listed. Documentation shall be submitted to confirm suitability of the lubricant for the cables used on the project.

Each run of cable shall have sufficient slack.

Where a number of wires are trained through a box, manhole or handhole, they shall be grouped by circuit where applicable and bundled using appropriate cable ties and supported to minimize pressure or strain on cable insulation.

Wire and cable shall not be bent to a radius less than the manufacturer's recommended bending radius, either in permanent placement or during Installation.

Cable pulling apparatus shall have no sharp edges or protrusions, which could damage cables or raceways.

22. Piping and Appurtenances

The work specified herein includes furnishing and installing all piping and accessories required for a complete and satisfactorily working Installation as shown on the drawings and as specified herein.

All piping shall be Generally arranged and aligned in accordance with the proposed drawings prepared by the Contractor and as specified. Where special conditions are encountered in the field, the arrangement and alignment of piping shall be as directed by the Engineer.

Piping shall be installed as directly as possible between connecting points insofar as the work of other trades permit. Where interference occurs with another trade whose work is more difficult to reroute, the

Contractor shall revise the routing as required to avoid subject interferences. Piping shall be carefully installed to provide for proper alignment, slope and expansion.

To allow for expansion and contraction, pipe shall be guided and supported in such manner that pipe lines shall not creep, sag or buckle. Anchors and supports shall be provided wherever necessary to prevent any misalignment of piping. Pipe support shall not be limited to support indicated on the drawings.

For underground piping, where changes in direction occur and wherever else required, piping shall be anchored to prevent blowouts or creep from either exterior or interior stresses at pipe joints. Allowance shall be made whenever necessary for any future settlement of pipe lines to insure the required pitch and avoid pocketing.

Small tubing to gauges, controls, or other equipment, installed on any apparatus shall not be coiled nor excessive in length but shall be installed neatly, carefully, bent at all changes in direction, secured in place and properly fastened to equipment at intervals to prevent sagging.

Prior to the start of any piping Installation work, the Contractor shall prepare, and submit for approval by the Engineer, detailed piping Installation drawings. These shall be prepared on the basis of actual equipment being furnished on actual dimensions of walls, openings and other significant elements.

23. Steel Pipe

Steel pipe shall be Schedule 40, black or galvanized as indicated on the Drawings or as specified elsewhere in the specifications. Steel pipe shall be subject to the requirements of the applicable portions of the latest editions of the following standards:

A53 Specification for Pipe, Steel, Black and Hot-Dipped, Zinc-Coated Welded and Seamless. ASTM A120 Specification for Pipe, Steel, Black and Hot-Dipped, Zinc-Coated (Galvanized) Welded and Seamless for Ordinary Uses.

A120 Specification for pipe, steel, black and hot-dipped, zinc-coated (galvanized) welded or seamless for ordinary uses.

Steel pipe shall have flanged ends when indicated on the Drawings. Flanges for steel pipe shall be of weld neck or slip-on type. Flanges of the slip-on type shall be installed with the pipe set back from the face of the flange and the flange welded to the pipe in both front and back.

Unless otherwise indicated, flanged steel pipe shall be made up with cast iron fittings.

24. Ductile Iron Fittings

Ductile iron fittings shall be provided as indicated on the Drawings and specified herein. Ductile iron fittings shall be subject to the requirements of the applicable portions of the latest editions of the following standards:

A21.10 Ductile-Iron Fittings, 76.2mm (3-in.) through 1.22M (4 feet) for Water and Other Liquids.

25. Flanged Connections

Flanged connections shall be made as indicated on the proposed Drawings prepared by the Contractors and as specified herein. All flanges shall be drilled in conformance with the 125/150 ANSI Standard template.

Class 68.0 kg (150 pound) steel flanges shall be smoothed finished (flat faced) for connection to dissimilar metals such as cast iron.

Flanged connections shall be assembled with full face rubber gaskets using ASTM A307, Grade B, hex head machine bolts.

26. Wall Castings

Cast iron wall castings shall be furnished and installed for all storm water piping passing through walls, as shown on the drawings.

Wall castings shall be flanged at both ends with flanges to fit flush to surface. Flanged ends shall be tapped for studs with drilling to conform to the American Cast Iron Flange Standard, Classes 125 (B16.1).

All wall castings shall be furnished and installed with centrally located intermediate wall collars to provide watertight construction by increasing resistance to seepage. Wall castings to be set in the form with the bolt holes in the flanges straddling the center lines - both horizontally and vertically.

27. Wall Sleeves

Wall sleeves shall be cast iron and schedule 40 galvanized steel pipe as called for on the drawings. Sleeves shall be sealed with modular type wall seals.

28. Wall Opening

The Contractor shall determine the required inside diameter of each individual wall opening or sleeve before opening shall be sized as recommended by the manufacturer to fit the pipe and Link-Seal to assure water-tight joint.

29. Sleeve Couplings

Sleeve type couplings for steel pipe shall be dresser type with center stop removed or approved equal.

30. Flap Valves (Flap Gates)

The Flap Valve, size as indicated in the Pay Item, shall be flange-framed with a resilient seat. It shall be specifically designed for pump discharge service.

The body shall be cast-iron ASTM A126-B. The flange shall be faced and drilled 125 lbs, standard for all pipe flange mounting.

A resilient seat, neoprene on Burna-N shall be bonded in a groove machined in the body to provide a wide contact surface for the seat machined in the cover.

The cover, or flap, shall be cast iron, ASTM A126-B with spherically dished design to withstand maximum operating loads. Severe pump discharge applications may require high-test cast-iron, ASTM A126-C, or ductile iron, ASTM A536 for the cover as recommended by the manufacturer.

The hinge arms shall be high-tensile bronze ASTM B584-CA865. The hinge pins, designed in double shear, shall be silicon bronze, ASTM 898-CA655 or Type 304 stainless steel. Each hinge arm shall have two pivot points, an adjustable lower pivot with limited rotation and a threaded upper hinge post to adjust flap valve sensitivity. A lubrication fitting shall be supplied for each pivot.

An anti-locking bar, between the hinge arms, shall be provided to prevent excessive rotation about the lower hinge pin.

A steel leaf spring attached to the body and extended over the cover shall be provided to safely limit the travel of the cover during “pump discharge” operation. A rubber pad shall be provided at the spring to cover the contact point.

Surveillance And Dynamic Message Systems Non-Routine Pay Items:

SB01 Beacon, Flashing, Low Mount, 1 Face

Description. This item shall conform with sections TSC T401#1, T412#1, and T426#1 of the Recurring Special provisions for Traffic Surveillance and highway standard 2372 "Details of Spanwire Mounted Signal and Flashing Beacon Installation" except as revised herein. This item shall consist of installing two (2) low mounted eight inch or single section yellow flashing beacons on an existing post as shown on the plans or directed by the TSC Engineer. This item shall include furnishing and installing a flasher controller in the cabinet, required by the TSC Engineer, and all other incidentals necessary to complete the installation. The basis of payment is each for furnishing all equipment and labor necessary to complete the installation. The item shall not include the underground conduits, trench and backfill or the cable between the service installation and the base of the flashing beacon. These items will be paid separately.

Basis of Payment. This work shall be paid at the contract unit price each to BEACON, FLASHING, LOW MOUNT, 1 FACE, FURNISH AND INSTALL (SF1) as described above, which price shall be payment in full for all work as described herein and as directed by the Engineer.

SC01 Cabinet Housing Equipment, Remove and Reinstall

Description. This item shall conform to Section T637 #1 of the Traffic Surveillance Specification except as reviewed herein. Removal of an existing traffic Surveillance cabinet and transportation to the Contractor's storage facilities during reconstruction of a surveillance location as well as reinstallation of same cabinet upon completion of repair or reconstruction shall be considered as a complete item. This item shall include new anchor bolts, nuts and washers as incidental to the item.

Basis of Payment. The work shall be paid at the contract unit price for each CABINET HOUSING EQUIPMENT, REMOVE AND REINSTALL and for which price shall be payment in full for all work as described herein and as directed by the Engineer.

SC02 Cabinet, Metering, Remove and Salvage

Description. This work shall consist of completely removing an existing surveillance/metering cabinet, being careful not to damage those existing conduits which will be reused for a new surveillance cabinet. In case an existing conduit is designated to be reused is damaged, the unsuitable portion will be cut off and a new conduit furnished and spliced in place. The repair work will not be paid for separately, but will be incidental to this bid item. The Surveillance/Metering Cabinet will be disposed of as directed by the engineer and all debris removed beyond the right of way.

Basis of Payment. This work will be paid for at the contract unit price each for CABINET, METERING, REMOVE AND SALVAGE, which price shall be payment in full for all labor and materials necessary to complete the work as described above.

SC03 Cabinet, Type 2, for Surveillance

Description. This item shall consist of furnishing and installing a new type II cabinet pedestal mounted at an existing speed count installation and shall include wiring and re-installation of equipment and appurtenances from existing to new cabinet.

The components of the expressway detector cabinet shall consist of a cabinet post and base, foundation, telemetry mounting frame, where applicable.

<u>TYPE</u>	<u>HEIGHT</u>	<u>WIDTH</u>	<u>DEPTH</u>	<u>THICKNESS</u>	<u>MATERIAL</u>
ESP 2	36"	20"	15"	3/16"	Fabricated Aluminum

This cabinet shall be water tight. Doors shall be gasketed to provide a waterproof seal. Bases shall be caulked to obtain a moisture-proof bond, and replacement cabinets will be re-numbered with cabinet replacement numbers to match location.

All cabinets shall be fitted with a fused thermostatically controlled fan.

It shall be mounted at the top of the cabinet for a forced air fan system that has a screened air exhaust opening under roof overhang and no opening in top of cabinetry. The fan shall be capable of operating at 130 CFM. at .160" of water static pressure.

Materials shall conform to controller cabinets listed in the Standard Specifications for Road and Bridge 1085.47, except that the door shall not have any outside designation nor shall the cabinet door be equipped with a police door or louvers. Post top mounted cabinets, shall have a 1/4" cabinet bottom completely welded.

Installation shall conform to applicable portions of Section TSC T637#2 of the Traffic Surveillance Specifications.

Cabinets, cabinet posts, and cabinet pedestals shall be primed and painted in accordance with Section TSC T712#1 of the Traffic Surveillance Specifications. The final coat and color shall be as directed by the Engineer.

All cabinets shall be serviced by 117 volts AC power and a telecommunication system. Each cabinet shall be equipped with a 10 ampere circuit breaker, ground rod, 115 VAC RF1 filtering surge protector (SHP-6LC Surrestor), 130 volt, 70 joules, 10 amp varistor, lighting protection for each loop (SRA-6LC Surrestor), data line protection for each leg of the four (4) wire telecommunication system (SRA 64C Surrestor), a pull chain porcelain fixture shall be mounted on metal plate, that shall be mounted on the cabinet ceiling. No holes shall be drilled through the cabinet exterior for internal equipment mounting. It will also be equipped with Handy Boxes, with G.F.I. duplex outlet.

Each wire entering a cabinet shall be terminated in a workmanlike manner at a terminal strip or switch. If more than one wire has a common terminal on a terminal strip, the adjacent strip shall be used and an appropriate jumpered connection shall be made. All cables and wires entering a cabinet shall be dressed, harnessed, tied, laced and clamped to produce a workmanlike wiring installation.

Pay Item SC4 Continued:

A copper wire, combination grounding bus shall be mounted on the rear wall of the cabinets. All cabinets shall be furnished with a minimum of two (2) shelves per cabinet.

Basis of Payment. This work shall be paid at the contract unit price each for CABINET, TYPE 2, FOR SURVEILLANCE, which price shall be payment in full for furnishing and installing and all work as described herein and as directed by the Engineer.

SC04 Cabinet, Type 3, for Surveillance

Description. This item shall consist of furnishing and installing a new type 3 (III) cabinet at an existing surveillance installation and shall include wiring and re-installation of equipment from existing cabinet to a new cabinet.

The components of the expressway monitoring cabinet shall consist of where applicable a flasher controller. It shall be solid state. It shall consist of two components: A base, which is mounted on the ramp metering, control cabinet wall, and the flasher which plugs into and is secured to the base by a loading screw. A radio interference filter shall be supplied with the flasher controller. The flashing beacons shall flash alternately at the rate of not less than fifty (50) nor more than sixty (60) flashes per minute. Ramp metering cabinet shall have a signal load relay installed.

The signal load relay shall consist of two components, a base, which is mounted on the E.S.P. Type 3 cabinet wall, and a signal load relay which plugs into and is secured to the base by locking screw. The coil of this relay shall be connected to the mark output of the signal change tone receiver. The one set of contacts of the load relay shall be used to change the ramp signal and one set of contacts shall be used to key the mark input to the signal change transmitter. Telemetry mounting frame with frame mounting hardware. All cabinets shall be fitted with a fused thermostatically controlled fan. It shall be mounted at the top of the cabinet for a forced air fan system that has a screened air exhaust opening under roof overhang and no opening in top of cabinetry. The fan shall be capable of operating at 130 cfm.. at .160" of water static pressure

Cabinets shall be supplied in sizes with minimum inside dimensions listed below:

<u>TYPE</u>	<u>HEIGHT</u>	<u>WIDTH</u>	<u>DEPTH</u>	<u>THICKNESS</u>	<u>MATERIAL</u>
ESP 3	49-1/2"	30"	17"	3/16"	Fabricated Aluminum

This cabinet shall be watertight. Doors shall be gasketed to provide a waterproof seal. Bases shall be caulked to obtain a moisture-proof bond, and replacement cabinets will be re-numbered with cabinet replacement numbers to match location.

Materials shall conform to controller cabinets as listed in the Standard Specifications for Road and Bridge items, 1085.47 except that the door shall not have any outside designation nor shall the cabinet door be equipped with a police door or louvers.

Installation shall conform to applicable portions of Section TSC T637#2 of the Traffic Surveillance Specifications.

Cabinets, shall be primed and painted in accordance with Section TSC T712#1 of the Traffic Surveillance Specifications. The final coat and color shall be as directed by the Engineer.

All cabinets shall be serviced by 117 volts AC power and a telecommunication system. Each cabinet shall be equipped with a 10 ampere circuit breaker, ground rod, 115 VAC RF1 filtering surge protector (SHP-6LC Surrestor), 130 volt, 70 joules, 10 amp varistor lighting protection for each leg of the four (4) wire telecommunication system (SRA 64 C Surrestor), 130 volt, 70 joules, 10 amp varistor, lighting protection for each loop (SRA-6LC Surrestor), data line protection for each leg of the four (4) wire telecommunication system (SRA 64C Surrestor).

It will also be equipped with Handy Boxes, with G.F.I. duplex outlet and a pull chain lampholder with an A.C. outlet.

No holes shall be drilled through the cabinet exterior for internal equipment mounting.

Each wire entering a cabinet shall be terminated in a workmanlike manner at a terminal strip or switch. If more than one wire has a common terminal on a terminal strip, the adjacent strip shall be used and an appropriate jumpered connection shall be made.

All cables and wires entering a cabinet shall be dressed, harnessed, tied, laced and clamped to produce a workmanlike wiring installation.

A copper wire, combination grounding bus shall be mounted on the rear wall of the cabinets. All cabinets shall be furnished with a minimum of two (2) shelves per cabinet.

This work shall be paid at the contract unit price each for CABINET, TYPE 3 (III), FOR SURVEILLANCE, which price shall be payment in full for furnishing and installing and all work as described herein and as directed by the Engineer.

SC05 Cabinet, Model 334

Description: Work under this item shall consist of furnishing and installing a Model 334 cabinet for field equipment including fiber optic communications, ramp meter and system detector stations, and dynamic message signs as shown on the Plans and as hereinafter provided.

Materials:

General: Cabinet, Model 334 shall be a durable, weatherproof enclosure, constructed of 3/16-inch thick aluminum or 1/8-inch thick aluminum lined with bullet resistant fiberglass panels that shall be UL Listed and tested for UL752 Level 3 with a nominal thickness of 1/2-inch maximum, and a nominal weight of 5.0 pounds per square foot maximum. The cabinet shall have nominal outside dimensions of 66-inches high X 24-inches wide X 30-inches deep. Cabinet, Model 334 shall consist of the following components: double door, each equipped with a lock for front and rear cabinet entry, housing, mounting cage, power distribution assembly, service panel, thermostatically controlled fan, and all necessary mounting hardware and wiring, and other equipment, as shown on the Plans and specified in these special provisions.

All bolts, nuts, washers, screws, hinges, and hinge pins that are subject to corrosion shall be stainless steel unless otherwise specified. All equipment under this item shall be in accordance with Section 1074.03 of the Standard Specifications except as modified herein.

Cabinet Components: The housing and the mounting cage assembly shall conform to those of the Model 334 cabinet provisions of the "Traffic Signal Control Equipment Specifications (TSCES) issued by the State of California, Department of Transportation, and to all addenda thereto current at the time of project advertising. The housing shall be rainproof with the top of the enclosure crowned to prevent standing water. All exterior seams for the enclosure and doors shall be continuously welded and shall be smooth. The housing shall have no provisions for a police panel of door.

The cabinet shall have single front and rear doors, each equipped with a lock. The enclosure door frames shall be double flanged out on all 4 sides and shall have strikers to hold tension on and form a firm seal between the door gasket and the frame. The front and rear doors shall be provided with catches to hold the door open at both 90 and 180 +/- 10 degrees. Gasket shall be provided on all door openings and shall be dust-tight. For horizontal support and bolt attachment, cage bottom support mounting angles shall be provided on either side, level with the bottom edge of the door.

The latching handles on the doors shall have provisions for padlocking in the closed position. When the door is closed and latched, the door shall be locked. The locks and handles shall be on the right side of the front door and the left side of the rear door. The lock and lock support shall be rigidly mounted to the door. The locks shall be Corbin #2 and two keys shall be supplied to the Department with each lock. The keys shall be removable in the locked position only.

The front and rear doors shall be provided with louvered vents. A removable and reusable air filter shall be housed behind the door vents. The filter filtration area shall cover the vent opening area, and the filter shell shall be provided that fits over the filter providing mechanical support for the filter. The shell shall be louvered to direct the incoming air downward.

The intake (including filter with shell) and exhaust areas shall pass a minimum of 60 cubic feet of air per minute for housing #1 and 26 cubic feet of air per minute for housing #2. The thermostatically controlled fan with ball or roller bearing shall be mounted within the housing and vented. The fan shall provide a capacity of at least 150 cubic feet of free air delivery per minute of ventilation. The fan shall be thermostatically controlled and activated when the temperature inside the cabinet exceeds 75 degrees Fahrenheit and shut off when the temperature is less than 64 degrees Fahrenheit. In addition, the fan shall be manually adjustable for automatic turn on and off. The fan circuit shall be protected at 125% of the fan motor ampacity.

The housing shall also be equipped with a heating element installed in the bottom front of the cabinet and mounted along the side of the rack. The heating element shall draw 500 watts and have an output of a least 1700 BTU/hr. The heater shall have a built-in quick response thermostat with sealed contacts that has a temperature control range of 40° F to 100° F, have a built-in thermal cut-off to automatically shut-off the heater in the event of overheating.

All sub-assemblies shall be mounted in removable 19-inch EIA self-standing rack assemblies. The EIA rack portion of the cage shall consist of 1 pair of continuous, adjustable equipment mounting angles that comply with Standard EIA RS-310-B. The cage shall be centered within the cabinet and bolted to the cabinet at 4 points.

The DMS controller cabinet shall be equipped with 2 shelves. One shelf shall be fixed and the other shall be a slide-out shelf suitable for resting a laptop computer on.

All other cabinet shall be equipped with 2 shelves. Shelves shall be the full width of the rack and 12-inches deep. The shelves shall be designed to support a minimum of 50 pounds.

The power distribution assemblies for the DMS controller shall have as a minimum; one 50A, 2-pole, 240V main circuit breaker; five 15A, 1-pole, 120V secondary circuit breakers; eight standard 117 VAC controller and equipment receptacles, and one duplex, 3-prong, NEMA GFI type 5 15R grounded outlet.

The power distribution assemblies for all other cabinets shall be as shown on Plans and shall consist of input files that are common to both 332 and 336 type cabinets and provides 9 AC outputs and up to 28 isolated inputs. The power distribution assembly shall consist of the following: one 30A, 120V main circuit breaker, three 15A, 120V single pole secondary circuit breakers, eight standard 117 VAC controllers and equipment receptacles, and one duplex, 3-prong NEMA GFI Type 5 15R grounded utility type outlet.

Rating of breakers shall be shown on face of breaker or handle. Breaker function shall also be labeled below breakers on front panel. The first equipment receptacle in the circuit shall have ground-fault circuit interruption as defined in the NEC. Circuit interruption shall occur on 6 mA of ground-fault current. All conductors from the power distribution assembly routed to the cabinet wiring shall be connected to the terminal block on the common side, except for the AC power conductor between the service terminal block and the main circuit breaker. All internal conductors terminating at the blocks shall be connected to the other side of the blocks.

Two side panels shall be provided and mounted on the cabinet sidewall. In viewing from the front door, the left side panel shall be designated as the “Input/Communications” and the right side panel shall be designated as the “Service Panel”. The panel shall be drilled and tapped, as necessary, to mount the terminal blocks and other attachments described herein, as well as to mount the panel to the cabinet wall.

The terminal blocks shall be barrier type rated at 20 A, 600 V RMS minimum. The terminal screws shall be nickel-plated brass binder head type with screw inserts of same material the terminals of the power line service terminal block shall be labeled “AC+, AC-, and AC GND”, and shall be covered with a clear insulating material to prevent inadvertent contact. Terminating lugs large enough to accommodate the incoming service conductors shall be furnished for the service terminal block. The service terminal block shall be rated for 100 A at 600V peak, minimum.

Surge suppression for DMS controller cabinets shall be provided by a two-stage system using metal oxide varistors (MOV) and spark gap arrestors. The clamping voltage of the system shall be 280 V on 240V lines for the first stage, and 320 V on 240 V lines for the second stage.

The power distribution assembly for all other cabinets shall protect the equipment powered by the assembly from power transients. Over voltage protection shall be provided for the power distribution assembly and shall contain, as a minimum, a surge arrester, which shall reduce the effect of power line voltage transients and be mounted to the service panel. The arrester shall have the following minimum features:

Recurrent Peak Voltage:	184V
Energy Rating (Minimum)	50 J
Power Dissipation, Average:	0.85 W
Peak current for pulses less than 7 microseconds:	1250 A
Stand-by Current for 60 Hz Sinusoidal:	1mA or less

Each cabinet shall be equipped with two fluorescent lighting fixtures mounted to the inside top front portion of the cabinet. The fixtures shall have an F-15-T-8 cool white lamp, operated from a normal power factor, UL listed cold

weather ballast. A door-activated switch shall be installed to turn the cabinet lights on when the front door or rear door is opened. The door switches shall be on a separate circuit by themselves and used only to turn on the cabinet lights.

Each cabinet shall be supplied with a heavy-duty plastic envelope to store plans, wiring diagrams, schematics, etc. This envelope shall have metal grommets so that it hangs from the door hooks. The envelope shall have minimum dimensions of 10 inches X 15 inches.

Foundations shall conform to those shown on Detail sheet “Cabinet Model 334 Details” of the Plans. The foundation is paid for separately.

Identification: The Cabinet, Model 334 shall be identified and labeled with external markings as specified in Article 1069.02 of the Standard Specifications and as shown on the Plans.

CONSTRUCTION REQUIREMENTS:

The Contractor shall deliver the Cabinet Model 334 mounted on a ply-board shipping pallet that is bolted to the cabinet base. The cabinet shall be enclosed in a slipcover cardboard packaging shell. The housing doors shall be blocked to prevent movement during transportation to the site.

The Contractor shall securely fasten the Cabinet Model 334 on the new concrete foundation at the locations shown on the Plans. The Contractor shall confirm the orientation of the Cabinet Model 334 installation and its front door side with the Engineer prior to installation. Stainless steel bolted connections shall be provided with lock-washers, locking nuts, or other approved means to prevent the connection nuts from backing off. Dissimilar materials shall be isolated from one another by stainless steel fittings.

The Contractor shall make all power connections to the cabinet in accordance with the Plans and as required. The neutral bus shall be isolated from the cabinet and equipment ground. It shall terminate at the neutral lug ultimately attached to the meter pedestal. All conductors used in cabinet wiring shall terminate with properly sized non-insulated (if used, for DC logic only) or clear insulated spring-spade type terminals except when soldered to a through-panel solder lug on the rear side of the terminal block or as specified otherwise. All conductors, except those which can be readily traced, shall be labeled. Labels attached to each end of the conductor shall identify the destination of the other end of the conductor. Cabling shall be routed to prevent conductors from being in contact with metal edges. Cabling shall be arranged so that any removable assembly may be removed without disturbing conductors not associated with that assembly.

All equipment in the cabinet, when required, shall be clearly and permanently labeled using marker strips. The marker strips shall be made of material that can be easily and legibly written on, using a pencil or ballpoint pen. Marker strips shall be located immediately below the item that they are to identify and must be clearly visible with the items installed.

DMS controller cabinets shall meet the requirements of these specifications and of the DMS manufacturer. The requirements listed in this specification are minimum construction guidelines and shall be adjusted as required to meet the selected sign manufacturer requirements. No additional compensation shall be provided to meet these requirements. These cabinets shall only be ordered after the DMS manufacturer has been selected and has approved the cabinet shop drawings.

Tests: Cabinet Acceptance Test – In addition to the environmental and design approval tests specified in the FHWA Type 170 Traffic Signal Control System Hardware Specification, the following water spray test shall be performed for each type of cabinet:

Spray water from a point directly overhead at an angle of 60 degrees from the vertical axis of the cabinet. Repeat for each of eight equally spaced positions around the cabinet for a period of five minutes in each position. The water shall be sprayed using a domestic type-sprinkling nozzle at a rate of not less than 10

gallons per minute per square foot of surface area. The cabinet shall then be inspected for leakage. Evidence of water leakage shall be cause for rejection.

Operational Standalone Test – The operational standalone test for each Cabinet Model 334 installed shall consist of the following:

- Visual inspection of the cabinet and its contents for workmanship
- Verification of the cabinet grounding in accordance with Article 1074.03(a)(4) of the Standard Specifications
- Measurement of the voltage at the input panel

Documentation: Shop drawings and wiring lists showing the proposed layout of each type of cabinet shall be submitted to the Engineer for approval prior to the start of fabrication. Wiring lists for the internal manufacturer cut sheets for all electrical equipment included in each type of cabinet shall be included in the submission.

Four copies of drawings showing the wiring for each cabinet shall be provided. One copy shall be placed in the clear plastic envelope furnished as part of the cabinet. The other three copies shall be delivered to the Engineer.

For each cabinet, four copies of a configuration of the equipment reporting to that cabinet shall be provided. The sheet shall also list field settable options for the equipment contained in the cabinet. This shall include device addresses and output voltage settings for power supplies. One of these copies shall be placed in the clear plastic envelope furnished as part of the cabinet. The other three copies shall be delivered to the Engineer.

Warranty: The Contractor shall warranty all materials and workmanship including labor for a period of two years after the completion and acceptance of the installation, unless other warranty requirements prevail. The warranty period shall begin when the Contractor completes all construction obligations related to this item and when the components for this item have been accepted, which shall be documented as the final completion date in the construction status report. The warranty shall warrant and guarantee repair of the component parts of the Cabinet Model 334 furnished by the Contractor that prove to be defective in workmanship and materials during the first two years of operation as defined and noted above at no additional cost to the Department.

METHOD OF MEASUREMENT:

CABINET MODEL 334 shall be counted as each for the number installed as indicated on the plans or as determined by the Engineer.

BASIS OF PAYMENT:

This item shall be paid for at the Contract Unit price each for CABINET, MODEL 334. This shall be payment for furnishing and installing the cabinet and all connections, testing, and all labor, tools, equipment, transportation, and incidentals necessary to complete this item.

SC06 Cabinet, System Detector, Model 334

SC07 Cabinet, Ramp Meter, Model 334

SC08 Cabinet, Ramp Meter/System Detector, Model 334

Description. This item shall consist of furnishing and installing the equipment in the Model 334 surveillance cabinet.

Materials. The Contractor shall provide the following equipment items to be installed in the Model 334 surveillance cabinet:

- 2070 LITE CONTROLLER (paid for under a separate pay item)
- MAGNETO-INDUCTIVE VEHICLE DETECTOR (paid for under a separate pay item)

- DETECTOR RACK
- LOAD SWITCH
- SOLID STATE FLASHER
- FIBER OPTIC TERMINATION PANEL, 12f (paid for under a separate pay item)
- SERIAL DEVICE SERVER
- DRY CONTACT TO ETHERNET CONVERTER
- VOLTAGE LINE SENSOR

Detector Rack

The Contractor shall furnish and install a Detector Rack with power supplies, loop interface panels, cables and harnesses complete in a surveillance cabinet as shown on the plans and as directed by the TSC Surveillance Engineer.

Detector Rack Power Supply

The power supply shall provide regulated DC power for up to 16 input channels. Input voltage shall be 120 VAC, 50/60 Hz. Output voltage (per channel).

<u>Output voltage VAC</u>	<u>Load current (mA)</u>
31.3	0
27.2	100
24.3	200
21.8	300

The power supply shall have one output indicator per channel. Indicators shall have high-intensity red LEDs which shall indicate output status. Indicators shall illuminate when voltage is greater than or equal to 21.0 VAC ±1.0 VDC and extinguish when voltage is less than 21.0 VDC ± 1.0 VDC.

One power switch shall switch input line voltage for all channels. The power supply shall have the following characteristics:

- Dimensions 2.00” x 4.50” H x 6.875 D
- Weight approximately 2.5 lbs.

The connector shall be a 2 x 22 pin edge card connector with .156” spacing. The connector shall be centered or 4.50” dimension with the following pin assignments:

<u>Pins</u>	<u>Assignment</u>
1 & A	DC Common
2 & B	Channel 1
3 & C	Channel 2
4 & D	Spare
5 & E	Spare
6 & F	Spare
7 & H	Spare
8 & J	Spare
9 & K	Spare
10 & L	Chassis Ground
11 & M	120 VAC Neutral
12 & N	120 VAC Line
13 & P	Spare
14 & R	Spare

15 & S	Spare
16 & T	Spare
17 & U	Channel 3
18 & V	Channel 4
19 & W	Spare
20 & X	Spare
21 & Y	Spare
22 & Z	Spare

The power supply shall fit in standard size card rack.

Detector Card Rack

The card rack shall be equal to or exceed an Econolite 16-position card rack with the loop interface panel.

The 16-position card rack shall be able to support eight 2-channel detectors, four 4-channel detectors or any combination needed.

The Contractor shall provide all labor and materials necessary to terminate the loops in the surveillance cabinet and extend the detector output to the FSK telemetry and connect the RS-32 port off the back panel of the card rack to the Serial Device Server.

The Contractor shall supply each card rack with the RS-232 port pre-wired from the back plane of the card rack.

The RS-232 port connector shall plug into the Serial Device Server without the aid of any adapters. The Contractor shall be responsible for coordination between manufacturers to ensure that the correct connector configuration is used.

The card rack shall be attached to the top shelf in the surveillance cabinet. No tools shall be required to remove the card rack from the shelf.

The loop interface panel shall be used for the purpose of connecting the field loops to the non-invasive, magneto-inductive vehicle detector.

The interface panels shall be manufactured from FR4 G10 fiberglass, .0062” thick, with a minimum of 2 oz. of copper for all traces.

One 16-position interface panel shall be provided for each 16-position card rack.

Each interface panel shall be supplied with a ground terminal bus for termination of the homerun cable shield if elected to be terminated.

Each interface panel shall accommodate 16 independent field loops to be connected.

The loop interface panel shall be attached to the “C” unistrut channel on the side wall of the surveillance cabinet and connected to the card rack via the factory made 20 AWG, twisted pair harness.

The card rack optically isolated FEP outputs shall be hard wired to the telemetry terminal strips. The telemetry terminal strips are the break point between the FSK telemetry swing rack and the card rack.

Lightning protection shall be mounted and provided for each field loop on the interface panel. Mounting holes shall be provided for the Edco SRA-6LC loop lightning protection device.

Load Switch

The Load Switch, when connected to the ramp meter controller, shall be used to control the ramp meter LED signals. The Load Switch shall comply with the following:

- Operating voltage: 80 to 135 VAC
- Maximum load current: 15 amperes
- Control signal voltage +24 VDC
- Isolation: 2500 VDC and 10 MOhms
- Control signal inputs: Green (Walk), Yellow, and Red (Don't Walk)
- Temperature range: -20°C to 74°C
- Nominal dimension (H x W x D): 4.2 in. x 1.75in. x 8.5 in.

The Load Switch shall mate with any standard NEMA loadbay or with the Model 334 Cabinet output file. The load switch must be fully guaranteed against all failures due to manufacturing defects for at least two years from the time of installation.

Solid State Flasher

The Solid State Flasher, when connected to the ramp meter controller, shall be used to control the ramp meter warning flashing beacons. The Solid State Flasher shall comply with the following:

- Operation voltage: 80 to 135 VAC
- Maximum load current: 15 amperes
- Temperature range: -20°C to 74°C
- Nominal dimension (H x W x D): 4.2 in. x 1.75in. x 8.5 in.

The Solid State Flasher shall flash alternately at the rate of not less than fifty nor more than sixty flashes per minute. A radio interference filter shall be supplied with the Solid State Flasher. The Solid State Flasher shall mate with any standard NEMA loadbay or with the Model 334 Cabinet output file. The Solid State Flasher must be fully guaranteed against all failures due to manufacturing defects for at least two years from the time of installation.

Serial Device Server

The Contractor shall furnish industrially-hardened, Ethernet serial device servers. The device server shall be a multi-port serial-to-Ethernet server, specifically designed to operate in harsh environments. The Ethernet server shall operate within specifications over the temperature range of -40°C to 85°C. The server shall operate with relative humidity of 95% non-condensing.

The Ethernet server shall have four RS-232 ports, two 100 Base T ports, and two 100 Base FX ports. The optical ports shall satisfy the following:

- Shall be designed to operate into single mode cable with physical core of 8-9 microns
- Shall provide a nominal output power of -16 dBm, receive sensitivity of -32 dBm, and link power budget of 16 dB.
- Shall operate at 1310 nm (nominal)

The Ethernet ports shall be full duplex. The Ethernet switch management shall be full duplex. The Ethernet switch management shall include:

Enhanced Rapid Spanning Tree (IEEE 802.1w) for fault tolerance with rapid recovery times
Quality of Service (IEEE 802.1p) for real-time traffic
Port rate limiting: 128 kbps, 256 kbps, 512 kbps, 4 Mbps, and 8 Mbps
VLAN (IEEE 802.1q) for traffic segregation with double tagging
IGMP Snooping for multicast filtering
Port configuration, status, statistics, mirroring, and security
Loss of link management for link pulse control on fiber ports

The Contractor shall install, provision, and test all equipment. The Contractor shall prepare a shop drawing, which details all of the equipment to be supplied under this bid item. The submittal shall consist of the standard catalogue descriptions and user or installation manuals for each component. The information submitted must be sufficient to verify that the equipment is compliant with all of requirements included in the material specifications. In addition, schematics shall be included which detail the interconnection of all of the components to other system components.

The Contractor shall demonstrate a prototype assembly using the proposed components. This demonstration shall take place at a Contractor selected and Engineer approved location. These conformance tests shall be completed prior to the delivery of any completed assemblies to the project site. Any deviations from these specifications that are identified during this testing shall be corrected prior to shipment of the assembly to the project site.

The Contractor shall develop and submit for the Engineer's approval, a detailed test plan that verifies that each component is compliant with the specification and that all of the interconnection cables are operational and properly configured. This test shall use standard manufacturer operating and diagnostic software. At the test, each component will be inspected to verify that it has been delivered according to the approved shop drawings.

The Contractor shall label all cables and ports using permanent cable tags. These labels shall identify the function of the cables and the ports the cables are connected to.

Installation

The Model 2070 Lite ATC unit shall be installed and connected inside the Model 334 Cabinet at the locations as shown on the Plans and according to the manufacturer's instructions. The contractor shall install all cables and ancillary equipment, connecting the Model 2070 Lite ATC to the Ramp Meters and Detectors.

Surge and over-voltage protection shall be installed on all loop lead-in cables and all power conductors.

All cables shall be neatly dressed and labeled with their function and physical connection.

Testing

The Contractor shall power up the Model 2070 Lite ATC and self-test the unit using available software. Applications software shall be uploaded, configured, and validated. This testing shall be accomplished prior to installing the unit in the field cabinet. After the unit is installed in the cabinet, the Contractor shall apply power and verify the unit is operating correctly. Tests previously used for bench checking shall be repeated and documented.

The Contractor shall test the operation of the 2070 Lite Controller as a subsystem with the vehicle detection systems operational, using CCTV video as ground truth for ramp meter operations and volumes, and a calibrated radar gun for speed. Traffic data produced by the 2070 Lite Controller shall be within 5% of ground truth (actual traffic counts and speeds). A written copy of the test, with supporting videotape, shall be submitted to the Engineer at the end of the test for approval.

The Contractor shall test the communications between the 334 Cabinet and the Traffic Systems Center. This test shall demonstrate the capability of setting the timing plans remotely for ramp metering cabinets and to download traffic data for others. These tests will use the software provided under the pay item for the 2070 Lite Controller.

Documentation

One copy of all operations and maintenance manuals for each component shall be delivered for each assembly installed. In addition, full documentation for all software and associated protocols shall be supplied to the Department on a 3.5-inch floppy disk(s) and a CD-ROM. The Department reserves the right to provide this documentation to other parties who may be contracted with, in order to provide overall integration or maintenance of this item.

Warranty

The Contractor shall warranty all materials and workmanship including labor for a period of two years after the completion and acceptance of the installation, unless other warranty requirements prevail. The warranty period shall begin when the Contractor completes all construction obligations related to this item and when the components for this item have been accepted, which shall be documented as the final completion date in the construction status report. This warranty shall include repair or replace all failed components via a factory authorized depot repair service. All items sent to the depot for repair shall be returned within two weeks of the date of receipt at the facility. The depot location shall be in the United States. The provider of the warranty shall be responsible for all return shipping costs.

The depot maintainer designated for each component shall be authorized by the original manufacturer to supply this service. A warranty certificate shall be supplied for each component from the designated depot repair site indicating the start and end dates of the warranty. The certificate shall be supplied at the conclusion of the system acceptance test and shall be for a minimum of two years after that point. The certificate shall name the Department as the recipient of the service. The Department shall have the right to transfer this service to other private parties who may be contracted to perform overall maintenance of the facility.

BASIS OF PAYMENT

This item shall be paid for at the contract unit price each for CABINET, SYSTEM DETECTOR, MODEL 334; CABINET, RAMP METER, MODEL 334; CABINET, RAMP METER/SYSTEM DETECTOR, MODEL 334. This shall be payment in full for all work and incidental items to install all equipment in the cabinet.

SC09 Controller, Model 2070 Lite

Description: This work shall consist of furnishing and installing a Model 2070 Advanced Transportation Controller (ATC) Lite at locations shown on the Plans, including all necessary hardware and accessories required for use as a 2070 Lite Controller. The 2070 Lite Controller along with its associated components will be part of the ramp metering and vehicle sensing subsystem known as the surveillance system.

Materials: Materials shall be according to the following:

General:

The Model 2070 Lite ATC shall comply with the Caltrans 2002 Transportation Electrical Equipment Specifications (TEES) and meet or exceed the requirements as outlined in the Advanced Transportation Controller Standard Specification by the Joint AASHTO/ITE/NEMA ATC Committee minus the VME chassis.

The Model 2070 Lite ATC unit shall be modular in design and configurable for a variety of traffic management applications. In addition, the Model 2070 Lite ATC shall be compatible with Type 170, 170E, and NEMA specified controller equipment. In addition, the Model 2070 Lite ATC shall mate with Type 170 and ITS style cabinets.

Hardware:

The Model 2070 Lite ATC unit shall consist of a metal housing that is 177mm (7") high by 483mm (19 in) wide by 260mm (10 in) deep and weighs less than 11.3kg (25 lb) with the following components:

- Serial motherboard
- Single 96-pin DIN connectors for plug-in boards
- Liquid Crystal Display (LCD), 8 lines, 40 characters per line, back-light 203 mm (8 in) by 1000 mm (40 in)
- 2 keypads on panel for programming

A plug-on board with two (2) predefined 50-pin connectors shall be provided. The Motorola 68360 microprocessor computer shall be provided with the minimum requirements defined below and will be mounted on the engine board, along with the various crystals and communications circuitry:

- 25 Mhz
- 4MB of DRAM
- 512 KB SRAM
- 4 MB or flash memory

Revised 04/19/06

- 225 K battery-backed SRAM
- Data Key
- Real-time time of day clock

Operating System

The model 2070 Lite ATC shall be capable of running the standard Microware OS-9 operating system as well as multi-tasking and DOS like commands.

Field I/O Modules

The following common features shall be provided:

- 614 K baud data rate to CPU
- Parallel I/O ports – 64 bits each input and 64 output
- SDLC compatible communication with CPU module
- External EIA-485 port connector
- Optically isolated modules to provide protection from lightning and surges

Power Supply

A power supply shall be provided meeting or exceeding the following requirements:

- 10 amps
- Power consumption of 25 to 75 watts typical and 120 watts maximum
- 100 watt quadruple industrial-grade outlet supply
- 50 KHz switching regulator
- Storage system for memory backup without batteries
- Internal safety circuitry senses and measures

The cabinet shall be equipped with two-stage surge suppression, which incorporates both silicon avalanche diode and MOV components and technology. The surge suppression shall be equipped with status and maintenance LED indicators.

Communications Modules

The communications modules shall conform to EIA-232 specifications, and the two leftmost slots on the motherboard shall be made available for dual communications modules.

Miscellaneous features

The following miscellaneous and optional features shall also be provided with the Model 2070 Lite ATC:

- Direct access to serial ports from the application software
- A self-contained independent power supply module
- Input protection
- +5 VDC standby power using capacitor backup

Revised 04/19/06

Safety circuitry to monitor line voltage and output

Environmental

All components shall operate within the following environments:

Temperature and humidity	-37° to +74° Celsius (-35° to +150° Fahrenheit)
Humidity (inside cabinet)	5 to 95%, non-condensing

Application Software

Application software and associated licenses shall be provided with each Model 2070 Lite ATC unit. The application software shall be designed to operate on the Model 2070 controller hardware platform, and shall allow the Model 2070 Lite ATC to continuously control the ramp meters as well as poll and monitor the volume, occupancy and speed of vehicles passing over the detector loops at the locations shown on the Plans. The Model 2070 Lite ATC application software shall then process and communicate this data at the system polling rate of 30 seconds when requested in ASCII character strings to a computer workstation located at the IDOT Traffic Systems Center (TSC). The application software shall also have the following features:

- Diverse programming configuration capabilities
- Support high-speed system communications using NTCIP 1207:2001 protocol
- Allow special software control configurations
- Provide user-definable cabinet input/output function mappings
- Provides easy-to-use menu driven inter-face with spreadsheet style data entry and multi-table parameter database
- Provides security and password protected access
- Provides extensive status information on communications, detector diagnostics, and inputs/outputs
- Generates extensive reports that include the date and time of occurrence on Local Alarm Log, Communications Fault Log, Detector Fault Log, System Detector Log, MOE Log, Speed Log, and Volume Count Log

Construction Requirements:

Installation:

The Model 2070 Lite ATC unit shall be installed and connected inside the Model 334 Cabinet at the locations as shown on the Plans and according to the manufacturer's instructions. The Contractor shall install all cables and ancillary equipment, connecting the Model 2070 Lite ATC to the Ramp Meters and Detectors.

Surge and over-voltage protection shall be installed on all loop lead-in cables and all power conductors.

All cables shall be neatly dressed and labeled with their function and physical connection.

Testing:

The Contractor shall power up the unit and self-test the unit using available software. Applications software shall be uploaded, configured, and validated. This testing shall be accomplished prior to installing the unit in the field cabinet.

After the unit is installed in the cabinet, the Contractor shall apply power and verify the unit is operating correctly. Tests previously used for bench checking shall be repeated and documented.

The Contractor shall test the operation of the 2070 Lite Controller, using CCTV video as ground truth for ramp meter operations and volumes, and a calibrated radar gun for speed. Traffic data produced by the 2070 Lite Controller shall be within 5% of ground truth (actual traffic counts and speeds). A written copy of the test, with supporting videotape, shall be submitted to the Engineer at the end of the test for approval.

Documentation:

Three copies of all operations and maintenance manuals for each Model 2070 Lite ATC unit shall be delivered for each assembly installed. In addition, full documentation for all software and associated protocols shall be supplied to the Department on an 88.9 mm (3.5-inch) floppy disk(s) and a CD-ROM. The Department reserves the right to provide this documentation to other parties who may be contracted with in order to provide overall integration or maintenance of this item.

Warranty:

The Contractor shall warranty all materials and workmanship including labor for a period of two years after the completion and acceptance of the installation, unless other warranty requirements prevail. The warranty period shall begin when the Contractor completes all construction obligations related to this item and when the components for this item have been accepted, which shall be documented as the final completion date in the construction status report. This warranty shall include repair and/or replacement of all failed components via a factory authorized depot repair service. All items sent to the depot for repair shall be returned within two weeks of the date of receipt at the facility. The depot location shall be in the United States. Repairs shall not require more than two weeks from date of receipt and the provider of the warranty shall be responsible for all return shipping costs. The depot maintainer designated for each component shall be authorized by the original manufacturer to supply this service.

A warranty certificate shall be supplied for each component from the designated depot repair site indicating the start and end dates of the warranty. The certificate shall be supplied at the conclusion of the system acceptance test and shall be for a minimum of two years after that point. The certificate shall name the Department as the recipient of the service. The Department shall have the right to transfer this service to other private parties who may be contracted to perform overall maintenance of the facility.

Method of Measurement:

2070 Lite Controller shall be measured for payment by the actual number of the Model 2070 Lite ATC units furnished, installed, tested, and accepted.

Basis of Payment:

Payment will be made at the contract unit price for each CONTROLLER, MODEL 2070 LITE, including all equipment, material, testing, documentation, and labor detailed in the contract documents for this bid item.

SCA1 Capacitor Bank

Description. This item shall consist of furnishing and installing a capacitor(s), equal to Sprague Powerlytic , 36 DX, 12000-200 DC, 8743L 4101, 5 capacitors per assembly at various changeable message sign locations as directed by the Engineer.

This work includes installing in place a Capacitor(s) in existing assemblies at various sites including any miscellaneous wiring, cutting or fitting needed to make a complete and working installation.

Basis of Payment. This work shall be paid at the contract unit price each for CAPACITOR BANK, which price shall be payment in full for all work as described herein and as directed by the Engineer.

SCF1 Clear Facia Sign Panel

Description. This item shall consist of furnishing and installing a Clear Facia Sign Panel, equal to lexan SG 300 at various changeable message sign locations as directed by the Engineer.

This work includes installing in place a Clear Facia Sign panel including any miscellaneous wiring, cutting of fitting needed to make a complete and working installation.

Basis of Payment. This work shall be paid at the contract unit price per square foot each for CLEAR FACIA SIGN PANEL, which price shall be payment in full for all work as described herein and as directed by the Engineer.

SCP1–SCP2 DMS Power Cabinet

Description. This item shall consist of furnishing and installing cabinets of the type and size specified in place complete with meter fitting, all interior components and wiring as specified herein, shown on the Contract Drawings and as directed by the Engineer.

General Requirements. The cabinet with all of its electrical components and parts shall be assembled in a neat orderly fashion. All of the electrical cables shall be installed in a trim, neat, professional manner. The cables shall be trained in straight horizontal and vertical directions and be parallel, next to, and adjacent to other cables whenever possible. The completed controller shall be UL listed as an Industrial Control Panel under UL 508.

Cabinet:

- 3.1 Cabinets shall be of fabricated aluminum supplied in sizes with minimum inside dimensions as listed below.

TYPE	HEIGHT	WIDTH	DEPTH	THICKNESS
E.S.P.2	36"	20"	15"	3/16"
E.S.P. 3	49.5"	30"	17"	3/16"

- 3.2 Cabinets shall be watertight. Doors shall be gasketed to provide a waterproof seal. Bases shall be caulked to obtain a moisture-proof bond. All cabinets shall have Type 2 Corbin brass locks or equal.
- 3.3 Materials shall conform to controller cabinets as listed in the Standard Specifications 1085.47 except that the door shall not have any outside designation nor shall the cabinet door be equipped with a police door or louvers. Post top mounted cabinets, shall have a 1/4" bottom of cabinet welded.
- 3.4 Each cabinet shall have a circuit breaker type panelboard. Panels shall be single phase, 3-wire with separate ground bus and neutral bus with main and branch circuit breakers as indicated on the drawings. The panelboard shall have a NEMA Type 1 enclosure as a minimum.

- 3.5 All cabinets for panelboards, shall be oversized to accommodate panelboard mounted on a NEMA 1 subpanel, electric space heaters, porcelain light fixture, and controls. Ratings of heaters shall be as recommended by the equipment manufacturers and shall be so designed and installed as to not cause any damage to components, wire insulation or cause tripping of circuit breakers from overheating.
- 3.6 Heaters and controls shall be UL listed.
- 3.7 Provide an additional circuit breaker to provide power to the heater, and porcelain base light fixture with a 3-prong 110 volt outlet.
- 3.8 Space heaters with suitable thermostats and humidistat shall be installed in each enclosure to provide against the effects of moisture and low temperatures. The space heaters shall be rated to operate on 120 volts, single phase.
- 3.9 The space heaters shall be controlled from a “HAND-OFF-AUTO” selector switch, thermostat, and humidistat, all wired in parallel in the “AUTO” position and they shall be by-passed in the hand position. The thermostats shall have a 35 degrees F minimum setting. The humidistat range shall be 20 percent to 80 percent, 3 percent differential.
- 3.10 Heaters and controls shall be so arranged and installed to eliminate any exposed live parts thereby preventing any shock hazard.
- 3.11 Each cabinet shall be provided with 100 amp meter socket for ComEd’s meter.
- 3.12 Type III cabinet shall be pad mounted with meter fitting attached to the cabinet.
- 3.13 Type II cabinets shall be pedestal mounted with meter fitting attached to the cabinet. Mounting hardware, post, base, and wiring shall be considered incidental to the item.

4. CIRCUIT BREAKERS

- 4.1 All feeders, branch circuits, and auxiliary and control circuits shall have overcurrent protection. Unless otherwise indicated, the overcurrent protection shall be by means of circuit breakers.
- 4.2 Unless otherwise indicated, circuit breakers shall be standard UL-listed molded case, thermal-magnetic bolt-on type circuit breakers with trip-free indicating handles.
- 4.3 Unless otherwise indicated, circuit breakers shall have a UL-listed interrupting rating of not less than 10,000 ms symmetrical amperes at rated circuit voltage for which the breaker is applied.
- 4.4 Multi-pole circuit breakers larger than 100 ampere size shall have adjustable magnetic trip settings.
- 4.5 The number of branch circuit breakers shall be as indicated on the Control Cabinet detail drawing.

5. WIRING AND IDENTIFICATION:

- 5.1 Unless otherwise indicated, power wiring within the cabinet shall be of the size specified for the corresponding service conductors and branch circuits and shall be rated RHH/RHW, 600 volts.
- 5.2 Unless otherwise indicated control and auxiliary circuit wiring shall be rated RHH/RHW or MTW with jacket. 600 volts

- 5.3 Unless otherwise indicated, all power and control wiring shall be tagged with self-sticking cable markers and shall be standard copper. If the contract drawings do not specifically indicate assigned wire designations, the manufacturer shall assign wire designations and indicate them on the shop drawings.
- 5.4 All switches, controls and the like shall be identified both as to function and position (as applicable) by means of engraved 2-color nameplates attached with screws, or where nameplates are not possible in the judgment of the Engineer, by the use of cloth-backed adhesive labels as approved by the Engineer.

6. INSTALLATION

- 6.1 Installation shall conform to applicable portions of Section 863 of the Standard Specifications.
- 6.2 Cabinets, cabinet posts and cabinet pedestals shall be primed and painted in accordance with the TSC Specification T712#1. The final coat color shall be as specified by the TSC at the time of the pre-construction meeting. Interior of all cabinets shall be painted high gloss white.
- 6.3 All cabinets and wiring entering a cabinet shall be dressed, harnessed, tied, laced and clamped to produce a workmanlike wiring installation.
- 6.4 All power cables shall be labeled with a Panduit type cable tag. The tag will identify the type of cable and the destination.
- 6.5 A copper ground bus shall be mounted on the rear wall of the cabinet.
- 6.6 Each cabinet shall contain a wiring diagram of the installation in addition to the diagrams which are to be submitted to the Engineer.
- 6.7 Prior to the wiring of the cabinet, the Contractor shall submit a box print for approval before cabinet wiring shall begin.
- 6.8 The Contractor shall furnish three (3) diagrams of the internal and external connections of the equipment in each cabinet. He shall furnish the operating and maintenance instructions for all equipment supplied. One copy of the wiring diagram for each cabinet shall be retained in each field cabinet. Wiring diagram shall be contained in a plastic pouch that shall be permanently mounted to the door of each cabinet. Contractor shall permanently mark the cabinet for each termination.
- 6.9 Cable harnesses, terminal boards, and mounting hardware shall be installed as needed.

Method of Measurement. Cabinets will be accepted as concrete foundation mounted, pole mounted, pedestal mounted, or attached to structure. Each cabinet installed complete and in place will be counted as a single unit.

Basis of Payment. This work will be paid at the contract unit price (each) for DMS POWER CABINET, size specified, installed complete and in place.

SCP1 DMS POWER CABINET TYPE 2 WITH METER

SCP2 DMS POWER CABINET TYPE 3 WITH METER

SD01 Detector Loop Sensor Unit, Four Channel Digital

Description. This item shall consist of furnishing and installing a four (4) channel digital loop detector sensor unit in an existing cabinet at the location and as directed by the Engineer.

The sensor unit shall operate on a regulated 117 VAC. The sensor unit shall be of solid state design throughout. Each sensor unit shall include two or four complete loop detector channels.

The loop connected to each of the four or two channels shall be sequentially scanned at a rate of not less than 148 times per second. Only one loop shall operate at a time in the system to eliminate cross-talk.

The digital loop sensor shall be automatically and instantaneously self-tuning requiring no burn-in or warm-up time. Then it shall also track environmental changes.

The digital sensor unit shall be self-tracking and fully automatic in its recovery from power failure.

The digital sensor unit shall be of sufficient sensitivity to detect the smallest licensable motor vehicle, including motorbikes. The sensor unit shall detect a Honda CT-170 and hold the detection for a minimum of four minutes.

The sensor unit shall be designed to operate in conjunction with three turns of a loop wire imbedded up to three inches deep in a reinforced concrete roadway.

The loop and lead-ins will measure at least 100 megaohms above ground and have a minimum inductance of 50 microhenries and a maximum of not more than 5 ohms. Digital sensor unit shall be capable of tuning to an inductance of 50 microhenries and a maximum of not more than 5 ohms. Digital sensor unit shall be capable of tuning to an inductance range of 0 to 2000 microhenries.

Vehicle detection shall be indicated by a single optically insulated solid state output per channel.

Output circuit shall be an optically coupled output, which uses a coupled photo transistor. It shall be capable of switching 50 milliamperes with less than 0.7 volts drop and shall tolerate 30 volts when off.

Polarity of interface between telemetry and sensor unit must be observed.

Any size or type of motor vehicle from motorcycle to a high bed tractor-trailer moving over the loop shall be detected and each vehicle shall produce only one output for length of time the vehicle is over the loop.

Detection shall be positive for all vehicle speeds 0 to 80 miles per hour.

The sensor unit shall be capable of reliable operations when placed up to 1000 feet away from loops and connected with Canoga 30003 or equal, stranded copper wire.

The loops will vary in size from 5 feet by 6 feet up to 18 feet by 6 feet. Loop system with 100 feet of lead-in shall perform with sensitivity to detect and hold the smallest motorbike.

Detection shall not be affected by weather conditions nor shall a false detection be caused by a sudden rainstorm nearby lighting or erratic change in temperature of the sensor unit shall be from -30 degrees C to +60C. The sensor unit shall be so designed that it will be stable in operation over a very high drift range and over the entire temperature range and environmental changes. The sensor unit shall have built-in lightning protection for each channel.

Each detection channel shall have its own output indicator lamp and switch. The switch shall provide eight sensitivities, .0025% to .33% and 3 modes; off, pulse, and presence. In the pulse mode each new vehicle shall produce and output pulse of 225 millisecond duration. A vehicle remains on a loop for more than two seconds shall be "tuned out" allowing operation of the loop to other vehicle.

In the presence mode output duration shall be equal to the percent of time the vehicle is present on the loop. Vehicle detection and hold times shall not be less than 30 minutes.

Electrical connection from the sensor unit to incoming and outgoing circuits shall be made by one MS type multiple positive connection plug and jack, or equivalent arrangement, to permit rapid replacement with similar existing units without disconnecting or reconnecting individual wires.

All tuning adjustments shall be made with controls provided on the sensor unit without requiring movement of the sensor unit. These controls shall be identified and it shall not be necessary to remove or change wires or contacts nor to use any tools other than a screwdriver in tuning or making sensitivity adjustments.

A properly tuned sensor unit shall detect all high vehicles (truck with chassis 4 feet above pavement) with one contact closure and yet shall not detect vehicles passing in lanes adjacent to loop installation.

All transistors shall be silicon types. The main logic of the unit shall be a single MOS-LS1 chip to simplify the electronics, increase reliability and improve maintainability. All IC chips will be socketed.

The sensor unit shall be contained in a rigid high quality metal enclosure providing complete protection to all components and electrical connections.

During normal detection operation the state of the output indicator shall correspond exactly to the state of the output.

A frequency switch shall be provided to raise or lower the loop oscillator frequency for the elimination of cross-talk between sensor unit, should it ever occur.

The digital sensor unit shall be provided with a circuit breaker.

Special circuitry shall be provided so that the sensor unit shall continue in proper operation even though the induction loop is shorted or leaking to the ground.

Induction loops shall be coupled to a transformer to provide for rejection of induction loop lead-in cable noise and shall allow low inductance operation (0 to 50 microhenries).

A reset shall be provided to reset all channels.

There shall be a write-on pad mounted on sensor to identify traffic lane with channel indication.

Basis of Payment. This item shall be paid at the contract unit price each for DETECTOR LOOP SENSOR UNIT, FOUR CHANNEL DIGITAL, channels specified, furnished and installed, operating and completely in place. Terminal boards, cable harness wiring and miscellaneous will not be paid separately, but shall be considered as incidental to the cost of the item.

SD02 Detector Loop Sensor Unit, Two Channel Digital

Description. This item shall consist of furnishing and installing a two (2) channel digital loop detector sensor unit in an existing cabinet at the location and as directed by the Engineer.

The sensor unit shall operate on a regulated 117 VAC. The sensor shall be of solid state design throughout. Each sensor unit shall include two or four complete loop detector channels.

The loop connected to each of the four or two channels shall be sequentially scanned at a rate of not less than 148 times per second. Only one loop shall operate at a time in the system to eliminate cross-talk.

The digital loop sensor shall be automatically and instantaneously self-tuning requiring no burn-in or warm-up time. Then it shall also track environmental changes.

The digital loop sensor unit shall be self-tracking and fully automatic in its recovery from power failure.

The digital loop sensor unit shall be of sufficient sensitivity to detect the smallest licensable motor vehicle including motorbikes. The sensor unit shall detect a Honda CT-170 and hold the detection for a minimum of our minutes.

The sensor unit shall be designed to operate in conjunction with three turns of a loop wire imbedded up to three inches deep in a reinforced concrete roadway.

The loop and lead-ins will measure at least 100 megohms above ground and have a minimum inductance of 50 microhenries and a maximum of not more than 5 ohms. Digital sensor unit shall be capable of tuning to an inductance range of 0 to 2000 microhenries.

Vehicle detection shall be indicated by a single optically insulated solid state output per channel.

Output circuit shall be an optically coupled output, which uses a coupled photo transistor. It shall be capable of switching 50 milliamperes with less than 0.7 volts drop and shall tolerate 30 volts when off.

Polarity of interface between telemetry and sensor unit must be observed.

Any size or type of motor vehicle from motorcycle to a high bed tractor trailer moving over loop shall be detected and each vehicle shall produce only one output for length of time the vehicle is over the loop.

Detection shall be positive for all vehicle speeds 0 to 80 mph.

The sensor unit shall be capable of reliable operations when placed up to 1000 feet away from loops and connected with Canoga 30003 or equal, stranded copper wire.

The loops will vary in size from 5 feet by 6 feet up to 18 feet by 6 feet. Loop system with 100 feet of lead-in shall perform with sensitivity to detect and hold the smallest motorbike.

Detection shall not be affected by weather conditions nor shall a false detection be caused by a sudden rainstorm nearby lighting or erratic change in temperature of the sensor unit shall be from -30C to +60C. The sensor unit shall be so designed that it will be stable in operation over a very high drift range and over the entire temperature range and environmental changes. The sensor unit shall have built-in lightning protection for each channel.

Each detection channel shall have its own output indicator lamp and switch. The switch shall provide eight sensitivities, .0025% to .33% and 3 modes; off, pulse, and presence.

In the presence mode output duration shall be equal to the percent of time the vehicle is present on the loop. Vehicle detection and hold times shall not be less than 30 minutes.

Electrical connection from the sensor unit to incoming and outgoing circuits shall be made by one MS type multiple positive connection plug and jack, or equivalent arrangement, to permit rapid replacement with similar existing units without disconnecting or reconnecting individual wires.

All tuning adjustments shall be made with controls provided on the sensor unit without requiring movement of the sensor unit.

These controls shall be identified and it shall not be necessary to remove or change wires or contacts nor to use any tools other than a screwdriver in tuning or making sensitivity adjustments.

A properly tuned sensor unit shall detect all high vehicles (truck with a chassis 4 feet above pavement) with one contact closure and yet shall not detect vehicles passing in lanes adjacent to loop installation.

All transistors shall be silicon types. The main logic of the unit shall be a single MOS-LS1 chip to simplify the electronics, increase reliability and improve maintainability. All IC chips will be socketed.

The sensor unit shall be contained in a rigid high quality metal enclosure providing complete protection to all components and electrical connections.

During normal detecting operation the state of the output indicator shall correspond exactly to the state of the output.

A frequency switch shall be provided to raise or lower the loop oscillator frequency for the elimination of cross-talk between sensor unit, should it ever occur.

The digital sensor unit shall be provided with a circuit breaker.

Special circuitry shall be provided so that the sensor unit shall continue in proper operation even though the induction loop is shorted or leaking to the ground.

Induction loops shall be coupled to a transformer to provide for rejection of induction loop lead-in cable noise and shall allow low inductance operation (0 to 50 microhenries).

A reset shall be provided to reset all channels.

There shall be a write-on pad mounted on sensor to identify traffic lane with channel indication.

Basis of Payment

This item shall be paid at the contract unit price each for TWO (2) CHANNEL DIGITAL LOOP DETECTOR SENSOR UNIT, channels specified, installed, operating and completely in place.

Terminal boards, cable harness wiring and miscellaneous will not be paid separately, but shall be considered as incidental to the cost of the item.

SD03 Detector Loop Round, Square, or Rectangular

Description. This item shall consist of furnishing, installing and testing an induction loop, of the dimensions shown on the plans or of the dimension from Table 1, at the locations shown. The induction loop shall be installed in accordance with all applicable portions of article 847 of the standard specification for Road and Bridge. All saw cutting, cable installation, joint sealing, lead-ins and testing necessary to complete the installation shall conform with the following requirements.

Materials. The cable used for induction loop shall be No 14-7 strand XHHW XLP-600V. Encased in orange Detect-duct tubing as manufactured by Kris-Tech Wire Company, or comparable. Lead-ins shall be Conoga 30003 or equal cable.

Joint sealer (Dozseal 230) shall have sufficient strength and resiliency to withstand stresses set up by vibrations and differences in expansion and contraction due to temperature changes. Adhesion to clean dry, oil-free Portland Cement concrete shall be at least equal to the tensile strength of the concrete. The joint sealer, with qualities described above, shall be capable of curing in a maximum time of 30 minutes at all temperatures. Curing shall be defined as the capability of withstanding normal traffic loads without degradation.

Installation Details. Slots in the pavement shall be cut with a concrete sawing machine in accordance with the applicable portions of Section 420.10 of the Standard Specifications for Road and Bridge Construction. The slot must be clean, dry, and oil-free. Wire shall be inserted in the pavement slot with a blunt tool which will not damage the insulation and wedges made of loop tubing “Deteca-duct” will be installed at eighteen (18) inch intervals to keep new loops from floating. Loops should not be installed at an outside temperature below 50F (10C) degrees unless directed by Engineer.

Plastic sleeving shall be used to insulate the wire where loop wire crosses cracks and joints in the pavement. The sleeving shall be properly sealed with electrical tape to prevent joint sealer from entering sleeves. Sleeving shall extend a minimum of 8 inches each side of joint.

All mainline loops shall be round, six(6) feet in diameter, and centered in traffic lanes unless designated otherwise by the Engineer.

The Contractor shall core drill a six foot diameter round induction loop. The width of the drill portion shall be .500", the depth shall be a maximum of 2.75". A saw cut (home run) .375 in width and the same depth as the drilled portion shall be cut to the core hole. The core hole will be a minimum 2 ½" diameter and drilled to a depth to meet the installed P-duct. At the point where the 6' diameter loop intercepts the straight cut (home run) the wire leaving the loop will have a minimum of a 1.5" radius entering the straight cut. Interception point of home run slot and round loop shall not be cored.

Induction loops on exit and entrance ramps as well as speed/count stations shall be square or rectangular with edges perpendicular or parallel to traffic flow. Induction loops shall be centered on all ramps and in traffic lanes unless designated otherwise on the plans or by the Engineer. Traffic lanes shall be referred to by number and loop wire shall be color-coded and labeled accordingly.

A chart, which shows the coding for each installation, shall be included in each cabinet. No core holes shall be allowed at corner of any loop. Sawcuts for all induction loops and lead ins shall not be greater than 2.75 inches in depth.

All excess joint sealer shall be removed so that the level of the sealer in the saw cut is at the same level as the adjoining pavement.

All excess joint sealer shall be removed so that the level of the sealer in the saw cut is at the same level as the adjoining pavement.

All induction loops shall contain a minimum three (3) turns of No. 14 wire. Each induction loop shall have its own Canoga 30003 or equal home run or lead-in to the cabinet. Induction loops shall not be connected in series with other loops. This wire shall be free from kinks or any insulation abrasions. The loop lead-in shall be barrels sleeved, crimped, soldered and protected by heat shrinkable tubing to the loop #14 wire. Lead-ins shall be placed in such a manner that they take the most direct route to the cabinet.

Lead-in cable Canoga 30003 or equivalent will only be installed where the lead in length from point of interception to the point of termination exceeds 150 feet (45.75m).

Where lead-in runs are less than 150 feet (45.75m), the loop wire will be utilized as lead-in to the point of termination w/o splices, being twisted 5 turns per foot (304.8mm). The loop wire will be paid as "lead-in" from last point of saw cut in pavement at dive hole to point of termination in cabinet.

Loop lead-ins placed in handholes shall be coiled, taped and hung from hooks on the sides of the handhole to protect against water damage. Any other method of installation will require prior written approval of the Engineer. Each loop lead-in shall be color coded and tagged at the core hole, in each junction box it passes through and at the termination point in the cabinet.

Slots shall be cut so that no bends greater than 50 degrees is used. Diagonal saw cuts (a minimum of twelve (12) inches (304.8mm) in length) shall be used at all corners to conform with this specification. Core hole at corner or cracks shall not be allowed. The Engineer shall be contacted regarding proposed changes in loop locations necessitated by badly deteriorated pavement. The Engineer may relocate such loops. copper wire and lead-ins shall not be installed in the curb and gutter section or through the edge of pavement. A hole shall be drilled at least 12" (304.8mm) in from the edge of pavement through which the P-duct, loop wire and lead-in shall be installed. Saw cuts through shoulders to core hole shall not be allowed. loop lead-ins shall not be allowed in saw cuts in shoulders.

Ramp Loop Table (1)

<u>W (FT.) (m)</u>	<u>S (FT.) (m)</u>
12 3.7m	8 2.4m
13 4.0m	9 2.8m
14 4.3m	10 3.1m
15 4.6m	11 3.4m
16 4.9m	12 3.7m
17 5.2m	13 4.0m
18 5.5m	14 4.3m
19 5.8m	15 4.6m
20 6.1m	16 4.9m
21 6.4m	17 5.2m
22 6.7m	18 5.5m
23 7.0m	19 5.8m
24 7.3m	20 6.1m
25 7.6m	21 6.4m

*EXAMPLE: Where lane width (W) is 12' (3.66m), loop width(s) shall be 8' (2.44m),
 Length of loop shall be determined by location.

Should the induction loop and/or core hole for the induction loop and loop lead-in cable be paved over by other construction operations, it shall be the contractor's responsibility for locating and finding the induction loop and/or the core hole for the repair of a bad loop or lead-in or for the installation of a new loop or loop lead-in. The locating of the core hole and the induction loop shall be incidental to the cost of the induction loop lead-in installation.

Traffic Systems Center
 Loop Splicing Requirement

<u>Mainline Loops</u>	<u>Metering Loops</u>	<u>Speed Count</u>
Lane 1 - Blue	Loop 1 - Green - Input Loop	Lane 1 - Blue
Lane 2 - Brown	Loop 2 - Yellow - Demand Loop	Exit-Black
Lane 3 - Orange	Loop 3 - Red - Passage loop	Lane 2 - Brown
Lane 4 - Violet		Entrance-White
Lane 5 - Slate		Lane 3 - Orange
		Lane 4 - Violet

Lane 1 being the left lane in direction of traffic flow for mainline and ramps.

When 2 or 3 loops are installed on an exit or entrance ramp the loop color code shall conform to the mainline loop color code and shall be marked as entrance or exit ramp loops.

Only Speed/Count Station loops both square and rectangle shall be color coded and tagged by lane per specific locations as noted on plans, or as directed by the Engineer.

In addition to color codes each loop shall be identified with a written label attached to the loop wire, or lead-in wire. The tags shall be Panduit #MP250W175-C or equivalent. All wires and cables shall be identified in each handhole or cabinet the cable passes through, or terminates in. The labels shall be attached to the cable by use of two cable ties.

An electronic test instrument capable of measuring large values of electrical resistance such as a major megger, shall be used to measure the resistance of the induction loop and its lead-in shall be a minimum of 500 megohms above ground under any conditions of weather or moisture. The loop and the loop lead-in shall have an inductance between 50 microhenries and 1000 microhenries. The continuity test of the loop and loop lead-in shall not have a resistance greater than five (5) ohms. Testing shall be done with the required loop tester.

Loop wire and lead-ins shall not be installed in the curb and gutter section or through the edge of pavement. A hole, 2-1/2" shall be drilled at least 12" in from the edge of pavement through which the P-Duct, loop wire, and lead-in shall be installed.

Method of Measurement. A loop is considered by lineal feet plus lead-in into the dive hole.

Basis of Payment. This work shall be paid at the contract unit price per lineal foot for DETECTOR LOOP ROUND, SQUARE, OR RECTANGULAR of the size, number and type as specified, which shall be payment in full for the work described herein. The contract shall be paid lineal feet for the loop, plus the lineal footage for the home run straight cut to the core hole. The cost of expressway lane closure and miscellaneous cost shall be incidental.

SDC1 Dome Camera

Description: This item shall consist of furnishing and installing a Dome Day/Night Camera. This work shall include installing in place a Dome Day/Night Camera as specified here in including any miscellaneous wiring, cutting or fitting needed to make a complete working installation.

Dome Camera

General requirements: Day/night system, outdoors pendant system, integral 1/6-inch high resolution, color/monochrome CCD camera, pan/tilt, and receiver/driver system, architectural and engineering specification.

The product described in this specification is the dome camera day/night system. The dome camera shall be a 160mm (6.3-inch) domed camera system containing a 1/6-inch image format, high resolution, CCD camera with an 25:1 auto-iris, auto-focus zoom lens, a high-speed pan/tilt, and an intelligent integral receiver/driver. The Envirodome day/night is available with a color/monochrome camera module.

This product shall be manufactured by a firm whose quality system is in compliance with the I.S./ISO 9001/EN 29001, QUALITY SYSTEM.

Overall system:

The dome camera is a variable/high-speed, domed camera system consisting of an integral 1/6-inch, high resolution, CCD camera with 25x (2.4 mm to 60 mm) optical zoom lens, pan/tilt, receiver/driver, and integral housing with power supply.

The camera system is comprised of the following components, pre-assembled in an outdoor pendant housing: (1) Camera and lens with covert inner liner, pan/tilt, and receiver/driver; (2) Backbox/power supply module; and (3) 160 mm (6.3-inch) dome module (4) Pole mount adaptor

The camera system shall be compatible with the existing TSC switcher/controller.

The camera system shall allow address setting remotely or directly via the four digit thumbwheel on the unit.

The camera system shall accept Bi-phase and RS-232 data formats.

Camera:

The following camera parameters may be remotely set or adjusted from the main control site:

AGC

Zoom

Auto/manual focus and iris control

Backlight compensation

Auto pan speed

The camera shall provide continuous auto-focus and auto-iris zoom lens functions that can be manually overridden by depressing their respective buttons on the system controller keyboard.

Pan/Tilt:

The dome camera shall contain an integral 360° pan/tilt. This variable speed pan/tilt shall be capable of operating in the manual mode to speeds up to 120° per second.

The dome camera system will store up to 99 preposition shots and seek any of those preposition shots at the speed of 360° per second at an accuracy of ± 0.5 degrees²

The dome camera can be activated to autopan between two electronically set limit stops. The dome camera system provides a pivot feature that automatically rotates the camera to simplify tracking of a person walking directly under the dome.

The dome camera shall include auto scaling, allowing precise camera movement at all zoom settings.

The dome camera shall provide an auto playback (Guard Tour) feature, which will duplicate the exact control functions as programmed by the operator. The playback mode may be selected to operate one time or set to continuously repeat. Two tours are available with a total duration of 15 minutes.

The dome camera shall provide 16 programmable on-screen sector titles with 16 character title for each sector and each preset position.

Housing:

The dome camera housing shall be a 9.625-inch (244.48mm) outdoor, pendant-mounted dome housing, with integral sunshield.

The housing shall allow for 360 degree viewing.

The housing shall meet IP66 (NEMA 4) sealing requirements.

The housing shall be supplied with an internal heater and blower for environmental applications.

The housing shall be available with clear or light-tinted lower dome capsules.

The top of the housing shall provide mechanical and electrical connection points for the dome camera.

The pole and wall mount models shall allow camera cabling to pass through the mount's tubular body.

Electrical specifications:

Imager: Interline transfer CCD, 1/6-inch format, 752 H x 582 V active picture elements (NTSC), 752 H x 697 V active picture elements (PAL).

Horizontal Resolution: 470 TVL (typical).

Video Output: 1.0 Vp-p \pm 0.1 Vp-p, 75 ohms.

Scene Illumination:

Usable Picture (f/1.6):

Frame integration off: day mode: .5 lux (.05 fc), night mode: .031 lux (.0031 fc)

Frame integration on: day mode: .031 lux (.0031 fc), night mode: .004 lux (.0004 fc).

Signal to Noise Ratio: 50 dB minimum.

White Balance: 2000 to 10,000 K.

AGC: 18 dB maximum gain.

Supply Voltage:
EIA RS-170/NTSC models 120 VAC, 60 Hz
CCIR/PAL models: 230 VAC, 50 Hz.

Power Requirement at supply voltage:
Camera: 20 watts maximum
Heater: 30 watts maximum
Total: 50 watts maximum.

Mechanical specifications:

Connectors:
Video Out: BNC
Data In: Terminal block
Power: Terminal block.

Lens Focal Range: 2.4 to 60 mm.

Angle of view: 45.0° (wide, no zoom), 2.0° (tele, full zoom).

Pan range: 0° to 360° continuous.

Tilt Range: 0° to 90° from horizontal plane.

Pan/Tilt speed: variable to 120°/second in manual mode, 360°/second in preposition seek mode.

Preposition Accuracy: $\pm .5^{02}$.

Overall dimensions: 244.48 W x 324.36 H mm (9.625 W x 12.77 H in).

Weight: 5.9 kg (13 lb.).

Construction: Cast aluminum

Finish:
Pendant Housing: Powder-coated white.
Camera liner: Black
Dome capsule: Clear.

Environmental Specifications:

Operating Temperature: -40° C to +50° C (-40° F to + 122° F)
Storage Temperature: -40° C to +60° C (-40° F to + 140° F).
Humidity: 0% to 90% relative, non-condensing.
The housing shall be designed to meet NEMA-4, IP65 specifications.

Agency Approvals:

EMC Requirements: CE Immunity, CE Emission Class A, FCC Class A.

1. Safety: CE, UL, cUL.

Wiring Devices

Provide 2 additional 20A, 120V, single phase 3-wire duplex receptacle in each surveillance cabinet

Cables

- 1 Coaxial cables shall have a 75 ohm nominal impedance and are 100% factory sweep tested, 5 to 450 MHz by the structural return loss method.
- 2 CCTV video distribution RG 59/U, Cellular polyethylene dielectric base copper braid shield with 95% minimum shield factor, No. 22 AWG standard copper conductor, and PVC jacket.
- 3 CCTV coaxial cable connectors shall be BNC, 75 ohms.
- 4 Data control cable shall be shielded no. 22 AWG or as recommended by the Camera manufacture.

Video and Data Suppression

- 1 The video suppression shall be equal to or exceed polyphaser model IS-75bb base band coaxial protector or as recommended by the camera manufacture.
2. The data line suppresser for camera controls shall be equal to or exceed Polyphaser Model ID-SPDDL.

Basis of Payment. This work shall be paid for at the contract unit price each for Dome Cameras, which price shall be payment in full to furnish and install, and for all work as described here in and as directed by the Engineer.

SE01 Electric Service Upgrade and Grounding

Description. The Contractor shall perform the electric service and grounding modification as specified to surveillance locations as designated by the Engineer. (This work is for additional locations, over and above the 50 locations to be upgraded under routine maintenance).

Work Description. The contractor is responsible for scheduling the work and for coordinating with the engineer whenever Engineer-witness functions are required. The Contractors shall also advise the engineer when each location is complete and shall provide a written certification to that effect. The Engineer reserves the right to require a final inspection of the modification at any or all of the locations certified as complete. Should deficiencies be found upon inspection, a corrective work list will be prepared.

The surveillance installations being modified shall be kept operational at all times except as expressly allowed herein or otherwise permitted by the Engineer. The Contractor shall be responsible for all traffic control and temporary provisions required for the work, all at no additional cost to the pay item. All cable, conduit, fittings and accessories shall be new. All materials and work shall be in conformance with the requirements of applicable contract specifications and article 250 of the National Electrical Code.

The Contractor shall be responsible for coordination with the Electric Utility as necessary and shall be responsible for reporting any account modifications arising from the work to the Engineer in a timely manner. Although it is anticipated that all service agreements and accounts will remain as-is, if new agreements are required, the Contractor shall facilitate coordination between the Electric Utility and the Engineer, with the Department to sign any appropriate new agreements.

The work will generally include:

- Replacement of the electric service entrance equipment and cables
- New grounding of the service

- New feeder conductors from the service disconnect to the controller cabinet
- Cabinet grounding modifications
- Supplementary ground electrodes at handholes
- Extension of equipment ground wires to all poles, posts, handholes, etc.
- Bonding of equipment ground to all exposed metal parts
- Testing and documentation

Replace Electric Service Entrance

The work shall include the removal of the existing service disconnecting means and the service conductors and shall include the furnishing and installing a new pole-mounted or pedestal-mounted service disconnecting means and new service conductors, based on the manner of the existing service. The new electric service disconnect, cables and the service connection shall be in accordance with details included herein. Unless otherwise indicated, the pole-mounted electric service box provided for these installations shall be Type B1 (equipped for 240/120 V. – 2 W service), shown in Figure L-3A, Volume 1, Article 7, page 20, unless specified otherwise by the Engineer to meet special requirements of certain locations.

Provide New System Ground of Electric Service

The work shall include the installation of a new system ground, connected to the ground bar of the service disconnect, using one or more ground rod grounding electrodes, or other means approved by the Engineer. The system ground shall have a resistance to earth not to exceed 10 ohms without connection to the additional electrodes established at poles or other points at the surveillance/CMS signal location. The system ground resistance shall be verified by a contractor test, using the fall-of potential method and witnessed and approved by the engineer, with a record of the test entered by the Contractor and signed by the Contractor and the Engineer. Should more than one electrode be required to establish a low enough resistance, additional electrodes shall be connected to the grid, with re-testing. All ground electrode connections shall be exothermically welded. Ground rods and grounding electrode conductors shall be as specified and detailed.

The service grounded circuit conductor (which may or may not be a system neutral) shall be bonded to the system ground at the service disconnect and shall be isolated from ground throughout the remainder of the electrical distribution.

Extend New Conductors to Controller

A new ground terminal bar shall be installed at the surveillance cabinet and this bar shall be bonded to the cabinet enclosure. The work shall include the replacement of the existing feeder and the extension of new feeder conductors from the service disconnect to the surveillance cabinet. The cable will be a multi-conductor jacketed cable as specified and it shall include a green-insulated ground wire to bond the service ground bar to the controller cabinet ground bar. The Contractor shall confirm the integrity of the existing feeder conduit run, and shall clean the run before installing the new feeder. If the size of the conduit is demonstrated to be inadequate for the new feeder cable or if it is demonstrated as not re-usable for some other reason and no other alternative is feasible, the contractor shall use a new feeder conduit run, as part of this pay item, with all cable work remaining as the Contractor's responsibility at no additional cost to the pay item.

Cabinet Grounding Modifications

The Contractor shall confirm the presence of a terminal bar, with suitable terminals, for the grounded circuit conductor (white wire) at the controller cabinet and shall assure isolation of this bar from the cabinet enclosure and other grounded parts. If the existing bar is inadequate or is not isolated properly, the Contractor shall provide a new bar or otherwise correct the installation, removing any incorrect items. Similarly, the Contractor shall confirm the presence of a ground bar, with suitable terminals, which is bonded to the cabinet enclosure and grounded metal parts. If the existing ground bar is inadequate or is not bonded properly, the Contractor shall provide a new bar or otherwise correct the installation, removing any incorrect items.

Extension of Equipment Ground

The Contractor shall extend an equipment ground conductor from the ground bar in the controller cabinet to distributed elements of the system, bonding the equipment ground conductor to all handhole frames, metal poles and other enclosures, metal conduit, etc., including any existing supplemental ground rods that may be in place. The Contractor

shall assure that good equipment ground continuity and a low-impedance ground return path is established throughout for all exposed metal parts of the installation.

It is not the intent of this work item to require re-cabling of the surveillance load equipment to achieve grounding. In all cases, a green-insulated ground conductor shall be used whenever possible, and only if conduit space will not accommodate an insulated conductor will a bare conductor be allowed. A common conductor may be employed for multiple load circuit cables in a given conduit, but an equipment ground conductor shall be run with or shall encircle each set of circuit conductors extended from the controller cabinet.

Recognizing the intent to leave existing conductors in place and operations, the contractor may chose from among identified and prioritized acceptable alternative to affect the grounding modifications:

If an existing conduit will accommodate the installation of a ground wire, the ground wire shall be installed within the conduit with the circuit conductors. Existing conductors should only be withdrawn from a conduit run to facilitate pulling of the ground wire if absolutely necessary.

If an existing metal conduit will not accommodate the required ground wire, and if the Contractor can identify end-to-end electrical continuity of the conduit, the Contractor may bond to the conduit externally in an approved manner to establish ground continuity, thus using the metal conduit as the equipment ground conductor.

If a given conduit run is demonstrated to be damaged and electrically discontinuous in the presence of the Engineer, and if no other alternative is feasible, the Engineer will authorize a new conduit run, to be paid under separate pay item, with all cable installation to remain part of the grounding modification work at no additional cost to the pay item. When a new conduit is installed, an insulated ground conductor must be installed within, together with the circuit conductors, regardless of the ground continuity of the new conduit, and the new conduit shall be appropriately bonded to the equipment ground.

Bonding

The Contractor shall establish equipment ground bonding to the cover frame of every handhole with an approved connection. The contractor shall establish equipment ground bonding at every metal pole, post or other enclosure or device, also with an approved connecting. At poles or post bases, it may be possible to install washers, lugs, and extra nuts where extra anchor bolt protrusion allows it. Otherwise, poles may be drilled and tapped and fitted with appropriate ground lugs. Connections at poles and other enclosures shall be pigtailed from splices whenever more than one ground conductor is connected so that ground continuity is not dependent upon ground lug connection. Splices of ground conductors (in lieu of exothermic weld connectors) will be permitted at poles an other such connection point above grade, with splices to be made using suitable copper crimp sleeves and heat-shrink insulated caps as specified.

Testing and Documentation

As noted above, the system ground resistance to earth shall be tested, in isolation from equipment ground extensions from that point. Testing shall be performed by the Contractor using the fall-of-potential method, with results recorded by the Contractor and witnessed by the Engineer. Ground continuity shall be tested using an approved low-impedance ohmmeter, to the farthest point of each circuit extension from the controller cabinet. Results shall be recorded by the contractor and witnessed by the Engineer.

Method of Measurement. Each additional surveillance grounding and service upgrade performed as specified and inspection report submitted and approved by the Engineer shall be counted as a unit for payment.

Basis of Payment. This item shall be paid at the Contract unit price each for ELECTRICAL SERVICE UPGRADE AND GROUNDING, which shall be payment in full for the work described herein.

SE02 Electrical Cable in Conduit, 4C/ No. 18 Shielded Loop Detector

Description. This work shall consist of furnishing materials and labor for installation of shielded loop detector cables in conduit as specified herein and indicated by the Engineer, complete with all identification, terminating and testing.

General

Lead-ins shall be Conoga 30003 or equal cable. The jacket of high density polyethylene shall be rated to 600 volts in accordance with UL 83 Section 36.

All cables shall be UL listed.

Unless otherwise indicated all cable shall be rated 600 volts.

The cable shall be rated 90 degrees C. dry and 75 degrees C. wet and shall be suitable for installation in wet and dry locations, exposed to the weather, and shall be resistant to oils and chemicals.

The UL listing mark, cable voltage, insulation type and ratings, as well as the cable size shall all be clearly printed on the cable in a color contrasting with the insulation color.

Conductors:

Conductors shall be #18 awg 7X.0152” un-coated copper.

Conductors shall meet the requirements of ASTM Designation B-8 as applicable.

Unless otherwise indicated, all conductors shall be stranded and twisted 4 turns per foot.

The cable shall be an assembly of pairs of left hand lay twisted insulated conductors, with a core filled with a petroleum base flooding compound, overlapped conductive tape shield and a black high density polyethylene jacket overall. This cable shall meet the requirements of IEEE Standard 383.

Insulation:

The conductors shall be coded as follows: black-red-white-green

Cable insulation shall incorporate polyvinyl chloride (PVC) with a clear nylon covering overall as specified and the insulation shall meet or exceed the requirements of ICEA S-61-402, NEMA Standard Publication No. WC-5, UL Standard 83, as applicable.

Unless otherwise indicated, cable conductors shall be solid full color coded via insulation color.

Quality Control:

Submittal information shall include demonstration of compliance with all specified requirements.

All cables shall be delivered to the site in full reels. Cable on the reels shall be protected from damage during shipment and handling by wood lagging or other means acceptable to the Engineer. Reels shall be tagged or otherwise identified to show the UL listing.

Installation. The loop lead-in shall be a Canoga 30003 or equal cable. The loop lead-in shall be barrel sleeved, crimped, soldered and protected by heat shrinkable tubing to the loop #14 wire. Lead-ins shall be twisted in such a manner so as to prevent mechanical movement between the individual cables. Lead-ins shall be brought into a cabinet or handhole at the time the induction loop is placed in the pavement. Loops located over 1000 feet from cabinet require four (4) turns of No. 14 wire.

Lead-in cable Canoga 30003 or equivalent will be installed where the lead in length from point of interception to the point of termination exceeds 150 feet.

Where lead in runs are less than 150 feet the loop wire will be utilized as lead in to the point of termination w/o splices, being twisted 5 turns per foot. The loop wire will be paid for as "lead in" from last point of sawcut in pavement at dive hole to point of termination.

Loop lead-ins placed in handholes shall be coiled, taped and hung from the side of the handhole to protect against water damage. Any other method of installation will require prior written approval of the Engineer. Each loop lead-in shall be color coded and tagged in each handhole through which it passes. The loop lead-in shall be color coded and tagged at the core hole, in each junction box it passes through and at the termination point in the cabinet.

TRAFFIC SYSTEMS CENTER LOOP SPLICING REQUIREMENT

<u>MAINLINE LOOPS</u>		<u>METERING LOOPS</u>			
Lane 1	Blue	Lane 4	Violet	Loop 1	Green
Lane 2	Brown	Exit	Black	Loop 2	Yellow
Lane 3	Orange	Entrance	White	Loop 3	Red

When 2 or 3 loops are installed on an exit or entrance ramp the loop color code shall conform to the mainline loop color code and shall be marked as entrance or exit ramp loops.

In addition to color codes each loop shall be identified with a written label attached to the loop wire, or lead-in wire. The tags shall be Panduit #MP250W175-C or equivalent. All wires and cables shall be identified in each handhole or cabinet the cable passes through, or terminates in. The labels shall be attached to the cable by use of two cable ties.

Testing. After installation, the cable shall be tested as approved by the Engineer. Cable failing to pass the test shall be replaced with new cable at no additional cost.
Pay Item SE1 Continued:

Method of Measurement. The cable shall be measured for payment in linear foot in place. Measurements shall be made in straight lines between changes in direction and to the centers of equipment. All vertical cable and permissible cable slack shall be measured for payment. A total of six (6) feet of slack shall be allowed for the end of a run terminating at a panel and four (4) feet will similarly be allowed when terminating at a wall-mounted panel. Additional vertical distance for the height of conduit risers, etc., as applicable, will be measured for payment for equipment so mounted.

Basis of Payment. This work shall be paid at the Contract unit price per linear foot furnish and installed for ELECTRICAL CABLE IN CONDUIT, 4/C NO. 18 SHIELDED LOOP DETECTOR

SI01 Inspection, Automatic Suppression System

This item shall consist of scheduling a semi-annual inspection, functional test, and certification of the Automatic Suppression Alarm System located at the Traffic Systems Center.

All work shall be performed by a trained and certified fire alarm technician twice during each contract year in accordance with the manufactures recommendations, local code and national code.

The following procedure minimum shall be conducted during each inspection;

1. clean smoke detectors
2. calibration of smoke detectors
3. actual alarming of detectors and manual pull stations
4. check control panel electrical wiring for grounds and shorts
5. check control panel battery standby and charger
6. check alarm devices such as bells and horns
7. check Halon storage tanks weight and pressure

8. Test interlocking equipment for shut down
9. check other specialized components as needed
10. submit written reports to purchaser with recommendations for corrections, additions, deletions, or other changes to the system.

Basis of Payment. This item shall be paid at the contract unit price each for INSPECTION, AUTOMATIC SUPPRESSION SYSTEM, which price be payment in full for all work described herein and as directed by the Engineer.

SJ01 Junction Box, Stainless Steel

Description. This item shall consist of furnishing and installing at a specific location a junction box with cover, Type “J”, continuously welded, 1/4” thick, Type 316 stainless steel as specified.

Installation Details. All junction boxes shall be water tight. Pre-drilled holes shall be provided for the applicable conduit size and location. Unless otherwise specified, conduits terminating at stainless steel boxes shall be terminated in conduit hubs.

The cover shall be recessed within an outside frame, having a water-tight gasket, and mounted flush with the surface of this frame. Recessed stainless steel slot head screws shall secure the cover.

Junction Box Embedded in Concrete. For example: A stainless steel continually welded box 41” X 12” X 12” with stainless steel 1/4” type 316 cover and neoprene gasket with a minimum of ten (10) 3/8” X 3/4” flat head stainless steel slotted screws - Reference Traffic Surveillance Typical Drawings TY-ITSC-663 #2 through #13 drawings.

Basis of Payment. This work will be paid at the contract unit price each for furnishing and installing a JUNCTION BOX, STAINLESS STEEL, which price shall be payment in full for all labor and materials necessary to complete the work as described above.

SLP1 Lightning Protection For Communication Lines

Description. This item shall consist of furnishing and installing stud mounted lightning protection on non-polarized balanced telephone pairs, as directed, in writing, by the Engineer.

The Contractor shall furnish and install EDCO Surrestor SRA-64C-008 D mounted on brackets for installing multiple unit of four or eight stud mounted in line devices. The mounting brackets shall be bonded to an earth ground. The Surrestor shall be non-polarized unit intended for balanced telephone line operation. The Surrestor shall provide two-stage protection, differential mode protection, common mode protection, automatic recovery, fast response time and be flame retardant epoxy encapsulated. Miscellaneous hardware and mounting will not be paid separately but shall be considered as incidental to the cost of the item. Surrestor shall be mounted in existing surveillance cabinet.

Basis of Payment. This work shall be paid at the contract unit price each for LIGHTING PROTECTION FOR COMMUNICATION LINES, which price shall be payment in full for all work as described herein and as directed by the Engineer.

SLP2 Lightning Protection for Induction Loop Detectors

Description. This item shall consist of furnishing and installing stud mounted lightning protection on existing induction loops in existing surveillance cabinets, as directed, in writing, by the Engineer.

The Contractor shall furnish and install EDO Surrestor SRA-16C-1 mounted on brackets for installing multiple units of four or eight stud mounted inline devices. The mounting bracket shall be bonded to an earth ground.

The SRA-16C-1 shall be a three terminal device, two of which are connected across the loop inputs of the detector for differential mode protection and the third terminal grounded to protect against common mode damage. Differential mode surges (induced voltage across the loop detector input terminals) shall be clamped by semiconductor array instantly. Common mode surges (induced voltages between the loop leads and ground) shall be handled by a three element gas discharge tube which fires at 400 VDC and thereafter clamps the two loop leads to 30 volts in respect to ground. The Surrestor shall be mounted in existing surveillance cabinet. Miscellaneous hardware and mounting will not be paid separately but shall be considered as incidental to the cost of this item.

Basis of Payment. This work shall be paid at the contract unit price each for LIGHTING PROTECTION FOR INDUCTION LOOP DETECTORS, which price shall be payment in full for all work as described herein and as directed by the Engineer.

SP01 Paint Surveillance Installation

Description. This item shall consist of painting an individual ramp metering locations or surveillance cabinets at a specific location as directed by the Engineer.

These items shall conform with of the Recurring Special Provisions for Traffic Surveillance (TSC T721#1) except as revised herein. The cleaning and preparation of the surface to be painted in these items shall be as follows: All painted surfaces shall be cleaned by mechanical means removing all loose or flaking paint and rust. The cleaned surface shall be free of all visible oil, grease, dirt, dust, rust, paint, oxides, and other foreign matter except for staining all debris shall be cleaned up. Vacuuming and sweeping or blowing away of the material is not allowed. All cleaned parts must be primed with an approved primer. This work shall be completed between May 1 and October 15 of the calendar year. Basis of payment is each for furnishing all labor, materials, equipment, and clean up for painting the above pay items.

Note: The Contractor is required to paint individual expressway cabinets a color other than federal yellow. Color code for individual locations shall be determined prior to starting work.

At ramp metering locations the Contractor shall be required to paint control cabinet, signal heads, flashing beacons, and AC service installation.

Aluminum signal parts, except doors, shall have minimum 2 coats of durable paint, final coat federal yellow.

Traffic signal doors and visors shall have minimum 2 coats of durable paint, final coat dull black in color.

Any steel or iron parts or fittings shall have one coat of approved primer and 2 coats of federal yellow.

Ramp control cabinets are lime green in color.

Special Instructions

- Painting Date - At the completion of the work, the Contractor shall stencil in black color paint the date of painting the cabinet. The letters shall be capitals, not less than 1 inch and not more than 2 inches in height.

The stencil shall show the month and year in which the painting was completed. This shall be stenciled at bottom front of the cabinet facing traffic flow.

- Cleanup - all surfaces painted inadvertently shall be cleaned immediately.

Basis of Payment. This work shall be paid at the contract unit price each for each PAINT SURVEILLANCE INSTALLATION as described above, which price shall be payment in full for all work as described herein and as directed by the Engineer.

SP02 Paint Traffic Signal Mounting Hardware

Description. This item shall conform with Section 840 of the Standard Specifications for Road and Bridge Construction and highway standard 2371 "Details for Mounting Traffic Signals" except as revised herein. All connecting hardware and mounting brackets shall be painted yellow in accordance with AASHTO M111. The basis of payment is each for furnishing and installing the mounting hardware.

Basis of Payment. This work shall be paid at the contract unit price each for PAINT TRAFFIC SIGNAL MOUNTING HARDWARE (1 Face: TSC) as described above, which price shall be payment in full for all work as described herein and as directed by the Engineer.

SPB1 Post Base, Traffic Signal

Description. This item shall conform with section TSC T401#1 of the Recurring Special Provisions for Traffic Surveillance for traffic control item and the painting and base requirement of pay item of this contract. The basis of payment is each for furnishing and installing a traffic signal post base/or barrier wall post bracket where necessary.

Basis of Payment. This work shall be paid at the contract unit price each for POST BASE, TRAFFIC SIGNAL, as described above, which price shall be payment in full for all work as described herein and as directed by the Engineer.

SPG1 Post, Guard

This item shall consist of furnishing and installing a 10 foot length of 6 inch diameter, galvanized steel pipe, filled with concrete buried vertically 5 feet deep in the ground, as directed by the Engineer to protect the Traffic Systems Center cabinet installation from vehicular damage.

Basis of Payment. This item will be paid at the contract unit price each for furnishing and installing POST, GUARD completely in place.

Digging holes, transportation, handling, concrete and miscellaneous items will not be paid for separately but shall be considered incidental to the cost of this item.

SPI1 Public Information Surveillance System

Description. This item shall consist of furnishing and installing a 40 channel CB radio, and antenna with 4-inch PVC duct together with a type 20721 station coupler (RDM ZR) to existing Traffic Systems Center Cabinet as directed in writing by the Engineer.

The Traffic Systems Center will be provided by the Contractor a CB radio, CB antenna, a 4" PVC duct to hide and mount the CB antenna, a 12 volt power supply and mounting hardware to be installed in a pre-existing cabinet. The Contractor shall install all the mounting hardware for the PVC and antenna, AC duplex outlet, cabling, wiring, matching transformer connectors, plugs and station coupler (Valcom V9940 or equivalent) to automatically answer a dial up telephone call to monitor the output of the CB radio which shall be set to Channel 19. The Contractor shall cooperate with the telephone company installer of the dial up phone circuit by providing access to the existing surveillance cabinet. Miscellaneous hardware, drilling, tapping shall not be paid separately, but shall be considered as incidental to the cost of this item. The station coupler (Valcom V9940 or equivalent) shall serve as an interface

between the output of the CB radio and a single party dial up telephone line. it shall provide DC isolation and high voltage surge protection; provide conditional balance; ringing detector for every frequency 20 Hz and above; network control signaling (off hook, dial pulse tone address signaling and ringing); automatic and controlled answer and disconnect (calling party controlled disconnect) and AC or DC powered (low voltage transformer Valcom VP-624B or equal) and shelf mounted.

Basis of Payment. This work shall be paid at the contract unit price each for PUBLIC INFORMATION SURVEILLANCE SYSTEM, which shall be payment in full for all work as described herein and as directed by the Engineer.

SPI2 Public Information Surveillance System, Relocate

Description. This item shall consist of installing a state provided CB radio monitoring system and antenna with 4-inch (101.6mm) PVC duct together with a type 20721 station coupler (RDM ZR) from/to existing Traffic Systems Center Cabinet as directed in writing by the Engineer.

The Traffic Systems Center will provide to the Contractor a CB radio, CB antenna, a 4" PVC duct to hide and mount the CB antenna, a 12 volt power supply and a dial up telephone circuit, and mounting hardware from a pre-existing cabinet. The Contractor shall install all the mounting hardware for the PVC and antenna, AC duplex outlet, cabling, wiring, matching transformer connectors, plugs and station coupler (Valcom V9940 or equivalent) to automatically answer a dial up telephone call to monitor the output of the CB radio which shall be set to Channel 19. The Contractor shall cooperate with THE TELEPHONE COMPANY installer of the dial up phone circuit by providing access to the existing surveillance cabinet. Miscellaneous hardware, drilling, tapping shall not be paid separately, but shall be considered as incidental to the cost of this item. The station coupler (Valcom V9940 or equivalent) shall serve as an interface between the output of the CB radio and a single party dial up telephone line. it shall provide DC isolation and high voltage surge protection; provide conditional balance; ringing detector for every frequency 20 Hz and above; network control signaling (off hook, dial pulse tone address signaling and ringing); automatic and controlled answer and disconnect (calling party controlled disconnect) and AC or DC powered (low voltage transformer Valcom VP-624B or equal) and shelf mounted.

Basis of Payment. This work shall be paid at the contract unit price each for PUBLIC INFORMATION SURVEILLANCE SYSTEM, RELOCATE, which shall be payment in full for all work as described herein and as directed by the Engineer.

SPT1 Post, Traffic Signal, 1' TO 3'-6"

Description. This item shall conform with section 832 of the Standard Specifications for Road and Bridge Construction except as revised herein. This item shall consist of furnishing a new yellow painted traffic signal Post 1' to 3'-6" in length together with a painted yellow cast iron octagonal in shape base. The Contractor shall use a fabric post tightened to attach the post to the base. If the paint on the post is removed or damaged by using a chain post tightened exposing the base metal, the post shall be rejected and replaced with a new post. During fabrication of the post necessitating the threading of the post, the bare metal shall be immediately cleaned to remove all cutting solvents and oils, then spray painted with two coats of an approved yellow. If the post arrives with any rust showing, it shall be sent back to the fabricator. No more than three-fourths (3/4) inch of thread shall be allowed to protrude above the post base. Bases shall be octagonal in shape, approximately fourteen (14) inches high and sixteen (16) inches across the flat sides at the bottom. All bases shall be designed to accept five-eighths (5/8) inch diameter anchor bolts evenly spaced in a twelve and one half (12-1/2) inch to thirteen (13) inch diameter. Basis of payment is each for furnishing and installing the traffic signal post.

Basis of Payment. This work shall be paid at the contract unit price each for TRAFFIC SIGNAL POST, 1' TO 3'-6" – as described above, which price shall be payment in full for all work as described herein and as directed by the Engineer.

SPW1 Post, Wood

Description. This item shall consist of furnishing, installing a 6" x 6" x 16'-0" wood posts at ramp metering locations shown on the plans, or as directed by the Engineer.

Material

Each post shall be of southern pine conforming to Article 707.09 of the Standard Specifications for Road and Bridge Construction. The preservative used in the treatment of the wood posts shall be a solution of pentachlorophenol meeting the requirement of Article 707.12 of the Standard Specifications.

Installation Details

The posts shall be placed vertically in a vertical hole not exceeding 12 inches in diameter and not less than 5 feet deep. The post shall be placed in the center of the hole and backfilled with stone screenings thoroughly tamped in 12-inch lifts. The stone screenings shall conform to Article 704.01 (Gradation CA 6) of the Standard Specifications. The post shall be vertical after the tamping.

Under no circumstances will the sawing off of any part of a post be permitted after the preservative has been applied.

Basis of Payment. This work will be paid at the contract unit price each for WOOD POST, of the length specified, which price shall be payment in full for furnishing and erecting the post, digging and backfilling the post hole.

SR01 Radar Vehicle Detector

1. GENERAL

- 1.1 The purpose of this specification is to describe the minimum requirements of a Radar Vehicle Detector (RVD)
- 1.2 All work performed shall conform to the requirements of the Department's Standard Specifications (Standards) and Standard Drawings, unless otherwise shown on the contract Drawings or noted in the contract Special Provisions.
- 1.3 The Contractor shall be responsible for coordinating and monitoring the schedule of the installation of the RVD.
- 1.4 This work shall consist of furnishing all labor, materials, equipment and testing to supply and install a Radar Vehicle Detector in accordance with the contract drawings and these special provisions.

2. General Description

- 2.1 The RVD shall be easy to install and remove, and shall be fully programmable to support a variety of applications.
- 2.2 The RVD shall be self-contained and require no external controllers and shall internally calculate all required traffic parameters.
- 2.3 The RVD shall be furnished with the necessary software for installation in a portable PC for set-up.
- 2.4 All Equipment and component parts furnished shall be new, be of the latest design and manufacture, and be in an operable condition at the time of delivery and installation. All parts

shall be of high quality workmanship, and no part or attachment shall be substituted or applied contrary to the manufacturer's recommendations and standard practices.

- 2.5 The design shall be such as to prevent reversed assembly or improper installation of connectors, fasteners, etc. Each item of equipment shall be designed to protect personnel from exposure to high voltage during equipment operation, adjustments, and maintenance.
 - 2.6 The designed Mean Time between Failures (MTBF) of the RVD unit, operating continuously in their application, shall be 10 years of longer.
3. Environmental Conditions
 - 3.1 Except as stated otherwise herein, the equipment shall meet all its specified requirements during and after subjecting to any combination of the following:
 - 3.1.1 Ambient temperature range of -37° to +74°C.
 - 3.1.2 Relative humidity from 5% to 95%, non-condensing.
 - 3.1.3 Power surge of 6kV – 10,000 amps.
 - 3.2 The design shall be inherently temperature compensated to prevent abnormal operation. The circuit design shall include such compensation as is necessary to overcome adverse effects due to temperature in the specified environment range.
 - 3.3 Except as may be otherwise stated herein for a particular item, no item, component, or subassembly shall emit a noise level exceeding the peak level of 55 dBA when measured at a distance of 1 meter away from its surface.
 - 3.4 The detector shall include surge protection in accordance with IEEE Standard C62.41-1980 Category C.
 - 3.5 The microwave radar detector shall be resistant to vibration in accordance with IEC 68-2-30 (test Fc), NEMA TS-1 (Section 2.1.12), or approved equivalent. The microwave detector shall be resistant to shock in accordance with IEC 68-2-27 (test EA), NEMA TS-1(Section 2.1.13), or approved equivalent.
 4. Functional Characteristics
 - 4.1 Capabilities:
 - 4.1.1 The RVD shall be a true presence detector that can provide presence, volume, and lane occupancy and speed information on up to eight discreet detection zones. This information shall be available to existing controllers via contact closure pairs and to other systems via serial communications lines.
 - 4.2 Transmission:
 - 4.2.1 Each microwave radar detector shall transmit on a frequency band of 10.525 GHz+/-25Mhz or another approved spectral band. The detector shall comply with the limits for a Class A digital device. Pursuant to Part 15 of the FCC rules or the appropriate Spectrum Management Authority. The RVD shall not interfere with any known equipment.
 - 4.2.2 Transmitter power shall not exceed 10 milliwatts.
 - 4.3 Area Coverage:

4.3.1 The RVD's field of view shall cover an area defined by an oval shaped beam and its maximum detection range shall be as follows:

1. Elevation Beam Width: 45°
2. Azimuth Beam Width: 15°
3. Range: 10'-0" to 200'-0"

4.4 Detection Zones:

4.4.1 The number of detection zones defined shall be no less than 8. The range limits of each zone shall be user defined in 7'-0" resolution.

4.5 Measurement Accuracy:

4.5.1 The detector shall identify vehicle presence within each detection zone with a 95% accuracy or greater. Independent of the vehicle's direction of travel through the detection zone.

4.5.2 The maximum permissible error shall be 5% in the detection of the direction and magnitude of radial speed and 10% in the case of transverse speed

4.6 The internal controller shall provide the following capabilities:

- 4.6.1 Presence in detection zone: 2% error
- 4.6.2 Per lane Occupancy (Side-fired): 5% error 0-100% range
- 4.6.3 Per lane Volume (Side-fired) 5% error 0-255 range
- 4.6.4 Per lane Long Vehicle Volume (Side-fired): 10% error 0-255
- 4.6.5 Per lane Average Speed (Side-fired): 10% error 0-160kmh (0-100 mph)
- 4.6.6 Volume and Occupancy (Forward-looking): 2% error
- 4.6.7 Average Speed (Forward-looking): 5% error 0-160kmh(0-100mph)
- 4.6.8 Speed (Forward-looking): 2% error 0-160kmh(0-100mph)
- 4.6.9 For both per-vehicle and Average speed:
 1. Veh. Length (Fwd-looking): 10% error 0-25m (0-85 Ft.)
 2. Range Resolution: 7 Ft. error
 3. Time events Resolution: 10 mSec. Error

5. Mechanical

5.1 The Microwave radar detector shall be enclosed in a rugged weatherproof box and sealed to protect the unit from wind up to 90 mph, dust and airborne particles, and exposure to moisture (NEMA type 4X enclosure). The overall dimensions of the box, including fittings, shall not exceed 8" x 10" x 6". The total weight of the microwave radar detector assembly shall not exceed 5 pounds.

5.2 The mounting assembly shall have all painted steel, stainless steel, or aluminum construction, and shall support a load of 20 pounds. The mounting assembly shall

incorporate a ball-joint, or other approved mechanism, that can be tilted in both axes, then locked in place, to provide the optimum area of coverage.

6. Electrical

- 6.1 The RVD unit shall be operable from either 12-24 VAC/DC dissipating 6W. 110V AC Power supply shall be obtained from the power distribution assembly within the controller cabinet.
- 6.2 The interface consists of a single MS connector which provides power to the unit, output contact closure wire pairs for each of the required detection zones rated at 200V AC/DC 100 mA, and serial communication lines for programming, testing or modern interface at 9600 Baud rate. Data format of the serial port shall be standard binary NRZ 8 bits data, 1 stop bit, no parity.
- 6.3 A UV-resistant cable of multiple twisted pairs of stranded AWG #18, or #22 wires with a common shield rated at 300V with a temperature rating of 105°C (Belden #9563 for 18 AWG, #9521 for 22 AWG or approved equal) will provide connection between the RVD and the cabinet equipment.
- 6.4 The distance the RVD is located from control cabinet shall dictate cable size: For sensor less than 250 feet from control cabinet, use 22 AWG wire; for distances greater than 250 feet use 18 AWG wire. All cable assemblies shall be at least 11 pairs minimum.
- 6.5 Contractor shall supply DC or low voltage AC transformer, wall mount, in controller cabinet rated 16-20 volts, 10 VA for each RVD unit.
- 6.6 The MS connector pins must be crimped to the cable conductors and assembled and tested prior to installation and pulling of cable on –site.
- 6.7 The junction box or cabinet to house the RS 232 connector must be located within sight of the desired detection zones in order to initially set up the sensor or to alter the set-up at a later date.

7. Installation

- 7.1 The RVD shall be mounted in either Side-fired or Forward-looking configuration. It shall be mounted on poles or sign structures at the specified locations, using the supplied mounting brackets. The brackets shall be attached with approved 0.75” wide, .025” thick, stainless steel bands or to a concrete wall/bridge using 2 stainless steel expansion bolts of sufficient length and diameter to support 100 pounds.
- 7.2 The contractor shall install the detector unit on a pole at the height of 20 to 25 feet above the road surface so that the masking of vehicles is minimized and that all detection zones are contained within the specified elevation angle as suggested by the manufacturer.
- 7.3 In the Forward-look configurations the detector will be mounted over the center of each lane.
- 7.4 The RVD detection zones shall be set up using the provided software and a Notebook PC.
- 7.5 A 3.5 foot serial cable with DB 9 connector shall be installed in control cabinet for interface with RVD. This cable shall be installed permanently for testing and setup of RVD.

Method of Measurement. This item shall be measured Radar Vehicle Detector installed each, tested, operational, and complete

Basis of Payment. This work shall consist of furnishing all labor, materials, equipment, set-up and testing to supply and install a RADAR VEHICLE DETECTOR (RVD) complete in accordance with the contract drawings and these special provisions. Miscellaneous connectors, brackets, cables and serial port cable shall be included in unit price for RVD.

SR02 Radar Vehicle Detection Station

Description:

This item shall consist of furnishing and installing a Radar Vehicle Detection Station where indicated per these special Provisions and as directed by the Engineer.

Materials:

The Contractor shall furnish the following components that can be configured as a Radar Vehicle Detection Station.

- Radar Vehicle Detector
- Frequency Hopping Spread Spectrum Radio
- Solar Panels
- Batteries
- Cabinet/Enclosure to house batteries and electronics
- Internal or External Whip Antenna or Yagi antenna
- All related connection cables

These components shall be compatible with the existing components that were removed and salvaged from the Dan Ryan Reconstruction Project, contract #62583.

System Components

Standard Solar Power Assembly

The solar modules shall be made in North America and have a 20-year factory warranty. The solar array shall be a minimum of 85 watts peak. Solar modules shall be UL listed, and FM approved. The array mount shall attach to the side of an approved pole with stainless steel fasteners. The array mount shall be aluminum alloy or stainless steel. The array shall be capable of withstanding 125 mph winds.

The solar charge regulator shall be UL listed, minimum 10A with solid state, low-voltage disconnect. The solar charge regulator shall be sealed with internal temperature compensation, lightning protection, reverse polarity protection and LED indicators. The solar charge regulator shall be FM approved and have the CE mark.

The batteries shall be 12 V gel electrolyte, non-spillable, maintenance free units. Battery autonomy shall be minimum 14 days.

Enclosures shall be .125" aluminum with stainless steel hardware. The enclosures shall have #2 Corbin Lock on an insulated door. There shall be separate compartments for the batteries for the electronics. The minimum enclosure dimensions shall be 43.875" x 16.5" x 10.25".

The enclosure shall have 2 shelves min. with 1.00" x 2.00" opening cutout in the shelf. The lower compartment shall have a 13.00" x 15.00" back panel, .125" thick. The upper and middle compartments shall be vented by louvers on each side. Door shall be equipped with a door stop mechanism to stop the door at 90° and 180°. Cabinet shall have a plastic sheet holder which shall contain the wiring and as-built diagrams specific to the site.

For the solar array power wiring shall be 10-2, stranded copper, double insulated, sunlight resistant, 600 V 90C rated cable.

Minimum Solar Power Requirements to operate in the Chicago area:

- 2-85 watt panels with side of pole mounting
- 1 charge regulator
- 2-120 amp hour batteries AGM Type
- 1-Aluminum Enclosure
- Connection Cables – 10 AWG

Radar Vehicle Detector

General Information

- The purpose of this specification is to describe the minimum requirements of a Radar Vehicle Detector (RVD).
- The RVD shall be easy to install and remove, and shall be fully programmable to support a variety of applications.

The designed Mean Time Between Failures (MTBF) of the RVD unit, operating continuously in their application, shall be 10 years or longer.

The manufacturer of the RVD shall provide at least three (3) references to show that the RVD product has been deployed in operations systems of similar scope and size for over three (3) years. The Contractor shall be responsible for providing all materials to install and place the equipment into operation (mounting brackets, connector backshells) which will be part of the bid price of the item.

The microwave radar detector shall be resistant to vibration in accordance with IEC 68-2-30 (test Fc), NEMA TS-1, (Section 2.1.13), or approved equivalent.

MICROWAVE TRANSMISSION

The microwave radar detector shall transmit on a frequency band of 10.525 GHz +/- 25 MHz or another approved spectral band. It shall comply with the limits for a Class A digital device, pursuant to Part 15 of the FCC rules or the appropriate Spectrum Management Authority. The RVD shall not interfere with any known equipment. Transmitter power shall not exceed 10 milliwatts.

The microwave radar detector shall be resistant to vibration in accordance with IEC 68-2-30 (test Fc), NEMA TS-1 (Section 2.1.12), or approved equivalent.

The microwave detector shall be resistant to shock in accordance with IEC 68-2-27 (test EA), NEMA TS-1 (Section 2.1.13), or approved equivalent.

AREA OF COVERAGE

The RVD's field of view shall cover an area defined by an oval shaped beam and its maximum detection range shall be as follows:

- Elevation Beam Width 40 degrees
- Azimuth Beam Width 15 degrees
- Range 10 to 200 feet

DETECTION ZONES

The maximum number of detection zones defined shall be no less than eight (8). The range limits of each zone shall be user defined in 7-ft. resolution

FUNCTIONAL CHARACTERISTICS

CAPABILITIES

The RVD shall be a true presence detector. It shall be suitable for mounting on road-side poles or on overhead structures and provide the following:

- Presence of moving or stopped vehicles in its detection zones, provided as duration of contact closure to existing controllers.
- Traffic data accumulated over user defined time intervals in a 10 to 600 sec range, transmitted via serial communications lines to other systems.
- Traffic data shall be available simultaneously with detection zone contact closures
- Side fired configuration data shall include the following in each of up to eight (8) detection zones:
 - Volume
 - Lane occupancy
 - Average speed
 - Vehicle length classification in up to 4 user-defined classes.
- RVD on overhead structures (forward-looking configuration) shall monitor traffic in one lane and be capable of providing the following data:
 - Volume, occupancy and speed in the lane
 - Per vehicle speed and length
 - Binning of volume data in up to 7 speed and length bins
 - It shall be possible to define the scope of transmitted data
 - It shall be compatible with the Radar Detector Unit salvaged from Dan Ryan Contract #62583.

MECHANICAL

The microwave radar detector shall be enclosed in a rugged weatherproof box and sealed to protect the unit from wind up to 90 mph, dust and airborne particles, and exposure to moisture (NEMA type 3R enclosure).

Max. weight of the microwave radar detector assembly 2.2kg (5 pounds)

The mounting assembly shall have all coated steel, stainless steel, or aluminum construction, and shall support a load of 20 pounds. The mounting assembly shall incorporate a ball-joint, or other approved mechanism, that can be tilted in both axis, then locked into place, to provide the optimum area of coverage.

ELECTRICAL

The RVD unit shall be operable from either 12-24 VAC/DC, or 95-135VAC @ 60 Hz. Power supply shall be obtained from the power distribution assembly within the controller cabinet, solar array or any convenient power source.

Power dissipation shall not exceed 4.5W or an average of 6.0 Watts for RVD equipped with internal Spread Spectrum modem.

CABLE

Connection between the RVD and the cabinet equipment shall be provided by a single, MS connector terminated cable.

The cable shall provide power to the unit, and output contact closure wire pairs rated at 300V AC/DC 100 mA for each of the required detection zones and data interface.

A junction box or cabinet to house the data interface connector must be located within sight of the desired detection zones in order to initially set up the sensor or to alter the set-up at a later date.

The cable shall be UV-resistant and provide multiple twisted pairs of stranded AWG #20 or #22 wire with a common shield rated at 300V with a temperature rating of 105° C.

The MS connector pins must be crimped to the cable conductors and assembled and tested prior to installation and pulling of cable on site.

ELECTRICAL ISOLATION AND SURGE PROTECTION

Power lines, contact closures and serial port shall be isolated. Power lines and serial port shall be surge protected within the unit.

DATA INTERFACE

Data communications shall be asynchronous. It shall be configurable as:

- Opto-isolated RS-485 or RS-232 port at variable rates from 2400 up to 115200 bits per second. Data format of the serial port shall be standard binary NRZ 8 bits data, 1 stop bit, no parity.
- An integrated spread Spectrum radio modem
- Ethernet port (TCP/IP)

INSTALLATION

The RVD shall be mounted in either Side-fired or Forward-looking configuration on poles or sign structures at the specified locations, using the supplied mounting brackets. The brackets shall be attached with approved ¾-inch wide, .025-inch thick, stainless steel bands or to a concrete wall/bridge using 2 stainless steel expansion bolts of sufficient length and diameter to support 100 pounds.

The contractor shall install the detector unit on a pole at the height of 21 feet min. above the road surface so that the masking of vehicles is minimized and that all detection zones are contained within the specified elevation angle as suggested by the manufacturer. In the Forward-look configurations the detector will be mounted over the centre of each lane. The mounting bracket shall allow replacement of unit without the need for re-aiming. The RVD detection zones shall be set up using the provided licensed software and the Contractor's Notebook PC.

Contractor shall provide the Department with 10 licensed copies or a multiple user license for the RVD software to set up, calibrate and monitor the RVD sensor. Contractor shall be responsible to provide his own computer to set up and calibrate the RVD or Master Radio Controller Sites.

INTEGRATED RADIO MODEM SPECIFICATIONS

Technology	Frequency Hopping Spread Spectrum Radio
Frequency band	900 MHz or 2.4 GHz licensed exempt ISM bands
Mode	Slave or repeater operation
Hopping pattern	64 pseudo-random sequences selectable
Transmitter power	1mW, 10mW, 100mW or 1W selectable
Antenna	Integral 9" Whip or External Whip/Yagi Antenna
Range	Up to 30 km depending on power, line of sight and antenna
Error detection	CRC-16
Network addressing	Up to 65535 addresses
Encryption	Up to 65535 combinations
Interface	Asynchronous, AT Command set, transparent data set
Licensing	FCC rules Part 15 approval. License free operation in the US
Temperature range	37° to +70° C
Power consumption	
Receive	0.55 W

Transmit @ 1mW	0.55 W
Transmit @ 10mW	0.65 W
Transmit @ 100mW	0.88 W
Transmit @ 1W	2.2 W

DSS Radio shall be compatible with DSS Radios salvaged from Contract 62583

ENVIRONMENTAL CONDITIONS AND PROTECTIONS

Except as stated otherwise herein, the equipment shall meet all its specified requirements during and after subjecting to any combination of the following:

- Ambient temperature range of -37 to +74 degrees C
- Relative humidity from 5 to 95 percent, non-condensing
- Winds up to 160 Km/h
- Rain and other precipitation up to 100mm/h
- Power surge of \pm 1kV surge (rise time = 1.2 μ sec, hold = 50 μ sec) applied in differential mode to all lines, power and output, as defined by IEC 1000-4-5 and EN 61000-4-5 standards.
- Surge Arrestor shall be included for master antenna installation.

Except as may be otherwise stated herein for a particular item, no item, component, or subassembly shall emit a noise level exceeding the peak level of 55 dBA when measured at a distance of one meter away from its surface.

DSS Transceivers

DSS Transceiver features:

- Frequency Hopping Spread Spectrum Radio Operating in 900 MHz or 2.4GHz license-exempt ISM bands
- Time Division Multiplex Access (TDMA) operation
- Master, Slave and Repeater modes
- 64 pseudo-random hopping sequences for 900 MHz band, 49 for 2.4GHz band
- Up to 65535 network addresses
- Up to 65535 encryption combinations
- Selectable transmit power: 1, 10, 100 or 1000 mW

Wood Poles

Temporary 27.43 meter high, state stock, wood poles shall be used for detector sites and collection sites. The system components shall be mounted to the wood poles at the locations in this specification or as directed by the Engineer. Wood Poles shall be paid separately as POLE UNIT, WOOD, INSTALL ONLY.

Method of Measurement

RVD VEHICLE DETECTION STATION will be counted as each, regardless of number of RVD Detectors, number of solar panels, batteries, or size of regulator required to provide for a functioning location.

Basis of Payment

This work shall be paid for at the contract unit price each for RVD DETECTION STATION, which shall be payment in full for all material, labor, equipment, tools, and all incidentals necessary for the completion of this work describe herein and elsewhere in the contract documents.

SR03 Radar Vehicle Detection Hub

Description:

This item shall consist of furnishing and installing a Radar Vehicle Detection Hub where indicated in these special provisions and as directed by the Engineer.

Materials:

The Contractor shall furnish the following components that can be configured as a Radar Vehicle Detection Hub. These components shall be compatible with the existing components that were removed and salvaged from the Dan Ryan Reconstruction Project, contract #62583.

The Radar Vehicle Detection Hub sites shall include but not be limited to the following hardware:

- Wood Pole
- Master Radio Controller
- Salvaged or state stock cabinets
- Antennas
- Telemetry Racks w/Power supplies (Provided by Department)
- All related connection cables
- 120V AC and Telephone Connections
- GSC Rigid conduit from service to cabinet

ENVIRONMENTAL CONDITIONS AND PROTECTION

Except as stated otherwise herein, the equipment shall meet all its specified requirements during and after subjecting to any combination of the following:

- Ambient temperature range of -37 to +74 degrees C
- Relative humidity from 5 to 95%, non-condensing
- Power surge of ± 1 kV surge (rise time = 1.2 μ sec, hold = 50 μ sec) applied in differential mode to all lines, power and output, as defined by IEC 1000-4-5 and EN 61000-4-5 standards.

The design shall be inherently temperature compensated to prevent abnormal operation. The circuit design shall include such compensation as is necessary to overcome adverse effects due to temperature in the specified environmental range.

All equipment and component parts furnished shall be new, be of the latest design and manufacture, and be in an operable condition at the time of delivery and installation. All parts shall be of high quality workmanship, and no part or attachment shall be substituted or applied contrary to the manufacturer's recommendations and standard practices.

The design shall be such as to prevent reversed assembly or improper installation of connectors, fasteners, etc. Each item of equipment shall be designed to protect personnel from exposure to high voltage during equipment operation, adjustments and maintenance.

Except as may be otherwise stated herein for a particular item, no item, component, or subassembly shall emit a noise level exceeding the peak level of 55 dBA when measured at a distance of one meter away from its surface.

WIRELESS DATA TRANSFER SYSTEM

This document describes the function of a system comprised of multiple Radar Vehicle Detectors (RVD) equipped with RF transceivers capable of communicating with a single central RF unit at a Traffic Controller. The system will provide wireless transfer of vehicle detection's from the RVD to the Traffic Controller and interface via contact closure.

Prior to installing RVD Detector Stations or RVD Detection Hubs, the Contractor shall provide the Department a Radio Site Survey of the I-55 Expressway segment to determine the optimum radio band to operate the Wireless Transfer System. The Radio Site Survey will also determine the feasibility of the Suggested RVD Detector Stations

and RVD Detection Hubs listed in this specification. It shall be the Contractor's responsibility to verify each location's viability and make any alternate site recommendations to the Department, should the viability of a particular site be in question. The final locations shall be picked based on the Radio Site Survey. The cost of the Radio Site Survey shall be included in the cost of the Radar Vehicle Detection Hub Pay Items.

WIRELESS DATA CONFIGURATION

The wireless data network shall be a multipoint to point data network meeting the following requirements:

Master Radio Controller @ Data Collection Sites

The wireless system for concentration of vehicle detection events from several RVD sensors equipped with Digital Spread Spectrum (DSS) modems into a single Master Radio Controller unit.

The Master Radio Controller's DSS modem employs Time Division Multiplex Access (TDMA) protocol to communicate with a number of RVD sensors slave modems. Each RVD slave transmits a data packet during its assigned time slot every 0.5 seconds. Transmitted data carries information on vehicle presence in all its detection zones with a 10mS resolution.

The user assigns one of the Master Controller's 32 dry relay contacts to each detection zone of all RVD sensors in the system. The Master controller reconstructs vehicle presence from the received data and converts it to closures of the corresponding contacts.

The system should come pre-configured as "plug and play". Operating Features:

Controller

The controller of the wireless system shall provide the following:

- Built-in DSS Transceiver configured as Master
- SIZE 135 x 135 x 50 mm (5.25 x 5.25 x 2 in), WEIGHT 500g (1.1lb)
- INPUT (wireless data) Contact closure data from up to 32 detection zones of up to 8 Multi-zone Vehicle Detectors.
- OUTPUT (37-pin D-type connector) 32 dry relay contacts shall be rated at 80V, 50mA, 600mW maximum isolation-1500VAC
- Accuracy of contact closure reconstruction-to10ms
- Delay – up to 1 sec
- POWER The controller shall be powered by 9-24V AC or DC
- Setup and diagnostic software providing:
 - Display of system in operation
 - Assignment to sensors detection zones to Output contacts
 - DSS Network parameter setup
 - Hardware diagnostic tests
 - Monitoring of link quality
 - Access to sensors for diagnostic purposes
 - Logging of activity and diagnostics
 - Frequency spectrum display to help in hop sequence selection
 - DSS Master shall be shelf mounted and ordered with its own power supply

Radar Vehicle Detection Hub communicates to a maximum of four Radar Vehicle Detection Stations using point-to-point, spread spectrum radios. The Contractor shall assign the radios to specific channels based on:

- The assessment of propagation and noise measurements during the initial site assessment
- Mitigation of interference between links

Installation:

The Contractor shall install the cabinets, detectors, and transceivers at the Stations and Hubs approved by the Engineer. The Contractor shall interface the transceivers to the radar detectors at the Stations and the transceivers to the Tone Telemetry equipment at the Hubs.

If required, the Contractor shall provide additional phone circuits and relocate additional tone equipment to the Hub. The additional phone circuits are paid for under a separate pay item. The tone equipment will be relocated from other cabinets under REMOVE AND SALVAGE EXISTING TSC EQUIPMENT.

The Contractor maps one of the Hub's eight dry contacts to each detection zone of the RADAR VEHICLE DETECTOR sensors in the system. At the TSC, the Contractor shall cross-connect the incoming closures to the nearest incoming ATMS FEP detector input. (All of the existing detector equipment is cross-connected to the IDF in the Intermediate Distribution Frame (IDF).

When all equipment is installed and connected, the Contractor shall test and demonstrate the performance and accuracy of the installed detectors. This test shall match observed and detected vehicles, as well as the ability of the Advance Traffic Management System to collect and use the data for travel times. The accuracy of the travel times is not an issue for the Contractor, provided the detectors are reporting the vehicles' presence correctly.

Wood Poles

Temporary 27.43 meter high, state stock, wood poles shall be used for detector sites and collection sites. The system components shall be mounted to the wood poles at the locations in this specification or as directed by the Engineer. Wood Poles shall be paid separately as POLE UNIT, WOOD, INSTALL ONLY.

Method of Measurement:

Radar Vehicle Detection Hub shall be measured per each detection Hub installed.

Basis of Payment

The following items shall be paid for each RADAR VEHICLE DETECTION HUB, which price shall include all materials, equipment, and labor needed to perform the work described herein.

SR04 RVD Station, Remove, Salvage, and Reinstall

SR05 RVD Hub, Remove, Salvage, and Reinstall

Description:

This item shall consist of removing, salvaging, and reinstalling a wireless Surveillance Vehicle Detection System. This system shall consist of the following elements: Salvaged Radar Vehicle Detection Station (RVD Station); salvaged Radar Detection Hub (RVD Hub) relocated from Dan Ryan Temporary Detection System, Contract 62583 and I-80 Contract 62664.

The wireless vehicle detection system will emulate the typical 6' diameter induction loops. The system will use a hub, located at the site where AC power and phone service are available. This hub will use spread spectrum radios to communicate upstream and downstream with radar vehicle detectors at radar vehicle detector stations. The radar detectors will be configured to emulate the loop detectors and provide dry contact switch closures through the radios to the hub. At the hub, the switch closures will be connected to tone transmitters on a telephone circuit to the Traffic Systems Center (TSC).

The new Radar Detector Stations and relocated Radar Vehicle Detection Stations, however, will be isolated from the system and will not have access to normal power service. These installations will use solar power for the radar detectors and radios.

All work will require close coordination with the TSC staff and the Engineer.

Materials:

The Contractor shall remove, salvage and reinstall the following components and subsystems that can be configured as Radar Vehicle Detection Hubs and Radar Vehicle Detection Stations:

Salvaged components from Contract 62583 and 62664 that comprise a Radar Vehicle Detection Station are:

- Solar Panel
- Solar Charge Regulator
- Batteries, 12v, gel-electrolyte
- Battery enclosure
- Radar Vehicle Detector w/integrated DSS Radio (900 MHz)
- RVD Bracket
- RVD Cables
- Wood Pole
- Yagi Antenna

Salvaged components from Contract 62583 and 62664 that comprise a Radar Vehicle Detection Hub are:

- Wood Pole
- 900 MHz Spread Spectrum Radio
- Yagi Antenna
- All related connection cables, brackets, and other incidental items
- TSC telemetry cabinet w/ tone rack enclosure

The Contractor shall install the detector unit on the pole at the nominal height of 21 feet above the road surface so that the masking of vehicles is minimized and that all detection zones are contained within the specified elevation angle as suggested by the manufacturer. The radar vehicle detector's detection zones shall be set up using the provided licensed software and the Contractor's Notebook PC.

Each Detector Hub communicates to a maximum of four Temporary Detection Stations using point-to-point, spread spectrum radios. The Contractor shall assign the radios to specific channels based on:

- The assessment of propagation and noise measurements during the initial site assessment
- Mitigation of interference between links

The Contractor shall install the cabinets, detectors, and transceivers at the Stations and Hubs approved by the Engineer. The Contractor shall interface the transceivers to the radar detectors at the Stations and the transceivers to the Tone Telemetry equipment at the Hubs.

If required, the Contractor shall provide additional phone circuits and relocate additional tone equipment to the Hub. The additional phone circuits are paid for under a separate pay item. The tone equipment will be relocated from other cabinets under REMOVE AND SALVAGE EXISTING TSC EQUIPMENT.

The Contractor maps one of the Hub's eight dry contacts to each detection zone of the RADAR VEHICLE DETECTOR sensors in the system. At the TSC, the Contractor shall cross-connect the incoming closures to the nearest incoming ATMS FEP detector input. (All of the existing detector equipment is cross-connected to the IDF in the Intermediate Distribution Frame (IDF)).

When all equipment is installed and connected, the Contractor shall test and demonstrate the performance and accuracy of the installed detectors. This test shall match observed and detected vehicles, as well as the ability of the

Advance Traffic Management System to collect and use the data for travel times. The accuracy of the travel times is not an issue for the Contractor, provided the detectors are reporting the vehicles' presence correctly.

Temporary Detection System, Removal and Salvage from Dan Ryan Reconstruction Contract 62583 and I-80 Reconstruction contract 62664

Removal

Removal of the temporary detection system shall meet the requirements of Section 895 of the Standard Specifications.

All of the temporary detection equipment is to be removed upon completion of the project. All equipment shall be salvaged, stored and reinstalled on one or on multiple corridors identified by the Traffic Systems Center Manager or the Engineer. These corridors are as follows: I-55 Weber Rd. to I-80, US 41 south of Deerfield Rd. to north of Park Ave. West, I-80 LaGrange Rd. to I-355, and LaGrange Rd. north and south of I-55.

Construction Requirements

Any damage resulting from the removal and transportation of the temporary detection equipment (and associated items) designated for removal and salvage as indicated in the plans, shall be repaired or replaced in-kind, at the Contractor's expense, to the satisfaction of the Engineer. The Engineer in conjunction with the TSC Engineer will be responsible for determining the extent of the damage and the suitability of repair or replacement.

No removal work shall be permitted without first notifying, and obtaining approval from, both the Engineer and Traffic Systems Engineer ((708-524-2145) at least 72 hours prior to commencing the removal operations. An inspection and approval by the Engineer in conjunction with the Traffic Systems Engineer will take place before any associated proposed temporary surveillance is approved for removal or energized for operation.

The Contractor shall provide five (5) copies of a list of equipment that is to remain the property of the Department, including model and serial numbers where applicable. Temporary detection equipment from the same location shall be boxed together (equipment from different locations shall not be mixed) and all boxes and controller cabinets shall be clearly marked and labeled with the location from which they were removed.

If necessary, the Contractor shall safely store and arrange for pick-up of all existing equipment to be returned to agencies other than the Department. The contractor shall package the equipment and provide all necessary documentation as stated above.

Method of Measurement

RVD STATION, REMOVE, SALVAGE AND REINSTALL and RVD HUB, REMOVE, SALVAGE, AND REINSTALL shall be measured per each detection station installation, station relocation, hub installation, or hub relocation.

Basis of Payment

The following items shall be paid for at the Contract Unit Price each RVD STATION, REMOVE, SALVAGE AND REINSTALL and RVD HUB, REMOVE, SALVAGE, AND REINSTALL, which price shall include all materials, equipment, and labor needed to perform work described herein.

SR06 RVD Hub/RVD Station Radio Site Survey

General

The Contractor shall provide the Department a Radio Site Survey of the identified corridors in SR04 and SR05 or as specified by the Engineer, to determine the optimum radio band to operate the wireless transfer system. The Radio

Site Survey will also determine the feasibility of the suggested RVD Hubs and RVD Stations as shown in the plans or as directed by the Engineer. It shall be the Contractor's responsibility to verify each location's viability and make any alternate site recommendations to the Department, should the viability of a particular site be in question. The final location shall be based on the Radio Site Survey. A representative of the detector manufacturer shall be on site to conduct the tests and submit a detailed map of the area with the proper setback, mounting height, remote signal and host signal strength along with alternate site recommendations to the Engineer.

Basis of Payment

This work shall be paid for at the contract unit price lump sum for RVD HUB/RVD STATION RADIO SITE SURVEY which shall be payment in full for all material, labor, equipment, tools, and all incidentals necessary to complete this work described herein and elsewhere in the contract documents.

SS01 Signal Head, 1 Face

Description. This items shall conform with Section 840 of the Standard Specifications for Road and Bridge Construction and highway standard 2371 "detail for mounting traffic signals: except as revised herein. All traffic signal sections shall have eight (8) inch lenses unless otherwise stated on the plans or directed by the signal engineer. Existing signal head(s) at locations where a new signal head, face(s) or section(s) are installed, the removal of an existing signal head, face(s) or section(s) shall be incidental to this item. Mounting hardware will be paid separately. The basis of payment is each for furnishing and installing the signal section head complete.

Basis of Payment. This work shall be paid at the contract unit price each for SIGNAL HEAD, 1 FACE as described above, which price shall be payment in full for all work as described herein and as directed by the Engineer.

SS02 Signal Section or Head, Remove And Salvage

Description. This item shall consist of removing an existing traffic signal head or section at a locations shown on the plans or as directed by the TSC Engineer. The removal of an existing traffic signal had or section will be paid only when its removal or relocation is not included in another pay item. The basis of payment is each including all labor and equipment to complete the removal of the existing signal head or section. The existing signal section(s) or head(s), when removed, shall become the property of the Contractor and the salvage value of the head(s) or section(s) is to be reflected in the unit bid price.

Basis of Payment. This work shall be paid at the contract unit price each to SIGNAL SECTION OR HEAD, REMOVE AND SALVAGE as described above, which price shall be payment in full for all work as described herein and as directed by the Engineer.

SS03 Signaling Load Relay, Mechanical

Description. This item shall consist of furnishing and installing a signal load relay, mechanical state, in a surveillance cabinet.

This item shall consist of furnishing and installing a Signal Load Relay-Mechanical type mated with Cinch series 2400 socket.

The load relay shall be able to switch 20 amperes for industrial use in multiple configuration and 30 amperes in multi-pole configuration at 120 VAC or 240 VAC, in a dust covered Jones plug. Relay shall be double pole, double throw.

The load relay shall have a mechanical life in excess of 5 million operations and shall be a Midtex type 136 or equal.

Ramp metering cabinet shall have a signal load relay installed. The signal load relay shall consist of two components, a base which is mounted on the E.S.P. Type 3 cabinet wall and a signal load relay which plugs into and is secured to the base by a locking screw. The coil of this relay shall be connected to the mark output of the signal change tone receiver. The one set of contacts of the load relay shall be used to change the ramp signals and one set of contacts shall be used to key the mark input to the signal change transmitter.

Basis of Payment. This work shall be paid at the contract unit price each for SIGNALING LOAD RELAY, MECHANICAL, which price shall be payment in full for all work as described herein and as directed by the Engineer.

SS04 Solar Panel, 10 W

Description. This item shall consist of furnishing and installing a solar panel, Solarex 10 watt range p/u MSX-10 or equivalent at various count/speed locations as directed by the Engineer.

The Contractor shall furnish and install at various existing speed/count location cabinets a solar panel attached either to a post or cabinet as directed by the Engineer. This work includes installing and wiring the control cabinet as necessary.

Basis of Payment. This work shall be paid at the contract unit price each for SOLAR PANEL, 10 W, which price shall be payment in full for all work as described herein and directed by the Engineer.

SS05 Solar Panel, 20 W

Description. This item shall consist of furnishing and installing a solar panel, Solarex 20 watt range p.u MSX-20 or equivalent at various count/speed locations as directed by the Engineer.

The Contractor shall furnish and install at various existing speed/count location cabinets a solar panel attached either to a post or cabinet as directed by the Engineer. This work includes installing and wiring the control cabinet as necessary and removing existing solar panel, returned to state stock.

Basis of Payment. This work shall be paid at the contract unit price each for SOLAR PANEL, 20W, which price shall be payment in full for all work as described herein and directed by the Engineer.

SSU1 Surge Protectors, AC Filtering

Description. This item shall consist of furnishing and installing AC power line noise surge, transient and RFI filter suppresser in an existing Traffic Systems Center cabinet as directed in writing by the Engineer.

The Contractor shall furnish and install in an existing Traffic Systems Center cabinet and EDCO SURRESTOR ACP-340 filtering surge and power line noise protector. The Contractor shall remove the old AC line filter and RFI filter before installing a new Surrestor. He shall do all the necessary drilling and tapping to proper mount the Surrestor. Miscellaneous hardware, mounting and wiring shall not be paid separately but shall be considered as incidental to the cost of this item.

Basis of Payment. This work shall be paid at the contract unit price each for SURGE PROTECTORS, AC FILTERING, which price shall be payment in full for all work as described herein and as directed by the Engineer.

ST01 TELCO Suppression

Description. This item shall consist of furnishing and installing a 66 block, silicon avalanche diode technology, transient voltage surge suppression on Telco T-1 and E-1 data lines at Communication Cross Connects, Comm Huts, or at Traffic Systems Center.

The transient voltage surge suppression shall employ silicon avalanche diode (SAD) technology which is non degrading, fast clamping, clip on with a single bus to ground to allow multiple modules to be placed in series for a quick installation.

Max operating voltage	17Vpk
Clamping voltage	20Vpk
Max operating frequency	20Mhz
Peak pulse power dissipation	15joules
Response time	<5nsec
Protection mode	Tip to Ring Tip to Ground Ground to Tip

Basis of Payment. This work shall be paid for at the contract unit price each, for TELCO SUPPRESSION, which shall be payment in full for all work described herein and as directed by the Engineer.

ST02 Telecommunication Cable Inline Connectors And Termination

Description. This item shall consist of furnishing and installing U1B inline connectors and U1Y bridging inline connectors in a junction box type "J" in the expressway median barrier wall as directed, in writing, by the Engineer.

Installation. There is an existing 100C-No. 19 telecommunication cable in the expressway median barrier wall. This cable is "spliced" in junction box type "J" at each surveillance installation and every 1500 feet in the barrier wall. In the junction box type "J" the Contractor shall remove the existing S66 telephone type terminal blocks and the Plate bracket. The Contractor shall re-terminate the 100C-No. 19 cable the installation incoming 6C-No. 19 cable with Scotchlok Brand U1B inline, sealed, moisture resistant four wire (1 full pair) connector for solid copper (16-19 AWG) cable. The 100 C-No. 19 cable shall be joined bundle for bundle, cable pair or cable pair in the junction box type "J" with the U1B and U1Y connectors. A special crimping tool shall be required for installing the Scotchlok inline connectors. All cabling shall be tied and placed in the "J" box in a neat workmanlike manner. The Contractor shall clean the interior of the "J" box ensuring it is free of debris, water and any corrosion. The Contractor shall ensure that the shielding of both incoming cables are properly bonded together with 10 AWG wire and stainless steel clamps. Contractor shall be responsible for the cost of any and all expressway lane and/or shoulder closures required to complete the work in the median barrier wall. Miscellaneous hardware shall not be paid separately but considered as incidental to the cost of this item.

Basis of Payment. This work shall be paid at the contract unit price each, TELECOMMUNICATION CABLE INLINE CONNECTORS AND TERMINATION, which payment will be paid in full for all the work described herein.

ST03 Telecommunication Cable - No. 19/3 Pair

Description. This item shall consist of furnishing and installing telephone cable intended for direct burial in P-duct or G.S. conduit. The number of conductors shall be twisted into pairs stranded into a cable core and enclosed in two polyethylene jackets, with a copper shield between the inner and outer jackets.

All No. 19 electric cable shall conform with these specifications and the current addition of the Rural Electrification Specification for fully color-coded, polyethylene or crystalline propylene/ethylene copolymer-insulated, double polyethylene copolymer-insulated, double polyethylene-jacketed telephone cables for direct burial PE 54. The No. 19 cables shall be installed in complete spans.

Material and Testing. No. 19 electric cable shall meet the requirement set forth in the REA Specification PE 54.

Conductors. Each conductor shall be a solid round wire of commercially pure annealed copper. Conductors shall meet the requirements of ASTM Designation B-3, latest issue, except that the requirements for dimensions and permissible variations are waived.

Conductor Insulation. Each conductor shall be insulated with colored insulating grade high density polyethylene or crystalline propylene/ethylene copolymer. The manufacturer shall have the option of using either of the above materials.

Identification of Pairs. The polyethylene or propylene copolymer compounds used for conductor insulation shall be colored so as to identify (1) the "tip" and "ring" conductor of each pair, and (2) each pair in the completed cable.

Standards of Color. The colors of insulated conductors supplied in accordance with this specification shall fall within the limits of standards of color as defined by the Munsell Color Notations specified in paragraph 4.031.

Twisting of Pairs. The insulated conductors shall be twisted into pairs.

In order to provide sufficiently high crosstalk losses at voice and carrier frequencies, the pair twists shall be designed to enable the cable to meet the pair-to-pair capacitance unbalance requirements and the crosstalk requirements.

Core Covering. The core shall consist of an inner jacket of polyethylene applied over the completed core, a metal shield, and an outer jacket of polyethylene.

Shield. A gopher-resistant corrugated shield of fully annealed copper shall be applied longitudinally over the inner jacket. The shield shall completely cover the inner jacket and shall be so constructed that the completed cable shall meet the bending requirements given in paragraph 9 of Rural Electrification Specification PE-54. The shield shall provide 100% electrical shielding plus resistance to gopher attack or other severe service conditions.

Mutual Capacitance. The average mutual capacitance of all pairs in any reel shall be in accordance with the following table:

<u>Number of Cable Pairs</u>	<u>Average Mutual Capacitance</u>	
	<u>mf/mile</u>	<u>(mf/km)</u>
3	0.083 plus or minus 0.010 (0.052 plus or minus 0.006)	
6, 12	0.083 plus or minus 0.007 (0.052 plus or minus 0.004)	
18 or more	0.083 plus or minus 0.004 (0.052 plus or minus 0.002)	

Mutual capacitance is the effective capacitance between the two wires of a pair.

Capacitance Unbalance: (Pair to Pair): Pair-to-pair capacitance unbalances as measured on the completed cable at a frequency of 1000 plus or minus 100 Hz shall not exceed the following values:

<u>Number of Cable Pairs</u>	<u>Pair-to-Pair Capacitance Unbalance (Max)</u>	
	<u>mmf/kf</u>	<u>(mmf/km)</u>
	<u>Max. Individual</u>	
Less than 12	100 (181.1)	

Capacitance Unbalance - (Crosstalk Loss): The r.m.s. output-to-output far-end crosstalk loss as measured on the completed cable at a frequency of 150 kHz shall be not less than 73 db per 1,000 feet (67.8 db per kilometer) for cable sizes of 6 pairs and larger. The r.m.s. calculation shall be based on the combined total of all adjacent and alternate pair combinations within the same layer and center to first layer pair combinations.

Capacitance Unbalance - (Pair to Shield): Pair-to-shield direct capacitance unbalances as measured on the completed cable at a frequency of 1000 plus or minus 100 Hz shall not exceed the following values:

<u>Number of Cable Pairs</u>	<u>Pair-to-Shield Capacitance Unbalance (Max)</u> <u>mmf/kf (mmf/km)</u> <u>Max. Individual</u>
Less than 12	250 (820)

Conductor Resistance. The DC. resistance of any conductor as measured on the completed cable shall not exceed the following values when measured at or corrected to 20° C.

<u>AWG</u>	<u>Maximum Resistance</u> <u>ohms/kf (ohms/km)</u>
19	8.7 (28.5)

Basis of Payment. This work will be paid for at the contract price per lineal foot for TELECOMMUNICATION CABLE - NO. 19/3 PAIR of the number of conductors specified, which price or prices shall be payment in full for furnishing all materials, making all electrical connection and installing the cable in place.

ST04 Telecommunication Cable- No. 19/25 Pair

Description. It is the intent of this specification that a continuous communication cable be installed on the Expressway and be connected to the Traffic Systems Center. All surveillance installations along the Expressway will be connected to this cable which shall be connected to the Traffic Systems Center building approximately East Avenue and the Eisenhower Expressway. This item shall consist of furnishing and installing a 25 pair No. 19 gauge wire, telephone type cable, with all necessary connection blocks, binding posts, connections and all necessary miscellaneous hardware. The 25 pair No. 19 cable shall conform with these specifications and the current edition of The Rural Electrification Specification (REA) PE-39.

Material & Construction. The #19 telecommunication cable shall meet the requirements set forth in the REA Specification PE-39. Shielding shall be fully annealed solid copper. Shielding between cables shall be bonded together by a #10 AWG copper wire and stainless steel clamps.

Testing. Once the telecommunications cable is installed the Contractor in the presence of the TSC Engineer shall test the cable. The type of test performed shall be an end to end test with Halcyon type equipment transmitting and receiving at each end of the cable. Each pair shall be tested and the results shall be recorded and submitted to the Engineer. If any results don't fall within the requirements set forth in (REA) PE-39, the Contractor shall correct and re-test that cable pair. Traffic Systems will tolerate only one pair out of every 100 pair of cable that doesn't meet or exceed specifications set forth in (REA) PE-39.

Installation Details. The telecommunication cable shall be installed in the median barrier wall where a 4-inch P.V.C. duct shall be provided for its installation. The Contractor shall insure that the telecommunication duct is continuous, free of debris and not connected to the electrical lighting cable duct.

"Junction boxes" or cross connect terminals shall be installed in or at the median barrier wall at every Surveillance installation, as shown on the plans, and every 1500 feet. The cable shall be continuous between runs. No splices will be allowed in the cable. Should it not be possible to run the cable continuous between surveillance installation, the interconnection of the cable will be allowed in the "junction box" with U1B/U1Y connectors or equal. These "splices" shall be held to a minimum and maximum cable lengths shall be used to reduce the number connections.

The cables shall be terminated in a Surveillance installation cabinet as shown on the plan. The cables shall be connected on a type 66 connector block which shall be mounted in the cabinet. The Surveillance installation shall be connected to the appropriate cable pair on the 66 blocks with a 6C-No. 19 cable. Two (2) type 66 connecting blocks shall be required per 50 pair cable installation; four (4) type 66 connecting blocks shall be required per 100 pair cable installation.

The type 66 quick connect terminal blocks shall be furnished with tin lead plated clips manufactured to Western Electric Specification #669A. There shall be eight spring clips, which are electrically and mechanically common to each other, to a row and 25 rows of spring clips. The type 66 connecting block shall be 13-5/16 x 3-3/8 x 1-1/8. The block shall be molded of self extinguishing material and shall have molded in fanning strips on each side which shall be marked every five rows. The top

of the block shall be lettered by rows (A-B-C etc.) and the retaining plate shall be numbered every other row and lettered on the top to correspond to the face of the block. The Contractor shall insure that none of the spring clip rows are shorted together or shorted to the junction box or cabinet. The Contractor shall supply the type 66 block with high impact PVC, transparent snap on protective covers. The Contractor shall spray the spring clips with a protective coating after all wires are terminated. A punch down impact tool will be required to make the connection to the type 66 block. The punch down, impact tool shall be equal to or exceed the Harris Dracon DELUX Automatic Impact Tool D814 for Type 66 blocks only.

When installing the tele-communication cable, the Contractor shall extend his installation and connection of the cable to the next adjacent surveillance installation or "junction box" beyond the limits of his contract section. He shall be responsible for insuring that the cable is continuous and connected from one contract section to the other.

Basis of Payment. This work shall be paid at the contract price per lineal foot for TELECOMMUNICATIONS CABLE - NO. 19/25 PAIR which price shall be payment in full for furnishing all materials, making all electrical connections and installing the cable complete in place.

Connecting blocks, terminal blocks, wiring, mounting brackets, U1B/U1Y connectors, and miscellaneous hardware will not be paid separately, but shall be considered as incidental to the cost of this item.

ST05 Telecommunication Cable, Install Only

Description: This item shall consist of retrieving from the State's storage facility, installing and testing telecommunication cable of the type and size specified. There are several sizes of cable at the State's storage facility: 25 pair, 50 pair, and 100 pair No. 19.

Material and construction: The #19 telecommunication cable shall meet the requirements set forth in the REA Specification PE-39. Shielding shall be fully annealed and solid copper. Shielding between cables shall be bonded together by a #10 AWG copper wire and stainless steel clamps.

Testing: Once the telecommunications cable is installed, the Contractor (in the presence of the TSC Engineer) shall test the cable. The type of test performed shall be an end to end test with Halcyon type of equipment transmitting and receiving at each end of the cable. Each pair shall be tested and the results shall be recorded and submitted to the Engineer. If any results don't fall within the requirement set forth in (REA) PE-39, the Contractor shall correct and re-test that cable pair.

Installation Details: The telecommunication cable shall be installed in the median barrier wall where a 4-inch P.V.C. duct shall be provided for its installation. The Contractor shall insure that the telecommunication duct is continuous, free of debris and not connected to the electrical lighting cable duct.

"Junction boxes" or cross connect terminals shall be installed in or at the median barrier wall at every surveillance installation, as shown on the plans, and every 1500 feet. The cable shall be continuous between runs. No splices will be allowed in the cable. Should it not be possible to run the cable continuous between surveillance installations,

the interconnection of the cable will be allowed in the “junction box” with U1B/U1Y connectors or equal. These “splices” shall be held to a minimum and maximum cable lengths shall be used to reduce the number of connections.

The cables shall be terminated in a surveillance installation cabinet as shown on the plan. The cables shall be connected on a type 66 connector block which shall be mounted in the cabinet. The surveillance installation shall be connected to the appropriate cable pair on the 66 blocks with a 6C-No. 19 cable. Two (2) type 66 connecting blocks shall be required per 50 cable installation.

The type 66 quick connect terminal blocks shall be furnished with tin lead plated clips manufactured to Western Electric Specification #669A. There shall be eight spring clips, which are electrically and mechanically common to each other, to a row and 50 rows of spring clips. The type 66 connecting block shall be 13-5/16 x 3-3/8 x 1-1/8. The block shall be molded of self extinguishing material and shall have molded in fanning strips on each side which shall be marked every five rows. The top of the block shall be lettered by rows (A-B-C) etc. and the retaining plate shall be numbered every other row and lettered on the top to correspond to the face of the block. The Contractor shall insure that one of the spring clip rows are shorted together or shorted to the junction box of cabinet. The Contractor shall supply the type 66 block with high impact PVC, transparent snap-on protective covers. The Contractor shall spray the spring clips with a protective coating after all wires are terminated. A punch down impact tool will be required to make the connection to the type 66 block. The punch down, impact tool shall be equal to or exceed the Harris Dracon DELUX Automatic Impact Tool D814 for type 66 blocks only.

When installing the telecommunication cable, the Contractor shall extend his installation and connection of the cable to the next adjacent surveillance installation or ‘junction box’ beyond the limits of his contract section. He shall be responsible for insuring that the cable is continuous and connected from one contract section to the other.

Basis of Payment: This work shall be paid at the contract price per lineal foot for Telecommunications Cable, Install Only which price shall be payment in full for furnishing all materials, making all electrical connections and installing the cable complete in place.

Connecting blocks, terminal blocks, wiring mounting brackets, U1B/U1Y connectors, and miscellaneous hardware will not be paid separately, but shall be considered as incidental to the cost of this item.

STN1 Tone Power Supply

Description. Under this item, for a unit price each as shown in the schedule of prices, and when directed by the Engineer in writing, the Contractor shall furnish a power supply (QEI Model P 21 or equivalent) in strict accordance with supplement and specified herein.

The power supply shall operate on input voltage of 117 VAC allowing for 10% variation in line voltage.

The power supply shall provide a regulated 12 VDC output at 1.7 amps.

Each tone equipment mounting frame field located or office located, shall have its own regulated power supply, capable of operating at least ten tone modules in any combination of transmitters and receivers.

The power supply shall have floating type gold plated connection to insure good connection.

The front panel of the power supply shall have an on/off switch and a yellow LED that indicates the status of the output DC voltage.

The power supply shall contain a switch and L.E.D. on the front panel to permit the monitoring of the supply voltage with the existing Traffic Systems Center tone test meter.

The power supply shall be fused.

The power supply shall have a DC voltage control.

Basis of Payment. This work shall be paid at the contract unit price each for furnishing a Power Supply (QEI Model QP21 or equivalent), TONE POWER SUPPLY, which price shall be payment in full for all work as described herein and as directed by the Engineer.

STN2 Tone Rack Cradle Assembly for Field

Description. This work consists of furnishing and installing a field tone rack cradle assembly per typicals TY-1 TSC-400#6 and #7 at a location designated by the Engineer.

Basis of Payment. This work shall be paid at the contract unit price each for FIELD TONE RACK CRADLE ASSEMBLY FOR FIELD, which shall be payment in full for all work as described herein and as directed by the Engineer.

STN3 Tone Receiver, F.S.K.

Description. Under this item, for a unit price each as shown in the schedule of prices, and when directed by the Engineer in writing, the Contractor shall furnish and install FSK tone receiver (QEI Model TSC445R or equivalent).

The requirements as to the programmable channel frequency range, channel spacing, holding of shifted frequency and operating voltage shall be the same as those for 3 Frequency Transmitter.

Input sensitivity of tone receiver shall be adjustable down to -45 dbm. The dynamic range shall be 25 db.

Adjacent channel attenuation shall be at least 35 db.

Each receiver shall be capable of test operation of at least 30 pulses per second.

Each receiver shall have one single pole, double throw, mark relay output and single pole, double throw space output relay.

Each receiver shall also have carrier detector circuit with one single pole double throw relay output.

All output relays contacts shall be capable of handling a minimum of 30 VA continuously. Any substitution shall be subject to written approval of the Engineer.

Receiver shall have L.E.D. indicators for Mark-Red, Space-Yellow and Carrier Green, visible through the face panel.

The receiver shall have a floating type gold plated connector to insure good connection.

Receiver shall operate in a space hold, 2 state operation.

An attenuation plug shall be provided to set sensitivity level of receiver.

Each receiver shall come with 2 spare relays as above.

Test points through front face plate shall be provided to test for DC voltage levels.

Basis of Payment.

Under this item, for a unit price each as shown in the schedule of prices, and when directed by the Engineer in writing, the Contractor shall furnish and install an FSK TONE RECEIVER (QEI Model TSC445R or equivalent).

STN4 Tone Transmitter, F.S.K.

Description. Under this item, for a unit price each as shown in the schedule of prices, and when directed by the Engineer in writing, the Contractor shall furnish and install an F.S.K. tone transmitter (Regular)(QEI Model TSC 445T or equivalent) in strict accordance specified herein.

Telemetry equipment shall be furnished and installed in the Traffic Systems Center office and along expressway at locations designated in these Special Provisions and in strict accordance with these specifications.

Communication line from field located cabinets to the Traffic Systems Center Office will be via 3002 Channel, C1 conditioning, Type 7FDDC telephone pairs leased by the Traffic Systems Center, or telecommunication cable in the barrier wall.

All tone transmitters and tone receivers shall be three frequency frequency-shift; that is equipment which the center frequency is normally on at all times and electrically shifted +30 Hz to a higher frequency (mark) or -30 Hz to a lower frequency (space). Other frequency shifts from +10 to +300 shall be user selectable.

All transmitters, receivers and power supplies shall be of the modular plug in type construction. The circuitry of each unit shall be protected U-shaped metal chassis, cadmium plated with irradiate finish.

All tone equipment shall be physically interchangeable with existing Traffic Systems Center tone equipment, that is furnished tone equipment shall be directly compatible with and replaceable by existing tone equipment with no modification to any hardware.

All transmitters, receivers and power supplies shall be solid state. All transistors shall be silicon, excepting the power transistors in power supplies. All transmitters and receivers IC's shall be plug in.

All transmitters and receivers shall be programmable frequency-shift key units. These FDM units shall have a universal card which is field programmable for any channel frequency or shift. The frequencies available shall be in the range of 120 HZ to 5235 Hz in increments of 5 Hz. The shifts available shall be 10, 25, 30, 35, 42.5, 60, 70, 75, 120, 150, 240, and 300 Hz. A new center frequency or shift shall be field programmed by simply changing setting of the program switch or plug-in jumpers.

All transmitters and receivers shall be capable of being operated at any frequency shall be clearly visible through or on the front of each transmitter and receiver. Such indication will always correspond to the frequency of the elements currently operating in each module. Contractor shall supply 500 complete sets of pre-printed tags for labeling the units indicating the center frequency.

Transmitters and receivers shall work into a communication link with standard impedance of 600 ohms.

Transmitters and receivers shall be individually fused.

Mechanical and Environmental Requirements:

Field Units:

Receivers, transmitters and power supplies shall be capable of operation in field cabinets which provide protection against direct contact with the elements with no special provisions for environmental; control.

All field located tone equipment shall be mounted in the traffic control cabinets as designated elsewhere in these specifications.

All field located tone equipment shall be capable of operation on a temperature range of -30 degrees to +60 degrees Celsius and shall have P.C. boards coated for protection against humidity in the range of 0% to 96%.

All field tone equipment shall be capable of being tipped, while in operation, from the vertical to the horizontal position and back again, without having adverse effect on the continuous operation of the transmitter, receiver or power supply.

Basis of Payment. This work shall be paid at the contract unit price each for TONE TRANSMITTER, F.S.K., which price shall be payment in full for all work as described herein and as directed by the Engineer.

SU01 UPS System, Inspection

Description. The Contractor shall furnish a factory sales and service company to complete an annual comprehensive UPS inspection as specified herein at the Traffic Systems Center.

Location. This work shall apply to the monitoring UPS system located at 445 W. Harrison St., Oak Park, IL 60304

Work Description. Cyberex 75 KVA 3 Phase uninterruptible supply unit with 90 each-PRC 1280-12 volt - 80AH battery storage units.

The inspection shall consist of but not be limited to the following items, which are described below:

- (A) Initial checks - System energized and carrying a customer's load.
 - 1. Verify initial, as found, voltage and current on the following:
 - a) Rectifier input
 - b) Rectifier output
 - c) Inverter output
 - d) Alternate line

- (B) System in bypass and de-energized - Customer's load on alternate line.
 - 1. Verify the following:
 - a) Bolted, screw and crimp connections for tightness
 - b) Relays, seated properly
 - c) Wiring, for electrical and physical damage
 - d) Capacitors, for bulging and/or leaking
 - e) Proper alignment of all sliding P.C. Boards
 - f) Plugs, for proper electrical and physical connection
 - g) P.C. Boards, for over-temperaturing
 - h) Vacuum system (if customer has vacuum available)

- (C) System in bypass and energized - Customer's load on alternate line.
 - 1. Verify the following:
 - a) All alarms and indicators for proper function and operation
 - b) Measure and adjust all critical logic settings
 - c) Battery Plant:
 - 1)Volts per cell
 - 2) Pilot cell temperature
 - 3) Pilot cell specific gravity
 - 4) Water levels
 - 5) Visual inspection of interior and intercell connections
 - 2. Short term (2 Minute) discharge test using the inverter as the load to evaluate battery condition. (Only with customer prior approval)
 - 3. All battery data recorded in site log book.

- (D) Final Checks - System energized and carrying customer's load.
 - 1. Verify final voltage and current on the following:

- a) Rectifier input
- b) Rectifier output
- c) Inverter output
- d) Alternate line

(E) Report - The service engineer shall provide a detail service report to the TSC Manager along with any service recommendations for additional service which they believe may be required but not covered under their service agreement.

Method of Measurement. Each inspection that is completed shall be recorded on vendor furnished forms, with all its corresponding deficiencies noted and the inspection report submitted to the Engineer. Any necessary repairs shall be paid on an as needed basis through vendor item.

Basis of Payment. This item shall be paid at the contract unit price each for the UPS SYSTEM, INSPECTION, which shall be payment in full for the work described above.

SU02 U.P.S. System, Storage Battery, Remove And Replace

Description. This item shall consist of removal, disposal and replacement of a existing storage battery for U.P.S. system located at TRAFFIC SYSTEMS CENTER, 445 West Harrison St., Oak Park, Illinois.

Materials. All materials shall conform to Cyberex battery PRC 1280 - 12 VOLT or equivalent.

Basis of Payment. This work will be paid at the contract unit price each for a U.P.S. SYSTEM, STORAGE BATTERY, REMOVE AND REPLACE, which price shall be payment in full for all necessary removal and disposal of existing storage battery and installing new storage battery.

SV01 Vendor Budgetary Allowance for Repair Services

Description. This item is to establish a budget account to allocate funds for the payment of various types of non-routine repair services required for those changeable message signs utilizing Telespot equipment and components.

These services, including associated modifications to the equipment, are required for the continuing maintenance program but which can not be accurately or completely identified nor specified properly as necessary for preparation of the bidding document for this contract because of Telespot's apparent discontinuance of manufacturing and support. This item requires immediate service to support the operational requirements of freeway-installed changeable message signs but is not for services included under Routine Maintenance.

Basis of Payment. The Engineer will evaluate the quotations and authorize work accordingly. The total estimated amount of annual expenses to be incurred for goods and services performed under this item is \$40,000 as indicated under pay item SV1, as a budgetary allowance for repair services.

SV02 Vendor Budgetary Allowance for ATMS Maintenance/Support

Description. This item is to establish a budget account to allocate funds for ATMS maintenance and support from the approved vendors of the hardware and software to continue maintenance and support of the ATMS at the Traffic Systems Center.

These services, including associated modifications to the equipment, are required for the continuing maintenance program but which can not be accurately or completely identified nor specified properly as necessary for preparation of the bidding document for this contract. This item is for immediate service to support the operational requirements of the traffic management system but is not for services included under Routine Maintenance.

Illinois Department Of Transportation
Electrical Maintenance Contract # 60E15
Section 2 – Special Provisions

Various Routes
Section 2008-002TS
Various Counties

Basis of Payment. The Engineer will evaluate the quotations and authorize work accordingly. The total estimated amount of annual expenses to be incurred for goods and services performed under this item is \$75,000 as indicated under pay item SV02, as a budgetary allowance for repair services.

Traffic Signal System Non-Routine Pay Items:

TC01–TC02 Full Actuated Controller in Cabinet

Description. This item shall conform with sections 857 of the Standard Specifications for Road and Bridge Construction and District 1 Traffic Signal Specifications except as revised herein. All equipment shall be NEMA TS II Type I unless otherwise approved by the Engineer. At the time this item is authorized, the Signal Engineer may indicate what brand of equipment is to be supplied for that authorization. Installation of controller and cabinet, including all testing, shall be included in these items. Removal of any existing controller, cabinet, and all other related equipment in the cabinet is considered included in this item. The Contractor shall deliver the removed equipment to the state stock storage location per the requirements within the contract.

Basis of Payment. This work shall be paid at the contract unit price each for FULL ACTUATED CONTROLLER IN CABINET of the type specified as described above, which price shall be payment in full for all work as described herein and as directed by the Signal Engineer.

TC01 Full Actuated Controller In Type IV Cabinet

TC02 Full Actuated Controller In Type V Cabinet

TC03 Full Actuated Controller in Type IV Cabinet With RR Equipment

Description. This item shall conform with sections 857 of the Standard Specifications for Road and Bridge Construction, District 1 Traffic Signal Specifications and the provision of Pay Item TC1 in this contract except as revised herein. The controller and cabinet furnished is to be installed at an intersection which is interconnected with a railroad gate controller cabinet. Equipment shall be NEMA TS II Type I unless otherwise approved by the Engineer. At the time this item is authorized, the Signal Engineer may indicate what brand of equipment is to be supplied for that authorization. At all Railroad locations which are not part of a closed loop system (stand alone), the controller and cabinet shall meet the following. The controller cabinet shall contain a 56 kbps auto dial/Auto answer modem. The cabinet shall be provided with an outdoor network interface for the termination of the telephone service. It shall be mounted to the inside of the cabinet suitable to provide access for the termination of the telephone service and shall be equipped with a standard three electrode heavy duty gas tube surge arrestor. Installation of controller and cabinet, including all testing, shall be included in this item. Removal of any existing controller, cabinet, and all other related equipment in the cabinet is considered included in this item. The Contractor shall deliver the removed equipment to the State stock storage location per the requirements within the contract.

Basis of Payment. This work shall be paid at the contract unit price each for FULL ACTUATED CONTROLLER, IN TYPE IV CABINET WITH RAILROAD EQUIPMENT as described above, which price shall be payment in full for all work as described herein and as directed by the Signal Engineer.

TC04 Full Actuated Controller

Description. This item shall conform with sections 857 of the Standard Specifications for Road and Bridge Construction and District 1 Traffic Signal Specifications. Equipment shall be NEMA TS II Type I unless otherwise approved by the Engineer. At the time this item is authorized, the Signal Engineer may indicate what brand of equipment is to be supplied for that authorization. Removal of the existing controller and related items, if required, shall be considered included in this item. The Contractor shall deliver the existing equipment to the State stock storage location per the requirements within the contract.

Installation of the controller and testing shall be included in this item. When installing the new controller into an existing system, the new controller shall contain all necessary telemetry modules, modems, circuit panels and wiring harnesses. All items necessary to

enable the controller to communicate/operate within an existing FSK closed loop system or an existing fiber optic closed loop system shall be included in this item.

Basis of Payment. This work shall be paid at the contract unit price each for FULL-ACTUATED CONTROLLER as described above, which price shall be payment in full for all work as described herein and as directed by the Signal Engineer.

TC05–TC06 Install Existing Traffic Signal Controller or Controller and Cabinet

Description. These items shall conform with sections 857 of the Standard Specifications for Road and Bridge Construction and District 1 Traffic Signal Specifications except as revised herein. Included in the above pay items are the replacement and/or addition of controller harnesses, conflict monitor harnesses, and detector harnesses as required to install the existing controller and/or cabinet at a location directed by the Signal Engineer. The current controller software at time of field installation shall be included in these items. The Contractor shall provide five (5) copies (11" x 17") of the cabinet wiring diagrams for the new cabinet location. Cable logs must be furnished indicating the number of each cable, the field termination point, and all cables must be tagged with an I.D. number corresponding with the cable log. As included in this item, the Contractor shall transport the proposed equipment to the intersection and transport the existing equipment to the Contractor's location for state stock storage.

Basis of Payment. This work shall be paid at the contract unit price each for INSTALL EXISTING TRAFFIC SIGNAL CONTROLLER, OR CONTROLLER AND CABINET as described above, which price shall be payment in full for all work as described herein and as directed by the Signal Engineer.

TC05 INSTALL EXISTING TRAFFIC SIGNAL CONTROLLER

TC06 INSTALL EXISTING TRAFFIC SIGNAL CONTROLLER AND CABINET

TC07 Controller Cabinet, Type IV

Description. This work shall consist of furnishing and installing a cabinet and peripheral equipment for an existing traffic signal controller.

Materials. Materials shall be according to the following Articles of Section 1000 – Materials:

Item	Article/Section
Controller Cabinet and Peripheral Equipment	1074.03

General. The cabinet shall be furnished with panel, terminal facilities, conflict monitor, load switches, and flasher relays complete with necessary connections for proper operation. The type of cabinet shall be as specified on the plans.

Basis of Payment. This work shall be paid at the contract unit price each for CONTROLLER CABINET, TYPE IV, of the type specified as described above, which price shall be payment in full for all work as described herein and as directed by the Signal Engineer.

TC08 Controller And Cabinet Modification

Description. This item shall conform with Section 857 of the Standard Specifications for Road and Bridge construction. This work shall consist of controller and cabinet revisions to provide an additional phase, phase overlap, or pedestrian movement to an existing traffic signal. This work to include but not limited to installing a load switch cabinet wiring, and reprogramming the controller per plans or as directed by the engineer.

Basis of Payment. This work shall be paid for at the contact unit price each to provide CONTROLLER AND CABINET MODIFICATION as described above, which price shall be payment in full for all work described herein and as directed by the Signal Engineer.

TC09–TC10 Communications Control Equipment

Description. This item shall conform with sections 857 and 864 of the Standard Specifications for Road and Bridge Construction and the District 1 Traffic Signal Specifications except as revised herein. This item may be used in conjunction with the items for "Full Actuated Controller in Cabinet" or it may be used with an existing cabinet. This item shall include the installation of all items necessary to enable the controller and cabinet to communicate as part of either an FSK or fiber optic closed loop system, as specified. Any modifications or equipment which needs to be removed from an existing cabinet to convert it from FSK/wire to fiber optic shall be included in this item. The Contractor shall deliver any existing equipment to the State stock storage location per the requirements of the contract.

Basis of Payment. This work shall be paid at the contract unit price each for COMMUNICATIONS CONTROL EQUIPMENT of the type specified as described above, which price will be payment in full for all work as described herein and as directed by the Signal Engineer.

TC09 FSK/Wire Communications Control Equipment
TC10 Fiber Optic Communications Control Equipment

TC11 Traffic Signal Master Controller

Description. This item shall conform with section 860 of the Standard Specifications for Road and Bridge Construction and District 1 Traffic Signal Specifications except as revised herein. Equipment shall be NEMA TS II Type I unless otherwise approved by the Engineer. The master controller may be installed in an existing controller cabinet replacing an existing master controller of the same, or different, manufacturer or at a new location. In all cases the Contractor shall furnish all necessary harnesses, relays, modems, transceivers, and telephone jack to place the proposed traffic signal master controller in operation. Locations where the master controller is installed within an existing system without the local traffic signal controllers being replaced, it shall be of the same manufacturer as the local controllers. The closed loop systems presently in use are manufactured by Siemens/Eagle Signal and Econolite Corporation. At the time this item is authorized, the Signal Engineer will indicate which manufacturer's equipment is to be supplied for that authorization. At the completion of installing the proposed master controller the Contractor shall, if applicable, remove the existing master controller, harnesses, relays, modems, and transceivers that are not used and deliver them to the State stock storage location per the requirements within the contract. A telephone line and modem for proper communication if not pre-existing shall be paid for separately under the item "Telephone Line and Modem".

Basis of Payment. This work shall be paid at the contract unit price each for TRAFFIC SIGNAL MASTER CONTROLLER as described above, which price shall be payment in full for all work as described herein and directed by the Signal Engineer.

TC12 Install Telephone Line And Modem

Description. This item shall conform with section 857 of the Standard Specifications for Road and Bridge Construction and the District 1 Traffic signal Specifications except as revised herein. This work shall consist of providing a phone line from the Illinois Bell System to a traffic signal controller cabinet to provide a working remote monitoring capabilities by the IDOT Traffic Signal Engineer in the Schaumburg office. The phone line shall be capable of providing regular or ISDN communication as required by the Engineer. The contractor shall provide an approved phone company junction box inside the controller cabinet, a 56K band modem as recommended by the equipment supplier, and all wiring necessary to the master controller or controller to provide proper communications. Able and conduit from the Illinois Bell System to the cabinet phone junction box will be paid for separately.

The contractor shall accomplish this work in the following process utilizing District 1 staff:

As soon as practical or within one week after the contract has been awarded, the Contractor shall contact (via phone) the Administrative support Manager in the District 1 Business Services Section at 847-705-4011 to request a phone line installation.

A follow-up fax transmittal to the Administrative Support Manager (847-705-4712) with all required information pertaining to the phone installation is required from the Contractor within one week after the initial request has been made. A copy of this fax transmittal must also be faxed by the Contractor to the Traffic Signal Systems Engineer at 847-705-4089. The required information to be supplied on the fax shall include (but not limited to): A street address for the new traffic signal service is needed; the name and number of the Contractor's employee for the telephone company to contact regarding site work and questions.

The usual time frame for the activation of the phone line is 4-6 weeks after the Business Services Section has received the Contractor supplied fax. It is, therefore, imperative that the phone line conduit and pull-string be installed by the Contractor in anticipation of this time frame. On jobs which include roadway widening in which the conduit cannot be installed until this widening is completed, the Contractor will be allowed to delay the phone line installation request to the Business Services Section until a point in time that is 4-6 weeks prior to the anticipated completion of the traffic signal work.

The telephone line shall be installed and activated one month before the system final inspection.

All phone company costs associated with the telephone line installation and activation (not including the contract specified conduit installation between the point of telephone service and the traffic signal controller cabinet) shall be paid by the district One Business Services Section (i.e., this will be an IDOT phone number not a Contractor phone number).

BASIS OF PAYMENT:

This work shall be paid for at the contract unit price each and to install a working INSTALL TELEPHONE LINE AND MODEM as described above, which price shall be payment in full for all work as described herein and directed by the Signal Engineer.

TC13 Install Updated Prom Set At Existing Local Or Master Controller

Description. This item shall consist of installing a new PROM or set of PROMS of the latest version of software in an existing traffic signal local or master controller. At locations that contain coordination modules, all PROMS in the controller, telemetry module, and coordination module must be of the same version and revision. New system interface board shall be included in this item.

Basis of Payment. This work shall be paid at the contract unit price each for INSTALL UPDATED PROM SET AT EXISTING LOCAL OR MASTER CONTROLLER, as described above, which price shall be payment in full for all work as described herein and as directed by the Signal Engineer.

TC14 NEMA Conflict Monitor/ MMU with Event Logging

Description. This item shall conform with sections 857 of the Standard Specifications for Road and Bridge Construction and District 1 Traffic Signal Specifications except as revised herein. This item includes all labor and harnesses required to install an EDI Model SSM-12LE or MMU-16 NEMA type conflict/voltage monitor with event logging or an approved equal in an existing traffic signal controller cabinet as directed by the Signal Engineer. Remove all existing conflict monitor/ MMU harnesses not reused and the existing conflict monitor/ MMU from the cabinet and deliver them to the State stock storage location per the requirements of the contract.

Basis of Payment. This work shall be paid at the contract unit price each for NEMA CONFLICT MONITOR/ MMU WITH EVENT LOGGING as described above, which price shall be payment in full for all work as described herein and as directed by the Signal Engineer.

TC15 UPS System

Description. This specification sets forth the minimum requirements for a system that provides an uninterruptible power supply (UPS) for signalized intersections. This work shall consist of furnishing and installing a UPS as specified by the Standard Specifications for Road and Bridge Construction and District 1 Traffic Signal Specifications.

Basis of Payment. This work shall be paid at the contract unit price each to install UPS SYSTEM as described above, which price shall be payment in full for all work as described herein and as directed by the Signal Engineer.

TCS1 Portable Changeable Message Sign

Description. This specification sets forth the minimum requirements for use of a portable changeable message sign intended to advise motorists of future or current conditions. This device should operate with LEDs, have a programmable message sign capable of displaying varying fonts, and alphanumeric messages. The device must be capable of displaying three lines with a minimum 12" x 18" characters.

The sign must be solar powered with battery back up. The message should be legible from a minimum of 600' and have a total display of at least approximately 70" x 120". Ver-macPCMS-1210, Wanco WTMMB-s-LL(A), or approved equivalent.

Basis of Payment. This work shall be paid for at the contract unit price each for Portable Changeable Message Sign, which shall include payment in full for furnishing, installing and removing, maintaining, and programming one sign for a minimum of fourteen (14) days or as directed by the Engineer.

TD01 Drill Existing Handhole

Description. Refer to District 1 Traffic Signal Specifications.

Basis of Payment. This work shall be paid at the contract unit price each for DRILL EXISTING HANDHOLE as described above, which price shall be payment in full for all work as described herein and as directed by the Signal Engineer.

TE01–TE06 AND TEC1–TEC2 Electric Cable

Description. This item shall conform with section 873 of the Standard Specifications for Road and Bridge Construction and the District 1 Traffic Signal Specifications, or as directed by the Engineer. When a new cable is being installed to replace an existing cable, the removal of the existing cable shall be included in this item. This item shall be used for cable installed in a raceway, conduit or aerial suspended.

Basis of Payment. This work will be paid at the contract unit price per foot of ELECTRIC CABLE of the type, size, and number of conductors specified, which price shall be payment in full for furnishing the material, making all electrical connections, and installing the cable complete.

The type specified will indicate whether it is shielded and the method of installation. For example: Electric Cable No. 14, 2/C Twisted, Shielded.

TE01 Electric Cable No. 14 2/C

TE02 Electric Cable No. 14 3/C

TE03 Electric Cable No. 14 5/C
TE04 Electric Cable No. 14 7/C
TE05 Electric Cable No. 14 2/C, Twisted Shielded
TE06 Electric Cable No. 18, 3 Pair, Twisted Shielded
TEC1 Electric Cable in Conduit, Tracer No. 14 1/C
TEC2 Electric Cable No. 14, 3/C, Railroad

TF01–TF06 Concrete Foundations

Description. These items shall conform with Section 878 of the Traffic Specifications and District 1 Traffic Signal Specifications and as directed by the Signal Engineer.

Basis of Payment. This work will be paid at the contract unit price per foot of depth for CONCRETE FOUNDATION of the type specified, which price shall be payment in full for all necessary excavating or drilling, backfilling, disposal of unsuitable material, form work, and furnishing all materials within the limits of the foundation including anchor bolts. If rock excavation is required it will be paid in accordance with Article 109.04 of the Standard Specifications.

TF01 Concrete Foundation, Type A
TF02 Concrete Foundation, Type D
TF03 Concrete Foundation, Type E 24 inch Diameter
TF04 Concrete Foundation, Type E 30 inch Diameter
TF05 Concrete Foundation, Type E 36 inch Diameter
TF06 Concrete Foundation, Type E 42 inch Diameter

TF07 Concrete Foundation, Rebuild/Modify, Type D

Description. This item shall consist of the partial removal of an existing Type "D" Foundation at the location on the plans or as directed by the Signal Engineer. The existing foundation shall be removed to a depth of at least 0.3048m (twelve inches) below finished grade. The disposal of the concrete debris outside of the right-of-way shall be included in this item. The existing conduit shall remain in place and shall be carefully protected. The new conduits from the double handhole shall be installed, if required, as shown on the plans.

Installation. Upon completion of the above work, holes for steel dowels of the size indicated shall be drilled in the remaining concrete where indicated on the drawings.

The adjacent area shall be excavated and formed with anchor bolts and new conduit stubs to provide a concrete foundation for a Type IV cabinet as per the current Highway Standard, "Concrete Foundation Details". The Contractor shall follow the recommendations of the manufacturer, subject to approval of the Engineer.

Provide a 36" x 48" x 5" P.C.C. apron sidewalk on the side of the access door to the controller to facilitate servicing the controller.

Anchor bolts shall be new and shall meet all the requirements of sections 800 and 1000 of the Standard Specifications for Road and Bridge Construction.

Basis of Payment. This work shall be paid at the contract unit price each for CONCRETE FOUNDATION, REBUILD/MODIFY, TYPE D, which price shall be payment in full for all labor, materials, and equipment necessary to complete the work described above and as indicated on the drawings. The removal of the existing controller shall be included in this pay item, as well as the pulling and reinstalling of the existing cable from conduit.

TFB1 Flashing Beacon, Post Mount, 1 Face

Description. This item shall conform with sections 800 and 1000 of the Standard Specifications for Road and Bridge Construction. District 1 Traffic Signal Specifications and the current Highway standard, "Details of Spanwire Mounted Signal and Flashing Beacon Installation" except as revised herein. This item shall consist of installing a post mounted 300mm (twelve inch) L.E.D. single section red or yellow flashing beacon on an existing post as shown on the plans or directed by the Signal Engineer. This item shall include furnishing and installing a flasher controller in an aluminum cabinet, or integrated within the head, service installation (post mounted), 300mm (twelve inch) L.E.D. red or yellow signal section with a dimmer if required by the Signal Engineer, and all other includeds necessary to complete the installation.

As directed by the Signal Engineer or if shown on the plans, the Contractor may be instructed to provide LED displays as opposed to standard incandescent signal sections. All lamps are considered included in this item.

Basis of Payment. This work shall be paid at the contract unit price each to install FLASHING BEACON, POST MOUNT, 1 FACE as described above, which price shall be payment in full for all work as described herein and as directed by the Signal Engineer.

TFB2 Flashing Beacon, Span Wire Mounted

Description. This item shall conform with the Standard Specifications for Road and Bridge Construction, District 1 Traffic Signal Specifications and the current Highway standard "Details of Spanwire Mounted Signals and Flashing Beacon Installations" except as revised herein. This item shall include furnishing and installing a flasher controller in an unpainted aluminum cabinet, or integrated within the head, service installation (post mounted), any number of 300 mm (twelve inch) L.E.D. signal faces, red or yellow with a dimmer if required by the Signal Engineer, wood poles, span wire and span wire accessories, electrical conduit, electric cable, trench and backfill and all other includeds necessary to complete the installation.

As directed by the Signal Engineer or if shown on the plans, the Contractor may be instructed to provide LED displays as opposed to standard incandescent signal sections. All lamps are considered included in this item.

Basis of Payment. This work shall be paid at the contract unit price each to install FLASHING BEACON, SPAN WIRE MOUNTED as described above, which price shall be payment in full for all work as described herein and as directed by the Signal Engineer.

TFB3 Flashing Beacon, Solar, Post Mount, 1 Face

Description. This item shall conform with sections 800 and 1000 of the Standard Specifications for Road and Bridge construction and District One Traffic Signal Specifications. This item shall consist of furnishing and installing a 300mm (12-inch) single red or yellow flashing module on a new or existing post as shown on the plans or directed by the engineer. This item shall include furnishing and installing a flasher controller that is integrated within the signal head, with discrete solar panels, LED module, battery, electronics, compact housing and capable of operating 24 hours, 7 days a week.

The flasher unit shall install on standard wood or metal posts. The flash pattern shall be MUTCD compliant and have alternate flash patterns available. The LED module shall be ITE VTCSH-STD Part-2 compliant.

The flasher unit shall operate over a maximum temperature range of -40° F to 176° F.

The battery shall have a life span of a minimum of 5 years and be field replaceable. The battery and electronics may be located inside the solar panel housing or signal head.

The sections of the flasher unit shall be secured with tamper resistant stainless steel hardware and unless otherwise noted, the housing shall be black in color.

Basis of Payment. This work shall be paid for at the contract unit price each for FLASHING BEACON, SOLAR, POST MOUNT, 1 FACE FLASHER UNIT, of the color LED, as described above, which price shall be payment in full for furnishing and installing a post mounted flasher with all mounting hardware.

TGS1 Additional Grounding And Electric Service Upgrade

Description. The Contractor shall perform additional electric service and grounding upgrades as specified to the traffic signal system locations as designated by the Engineer. (This work is for additional locations, over and above the 200 locations to be upgraded under routine maintenance).

Work Description. The contractor is responsible for scheduling the work and for coordinating with the engineer whenever Engineer-witness functions are required. The contractors shall also advise the engineer when each location is complete and shall provide a written certification to that effect. The Engineer reserves the right to require a final inspection of the modification at any or all of the locations certified as complete. Should deficiencies be found upon inspection, a corrective work list will be prepared.

The traffic signal installations being modified shall be kept operational at all times except as expressly allowed herein or otherwise permitted by the Engineer. The Contractor shall be responsible for all traffic control and temporary provisions required for the work, all at no additional cost to the pay item. All cable, conduit, fittings and accessories shall be new. All materials and work shall be in conformance with the requirements of applicable contract specifications and article 250 of the National Electrical Code.

The Contractor shall be responsible for coordination with the Electric Utility as necessary and shall be responsible for reporting any account modifications arising from the work to the Engineer in a timely manner. Although it is anticipated that all service agreements and accounts will remain as-is, if new agreements are required, the Contractor shall facilitate coordination between the Electric Utility and the Engineer, with the department to sign any appropriate new agreements. Only momentary outage of a traffic signal location undergoing modification will be allowed, and the contractor shall provide generator power or make temporary service connections as necessary to assure continuity of operations as modifications are made.

The work will generally include:

- Replacement of the electric service entrance equipment and cables
- New grounding of the service
- New feeder conductors from the service disconnect to the controller cabinet
- Cabinet grounding modifications
- Supplementary ground electrodes at handholes
- Extension of equipment ground wires to all poles, posts, handholes, etc.
- Bonding of equipment ground to all exposed metal parts
- Testing and documentation

Replace Electric Service Entrance

The work shall include the removal of the existing service disconnecting means and the service conductors and shall include the furnishing and installing a new pole-mounted service disconnecting means and new service conductors, based on the manner of the existing service. The new electric service disconnect, cables and the service connection shall be in accordance with details included herein, and Figure L-3A, as shown in Volume 1, Article 7, unless specified otherwise by the Engineer to meet special requirements of certain locations, pedestrian traffic, etc.

Provide New System Ground of Electric Service

The work shall include the installation of a new system ground, connected to the ground bar of the service disconnect, using one or more ground rod grounding electrodes, or other means approved by the Engineer. The system ground shall have a resistance to earth not to exceed 10 ohms without connection to the additional electrodes established at poles or other points at the traffic signal location. The system ground resistance shall be verified by a contractor test, using the fall-of potential method and witnessed and approved by the engineer, with a record of the test entered by the Contractor and signed by the Contractor and the Engineer. Should more than one electrode be required to establish a low enough resistance, additional electrodes shall be connected to the grid, with re-testing. All ground electrode

connections shall be exothermically welded. Ground rods and grounding electrode conductors shall be as specified and detailed.

The service grounded circuit conductor (which may or may not be a system neutral) shall be bonded to the system ground at the service disconnect and shall be isolated from ground throughout the remainder of the electrical distribution.

Extend New Conductors to Controller

A new ground terminal bar shall be installed at the traffic signal control cabinet and this bar shall be bonded to the cabinet enclosure. The work shall include the replacement of the existing feeder and the extension of new feeder conductors from the service disconnect to the traffic signal control cabinet. The cable will be a multi-conductor jacketed cable as specified and it shall include a green-insulated ground wire to bond the service ground bar to the controller cabinet ground bar. The contractor shall confirm the integrity of the existing feeder conduit run, and shall clean the run before installing the new feeder. If the size of the conduit is demonstrated to be inadequate for the new feeder cable or if it is demonstrated as not re-usable for some other reason and no other alternative is feasible, the contractor shall use a new feeder conduit run, as part of this pay item, with all cable work remaining as the Contractor's responsibility at no additional cost to the pay item.

Cabinet Grounding Modifications

The contractor shall confirm the presence of a terminal bar, with suitable terminals, for the grounded circuit conductor (white wire) at the controller cabinet and shall assure isolation of this bar from the cabinet enclosure and other grounded parts. If the existing bar is inadequate or is not isolated properly, the Contractor shall provide a new bar or otherwise correct the installation, removing any incorrect items. Similarly, the contractor shall confirm the presence of a ground bar, with suitable terminals, which is bonded to the cabinet enclosure and grounded metal parts. If the existing ground bar is inadequate or is not bonded properly, the Contractor shall provide a new bar or otherwise correct the installation, removing any incorrect items, as included in this pay item.

Supplementary Ground Electrodes

A ground rod shall be driven at traffic signal handholes present at each corner of a location (but not within the roadway) except for handholes within 15 feet of the service ground electrode. The ground rods shall be as specified and all connections directly to the ground rods shall be exothermically welded.

Extension of Equipment Ground

The contractor shall extend an equipment ground conductor from the ground bar in the controller cabinet to distributed elements of the system, bonding the equipment ground conductor to all handhole frames, metal poles and other enclosures, metal conduit, etc., including any existing supplemental ground rods that may be in place. The Contractor shall assure that good equipment ground continuity and a low-impedance ground return path is established throughout for all exposed metal parts of the installation.

It is not the intent of this work item to require re-cabling of the traffic signal load equipment to achieve grounding. In all cases, a green-insulated ground conductor shall be used whenever possible, and only if conduit space will not accommodate an insulated conductor will a bare conductor be allowed. A common conductor may be employed for multiple load circuit cables in a given conduit, but an equipment ground conductor shall be run with or shall encircle each set of circuit conductors extended from the controller cabinet.

Recognizing the intent to leave existing conductors in place and operations, the contractor may chose from among identified and prioritized acceptable alternative to affect the grounding modifications:

If an existing conduit will accommodate the installation of a ground wire, the ground wire shall be installed within the conduit with the circuit conductors. Existing conductors should only be withdrawn from a conduit run to facilitate pulling of the ground wire if absolutely necessary.

If an existing metal conduit will not accommodate the required ground wire, and if the contractor can identify end-to-end electrical continuity of the conduit, the contractor may bond to the conduit externally in an approved manner to establish ground continuity, thus using the metal conduit as the equipment ground conductor.

If a given conduit run is demonstrated to be damaged and electrically discontinuous in the presence of the Engineer, and if no other alternative is feasible, the engineer will authorize a new conduit run, to be paid under separate pay time, with all cable installation to remain part of the grounding modification work at no additional cost to the pay item. When a new conduit is installed, an insulated ground conductor must be installed within, together with the circuit conductors, regardless of the ground continuity of the new conduit, and the new conduit shall be appropriately bonded to the equipment ground.

Bonding

The Contractor shall establish equipment ground bonding to the cover frame of every handhole with an approved connection. The contractor shall establish equipment ground bonding at every metal pole, post or other enclosure or device, also with an approved connecting. At poles or post bases, it may be possible to install washers, lugs, and extra nuts where extra anchor bolt protrusion allows it. Otherwise, poles may be drilled and tapped and fitted with appropriate ground lugs. Connections at poles and other enclosures shall be pigtailed from splices whenever more than one ground conductor is connected so that ground continuity is not dependent upon ground lug connection. Splices of ground conductors (in lieu of exothermic weld connectors) will be permitted at poles or other such connection point above grade, with splices to be made using suitable copper crimp sleeves and heat-shrink insulated caps as specified.

Testing and Documentation

As noted above, the system ground resistance to earth shall be tested, in isolation from equipment ground extensions from that point. Testing shall be performed by the contractor using the fall-of-potential method, with results recorded by the Contractor and witnessed by the Engineer. Ground continuity shall be tested using an approved low-impedance ohmmeter, to the farthest point of each circuit extension from the controller cabinet. Results shall be recorded by the contractor and witnessed by the Engineer.

Special Considerations

Temporary signal installations and other span-wire installations shall be included in the scope of service and grounding modifications. For span-wire installations, the messenger wire shall be employed as an equipment ground conductor and taps shall be made to this wire to extend an equipment ground connection to appropriate exposed metal parts. A service grounding electrode shall be established at the electric service disconnect and a ground rod shall be installed and connected at one pole per quadrant.

Method of Measurement. Each traffic signal grounding modification and electric service upgrade as performed as specified and inspection report submitted and approved by the Engineers shall be counted as unit for payment.

Basis of Payment. This item shall be paid at the contract unit price each for TRAFFIC SIGNAL ADDITIONAL GROUNDING AND ELECTRIC SERVICE UPGRADE, which shall be payment in full for the work described herein.

TL01 Inductive Detector Loop

Description. This work shall consist of furnishing and installing inductive loop detector

Materials. Materials shall be according to the following Articles/Section 1000 – Materials”

Item	Article/Section
(a) Inductive Loop detector	1079.01

Construction Requirements:

Installation:

The inductive loop detector shall be installed inside traffic signal controller cabinet. The detector shall be either card rack type or shelf-mounted type. The detector may be single-channel, two-channel, or four-channel.

Basis of Payment. This work will be paid for at the contract unit price each for INDUCTIVE LOOP DETECTOR which price shall include the necessary connections and adjustment for proper operation.

If the detector unit has more than one complete detection channel, each compound detection channel will be considered as a detector for payment.

TL02 Detector Loop

Description. This item shall conform with sections 800 and 1000 of the Standard Specifications for Road and Bridge Construction, District 1 Traffic Signal Specifications and the District 1 Standard Traffic Signal Design Details, except as revised herein.

1. Asphalt Pavement

Detector loop which is to be installed in the proposed asphalt pavement must be placed in the pavement below the surface course. The location of each dive hole shall be marked on the face of the curb or handhole with a saw cut.

2. Existing Asphalt Pavement

Detector loop which is to be installed in an existing asphalt pavement shall be located to miss existing pavement cracks, if possible. The saw cut is to be filled with sealant to 3.0mm (one-eighth inch) below the surface of the pavement.

3. Concrete Pavement

Detector loop which is to be installed in concrete pavement must be placed to miss pavement joints and cracks, if possible. The saw cut is to be filled with sealant to one-eighth inch below the surface of pavement.

Loop Preparation

All detector loop saw cuts shall be a minimum of one and one half inches and a maximum of two inches, and the depth shall be equal to the saw cut. Saw cuts across the corners are NOT allowed. The saw cut shall be a minimum of five-sixteenths inches wide and cut in accordance with local and EPA dust control requirements. Detector loop(s) shall not be installed in wet conditions and the saw cuts must be free of debris and residue such as dust and water which is to be achieved by the use of compressed air, wire brushing and heat drying according to sealant manufacturer requirements. The detector wire shall be held in place by the use of form wedges of sufficient diameter and strength to hold the wire one inch below the surface of the pavement. Wedges shall be spaced no more than eighteen inches apart. The wire from the detector loop to the handhole shall have six twists per foot and have a separate unit duct raceway from the edge of pavement to the handhole. The unit duct shall be one foot into the pavement and loop under the curb and gutter. The unit duct shall be placed at a thirty inch depth.

Contractor Loop Identification

The loop detector wire shall be spliced in the handhole and each lead-in wire shall be labeled in the handhole using a Conduit 250W175C waterproof tag or approved equal secured to each wire with nylon ties. Each lead-in cable tag shall indicate the location of the loop, loop rotation (clockwise/counterclockwise), loop lead-in direction (in or out), loop cable number, location in cabinet, and number of turns in the detector loop using waterproof ink as indicated on the District 1 Loop Detail. The Contractor shall mark loop locations on as-built plans and present to the Engineer after final inspection.

Six foot round loop(s) may be substituted for six foot by six foot square loop(s) and shall be paid as 24 feet of detector loop.

Basis of Payment. This work shall be paid at the contract unit price per foot for DETECTOR LOOP as described above, which price shall be payment in full for all work as described herein and as directed by the Signal Engineer.

TLS1 LED Illuminated Sign

Description. This item shall conform with the Standard Specifications for Road and Bridge Construction and the District 1 Traffic Signal Specifications, except as revised herein. This work shall consist of furnishing and installing

an Illuminated Sign, LED type with blank out ability indicating the symbolic legend for “No Right Turn” or “No Left Turn” as required by the Signal Engineer.

Basis of Payment. This work shall be paid at the contract unit price each for LED ILLUMINATED SIGN which price shall be payment in full for furnishing and installing the illuminated sign complete.

TM01 Microwave Vehicle Sensor

Description. This item shall consist of furnishing and installing a Microwave Vehicle Sensor in accordance with these requirements.

The microwave vehicle sensor shall be approved by IDOT before furnishing and installing. The Contractor shall install, wire, and adjust the alignment of the sensor in accordance to the manufacturer's recommendations and requirements. The installation shall be approved by the Engineer.

The microwave vehicle sensor shall meet the following requirements:

- Detection Range - Adjustable to 60 feet
- Detection Angle - Adjustable, horizontal and vertical
- Detection Pattern -16° beam width minimum. (at 50' the pattern shall be approximately 15.5' wide)
- Mounting -Heavy duty bracket, predrilled and slotted for pole mounting
- Visible detection indicator light

Basis of Payment. This work will be paid at the contract unit price each for MICROWAVE VEHICLE SENSOR, which price shall be payment in full for furnishing and installing the Microwave Vehicle Sensor complete in place.

TMA1–TMA5 Steel Mast Arm Assembly And Pole

Description. This item shall conform to the requirements of sections 877 of the Standard Specifications for Road and Bridge Construction, the District 1 Traffic Signal Specifications and the current Highway Standard, "Steel Mast Arm Assembly and Pole", except as revised herein.

Prior to the final acceptance of any Steel Mast Arm Assembly and Pole, Contractor must furnish to the Engineer a certified, notarized mill analysis of the material used in the Steel Mast Arm Assembly and Pole.

This item, when applicable, shall include the relocation of existing sign panels currently installed at the location.

If the proposed mast arm assembly is replacing an existing mast arm, the removal of the existing mast arm assembly shall be included in this item. The Contractor shall retain ownership of the existing mast arm assembly.

The mast arm shroud shall be included in this item and shall be galvanized steel or extruded aluminum for protection of the mast arm pole base plate similar to the dimensions detailed in the “District 1 Standard Traffic signal Design Details.” The shroud shall be of sufficient strength to deter pedestrian and vehicular damage. The shroud shall allow it to circulate throughout the mast arm but not allow manifestation of insects or critters. The shroud shall be constructed, installed, and designed not to be hazardous to probing fingers and feet. All mounting hardware shall be stainless steel.

Shroud shall fit any pole size supplied by the manufacturer

Basis of Payment. This work shall be paid at the contract unit price each for furnishing and installing a STEEL MAST ARM ASSEMBLY AND POLE as described above, which price shall be payment in full for all work as described herein and as directed by the Signal Engineer.

TMA1 Steel Mast Arm Assembly and Pole 16 ft to 28 ft

TMA2 Steel Mast Arm Assembly and Pole 30 ft to 44 ft
TMA3 Steel Mast Arm Assembly and Pole 46 ft to 55 ft
TMA4 Steel Mast Arm Assembly and Pole 56 ft to 65 ft
TMA5 Steel Mast Arm Assembly and Pole 66 ft to 75 ft

TMA6 Relocate or Install Existing Mast Arm Assembly And Pole

Description. This item shall conform with sections 877 of the Standard Specifications for Road and Bridge Construction and District 1 Traffic Signal Specifications except as revised herein. The Mast Arm Assembly and Pole shall come from State stock or be relocated from one foundation to another foundation at the same intersection or another intersection as indicated on the plans. All transportation costs to move the mast arm assembly and pole from State stock to an intersection or from intersection to intersection are included in this item. Existing holes in the Mast Arm Assembly and Pole shall be plugged as directed by the Signal Engineer. If the existing mast arm has an existing galvanized metal shroud, it shall be relocated along with the mast arm as included in this item. Otherwise, the Contractor shall be required as part of this item to install at the base of the mast arm, stainless steel screening in accordance with the Standard Specifications; or the Contractor may be required to install a mast arm shroud as described in TMA1-5 in lieu of stainless steel screening as directed by the Signal Engineer. The cost of furnishing and installing a new shroud shall be included in this item.

Basis of Payment. This work shall be paid at the contract unit price each for RELOCATE OR INSTALL EXISTING MAST ARM ASSEMBLY AND POLE, as described above, which price shall be payment in full for all work as described herein and as directed by the Signal Engineer.

TPP1 Pedestrian Push-Button Post, Galvanized Steel, Type II

Description. This work shall consist of furnishing a pedestrian push-button post and installing it on a concrete foundation.

Materials. Materials shall be according to the following Articles of section 1000 – Materials:

Item	Article/Section
a. Pedestrian Push-Button	1074.02
b. Traffic signal Post	1077.01
c. Concrete	1020

Construction Requirements.

Installation.

The pedestrian push-button post shall be installed plumb on a concrete foundation according to the details shown on the plans. The contractor shall apply an anti-seize post compound on all nuts and bolts prior to assembly.

The foundation shall be made Class SI concrete.

Basis of Payment. This work will be paid for at the contract unit price each for PEDESTRIAN PUSH-BUTTON POST, TYPE II, GALVANIZED STEEL, , which shall be payment in full for the work described herein.

TPP2 Pedestrian Push-Button

Description. This item shall conform with sections 888 and 1074 of the Standard Specifications for Road and Bridge Construction and District 1 Traffic Signal Specifications except as revised herein. The Pedestrian Push-button assembly shall be one piece cast aluminum alloy with momentary LED such as the Campbell 4EVR 120 or Polara

Bulldog type, or an approved equivalent and include pedestrian push button station and sign. See District One Specifications for Pedestrian Station and Sign Requirements.

Basis of Payment. This work shall be paid at the contract unit price each for PEDESTRIAN PUSH-BUTTON as described above, which price shall be payment in full for all work as described herein and as directed by the Signal Engineer.

TR01 Rotate Signal Phasing at an Existing Traffic Signal Intersection

Description. This item shall consist of revising the traffic signal phasing at an existing traffic signal intersection. The proposed sequence of operation shall conform with the current "Standard Phase Designation Diagrams and Phase Sequences" Highway Standard, the District's phase diagrams and notes, the District's chart sequence of operations or as directed by the Signal Engineer. The phase rotation shall consist of the following items to complete the phase rotation:

1. Modify all incoming field wiring to provide the new sequence of operations which includes all signal heads, pedestrian heads, internally illuminated signs, emergency vehicle preemption confirmation beacons, vehicle detectors, pedestrian detectors and system detectors.
2. Modify the controller programming and phase overlaps to provide the proposed sequence of operations.
3. All back panel modifications are required to provide the proposed sequence of operations and system detection.
4. The Contractor shall provide five (5) copies (11" x 17") of revised cabinet wiring diagrams.
5. The Contractor shall provide revised cable logs indicating the number of each cable, the field location the cable is terminated at, and all cables must be tagged with an I.D. number that corresponds with the revised cable log.

Basis of Payment. This work shall be paid at the contract unit price each for ROTATE SIGNAL PHASING AT AN EXISTING TRAFFIC SIGNAL INTERSECTION as described above, which price shall be payment in full for all work as described herein and as directed by the Signal Engineer.

TR02 Re-Assign System Detectors

Description. This work shall consist of reassigning system detectors in an existing Closed Loop System as per the plan or as directed by the Signal Engineer. This may include rewiring system detectors to different inputs into the local controller, installing diodes to provide a second channel of detector output to use an existing local detector as a dual system/local detector, changing system detector assignments, wiring system detectors directly to a master controller or rewiring system detectors to different inputs in the master controller. Any additional amplifiers or dual output amplifiers that are necessary will be paid separately, otherwise all remaining materials and labor required to complete this work shall be included in this item.

Basis of Payment. This work shall be paid at the contract unit price for 1 each RE-ASSIGN SYSTEM DETECTORS, which will include all necessary reassigning of system detectors at one signalized intersection.

TS01 Manhole Cover And Frame Grounding Furnish And Install

Description. Refer to TRAFFIC SIGNAL SPECIFICATIONS, effective January 1, 2002, revised May 22, 2002, herein.

Basis of Payment. This work shall be paid at the contract unit price each for MANHOLE COVER AND FRAME GROUNDING FURNISH AND INSTALL as described above, which price shall be payment in full for all work as described herein and as directed by the Signal Engineer.

TSD1 LED Signal Display

Description. This item shall consist of installing a 12" LED Display into an existing signal section or a new signal section. The LED display shall fit into the signal housing without any modifications to the housing and meet District 1 Traffic Signal Specifications. Removal of the existing lens and reflector shall be included in this item. The existing lens and reflector shall become the Contractor's property and the unit price should reflect the salvage value of these items.

Basis of Payment. This work shall be paid at the contract unit price each for LED SIGNAL DISPLAY, which price shall be payment in full for supplying and installing a display as described herein.

TSH1–TSH3 Incandescent Signal Head, 1 Face

Description. These items shall conform with sections 880 of the Standard Specifications for Road and Bridge Construction, District 1 Traffic Signal Specifications, the current Highway Standard "Traffic Signal Mounting Details", and District 1 Standard Traffic Signal Design Details, except as revised herein. All traffic signal sections shall have incandescent optics with 300mm (twelve inch) lenses unless otherwise stated on the plans or as directed by the Signal Engineer. At locations where new signal heads are replacing existing signal heads, the removal of the existing signal heads and existing mounting hardware shall be included in these items and the Contractor shall retain ownership of the existing used signal heads.

All mounting hardware shall be new and shall be included in the pay item for signal head. The pay items listed below shall include either bracket mounts or mast arm mounts as required by the plans or directed by the Signal Engineer. Any modifications to mounting hardware shall be included in this item.

Mast arm mounted signal heads shall include louvered traffic signal backplates. The backplate shall be included in these items.

Basis of Payment. This work shall be paid at the contract unit price each for SIGNAL HEAD, 1 FACE of the number sections specified, which price shall be payment in full for all work as described herein and as directed by the Signal Engineer. Removal, salvage, or disposal of existing heads and related mounting hardware and backplates shall be included in these items.

TSH1 Signal Head, 1 Face, 3 Section
TSH2 Signal Head, 1 Face, 4 Section
TSH3 Signal Head, 1 Face, 5 Section

TSH4 Signal Head Lens

Description. This item shall conform with sections 880 of the Standard Specifications for Road and Bridge Construction and the District 1 Traffic Signal Specifications, except as revised herein. The traffic signal replacement lens shall be installed in either a eight inch or twelve inch conventional signal section. The pedestrian replacement lens shall be installed in either a nine inch or 12 inch conventional rectangular pedestrian section. The proposed replacement lens must fit the existing section in a manner that dust and water are sealed out. The color and type of replacement lens will be indicated on the plans or as directed by the Signal Engineer. The replacement lens may consist of the following types: green ball, yellow ball, red ball, green arrow, yellow arrow, red arrow, walk or don't walk. The arrow lenses shall be of the straight through, right or left types and when an arrow lens has a designation of top inscribed the lens must be installed in the signal section with that orientation. The existing lens shall be removed and disposed of at the contractor's expense.

Basis of Payment. This work shall be paid at the contract unit price each for SIGNAL HEAD LENS, as described above, which price shall be payment in full for all work as described herein and as directed by the Signal Engineer.

TSH5 Pedestrian Incandescent Signal Head, 1 Face

Description. This item shall conform with sections 881 of the Standard Specifications for Road and Bridge Construction, District 1 Traffic Signal Specifications, the current Highway Standard "Traffic Signal Mounting Details" and District 1 Standard Signal Design Details, except as revised herein. All pedestrian signal sections shall have 300mm (twelve inch) lenses unless stated on the plans or as directed by the Signal Engineer. At locations where new pedestrian signal head(s) or faces are replacing an existing pedestrian signal head(s) or faces the removal shall be included in this item and the Contractor shall retain the used existing pedestrian signal head(s) or faces. All necessary mounting hardware or modifications to existing mounting hardware shall be included in this item.

Basis of Payment. This work shall be paid at the contract unit price each for PEDESTRIAN SIGNAL HEAD, 1 FACE, as described above, which price shall be payment in full for all work as described herein and as directed by the Signal Engineer.

TSL1–TSL8 LED Signal Head, 1 Face

Description. These items shall conform with sections 880 of the Standard Specifications for Road and Bridge Construction, District 1 Traffic Signal Specifications, the current Highway Standard "Traffic Signal Mounting Details", Special Provision for Light Emitting Diode (LED) Signal Head, and District 1 Standard Traffic Signal Design Details, except as revised herein. All traffic signal sections shall have 300mm (twelve inch) lenses unless otherwise stated on the plans or as directed by the Signal Engineer. At locations where new signal heads are replacing existing signal heads, the removal of the existing signal heads and mounting hardware shall be included in this item and the Contractor shall retain ownership of the existing used signal heads.

All mounting hardware shall be new and shall be included in the pay item for signal head. The pay items listed below shall include either bracket mounts or mast arm mounts as required by the plans or directed by the Signal Engineer. Any modifications to mounting hardware shall be included in this item.

Remotely Steerable Optics:

This item shall provide a visibility zone of red, yellow and green, without requiring louvers or other external blocking devices to achieve the end result. No indication shall result from external illumination nor shall one section illuminate another. The LEDs are steered using one (1) Wi-Fi enabled PDA which is included in this contract. Manufacturer shall warrant the remotely steerable optic head to be free from defects in material and workmanship for a minimum of seven (7) years from date of turn-on.

Mast arm mounted signal heads shall include louvered traffic signal backplates. The backplate shall be included in the cost of the signal head.

Basis of Payment. This work shall be paid at the contract unit price each for LED SIGNAL HEAD, 1 FACE of the number of sections specified OR LED SIGNAL HEAD, OPTICALLY PROGRAMMED or REMOTELY STEERABLE OPTICS, 1 FACE of the number of sections specified, which price shall be payment in full for all work as described herein and as directed by the Signal Engineer. Removal, salvage, or disposal of existing heads and related mounting hardware and backplates shall be included in these items.

TSL1	LED Signal Head, 1 Face, 2 Section
TSL2	LED Signal Head, 1 Face, 3 Section
TSL3	LED Signal Head, 1 Face, 4 Section
TSL4	LED Signal Head, 1 Face, 5 Section
TSL5	LED Signal Head, Optically Programmed, 1 Face, 3 Section
TSL6	LED Signal Head, Optically Programmed, 1 Face, 5 Section
TSL7	LED Signal Head, Remotely Steerable Optics, 1 Face, 3 Section
TSL8	LED Signal Head, Remotely Steerable Optics, 1 Face, 5 Section

TSL9 LED PEDESTRIAN SIGNAL HEAD, 1 FACE

Description. This item shall conform with sections 881 of the Standard Specifications for Road and Bridge Construction, District 1 Traffic Signal Specifications, the current Highway Standard "Traffic Signal Mounting Details" and District 1 Standard Signal Design Details, except as revised herein. All led pedestrian signal sections shall have 300mm (twelve inch) lenses unless stated on the plans or as directed by the Signal Engineer. At locations where new pedestrian signal head(s) or faces are replacing an existing pedestrian signal head(s) or faces the removal shall be included in this item and the Contractor shall retain the used existing pedestrian signal head(s) or faces.

All mounting hardware shall be new and shall be included in the pay item for signal head. The pay items listed below shall include either pole mounts or post mounts as required by the plans or directed by the Signal Engineer. Any modifications to mounting hardware shall be included in this item.

Basis of Payment. This work shall be paid at the contract unit price each for LED PEDESTRIAN SIGNAL HEAD, 1 FACE, as described above, which price shall be payment in full for all work as described herein including mounting hardware and as directed by the Signal Engineer.

TSL10 LED Pedestrian Signal Head, Countdown, 1 Face

Description. This item shall conform with sections 881 of the Standard Specifications for Road and Bridge Construction, District 1 Traffic Signal Specifications, the current Highway Standard "Traffic Signal Mounting Details" and District 1 Standard Signal Design Details, except as revised herein. This work shall consist of furnishing and installing a pedestrian countdown signal head, with light emitting diodes (LED) of the type specified in the plan. At locations where new pedestrian signal head(s) or faces are replacing an existing pedestrian signal head(s) or faces, the removal shall be included in this item and the Contractor shall retain the used existing pedestrian signal head(s) or faces.

All mounting hardware shall be new and shall be included in the pay item for signal head. The pay item listed below shall include either pole mounts or post mounts as required by the plans or directed by the Signal Engineer. Any modifications to mounting hardware shall be included in this item.

Pedestrian Countdown Signal Head, Light Emitting Diode, shall be 16 inch (406mm) x 18 inch (457mm) and conform fully to the District 1 Traffic Signal Specifications.

Basis of Payment. This item shall be paid for at the contract unit price each for PEDESTRIAN COUNTDOWN SIGNAL HEAD, LED, 1 FACE, which shall be payment in full for furnishing the equipment described above including LED(s) modules, all mounting hardware, and installing them in satisfactory operating condition.

TSR1 Remove Signal Section Or Head

Description. This item shall conform with sections 880 of the Standard Specifications for Road and Bridge Construction and the District 1 Traffic Signal Specifications, except as revised herein.

This item shall consist of removing an existing traffic signal head or section at a location shown on the plans or as directed by the Signal Engineer. The removal of an existing traffic signal head or section will be paid only when its removal or relocation is not included in another pay item. The existing signal section(s) or head(s), when removed, shall become the property of the Contractor and the salvage value of the head(s) or section(s) is to be reflected in the unit bid price.

A traffic signal head with multiple faces and/or pedestrian signals mounted on the same item shall be paid at 1 each for the complete or partial removal. All remaining holes in the post or mast arm shall be plugged and any additional hardware necessary for any remaining sections shall be included in this item.

Basis of Payment. This work shall be paid at the contract unit price each to REMOVE SIGNAL SECTION OR HEAD, as described above, which price shall be payment in full for all work as described herein and as directed by the Signal Engineer.

TSR2 Relocate or Install Existing Signal Section Or Head

Description. This item shall conform with sections 800 and 1000 of the Standard Specifications for Road and Bridge Construction and the District 1 Traffic Signal Specifications except as revised herein. This item includes the relocation of traffic signal head(s) and pedestrian signal head(s). The combination of a traffic signal head and a pedestrian signal head mounted on the same traffic signal post, mast arm pole, or street lighting pole shall be considered a single unit and shall be paid as one (1) each relocate signal head. This item shall include removing a traffic signal head from one intersection, transporting it to another intersection and installing it at a new location or installing an existing signal head from State stock. Any modifications or adjustments to the existing signal head or programming of the existing signal head shall be included in this item.

All mounting hardware shall be new and shall be included in the pay item for signal head. The pay item listed below shall include either mast arm mounts, pole mounts or post mounts as required by the plans or directed by the Signal Engineer. Any modifications to mounting hardware shall be included in this item.

Basis of Payment. This work shall be paid at the contract unit price each to RELOCATE OR INSTALL EXISTING SIGNAL HEAD, as described above, which price shall be payment in full for all work as described herein and as directed by the Signal Engineer.

TT01 Temporary Traffic Signal Installation

Description. This item shall conform with sections 890 of the Standard Specifications for Road and Bridge Construction, the District 1 Traffic Signal Specifications and the current Highway Standard, "Temporary Traffic Signal", except as revised herein.

The temporary traffic signal installation when completed shall become the property of the State of Illinois. All equipment and material shall be new.

The controller shall be one of the approved District 1 Closed Loop brands and the display shall be menu driven. The controller and its associated equipment shall be housed in an aluminum traffic signal controller cabinet Type IV or Type V, as designated on the plans or by the Signal Engineer and mounted on an enclosed wood stand with a three feet by four feet by 5 inches thick and a concrete pad in front of the cabinet door. The cabinet shall contain all harnesses, load switches, flasher, conflict monitor, detector harnesses and related components required to provide the sequence of operations on the plans or as directed by the Signal Engineer.

Traffic signal heads furnished for the installation shall be LED type with expanded view and have twelve inch lenses and be painted federal yellow with flat black faces and tunnel visors. Each approach to a signalized intersection must have a minimum of three (3) signal heads spaced a minimum of eight feet apart.

Pedestrian signal heads and push-button detectors, if required, will be paid separately. All vehicle detection, when required, as part of a temporary signal installation, will be paid separately. When possible, the Department will provide the detector amplifiers for the intersection from state stock. If necessary the Department shall authorize the installation of new amplifiers through a non routine work order.

The bottom of any span wire mounted signal head (or backplate if equipped) shall be no lower than 17-ft and the top of the signal head shall be no higher than 25-ft above the crown of the road, unless otherwise directed by the Signal Engineer.

All equipment furnished and installed shall become the property of the Illinois Department of Transportation.

Basis of Payment. This work shall be paid at the contract unit price each for TEMPORARY TRAFFIC SIGNAL INSTALLATION, as described above, which price shall be payment in full for all work as described herein and as directed by the Signal Engineer. Maintenance of the temporary traffic signal installation will be paid separately after the temporary signal is approved for operation by the Department.

TTM1 Thermoplastic Pavement Marking Line 24 Inch

Description. This item shall conform with sections 700 and 1000 of the Standard Specifications for Road and Bridge Construction as directed by the Signal Engineer.

Basis of Payment. This work will be paid at the contract unit price per foot of applied line for THERMOPLASTIC PAVEMENT MARKING LINE 24 inch.

TTP1 Traffic Signal Post, 10 FT to 18 FT

Description. This item shall conform with sections 875 of the Standard Specifications for Road and Bridge Construction, the District 1 Traffic Signal Specifications and District 1 Traffic Signal Design Details except as revised herein.

When the new post is being installed on an existing foundation to replace an existing post, the removal of the existing post shall be included in this item.

Basis of Payment. This work shall be paid at the contract unit price each for TRAFFIC SIGNAL POST, 10 FT TO 18 FT as described above, which price shall be payment in full for all work as described herein and as directed by the Signal Engineer.

TTP2 - TTP3 Remove Traffic Signal Post and Remove Mast Arm Assembly and Pole

Description. These items consist of removing an existing traffic signal post or mast arm assembly and pole at a location shown on the plans or as directed by the Signal Engineer. The existing traffic signal post or existing mast arm assembly shall become the Contractor's property and the salvage value of the item shall be reflected in the unit price.

Basis of Payment. This work shall be paid at the contract unit price each for the pay items listed below and as described above, which price shall be payment in full for all work as described herein and as directed by the Signal Engineer.

- TTP2 Remove Traffic Signal Post
- TTP3 Remove Mast Arm Assembly and Pole

TTP4 Relocate or Install Existing Signal Post

Description. This item shall conform with sections 875 of the Standard Specifications for Road and Bridge Construction and the District 1 Traffic Signal Specifications, except as revised herein. Installation of an existing signal post includes transportation from the Contractor storage facilities or from one intersection to the intersection where the post is to be installed. The existing signal post will be installed on an existing or new concrete foundation. This item shall include new anchor bolts, nuts, and washers, if required, as included in this item. New concrete foundation will be paid separately.

Basis of Payment. This work shall be paid at the contract unit price each for RELOCATE OR INSTALL EXISTING SIGNAL POST, as described above, which price shall be payment in full for all work as described herein and as directed by the Signal Engineer.

TVD1 Video Detection System, Complete Intersection

Description. This specification sets forth the minimum requirements for a system that monitors vehicles on a roadway via processing of video images and provides detector outputs to a traffic controller or similar device. This work shall consist of furnishing and installing an Autoscope or approved equal video vehicle detection system including all necessary hardware, cable and accessories as specified on the plans. An extension pole for mounting video cameras, when needed or directed by the engineer, will be included in this item.

The system shall consist of four (4) image sensors, a machine vision processor (MVP) and a video monitor.

The system shall be able to detect either approaching or receding vehicles in multiple traffic lanes. With a MVP capable of handling four image sensors, there shall be a minimum of 100 detection zones that can be user-defined through interactive graphics by placing lines and/or boxes in an image or a VGA monitor. The user shall be able to redefine previously defined detection zones. The MVP shall calculate traffic parameters in real-time and provide local non-volatile data storage for later downloading and analysis.

1. FUNCTIONAL CAPABILITIES

1.1 REAL-TIME DETECTION

1.1.1 The MVP shall be capable of simultaneously processing information from up to four (4) CCTV video image sensors. The video image sensors may be, but are not required to be, synchronized or line locked. The video shall be digitized and analyzed at a rate of 30 times per second. A fifth image sensor input shall be provided on the four camera units as a surveillance video input to be switched as one of five live video sources.

1.1.2 A MVP capable of handling four image sensors shall be able to detect the presence of vehicles in a minimum of 100 detection zones within the combined field of view of the image sensors.

1.1.3 Different detector types shall be selectable via software. Detector types shall include count detectors, presence detectors, directional presence detectors, speed detectors, station detectors, input detectors, and detector logical functions. The speed detectors shall report vehicle speed and vehicle classification based on length. Three length categories shall be user-definable in software.

1.1.4 Once the MVP has been properly set up using a supervisor computer, it shall be possible to disconnect the supervisor computer. The MVP shall then detect vehicles as a stand-alone unit, calculate traffic parameters in real-time, and store traffic parameters in its own non-volatile memory.

1.1.5 The MVP shall provide the ability to compensate for minor camera movement. At a minimum, image stabilization detectors shall minimize the effects of image sensor movement. The MVP shall provide the capability to link the analog video image to the digital detector lay out as reference information for stabilization. Stabilization shall only be required if there is a motion problem observed by the user. One to five image stabilizers shall be able to be placed in the video image for each detector orientation.

1.2 LOCAL DATA STORAGE

1.2.1 The MVP shall count vehicles in real-time and compute the average of traffic parameters over user-defined time intervals (or time slices), as follows:

- a. Volume
Number of vehicles detected during the time interval.

- b. Occupancy
Lane occupancy measured in percent of time.
- c. Vehicle Classification
Number of automobiles, single unit trucks or tractor trailers, as defined by length.
- d. Flow Rate
Vehicles per hour per lane.
- e. Headway
Average time interval between vehicles.
- f. Speed
Time mean and space mean vehicle speed in M.P.H. or KM/H.
- g. Level of Service
Determined by user defined thresholds for average speed and flow rates.
- h. Space Occupancy
Sum of the vehicle lengths divided by average distance traveled during the time interval measured as percent.
- i. Density
Average flow divided by space mean speed expressed in vehicles/mile or vehicles/kilometer.

1.2.2 The duration of the time intervals (or time slices) shall be user-selectable as 10, 20, or 30 seconds, 1, 5, 10, 15, 30, or 60 minutes.

1.2.3 The time-interval data shall be retained in non-volatile EEPROM flash memory within the MVP for later transfer to a supervisor computer for analysis. The amount of memory shall be 1 MB or 2 MB as specified.

1.2.4 Retrieval of data stored in the non-volatile memory of the MVP shall be via a serial communications port. Data shall be transferred to a supervisor computer via modem and dial-up telephone connection provided in the traffic signal controller cabinet.

The Contractor shall coordinate with the telephone company and IDOT to install a standard voice-grade dial-up telephone line. Any charges by the telephone company to provide service will be paid by IDOT.

The controller cabinet shall contain a 33.6 kbps auto dial/auto answer modem.

The controller cabinet shall be equipped with surge suppressers and noise filters for the telephone line and the modem's power receptacle. These shall be three (3) stage variety containing avalanche diodes, metal-oxide varistors and gas tube arrestors.

1.3 OPERATION WITH SUPERVISOR ON-LINE

1.3.1 Once the detector configuration has been downloaded from a supervisor computer into the MVP, it shall be possible to operate the video detection system with the supervisor computer disconnected or on-line.

1.3.2 When a supervisor computer is on-line, it shall be possible to view vehicle detections in real-time as they occur on the supervisor's color VGA display.

1.3.3 It shall be possible to save the time-interval traffic data on a supervisor computer hard disk. This traffic data shall be that described in Section 1.2.1. It shall also be possible to save on hard disk the

complete time data or actuation data for each vehicle detection. The collected traffic and detection data shall be made available in readily-accessible Traffic Signal Controller format. The supervisor computer

software shall provide file management routines for efficiently filing, retrieving, and reporting of the collected traffic data.

1.3.4 It shall be possible to display the captured traffic data on the VGA screen of a supervisor computer in numeric format. The data displayed shall be for the last complete interval. Selection of the data to be displayed

shall be by pull-down menus and shall be in the form of windows under the Windows NT (latest version) graphics operating environment.

1.3.5 The MVP shall include the capability to capture a video image (snapshot) from a selected image sensor input and transmit the image to a supervisor computer for display. The captured video image shall be compressed to minimize the time needed to transmit the image. An option shall be provided to allow continuing or suspending detection while the video image is being compressed and transmitted.

1.3.6 It shall be possible to capture and store as a file the video image currently being displayed at a supervisor computer.

1.3.7 Communications with a supervisor computer shall be via either a point-to-point or multi-drop communications architecture. An error-checking and retransmission protocol shall be used for file transfer operations.

2. MVP HARDWARE

2.1 MVP MOUNTING

The MVP shall be shelf or rack mountable as necessary per the application.

2.2 MVP ENVIRONMENTAL

The MVP shall be designed to operate reliably in the adverse environment found in the typical roadside traffic cabinet. It shall meet the environmental requirements set forth by the NEMA (National Electrical Manufacturers Association) TS1 and TS2 standards. Operating temperature shall be from -35 to +74 degrees C at 0% to 95% relative humidity, non-condensing.

2.3 MVP ELECTRICAL

2.3.1 The MVP shall be nodular in design and provide processing capability equivalent to the Intel 486SX microprocessor. The bus connections used to interconnect the nodules of the MVP shall be gold-plated DIN connectors.

2.3.2 The MVP shall be powered by 115/230 VAC, 50/60 Hz, single phase, and draw a maximum of 0.25 amps, or by 190-270 VAC, 50 Hz, single phase and draw 0.12 amps. The power supply shall automatically adapt to the input power level. The MVP shall include transient protection sufficient enough to meet the requirements set forth in the NEMA TS1 and TS2 standards. Power to the MVP shall be from the transient protected side of the AC power distribution system in the traffic control cabinet in which the MVP is installed.

2.3.3 Serial communications to a supervisor computer shall be through an RS-232/RS-422 serial port. The port shall be able to download traffic data stored in non-volatile memory as well as the real-time detection information needed to show detector actuations. A 9-pin "D" subminiature connector on the front of the MVP shall be used for serial communications.

2.3.4 The MVP shall be equipped with a NEMA TS1 detector interface with 32 detector outputs. Output level shall be compatible with the NEMA TS1 and NEMA TS2 standards. A 37-pin "D" subminiature connector on the front of the MVP shall be used for interfacing to these outputs.

2.3.5 The MVP shall be available with a NEMA TS2 Type 1 detector interface, where detector information is transmitted serially via an RS-485 data path. a 15-pin "D" subminiature connector meeting the requirements of the TS2 standard shall be used for the serial detector output.

2.3.6 NEMA red/green inputs for up to 16 phases shall be available as inputs to provide controller state information for detection and Extend/Delay timing functions. A 37-pin "D" subminiature connector on the front of the MVP shall be used for these inputs.

2.3.7 The MVP shall be equipped with up to four RS-170 black and white composite video inputs, so that signals from up to four image sensors can be processed in real-time. A fifth video input on four camera units shall be provided to allow connection of a local surveillance camera or other non-detection video source. The video from the auxiliary video input shall not be processed for detection. BNC connectors on the front of the MVP shall be used for all video inputs.

2.3.8 The MVP shall be equipped with a single RE-170/NTSC composite video output. These output shall be capable of being switched to correspond to any of the video inputs, as selected remotely via a supervisor computer or front panel switch. Multiple video outputs requiring external cable connections to create a combined single video output shall not be acceptable. A BNC connector on the front of the MVP shall be used for video output.

2.3.9 As an alternate to RS-170/NTSC video format, the MVP shall be available with video inputs and outputs in the CCIR black and white format.

2.3.10 The MVP software shall be stored in flash memory within the MVP. This software shall be capable of being updated without the removal of modules or memory devices.

2.3.11 The MVP software shall include diagnostic software to allow testing the MVP functions. This shall include the capability to set and clear individual detector outputs and display the status of inputs to enable setup and troubleshooting in the field.

3. IMAGE SENSOR

3.1 The video detection system shall use medium resolution, monochrome image sensors as the video source for real-time vehicle detection. As a minimum, each image sensor shall provide the following capabilities:

- a) Images shall be produced with a CCD sensing element with horizontal resolution of at least 500 lines and vertical resolution of at least 350 lines. Images shall be output:
 - 1) As a video signal conforming to RS170, RS 170A, or NTSC specifications.
 - 2) As a video signal conforming to CCIR or PAL specifications.
- b) Useable video and resolvable features in the video image shall be produced when those features have luminance levels as low as 0.1 lux at night.
- c) Useable video and resolvable features in the video image shall be produced when those features have luminance levels as high as 10,000 lux during the day.
- d) Useable video and resolvable features in the video image shall be produced when the ratio of the luminances of the resolved features in any single video frame is 300:1.
- e) Automatic gain, automatic iris, and absolute black reference controls shall be furnished:
 - 1) Automatic iris shall operate in a damped manner with a time constant of 0.25 seconds or longer.
 - 2) Automatic gain shall operate in a damped manner with a time constant of one second, and automatic gain shall not be applied to the video signal until the lens aperture is fully opened by the automatic iris control.
 - 3) Automatic gain, automatic iris, and sensitivity shall be factory adjusted and/or modified as required for proper performance with the video detection system.
 - 4) The black level shall be adjusted to 0 IRE units.
 - 5) The iris video level shall be adjusted so that a no-contrast image has 50 IRE units of video.

- 6) The lens ALC shall be adjusted to average.
- f) An optical filter and appropriate electronic circuitry shall be included in the image sensor to suppress “blooming” effects at night.
- g) It is preferred that the image sensor video signal be crystal synchronized. Line lock synchronization, however, is acceptable.
- h) Gamma for the image sensor shall be preset at the factory to a value of 1.0.

3.2 The image sensor shall be equipped with an auto-iris lens with fixed focal length to suite the site. The maximum aperture of the lens shall be prefocused at infinity at the factory, shall not be smaller than f1.8 and the minimum aperture of the lens shall not be larger than f300.

3.3 The image sensor and lens assembly shall be housed in an environmental enclosure that provides the following capabilities:

- a) The enclosure shall be waterproof and dust-tight to NEMA-4 specifications, and shall be pressurized with an inert gas to 5 ñ 1 psi.
- b) The enclosure shall allow the image sensor to operate satisfactorily over an ambient temperature range from - 34 degrees C to +60 degrees C while exposed to precipitation as well as direct sunlight.
- c) The enclosure shall allow the image sensor horizon to be rotated in the field during installation.
- d) The enclosure shall include a provision at the rear of the enclosure for connection of power and video signal cables fabricated at the factory. Input power to the environmental enclosure shall be 115 VAC 60 Hertz, with 240 VAC 50 Hertz as an option.
- e) A heater shall be at the front of the enclosure to prevent the formation of ice and condensation in cold weather, as well as to assure proper operation of the lens’ iris mechanism. The heater shall not interfere with the operation of the image sensor electronics, and it shall not cause interference with the video signal.
- f) The enclosure shall be light-colored and shall include a sun shield to minimize solar heating. The front edge of the sunshield shall protrude beyond the front edge of the environmental enclosure and shall include a provision to divert water flow to the sides of the sunshield. The amount of overhang of the sunshield shall be adjustable to prevent direct sunlight from entering the lens.
- g) The total weight of the image sensor in the environmental enclosure with sunshield shall be less than 2.3 kg or 5 pounds.
- h) When operating in the environmental enclosure with power and video signal cables connected, the image sensor shall meet FCC class B requirements for electromagnetic interference emissions.

3.4 The video output of the image sensor shall be isolated from earth ground. All video connections from the image sensor to the video interface panel shall also be isolated from earth ground. The video output stage of the image sensor shall include transient protection to prevent damage to the image sensor due to voltage transients occurring on the coaxial cable leading from the image sensor to the MVP.

3.5 Connections for both video and power shall be made to the image sensor using a single 18-pin circular metal shell connector (Bendix PT07C-14-18P or equivalent). The mating cable shall use a right angle shell and shall be available in lengths of 5, 10, 30, and 60 feet to accommodate various installations.

3.6 A galvanized steel junction box shall be provided for each image sensor and shall be mounted on the combination traffic signal pole at the location and elevation as specified in the plans. The junction box shall contain a terminal block for terminating power to the image sensor and connection points for coaxial cables from the image

sensor and from the MVP. Nominal dimensions shall be 8.25" x 6" x 4.25" (HxWxD). The total weight of the junction box shall be less than 2.3 KG (5 pounds).

3.7 A video interface panel shall be available for installation inside of the traffic signal controller cabinet. The panel shall provide coaxial cable and image sensor AC power connection points. An Edco CX06-BNCY or approved equal transient suppresser shall be included for each image sensor. The shield side of the coaxial cable connection at the transient suppresser shall be connected to earth ground via the transient suppresser. The image sensor AC power shall be connected to the transient protected side of the AC power distribution system in the traffic signal controller cabinet in which the MVP is installed.

Power shall be provided to the image sensor via a 3/C No. 14 electric cable in accordance with the District 1 traffic signal specifications.

If the coaxial cable used to connect the video signal from the image sensor to the MVP is to be routed through a conduit containing AC power cables, the AC power cables shall use twisted wires meeting, at a minimum, IMSA 19-1 or 20-1 specifications. If unbundled AC power cables are routed with the coaxial cable, a video isolation amplifier shall be installed in place of the video interface panel. The isolation amplifier shall buffer the video signal and provide transient suppression. The isolation amplifier shall have a minimum common mode rejection ratio at 60 Hz of 100 dB.

3.8 The image sensor shall be connected to the MVP such that the video signal originating from the image sensor is not attenuated more than three (3) dB when measured at the MVP. The connection between the image sensor and the MVP shall be coaxial cable. The coaxial cable used shall be a low loss 75 ohm precision video cable (RG-59U) suited for outdoor installation, such as Belden 8281, West Penn P806, or approved equal.

4. VIDEO MONITOR

A video monitor with a minimum display of 9 inches shall be provided in the traffic signal cabinet. All necessary connections shall be provided to power and to the video outputs on the MVP. The video Pay

monitor shall be easily powered on and off as necessary for inspection of proper placement of detectors. The monitor shall display a single field of view form one image sensor at a time with all detectors for the direction overlaid on the image. The video input to the monitor shall be simply switched form one image sensor to another for routine inspection of all detection zones.

5. VEHICLE DETECTION

5.1 DETECTION ZONE PLACEMENT

The video detection system shall provide flexible detection zone placement anywhere and at any orientation within the combined field of view of the image sensors. Preferred presence detector configurations shall be lines placed across lanes of traffic or lines placed in-line with lanes of traffic. A single detector line shall be able to replace one or more conventional detector loops connected in series. Detection zones shall be able to be overlapped. In addition, detection zones shall have the capability of implementing logical functions including AND, OR, NAND, N of M and delay/extend timing.

5.2 DETECTION ZONE PROGRAMMING

5.2.1 Placement of detection zones shall be by means of a supervisor computer operating the Microsoft Windows graphics environment and a mouse. The VGA monitor shall show images of the detection zones superimposed on the video image of traffic.

5.2.2 The detection zones shall be created by using the mouse to draw detection lines on a supervisor computer's VGA monitor. The detection zones shall be capable of being sized, shaped and overlapped to provide optimal road coverage and detection. It shall be possible to save the detector configurations on disk, to down load detector configurations to the MVP, and to retrieve the detector configuration that is currently running in the MVP.

5.2.3 It shall be possible to use a supervisor computer's mouse to edit previously defined detector configurations so as to fine-tune the detection zone placement size and shape. Once a detection configuration has been created. The supervisor computer system shall provide a graphic display of the new configuration on its own VGA screen.

5.2.4 When a vehicle is within a detection zone, the detection zone shall change in color or intensity on the VGA monitor thereby verifying proper operation of the detection system. Color changes shall also be used to indicate detection delay and extension timing.

5.3 OPTIMAL DETECTION

The image sensor shall be able to view both approaching or departing traffic. A single image sensor, placed at a mounting height that minimizes vehicle image occlusion and equipped with a lens to match the width of the road, shall be able to monitor six (6) to eight (8) traffic lanes simultaneously.

5.4 DETECTION PERFORMANCE

Using an image sensor, as defined in Section 5.0, and in the absence of occlusion, the system shall be able to count vehicles with less than four (4) percent error under normal conditions (day and night) and less than seven (7) percent error under artifact conditions (such as caused by shadows, fog, rain, snow).

The volume count error shall be for the entire roadway and shall be compiled over time intervals which contain a minimum of 100 vehicles to ensure statistical significance.

6. INSTALLATION

The supplier of the video detection system shall supervise the installation and testing of the video detection system. A factory certified representative from the supplier shall be on-site during installation.

7. WARRANTY, MAINTENANCE, AND SUPPORT

7.1 The video detection system shall be warranted by its supplier for a minimum of two (2) years.

7.2 Ongoing software supported by the supplier shall include updates of the MVP and supervisor software. These updates shall be provided free of charge during the warranty period.

7.3 The supplier shall maintain a program for technical support and software updates following expiration of the warranty period. This program shall be made available to the contracting agency in the form of a separate agreement for continuing support.

Basis of Payment. This work shall be paid at the contract unit price each to VIDEO DETECTION SYSTEM, COMPLETE INTERSECTION, as described above, which price shall be payment in full for all work as described herein and as directed by the Signal Engineer.

TVD2 Video Detection System, Single Camera/Processor

Description. This item shall conform with the specification for Video Detection System (Complete Intersection) except as revised herein.

This work shall consist of furnishing and installing an Autoscope Solo or approved equal Video Detection System including all necessary hardware, cable and accessories as specified on the plans. An extension pole for mounting video cameras, when needed or directed by the engineer, will be included in this item.

The system shall consist of one Image Sensor and Machine Vision Processor (MVP) integrated into one compact unit. Rather than an MVP located in the traffic signal control cabinet, a Mini Hub shall be provided which will act

as a interface between the image sensor/MVP and the traffic controller. The Mini Hub shall be shelf mount or it shall fit a standard detector rack depending on the application.

Similarly, as with the Video Detection System (Complete Intersection), a phone modem, phone line interface and video monitor shall be provided.

The image sensor/MVP shall provide 32 detection zones for the one field of view.

The image sensor/MVP shall utilize a six pair twisted shielded cable for power and video connections from the traffic signal cabinet to the image sensor. The cable shall be in accordance with the recommendation of the manufacturer of the Video Detection System. All necessary cables, connections and hardware shall be included in this item Video Detection System (Single Camera/Processor).

Basis of Payment. This work shall be paid at the contract unit price each for VIDEO DETECTION SYSTEM, SINGLE CAMERA/PROCESSOR VIDEO DETECTION, as described above, which price shall be payment in full for all work as described herein and as directed by the Signal Engineer.

TWD1 Wireless Detection System, Complete Intersection

Description. This specification sets forth the minimum requirements for a wireless vehicle detection system that uses pavement-mounted magnetic sensors to detect the presence and movement of vehicles. This work shall consist of furnishing and installing a Sensys or approved equal wireless vehicle detection system including all necessary hardware, cable and accessories as shown on the plans and required to provide a fully operational system.

The system shall consist of a minimum of thirty (30) flush mounting pavement detector sensors, two (2) access points, two (2) repeaters and associated contact closure cards. The system shall be able to detect either approaching or receding vehicles in multiple traffic lanes. Extension poles for mounting wireless access points and repeaters shall meet the requirements of specification LP02 and be included in this item.

General:

The Detector Sensing System shall deploy a design that supports a minimum of eight sensor units being controlled by a radio repeater and a design that incorporates repeaters and a single receiver that supports a cumulative sum of eighty (80) separate detector sensors concurrently at any traffic signalized intersection. The design shall structure data transmissions in a manner as to be non-interfering with other sensors installed. This design shall include a non-interference technique that allows radio link from the detector sensor to the repeater/receiver and a radio link from each repeater to the receiver base at the traffic controller. Repeater devices shall deploy a battery operation or be provided with a battery with solar recharging installation. Batteries shall be rated for a minimum of two (2) years. Each repeater device or receiver device shall be capable of receiving up to eight (8) embedded detector sensors at a range of up to 150 feet from the repeater to the embedded detector sensor.

Epoxy fill for the roadway based on the pavement surface where the detectors are being installed with appropriate temperature ratings shall be applied.

Detector cards for traffic control detector rack positions shall be furnished. Each detector card shall be a four channel device and be capable of providing detector ground true input to the traffic controller as well as linking the detector data to a remote Ethernet port for remote monitoring, concurrently. Traffic controller detector sensor card units shall be compatible with TS-1 terminal facility terminations, unless otherwise specified on the Plans. The detector cards and Expansion Modules shall provide one detector input to the traffic controller for each detector sensor installed. Modification to the existing detector racks to accommodate the new detector may be necessary. Repeater sites are required for all embedded sensors installed in excess of 150 feet from a receiver or repeater. An additional repeater for any repeater is required for distances greater than 900 feet from a repeater or receiver and/or

does not provide sufficient radio propagation to properly support a radio link – repeater to repeater or repeater to receiver, which could occur with non-line of sight locations.

A factory representative is required at turn-on to support the radio installations and to implement the radio and device programming.

Detector Sensors:

The flush mounting pavement sensors shall be of the magnetic field (magnetometer) sensing technology capable of detecting and reporting volume count, speed, occupancy and headway, as a minimum. The sensor section of the detector shall be embedded in the roadway pavement and shall utilize a radio transmitter link for the detector to a receiver radio being provided to the traffic controller and/or central monitoring server. The detector sensor embedded in the pavement shall not exceed a four (4) inch diameter and a depth of two (2) inches and shall be installed in a four (4) inch diameter, two and a half (2.5) inch deep cored hole in the pavement, centered in the travel lane. Detector sensors, embedded at a distance greater than one-hundred and fifty (150) feet from the receiver unit installed at the traffic controller cabinet, shall have a repeater installed to relay the sensor data to the receiver. The embedded detector sensor shall be battery operated with a battery design rated for ten (10) year life in this application.

Each detector sensor unit shall self-calibrate and self-configure their electronics for proper detection application. Each sensor unit shall be provided with flash memory upgrade capability to allow upgraded operation or safety enhancements to be “flushed” into local memory without removing the device for the pavement.

Radio Transceivers:

Radio transceivers shall utilize devices that are compliant with IEEE 802.15.4 standards and are able to operate on any of the allocated 16 channels of the 2.4 to 2.48 GHz spectrum. The factory support shall include the programming of the embedded sensor time slots and shall provide a written copy of the final design to the City Traffic Engineer plus one copy for the traffic controller cabinet. One software set of device programming (GUI), if other than standard WEB Browser via SNMP protocol, shall be provided for each intersection where devices are installed. The factory representative shall certify proper installation of the devices, the radio links, device settings and the traffic controller detector assignments. The factory representative shall provide an on-site computer and shall link to the Access Box for all programming. The GUI software shall provide real time management and monitoring of the Detector Sensing System as well as the Event Processing Software. One copy of the Event Processing Software shall be provided.

Basis of Payment. This work shall be paid at the contract unit price each to WIRELESS DETECTION SYSTEM, COMPLETE INTERSECTION, as described above, which price shall be payment in full for all work as described herein and as directed by the Signal Engineer.

TWD2 Wireless Detection System, Single Approach

Description. This item shall conform with the specification for Wireless Detection System (Complete Intersection) except as revised herein.

The system shall consist of a minimum of twelve (12) flush mounting pavement detector sensors, one (1) access point, one (1) repeater and associated contact closure cards for a single intersection approach with multiple lanes.

Basis of Payment. This work shall be paid at the contract unit price each for WIRELESS DETECTION SYSTEM, SINGLE APPROACH, as described above, which price shall be payment in full for all work as described herein and as directed by the Signal Engineer.

TWI2 Wireless Interconnect System

Description. The radio interconnect system shall be compatible with Eagle or Econolite controller closed loop systems. This item shall include all materials, labor and testing to provide the completely operational closed loop system between two (2) intersections as shown on the plans. The radio interconnect system shall include the following components:

- a. Rack or Shelf Mounted RS-232 Frequency Hopping Spread Spectrum (FHSS) Radio
- b. Software for Radio Configuration (Configure Frequency and Hopping Patterns)
- c. Antennas (Omni Directional or Yagi Directional)
- d. Antenna Cables, LMR400, Low Loss. Max. 100-ft from controller cabinet to antenna
- e. Brackets, Mounting Hardware, and Accessories Required for Installation
- f. RS232 Data Cable for Connection from the radio to the local or master controller
- g. All other components required for a fully functional radio interconnect system

All controller cabinet modifications and other modifications to existing equipment that are required for the installation of the radio interconnect system components shall be included in this item.

The radio interconnect system may operate at 900Mhz (902-928) or 2.4 Ghz depending on the results of a site survey. The telemetry shall have an acceptable rate of transmission errors, time outs, etc. comparable to that of a hardwire system.

The proposed master controller and telemetry module shall be configured for use with the radio interconnect at a minimum rate of 9600 baud.

The radio interconnect system shall include all other components required for a complete and fully functional telemetry system and shall be installed in accordance to the manufacturers recommendations.

The following radio equipment is currently approved for use in Region One/District One: Encon Model 5100 and Intuicom Communicator II.

Basis of Payment. This work shall be paid at the contract unit price each for WIRELESS INTERCONNECT SYSTEM, as described above, which price shall be payment in full for all work as described herein and as directed by the Signal Engineer.

TRAFFIC SIGNAL SPECIFICATIONS

Effective: May 22, 2002

Revised: June 18, 2008

These Traffic Signal Special Provisions and the "District One Standard Traffic Signal Design Details" supplement the requirements of the State of Illinois "Standard Specifications for Road and Bridge Construction." The intent of these Special Provisions is to prescribe the materials and construction methods commonly used for traffic signal installations. All material furnished shall be new. The locations and the details of all installations shall be as indicated on the Plans or as directed by the Engineer. The work to be done under this contract consists of furnishing and installing all traffic signal work as specified in the Plans and as specified herein in a manner acceptable and approved by the Engineer.

SECTION 720 SIGNING

MAST ARM SIGN PANELS

Add the following to Section 720.02 of the Standard Specifications:

Signs attached to poles or posts (such as mast arm signs) shall have mounting brackets and sign channels which are equal to and completely interchangeable with those used by the District Sign Shops. Signfix Aluminum Channel Framing System is currently recommended, but other brands of mounting hardware are acceptable based upon the Department's approval.

DIVISION 800 ELECTRICAL

INSPECTION OF ELECTRICAL SYSTEMS

Add the following to Article 801.10 of the Standard Specifications:

All cabinets including temporary traffic signal cabinets shall be assembled by an approved equipment supplier in District One. The Department reserves the right to request any controller and cabinet to be tested at the equipment supplier facilities prior to field installation, at no extra cost to this contract. All railroad interconnected (including temporary railroad interconnect) controllers and cabinets shall be new, built, tested and approved by the controller equipment vendor, in the vendor's District One facility, prior to field installation. The vendor shall provide the technical equipment and assistance as required by the Engineer to fully test this equipment.

DAMAGE TO TRAFFIC SIGNAL SYSTEM

Add the following to Article 801.12(b) of the Standard Specifications to read:

Any damaged equipment or equipment not operating properly from any cause whatsoever shall be repaired with new equipment provided by the Contractor at no additional cost to the Contract and or owner of the traffic signal system, all as approved by the Engineer. Final repairs or replacement of damaged equipment must meet the approval of the Engineer prior to or at the time of final inspection otherwise the traffic signal installation will not be accepted. Cable splices outside the controller cabinet shall not be allowed.

RESTORATION OF WORK AREA

Add to Section 801 of the Standard Specifications:

Restoration of the traffic signal work area shall be included in the related pay items such as foundation, conduit, handhole, trench and backfill, etc. All roadway surfaces such as shoulders, medians, sidewalks, pavement, etc. shall

be replaced in kind. All damage to mowed lawns shall be replaced with an approved sod, and all damage to unmowed fields shall be seeded. Restoration of the work area shall be included in the contract without any extra compensation allowed to the Contractor.

SUBMITTALS

Revise Article 801.05 of the Standard Specifications to read:

The Contractor shall provide:

- a. All material approval requests shall be submitted at the preconstruction meeting, including major traffic signal items listed in the table in Article 801.05.
- b. All material or equipment which are similar or identical shall be the product of the same manufacturer, unless necessary for system continuity. Traffic signal materials and equipment shall bear the U.L. label whenever such labeling is available.
- c. Seven (7) copies of a letter from the Traffic Signal Contractor on company letterhead listing the contract number or permit number, project location/limits, pay item description, pay code number, manufacturer's name and model numbers of the proposed equipment and stating that the proposed equipment meets all contract requirements. The letter will be reviewed by the Traffic Design Engineer to determine whether the equipment to be used is approvable.
- d. Seven (7) copies of shop drawings for mast arm poles and assemblies, including combination mast arm poles, are required. A minimum of two (2) copies of all other material catalog cuts are required. Submittals for equipment and materials shall be complete. Partial or incomplete submittals will be returned without review.
- e. Certain non-standard mast arm poles and assemblies will require additional review from IDOT's Central Office. Examples include ornamental/decorative and non-standard length mast arm pole assemblies. The Contractor shall account for the additional review time in his schedule.
- f. The contract number or permit number, project location/limits and corresponding pay code number must be on each sheet of the letter, material catalog cuts and mast arm poles and assemblies drawings.
- g. Where certifications and/or warranties are specified, the information submitted for approval shall include certifications and warranties. Certifications involving inspections, and/or tests of material shall be complete with all test data, dates, and times.
- h. After the Engineer reviews the submittals for conformance with the design concept of the project, the Engineer will stamp the drawings indicating their status as 'Approved', 'Approved-As-Noted', 'Disapproved', or 'Information Only'. Since the Engineer's review is for conformance with the design concept only, it is the Contractor's responsibility to coordinate the various items into a working system as specified. The Contractor shall not be relieved from responsibility for errors or omissions in the shop, working, layout drawings, or other documents by the Department's approval thereof. The Contractor must still be in full compliance with contract and specification requirements.
- i. All submitted items reviewed and marked 'APPROVED AS NOTED', or 'DISAPPROVED' are to be resubmitted in their entirety, unless otherwise indicated within the submittal comments, with a disposition of previous comments to verify contract compliance at no additional cost to the contract.
- j. Exceptions, Deviations and Substitutions. In general, exceptions to and deviations from the requirements of the Contract Documents will not be allowed. It is the Contractor's responsibility to note any deviations from Contract requirements at the time of submittal and to make any requests for deviations in writing to the Engineer. In general, substitutions will not be acceptable. Requests for substitutions must demonstrate that the proposed substitution is superior to the material or equipment required by the Contract Documents. No exceptions, deviations or substitutions will be permitted without the approval of the Engineer.

MAINTENANCE AND RESPONSIBILITY

Revise Article 801.11 of the Standard Specifications to read:

- a) Existing traffic signal installations and/or any electrical facilities at all or various locations may be altered or reconstructed totally or partially as part of the work on this Contract. The Contractor is hereby advised

that all traffic control equipment, presently installed at these locations, may be the property of the State of Illinois, Department of Transportation, Division of Highways, County, Private Developer, or the Municipality in which they are located. Once the Contractor has begun any work on any portion of the project, all traffic signals within the limits of this contract or those which have the item "Maintenance of Existing Traffic Signal Installation," "Temporary Traffic Signal Installation(s)" and/or "Maintenance of Existing Flashing Beacon Installation," shall become the full responsibility of the Contractor. The Contractor shall supply the engineer and the Department's Electrical Maintenance Contractor a 24-hour emergency contact name and telephone number.

- b) When the project has a pay item for "Maintenance of Existing Traffic Signal Installation," "Temporary Traffic Signal Installation(s)" and/or "Maintenance of Existing Flashing Beacon Installation," the Contractor must notify both the Area Traffic Signal Maintenance and Operations Engineer at (847) 705-4424 and the Department's Electrical Maintenance Contractor, of their intent to begin any physical construction work on the Contract or any portion thereof. This notification must be made a minimum of seven (7) working days prior to the start of construction to allow sufficient time for inspection of the existing traffic signal installation(s) and transfer of maintenance to the Contractor. If work is started prior to an inspection, maintenance of the traffic signal installation(s) will be transferred to the Contractor without an inspection. The Contractor will become responsible for repairing or replacing all equipment that is not operating properly or is damaged at no cost to the owner of the traffic signal. Final repairs or replacement of damaged equipment must meet the approval of the Engineer prior to or at the time of final inspection otherwise the traffic signal installation will not be accepted.
- c) Contracts such as pavement grinding or patching which result in the destruction of traffic signal loops do not require maintenance transfer, but require a notification of intent to work and an inspection. A minimum of seven (7) working days prior to the loop removal, the Contractor shall notify the Area Traffic Signal Maintenance and Operations Engineer at (847) 705-4424 and the Department's Electrical Maintenance Contractor, at which time arrangements will be made to adjust the traffic controller timing to compensate for the absence of detection. See additional requirements in these specifications under Inductive Loop Detector.
- d) The Contractor is advised that the existing and/or temporary traffic signal installation must remain in operation during all construction stages, except for the most essential down time. Any shutdown of the traffic signal installation, which exceeds fifteen (15) minutes, must have prior approval of the Engineer. Approval to shutdown the traffic signal installation will only be granted during the period extending from 10:00 a.m. to 3:00 p.m. on weekdays. Shutdowns shall not be allowed during inclement weather or holiday periods.
- e) The Contractor shall be fully responsible for the safe and efficient operation of the traffic signals. Any inquiry, complaint or request by the Department, the Department's Electrical Maintenance Contractor or the public, shall be investigated and repairs begun within one hour. Failure to provide this service will result in liquidated damages of \$500 per day per occurrence. In addition, the Department reserves the right to assign any work not completed within this timeframe to the Electrical Maintenance Contractor. All costs associated to repair this uncompleted work shall be the responsibility of the Contractor. Failure to pay these costs to the Electrical Maintenance Contractor within one month after the incident will result in additional liquidated damages of \$500 per month per occurrence. Unpaid bills will be deducted from the cost of the Contract. The District's Electrical Maintenance Contractor may inspect any signaling device on the Department's highway system at any time without notification.

TRAFFIC SIGNAL INSPECTION (TURN-ON)

Revise Article 801.15(b) of the Standard Specifications to read:

It is the intent to have all electric work completed and equipment field tested by the vendor prior to the Department's "turn-on" field inspection. If in the event the Engineer determines work is not complete and the inspection will require more than two (2) hours to complete, the inspection shall be canceled and the Contractor will

be required to reschedule at another date. The maintenance of the traffic signals will not be accepted until all punch list work is corrected and re-inspected.

When the road is open to traffic, except as otherwise provided in Section 850 of the Standard Specifications, the Contractor may request a turn-on and inspection of the completed traffic signal installation at each separate location. This request must be made to the Area Traffic Signal Maintenance and Operations Engineer at (847) 705-4424 a minimum of seven (7) working days prior to the time of the requested inspection. The Department will not grant a field inspection until notification is provided from the Contractor that the equipment has been field tested and the intersection is operating according to Contract requirements. The Department's facsimile number is (847) 705-4089. The Contractor must invite local fire department personnel to the turn-on when Emergency Vehicle Preemption (EVP) is included in the project. The Contractor must notify the SCAT Consultant of the turn-on schedule, as well as stage changes and phase changes during construction.

The Contractor must have all traffic signal work completed and the electrical service installation connected by the utility company prior to requesting an inspection and turn-on of the traffic signal installation. The Contractor shall be responsible to provide a police officer to direct traffic at the time of testing.

The Contractor shall provide a representative from the control equipment vendor's office to attend the traffic signal inspection for both permanent and temporary traffic signal turn-ons. Upon demonstration that the signals are operating and all work is completed in accordance with the Contract and to the satisfaction of the Engineer, the Engineer will then allow the signals to be placed in continuous operation. The Agency that is responsible for the maintenance of each traffic signal installation will assume the maintenance upon successful completion of this inspection.

The District requires the following from the Contractor at traffic signal turn-ons.

1. One set of signal plans of record with field revisions marked in red ink.
2. Notification from the Contractor and the equipment vendor of satisfactory field testing.
3. A knowledgeable representative of the controller equipment supplier shall be required at the traffic signal turn-on. The representative shall be knowledgeable of the cabinet design and controller functions.
4. A copy of the approved material letter.
5. One (1) copy of the operation and service manuals of the signal controller and associated control equipment.
6. Five (5) copies 11" x 17" (280 mm X 430 mm) or 22" x 34" (560 mm x 860 mm) of the cabinet wiring diagrams.
7. The controller manufacturer shall supply a printed form, not to exceed 11" x 17" (280 mm X 430 mm) for recording the traffic signal controller's timings; backup timings; coordination splits, offsets, and cycles; TBC Time of Day, Week and Year Programs; Traffic Responsive Program, Detector Phase Assignment, Type and Detector Switching; and any other functions programmable from the keyboard. The form shall include a location, date, manufacturer's name, controller model and software version. The form shall be approved by the Engineer and a minimum of three (3) copies must be furnished at each turn-on. The manufacturer must provide all programming information used within the controller at the time of turn-on.

Acceptance of the traffic signal equipment by the Department shall be based upon inspection results at the traffic signal "turn on." If approved, traffic signal acceptance shall be verbal at the "turn on" inspection followed by written correspondence from the Engineer. The Contractor shall be responsible for all traffic signal equipment and associated maintenance thereof until Departmental acceptance is granted.

All equipment and/or parts to keep the traffic signal installation operating shall be furnished by the Contractor. No spare traffic signal equipment is available from the Department.

All punch list work shall be completed within two (2) weeks after the final inspection. The Contractor shall notify the Electrical Maintenance Contractor to inspect all punch list work. Failure to meet these time constraints shall result in liquidated damage charges of \$500 per month per incident.

All cost of work and materials required to comply with the above requirements shall be included in the pay item bid prices, under which the subject materials and signal equipment are paid, and no additional compensation will be allowed. Materials and signal equipment not complying with the above requirements shall be subject to removal and disposal at the Contractor's expense.

LOCATING UNDERGROUND FACILITIES

Revise Section 803 to the Standard Specifications to read:

If this Contract requires the services of an Electrical Contractor, the Contractor shall be responsible at his/her own expense for locating existing IDOT electrical facilities prior to performing any work. If this Contract does not require the services of an Electrical Contractor, the Contractor may request one free locate for existing IDOT electrical facilities from the District One Electrical Maintenance Contractor prior to the start of any work. Additional requests may be at the expense of the Contractor. The location of underground traffic facilities does not relieve the Contractor of their responsibility to repair any facilities damaged during construction at their expense.

The exact location of all utilities shall be field verified by the Contractor before the installation of any components of the traffic signal system. For locations of utilities the local Counties or Municipalities may need to be contacted, in the City of Chicago contact D.I.G.G.E.R. at (312) 744-7000 and for all other locations contact J.U.L.I.E. at 1-800-892-0123.

ELECTRIC SERVICE INSTALLATION

Revise Section 805 of the Standard Specifications to read:

Description. This work shall consist of all materials and labor required to install, modify, or extend the electric service installation. All installations shall meet the requirements of the details in the “District One Standard Traffic Signal Design Details” and applicable portions of the Specifications.

General. The electric service installation shall be the electric service disconnecting means and it shall be identified as suitable for use as service equipment.

The electric utility contact information is noted on the plans and represents the current information at the time of contract preparation. The Contractor must request in writing for service and/or service modification within 10 days of contract award and must follow-up with the electric utility to assure all necessary documents and payment are received by the utility. The Contractor shall forward copies of all correspondence between the contractor and utility company. The service agreement and sketch shall be submitted for signature to the Traffic Program’s engineer.

Materials

- a. General. The completed control panel shall be constructed in accordance with UL Std. 508A, Industrial Control Panel, and carry the UL label. Wire terminations shall be UL listed.
- b. Enclosures.
 1. Pole Mounted Cabinet. The cabinet shall be UL 50, NEMA Type 4X, unfinished single door design, fabricated from minimum 0.080-inch (2.03 mm) thick Type 5052 H-32 aluminum. Seams shall be continuous welded and ground smooth. Stainless steel screws and clamps shall secure the cover and assure a watertight seal. The cover shall be removable by pulling the continuous stainless steel hinge pin. The cabinet shall have an oil-resistant gasket and a lock kit shall be provided with an internal O-ring in the locking mechanism assuring a watertight and dust-tight seal. The cabinet shall be sized to adequately house all required components with extra space for arrangement and termination of wiring. A minimum size of 14-inches (350 mm) high, 9-inches (225 mm) wide and 8-inches (200 mm) in depth is required. The cabinet shall be channel mounted to a wooden utility pole using assemblies recommended by the manufacturer.

2. Ground Mounted Cabinet. The cabinet shall be UL 50, NEMA Type 3R unfinished single door design with back panel. The cabinet shall be fabricated from Type 5052 H-32 aluminum with the frame and door 0.125-inch (3.175 mm) thick, the top 0.250-inch (6.350 mm) thick and the bottom 0.500-inch (12.70 mm) thick. Seams shall be continuous welded and ground smooth. The door and door opening shall be double flanged. The door shall be approximately 80% of the front surface, with a full length tamperproof stainless steel .075-inch (1.91 mm) thick hinge bolted to the cabinet with stainless steel carriage bolts and nylocks nuts. The locking mechanism shall be slam-latch type with a keyhole cover. The cabinet shall be sized to adequately house all required components with extra space for arrangement and termination of wiring. A minimum size of 40-inches (1000 mm) high, 16-inches (400 mm) wide and 15-inches (375 mm) in depth is required. The cabinet shall be mounted upon a square Type A concrete foundation as indicated on the plans. The foundation is paid for separately.
- c. Surge Protector. Overvoltage protection, with LED indicator, shall be provided for the 120 volt load circuit by the means MOV and thermal fusing technology. The response time shall be <5n seconds and operate within a range of -40C to +85C. The surge protector shall be UL 1449 Listed.
- d. Circuit Breakers. Circuit breakers shall be standard UL listed molded case, thermal-magnetic bolt-on type circuit breakers with trip free indicating handles. 120 volt circuit breakers shall have an interrupting rating of not less than 65,000 rms symmetrical amperes. Unless otherwise indicated, the main disconnect circuit breaker for the traffic signal controller shall be rated 60 amperes, 120 V and the auxiliary circuit breakers shall be rated 10 amperes, 120 V.
- e. Fuses, Fuseholders and Power Indicating Light. Fuses shall be small-dimensional cylindrical fuses of the dual element time-delay type. The fuses shall be rated for 600 V AC and shall have a UL listed interrupting rating of not less than 10,000 rms symmetrical amperes at rated voltage. The power indicating light shall be LED type with a green colored lens and shall be energized when electric utility power is present.
- f. Ground and Neutral Bus Bars. A single copper ground and neutral bus bar, mounted on the equipment panel shall be provided. Ground and neutral conductors shall be separated on the bus bar. Compression lugs, plus 2 spare lugs, shall be sized to accommodate the cables with the heads of the connector screws painted green for ground connections and white for neutral connections.
- g. Utility Services Connection. The Contractor shall notify the Utility Company marketing representative a minimum of 30 working days prior to the anticipated date of hook-up. This 30 day advance notification will begin only after the Utility Company marketing representative has received service charge payments from the Contractor. Prior to contacting the Utility Company marketing representative for service connection, the service installation controller cabinet and cable must be installed for inspection by the Utility Company.
- h. Ground Rod. Ground rods shall be copper-clad steel, a minimum of 10 feet (3.0m) in length, and 3/4 inch (20mm) in diameter. Ground rod resistance measurements to ground shall be 25 ohms or less. If necessary additional rods shall be installed to meet resistance requirements at no additional cost to the contract.

Installation

- a. General. The Contractor shall confirm the orientation of the traffic service installation and its door side with the engineer, prior to installation. All conduit entrances into the service installation shall be sealed with a pliable waterproof material.
- b. Pole Mounted. Brackets designed for pole mounting shall be used. All mounting hardware shall be stainless steel. Mounting height shall be as noted on the plans or as directed by the Engineer.

- c. Ground Mounted. The service installation shall be mounted plumb and level on the foundation and fastened to the anchor bolts with hot-dipped galvanized or stainless steel nuts and washers. The space between the bottom of the enclosure and the top of the foundation shall be caulked at the base with silicone.

Basis of Payment. The service installation shall be paid for at the contract unit price each for SERVICE INSTALLATION of the type specified which shall be payment in full for furnishing and installing the service installation complete. The type A foundation which includes the ground rod shall be paid for separately. SERVICE INSTALLATION, POLE MOUNTED shall include the 3/4 inch (20mm) grounding conduit, ground rod, and pole mount assembly. Any charges by the utility companies shall be approved by the engineer and paid for as an addition to the contract according to Article 109.05 of the Standard Specifications.

GROUNDING OF TRAFFIC SIGNAL SYSTEMS

General. All traffic signal systems, equipment and appurtenances shall be properly grounded in strict conformance with the NEC. See IDOT District One Traffic Signal detail plan sheets for additional information.

The grounding electrode system shall include a ground rod installed with each traffic signal controller concrete foundation and all mast arm and post concrete foundations. An additional ground rod will be required at locations where measured resistance exceeds 25 ohms. Ground rods are included in the applicable foundation pay item and will not be paid for separately.

Testing shall be according to Article 801.13 (a) (4) and (5).

- a) The grounded conductor (neutral conductor) shall be white color coded. This conductor shall be bonded to the equipment grounding conductor only at the Electric Service Installation. All power cables shall include one neutral conductor of the same size.
- b) The equipment grounding conductor shall be green color coded. The following is in addition to Article 801.04 of the Standard Specifications.
 - 1) Equipment grounding conductors shall be bonded to the grounded conductor (neutral conductor) only at the Electric Service Installation. The equipment grounding conductor is paid for separately and shall be continuous. The Earth shall not be used as the equipment grounding conductor.
 - 2) Equipment grounding conductors shall be bonded, using a Listed grounding connector, to all traffic signal mast arm poles, traffic signal posts, pedestrian posts, pull boxes, handhole frames and covers and other metallic enclosures throughout the traffic signal wiring system, except where noted herein. Bonding shall be made with a splice and pigtail connection, using a sized compression type copper sleeve, sealant tape, and heat-shrinkable cap. A Listed electrical joint compound shall be applied to all conductors' terminations, connector threads and contact points.
 - 3) All metallic and non-metallic raceways containing traffic signal circuit runs shall have a continuous equipment grounding conductor, except raceways containing only detector loop lead-in circuits, circuits under 50 volts and/or fiber optic cable will not be required to include an equipment grounding conductor.
 4. Individual conductor splices in handholes shall be soldered and sealed with heat shrink. When necessary to maintain effective equipment grounding, a full cable heat shrink shall be provided over individual conductor heat shrinks.
- c) The grounding electrode conductor shall be similar to the equipment grounding conductor in color coding (green) and size. The grounding electrode conductor is used to connect the ground rod to the equipment grounding conductor and is bonded to ground rods via exothermic welding, listed pressure connectors, listed clamps or other approved listed means.

HANDHOLES

Add the following to Section 814 of the Standard Specifications:

All handholes shall be concrete, poured in place, with inside dimensions of 21-1/2 inches (549mm) minimum. Frames and lid openings shall match this dimension. The cover of the handhole frame shall be labeled "Traffic Signals" with legible raised letters.

For grounding purposes the handhole frame shall have provisions for a 7/16 inch (15.875mm) diameter stainless bolt cast into the frame. The covers shall have a stainless steel threaded stint extended from the eye hook assembly for the purpose of attaching the grounding conductor to the handhole cover.

The minimum wall thickness for heavy duty hand holes shall be 12 inches (300mm).

All conduits shall enter the handhole at a depth of 30 inches (760mm) except for the conduits for detector loops when the handhole is less than 5 feet (1.52 m) from the detector loop. All conduit ends should be sealed with a waterproof sealant to prevent the entrance of contaminants into the handhole.

Steel cable hooks shall be coated with hot-dipped galvanization in accordance with AASHTO Specification M111. Hooks shall be a minimum of 1/2 inch (12.7 mm) diameter with two 90 degree bends and extend into the handhole at least 6 inches (150 mm). Hooks shall be placed a minimum of 12 inches (300 mm) below the lid or lower if additional space is required.

FIBER OPTIC TRACER CABLE

The cable shall meet the requirements of Section 817 of the "Standard Specifications," except for the following:

Add the following to Article 817.03 of the Standard Specifications:

In order to trace the fiber optic cable after installation, the tracer cable shall be installed in the same conduit as the fiber optic cable in locations shown on the plans. The tracer cable shall be continuous, extended into the controller cabinet and terminated on a barrier type terminal strip mounted on the side wall of the controller cabinet. The barrier type terminal strip and tracer cable shall be clearly marked and identified. The tracer cable will be allowed to be spliced at the handholes only. All tracer cable splices shall be kept to a minimum and shall incorporate maximum lengths of cable supplied by the manufacturer. The tracer cable splice shall use a Western Union Splice soldered with resin core flux. All exposed surfaces of the solder shall be smooth. Splices shall be soldered using a soldering iron. Blow torches or other devices which oxidize copper cable shall not be allowed for soldering operations. The splice shall be covered with WCSMW 30/100 heat shrink tube, minimum length 4 inches (100 mm) and with a minimum 1 inch (25 mm) coverage over the XLP insulation, underwater grade.

Add the following to Article 817.05 of the Standard Specifications:

Basis of Payment. The tracer cable shall be paid for separately as ELECTRIC CABLE IN CONDUIT, TRACER, NO. 14 1C per foot (meter), which price shall include all associated labor and material for installation.

GROUNDING CABLE

The cable shall meet the requirements of Section 817 of the "Standard Specifications," except for the following:

Add to Article 817.02 (b) of the Standard Specifications:

Unless otherwise noted on the Plans, traffic signal grounding conductor shall be one conductor, #6 gauge copper, with a green color coded XLP jacket.

The traffic signal grounding conductor shall be bonded, using a Listed grounding connector (Burndy type KC/K2C, as applicable, or approved equal), to all proposed and existing traffic signal mast arm poles and traffic/pedestrian signal posts, including push button posts. The grounding conductor shall be bonded to all proposed and existing pull boxes, handhole frames and covers and other metallic enclosures throughout the traffic signal wiring system and noted herein and detailed on the plans. Bonding to existing handhole frames and covers shall be paid for separately.

Add the following to Article 817.05 of the Standard Specifications:

Basis of Payment. Grounding cable shall be measured in place for payment in foot (meter). Payment shall be at the contract unit price for ELECTRIC CABLE IN CONDUIT, GROUNDING, NO. 6, 1C, which price includes all associated labor and material including grounding clamps, splicing, exothermic welds, grounding connectors, and other hardware.

RAILROAD INTERCONNECT CABLE

The cable shall meet the requirements of Section 817 of the "Standard Specifications," except for the following:

Add to Article 817.02 of the Standard Specifications:

The railroad interconnect cable shall be three conductor stranded #14 copper cable in a clear polyester binder, shielded with #36 AWG tinned copper braid with 85% coverage, and insulated with .016" polyethylene (black, blue, red). The jacket shall be black 0.045 PVC or polyethylene.

Add the following to Article 817.05 of the Standard Specifications:

Basis of Payment. This work shall be paid for at the contract unit price per foot (meter) for ELECTRIC CABLE IN CONDUIT, RAILROAD, NO. 14 3C, which price shall be payment in full for furnishing, installing, and making all electrical connections in the traffic signal controller cabinet. Connections in the railroad controller cabinet shall be performed by railroad personnel.

MAINTENANCE OF EXISTING TRAFFIC SIGNAL INSTALLATION

Revise Section 850 of the Standard Specifications to read:

The energy charges for the operation of the traffic signal installation shall be paid for by others. Full maintenance responsibility shall start as soon as the Contractor begins any physical work on the Contract or any portion thereof.

The Contractor shall have on staff electricians with IMSA Level II certification to provide signal maintenance.

This item shall include maintenance of all traffic signal equipment at the intersection, including emergency vehicle pre-emption equipment, master controllers, uninterruptible power supply (UPS and batteries), telephone service installations, communication cables and conduits to adjacent intersections.

The maintenance shall be according to District One revised Article 801.11 and the following contained herein.

The Contractor shall check all controllers every two (2) weeks, which will include visually inspecting all timing intervals, relays, detectors, and pre-emption equipment to ensure that they are functioning properly. This item includes, as routine maintenance, all portions of emergency vehicle pre-emption equipment. The Contractor shall maintain in stock at all times a sufficient amount of materials and equipment to provide effective temporary and permanent repairs.

The Contractor shall provide immediate corrective action when any part or parts of the system fail to function properly. Two far side heads facing each approach shall be considered the minimum acceptable signal operation pending permanent repairs. When repairs at a signalized intersection require that the controller be disconnected, and

power is available, the Contractor shall place the traffic signal installation on flashing operation. The signals shall flash RED for all directions unless a different indication has been specified by the Engineer. The Contractor shall be required to place stop signs (R1-1-36) at each approach of the intersection as a temporary means of regulating traffic. The Contractor shall furnish and equip all their vehicles assigned to the maintenance of traffic signal installations with a sufficient number of stop signs as specified herein. The Contractor shall maintain a sufficient number of spare stop signs in stock at all times to replace stop signs which may be damaged or stolen.

The Contractor shall provide the Engineer with a 24 hour telephone number for the maintenance of the traffic signal installation and for emergency calls by the Engineer.

Traffic signal equipment which is lost or not returned to the Department for any reason shall be replaced with new equipment meeting the requirements of these Specifications.

The Contractor shall respond to all emergency calls from the Department or others within one hour after notification and provide immediate corrective action. When equipment has been damaged or becomes faulty beyond repair, the Contractor shall replace it with new and identical equipment. The cost of furnishing and installing the replaced equipment shall be borne by the Contractor at no additional charge to the contract. The Contractor may institute action to recover damages from a responsible third party. If at any time the Contractor fails to perform all work as specified herein to keep the traffic signal installation in proper operating condition or if the Engineer cannot contact the Contractor's designated personnel, the Engineer shall have the State's Electrical Maintenance Contractor perform the maintenance work required. The State's Electrical Maintenance Contractor shall bill the Contractor for the total cost of the work. The Contractor shall pay this bill within thirty (30) days of the date of receipt of the invoice or the cost of such work will be deducted from the amount due the Contractor. The Contractor shall allow the Electrical Maintenance Contractor to make reviews of the Existing Traffic Signal Installation that has been transferred to the Contractor for Maintenance.

Basis of Payment. This work shall be paid for at the contract unit price each for MAINTENANCE OF EXISTING TRAFFIC SIGNAL INSTALLATION.

TRAFFIC ACTUATED CONTROLLER

Add the following to Article 857.02 of the Standard Specifications:

Controllers shall be NEMA TS2 Type 1, Econolite ASC/3-1000 or Eagle/Siemens M52 unless specified otherwise on the plans or elsewhere on these specifications. Only controllers supplied by one of the District One approved closed loop equipment manufacturers will be allowed. The controller shall be the most recent model and software version supplied by the manufacturer at the time of the approval. The traffic signal controller shall provide features to inhibit simultaneous display of a circular yellow ball and a yellow arrow display. Individual load switches shall be provided for each vehicle, pedestrian, and right turn over lap phase. The controller shall prevent phases from being skipped during program changes and after all preemption events.

MASTER CONTROLLER

Revise Articles 860.02 - Materials and 860.03 - Installation of the Standard Specifications to read:

Only controllers supplied by one of the District approved closed loop equipment manufacturers will be allowed. Only NEMA TS 2 Type 1 Eagle/Siemens and Econolite closed loop systems shall be supplied. The latest model and software version of master controller shall be supplied.

Functional requirements in addition to those in Section 863 of the Standard Specification include:

The system commands shall consist of, as a minimum, six (6) cycle lengths, five (5) offsets, three (3) splits, and four (4) special functions. The system commands shall also include commands for free or coordinated operation.

Traffic Responsive operation shall consist of the real time acquisition of system detector data, data validation, and the scaling of acquired volumes and occupancies in a deterministic fashion so as to cause the selection and implementation of the most suitable traffic plan.

Upon request by the Engineer, each master shall be delivered with up to three (3) complete sets of the latest edition of registered remote monitoring software with full manufacture's support. Each set shall consist of software on CD, DVD, or other suitable media approved by the Engineer, and a bound set of manuals containing loading and operating instruction. One copy of the software and support data shall be delivered to the Agency in charge of system operation, if other than IDOT. One of these two sets will be provided to the Agency Signal Maintenance Contractor for use in monitoring the system.

The approved manufacturer of equipment shall loan the District one master controller and two intersection controllers of the most recent models and the newest software version to be used for instructional purposes in addition to the equipment to be supplied for the Contract.

The Contractor shall arrange to install a standard voice-grade dial-up telephone line to the master controller. This shall be accomplished through the following process utilizing District One staff. This telephone line may be coupled with a DSL line and a phone filter to isolate the dial-up line. An E911 address is required.

The cabinet shall be provided with an Outdoor Network Interface for termination of the telephone service. It shall be mounted to the inside of the cabinet in a location suitable to provide access for termination of the telephone service at a later date.

Full duplex communication between the master and its local controllers is recommended, but at this time not required. The data rate shall be 1200 baud minimum and shall be capable of speeds to 38,400 or above as technology allows. The controller, when installed in an Ethernet topology, may operate non-serial communications.

The cabinet shall be equipped with a 9600 baud, auto dial/auto answer modem. It shall be a US robotics 56K baud rate or equal.

As soon as practical or within one week after the contract has been awarded, the Contractor shall contact (via phone) the Administrative Support Manager in the District One Business Services Section at (847) 705-4011 to request a phone line installation.

A follow-up fax transmittal to the Administrative Support Manager (847-705-4712) with all required information pertaining to the phone installation is required from the Contractor as soon as possible or within one week after the initial request has been made. A copy of this fax transmittal must also be faxed by the Contractor to the Traffic Signal Systems Engineer at (847) 705-4089. The required information to be supplied on the fax shall include (but not limited to): A street address for the new traffic signal controller (or nearby address); a nearby existing telephone number; what type of telephone service is needed; the name and number of the Contractor's employee for the telephone company to contact regarding site work and questions.

The usual time frame for the activation of the phone line is 4-6 weeks after the Business Services Section has received the Contractor supplied fax. It is, therefore, imperative that the phone line conduit and pull-string be installed by the Contractor in anticipation of this time frame. On jobs which include roadway widening in which the conduit cannot be installed until this widening is completed, the Contractor will be allowed to delay the phone line installation request to the Business Services Section until a point in time that is 4-6 weeks prior to the anticipated completion of the traffic signal work. The contractor shall provide the Administrative Support Manager with an expected installation date considering the 4-6 week processing time.

The telephone line shall be installed and activated one month before the system final inspection.

All costs associated with the telephone line installation and activation (not including the Contract specified conduit installation between the point of telephone service and the traffic signal controller cabinet) shall be paid for by the District One Business Services Section (i.e., this will be an IDOT phone number not a Contractor phone number).

FIBER OPTIC CABLE

Add the following to Articles 871.01, 872.02, 871.04, and 871.05 of the Standard Specifications:

This work shall consist of furnishing and installing Fiber Optical cable in conduit with all accessories and connectors according to Section 871 of the Standard Specifications. The cable shall be of the type, size, and the number of fiber specified.

The control cabinet distribution enclosure shall be CSC FTWO12KST-W/O 12 Port Fiber Wall Enclosure or an approved equivalent. The fiber optic cable shall provide six fibers per tube for the amount of fibers called for in the Fiber Optic Cable pay item in the Contract. A minimum of six multimode fibers from each cable shall be terminated with approved mechanical connectors at the distribution enclosure. Fibers not being used shall be labeled "spare." Fibers not attached to the distribution enclosure shall be capped and sealed. A minimum of 13.0 feet (4m) of extra cable length shall be provided for the controller cabinet. The controller cabinet extra cable length shall be stored as directed by the Engineer.

Fiber Optic cable may be gel filled or have an approved water blocking tape.

Basis of Payment. The work shall be paid for at the contract unit price for FIBER OPTIC CABLE IN CONDUIT, NO. 62.5/125, MM12F SM12F, per foot (meter) for the cable in place, including distribution enclosure and all connectors.

CONCRETE FOUNDATIONS

Add the following to Article 878.03 of the Standard Specifications:

All anchor bolts shall be according to Article 1006.09, except all anchor bolts shall be hot dipped galvanized the full length of the anchor bolt including the hook.

Concrete Foundations, Type "A" for Traffic Signal Posts shall provide anchor bolts with the bolt pattern specified within the "District One Standard Traffic Signal Design Details." All Type "A" foundations shall be a minimum depth of 48 inches (1.22 m).

Concrete Foundations, Type "C" for Traffic Signal Cabinets with Uninterruptible Power Supply (UPS) cabinet installations shall be a minimum of 72 inches long and 31 inches wide. A concrete apron in front of the Type IV or V cabinet and UPS cabinet shall be included in this item. See District 1 Traffic Signal Detail sheet for additional construction requirements. Anchor bolts shall provide bolt spacing as required by the manufacturer.

Concrete Foundations, Type "D" for Traffic Signal Cabinets shall be a minimum of 48 inches (1.22 m) long and 31 inches (790 mm) wide. All Type "D" foundations shall be a minimum depth of 48 inches (1.22 m). The concrete apron shall be 36 in. x 48 in. x 5 in. (910 mm X 1220 mm X 130 mm). Anchor bolts shall provide bolt spacing as required by the manufacturer.

Concrete Foundations, Type "E" for Mast Arm and Combination Mast Arm Poles shall meet the requirements of the current State Standard 878001-06 (as of January 1, 2008).

No foundation is to be poured until the Resident Engineer gives his/her approval as to the depth of the foundation.

DETECTOR LOOP

Revise Section 886 of the Standard Specifications to read:

A minimum of seven (7) working days prior to the Contractor cutting loops, the Contractor shall have the proposed loop locations marked and contact the Area Traffic Signal Maintenance and Operations Engineer (847) 705-4424 to inspect and approve the layout. When preformed detector loops are installed, the Contractor shall have them inspected and approved prior to the pouring of the Portland cement concrete surface, using the same notification process as above.

Loop detectors shall be installed according to the requirements of the “District One Standard Traffic Signal Design Details.” Saw-cuts (homeruns on preformed detector loops) from the loop to the edge of pavement shall be made perpendicular to the edge of pavement when possible in order to minimize the length of the saw-cut (homerun on preformed detector loops) unless directed otherwise by the Engineer or as shown on the plan.

The detector loop cable insulation shall be labeled with the cable specifications.

Each loop detector lead-in wire shall be labeled in the handhole using a Panduit 250W175C water proof tag, or an approved equal, secured to each wire with nylon ties.

Resistance to ground shall be a minimum of 100 mega-ohms under any conditions of weather or moisture. Inductance shall be more than 50 and less than 700 microhenries. Quality readings shall be more than 5.

- (a) Type I. All loops installed in new asphalt pavement shall be installed in the binder course and not in the surface course. The edge of pavement, curb and handhole shall be cut with a 1/4 inch (6.3 mm) deep x 4 inches (100 mm) saw cut to mark location of each loop lead-in.

Loop sealant shall be a two-component thixotropic chemically cured polyurethane either Chemque Q-Seal 295, Percol Elastic Cement A/C Grade or an approved equal. The sealant shall be installed 1/8 inch (3 mm) below the pavement surface, if installed above the surface the overlap shall be removed immediately.

Detector loop measurements shall include the saw cut and the length of the loop lead-in to the edge of pavement. The lead-in wire, including all necessary connections for proper operations, from the edge of pavement to the handhole, shall be included in the price of the detector loop. Unit duct, trench and backfill, and drilling of pavement or handholes shall be included in detector loop quantities.

- (b) Preformed. This work shall consist of furnishing and installing a rubberized heat resistant preformed traffic signal loop in accordance with the Standard Specifications, except for the following:

Preformed detector loops shall be installed in new pavement constructed of Portland cement concrete using mounting chairs or tied to re-bar or the preformed detector loops may be placed in the sub-base. Loop lead-ins shall be extended to a temporary enclosure near the proposed handhole location with ends capped and sealed against moisture and other contaminants.

Handholes shall be placed next to the shoulder or back of curb when preformed detector loops enter the handhole. Non-metallic coilable duct, included in this pay item, shall be used to protect the preformed lead-ins from back of curb to the handhole.

Preformed detector loops shall be factory assembled. Homeruns and interconnects shall be pre-wired and shall be an integral part of the loop assembly. The loop configurations and homerun lengths shall be assembled for the specific application. The loop and homerun shall be constructed using 11/16 inch (17.2 mm) outside diameter (minimum), 3/8 inch (9.5 mm) inside diameter (minimum) Class A oil resistant synthetic cord reinforced hydraulic hose with 250 psi (1,720 kPa) internal pressure rating. Hose for the loop and homerun assembly shall be one continuous piece. No joints or splices shall be allowed in the hose except where necessary to connect homeruns or interconnects to the loops. This will provide maximum wire protection and loop system strength. Hose tee connections shall be heavy duty high temperature synthetic rubber. The tee shall be of proper size to attach directly to the hose, minimizing glue joints. The tee shall have the same flexible properties as the hose to insure that the whole assembly can conform to pavement movement and shifting without cracking or breaking. The

wire used shall be #16 THWN stranded copper. The number of turns in the loop shall be application specific. Homerun wire pairs shall be twisted a minimum of four turns per foot. No wire splices will be allowed in the preformed loop assembly. The loop and homeruns shall be filled and sealed with a flexible sealant to insure complete moisture blockage and further protect the wire. The preformed loops shall be constructed to allow a minimum of 6.5 feet of extra cable in the handhole.

Basis of Payment. This work shall be paid for at the contract unit price per foot (meter) for DETECTOR LOOP, TYPE I or PREFORMED DETECTOR LOOP as specified in the plans, which price shall be payment in full for furnishing and installing the detector loop and all related connections for proper operation.

EMERGENCY VEHICLE PRIORITY SYSTEM

Revise Section 887 of the Standard Specifications to read:

It shall be the Contractor's responsibility to contact the municipality or fire district to verify the brand of emergency vehicle pre-emption equipment to be installed prior to the contract bidding. The equipment must be completely compatible with all components of the equipment currently in use by the Agency.

All new installations shall be equipped with Confirmation Beacons as shown on the "District One Standard Traffic Signal Design Details." The Confirmation Beacon shall consist of a 6 watt Par 38 LED flood lamp with a 30 degree light spread, maximum 6 watt energy consumption at 120V, and a 2,000 hour warranty for each direction of pre-emption. The lamp shall have an adjustable mount with a weatherproof enclosure for cable splicing. All hardware shall be cast aluminum or stainless steel. Holes drilled into signal poles, mast arms, or posts shall require rubber grommets. In order to maintain uniformity between communities, the confirmation beacons shall indicate when the control equipment receives the pre-emption signal. The pre-emption movement shall be signalized by a flashing indication at the rate specified by Section 4D-11 of the "Manual on Uniform Traffic Control Devices." The stopped pre-empted movements shall be signalized by a continuous indication.

All light operated systems shall include security and transit preemption software and operate at a uniform rate of 14.035 Hz \pm 0.002, or as otherwise required by the Engineer, and provide compatible operation with other light systems currently being operated in the District.

Basis of Payment. The work shall be paid for at the contract unit price each for furnishing and installing LIGHT DETECTOR and LIGHT DETECTOR AMPLIFIER. Furnishing and installing the confirmation beacon shall be included in the cost of the Light Detector. The preemption detector amplifier shall be paid for on a basis of (1) one each per intersection controller and shall provide operation for all movements required in the pre-emption phase sequence.

RE-OPTIMIZE TRAFFIC SIGNAL SYSTEM

Description. This work shall consist of re-optimizing a closed loop traffic signal system according to the following Levels of work.

LEVEL I applies when improvements are made to an existing signalized intersection within an existing closed loop traffic signal system. The purpose of this work is to integrate the improvements to the subject intersection into the signal system while minimizing the impacts to the existing system operation. This type of work would be commonly associated with the addition of signal phases, pedestrian phases, or improvements that do not affect the capacity at an intersection.

LEVEL II applies when improvements are made to an existing signalized intersection within an existing closed loop traffic signal system and detailed analysis of the intersection operation is desired by the engineer, or when a new signalized or existing signalized intersection is being added to an existing system, but optimization of the entire system is not required. The purpose of this work is to optimize the subject intersection, while integrating it into the

existing signal system with limited impact to the system operations. This item also includes an evaluation of the overall system operation, including the traffic responsive program.

For the purposes of re-optimization work, an intersection shall include all traffic movements operated by the subject controller and cabinet.

After the signal improvements are completed, the signal shall be re-optimized as specified by an approved Consultant who has previous experience in optimizing Closed Loop Traffic Signal Systems for District One of the Illinois Department of Transportation. The Contractor shall contact the Traffic Signal Engineer at (847) 705-4424 for a listing of approved Consultants. Traffic signal system optimization work, including fine-tuning adjustments of the optimized system, shall follow the requirements stated in the most recent IDOT District 1 SCAT Guidelines, except as note herein.

A listing of existing signal equipment, interconnect information, phasing data, and timing patterns may be obtained from the Department, if available and as appropriate. The existing SCAT Report is available for review at the District One office and if the Consultant provides blank computer disks, copies of computer simulation files for the existing optimized system and a timing database that includes intersection displays will be made for the Consultant. The Consultant shall confer with the Traffic Signal Engineer prior to optimizing the system to determine if any extraordinary conditions exist that would affect traffic flows in the vicinity of the system, in which case, the Consultant may be instructed to wait until the conditions return to normal or to follow specific instructions regarding the optimization.

(a) LEVEL I Re-Optimization

1. The following tasks are associated with LEVEL I Re-Optimization.
 - a. Appropriate signal timings shall be developed for the subject intersection and existing timings shall be utilized for the rest of the intersections in the system.
 - b. Proposed signal timing plan for the new or modified intersection(s) shall be forwarded to IDOT for review prior to implementation.
 - c. Consultant shall conduct on-site implementation of the timings at the turn-on and make fine-tuning adjustments to the timings of the subject intersection in the field to alleviate observed adverse operating conditions and to enhance operations.
2. The following deliverables shall be provided for LEVEL I Re-Optimization.
 - a. Consultant shall furnish to IDOT a cover letter describing the extent of the re-optimization work performed.
 - b. Consultant shall furnish an updated intersection graphic display for the subject intersection to IDOT and to IDOT's Traffic Signal Maintenance Contractor.

(b) LEVEL II Re-Optimization

1. In addition to the requirements described in the LEVEL I Re-Optimization above, the following tasks are associated with LEVEL II Re-Optimization.
 - a. Traffic counts shall be taken at the subject intersection after the traffic signals are approved for operation by the Area Traffic Signal Operations Engineer. Manual turning movement counts shall be conducted from 6:30 a.m. to 9:30 a.m., 11:00 a.m. to 1:00 p.m., and 3:30 p.m. to 6:30 p.m. on a typical weekday from midday Monday to midday Friday. The turning movement counts shall identify cars, and single-unit, multi-unit heavy vehicles, and transit buses.
 - b. As necessary, the intersections shall be re-addressed and all system detectors reassigned in the master controller according to the current standard of District One.
 - c. Traffic responsive program operation shall be evaluated to verify proper pattern selection and lack of oscillation and a report of the operation shall be provided to IDOT.
2. The following deliverables shall be provided for LEVEL II Re-Optimization.
 - a. Consultant shall furnish to IDOT one (1) copy of a technical memorandum for the optimized system. The technical memorandum shall include the following elements:

- (1) Brief description of the project
 - (2) Printed copies of the analysis output from Synchro (or other appropriate, approved optimization software file)
 - (3) Printed copies of the traffic counts conducted at the subject intersection
- b. Consultant shall furnish to IDOT two (2) CDs for the optimized system. The CDs shall include the following elements:
- (1) Electronic copy of the technical memorandum in PDF format
 - (2) Revised Synchro files (or other appropriate, approved optimization software file) including the new signal and the rest of the signals in the closed loop system
 - (3) Traffic counts conducted at the subject intersection
 - (4) New or updated intersection graphic display file for the subject intersection
 - (5) The CD shall be labeled with the IDOT system number and master location, as well as the submittal date and the consultant logo. The CD case shall include a clearly readable label displaying the same information securely affixed to the side and front.

Basis of Payment. This work shall be paid for at the contract unit price each for RE-OPTIMIZE TRAFFIC SIGNAL SYSTEM – LEVEL I or RE-OPTIMIZE TRAFFIC SIGNAL SYSTEM – LEVEL II, which price shall be payment in full for performing all work described herein per intersection. Following completion of the timings and submittal of specified deliverables, 100 percent of the bid price will be paid.

OPTIMIZE TRAFFIC SIGNAL SYSTEM

Description. This work shall consist of optimizing a closed loop traffic signal system.

OPTIMIZE TRAFFIC SIGNAL SYSTEM applies when a new or existing closed loop traffic signal system is to be optimized and a formal Signal Coordination and Timing (SCAT) Report is to be prepared. The purpose of this work is to improve system performance by optimizing traffic signal timings, developing a time of day program and a traffic responsive program.

After the signal improvements are completed, the signal system shall be optimized as specified by an approved Consultant who has previous experience in optimizing Closed Loop Traffic Signal Systems for District One of the Illinois Department of Transportation. The Contractor shall contact the Traffic Signal Engineer at (847) 705-4424 for a listing of approved Consultants. Traffic signal system optimization work, including fine-tuning adjustments of the optimized system, shall follow the requirements stated in the most recent IDOT District 1 SCAT Guidelines, except as note herein.

A listing of existing signal equipment, interconnect information, phasing data, and timing patterns may be obtained from the Department, if available and as appropriate. The existing SCAT Report is available for review at the District One office and if the Consultant provides blank computer disks, copies of computer simulation files for the existing optimized system and a timing database that includes intersection displays will be made for the Consultant. The Consultant shall confer with the Traffic Signal Engineer prior to optimizing the system to determine if any extraordinary conditions exist that would affect traffic flows in the vicinity of the system, in which case, the Consultant may be instructed to wait until the conditions return to normal or to follow specific instructions regarding the optimization.

- (a) The following tasks are associated with OPTIMIZE TRAFFIC SIGNAL SYSTEM.
1. Appropriate signal timings and offsets shall be developed for each intersection and appropriate cycle lengths shall be developed for the closed loop signal system.
 2. Traffic counts shall be taken at all intersections after the permanent traffic signals are approved for operation by the Area Traffic Signal Operations Engineer. Manual turning movement counts shall be conducted from 6:30 a.m. to 9:30 a.m., 11:00 a.m. to 1:00 p.m., and 3:30 p.m. to 6:30 p.m. on a typical weekday from midday Monday to midday Friday. The turning movement counts shall identify cars, and single-unit and multi-unit heavy vehicles.

3. As necessary, the intersections shall be re-addressed and all system detectors reassigned in the master controller according to the current standard of District One.
4. A traffic responsive program shall be developed, which considers both volume and occupancy. A time-of-day program shall be developed for used as a back-up system.
5. Proposed signal timing plan for the new or modified intersection shall be forwarded to IDOT for review prior to implementation.
6. Consultant shall conduct on-site implementation of the timings and make fine-tuning adjustments to the timings in the field to alleviate observed adverse operating conditions and to enhance operations.
7. Speed and delay studies shall be conducted during each of the count periods along the system corridor in the field before and after implementation of the proposed timing plans for comparative evaluations. These studies should utilize specialized electronic timing and measuring devices.

(b) The following deliverables shall be provided for OPTIMIZE TRAFFIC SIGNAL SYSTEM.

1. Consultant shall furnish to IDOT one (1) copy of a SCAT Report for the optimized system. The SCAT Report shall include the following elements:

Cover Page in color showing a System Map
Figures <ol style="list-style-type: none"> 1. System overview map – showing system number, system schematic map with numbered system detectors, oversaturated movements, master location, system phone number, cycle lengths, and date of completion. 2. General location map in color – showing signal system location in the metropolitan area. 3. Detail system location map in color – showing cross street names and local controller addresses. 4. Controller sequence – showing controller phase sequence diagrams.
Table of Contents
Tab 1: Final Report <ol style="list-style-type: none"> 1. Project Overview 2. System and Location Description (Project specific) 3. Methodology 4. Data Collection 5. Data Analysis and Timing Plan Development 6. Implementation <ol style="list-style-type: none"> a. Traffic Responsive Programming (Table of TRP vs. TOD Operation) 7. Evaluation <ol style="list-style-type: none"> a. Speed and Delay runs
Tab 2. Turning Movement Counts <ol style="list-style-type: none"> 1. Turning Movement Counts (Showing turning movement counts in the intersection diagram for each period, including truck percentage)
Tab 3. Synchro Analysis <ol style="list-style-type: none"> 1. AM: Time-Space diagram in color, followed by intersection Synchro report (Timing report) summarizing the implemented timings. 2. Midday: same as AM 3. PM: same as AM
Tab 4: Speed and Delay Studies <ol style="list-style-type: none"> 1. Summary of before and after runs results in two (2) tables showing travel time and delay time. 2. Plot of the before and after runs diagram for each direction and time period.
Tab 5: Electronic Files <ol style="list-style-type: none"> 1. Two (2) CDs for the optimized system. The CDs shall include the following elements: <ol style="list-style-type: none"> a. Electronic copy of the SCAT Report in PDF format b. Copies of the Synchro files for the optimized system c. Traffic counts for the optimized system

- d. New or updated intersection graphic display files for each of the system intersections and the system graphic display file including system detector locations and addresses.

Basis of Payment. The work shall be paid for at the contract unit each for OPTIMIZE TRAFFIC SIGNAL SYSTEM, which price shall be payment in full for performing all work described herein for the entire traffic signal system. Following the completion of traffic counts, 25 percent of the bid price will be paid. Following the completion of the Synchro analysis, 25 percent of the bid price will be paid. Following the setup and fine tuning of the timings, the speed-delay study, and the TRP programming, 25 percent of the bid price will be paid. The remaining 25 percent will be paid when the system is working to the satisfaction of the engineer and the report and CD have been submitted.

TEMPORARY TRAFFIC SIGNAL TIMINGS

Description. This work shall consist of developing and maintaining appropriate traffic signal timings for the specified intersection for the duration of the temporary signalized condition.

All timings and adjustments necessary for this work shall be performed by an approved Consultant who has previous experience in optimizing Closed Loop Traffic signal Systems for District One of the Illinois Department of Transportation. The Contractor shall contact the Traffic Signal Engineer at (847) 705-4424 for a listing of approved Consultants.

The following tasks are associated with TEMPORARY TRAFFIC SIGNAL TIMINGS.

- (a) Consultant shall attend temporary traffic signal inspection (turn-on) and conduct on-site implementation of the traffic signal timings. Make fine-tuning adjustments to the timings in the field to alleviate observed adverse operating conditions and to enhance operations.
- (b) Consultant shall provide monthly observation of traffic signal operations in the field.
- (c) Consultant shall provide on-site consultation and adjust timings as necessary for construction stage changes, temporary traffic signal phase changes, and any other conditions affecting timing and phasing, including lane closures, detours, and other construction activities.
- (d) Consultant shall make timing adjustments and prepare comment responses as directed by the Area Traffic Signal Operations Engineer.

Basis of Payment. The work shall be paid for at the contract unit price each for TEMPORARY TRAFFIC SIGNAL TIMINGS, which price shall be payment in full for performing all work described herein per intersection. When the temporary traffic signal installation is turned on, 50 percent of the bid price will be paid. The remaining 50 percent of the bid price will be paid following the removal of the temporary traffic signal installation.

TEMPORARY TRAFFIC SIGNAL INSTALLATION

Revise Section 890 of the Standard Specifications to read:

General. Only an approved equipment vendor will be allowed to assemble the temporary traffic signal cabinet. Also, an approved equipment vendor shall assemble and test a temporary railroad traffic signal cabinet. (Refer to the "Inspection of Controller and Cabinet" specification). A representative of the approved control equipment vendor shall be present at the temporary traffic signal turn-on inspection.

(a) Controllers.

1. Only controllers supplied by one of the District approved closed loop equipment manufacturers will be approved for use at temporary signal locations. All controllers used for temporary traffic signals shall be fully actuated NEMA microprocessor based with RS232 data entry ports compatible with the latest revision of monitoring software approved by IDOT District 1, installed in NEMA TS1 or TS2 cabinets with 8 phase back panels, capable of supplying 255 seconds of cycle length and individual phase length settings up to 99 seconds. On projects with one lane open and two way traffic flow, such as bridge deck repairs, the temporary signal controller shall be capable of providing an adjustable all red clearance setting of up to 30 seconds in length. All controllers used for temporary traffic signals shall meet or exceed the requirements of Section 857 of the Standard Specifications with regards to internal time base coordination and preemption.
 2. All control equipment for the temporary traffic signal(s) shall be furnished by the Contractor unless otherwise stated in the plans. On projects with multiple temporary traffic signal installations, all controllers shall be the same manufacturer brand and model number with current software installed.
- (b) Cabinets. All temporary traffic signal cabinets shall have a closed bottom made of aluminum alloy. The bottom shall be sealed along the entire perimeter of the cabinet base to ensure a water, dust and insect-proof seal. The bottom shall provide a minimum of two (2) 4 inch (100 mm) diameter holes to run the electric cables through. The 4 inch (100 mm) diameter holes shall have a bushing installed to protect the electric cables and shall be sealed after the electric cables are installed.
- (c) Grounding. Grounding shall be provided for the temporary traffic signal cabinet meeting or exceeding the applicable portions of the National Electrical Code, Section 807 of the Standard Specifications and shall meet the requirements of the District 1 Traffic Signal Specifications for “Grounding of Traffic Signal Systems”.
- (d) Traffic Signal Heads. All traffic signal sections and pedestrian signal sections shall be 12 inches (300 mm). Traffic signal sections shall be LED with expandable view, unless otherwise approved by the Engineer. The temporary traffic signal heads shall be placed as indicated on the temporary traffic signal plan or as directed by the Engineer. The Contractor shall furnish enough extra cable length to relocate heads to any position on the span wire or at locations illustrated on the plans for construction staging. The temporary traffic signal shall remain in operation during all signal head relocations. Each temporary traffic signal head shall have its own cable from the controller cabinet to the signal head. Signal heads shall be mounted no less than 17-ft and no more than 25-ft above the crown of the roadway. Signal heads with backplates shall be measured from the bottom of the backplate for minimum clearance and from the top signal section for maximum clearance.
- (e) Interconnect
1. Temporary traffic signal interconnect shall be provided using fiber optic cable or wireless interconnect technology as specified in the plans. The Contractor may request, in writing, to substitute the fiber optic temporary interconnect indicated in the contract documents with a wireless interconnect. The Contractor must provide assurances that the radio device will operate properly at all times and during all construction staging. If approved for use by the Engineer, the Contractor shall submit marked-up traffic signal plans indicating locations of radios and antennas and installation details. If wireless interconnect is used, and in the opinion of the engineer, it is not viable, or if it fails during testing or operations, the Contractor shall be responsible for installing all necessary poles, fiber optic cable, and other infrastructure for providing temporary fiber optic interconnect at no cost to the contract.
 2. The existing system interconnect and phone lines are to be maintained as part of the Temporary Traffic Signal Installation specified for on the plan. The interconnect shall be

installed into the temporary controller cabinet as per the notes or details on the plans. All labor and equipment required to install and maintain the existing interconnect as part of the Temporary Traffic Signal Installation shall be included in the item Temporary Traffic Signal Installation. When shown in the plans, temporary traffic signal interconnect equipment shall be furnished and installed. The temporary traffic signal interconnect shall maintain interconnect communications throughout the entire signal system for the duration of the project.

3. Temporary wireless interconnect, compete. The radio interconnect system shall be compatible with Eagle or Econolite controller closed loop systems. This item shall include all materials, labor and testing to provide the completely operational closed loop system as shown on the plans. The radio interconnect system shall include the following components:
 - a. Rack or Shelf Mounted RS-232 Frequency Hopping Spread Spectrum (FHSS) Radio
 - b. Software for Radio Configuration (Configure Frequency and Hopping Patterns)
 - c. Antennas (Omni Directional or Yagi Directional)
 - d. Antenna Cables, LMR400, Low Loss. Max. 100-ft from controller cabinet to antenna
 - e. Brackets, Mounting Hardware, and Accessories Required for Installation
 - f. RS232 Data Cable for Connection from the radio to the local or master controller
 - g. All other components required for a fully functional radio interconnect system

All controller cabinet modifications and other modifications to existing equipment that are required for the installation of the radio interconnect system components shall be included in this item.

The radio interconnect system may operate at 900Mhz (902-928) or 2.4 Ghz depending on the results of a site survey. The telemetry shall have an acceptable rate of transmission errors, time outs, etc. comparable to that of a hardwire system.

The proposed master controller and telemetry module shall be configured for use with the radio interconnect at a minimum rate of 9600 baud.

The radio interconnect system shall include all other components required for a complete and fully functional telemetry system and shall be installed in accordance to the manufacturers recommendations.

The following radio equipment is currently approved for use in Region One/District One: Encon Model 5200 and Intuicom Communicator II.

- (f) Emergency Vehicle Pre-Emption. All emergency vehicle preemption equipment (light detectors, light detector amplifiers, confirmation beacons, etc.) as shown on the temporary traffic signal plans shall be provided by the Contractor. It shall be the Contractor's responsibility to contact the municipality or fire district to verify the brand of emergency vehicle preemption equipment to be installed prior to the contract bidding. The equipment must be completely compatible with all components of the equipment currently in use by the Agency. All light operated systems shall operate at a uniform rate of 14.035 hz \pm 0.002, or as otherwise required by the Engineer, and provide compatible operation with other light systems currently being operated in the District. All labor and material required to install and maintain the Emergency Vehicle Preemption installation shall be included in the item Temporary Traffic Signal Installation.
- (g) Vehicle Detection. All temporary traffic signal installations shall have vehicular detection installed as shown on the plans or as directed by the Engineer. Pedestrian push buttons shall be provided for all pedestrian signal heads/phases as shown on the plans or as directed by the Engineer. All approaches shall have vehicular detection provided by Video Vehicle Detection System as shown on the plans or as directed by the Engineer. The microwave vehicle sensor or video vehicle detection system shall be approved by IDOT before furnishing and installing. The Contractor shall install, wire, and adjust the

alignment of the microwave vehicle sensor or video vehicle detection system in accordance to the manufacturer's recommendations and requirements. The Contractor shall be responsible for adjusting the alignment of the microwave vehicle sensor or video vehicle detection system for all construction staging changes and for maintaining proper alignment throughout the project. A representative of the approved control equipment vendor shall be present and assist the contractor in setting up and maintaining the microwave vehicle sensor or video vehicle detection system. An in-cabinet video monitor shall be provided with all video vehicle detection systems and shall be included in the item Temporary Traffic Signal Installation.

- (h) Signs. All existing street name and intersection regulatory signs shall be removed from existing poles and relocated to the temporary signal span wire. If new mast arm assembly and pole(s) and posts are specified for the permanent signals, the signs shall be relocated to the new equipment at no extra cost.
- (i) Energy Charges. The electrical utility energy charges for the operation of the traffic signal installation shall be paid for by others if the installation replaces an existing signal. Otherwise charges shall be paid for under 109.05 of the Standard Specifications.
- (j) Maintenance. Maintenance shall meet the requirements of the Traffic Specifications and District Specifications for "Maintenance of Existing Traffic Signal Installation." Maintenance of temporary signals and of the existing signals shall be included to the cost of this item. When temporary traffic signals are to be installed at locations where existing signals are presently operating, the Contractor shall be fully responsible for the maintenance of the existing signal installation as soon as he begins any physical work on the Contract or any portion thereof. Maintenance responsibility of the existing signals shall be included to the item Temporary Traffic Signal Installation(s). In addition, a minimum of seven (7) days prior to assuming maintenance of the existing traffic signal installation(s) under this Contract, the Contractor shall request that the Resident Engineer contact the Bureau of Traffic (847) 705-4424 for an inspection of the installation(s).
- (k) Temporary Traffic Signals for Bridge Projects. Temporary Traffic Signals for bridge projects shall follow the State Standards, Standard Specifications, District 1 Traffic Signal Specifications and any plans for Bridge Temporary Traffic Signals included in the plans. The installation shall meet the above requirements for "Temporary Traffic Signal Installation". In addition all electric cable shall be aerially suspended, at a minimum height of 18 feet (5.5m), on temporary wood poles (Class 5 or better) of 45 feet (13.7 m), minimum height. The signal heads shall be span wire mounted or bracket mounted to the wood pole or as directed by the Engineer. The Controller cabinet shall be mounted to the wood pole or as directed by the Engineer. Microwave vehicle sensors or video vehicle detection may be used in place of the detector loops as approved by the Engineer.
- (l) Temporary Portable Traffic Signal for Bridge Projects.
 - 1. Unless otherwise directed by the Engineer, temporary portable traffic signals shall be restricted to use on roadways of less than 8000 ADT that have limited access to electric utility service, shall not be installed on projects where the estimated need exceeds ten (10) weeks, and shall not be in operation during the period of November through March. The Contractor shall replace the temporary portable traffic signals with temporary span wire traffic signals noted herein at no cost to the contract if the bridge project or Engineer requires temporary traffic signals to remain in operation into any part of period of November through March. If, in the opinion of the engineer, the reliability and safety of the temporary portable traffic signal is not similar to that of a temporary span wire traffic signal installation, the Contractor shall replace the temporary portable traffic signals with temporary span wire traffic signals noted herein at no cost to the contract.
 - 2. The controller and LED signal displays shall meet the above requirements for "Temporary Traffic Signal Installation".

3. Work shall be according to Article 701.18(b) of the Standard Specifications except as noted herein.
4. General.
 - a. The temporary portable bridge traffic signals shall be trailer-mounted units. The trailer-mounted units shall be set up securely and level. Each unit shall be self-contained and consist of two signal heads. The left signal head shall be mounted on a mast arm capable of extending over the travel lane. Each unit shall contain a solar cell system to facilitate battery charging. There shall be a minimum of 12 days backup reserve battery supply and the units shall be capable of operating with a 120 V power supply from a generator or electrical service.
 - b. All signal heads located over the travel lane shall be mounted at a minimum height of 17 feet (5m) from the bottom of the signal back plate to the top of the road surface. All far right signal heads located outside the travel lane shall be mounted at a minimum height of 8 feet (2.5m) from the bottom of the signal back plate to the top of the adjacent travel lane surface.
 - c. The long all red intervals for the traffic signal controller shall be adjustable up to 250 seconds in one-second increments.
 - d. As an alternative to detector loops, temporary portable bridge traffic signals may be equipped with microwave sensors or other approved methods of vehicle detection and traffic actuation.
 - e. All portable traffic signal units shall be interconnected using hardwire communication cable. Radio communication equipment may be used only with the approval of the Engineer. If radio communication is used, a site analysis shall be completed to ensure that there is no interference present that would affect the traffic signal operation. The radio equipment shall meet all applicable FCC requirements.
 - f. The temporary portable bridge traffic signal system shall meet the physical display and operational requirements of conventional traffic signals as specified in Part IV of the Manual on Uniform Traffic Control Devices (MUTCD). The signal system shall be designed to continuously operate over an ambient temperature range between -30 °F (-34 °C) and 120 °F (48 °C). When not being utilized to inform and direct traffic, portable signals shall be treated as nonoperating equipment according to Article 701.11.
 - g. Basis of Payment. This work will be paid for according to Article 701.20(c).

Basis of Payment. This work shall be paid for at the contract unit price each for TEMPORARY TRAFFIC SIGNAL INSTALLATION, TEMPORARY BRIDGE TRAFFIC SIGNAL INSTALLATION, or TEMPORARY PORTABLE BRIDGE TRAFFIC SIGNAL INSTALLATION. The price of which shall include all costs for the modifications required for traffic staging, changes in signal phasing as required in the Contract plans, microwave vehicle sensors, video vehicle detection system, any maintenance or adjustment to the microwave vehicle sensors/video vehicle detection system, all material required, the installation and complete removal of the temporary traffic signal.

REMOVE EXISTING TRAFFIC SIGNAL EQUIPMENT

Add the following to Article 895.05 of the Standard Specifications:

The traffic signal equipment which is to be removed and is to become the property of the Contractor shall be disposed of outside the right-of-way at the Contractor's expense.

All equipment to be returned to the State shall be delivered by the Contractor to the State's Traffic Signal Maintenance Contractor's main facility. The Contractor shall contact the State's Electrical Maintenance Contractor to schedule an appointment to deliver the equipment. No equipment will be accepted without a prior appointment. All equipment shall be delivered within 30 days of removing it from the traffic signal installation. The Contractor shall provide 5 copies of a list of equipment that is to remain the property of the State, including model and serial numbers, where applicable. He shall also provide a copy of the Contract plan or special provision showing the quantities and type of equipment. Controllers and peripheral equipment from the same location shall be boxed together (equipment from different locations may not be mixed) and all boxes and controller cabinets shall be clearly marked or labeled with the location from which they were removed. If equipment is not returned with these requirements, it will be rejected by the State's Electrical Maintenance Contractor. The Contractor shall be responsible for the condition of the traffic signal equipment from the time he takes maintenance of the signal installation until the acceptance of a receipt drawn by the State's Electrical Maintenance Contractor indicating the items have been returned in good condition.

The Contractor shall safely store and arrange for pick up of all equipment to be returned to agencies other than the State. The Contractor shall package the equipment and provide all necessary documentation as stated above.

Traffic signal equipment which is lost or not returned to the Department for any reason shall be replaced with new equipment meeting the requirements of these Specifications.

TRAFFIC SIGNAL PAINTING

Description. This work shall include surface preparation, powder type painted finish application and packaging of new galvanized steel traffic signal mast arm poles and posts assemblies. All work associated with applying the painted finish shall be performed at the manufacturing facility for the pole assembly or post or at a painting facility approved by the Engineer. Traffic signal mast arm shrouds and post bases shall also be painted the same color as the pole assemblies and posts.

Surface Preparation

All weld flux and other contaminates shall be mechanically removed. The traffic mast arms and post assemblies shall be degreased, cleaned, and air dried to assure all moisture is removed.

Painted Finish

All galvanized exterior surfaces shall be coated with a urethane or triglycidyl isocyanurate (TGIC) polyester powder to a dry film thickness of 2.0 mils. Prior to application, the surface shall be mechanically etched by brush blasting (Ref. SSPC-SP7) and the zinc coated substrate preheated to 450 degrees F for a minimum one (1) hour. The coating shall be electrostatically applied and cured by elevating the zinc-coated substrate temperature to a minimum of 400 degrees F. The finish paint color shall be one of the manufacturer's standard colors and shall be as selected by the local agency responsible for paint costs. The Contractor shall confirm, in writing, the color selection with the local responsible agency and provide a copy of the approval to the Engineer and a copy of the approval shall be included in the material catalog submittal.

Traffic signal heads, pedestrian signal heads and controller cabinets are not included in this pay item.

Any damage to the finish after leaving the manufacturer's facility shall be repaired to the satisfaction of the Engineer using a method approvable by the Engineer and manufacturer. If while at the manufacturer's facility the finish is damaged, the finish shall be re-applied.

Warranty

The Contractor shall furnish in writing to the Engineer, the paint manufacturer's standard warranty and certification that the paint system has been properly applied.

Packaging

Prior to shipping, the poles and posts shall be wrapped in ultraviolet-inhibiting plastic foam or rubberized foam.

Basis of Payment. This work shall be paid for at the contract unit price each for PAINT NEW MAST ARM POLE, UNDER 40 FEET (12.19 METER); PAINT NEW MAST ARM POLE, 40 FEET (12.19 METER) AND OVER; PAINT NEW COMBINATION MAST ARM POLE, UNDER 40 FEET (12.19 METER); PAINT NEW COMBINATION MAST ARM POLE, 40 FEET (12.19 METER) AND OVER; or TRAFFIC SIGNAL POST of any height, which shall be payment in full for painting and packaging the traffic signal mast arm poles and posts described above including all shrouds, bases and appurtenances.

Division 1000 Materials

Pedestrian Push-Button

Revise Article 1074.02 of the Standard Specifications to read:

- (a) General. Push-button assemblies shall be ADA compliant, highly vandal resistant, be pressure activated with minimal movement and cannot be stuck in a closed or constant call position. A red LED and audible tone shall be provided for confirmation of an actuation call.
- (b) Housing. The push-button housing shall be solid 6061 aluminum and powder coated yellow, unless otherwise noted on the plans.
- (c) Actuator. The actuator shall be stainless steel with a solid state electronic Piezo switch rated for a minimum of 20 million cycles with no moving plunger or moving electrical contacts. The operating voltage shall be 12-24 V AC/DC.
- (d) Pedestrian Station. Stations shall be designed to be mounted directly to a post, mast arm pole or wood pole. The station shall be aluminum and accept a 3-inch round push button assembly and 5 X 7 ¾ - inch R10-3b or R10-3d sign. A larger station will be necessary to accommodate the sign, R10-3e, for a count-down pedestrian signal.

Controller Cabinet And Peripheral Equipment

Add the following to Article 1074.03 of the Standard Specifications:

- (a) Cabinets shall be designed for NEMA TS2 Type 1 operation. All cabinets shall be pre-wired for a minimum of eight (8) phases of vehicular, four (4) phases of pedestrian and four (4) phases of overlap operation.
- (b)(5) Cabinets – Provide 1/8" (3.2 mm) thick unpainted aluminum alloy 5052-H32. The surface shall be smooth, free of marks and scratches. All external hardware shall be stainless steel.
- (b) (6) Controller Harness – Provide a TS2 Type 2 "A" wired harness in addition to the TS2 Type 1 harness.
- (b) (7) Surge Protection – EDCO Model 1210 IRS with failure indicator.
- (b) (8) BIU – Containment screw required.
- (b) (9) Transfer Relays – Solid state or mechanical flash relays are acceptable.
- (b) (10) Switch Guards – All switches shall be guarded.
- (b) (11) Heating – Two (2) porcelain light receptacles with cage protection controlled by both a wall switch and a thermostat or a thermostatically controlled 150 watt strip heater.
- (b) (12) Plan & Wiring Diagrams – 12" x 16" (3.05mm x 4.06mm) or 22" x 34" (560 mm x 860 mm) moisture sealed container attached to door.
- (b) (13) Detector Racks – Fully wired and labeled for four (4) channels of emergency vehicle pre-emption and sixteen channels (16) of vehicular operation.

- (b) (14) Field Wiring Labels – All field wiring shall be labeled.
- (b) (15) Field Wiring Termination – Approved channel lugs required.
- (b) (16) Power Panel – Provide a nonconductive shield.
- (b) (17) Circuit Breaker – The circuit breaker shall be sized for the proposed load but shall not be rated less than 30 amps.
- (b) (18) Police Door – Provide wiring and termination for plug in manual phase advance switch.
- (b) (19) Railroad Pre-Emption Test Switch – Eaton 8830K13 SHA 1250 or equivalent.

Railroad, Full-Actuated Controller And Cabinet

Add the following to Article 857.02 of the Standard Specifications:

Controller shall comply with Article 1073.01 as amended in these Traffic Signal Special Provisions.

Controller Cabinet and Peripheral Equipment shall comply with Article 1074.03 as amended in these Traffic Signal Special Provisions.

Add the following to Articles 1073.01 (c) (2) and 1074.03 (a) (5) (e) of the Standard Specifications:

Controllers and cabinets shall be new and NEMA TS2 Type 1 design.

A method of monitoring and/or providing redundancy to the railroad preemptor input to the controller shall be included as a component of the Railroad, Full Actuated Controller and Cabinet installation and be verified by the traffic signal equipment supplier prior to installation.

Railroad interconnected controllers and cabinets shall be assembled only by an approved traffic signal equipment supplier. The equipment shall be tested and approved in the equipment supplier's District One facility prior to field installation.

Electric Cable

Delete "or stranded, and No. 12 or" from the last sentence of Article 1076.04 (a) of the Standard Specifications.

Mast Arm Assembly And Pole

Add the following to Article 1077.03 (a) of the Standard Specifications:

Traffic signal mast arms shall be one piece construction, unless otherwise approved by the Engineer. All poles shall be galvanized. If the Department approves painting, powder coating by the manufacturer will be required over the galvanization.

This work shall consist of furnishing and installing a galvanized steel or extruded aluminum shroud for protection of the mast arm pole base plate similar to the dimensions detailed in the "District One Standard Traffic Signal Design Details." The shroud shall be of sufficient strength to deter pedestrian and vehicular damage. The shroud shall allow air to circulate throughout the mast arm but not allow infestation of insects or other animals. The shroud shall be constructed, installed and designed not to be hazardous to probing fingers and feet. All mounting hardware shall be stainless steel. The shroud shall not be paid for separately but shall be included in the cost of the mast arm assembly and pole.

Traffic Signal Post

Add the following to Article 1077.01 (b) of the Standard Specifications:

All posts and bases shall be steel and hot dipped galvanized. If the Department approves painting, powder coating by the manufacturer will be required over the galvanization.

Signal Heads

Add the following to Section 1078 of the Standard Specifications to read:

All signal and pedestrian heads shall provide 12” (300 mm) displays with glossy yellow or black polycarbonate housings. All head housings shall be the same color (yellow or black) at the intersection. For new signalized intersections and existing signalized intersections where all signal and/or pedestrian heads are being replaced, the proposed head housings shall be black. Where only selected heads are being replaced, the proposed head housing color (yellow or black) shall match existing head housings. Connecting hardware and mounting brackets shall be polycarbonate (black). A corrosion resistant anti-seize lubricant shall be applied to all metallic mounting bracket joints, and shall be visible to the inspector at the signal turn-on. Post top mounting collars are required on all posts, and shall be constructed of the same material as the brackets.

Pedestrian signal heads shall be furnished with the international symbolic "Walking Person" and "Upraised Palm" lenses. Egg crate sun shields are not permitted.

Signal heads shall be positioned according to the “District One Standard Traffic Signal Design Details.”

Signal Head, Backplate

Delete 1st sentence of Article 1078.03 of the Standard Specifications and add “All backplates shall be aluminum and louvered”.

Inductive Loop Detector

Add the following to Article 1079.01 of the Standard Specifications:

Contracts requiring new cabinets shall provide for card mounted detector amplifiers. Loop amplifiers shall provide LCD displays with loop frequency, inductance, and change of inductance readings.

Illuminated Sign, Light Emitting Diode

Revise Sections 891 of the Standard Specifications to read:

Description. This work shall consist of furnishing and installing an illuminated sign with light emitting diodes.

General. The light emitting diode (LED) blank out signs shall be manufactured by National Sign & Signal Company, or an approved equal and consist of a weatherproof housing and door, LEDs and transformers.

(a) Display.

1. The LED blank out sign shall provide the correct symbol and color for “NO LEFT TURN” OR “NO RIGHT TURN” indicated in accordance with the requirements of the "Manual on Uniform Traffic Control Devices". The message shall be formed by rows of LEDs.

2. The message shall be clearly legible. The message shall be highly visible, anywhere and under any lighting conditions, within a 15 degree cone centered about the optic axis.

The sign face shall be 24 inches (600 mm) by 24 inches (600 mm). The sign face shall be completely illegible when not illuminated. No symbol shall be seen under any ambient light condition when not illuminated.

3. All LEDs shall be T-1 3/4 (5mm) and have an expected lamplife of 100,000 hours. Operating wavelengths will be Red-626nm, Amber-590nm, and Bluish/Green-505nm. Transformers shall be rated for the line voltage with Class A insulation and weatherproofing. The sign shall be designed for operation over a range of temperatures from -35F to +165 F (-37C to +75C).
4. The LED module shall include the message plate, high intensity LEDs and LED drive electronics. Door panels shall be flat black and electrical connections shall be made via barrier-type terminal strip. All fasteners and hardware shall be corrosion resistant stainless steel.

(b) Housing.

1. The housing shall be constructed of extruded aluminum. All corners and seams shall be heli-arc welded to provide a weatherproof seal around the entire case. Hinges shall be continuous full-length stainless steel. Signs shall have stainless steel hardware and provide tool free access to the interior of the sign. Doors shall be 0.125-inch thick extruded aluminum with a 3/16-inch x 1-inch neoprene gasket and sun hood. The sign face shall have a polycarbonate, matte clear, lexan face plate. Drainage shall be provided by four drain holes at the corners of the housing. The finish on the sign housing shall include two coats of exterior enamel applied after the surface is acid-etched and primed with zinc-chromate primer.
2. Mounting hardware shall be black polycarbonate or galvanized steel and similar to mounting Signal Head hardware and brackets specified herein.

Basis of Payment. This work shall be paid for at the unit price each for ILLUMINATED SIGN, L.E.D.

Grounding Existing Handhole Frame And Cover

Description. This work shall consist of all materials and labor required to bond the equipment grounding conductor to the existing handhole frame and handhole cover. All installations shall meet the requirements of the details in the “District One Standard Traffic Signal Design Details” and applicable portions of the Specifications.

The equipment grounding conductor shall be bonded to the handhole frame and to the handhole cover. Two (2) 1/2-inch diameter x 1 1/4-inch long hex-head stainless steel bolts, spaced 1.75-inches apart center-to-center shall be fully welded to the frame and to the cover to accommodate a heavy duty Listed grounding compression terminal (Burndy type YGHA or approved equal). The grounding compression terminal shall be secured to the bolts with stainless steel split-lock washers and nylon-insert locknuts.

Welding preparation for the stainless steel bolt hex-head to the frame and to the cover shall include thoroughly cleaning the contact and weldment area of all rust, dirt and contaminates. The Contractor shall assure a solid strong weld. The welds shall be smooth and thoroughly cleaned of flux and spatter. The grounding installation shall not affect the proper seating of the cover when closed.

The grounding cable shall be paid for separately.

Method of Measurement. Units measured for payment will be counted on a per handhole basis, regardless of the type of handhole and its location.

Basis of Payment. This work shall be paid for at the contract unit price each for GROUNDING EXISTING HANDHOLE FRAME AND COVER which shall be payment in full for grounding the handhole complete.

Unit Duct

All installations of Unit Duct shall be included in the contract and not paid for separately. Polyethylene unit duct shall be used for detector loop raceways to the handholes. On temporary traffic signal installations with detector loops, polyethylene unit duct shall be used for detector loop raceways from the saw-cut to 10 feet (3m) up the wood pole, unless otherwise shown on the plans. Unit duct shall meet the requirements of NEC Article 343.

Uninterruptible Power Supply (UPS)

Description. This work shall consist of furnishing and installing an Uninterruptible Power Supply (UPS).

The UPS shall have the power capacity to provide normal operation of a signalized intersection that utilizes all LED type signal head optics, for a minimum of six hours.

The UPS shall include, but not be limited to the following: inverter/charger, power transfer relay, batteries, battery cabinet, a separate manually operated non-electronic bypass switch, and all necessary hardware and interconnect wiring according to the plans. The UPS shall provide reliable emergency power to the traffic signals in the event of a power failure or interruption. The transfer from utility power to battery power and visa versa shall not interfere with the normal operation of traffic controller, conflict monitor/malfunction management unit, or any other peripheral devices within the traffic controller assembly.

The UPS shall be designed for outdoor applications, and shall meet the environmental requirements of, “NEMA Standards Publication No. TS 2 – Traffic Controller Assemblies”, except as modified herein.

Materials. The UPS shall be line interactive and provide voltage regulation and power conditioning when utilizing utility power. The UPS shall be sized appropriately for the intersection’s normal traffic signal operating connected load, plus 20 percent (20%). The total connected traffic signal load shall not exceed the published ratings for the UPS. The UPS shall provide a minimum of six (6) hours of normal operation run-time for signalized intersections with LED type signal head optics at 77 °F (25 °C) (minimum 700 W/VA active output capacity, with 90 percent minimum inverter efficiency).

The maximum transfer time from loss of utility power to switchover to battery backed inverter power shall be 65 milliseconds.

The UPS shall have a minimum of three (3) sets of normally open (NO) and normally closed (NC) single-pole double-throw (SPDT) relay contact closures, available on a panel mounted terminal block or locking circular connectors, rated at a minimum 120 V/1 A, and labeled so as to identify each contact according to the plans. Contact closures shall be energized whenever the unit:

- Switches to battery power. Contact shall be labeled or marked “On Batt”.
- Has been connected to battery power for two (2) hours. Contact shall be labeled or marked “Timer”.
- Has an inverter/charger failure. Contact shall be labeled or marked “UPS Fail”.

Operating temperature for the inverter/charger, power transfer relay, and manual bypass switch shall be -35 to 165 °F (-37 to +74 °C).

Both the power transfer relay and manual bypass switch shall be rated at 240 VAC/30 amps, minimum.

The UPS shall use a temperature-compensated battery charging system. The charging system shall compensate over a range of 1.4 – 2.2 mV/°F (2.5 - 4.0 mV/°C) per cell. The temperature sensor shall be external to the inverter/charger unit. The temperature sensor shall come with 6.5 ft (2 m) of wire.

Batteries shall not be recharged when battery temperature exceeds $122\text{ }^{\circ}\text{F} \pm 5\text{ }^{\circ}\text{F}$ ($50\text{ }^{\circ}\text{C} \pm 3\text{ }^{\circ}\text{C}$).

The UPS shall bypass the utility line power whenever the utility line voltage is outside of the following voltage range: 85 VAC to 135 VAC ($\pm 2\text{ VAC}$).

When utilizing battery power, the UPS output voltage shall be between 110 and 125 VAC, pure sine wave output, ≤ 3 percent THD, $60\text{ Hz} \pm 3\text{ Hz}$.

The UPS shall be compatible with the District's approved traffic controller assemblies utilizing NEMA TS 1 or NEMA TS 2 controllers and cabinet components for full time operation.

When the utility line power has been restored at above $90\text{ VAC} \pm 2\text{ VAC}$ for more than 30 seconds, the UPS shall dropout of battery backup mode and return to utility line mode.

When the utility line power has been restored at below $130\text{ VAC} \pm 2\text{ VAC}$ for more than 30 seconds, the UPS shall dropout of battery backup mode and return to utility line mode.

The UPS shall be equipped to prevent a malfunction feedback to the cabinet or from feeding back to the utility service.

In the event of inverter/charger failure, the power transfer relay shall revert to the NC state, where utility line power is reconnected to the cabinet. In the event of an UPS fault condition, the UPS shall always revert back to utility line power.

Recharge time for the battery, from "protective low-cutoff" to 80 percent or more of full battery charge capacity, shall not exceed twenty hours.

The manual bypass switch shall be wired to provide power to the UPS when the switch is set to manual bypass.

When the intersection is in battery backup mode, the UPS shall bypass all internal cabinet lights, ventilation fans, service receptacles, any lighted street name signs, any automated enforcement equipment and any other devices directed by the Engineer.

As the battery reserve capacity reaches 50 percent, the intersection shall automatically be placed in all-red flash. The UPS shall allow the controller to automatically resume normal operation after the power has been restored. The UPS shall log an alarm in the controller for each time it is activated.

A blue LED indicator light shall be mounted on the front of the traffic signal cabinet or on the side of the UPS cabinet facing traffic and shall turn on to indicate when the cabinet power has been disrupted and the UPS is in operation. The light shall be a minimum 1 in. (25 mm) diameter, be viewable from the driving lanes, and able to be seen from 200 ft (60 m) away.

All 24 volt and 48 volt systems shall include an external or internal component that monitors battery charging to ensure that every battery in the string is fully charged. The device shall compensate for the effects of adding a new battery to an existing battery system by ensuring that the charge voltage is spread equally across all batteries.

Mounting/Configuration

The inverter/charger unit shall be rack or shelf-mounted.

All interconnect wiring provided between the power transfer relay, manual bypass switch, and cabinet terminal service block shall be at least 6.5 ft (2 m) of #10 AWG wire.

Relay contact wiring provided for each set of NO/NC relay contact closure terminals shall be 6.5 ft (2 m) of #18 AWG wire.

Battery Cabinet

Batteries, inverter/charger and power transfer relay shall be housed in a separate NEMA Type 3R cabinet. The cabinet shall be Aluminum alloy, 5052-H32, 0.125-inch thick and have a natural mill finish.

The door shall open to the entire cabinet, have a neoprene gasket, an Aluminum continuous piano hinge with stainless steel pin, and a three point locking system. The cabinet shall be provided with a main door lock which shall operate with a traffic industry conventional No. 2 key. Provisions for padlocking the door shall be provided.

The manually bypass switch shall be installed inside the traffic signal cabinet.

No more than three batteries shall be mounted on individual shelves for a cabinet housing six batteries and no more than four batteries per shelf for a cabinet housing eight batteries.

A minimum of three shelves shall be provided. Each shelf shall support a load of 132 lb (60 kg) minimum.

The battery cabinet housing shall have the following nominal outside dimensions: a width of 25 in. (785 mm), a depth of 16 in. (440 mm), and a height of 41 to 48 in. (1.1 to 1.3 m). Clearance between shelves shall be a minimum of 10 in. (250 mm).

The battery cabinet shall be ventilated through the use of louvered vents, filters, and one thermostatically controlled fan. The cabinet fan shall not be energized when the traffic signals are on UPS power.

The battery cabinet shall have provisions for an external generator connection.

The UPS with battery cabinet shall come with all bolts, conduits and bushings, gaskets, shelves, and hardware needed for mounting. A warning sticker shall be placed on the outside of the cabinet indicating that there is an uninterruptible power supply inside the cabinet.

Maintenance, Displays, Controls, and Diagnostics

The UPS shall include a display and/or meter to indicate current battery charge status and conditions.

The UPS shall have lightning surge protection compliant with IEEE/ANSI C.62.41.

The UPS shall be equipped with an integral system to prevent battery from destructive discharge and overcharge.

The UPS hardware and batteries shall be easily replaced without requiring any special tools or devices.

The UPS shall include a resettable front-panel event counter display to indicate the number of times the UPS was activated. The total number of hours the unit has operated on battery power shall be available from the controller unit or UPS unit.

The UPS shall be equipped with an RS-232 port.

The UPS shall include tip or kill switch installed in the battery cabinet, which shall completely disconnect power from the UPS when the switch is manually activated.

The UPS shall incorporate a flanged electric generator inlet for charging the batteries and operating the UPS. The generator connector shall be male type, twist-lock, rated as 15A, 125VAC with a NEMA L5-15P configuration and weatherproof lift cover plate (Hubbell model HBL4716C or approved equal). Access to the generator inlet shall be from a secured weatherproof lift cover plate or behind a locked battery cabinet police panel.

The manufacturer shall include two sets of equipment lists, operation and maintenance manuals, board-level schematic and wiring diagrams of the UPS, and battery data sheets. The manufacturer shall include any software needed to monitor, diagnose, and operate the UPS. The manufacturer shall include any required cables to connect the UPS to a laptop computer.

Battery System

Individual batteries shall be 12 V type, 65 amp-hour minimum capacity at 20 hours, and shall be easily replaced and commercially available off the shelf.

The UPS shall consist of an even number of batteries that are capable of maintaining normal operation of the signalized intersection for a minimum of six hours. Calculations shall be provided showing the number of batteries of the type supplied that are needed to satisfy this requirement. A minimum of four batteries shall be provided.

All batteries supplied in the UPS shall be either gel cell or AGM type, deep cycle, completely sealed, prismatic lead calcium based, silver alloy, valve regulated lead acid (VRLA) requiring no maintenance. All batteries in a UPS installation shall be the same type; mixing of gel cell and AGM types within a UPS installation is not permitted.

Batteries shall be certified by the manufacturer to operate over a temperature range of -13 to 160 °F (-25 to + 71 °C) for gel cell batteries and -40 to 140 °F (-40 to + 60 °C) for AGM type batteries.

The batteries shall be provided with appropriate interconnect wiring and corrosion resistant mounting trays and/or brackets appropriate for the cabinet into which they will be installed.

Batteries shall indicate maximum recharge data and recharging cycles.

Battery interconnect wiring shall be via a modular harness. Batteries shall be shipped with positive and negative terminals pre-wired with red and black cabling that terminates into a typical power-pole style connector. The harness shall be equipped with mating power-pole style connectors for the batteries and a single, insulated plug-in style connection to the inverter/charger unit. The harness shall allow batteries to be quickly and easily connected in any order and shall be keyed and wired to ensure proper polarity and circuit configuration.

Battery terminals shall be covered and insulated so as to prevent accidental shorting.

Warranty

The warranty for an uninterruptible power supply (UPS) shall cover a minimum of two years from date the equipment is placed in operation; however, the batteries of the UPS shall be warranted for full replacement for a minimum of five years from the date the traffic signal and UPS are placed into service.

Installation

When a UPS is installed at an existing traffic signal cabinet, the UPS cabinet shall partially rest on the lip of the existing controller cabinet foundation and be secured to the existing controller cabinet by means of at least four (4) stainless steel bolts. The UPS cabinet shall be completely enclosed with the bottom and back constructed of the same material as the cabinet.

When a UPS is installed at a new signal cabinet and foundation, it shall be mounted as shown on the plans.

Basis of Payment. This work will be paid for at the contract unit price per each for Uninterruptible Power Supply.

Signal Head, Light Emitting Diode

Description. This work shall consist of furnishing and installing a traffic signal head or pedestrian signal head with light emitting diodes (LED) of the type specified in the plan or retrofitting an existing traffic signal head with a traffic signal module or pedestrian signal module with LEDs as specified in the plans.

General. LED signal heads (All Face and Section Quantities), (All Mounting Types) shall conform fully to the requirements of Sections 880 and 881 and Articles 1078.01 and 1078.02 of the “Standard Specifications for Road and Bridge Construction,” adopted January 1, 2007, and amended herein:

1. The LED signal modules shall be replaced or repaired if an LED signal module fails to function as intended due to workmanship or material defects within the first 60 months from the date of delivery. LED signal modules which exhibit luminous intensities less than the minimum values specified in Table 1 of the ITE Vehicle Traffic Control Signal Heads: Light Emitting Diode (LED) Circular Signal Supplement (June 27, 2005) [VTSCH] or show signs of entrance of moisture or contaminants within the first 60 months of the date of delivery shall be replaced or repaired. The manufacturer's written warranty for the LED signal modules shall be dated, signed by an Officer of the company and included in the product submittal to the State.
2. Each module shall consist of an assembly that utilizes LEDs as the light source in lieu of an incandescent lamp for use in traffic signal sections.

(a) Physical and Mechanical Requirements

1. Modules can be manufactured under this specification for the following faces:
 - a. 12 inch (300 mm) circular, multi-section
 - b. 12 inch (300 mm) arrow, multi-section
 - c. 12 inch (300 mm) pedestrian, 2 sections
2. The maximum weight of a module shall be 4 lbs. (1.8 kg).
3. Each module shall be a sealed unit to include all parts necessary for operation (a printed circuit board, power supply, a lens and gasket, etc.), and shall be weather proof after installation and connection.
4. Material used for the lens and signal module construction shall conform to ASTM specifications for the materials.
5. The lens of the module shall be tinted with a wavelength-matched color to reduce sun phantom effect and enhance on/off contrast. The tinting shall be uniform across the lens face. Polymeric lens shall provide a surface coating or chemical surface treatment applied to provide abrasion resistance. The lens of the module shall be integral to the unit, convex with a smooth outer surface and made of plastic. The lens shall have a textured surface to reduce glare.
6. The use of tinting or other materials to enhance ON/OFF contrasts shall not affect chromaticity and shall be uniform across the face of the lens.
7. Each module shall have a symbol of the type of module (i.e. circle, arrow, etc.) in the color of the module. The symbol shall be 1 inch (25.4 mm) in diameter. Additionally, the color shall be written out in 1/2 inch (12.7mm) letters next to the symbol.

(b) Photometric Requirements

1. The minimum initial luminous intensity values for the modules shall conform to the values in Table 1 of the VTC SH (2005) for circular signal indications, and as stated in Table 3 of these specifications for arrow and pedestrian indications at 25°C.
2. The modules shall meet or exceed the illumination values stated in Article 1078.01(3)c of the "Standard Specifications for Road and Bridge Construction," Adopted January 1, 2007 for circular signal indications, and Table 3 of these specifications for arrow and pedestrian indications, throughout the useful life based on normal use in a traffic signal operation over the operating temperature range.
3. The measured chromaticity coordinates of the modules shall conform to the chromaticity requirements of Section 4.2 of the VTC SH (2005).

4. The LEDs utilized in the modules shall be AlInGaP technology for red, yellow, Portland orange (pedestrian) and white (pedestrian) indications, and GaN for green indications, and shall be the ultra bright type rated for 100,000 hours of continuous operation from -40°C to +74°C.

(c) Electrical

1. Maximum power consumption for LED modules is per Table 2.
2. LED modules will have EPA Energy Star compliance ratings, if applicable to that shape, size and color.
3. Operating voltage of the modules shall be 120 VAC. All parameters shall be measured at this voltage.
4. The modules shall be operationally compatible with currently used controller assemblies (solid state load switches, flashers, and conflict monitors).
5. When a current of 20 mA AC (or less) is applied to the unit, the voltage read across the two leads shall be 15 VAC or less.
6. The LED modules shall provide constant light output under power. Modules with dimming capabilities shall have the option disabled or set on a non-dimming operation.
7. The individual LEDs shall be wired such that a catastrophic loss or the failure of one or more LED will not result in the loss of the entire module.

(d) Retrofit Traffic Signal Module

1. The following specification requirements apply to the Retrofit module only. All general specifications apply unless specifically superseded in this section.
2. Retrofit modules can be manufactured under this specification for the following faces:
 - a. 12 inch (300 mm) circular, multi-section
 - b. 12 inch (300 mm) arrow, multi-section
 - c. 12 inch (300 mm) pedestrian, 2 sections
3. Each Retrofit module shall be designed to be installed in the doorframe of a standard traffic signal housing. The Retrofit module shall be sealed in the doorframe with a one-piece EPDM (ethylene propylene rubber) gasket.
4. The maximum weight of a Retrofit module shall be 4 lbs. (1.8 kg).
5. Each Retrofit module shall be a sealed unit to include all parts necessary for operation (a printed circuit board, power supply, a lens and gasket, etc.), and shall be weather proof after installation and connection.
6. Electrical conductors for modules, including Retrofit modules, shall be 39.4 inches (1m) in length, with quick disconnect terminals attached.
7. The lens of the Retrofit module shall be integral to the unit, shall be convex with a smooth outer surface and made of plastic or of glass.

(e) The following specification requirements apply to the 12 inch (300 mm) arrow module only. All general specifications apply unless specifically superseded in this section.

1. The arrow module shall meet specifications stated in Section 9.01 of the Equipment and Material Standards of the Institute of Transportation Engineers (November 1998) [ITE Standards], Chapter 2 (Vehicle Traffic Control Signal Heads) for arrow indications.

2. The LEDs arrow indication shall be a solid display with a minimum of three (3) outlining rows of LEDs and at least one (1) fill row of LEDs.
- (f) The following specification requirement applies to the 12 inch (300 mm) programmed visibility (PV) module only. All general specifications apply unless specifically superseded in this section.
1. The LED module shall be a module designed and constructed to be installed in a programmed visibility (PV) signal housing without modification to the housing.
- (g) The following specification requirements apply to the 12 inch (300 mm) Pedestrian module only. All general specifications apply unless specifically superseded in this section.
1. Each pedestrian signal LED module shall provide the ability to actuate the solid upraised hand and the solid walking person on one 12 inch (300mm) section.
 2. Two (2) pedestrian sections shall be installed. The top section shall be wired to illuminate only the upraised hand and the bottom section shall be the walking man.
 3. “Egg Crate” type sun shields are not permitted. All figures must be a minimum of 9 inches (225mm) in height and easily identified from a distance of 120-feet (36.6m).

Basis of Payment. This item shall be paid for at the contract unit price each for SIGNAL HEAD, LED, of the type specified, which price shall be payment in full for furnishing the equipment described above including signal head, LED(s) modules, all mounting hardware, and installing them in satisfactory operating condition. The type specified will indicate the number of signal faces, the number of signal sections, and the method of mounting.

Pedestrian head(s) shall be paid for at the contract unit price each for PEDESTRIAN SIGNAL HEAD, LED, of the type specified and of the particular kind of material when specified.

The type specified will indicate the number of faces and the method of mounting.

When installed in an existing signal head, this item shall be paid for at the contract unit price each for SIGNAL HEAD, LED of the type specified, RETROFIT, which price shall be payment in full for furnishing the equipment described above including LED(s) modules, all mounting hardware, and installing them in satisfactory operating condition.

The type specified will indicate the number of signal faces, the number of signal sections, and the method of mounting.

When installed in an existing signal head, this item shall be paid for at the contract unit price each for PEDESTRIAN SIGNAL HEAD, LED, of the type specified, RETROFIT, which price shall be payment in full for furnishing the equipment described above including LED(s) modules, all mounting hardware, and installing them in satisfactory operating condition.

The type specified will indicate the number of faces and the method of mounting.

TABLES

Table 2 Maximum Power Consumption (in Watts)

	Red		Yellow		Green	
	25°C	74°C	25°C	74°C	25°C	74°C
12 inch (300 mm) circular	11	17	22	25	15	15
12 inch (300 mm) arrow	9	12	10	12	11	11
Pedestrian Indication	Hand-Portland Orange		Person-White			
	6.2		6.3			

Table 3 Minimum Initial & Maintained Intensities for Arrow and Pedestrian Indications (in cd/m²)

	Red	Yellow	Green
Arrow Indication	5,500	11,000	11,000

Pedestrian Countdown Signal Head, Light Emitting Diode

Description. This work shall consist of furnishing and installing a pedestrian countdown signal head, with light emitting diodes (LED) of the type specified in the plan.

Pedestrian Countdown Signal Head, Light Emitting Diode, shall conform fully to the SIGNAL HEAD, LIGHT EMITTING DIODE specification, with the following modifications:

(a) Application

1. Pedestrian Countdown Signal Heads, shall not be used at signalized intersections where traffic signals and railroad warning devices are interconnected.
2. All pedestrian signals at an intersection shall be the same type and have the same display. No mixing of countdown and other types of pedestrian traffic signals will be permitted.

(b) General

1. The module shall operate in one mode: Clearance Cycle Countdown Mode Only. The countdown module shall display actual controller programmed clearance cycle and shall start counting when the flashing clearance signal turns on and shall countdown to “0” and turn off when the steady Upraised Hand (symbolizing Don’t Walk) signal turns on. Module shall not have user accessible switches or controls for modification of cycle.
2. At power on, the module shall enter a single automatic learning cycle. During the automatic learning cycle, the countdown display shall remain dark.
3. The module shall re-program itself if it detects any increase or decrease of Pedestrian Timing. The counting unit will go blank once a change is detected and then take one complete pedestrian cycle (with no counter during this cycle) to adjust its buffer timer.
4. The module shall allow for consecutive cycles without displaying the steady Upraised Hand.
5. The module shall recognize preemption events and temporarily modify the crossing cycle accordingly.
6. If the controller preempts during the Walking Person (symbolizing Walk), the countdown will follow the controller's directions and will adjust from Walking Person to flashing Upraised Hand. It will start to count down during the flashing Upraised Hand.
7. If the controller preempts during the flashing Upraised Hand, the countdown will continue to count down without interruption.

8. The next cycle, following the preemption event, shall use the correct, initially programmed values.
9. If the controller output displays Upraised Hand steady condition and the unit has not arrived to zero or if both the Upraised Hand and Walking Person are dark for some reason, the unit suspends any timing and the digits will go dark.
10. The digits will go dark for one pedestrian cycle after loss of power of more than 1.5 seconds.
11. The countdown numerals shall be two (2) “7 segment” digits forming the time display utilizing two rows of LEDs.
12. The LED module shall meet the requirements of the Institute of Transportation Engineers (ITE) LED purchase specification, “Pedestrian Traffic Control Signal Indications - Part 2: LED Pedestrian Traffic Signal Modules,” or applicable successor ITE specifications, except as modified herein.
13. The LED modules shall provide constant light output under power. Modules with dimming capabilities shall have the option disabled or set on a non-dimming operation.
14. In the event of a power outage, light output from the LED modules shall cease instantaneously.
15. The LEDs utilized in the modules shall be AlInGaP technology for Portland Orange (Countdown Numerals and Upraised Hand) and GaN technology for Lunar White (Walking Person) indications.
16. The individual LEDs shall be wired such that a catastrophic loss or the failure of one or more LED will not result in the loss of the entire module.

(c) Pedestrian Countdown Signal Heads

1. Pedestrian Countdown Signal Heads shall be 16 inch (406mm) x 18 inch (457mm), for single units with the housings glossy black polycarbonate. Connecting hardware and mounting brackets shall be polycarbonate (black). A corrosion resistant anti-seize lubricant shall be applied to all metallic mounting bracket joints, and shall be visible to the inspector at the signal turn-on.
2. Each pedestrian signal LED module shall be fully MUTCD compliant and shall consist of double overlay message combining full LED symbols of an Upraised Hand and a Walking Person. “Egg Crate” type sun shields are not permitted. Numerals shall measure 9 inches (229mm) in height and easily identified from a distance of 120 feet (36.6m).

(d) Electrical

1. Maximum power consumption for LED modules is 29 watts.
2. The measured chromaticity shall remain unchanged over the input line voltage range listed of 80 VAC to 135 VAC.

Basis of Payment. This item shall be paid for at the contract unit price each for PEDESTRIAN COUNTDOWN SIGNAL HEAD, LED, of the type specified, which shall be payment in full for furnishing the equipment described above including LED(s) modules, all mounting hardware, and installing them in satisfactory operating condition. The type specified will indicate the number of faces and the method of mounting.

Standard Traffic Signal Design Details

TOP VIEW

TYPE D FOR GROUND MOUNTED CONTROLLER CABINET

TOP VIEW

TYPE C FOR GROUND MOUNTED CONTROLLER CABINET AND UPS BATTERY CABINET

SHROUD DETAIL

TYPE	A	B	C	HEIGHT	WEIGHT
I	10.25" (260mm)	8.5" (216mm)	13" (330mm)	12" (305mm)	24kg
II	11.25" (286mm)	10.75" (273mm)	15.5" (393mm)	12" (305mm)	24kg

NOTE: SUPPORT EXISTING CABINET AND CONTROL EQUIPMENT ON NEW FOUNDATION WHILE FOUNDATION MODIFICATION WORK IS PROCEEDING.

MODIFY EXISTING TYPE 'D' FOUNDATION

NOT TO SCALE

EMERGENCY VEHICLE DETECTOR WITH CONFIRMATION BEACON MOUNTING DETAIL

POST CAP MOUNT

MAST ARM MOUNT

CONFIRMATION BEACON

IDENTIFICATION

ITEM NO.	IDENTIFICATION
1	OUTLET BOG - GALV. ZN. COAT. (0.0000346 OUN.)
2	OUTLET BOG COVER
3	RUBBER COVER CASSET
4	1/2" x 1/8" x 1/8" LOCKWASHER
5	1/2" x 1/8" x 1/8" NUT
6	1/2" x 1/8" x 1/8" NUT
7	1/2" x 1/8" x 1/8" NUT
8	1/2" x 1/8" x 1/8" NUT
9	1/2" x 1/8" x 1/8" NUT
10	1/2" x 1/8" x 1/8" NUT
11	1/2" x 1/8" x 1/8" NUT
12	POST CAP (18.75" x 5.75" x 1.75" MIN.)

8-3-93

STANDARD TRAFFIC SIGNAL DESIGN DETAILS

SPAN WIRE

WIRE WRAP

GALVANIZED TUBING

LIGHT DETECTOR AND CONFIRMATION BEACON FOR TEMPORARY TRAFFIC SIGNALS

NOT TO SCALE

NOTES:

- ALL ELECTRICAL ITEMS, EXCEPT ITEMS #2 AND #11 SHALL BE ALUMINUM OR GALVANIZED.
- ITEM #1 - 02/GENEY PSX-150 OR EQUIVALENT.
- ITEM #2 - MALBERRY CON-O-SHIELD LAMP SHIELD OR EQUIVALENT.
- ITEM #9 - 1/2" x 1/8" x 1/8" SADDLE BRACKET OR EQUIVALENT.
- WHEN POST MOUNTING IS SPECIFIED, ITEM #9 SHALL NOT BE REQUIRED. THE DETECTION UNIT SHALL BE MOUNTED DIRECTLY ON TOP OF THE CAP BY DRILLING THROUGH THE CAP AND SECURING THE DETECTION UNIT TO THE POST WITH FOUR (4) #8 x 1/2" x 1/8" x 1/8" TIGHTENING SCREWS SHALL BE REQUIRED ON EACH CAP.

STATE OF ILLINOIS
 DEPARTMENT OF TRANSPORTATION

DISTRICT 1
 STANDARD TRAFFIC SIGNAL DESIGN DETAILS

SCALE: _____ SHEET NO. _____ OF _____ SHEETS
 TO STA. _____ TO STA. _____

FILE NO. _____ DATE _____
 DRAWN BY _____
 CHECKED BY _____
 DATE _____

CONTRACT NO. _____
 SHEET NO. _____

WOOD OR TELESCOPING STEEL POSTS

Sign panel 900 (36) wide or less

Sign panel over 900 (36) wide

WOOD OR SIGNAL STANDARDS

Sign panel 900 (36) wide or less

Sign panel over 900 (36) wide

LIGHT OR SIGNAL STANDARDS

Sign panel 900 (36) wide or less

Sign panel over 900 (36) wide

BREAKAWAY STEEL TUBING POSTS
 (All sign panel sizes)

ROUTE MARKER ASSEMBLY

SUPPORTING CHANNEL DETAILS

Section modulus (minimum)	Axis A	Axis B
Steel	819 mm ³ (0.050 in. ³)	1720 mm ³ (0.105 in. ³)
Aluminum	2458 mm ³ (0.150 in. ³)	5162 mm ³ (0.315 in. ³)

DETAIL A

DETAIL B

DETAIL C

All dimensions are in millimeters (inches) unless otherwise shown.

DATE	REVISIONS
1-1-97	Revised Standard 2319-6.
2-1-95	Moved C. N. to Specs. Added metric.

SIGN PANEL MOUNTING DETAILS

STANDARD 720001

Illinois Department of Transportation

APPROVED: _____ 1997

ENGINEER OF TRANSPORTATION

APPROVED: _____ 1997

ENGINEER OF TRANSPORTATION

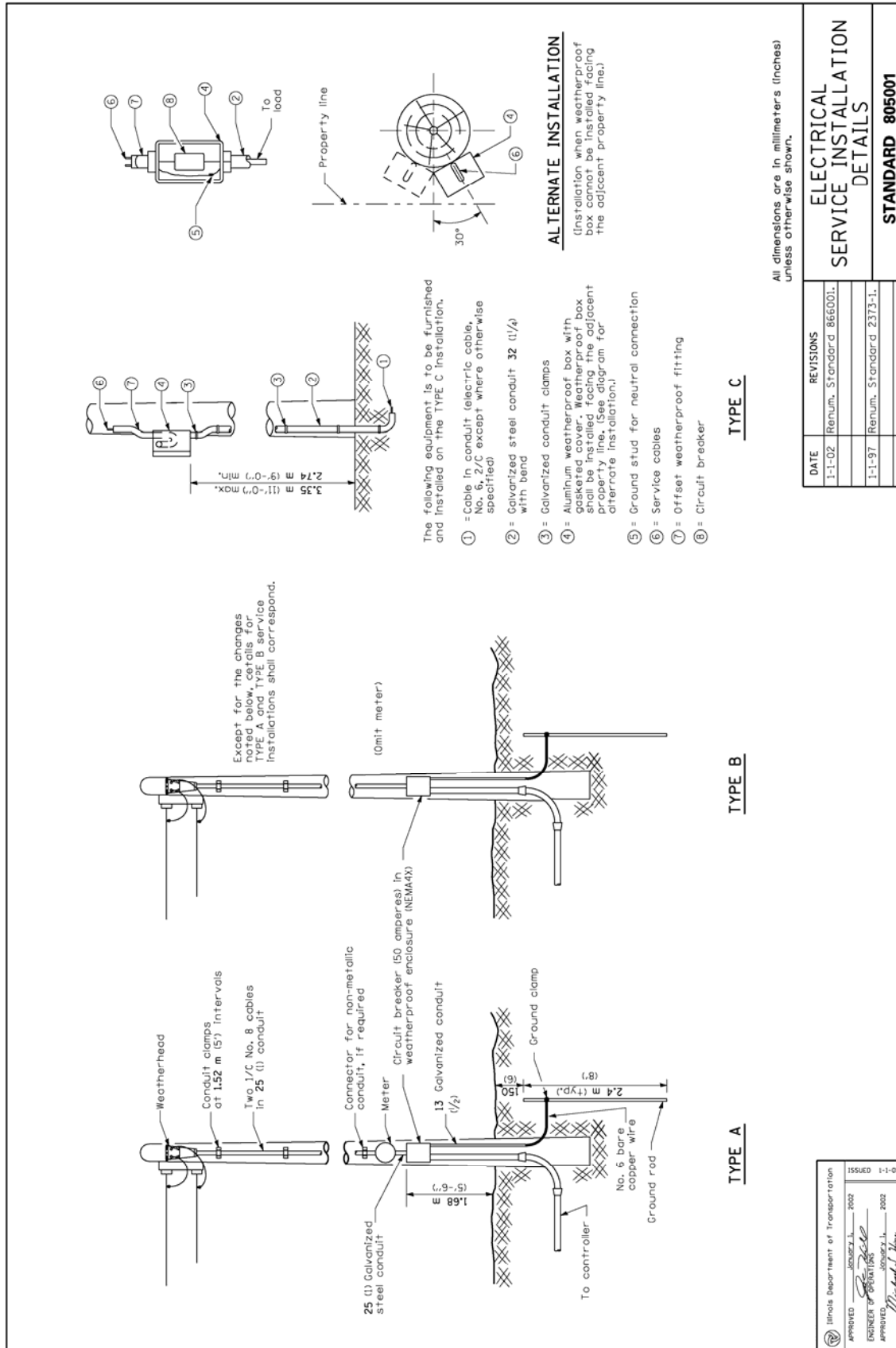

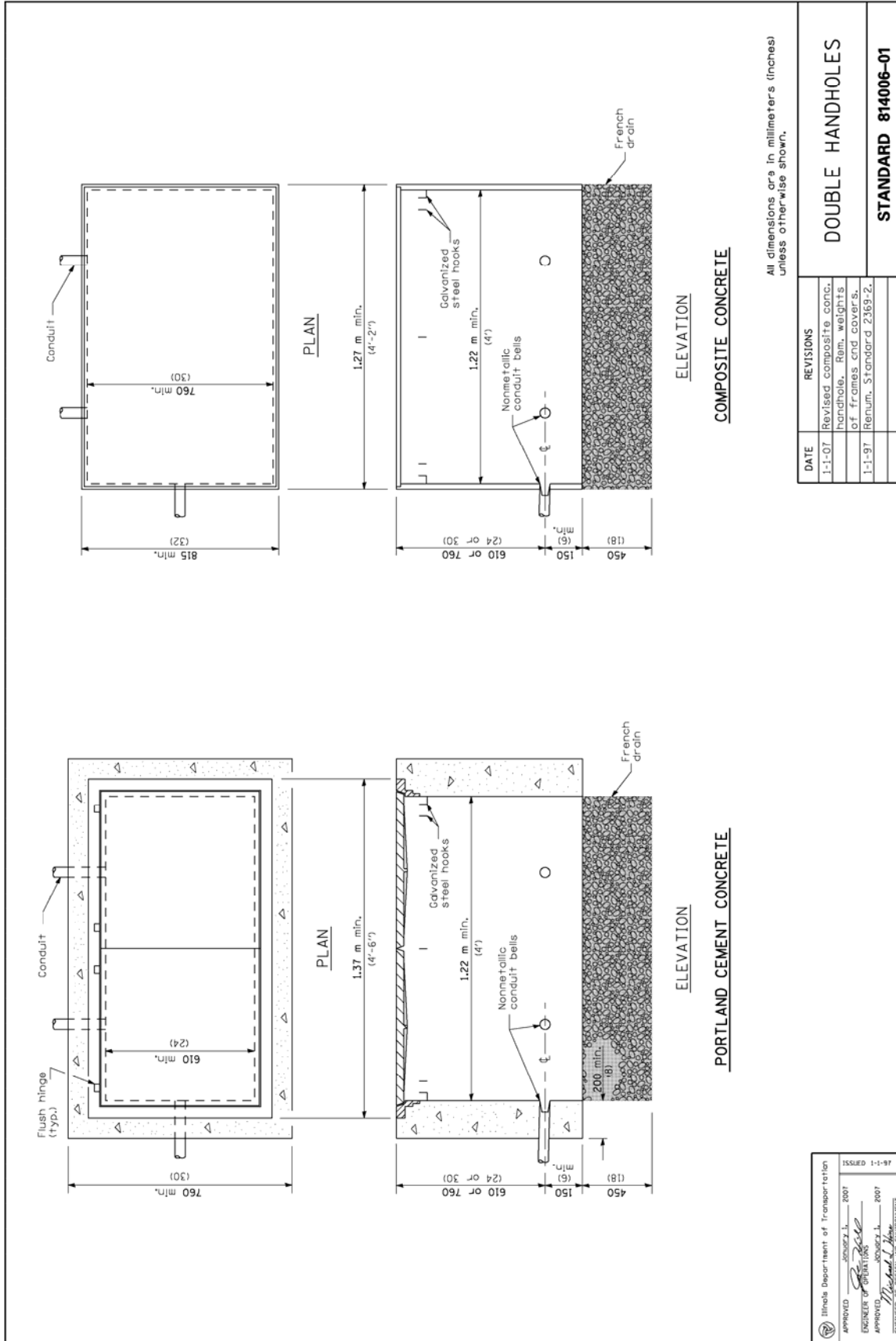

DATE	REVISIONS
1-1-07	Revised composite conc. handhole. Rem. weights of frames and covers.
1-1-97	Renum. Standard 2369-2.

Illinois Department of Transportation
 APPROVED: [Signature] 2007
 ENGINEER OF OPERATIONS
 APPROVED: [Signature] 2007
 ENGINEER OF DESIGN AND ENVIRONMENT

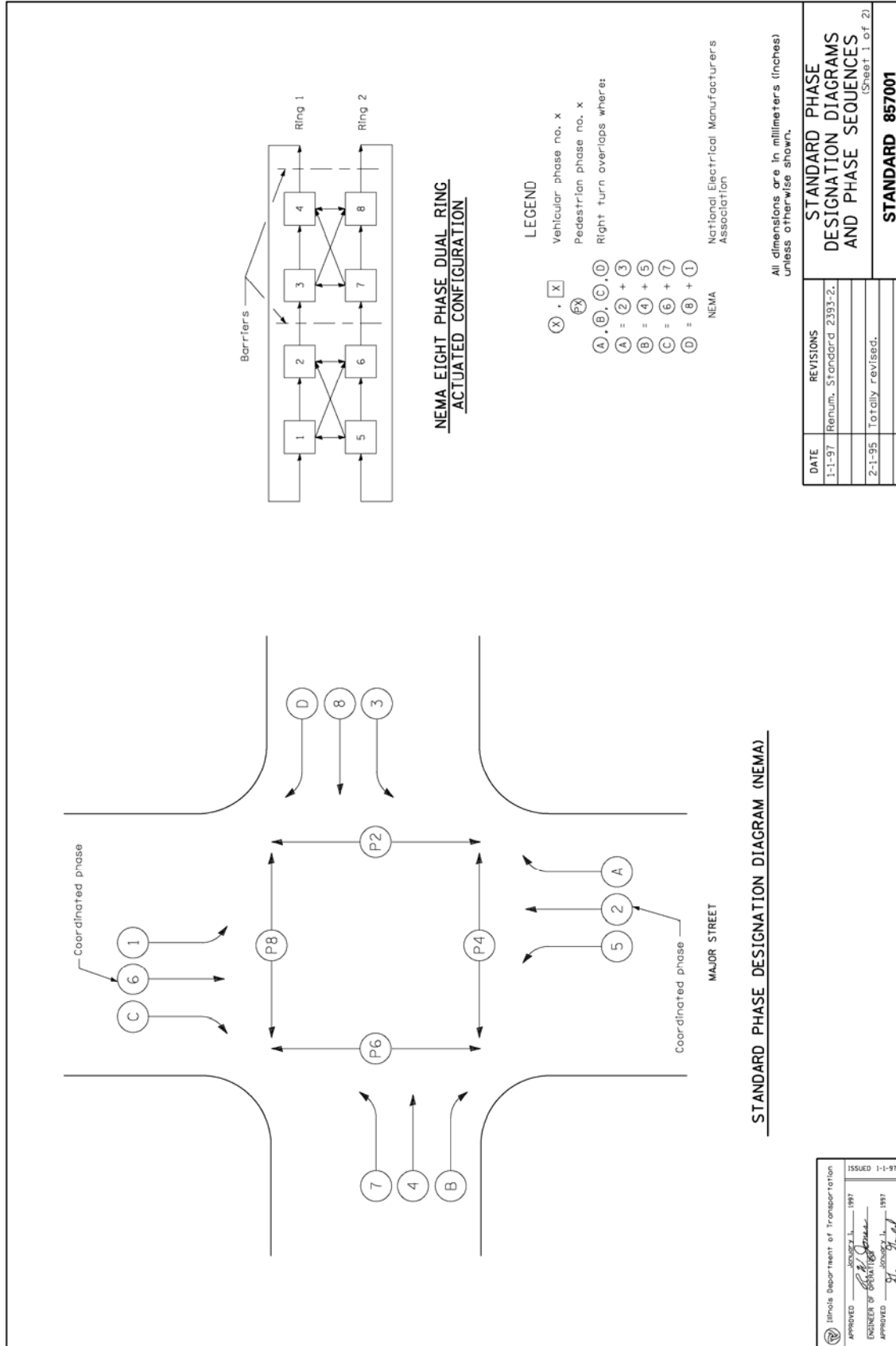

Illinois Department of Transportation
 APPROVED: _____ 1997
 ENGINEER OF TRANSPORTATION
 APPROVED: _____ 1997
 ENGINEER OF TRANSPORTATION

DATE	REVISIONS
1-1-97	Renum. Standard 2393-2.
2-1-95	Totally revised.

STANDARD PHASE DESIGNATION DIAGRAMS AND PHASE SEQUENCES
 (Sheet 1 of 2)

STANDARD 857001

All dimensions are in millimeters (inches) unless otherwise shown.

NEMA
 National Electrical Manufacturers Association

NEMA EIGHT PHASE DUAL RING ACTUATED CONFIGURATION

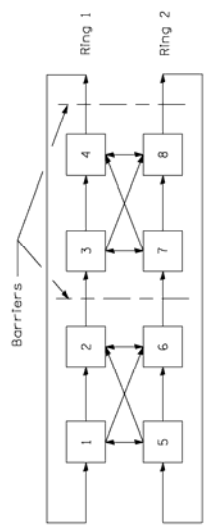

LEGEND

- (X) • [X] Vehicular phase no. x
- (X) • [X] Pedestrian phase no. x
- (X) • [X] Right turn overlaps where:
- (A) = (2) + (3)
- (B) = (4) + (5)
- (C) = (6) + (7)
- (D) = (8) + (1)

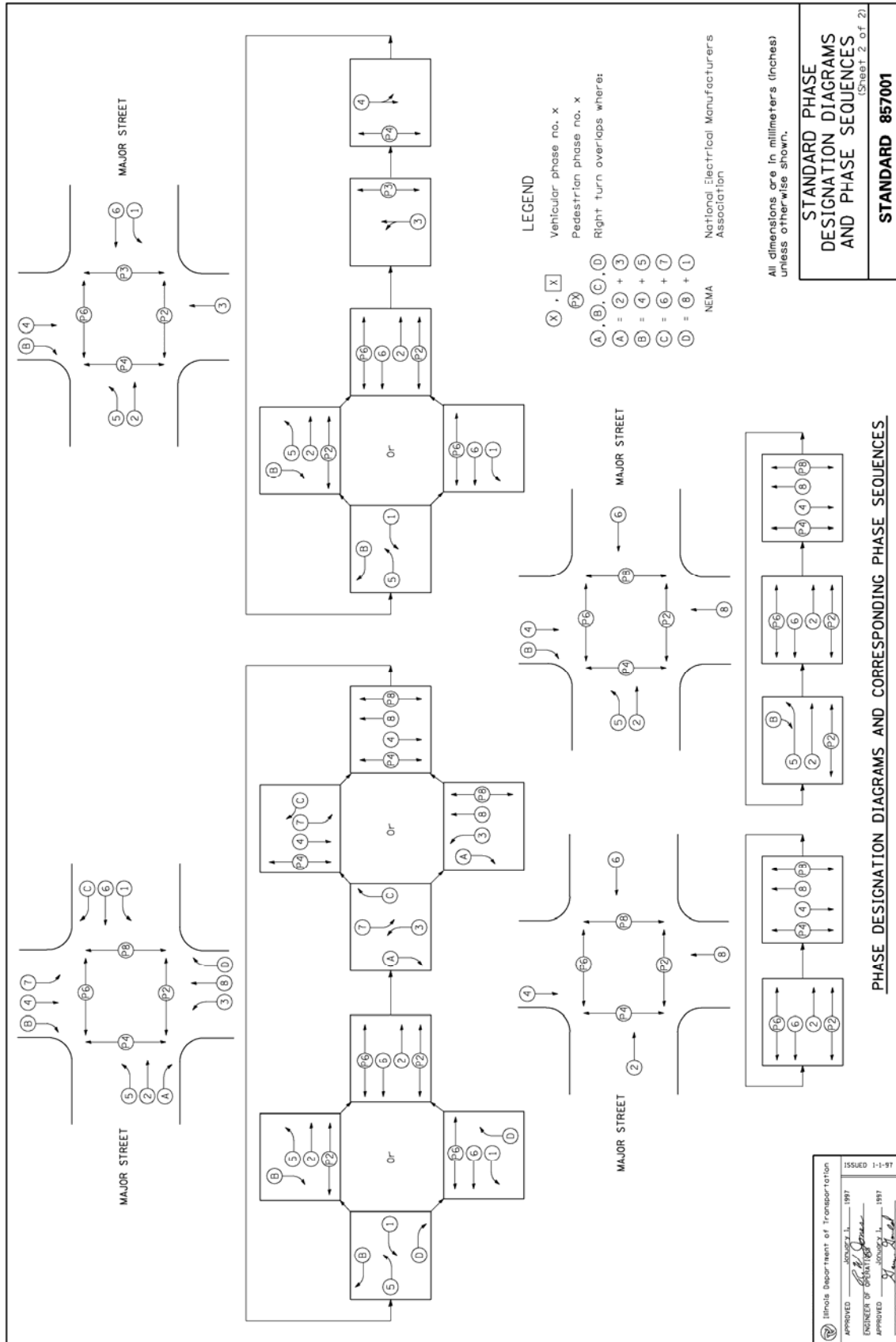

Illinois Department of Transportation
 APPROVED _____ DATE _____ 1997
 ENGINEER OF TRANSPORTATION
 APPROVED _____ DATE _____ 1997
 ENGINEER OF DESIGN AND ENVIRONMENT

ISSUED 1-1-97

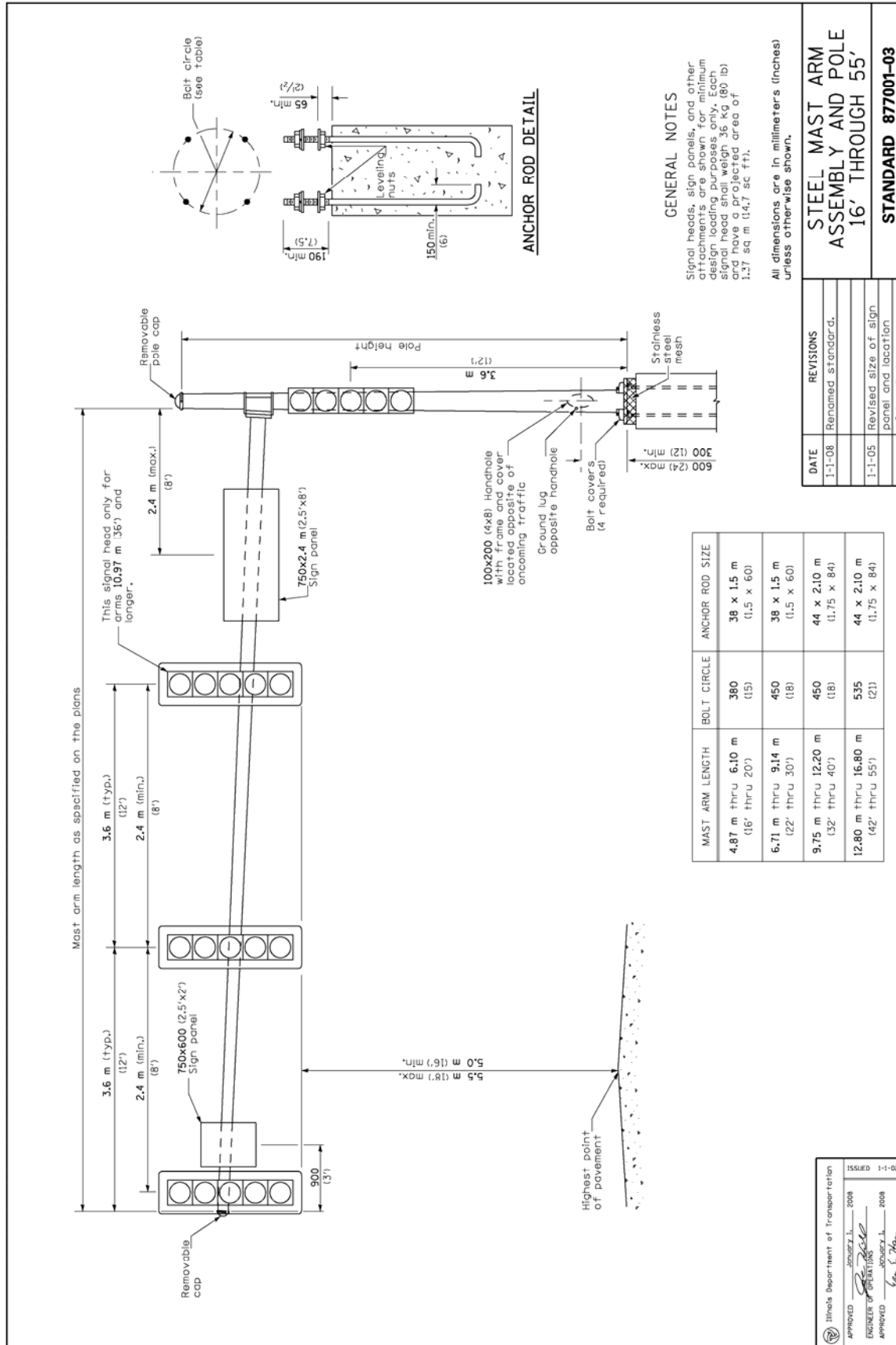

Illinois Department of Transportation
 APPROVED: [Signature] 2008
 ENGINEER OF OPERATIONS
 APPROVED: [Signature] 2008
 ENGINEER OF DESIGN AND ENVIRONMENT

ISSUED 1-1-02

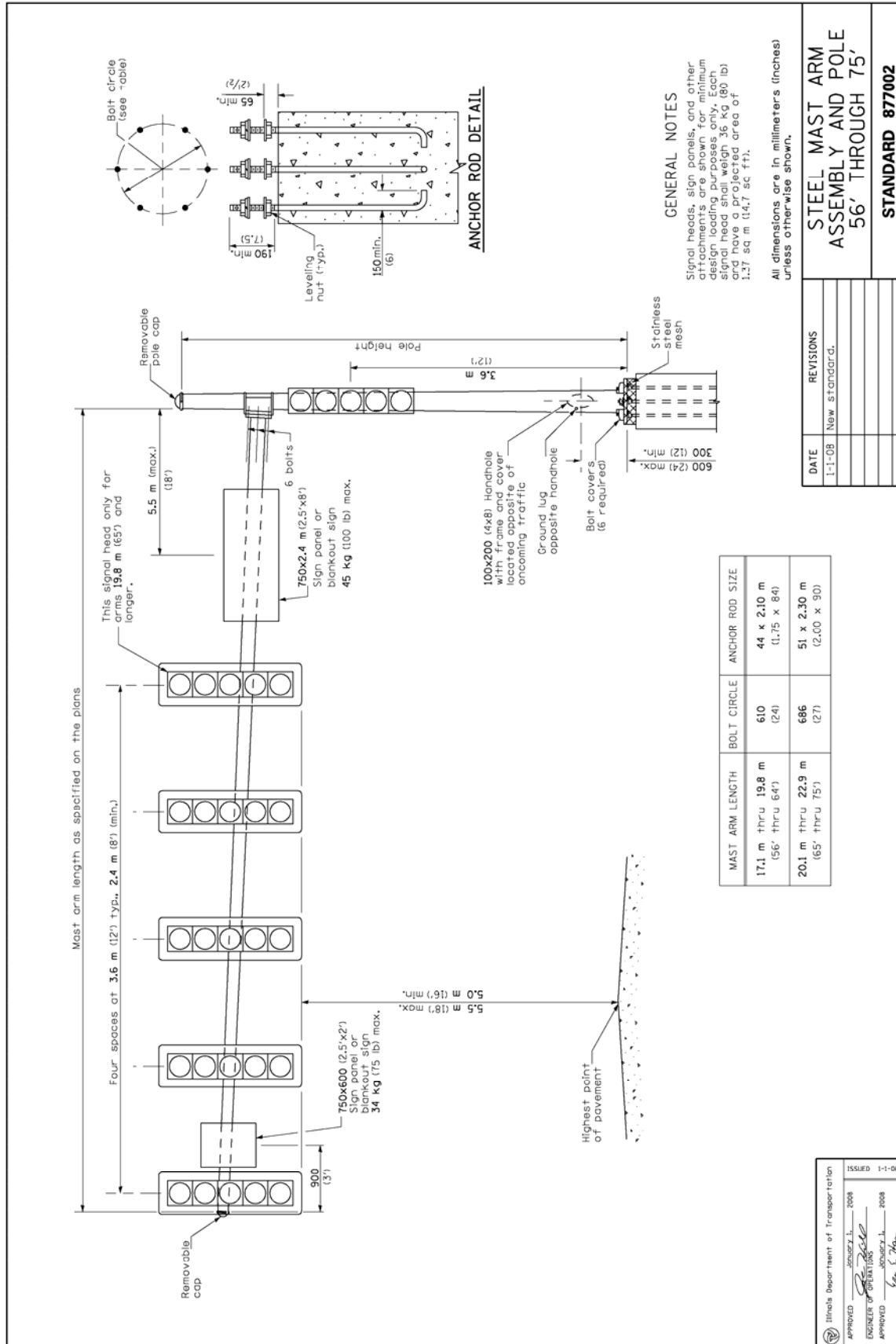

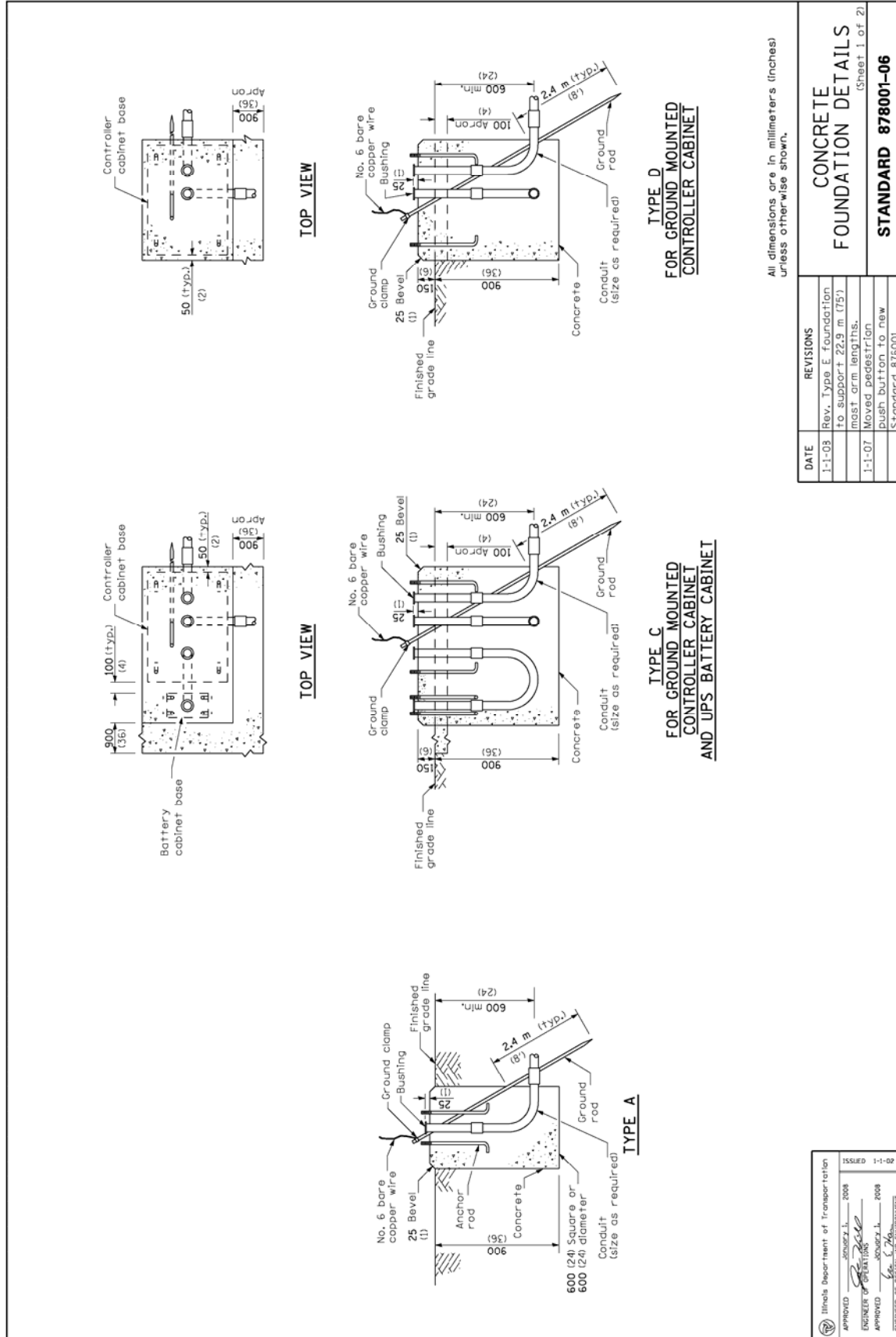

All dimensions are in millimeters (inches) unless otherwise shown.

DATE	REVISIONS
1-1-03	Rev. Type E foundation to support 22.9 m (75') mast arm lengths.
1-1-07	Moved pedestrian push button to new Standard 876001.

CONCRETE FOUNDATION DETAILS
 (Sheet 1 of 2)
STANDARD 878001-06

Illinois Department of Transportation	ISSUED 1-1-02
APPROVED <i>[Signature]</i> 2008	
ENGINEER OF OPERATIONS	
APPROVED <i>[Signature]</i> 2008	
ENGINEER OF DESIGN AND ENVIRONMENT	

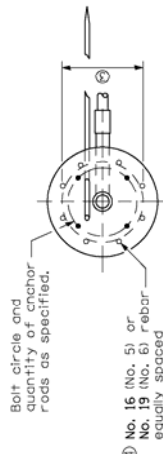

TOP VIEW

Mast Arm Length	① Foundation Depth*	② Foundation Diameter	③ Spiral Diameter	④ Quantity of Rebars	Size of Rebars
Less than 9.1 m (30')	3.0 m (10'-0")	750 (30)	600 (24)	8	16 (5)
Greater than or equal to 9.1 m (30') and less than 12.2 m (40')	4.1 m (13'-6")	750 (30)	600 (24)	8	16 (5)
Greater than or equal to 12.2 m (40') and less than 15.2 m (50')	3.4 m (11'-0")	900 (36)	750 (30)	12	16 (5)
Greater than or equal to 15.2 m (50') and less than 16.8 m (55')	4.0 m (13'-0")	900 (36)	750 (30)	12	16 (5)
Greater than or equal to 16.8 m (55') and less than 19.8 m (65')	4.6 m (15'-0")	900 (36)	750 (30)	12	19 (6)
Greater than or equal to 19.8 m (65') and up to 22.9 m (75')	6.4 m (21'-0")	1060 (42)	900 (36)	16	19 (6)
	1.6 m (5'-0")	1060 (42)	900 (36)	16	19 (6)

* These foundation depths are for sites which have cohesive soils (clayey silt, sandy clay, etc.) along the length of the shaft, with an average unconfined compressive strength (q_u) > 100 kPa (1.0 tsf). This strength shall be verified by boring data prior to construction or with testing by the Engineer during foundation drilling. The Bureau of Bridges & Structures should be contacted for a revised design if other conditions are encountered.

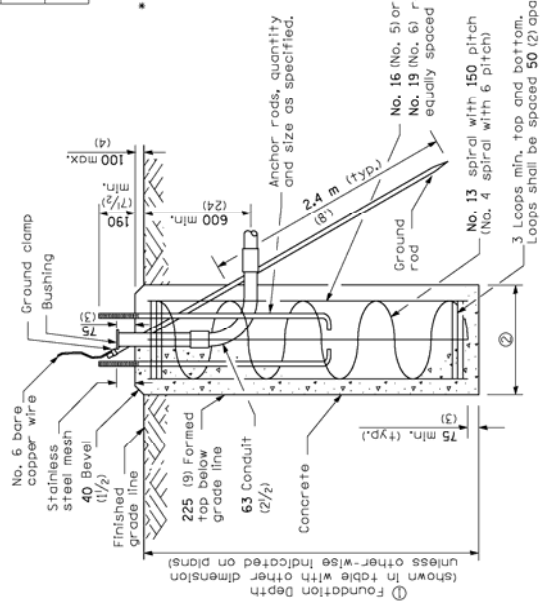

TYPE E

For standard and combination mast assemblies, Mast arm assemblies with dual arms require a special foundation design.

All dimensions are in millimeters (inches) unless otherwise shown.

Illinois Department of Transportation
 APPROVED: [Signature] 2008
 ENGINEER OF OPERATIONS
 APPROVED: [Signature] 2008
 ENGINEER OF DESIGN AND ENVIRONMENT

ISSUED 1-1-02

CONCRETE FOUNDATION DETAILS
 (Sheet 2 of 2)
STANDARD 878001-06

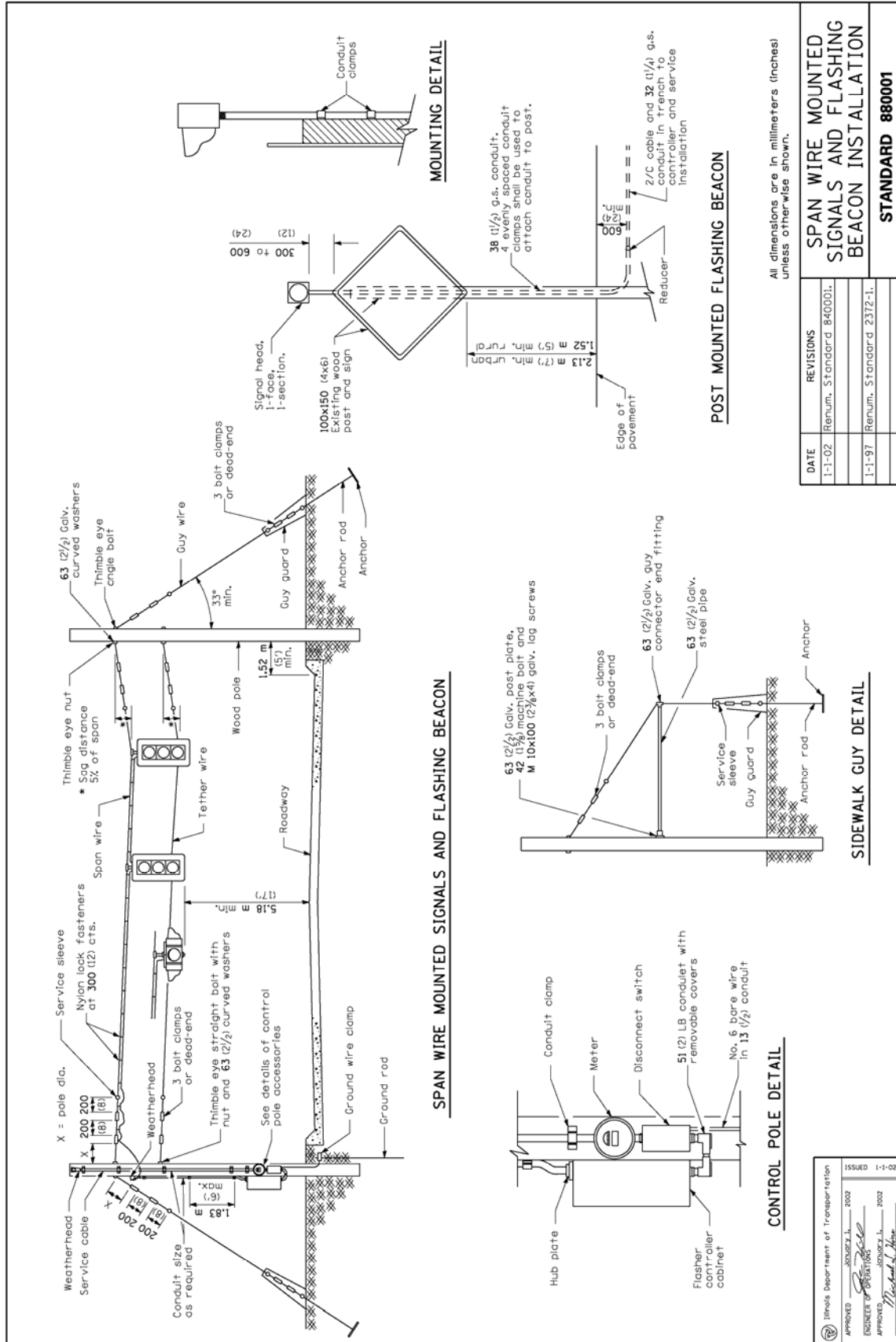

All dimensions are in millimeters (inches) unless otherwise shown.

DATE	REVISIONS
1-1-02	Revised Standard 840001.
1-1-97	Revised Standard 2372-1.

SPAN WIRE MOUNTED SIGNALS AND FLASHING BEACON INSTALLATION

STANDARD 880001

APPROVED	JANUARY 1, 2002	ISSUED	1-1-02
ENGINEER OF TRANSPORTATION	<i>[Signature]</i>		
APPROVED	JANUARY 1, 2002		
	<i>[Signature]</i>		

ILLINOIS DEPARTMENT OF TRANSPORTATION

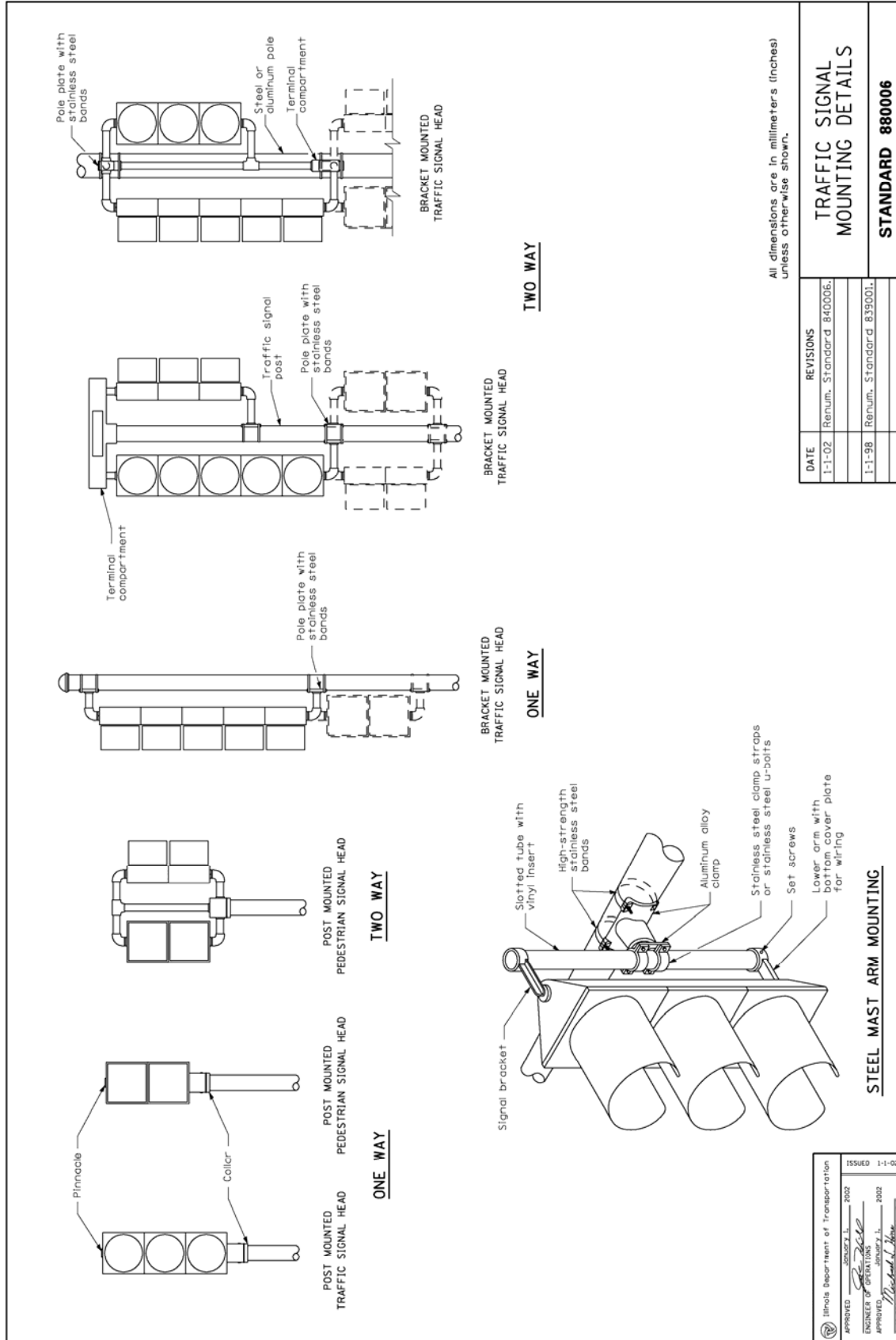

All dimensions are in millimeters (inches) unless otherwise shown.

DATE	REVISIONS
1-1-02	Renum. Standard 840006.
1-1-98	Renum. Standard 839001.

TRAFFIC SIGNAL MOUNTING DETAILS

STANDARD 880006

APPROVED ENGINEER OF TRANSPORTATION APPROVED ENGINEER OF DESIGN AND ENVIRONMENT	ISSUED 1-1-02 JANUARY 1, 2002 JANUARY 1, 2002
--	---

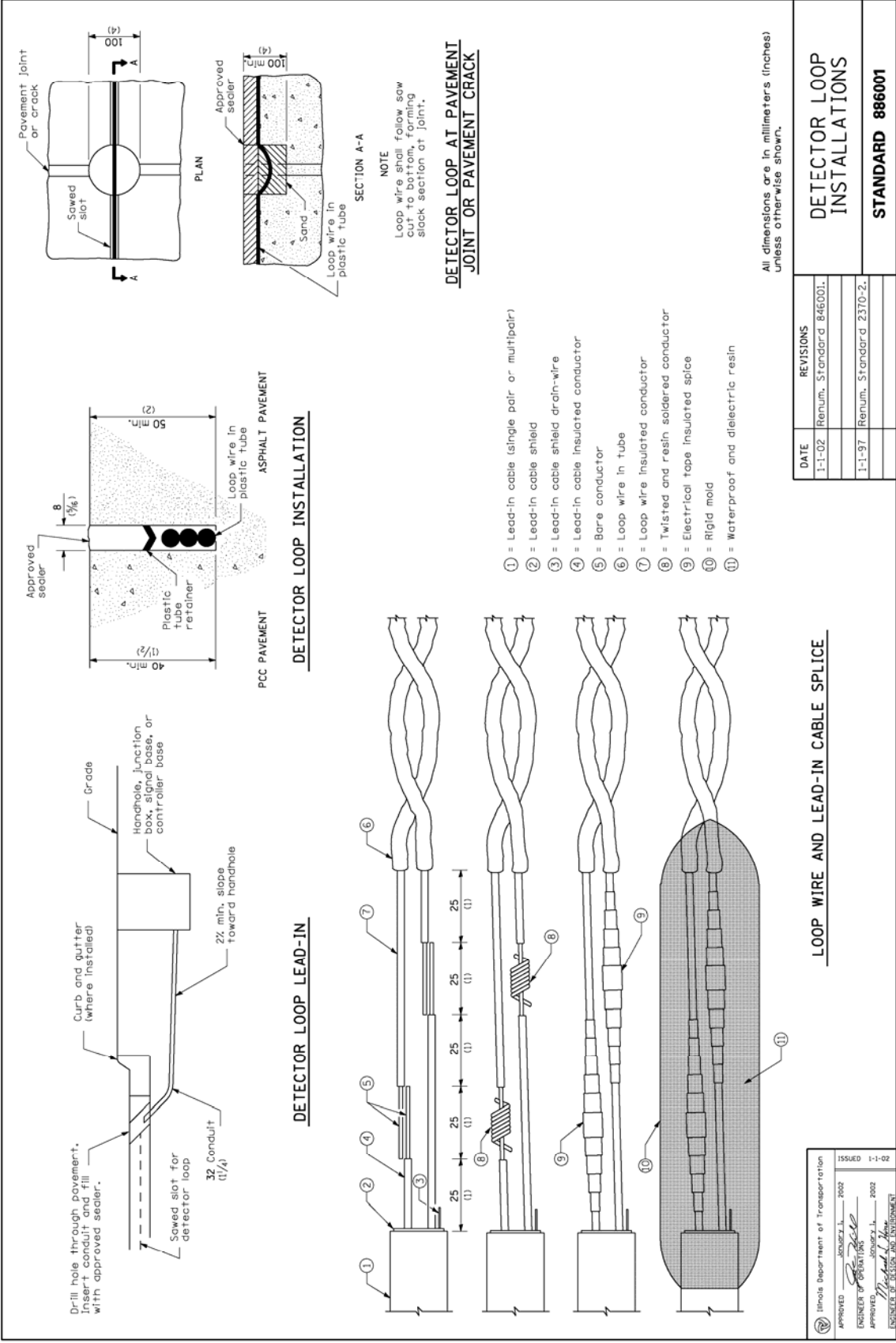

LOOP DETECTOR NOTES

1. EACH PAIR OF LOOP WIRES SHALL BE PLACED IN A SEPARATE UNIT DUCT FROM THE EDGE OF PAVEMENT TO THE HANDHOLE. SPACING BETWEEN THE HOLES DRILLED IN THE PAVEMENT SHALL NOT BE LESS THAN 6" (150 mm). UNIT DUCT SHALL BE INCLUDED IN THE COST OF THE LOOP WIRE.
2. THE NUMBER OF LOOP TURNS SHALL BE AS RECOMMENDED BY THE AMPLIFIER MANUFACTURER. ALL ADJACENT SIDES OF THE LOOPS SHALL BE INSTALLED IN SUCH A WAY THAT THE CURRENT FLOW IS IN THE SAME DIRECTION TO REINFORCE ITS MAGNETIC FIELDS FOR SMALL VEHICLE DETECTION.
3. EACH LOOP LEAD-IN SHALL BE IDENTIFIED AND PERMANENTLY TAGGED IN THE HANDHOLE. EACH LEAD-IN CABLE TAG SHALL INDICATE THE LOCATION OF THE LOOP, LOOP ROTATION (CLOCKWISE/COUNTERCLOCKWISE), LOOP LEAD-IN DIRECTION (IN OR OUT), LOOP CABLE NUMBER AND LOCATION IN CABINET, AND NUMBER OF TURNS IN THE DETECTOR LOOPS IN WATER PROOF INK AS INDICATED ON THE DISTRICT 1 STANDARD TRAFFIC SIGNAL DESIGN DETAIL. THE CONTRACTOR SHALL MARK LOOP LOCATIONS ON RECORD DRAWINGS AND PRESENT TO THE ENGINEER AFTER FINAL INSPECTION. LOOPS SHALL BE MARKED BY LANE AND LOOP NUMBER. SEE DETAIL BELOW.
4. ALL LOOP CABLE SHALL BE FASTENED WITH PLASTIC TIE WRAP TO THE HANDHOLE HOOKS.
5. IN ASPHALT PAVEMENT, LOOPS SHOULD BE PLACED IN THE BINDER AND DIVERTIBLES MARKED AT THE CURB WITH A SAW-CUT. THE SAW-CUT SHALL BE CUT IN ACCORDANCE WITH LOCAL AND E.P.A. DUST CONTROL REQUIREMENTS. DETECTOR LOOPS SHALL NOT BE INSTALLED IN WET CONDITIONS. THE SURFACE SHALL BE FREE OF DEBRIS AND RESIDUE. THE SURFACE SHALL BE COMPACTED AND FINISHED TO THE USE OF COMPRESSED AIR BRUSHING AND HEAT DRYING ACCORDING TO SEALANT MANUFACTURER REQUIREMENTS. THE DETECTOR WIRE SHALL BE HELD IN PLACE BY THE USE OF FORM WEDGES. WEDGES SHALL BE SPACED NO MORE THAN 18" (450 mm) APART.
6. LOOP SPLICES SHALL BE SOLDERED USING A SOLDERING IRON. BLOW TORCHES OR OTHER DEVICES WHICH OXIDIZE COPPER CABLE SHALL NOT BE ALLOWED FOR SOLDERING OPERATIONS. SEE DETAIL BELOW RIGHT.
7. PREFORMED DETECTOR LOOPS SHALL BE USED, AS SHOWN ON THE PLANS, WHERE NEW CONCRETE PAVEMENT IS PROPOSED. THE INSTALLATION OF PREFORMED LOOPS SHALL BE IN ACCORDANCE WITH THE DISTRICT 1 SPECIFICATIONS OR AS DIRECTED BY THE ENGINEER.

LOOP LEAD-IN CABLE TAG

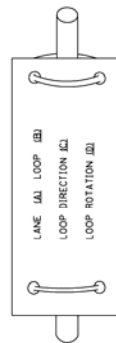

- A. LANE IS THE LANE CLOSEST TO THE CENTERLINE OF THE ROADWAY
- B. LOOP #1 IS THE LOOP IN THE LANE CLOSEST TO THE INTERSECTION.
- C. LABEL LOOP CABLE "IN" OR LOOP CABLE "OUT".
- D. LABEL LOOP CABLE CLOCKWISE OR LOOP CABLE COUNTERCLOCKWISE.

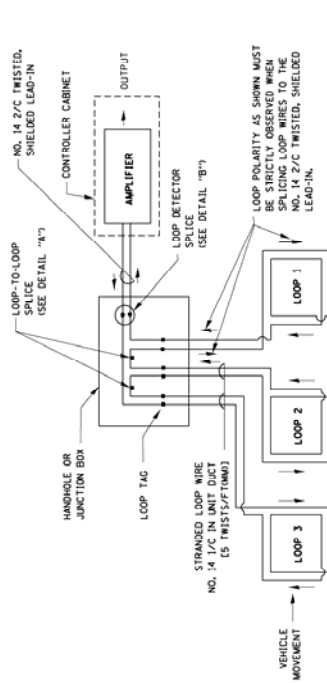

DETECTOR LOOP WIRING SCHEMATIC

- LOOPS SHALL BE SPLICED IN SERIES.
- SAW-CUTS SHALL BE A MINIMUM WIDTH OF 5/16" (18 mm).
- SAW-CUT DEPTHS SHALL BE 3" (75 mm), IF IN CONCRETE. THE SAW-CUT DEPTH SHALL BE TO THE TOP OF THE REINFORCEMENT.
- LOOP CORNERS SHALL BE DRILLED WITH A 2" (50 mm) DIAMETER CORE.

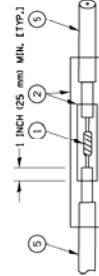

**DETAIL "A"
LOOP-TO-LOOP SPLICE**

LOOP DETECTOR SPLICE

- 1 WESTERN UNION SPLICE SOLDERED WITH ROSIN CORE FLUX. ALL EXPOSED SURFACES OF THE SOLDER SHALL BE SMOOTH.
- 2 WCSM 30/100 HEAT SHRINK TUBE. MINIMUM LENGTH 3" (75 mm), UNDERWATER GRADE.
- 3 WS 200/750 HEAT SHRINK TUBE. MINIMUM LENGTH 6" (150 mm), UNDERWATER GRADE.
- 4 NO. 14 2/C TWISTED, SHIELDED CABLE.
- 5 LOOP CONDUCTOR WITH FLEXIBLE PLASTIC TUBE.

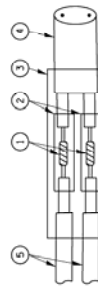

**DETAIL "B"
LOOP-TO-CONTROLLER SPLICE**

FILE NAME : 60E15-02-201-100-001	DESIGNED : D.A.J.	REVISION : 11-22-20	DISTRICT ONE	SHEET NO. 1 OF 4	SHEETS 1 STA.	TO STA.
USER NAME : 60E15-02-201-100-001	DRAWN : R.A.P.	REVISION : BUR. TRAFFIC 01-01-02	STANDARD TRAFFIC SIGNAL DESIGN DETAILS	SECTION	TS-49	
PLOT DATE : 04/08/2011 11:00 AM	CHECKED : D.A.J.	REVISION :	SCALE: NONE	FIG. NAME DIST. NO. 1	ILLUMINATED, AIR PROTECT	
PLOT DATE : 11/22/2010	DATE : 05-30-00	REVISION :				

NOTES:

1. ACCESSIBLE PEDESTRIAN SIGNAL LOCATIONS WITH PEDESTRIAN ACTUATION EACH PUSHBUTTON SHOULD ACTIVATE BOTH THE MAIN INTERVAL AND THE ACCESSIBLE PEDESTRIAN SIGNALS.
 AT ACCESSIBLE PEDESTRIAN SIGNAL LOCATIONS, PUSHBUTTONS SHOULD CLEARLY INDICATE WHICH CROSSWALK SIGNAL IS ACTIVATED BY EACH PUSHBUTTON. PUSHBUTTONS AND TACTILE WRIBES SHOULD BE OF A SIZE AND SPACING FOR ACCESSIBLE PEDESTRIAN SIGNALS. ACCESSIBLE PEDESTRIAN SIGNALS SHOULD BE MOUNTED AT THE CORNERS OF SIGNALIZED LOCATIONS. THE PUSHBUTTONS SHOULD BE SIGNALIZED BY THE DISTANCE OF AT LEAST 10 FT FROM THE APPROPRIATE PUSHBUTTON.
 PUSHBUTTONS FOR ACCESSIBLE PEDESTRIAN SIGNALS SHOULD BE LOCATED AS FOLLOWS:
 A) ADJACENT TO A LEVEL, ALL-WEATHER SURFACE TO PROVIDE ACCESS FROM A WHEELCHAIR, AND WHERE THERE IS AN ALL-WEATHER SURFACE, WHEELCHAIR ACCESSIBLE ROUTE TO THE RAMP.
 B) WITHIN 5 FT (1.5m) OF THE CROSSWALK EXTENDED.
 C) WITHIN 10 FT (3m) OF THE EDGE OF CURB, SHOULDER, OR PAVEMENT.
 D) PARALLEL TO THE CROSSWALK TO BE USED (SEE MUTCD FIGURE 4E-2).
 E) ABOVE PEDESTRIAN PUSHBUTTON MOUNTING HEIGHT SHOULD BE 3.5 FT (1.05m) ABOVE ADJACENT SIDEWALK.
 PEDESTRIAN SIGNAL FACES SHALL BE MOUNTED WITH THE BOTTOM OF THE HOUSING NOT LESS THAN 2.0m (6.56ft) OR MORE THAN 10 (3.05m) ABOVE THE SIDEWALK LEVEL AND SO THERE IS A PEDESTRIAN INDICATION IN THE LINE OF PEDESTRIANS' VISION WHICH PERTAINS TO THE CROSSWALK BEING USED.
 3. THE BOTTOM OF THE HOUSING OF A VEHICLE SIGNAL FACE, NOT MOUNTED OVER A ROADWAY, SHALL BE AT LEAST 10 FT (3.0m) BUT NOT MORE THAN 15 FT (4.5m) ABOVE THE SIDEWALK OR, ABOVE THE PAVEMENT GRADE AT THE CENTER OF THE ROADWAY IF NO SIDEWALK EXISTS.
 4. THE BOTTOM OF THE HOUSING OF A VEHICLE SIGNAL FACE, MOUNTED OVER A ROADWAY, SHALL BE ACCORDING TO MUTCD FIGURES 8F001 AND 8F002, 10 FT (3.0m) MIN., 18 FT (5.5m) MAX. FROM HIGHEST POINT OF PAVEMENT.

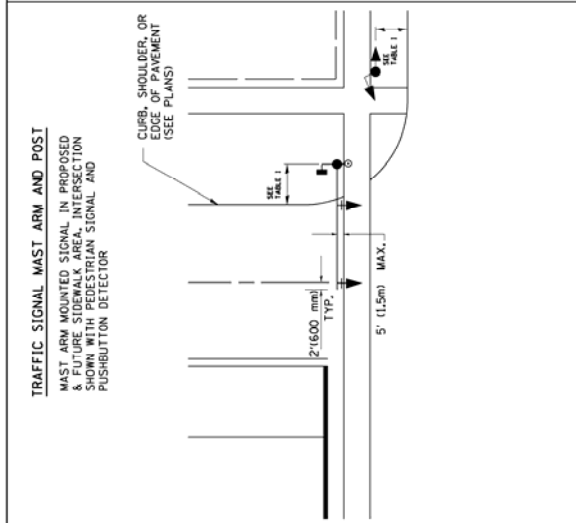
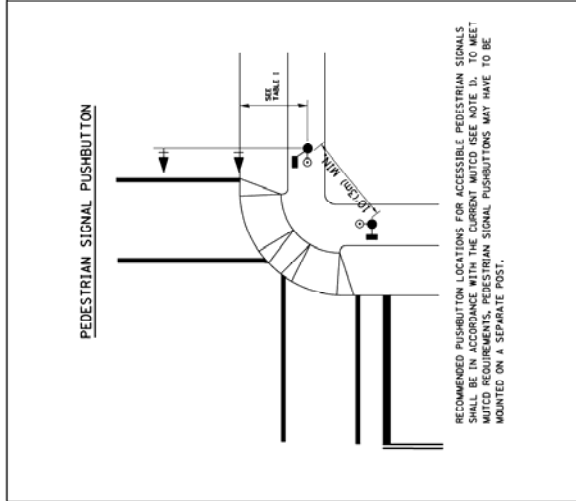
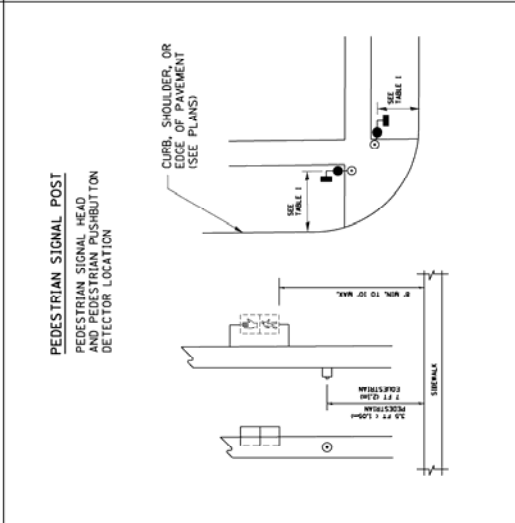
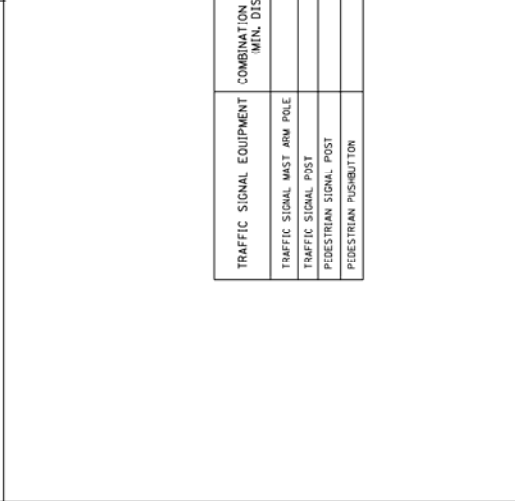

TABLE I

TRAFFIC SIGNAL EQUIPMENT	COMBINATION CONCRETE CURB AND CUTTER (MIN. DIST. FROM BACK OF CURB)	SHOULDER/NON-CURBED AREA (MIN. DIST. FROM EDGE OF PAVEMENT)
TRAFFIC SIGNAL MAST ARM POLE	6 FT (1.8m)	SHOULDER WIDTH + 2 FT (0.6m), MINIMUM 10 FT (3.0m)
TRAFFIC SIGNAL POST	4 FT (1.2m)	SHOULDER WIDTH + 2 FT (0.6m), MINIMUM 10 FT (3.0m)
PEDESTRIAN SIGNAL POST	4 FT (1.2m)	SHOULDER WIDTH + 2 FT (0.6m), MINIMUM 10 FT (3.0m)
PEDESTRIAN PUSHBUTTON	SEE NOTE 1	SEE NOTE 1



FILE NAME : 60E15-002TS-001-001	DESIGNED : D.A.J.	REVISION : BULK TRAFFIC 01-01-02	DISTRICT ONE	SECTION	TOTAL SHEET
PLOT SCALE : 3/8"=1'-0"	DRAWN : R.A.P.	REVISION :	STANDARD TRAFFIC SIGNAL DESIGN DETAILS	TS-09	COUNTY SHEETS NO.
PLOT DATE : 11/27/08	CHECKED : D.A.J.	REVISION :	SHEET NO. 2 OF 4	15-09	CONTRACT NO.
	DATE :	REVISION :	SCALE: NONE	FILE NAME DIST. NO. 1	ILLUSTRATED A3P PROJECT
				TO STA.	

Section 3 – List of Locations

Ct.	Loc. #	Main Route	Nearest Cross Street	Co.	Cab. / M.P.	RM Pay Item
1	L0103	I-55	Martin Luther King Dr	Cook	A	L-1
2	L0105	I-55	Michigan Ave	Cook	B	L-1
3	L0110	I-55	Wentworth Ave	Cook	C	L-1
4	L0115	I-55	Stewart Ave	Cook	D	L-1
5	L0120	I-55	Loomis St [Incl Nav]	Cook	E	L-1
6	L0123	I-55	Ashland Ave	Cook	E1	L-1
7	L0125	I-55	Damen Ave	Cook	F	L-1
8	L0130	I-55	California Ave	Cook	G	L-1
9	L0133	I-55	Kedzie Ave	Cook	G1	L-1
10	L0135	I-55	Pulaski Rd	Cook	H	L-1
11	L0137	I-55	Pulaski Rd Tunnel	Cook	H1	L-1
12	L0140	I-55	IL 50 (Cicero Ave)	Cook	I	L-1
13	L0145	I-55	S Central Ave	Cook	W	L-1
14	L0150	I-55	N Central Ave	Cook	X	L-1
15	L0155	I-55	Central Ave	Cook	J	L-1
16	L0160	I-55	64th St (6400 W)	Cook	K	L-1
17	L0165	I-55	IL 43 (Harlem Ave)	Cook	L	L-1
18	L0170	I-55	IL 43 (Harlem Ave)	Cook	Y	L-1
19	L0171	I-55	IL171 & 55th St	Cook	V	L-1
20	L0173	I-55	IL 171 (1st Ave) [Incl Nav]	Cook	M	L-1
21	L0175	I-55	IL 171 (1st Ave) [Incl Nav]	Cook	N	L-1
22	L0177	I-55	IL 171 & 47th St	Cook	Z	L-1
23	L0180	I-55	85th Ave (8500W)	Cook	O	L-1
24	L0184	I-55	91st Ave (9100W)	Cook	P	L-1
25	L0187	I-55	US 12/20/45 (LaGrange Rd)	Cook	R	L-1
26	L0188	I-55	SB US12/20/45 (LaGrange Rd) Ramp	Cook	R1	L-1
27	L0190	I-55	Wolf Rd	Cook	S	L-1
28	L0193	I-55	W of I-294 Tollway	Cook	S1	L-1
29	L0195	I-55	County Line Rd	Cook	T	L-1
30	L0403	I-57	99th St	Cook	A	L-1
31	L0405	I-57	Racine Ave	Cook	B	L-1
32	L0410	I-57	107th Pl	Cook	C	L-1
33	L0415	I-57	112th St	Cook	D	L-1
34	L0420	I-57	120th St	Cook	E	L-1
35	L0425	I-57	127th St	Cook	F	L-1
36	L0430	I-57	Vermont St	Cook	G	L-1
37	L0435	I-57	IHB RR	Cook	H	L-1
38	L0440	I-57	Spaulding Ave	Cook	I	L-1
39	L0445	I-57	147th St	Cook	J	L-1
40	L0450	I-57	Kedzie Ave	Cook	K	L-1
41	L0455	I-57	US 6 (159th St)	Cook	L	L-1
42	L0460	I-57	159th St & Crawford Ave	Cook	P	L-1
43	L0465	I-57	163rd St (Barry Ln)	Cook	M	L-1
44	L0470	I-57	W 167th St	Cook	N	L-1
45	L0475	I-57	E 167th St	Cook	O	L-1
46	L0480	I-57	175th St	Cook	T	L-1
47	L0485	I-57	I-80	Cook	U	L-1
48	L0489	I-57	Flossmoor Rd	Cook	V	L-1
49	L0492	I-57	Vollmer Rd	Cook	W	L-1
50	L0495	I-57	US 30 (Lincoln Highway)	Cook	X	L-1
51	L0497	I-57	Sauk Trail Rd	Cook	Y	L-1

Ct.	Loc. #	Main Route	Nearest Cross Street	Co.	Cab. / M.P.	RM Pay Item
52	L0603	I-80/94	Burnham Ave	Cook	A	L-1
53	L0605	I-80/94	Torrence Ave	Cook	B	L-1
54	L0610	I-80	169th St	Cook	E	L-1
55	L0615	I-80	Crawford Ave	Cook	F	L-1
56	L0618	I-80	175th St	Cook	F1	L-1
57	L0620	I-80	Central Ave	Cook	G	L-1
58	L0625	I-80	Ridgeland Ave	Cook	H	L-1
59	L0803	US 12/45	Devon Ave	Cook	A	L-1
60	L0805	US 12/45	Lawrence Ave	Cook	B	L-1
61	L0810	I-190	CN RR / Soo RR	Cook	C	L-1
62	L0815	I-190	Des Plaines River Rd	Cook	D	L-1
63	L0820	I-90	East River Rd	Cook	D1	L-1
64	L0825	I-90	Cumberland Ave	Cook	E	L-1
65	L0830	I-90	Oriole Ave	Cook	F	L-1
66	L0835	I-90	Sayer Ave	Cook	G	L-1
67	L0840	I-90	Moody Ave	Cook	H	L-1
68	L0845	I-90	Edmunds St	Cook	I	L-1
69	L0847	I-90	Lawrence Ave	Cook	J	L-1
70	L0850	I-90/94	Kedvale Ave	Cook	K	L-1
71	L0853	I-90/94	Kimball Ave	Cook	L	L-1
72	L0855	I-90/94	California Ave	Cook	M	L-1
73	L0857	I-90/94	Leavitt St	Cook	N	L-1
74	L0860	I-90/94	Cortland St	Cook	O	L-1
75	L0863	I-90/94	Blackhawk St	Cook	P	L-1
76	L0865	I-90/94	Augusta Blvd	Cook	R	L-1
77	L0867	I-90/94	Grand Ave	Cook	S	L-1
78	L0870	I-90/94	Ontario St / Ohio St	Cook	S1	L-1
79	L0873	I-90/94	Erie St	Cook	S2	L-1
80	L0875	I-90/94	Hubbard St	Cook	W	L-1
81	L0883	I-90/94	Hubbard St Cave	Cook	T	L-1
82	L0886	I-90/94	W Washington Blvd	Cook	U	L-1
83	L0888	I-90/94	E Washington Blvd	Cook	V	L-1
84	L0890	I-90/94	Van Buren St	Cook	Z	L-1
85	L0903	I-94	99th St	Cook	N	L-1
86	L0905	I-94	91st St	Cook	O	L-1
87	L0910	I-94	81st St	Cook	P	L-1
88	L0915	I-94	73rd St	Cook	R	L-1
89	L0917	I-90/94	67th St	Cook	R1	L-1
90	L0920	I-90/94	63rd St	Cook	S	L-1
91	L0925	I-90/94	57th St	Cook	T	L-1
92	L0927	I-90/94	55th St	Cook	T1	L-1
93	L0930	I-90/94	48th St	Cook	U	L-1
94	L0935	I-90/94	Root St	Cook	V	L-1
95	L0940	I-90/94	35th St	Cook	W	L-1
96	L0945	I-90/94	27th St	Cook	X	L-1
97	L0950	I-90/94	Normal Ave	Cook	Y	L-1
98	L0955	I-90/94	Wallace St	Cook	Z	L-1
99	L0960	I-90/94	21st Pl [Incl Nav]	Cook	A	L-1
100	L0965	I-90/94	17th St	Cook	B	L-1
101	L0970	I-90/94	Maxwell St	Cook	C	L-1
102	L0975	I-90/94	Polk St	Cook	D	L-1
103	L1003	IL 394	Sauk Trail Rd	Cook	A	L-1
104	L1004	IL 394	US 30 (Lincoln Highway)	Cook	N	L-1
105	L1005	IL 394	Glenwood Dyer Rd	Cook	B	L-1
106	L1008	IL 394	Thornton-Lansing Rd	Cook	D1	L-1
107	L1010	I-94	N of I-80	Cook	C	L-1
108	L1015	I-94	S of I-80	Cook	D	L-1

Ct.	Loc. #	Main Route	Nearest Cross Street	Co.	Cab. / M.P.	RM Pay Item
109	L1017	I-94	170th St	Cook	E1	L-1
110	L1020	I-94	165th St	Cook	E	L-1
111	L1025	I-94	159th St	Cook	F	L-1
112	L1030	I-94	Michigan City Rd	Cook	G	L-1
113	L1032	I-94	147th St	Cook	G1	L-1
114	L1035	I-94	Dolton Ave	Cook	H	L-1
115	L1040	I-94	137th St	Cook	X	L-1
116	L1046	I-94	E 130th St	Cook	V	L-1
117	L1047	I-94	W 130th St	Cook	W	L-1
118	L1050	I-94	119th St	Cook	J	L-1
119	L1055	I-94	111th St	Cook	K	L-1
120	L1060	I-94	115th St	Cook	Y	L-1
121	L1065	I-94	103rd St	Cook	L	L-1
122	L1070	I-94	100th St	Cook	M	L-1
123	L1075	I-94	Stoney Island Feeder & 105th St	Cook	P	L-1
124	L1080	I-94	Stoney Island Feeder & 103rd St	Cook	R	L-1
125	L1085	I-94	Stoney Island Feeder & 98th St	Cook	S	L-1
126	L1090	I-94	Stoney Island Feeder & 99th St	Cook	T	L-1
127	L1203	I-94	Knox Ave	Cook	A	L-1
128	L1205	I-94	Foster Ave	Cook	B	L-1
129	L1210	I-94	US 14 (Caldwell Ave/Peterson Ave)	Cook	C	L-1
130	L1215	I-94	Pratt Ave	Cook	D	L-1
131	L1220	I-94	Touhy Ave	Cook	E	L-1
132	L1225	I-94	Niles Center Rd	Cook	F	L-1
133	L1230	I-94	Oakton Rd	Cook	G	L-1
134	L1235	I-94	IL 58 (Dempster St)	Cook	H	L-1
135	L1240	I-94	Golf Rd	Cook	J	L-1
136	L1245	I-94	Glenview Rd	Cook	K	L-1
137	L1250	I-94	Lake Ave	Cook	L	L-1
138	L1255	I-94	Winnetka Rd	Cook	M	L-1
139	L1260	I-94	Willow Rd	Cook	N	L-1
140	L1265	I-94	Tower Rd	Cook	O	L-1
141	L1270	I-94	S of IL 68 (Dundee Rd)	Cook	P	L-1
142	L1275	I-94	IL 68 (Dundee Rd)	Cook	R	L-1
143	L1280	I-94	Lake Cook Rd	Cook	S	L-1
144	L1303	I-290	N Wells St	Cook	A	L-1
145	L1305	I-290	S Wells St	Cook	B	L-1
146	L1310	I-290	Franklin St	Cook	C	L-1
147	L1315	I-290	Wacker Dr	Cook	D	L-1
148	L1325	I-290	Canal St	Cook	F	L-1
149	L1330	I-290	Racine Ave	Cook	G	L-1
150	L1335	I-290	Leavitt St	Cook	H	L-1
151	L1340	I-290	Kedzie Ave	Cook	I	L-1
152	L1345	I-290	Pulaski Ave / Crawford Ave	Cook	J	L-1
153	L1350	I-290	IL 50 (Cicero Ave)	Cook	K	L-1
154	L1355	I-290	Central Ave	Cook	L	L-1
155	L1360	I-290	Oak Park Ave	Cook	M	L-1
156	L1362	I-290	IL 43 (Harlem Ave)	Cook	M1	L-1
157	L1365	I-290	Des Plaines Ave	Cook	N	L-1
158	L1370	I-290	IL 171 (1st Ave)	Cook	O	L-1
159	L1375	I-290	17th Ave	Cook	P	L-1
160	L1380	I-290	25th Ave	Cook	R	L-1
161	L1385	I-290	Westchester Blvd	Cook	S	L-1
162	L1386	I-290	US 12/20/45 (Mannheim Rd)	Cook	W	L-1
163	L1387	I-290	Wolf Rd Exit Ramp	Cook	X	L-1
164	L1388	I-290	Orchard Ave	Cook	Y	L-1
165	L1390	I-290	Laverne Ave (Wolf Rd)	Cook	T	L-1

Ct.	Loc. #	Main Route	Nearest Cross Street	Co.	Cab. / M.P.	RM Pay Item
166	L1391	I-290	W of I-88 Split	Cook	Z	L-1
167	L1393	I-290	Roosevelt Rd Exit Ramp	Cook	U	L-1
168	L1397	I-290	Arthur Ave	Cook	V	L-1
169	L1504	I-290 / IL 53	Biesterfield Rd	Cook	S	L-1
170	L1505	I-290 / IL 53	Schaumburg Rd	Cook	M	L-1
171	L1510	I-290 / IL 53	S of IL 72 (Higgins Rd)	Cook	N	L-1
172	L1515	I-290 / IL 53	IL 72 (Higgins Rd)	Cook	O	L-1
173	L1520	I-290 / IL 53	IL 58 (Golf Rd)	Cook	P	L-1
174	L1525	I-290 / IL 53	IL 62 (Algonquin Rd)	Cook	R	L-1
175	L1535	I-290 / IL 53	Euclid St	Cook	U	L-1
176	L1540	I-290 / IL 53	US 14 (Northwest Highway)	Cook	V	L-1
177	L1545	I-290 / IL 53	Palatine Rd	Cook	W	L-1
178	L1550	I-290 / IL 53	US 12 (Rand Rd)	Cook	X	L-1
179	L1580	I-290 / IL 53	IL 68 (Dundee Rd)	Cook	Y	L-1
180	L1590	I-290 / IL 53	Lake Cook Rd	Cook	Z	L-1
181	L2515	Elgin O'Hare	W of Plum Grove Rd	Cook	J	L-1
182	L2520	Elgin O'Hare	Roselle Rd	Cook	K	L-1
183	L2525	Elgin O'Hare	Mitchell Blvd	Cook	L	L-1
184	L2530	Elgin O'Hare	Rodenburg Rd	Cook	M	L-1
185	L2535	Elgin O'Hare	Springinsguth Rd	Cook	N	L-1
186	L0203	I-55	Madison St	DuPage	A	L-1
187	L0205	I-55	S IL 83 (Kingery Highway)	DuPage	B	L-1
188	L0210	I-55	N IL 83 (Kingery Highway)	DuPage	C	L-1
189	L0215	I-55	Cass Ave	DuPage	D	L-1
190	L0220	I-55	Kearney Rd	DuPage	E	L-1
191	L0225	I-55	Lemont Rd	DuPage	F	L-1
192	L0230	I-55	Woodward Ave	DuPage	G	L-1
193	L1405	I-290	St Charles Rd	DuPage	W	L-1
194	L1410	I-290	IL 64 (North Ave)	DuPage	X	L-1
195	L1415	I-290	York Rd	DuPage	Y	L-1
196	L1420	I-290	Grand Ave	DuPage	A	L-1
197	L1425	I-290	Villa Ave	DuPage	B	L-1
198	L1430	I-290	N IL 83 (Elmhurst Rd)	DuPage	C	L-1
199	L1435	I-290	S IL 83 (Elmhurst Rd)	DuPage	D	L-1
200	L1440	I-290	Addison Rd	DuPage	E	L-1
201	L1445	I-290	Mill Rd	DuPage	F	L-1
202	L1450	I-290	Itasca Rd	DuPage	G	L-1
203	L1455	I-290	I-290 / I-355 & Central Ave	DuPage	H	L-1
204	L1458	I-290 / I-355	US 20 (Lake St)	DuPage	I	L-1
205	L1460	I-290	IL 19 (Irving Park Rd)	DuPage	J	L-1
206	L1465	I-290	Thorndale Ave	DuPage	K	L-1
207	L1468	I-290	Devon Ave	DuPage	L	L-1
208	L1470	I-290 / I-355	Army Trail Rd	DuPage	T	L-1
209	L2605	Elgin O'Hare	IL 53 (Rohlwing Rd)	DuPage	H	L-1
210	L2610	Elgin O'Hare	Meacham Rd / Medinah Rd	DuPage	I	L-1
211	L2615	Elgin O'Hare	Wetland's (SW Metra RR Bridge)	DuPage	O	L-1
212	L2620	Elgin O'Hare	US 20 (Lake St)	DuPage	P	L-1
213	L1103	I - 94 (US 41)	Clavey Rd	Lake	T	L-1
214	L0305	I-55	Joliet Rd	Will	H	L-1
215	L0307	I-55	International Drive	Will	H1	L-1
216	L0310	I-55	IL 53	Will	I	L-1
217	L0313	I-55	W of IL 53	Will	I1	L-1
218	L0321	I-55	E of Naperville Rd	Will	K2	L-1
219	L0322	I-55	E of Weber Rd	Will	K1	L-1
220	L0323	I-55	Weber Rd	Will	K	L-1
221	L0325	I-55	IL 126	Will	L	L-1
222	L0330	I-55	US 30 (Lincoln Highway)	Will	M	L-1

Ct.	Loc. #	Main Route	Nearest Cross Street	Co.	Cab. / M.P.	RM Pay Item
223	L0335	I-55	US 52 (Jefferson St)	Will	N	L-1
224	L0340	I-55	IL 59 (Brookforest Ave)	Will	O	L-1
225	L0345	I-55	I-80	Will	P	L-1
226	L0350	I-55	US 6	Will	R	L-1
227	L0355	I-55	Bluff Rd	Will	S	L-1
228	L0360	I-55	Arsenal Rd	Will	T	L-1
229	L0365	I-55	Wilmington Rd	Will	U	L-1
230	L0370	I-55	Lorenzo Rd	Will	V	L-1
231	L0375	I-55	IL 129	Will	X	L-1
232	L0380	I-55	IL 113	Will	Y	L-1
233	L0385	I-55	Reed Rd	Will	Z	L-1
234	L0505	I-57	Manhattan Rd / Monee Rd	Will	M	L-1
235	L0560	I-57	Wilmington Rd / Peotone Rd	Will	Y	L-1
236	L0703	I-80	IL 43 (Harlem Ave)	Will	I	L-1
237	L0707	I-80	W of 80th Ave	Will	B	L-1
238	L0713	I-80	W of 88th Ave	Will	D	L-1
239	L0715	I-80	US 45 (96th Ave)	Will	F	L-1
240	L0717	I-80	E of 104th Ave	Will	G	L-1
241	L0724	I-80	I-355	Will	K	L-1
242	L0728	I-80	US 30 (Lincoln Highway)	Will	N	L-1
243	L0730	I-80	Briggs St	Will	P	L-1
244	L0735	I-80	N Richard St	Will	R	L-1
245	L0740	I-80	S Richard St	Will	S	L-1
246	L0750	I-80	IL 53 (Chicago St)	Will	U	L-1
247	L0755	I - 80	Water St	Will	V	L-1
248	L0760	I - 80	E Center St	Will	W	L-1
249	L0765	I - 80	W Center St	Will	X	L-1
250	L0770	I - 80	Larkin Ave	Will	Y	L-1
251	L0775	I - 80	Houbolt Rd	Will	Z	L-1

1	L1603	US 12 (Rand Rd)	US 12/45 (Lee St)	Cook	AD	L-2
2	L1605	US 12 (Rand Rd)	Euclid St	Cook	AR	L-2
3	L1607	US 12 (Rand Rd)	Lake Cook Rd	Cook	XI	L-2
4	L1610	US 14 (NW Hwy)	Baldwin Rd	Cook	AA	L-2
5	L1615	US 14 (Dempster St)	IL 21 (Milwaukee Ave)	Cook	AM	L-2
6	L1626	US 14 (Dempster St)	I-294 (Tollway)	Cook	XL	L-2
7	L1627	Busse Hwy	I-294 (Tollway)	Cook	XM	L-2
8	L1628	Oakton St	I-294 (Tollway)	Cook	XN	L-2
9	L1629	Touhy Ave	I-294 (Tollway)	Cook	XR	L-2
10	L1630	US 20 (Lake St)	IL 59 (Sutton Rd)	Cook	AC	L-2
11	L1632	IL 58 (Golf Rd)	I-294 (Tollway)	Cook	XO	L-2
12	L1633	IL 21 (Milwaukee Ave)	I-294 (Tollway)	Cook	XP	L-2
13	L1635	US 20 (Lake St)	Shales Pkwy / Bluff City Rd	Cook	AY	L-2
14	L1637	IL 43 (Waukegan Rd)	I-94 (Tollway)	Cook	RB	L-2
15	L1640	US 45 (Des Plaines River)	IL 21 (Milwaukee Ave)	Cook	AX	L-2
16	L1641	US 45 (Des Plaines River)	IL 58 (Golf Rd)	Cook	AO	L-2
17	L1645	US 45/IL 21 (Milwaukee)	Hintz Rd	Cook	AV	L-2
18	L1647	US 45/IL 21 (Milwaukee)	Lake Cook Rd	Cook	AK	L-2
19	L1650	IL 59 (Sutton Rd)	IL 58 (Golf Rd)	Cook	AH	L-2
20	L1653	IL 58 (Golf Rd)	Roselle Rd	Cook	RG	L-2
21	L1656	IL 58 (Golf Rd)	Highland Blvd	Cook	RH	L-2
22	L1657	IL 58 (Golf Rd)	IL 72 (Higgins Rd)	Cook	RE	L-2
23	L1658	IL 58 (Golf Rd)	Gannon Dr	Cook	RI	L-2
24	L1659	IL 58 (Golf Rd)	Southbridge Ln	Cook	RJ	L-2
25	L1660	IL 59 (Sutton Rd)	IL 68 (Dundee Rd)	Cook	AI	L-2
26	L1662	IL 59 (Sutton Rd)	IL 72 (Higgins Rd)	Cook	AW	L-2

Ct.	Loc. #	Main Route	Nearest Cross Street	Co.	Cab. / M.P.	RM Pay Item
27	L1663	IL 59 (Sutton Rd)	Shoe Factory Rd	Cook	AZ	L-2
28	L1664	IL 62 (Algonquin Rd)	Arlington Heights Rd	Cook	AF	L-2
29	L1668	IL 72 (Higgins Rd)	Berrington Rd	Cook	XK	L-2
30	L1673	IL 72 (Higgins Rd)	Spring Mill Dr	Cook	RD	L-2
31	L1674	IL 72 (Higgins Rd)	Churchill Rd	Cook	Rf	L-2
32	L1675	US 14 (NW Hwy)	IL 68 (Dundee Rd)	Cook	AG	L-2
33	L1677	IL 72 (Higgins Rd)	Roselle Rd	Cook	RC	L-2
34	L1678	IL 72 (Higgins Rd)	Morningside Dr	Cook	XF	L-2
35	L1680	IL 72 (Higgins Rd)	Touhy Ave	Cook	AL	L-2
36	L1683	IL 83 (Elmhurst Rd)	Palatine Rd	Cook	AS	L-2
37	L1685	Busse Highway	Oakton St	Cook	AB	L-2
38	L1687	Palatine Rd	Wheeling Rd	Cook	AT	L-2
39	L1691	Willow Rd	I-294 (Tollway)	Cook	XD	L-2
40	L1695	IL 72 (Higgins Rd)	I-90 (Tollway)	Cook	AN	L-2
41	L1698	Wolf Rd	I-90 (Tollway)	Cook	AQ	L-2
42	L1703	US12/20/45 (LaGrange)	IL 171 NE Ramp	Cook	BA	L-2
43	L1705	US12/20/45 (LaGrange)	IL 171 SW Ramp	Cook	BL	L-2
44	L1706	US12/20/45 (LaGrange)	Chicago Sanitary & Ship Canal	Cook	BK	L-2
45	L1707	IL 38 (Roosevelt Rd)	Boeger St	Cook	YA	L-2
46	L1708	IL 38 (Roosevelt Rd)	US 12/20/45 (Mannheim Rd)	Cook	YB	L-2
47	L1709	US12/20/45 (Mannheim)	22nd St (Cermak Rd)	Cook	BF	L-2
48	L1710	US12/45 (Mannheim)	IL 19 (Irving Park Rd)	Cook	BD	L-2
49	L1713	US 34 (Ogden Ave)	26th St	Cook	BZ	L-2
50	L1714	US 34 (Ogden Ave)	IL 50 (Cicero Ave)	Cook	BY	L-2
51	L1715	US 34 (Ogden Ave)	39th St (Pershing Rd)	Cook	BV	L-2
52	L1716	US 34 (Ogden Ave)	Wolf Rd	Cook	BW	L-2
53	L1717	IL 38 (Roosevelt Rd)	I-294 (Tollway)	Cook	BB	L-2
54	L1730	IL 43 (Harlem Ave)	66th St	Cook	BX	L-2
55	L1731	IL 43 (Harlem Ave)	79th St	Cook	BH	L-2
56	L1732	IL 64 (North Ave)	IL 171 (1st Ave)	Cook	BG	L-2
57	L1735	22nd St (Cermak Rd)	IL 171 (1st Ave)	Cook	BC	L-2
58	L1740	Lower Wacker Dr	Randolph St	Cook	BI	L-2
59	L1745	Lower Wacker Dr	Madison St	Cook	BJ	L-2
60	L1753	Lower Wacker Dr	Adams St	Cook	BN	L-2
61	L1755	Lower Wacker Dr	Van Buren St	Cook	BM	L-2
62	L1760	Damen Ave	Webster Ave	Cook	YV	L-2
63	L1762	Western Ave	Logan Blvd	Cook	YX	L-2
64	L1763	Sacramento Ave	Wellington Ave	Cook	YY	L-2
65	L1764	Kostner Ave	Berteau Ave	Cook	YZ	L-2
66	L1794	IL 43 (Harlem Ave)	Lawrence Ave	Cook	YT	L-2
67	L1802	US 12/20/45 (96th Ave)	87th St	Cook	CV	L-2
68	L1803	US 12/20/45 (96th Ave)	US 12/20 (95th St)	Cook	CW	L-2
69	L1804	US 45 (LaGrange Rd)	107th St	Cook	CX	L-2
70	L1805	US 45 (LaGrange Rd)	111th St	Cook	CY	L-2
71	L1810	US 12/20 (95th St)	IL 43 (Harlem Ave)	Cook	CB	L-2
72	L1823	US 30 (Lincoln Hwy)	Torrence Ave	Cook	CS	L-2
73	L1825	US 45 (LaGrange Rd)	IL 83 (Cal Sag Rd)	Cook	CE	L-2
74	L1827	IL 50 (Cicero Ave)	127th St	Cook	CH	L-2
75	L1830	IL 1 (Halsted Ave)	I-80 / I-294 (Tollway)	Cook	CK	L-2
76	L1835	IL 1 (Halsted Ave)	Ridge Rd	Cook	CA	L-2
77	L1837	IL 43 (Harlem Ave)	143rd St	Cook	CN	L-2
78	L1845	IL 83 (Kingery Hwy)	N IL 171 (Archer Ave)	Cook	CC	L-2
79	L1850	IL 83 (Kingery Hwy)	S IL 171 (Archer Ave)	Cook	CD	L-2
80	L1860	111th St	Austin Ave	Cook	CF	L-2
81	L1870	111th St	Laramie Ave	Cook	CG	L-2
82	L1885	US 6 (159th St)	Leavitt St	Cook	CT	L-2
83	L1886	US 6 (159th St)	CN RR Bridge	Cook	CJ	L-2

Ct.	Loc. #	Main Route	Nearest Cross Street	Co.	Cab. / M.P.	RM Pay Item
84	L1887	US 6 (159th St)	Park Ave	Cook	CL	L-2
85	L1888	US 6 (159th St)	Center Ave	Cook	CM	L-2
86	L1902	US 20 (Lake St)	Bloomington Rd	DuPage	PT	L-2
87	L1903	US 20 (Lake St)	Walnut St	DuPage	DW	L-2
88	L1905	US 34 (Ogden Ave)	IL 59	DuPage	DB	L-2
89	L1910	US 34 (Ogden Ave)	IL 83 (Kingery Highway)	DuPage	DA	L-2
90	L1912	IL 38 (Roosevelt Rd)	York Rd	DuPage	DH	L-2
91	L1913	IL 38 (Roosevelt Rd)	IL 83 NB Ramp	DuPage	DU	L-2
92	L1914	IL 83 (Kingery Hwy)	IL 56 EB Ramp	DuPage	DV	L-2
93	L1922	IL 53	I-88 (Tollway)	DuPage	DS	L-2
94	L1925	IL 53	IL 56 (Butterfield Rd)	DuPage	DM	L-2
95	L1935	IL 56 (Butterfield Rd)	IL 59	DuPage	DD	L-2
96	L1940	IL 56 (Butterfield Rd)	Highland Ave	DuPage	DJ	L-2
97	L1950	IL 59	Aurora Rd	DuPage	DC	L-2
98	L1959	IL 64 (North Ave)	IL 83 (Kingery Highway)	DuPage	DN	L-2
99	L1960	IL 64 (North Ave)	Main St (in Lombard)	DuPage	DE	L-2
100	L1961	IL 64 (North Ave)	IL 53 (Columbine Ave)	DuPage	DF	L-2
101	L1962	IL 64 (North Ave)	Kramer Ave	DuPage	PY	L-2
102	L1963	IL 64 (North Ave)	Ardmore ave	DuPage	PZ	L-2
103	L1964	IL 64 (North Ave)	Swift Rd	DuPage	PH	L-2
104	L1965	IL 64 (North Ave)	Main St (Glen Ellyn Rd)	DuPage	PI	L-2
105	L1966	IL 64 (North Ave)	Evergreen Ave	DuPage	PJ	L-2
106	L1967	IL 64 (North Ave)	Linda Ave	DuPage	PK	L-2
107	L1968	IL 64 (North Ave)	Schmale Rd	DuPage	PL	L-2
108	L1969	IL 64 (North Ave)	Gary Ave	DuPage	PM	L-2
109	L1970	IL 64 (North Ave)	Kuhn Rd	DuPage	PN	L-2
110	L1971	IL 64 (North Ave)	Morton Rd	DuPage	PO	L-2
111	L1972	IL 64 (North Ave)	St. Charles Rd	DuPage	PP	L-2
112	L1973	IL 64 (North Ave)	Prince Crossing Rd	DuPage	PR	L-2
113	L1974	IL 64 (North Ave)	Woodcrest Dr	DuPage	PS	L-2
114	L1975	IL 83 (Kingery Hwy)	55th St	DuPage	DL	L-2
115	L1980	IL 83 (Kingery Hwy)	Bluff Rd	DuPage	DI	L-2
116	L1983	IL 83 (Kingery Hwy)	22nd St (Cermak Rd)	DuPage	DO	L-2
117	L1990	IL 64 (North Ave)	Woodland Ave	DuPage	PC	L-2
118	L1991	IL 64 (North Ave)	Powis Rd	DuPage	PD	L-2
119	L1992	IL 64 (North Ave)	Kautz Rd / Smith Rd	DuPage	PE	L-2
120	L2003	US 20 (Lake St)	IL 47/ IL 72	Kane	KS	L-2
121	L2010	US 20 (Lake St)	Randall Rd	Kane	KX	L-2
122	L2012	US 30 (Briarcliff Rd)	IL 31 (W Lake St)	Kane	KF	L-2
123	L2015	IL 47	US 30 & IL 56	Kane	KG	L-2
124	L2045	IL 38 (Roosevelt Rd)	IL 47	Kane	KO	L-2
125	L2050	IL 47	Big Timber Rd	Kane	KE	L-2
126	L2065	IL 56 (Butterfield Rd)	Kirk Rd	Kane	KR	L-2
127	L2070	IL 72 (Higgins Rd)	Randall Rd	Kane	KT	L-2
128	L2075	IL 56 (Butterfield Rd)	Galena Rd	Kane	KZ	L-2
129	L2103	US 30 (Briarcliff Rd)	US 34 (Owesgo Rd)	Kendall	EA	L-2
130	L2203	US 12 / IL 59	IL 134 (Long Lake Rd)	Lake	LX	L-2
131	L2205	IL 22 (Half Day Rd)	I-94 (Tollway)	Lake	LS	L-2
132	L2207	Deerfield Rd	Northland Ave	Lake	LA	L-2
133	L2211	US 41 (Skokie Highway)	Deerfield Rd	Lake	LE	L-2
134	L2215	US 41 (Skokie Highway)	IL 60 (Town Line Rd)	Lake	LR	L-2
135	L2217	US 41 (Skokie Highway)	IL 120 (Belvidere Rd)	Lake	LB	L-2
136	L2220	US 41 (Skokie Highway)	IL 132 (Grand Ave)	Lake	LG	L-2
137	L2221	US 41 (Skokie Highway)	IL 173 (Rosecrans Rd)	Lake	LU	L-2
138	L2224	US 41 (Skokie Highway)	Kelly Rd	Lake	LV	L-2
139	L2227	US 41 (I-94)	Russell Rd	Lake	LL	L-2
140	L2230	US 41 (Skokie Highway)	Washington St	Lake	LD	L-2

Ct.	Loc. #	Main Route	Nearest Cross Street	Co.	Cab. / M.P.	RM Pay Item
141	L2235	IL 120 (Belvidere Rd)	Cohasset Ct	Lake	VA	L-2
142	L2236	IL 120 (Belvidere Rd)	Greenleaf St	Lake	VB	L-2
143	L2237	IL 120 (Belvidere Rd)	IL 43 (Waukegan Rd)	Lake	VC	L-2
144	L2239	IL 120 (Belvidere Rd)	Lakehurst Rd	Lake	VD	L-2
145	L2243	US 41 (Skokie Highway)	West Park Ave	Lake	LP	L-2
146	L2245	IL 21 (Milwaukee Ave)	IL 120 (Belevidere Rd)	Lake	LF	L-2
147	L2247	IL 21 (Milwaukee Ave)	I-94 (Tollway)	Lake	LC	L-2
148	L2250	IL 21 (Milwaukee Ave)	IL 137 (Buckley Rd)	Lake	LM	L-2
149	L2255	IL 43 (Waukegan Rd)	IL 137 (Buckley Rd)	Lake	LN	L-2
150	L2256	IL 59	Grass Lake Rd	Lake	LK	L-2
151	L2265	IL 120 (Belevidere Rd)	O'Plaine Rd	Lake	LO	L-2
152	L2267	IL 60 (Town Line Rd)	Riverwoods Rd	Lake	VE	L-2
153	L2268	IL 60 (Town Line Rd)	Saunders Rd	Lake	VF	L-2
154	L2270	IL 131 (Green Bay Rd)	IL 137 (Buckley Rd)	Lake	LY	L-2
155	L2274	IL 137 (Buckley Rd)	I-94 (Tollway)	Lake	LJ	L-2
156	L2275	IL 137 (Sheridan Rd)	Wadsworth Rd	Lake	LW	L-2
157	L2276	IL 137 (Sheridan Rd)	MLK Jr Dr	Lake	LQ	L-2
158	L2280	Amstutz Highway	Grand Ave	Lake	B	L-2
159	L2285	Amstutz Highway	Greenwood Ave	Lake	A	L-2
160	L2290	IL 22 (Lake Zurich Rd)	Ela Rd	Lake	LZ	L-2
161	L2305	US 14 (Northwest Hwy)	IL 31	McHenry	MA	L-2
162	L2310	US 14 (Northwest Hwy)	IL 47	McHenry	MC	L-2
163	L2315	US 14 (Northwest Hwy)	IL 176 (Terra Cotta Ave)	McHenry	MZ	L-2
164	L2330	IL 47	S IL 176 (Terra Cotta Ave)	McHenry	MS	L-2
165	L2335	IL 47	N IL 176 (Terra Cotta Ave)	McHenry	MN	L-2
166	L2402	US 6 (Southwest Hwy)	I-355	Will	WZ	L-2
167	L2404	US 30 (Plainfield Rd)	Larkin Ave	Will	WA	L-2
168	L2415	US 30 (Cass St)	Stevens St	Will	WD	L-2
169	L2418	US 30 (Lincoln Hwy)	Cedar Rd	Will	WE	L-2
170	L2420	US 45	US 52	Will	WW	L-2
171	L2428	IL 7 (159th St)	I-355	Will	WY	L-2
172	L2430	IL 7 (Renwick Rd)	IL 53 (Broadway St)	Will	WB	L-2
173	L2435	IL 50 (Cicero Ave)	Governors Highway	Will	WG	L-2
174	L2437	IL 50 (Cicero Ave)	Court St	Will	WI	L-2
175	L2445	IL 53 (Independence Ave)	Joliet Rd	Will	WP	L-2
176	L2448	IL 171 (Archer Ave)	I-355	Will	WQ	L-2
177	L2452	IL 113 (Main St)	IL 53(Front) & IL 129(Washington)	Will	HB	L-2
178	L2455	IL 394	Bemes Rd	Will	WK	L-2
179	L2460	IL 394	Faithorn Rd / Burville Rd	Will	WL	L-2
180	L2465	IL 394	Cottage Grove Ave	Will	WM	L-2
181	L2470	IL 394	Elms Court Rd	Will	WT	L-2
182	L2475	IL 394	Exchange St	Will	WO	L-2
183	L2478	IL 394	IL 1	Will	WV	L-2
184	L2480	IL 394	Goodnow Rd	Will	WU	L-2
185	L2485	IL 394	Richton Rd	Will	WR	L-2
186	L2490	IL 394	Steger Rd	Will	WS	L-2
1	L1617	US 14 (Dempster St)	IL 43 (Waukegan Rd)	Cook	XH	L-3
2	L1625	US 14 (NW Hwy)	CN RR / Soo RR	Cook	AE	L-3
3	L1631	Ballard Rd	I-294 (Tollway)	Cook	XS	L-3
4	L1643	US 45/IL 21 (Milwaukee)	IL 68 (Dundee Rd)	Cook	XG	L-3
5	L1655	IL 58 (Golf Rd)	Wolf Rd / CN RR	Cook	AJ	L-3
6	L1666	IL 50 (Cicero Ave)	Touhy Ave	Cook	XJ	L-3
7	L1670	IL 62 (Algonquin Rd)	Palatine Rd	Cook	AP	L-3
8	L1690	Palatine Rd	Schoenbeck Rd	Cook	AU	L-3
9	L1711	US12/45 (Mannheim Rd)	US 20 (Lake St)	Cook	YC	L-3

Ct.	Loc. #	Main Route	Nearest Cross Street	Co.	Cab. / M.P.	RM Pay Item
10	L1712	US12/45 (Mannheim Rd)	Proviso RR Bridge	Cook	YD	L-3
11	L1718	IL 43 (Harlem Ave)	Division St	Cook	YF	L-3
12	L1719	IL 43 (Harlem Ave)	Augusta Blvd	Cook	YG	L-3
13	L1720	IL 43 (Harlem Ave)	Chicago Ave	Cook	YH	L-3
14	L1721	IL 43 (Harlem Ave)	Ontario St	Cook	YI	L-3
15	L1722	IL 43 (Harlem Ave)	US 20 (Lake St)	Cook	YJ	L-3
16	L1723	IL 43 (Harlem Ave)	South Blvd	Cook	YK	L-3
17	L1725	IL 43 (Harlem Ave)	Randolph St	Cook	YM	L-3
18	L1726	IL 43 (Harlem Ave)	Washington St	Cook	YN	L-3
19	L1727	IL 43 (Harlem Ave)	Madison St	Cook	YO	L-3
20	L1728	IL 43 (Harlem Ave)	IL 38 (Roosevelt Rd)	Cook	YP	L-3
21	L1729	IL 43 (Harlem Ave)	16th St	Cook	YR	L-3
22	L1765	Lake Shore Dr	Sign Only @ I-55 Ramp	Cook	C1E	L-3
23	L1766	Lake Shore Dr	39th St (Cant Sign only)	Cook	BQ	L-3
24	L1767	Lake Shore Dr	35th St (Cant Sign only)	Cook	YE	L-3
25	L1768	Lake Shore Dr	27th St (Cant Sign only)	Cook	YQ	L-3
26	L1775	IL 38 (Roosevelt Rd)	Austin Blvd	Cook	BP	L-3
27	L1780	IL 38 (Roosevelt Rd)	East Ave	Cook	BE	L-3
28	L1785	IL 38 (Roosevelt Rd)	Oak Park Ave	Cook	BO	L-3
29	L1790	IL 38 (Roosevelt Rd)	Ridgeland Ave	Cook	BR	L-3
30	L1792	IL 38 (Roosevelt Rd)	Foster Ave	Cook	YS	L-3
31	L1796	IL 43 (Harlem Ave)	Cullom Ave	Cook	YU	L-3
32	L1815	US 30 (Lincoln Highway)	IL 43 (Harlem Ave)	Cook	CR	L-3
33	L1820	US 30 (Lincoln Highway)	Governors Highway / Crawford Ave	Cook	CR	L-3
34	L3110	Little Calumet River	I-94 (Bishop Ford)	Cook	324.6	L-3
35	L3115	Little Calumet River	IL 1 (Halsted St)	Cook	320.1	L-3
36	L3210	Cal-Sag Channel	Ashland Ave	Cook	319.0	L-3
37	L3215	Cal-Sag Channel	I-57	Cook	318.9	L-3
38	L3217	Cal-Sag Channel	Western Ave	Cook	318.0	L-3
39	L3220	Cal-Sag Channel	Kedzie Ave	Cook	316.9	L-3
40	L3230	Cal-Sag Channel	IL 50 (Cicero Ave)	Cook	314.9	L-3
41	L3235	Cal-Sag Channel	127th St	Cook	314.2	L-3
42	L3240	Cal-Sag Channel	IL 43 (Harlem Ave)	Cook	311.5	L-3
43	L3245	Cal-Sag Channel	IL 7 (Southwest Highway)	Cook	310.7	L-3
44	L3250	Cal-Sag Channel	US 45 (96th Ave)	Cook	308.4	L-3
45	L3255	Cal-Sag Channel	IL 83 (Kingery Highway)	Cook	304.1	L-3
46	L3405	Chicago San & Ship Canal	Central Ave	Cook	316.2	L-3
47	L3410	Chicago San & Ship Canal	NB IL 43 (Harlem Ave)	Cook	314.0	L-3
48	L3415	Chicago San & Ship Canal	SB IL 43 (Harlem Ave)	Cook	313.9	L-3
49	L3435	Chicago San & Ship Canal	US 12/20/45 (LaGrange Rd)	Cook	309.4	L-3
50	L3440	Chicago San & Ship Canal	Willow Springs Rd	Cook	307.9	L-3
51	L3445	Chicago San & Ship Canal	IL 83 (Kingery Highway)	Cook	304.1	L-3
52	L3450	Chicago San & Ship Canal	Lemont Rd (State St)	Cook	300.5	L-3
53	L3455	Chicago San & Ship Canal	IL 7 (9th St)	Cook	292.7	L-3
54	L1906	US 20 (Lake St)	Marcus Cinema	DuPage	UA	L-3
55	L1907	US 20 (Lake St)	Lombard Rd	DuPage	UB	L-3
56	L1908	US 20 (Lake St)	Itasca Rd	DuPage	UC	L-3
57	L1909	US 20 (Lake St)	Mill Rd	DuPage	UD	L-3
58	L1911	US 20 (Lake St)	JFK Dr	DuPage	UE	L-3
59	L1915	IL 38 (Roosevelt Rd)	Lorraine St	DuPage	DG	L-3
60	L1916	IL 38 (Roosevelt Rd)	President St	DuPage	DQ	L-3
61	L1917	IL 38 (Roosevelt Rd)	Naperville Rd	DuPage	DX	L-3
62	L1918	IL 38 (Roosevelt Rd)	Main St {Wheaton}	DuPage	DY	L-3
63	L1919	IL 38 (Roosevelt Rd)	West St	DuPage	DZ	L-3
64	L1920	IL 38 (Roosevelt Rd)	Gary's Mill Rd	DuPage	PF	L-3
65	L1921	IL 38 (Roosevelt Rd)	County Farm Rd	DuPage	PQ	L-3
66	L1930	IL 53	BNSF RR Bridge	DuPage	DR	L-3

Ct.	Loc. #	Main Route	Nearest Cross Street	Co.	Cab. / M.P.	RM Pay Item
67	L1951	IL 59	Gary's Mill Rd	DuPage	PG	L-3
68	L1955	IL 64 (North Ave)	Berteau Ave	DuPage	PU	L-3
69	L1956	IL 64 (North Ave)	Emroy Ave	DuPage	PV	L-3
70	L1957	IL 64 (North Ave)	York Rd	DuPage	PW	L-3
71	L1958	IL 64 (North Ave)	Myrtle Ave	DuPage	PX	L-3
72	L1985	IL 83 (Kingery Hwy)	St. Charles Rd	DuPage	DT	L-3
73	L1998	IL 64 (North Ave)	Sign Only @ Harvard Ave	DuPage	D5E	L-3
74	L1999	I-290	Sign Only @ CN RR	DuPage	D3E	L-3
75	L2020	IL 31 (State St)	W Big Timber Rd	Kane	KH	L-3
76	L2025	IL 31 (State St)	E Big Timber Rd	Kane	KJ	L-3
77	L2030	IL 31(2nd St / State St)	Indian Mounds Rd	Kane	KM	L-3
78	L2035	IL 31 (State St)	Judson Collage Entrance	Kane	KL	L-3
79	L2040	IL 31 (State St)	River Rd	Kane	KK	L-3
80	L2047	IL 38 (Roosevelt Rd)	14th St	Kane	KN	L-3
81	L2055	IL 47	Plank Rd	Kane	KP	L-3
82	L2060	IL 47	Galena Rd	Kane	KV	L-3
83	L2067	IL 64 (North Ave)	Burlington Rd	Kane	KW	L-3
84	L2105	US 30	IL 47	Kendall	EB	L-3
85	L2110	US 30	Orchard Rd	Kendall	EC	L-3
86	L2210	IL 43 (Waukegan Rd)	Osterman Ave	Lake	LI	L-3
87	L2228	US 41 (I-94)	Sign Only @ Russell Rd	Lake	L2E	L-3
88	L2260	IL 120 (Belevidere Rd)	Mill Rd (Wildwood Rd)	Lake	LH	L-3
89	L2298	US 41 (Skokie Highway)	Sign Only @ Deerfield Rd	Lake	L1E	L-3
90	L2340	IL 173	Beck Rd	McHenry	MB	L-3
91	L2405	US 30 (Lincoln Rd)	IL 126 (Lockport Rd)	Will	WN	L-3
92	L2410	US 30 (Cass St)	Pilcher Park Entrance	Will	WC	L-3
93	L2422	US 45 (96 th Ave)	191 st St	Will	WX	L-3
94	L2425	IL 1 (Halsted St)	Union	Will	WF	L-3
95	L2440	IL 53 (Broadway St)	EJE RR	Will	WH	L-3
96	L2450	IL 171 (Archer Ave)	EJE RR	Will	WJ	L-3
97	L2495	I-55	Sign Only @ Arsenal Rd	Will	W5E	L-3
98	L2496	I-55	Sign Only @ IL 129	Will	W7E	L-3
99	L2498	I-80	Sign Only @ Richard St	Will	W3E	L-3
100	L3535	Des Plaines River	I-80 (Access by Boat)	Will	287.0	L-3
101	L3545	Des Plaines River	I-55	Will	277.9	L-3

Count	Loc. #	Main Route	Nearest Cross Street	County	Street Address, City	RM Pay Item
1	PS02	I-94	Winnetka Rd	Cook	18 N West Frontage Rd, Northfield	P-1
2	PS03	I-94	Caldwell Ave / Peterson Ave	Cook	5700 N. Cicero Ave, Chicago	P-1
3	PS04	I-290	E of 1st Ave	Cook	8107 W I-290, Forest Park	P-1
4	PS05	I-290	Des Plaines Ave	Cook	701 W. Van Buren, Chicago	P-1
5	PS09	US 45 (Mannheim Rd)	US 20 (Lake St)	Cook	1549 Mannheim Rd, Stone Park	P-1
6	PS10	US 14 (Dempster St)	IL 21 (Milwaukee Ave)	Cook	8104 W. Dempster St, Niles	P-1
7	PS21	I-94	72nd St	Cook	3 E. 72nd St, Chicago	P-1
8	PS22	I-90/94	Fulton Ave	Cook	240 N. Union Ave, Chicago	P-1
9	PS23	I-90/94	Roscoe St	Cook	3415 N. Central Park Ave, Chicago	P-1
10	PS24	I-190	E of US 12/45 (Mannheim Rd)	Cook	9998 W. Bryn Mawr Ave, Rosemont	P-1
11	PS25	US 12/20 (95th St)	IL 43 (Harlem Ave)	Cook	7201 W. 95th St, Bridgeview	P-1
12	PS26	I-90/94	Roosevelt Rd	Cook	1125 S. Union Ave, Chicago	P-1
13	PS27	I-94	110th St	Cook	10925 S. Doty Rd, Chicago	P-1
14	PS28	IL 50 (Cicero Ave)	US 34 (Ogden Ave)	Cook	2618 S. Cicero Ave, Cicero	P-1
15	PS29	I-90/94	Wallace St	Cook	2422 S. Archer Ave, Chicago	P-1
16	PS30	I-55	Homan Ave	Cook	3510 S. Kedzie Ave, Chicago	P-1
17	PS31	111th St	Central Ave	Cook	5300 W. 111th St, Oak Lawn	P-1
18	PS33	Palatine Rd	IL 21 (Milwaukee Ave)	Cook	699 Milwaukee Ave, Prospect Heights	P-1
19	PS35	I-57	127th St	Cook	12950 S. Paulina St, Blue Island	P-1
20	PS36	IL 43 (Harlem Ave)	176th St	Cook	17701 S. Harlem Ave, Tinley Park	P-1
21	PS34	I-290	Emroy Ave	DuPage	395 N. Emroy Ave, Elmhurst	P-1
22	PS44	IL 83 (Kingery Highway)	S of IL 64 (North Ave)	DuPage	100 S. IL 83, Villa Park	P-1
23	PS42	IL 47	IL 72	Kane	15N300 IL 47, Hampshire	P-1
24	PS39	IL 60 (Kennedy Rd)	W of US 41 (Skokie Highway)	Lake	1391 Kennedy Rd, Lake Forest	P-1
25	PS40	US 45 (Lake Ave)	N of IL 60 (Towne Line Rd)	Lake	1499 S. Lake Ave, Mundelein	P-1
26	PS46	US 41 (Skokie Highway)	Clavey Rd	Lake	1448 Clavey Rd, Highland Park	P-1
27	PS52	IL 59	IL 126	Will	14706 S. IL 59, Plainfield	P-1
1	PS07	I-290	Wells St	Cook	530 S. Franklin St, Chicago	P-2
2	PS08	US 14 (Northwest Highway)	1/2 Mi E of US 12/45	Cook	865 Northwest Highway, Des Plaines	P-2
3	PS11	IL 50 (Cicero Ave)	158th St	Cook	15801 S. Cicero Ave, Oak Forest	P-2
4	PS12	IL 64 (North Ave)	W of 25th Ave	Cook	2600W. North Ave, Melrose Park	P-2
5	PS13	US 41 (Skokie Blvd)	S of Oakton St	Cook	7846 N. Skokie Blvd, Skokie	P-2
6	PS14	Ashland Ave	139th St	Cook	13901 S. Ashland Ave, Dixmoor	P-2
7	PS15	79th St	Kedzie Ave	Cook	3200W. 79th St, Chicago	P-2
8	PS16	IL 72 (Higgins Rd)	E of US 12/45 (Mannheim Rd)	Cook	10225 W Higgins Rd, Rosemont	P-2
9	PS17	IL 58 (Golf Rd)	E of US 45 (Des Plaines River Rd)	Cook	1855 W Golf Rd, Des Plaines	P-2
10	PS18	US 6 (159th St)	Park Ave	Cook	200E. 162nd St, South Holland	P-2
11	PS19	US 6 (159th St)	IL 50 (Cicero Ave)	Cook	4900 W. 159th St, Oak Forest	P-2
12	PS20	I-290	W of Wolf Rd	Cook	5005 W. I-290, Hillside	P-2
13	PS32	IL 64 (North Ave)	1st Ave	Cook	8501 W. North Ave, Melrose Park	P-2
14	PS51	127th St	E. of Crawford Ave	Cook	3559 W. 127th St, Alsip	P-2
15	PS47	IL 59	North Aurora Rd	DuPage	315 N. IL 59, Naperville	P-2
16	PS48	IL 56 (Butterfield Rd)	W of IL 59	DuPage	30W400 Butterfield Rd, Warrenville	P-2
17	PS37	US 41 (Skokie Highway)	IL 176 (Rockland Rd)	Lake	437 Skokie Highway, Lake Bluff	P-2

Count	Loc. #	Main Route	Nearest Cross Street	County	Street Address, City	RM Pay Item
18	PS38	US 41 (Skokie Highway)	Deerpath Ave	Lake	301 N. Skokie Highway, Lake Forest	P-2
19	PS41	US 41 (Skokie Highway)	N of IL 176 (Rockland Rd)	Lake	29315 N. Skokie Highway, Knollwood	P-2
20	PS43	US 41 (Skokie Highway)	N of IL 132 (Grand Ave)	Lake	1331 N. Skokie Highway, Gurnee	P-2
21	PS50	IL 22 (Half Day Rd)	US 41 (Skokie Highway)	Lake	1232 Half Day Rd, Highland Park	P-2

Ct	Loc #	Main Route	Nearest Cross Street	Co	Cab	Sign Label	Dir	Type of Equipment	RM Pay Item
1	S2005	I-57	IL 1 (Halsted St)	Cook	A2			Cabinet	S-1
2	S3075	I-90 OB NB Exit	IL 171 (Cumberland Ave)	Cook	E113			Cabinet	S-1
3	S3080	I-90 OB SB Entrance	IL 171 (Cumberland Ave)	Cook	E115			Cabinet	S-1
4	S3085	I-90 IB Entrance	IL 171 (Cumberland Ave)	Cook	E120			Cabinet	S-1
5	S3095	I-90 IB Entrance	Canfield Ave	Cook	F118			Cabinet	S-1
6	S3105	I-90	IL 43 (Harlem Ave)	Cook	F109			Cabinet	S-1
7	S3110	I-90	IL 43 (Harlem Ave)	Cook	F114			Cabinet	S-1
8	S3125	I-90	IL 43 (Harlem Ave)	Cook	G112			Cabinet	S-1
9	S3135	I-90	Sayre Ave	Cook	G110			Cabinet	S-1
10	S3140	I-90	Nagle Ave	Cook	H101			Cabinet	S-1
11	S3155	I-90	Bryn Mawr Ave	Cook	H106			Cabinet	S-1
12	S3165	I-90	Foster Ave	Cook	H97			Cabinet	S-1
13	S3175	I-90	Foster Ave	Cook	I102			Cabinet	S-1
14	S3185	I-90	Central Ave	Cook	I100			Cabinet	S-1
15	S3210	I-90	Lawrence Ave	Cook	J91			Cabinet	S-1
16	S3215	I-90	Lawrence Ave	Cook	J94A			Cabinet	S-1
17	S3240	I-90/94	Montrose Ave	Cook	J92			Cabinet	S-1
18	S3245	I-90/94	Keeler Ave	Cook	K77			Cabinet	S-1
19	S3270	I-90/94	Pulaski Rd	Cook	K84			Cabinet	S-1
20	S3275	I-90/94	IL 19 (Irving Park Rd)	Cook	K86			Cabinet	S-1
21	S3310	I-90/94	Avondale Ave	Cook	L76			Cabinet	S-1
22	S3320	I-90/94	Kimball Ave	Cook	L65			Cabinet	S-1
23	S3325	I-90/94	Kimball Ave	Cook	L72			Cabinet	S-1
24	S3340	I-90/94	Kedzie Ave	Cook	L70			Cabinet	S-1
25	S3350	I-90/94	California Ave	Cook	M57			Cabinet	S-1
26	S3365	I-90/94	Sacramento Blvd	Cook	M66			Cabinet	S-1
27	S3385	I-90/94	Diversey Ave	Cook	M62			Cabinet	S-1
28	S3390	I-90/94	Fullerton Ave	Cook	N51			Cabinet	S-1
29	S3405	I-90/94	Fullerton Ave	Cook	N58			Cabinet	S-1
30	S3415	I-90/94	Webster Ave	Cook	N56			Cabinet	S-1
31	S3420	I-90/94	Armitage Ave	Cook	O54			Cabinet	S-1
32	S3445	I-90/94	IL 64 (North Ave)	Cook	P41A			Cabinet	S-1
33	S3450	I-90/94	IL 64 (North Ave)	Cook	P48			Cabinet	S-1
34	S3460	I-90/94	Division St	Cook	R39			Cabinet	S-1
35	S3465	I-90/94	Division St	Cook	R44			Cabinet	S-1
36	S3480	I-90/94	Augusta Blvd	Cook	R42			Cabinet	S-1
37	S3485	I-90/94	Ogden Ave	Cook	R35			Cabinet	S-1
38	S3525	I-90/94	Lake St	Cook	Y28			Cabinet	S-1
39	S3550	I-90/94	Randolph St	Cook	Y29			Cabinet	S-1
40	S3570	I-90/94	Washington Blvd	Cook	Y25			Cabinet	S-1
41	S3600	I-90/94	Monroe St	Cook	Y17			Cabinet	S-1
42	S3635	I-90/94	Adams St	Cook	Z13			Cabinet	S-1
43	S4020	I-94	Elston Ave	Cook	B4			Cabinet	S-1
44	S4025	I-94	Foster Ave	Cook	B5			Cabinet	S-1

Ct	Loc #	Main Route	Nearest Cross Street	Co	Cab	Sign Label	Dir	Type of Equipment	RM Pay Item
45	S4040	I-94	Peterson Ave	Cook	C8			Cabinet	S-1
46	S4045	I-94	Peterson Ave	Cook	C9			Cabinet	S-1
47	S4050	I-94	Peterson Ave	Cook	C10			Cabinet	S-1
48	S4065	I-94	Touhy Ave	Cook	E12			Cabinet	S-1
49	S4070	I-94	Touhy Ave	Cook	E15			Cabinet	S-1
50	S4075	I-94	Touhy Ave	Cook	E16			Cabinet	S-1
51	S4080	I-94	Touhy Ave	Cook	E17			Cabinet	S-1
52	S4100	I-94	Dempster St	Cook	H21			Cabinet	S-1
53	S4105	I-94	Dempster St	Cook	H22			Cabinet	S-1
54	S4110	I-94	Dempster St	Cook	H23			Cabinet	S-1
55	S4115	I-94	Dempster St	Cook	H24			Cabinet	S-1
56	S5015	I-94	95th St	Cook	O86			Cabinet	S-1
57	S5035	I-94	87th St	Cook	O85			Cabinet	S-1
58	S5040	I-94	87th St	Cook	P82			Cabinet	S-1
59	S5050	I-94	83rd St	Cook	P78			Cabinet	S-1
60	S5070	I-94	79th St	Cook	P76			Cabinet	S-1
61	S5075	I-94	79th St	Cook	P77			Cabinet	S-1
62	S5085	I-94	76th St	Cook	R71			Cabinet	S-1
63	S5105	I-94	75th St	Cook	R72			Cabinet	S-1
64	S5115	I-94	71st St	Cook	R66			Cabinet	S-1
65	S5120	I-94	71st St	Cook	R67			Cabinet	S-1
66	S5125	I-94	67th St	Cook	R63			Cabinet	S-1
67	S5220	I-90/94	51st St	Cook	U39			Cabinet	S-1
68	S5225	I-90/94	51st St	Cook	U41			Cabinet	S-1
69	S5230	I-90/94	51st St	Cook	U43			Cabinet	S-1
70	S5235	I-90/94	51st St	Cook	U46			Cabinet	S-1
71	S5240	I-90/94	51st St	Cook	U48			Cabinet	S-1
72	S5385	I-90/94	Roosevelt Rd	Cook	C5			Cabinet	S-1
73	S5390	I-90/94	Roosevelt Rd	Cook	C6			Cabinet	S-1
74	S5405	I-90/94	Taylor St	Cook	D4			Cabinet	S-1
75	S6255	I-94	99th Pl	Cook	M2			Cabinet	S-1
76	S8005	I-290	Canal St	Cook	F0			Cabinet	S-1
77	S8040	I-290	Ashland Ave	Cook	G8			Cabinet	S-1
78	S8060	I-290	Damen Ave & Paulina St	Cook	H11A			Cabinet	S-1
79	S8085	I-290	Western Ave	Cook	H15			Cabinet	S-1
80	S8095	I-290	California Ave	Cook	H16			Cabinet	S-1
81	S8105	I-290	Sacramento Blvd	Cook	I19			Cabinet	S-1
82	S8110	I-290	Homan Ave	Cook	I20			Cabinet	S-1
83	S8120	I-290	Independence Blvd	Cook	J22			Cabinet	S-1
84	S8135	I-290	Independence Blvd	Cook	J27			Cabinet	S-1
85	S8140	I-290	Kostner Ave	Cook	J26			Cabinet	S-1
86	S8160	I-290	Cicero Ave	Cook	K33			Cabinet	S-1
87	S8165	I-290	Laramie Ave	Cook	K30			Cabinet	S-1
88	S8175	I-290	Central Ave	Cook	L32			Cabinet	S-1
89	S8195	I-290	Central Ave	Cook	L39			Cabinet	S-1
90	S8210	I-290	Austin Blvd	Cook	M43			Cabinet	S-1

Ct	Loc #	Main Route	Nearest Cross Street	Co	Cab	Sign Label	Dir	Type of Equipment	RM Pay Item
91	S8230	I-290	IL 43 (Harlem Ave)	Cook	M40			Cabinet	S-1
92	S8240	I-290	IL 43 (Harlem Ave)	Cook	M49			Cabinet	S-1
93	S8255	I-290	Des Plaines Ave	Cook	N53			Cabinet	S-1
94	S8265	I-290	IL 1717 (1st Ave)	Cook	O48			Cabinet	S-1
95	S8280	I-290	IL 1717 (1st Ave)	Cook	O59			Cabinet	S-1
96	S8285	I-290	9th Ave	Cook	P52			Cabinet	S-1
97	S8295	I-290	17th Ave	Cook	P54			Cabinet	S-1
98	S8310	I-290	17th Ave	Cook	P65			Cabinet	S-1
99	S8315	I-290	25th Ave	Cook	R58			Cabinet	S-1
100	S8320	I-290	25th Ave	Cook	R60			Cabinet	S-1
101	S8340	I-290	Addison Creek	Cook	R69			Cabinet	S-1
102	S8345	I-290	Mannheim Rd SE	Cook	S64			Cabinet	S-1
103	S8350	I-290	Mannheim Rd SW	Cook	S66			Cabinet	S-1
104	S8360	I-290	Mannheim Rd NE	Cook	S71			Cabinet	S-1
105	S8370	I-290	Mannheim Rd NW	Cook	S75			Cabinet	S-1
106	S8375	I-290	Hillside Ave	Cook	T70			Cabinet	S-1
107	S9030	I-290	St. Charles Rd	DuPage	W80			Cabinet	S-1
108	S9035	I-290	St. Charles Rd	DuPage	W82			Cabinet	S-1
109	S9040	I-290	St. Charles Rd	DuPage	W83			Cabinet	S-1
110	S9045	I-290	St. Charles Rd	DuPage	W85			Cabinet	S-1
111	S9055	I-290	IL 64 (North Ave)	DuPage	X86			Cabinet	S-1
112	S9075	I-290	IL 64 (North Ave)	DuPage	X90			Cabinet	S-1
113	S9130	I-290	IL 83 (Kingery Highway)	DuPage	A101			Cabinet	S-1
114	S9140	I-290	IL 83 (Kingery Highway)	DuPage	A103			Cabinet	S-1

1	S1000	I-55	Martin Luther King Dr	Cook	B0			Ramp	S-2
2	S1005	I-55	Martin Luther King Dr	Cook	B1			Ramp	S-2
3	S1010	I-55	State St	Cook	B3			Ramp	S-2
4	S1015	I-55	26th St & Wentworth Ave	Cook	C2			Ramp	S-2
5	S1020	I-55	26th St & Wentworth Ave	Cook	C5			Ramp	S-2
6	S1025	I-55	W of Wentworth Ave	Cook	C4			Ramp	S-2
7	S1030	I-55	W of Wentworth Ave	Cook	C7			Ramp	S-2
8	S1035	I-55	I-90/94 Interchange	Cook	Y15			Ramp	S-2
9	S1040	I-55	I-90/94 Interchange	Cook	Y16			Ramp	S-2
10	S1045	I-55	I-90/94 Interchange	Cook	Y17			Ramp	S-2
11	S1047	I-55	I-90/94 Cross Connect	Cook	MCD 18			Ramp	S-2
12	S1050	I-55	I-90/94 Interchange	Cook	Y18			Ramp	S-2
13	S1055	I-55	Archer Ave & Mary St	Cook	6			Ramp	S-2
14	S1060	I-55	Lock St	Cook	8			Ramp	S-2
15	S1065	I-55	Wood St	Cook	10			Ramp	S-2
16	S1075	I-55	Hoyne Ave	Cook	12			Ramp	S-2
17	S1080	I-55	Penn Central RR	Cook	14			Ramp	S-2
18	S1100	I-55	Kedzie Ave & California Ave	Cook	16			Ramp	S-2
19	S1105	I-55	Kedzie Ave & California Ave	Cook	18			Ramp	S-2
20	S1110	I-55	Kedzie Ave & California Ave	Cook	20			Ramp	S-2
21	S1115	I-55	East of Pulaski Rd (ATSF RR)	Cook	9			Ramp	S-2

Ct	Loc #	Main Route	Nearest Cross Street	Co	Cab	Sign Label	Dir	Type of Equipment	RM Pay Item
22	S1120	I-55	Pulaski Rd	Cook	11			Ramp	S-2
23	S1125	I-55	Pulaski Rd	Cook	22			Ramp	S-2
24	S1130	I-55	IL 50 (Cicero Ave)	Cook	13			Ramp	S-2
25	S1135	I-55	IL 50 (Cicero Ave)	Cook	TDC1			Ramp	S-2
26	S1140	I-55	IL 50 (Cicero Ave) OB Exit	Cook	15			Ramp	S-2
27	S1150	I-55	IL 50 (Cicero Ave) IB RS	Cook	26			Ramp	S-2
28	S1160	I-55	IL 50 (Cicero Ave)	Cook	24			Ramp	S-2
29	S1165	I-55	Central Ave	Cook	17			Ramp	S-2
30	S1170	I-55	Central Ave	Cook	28			Ramp	S-2
31	S1175	I-55	Central Ave / IL 43 (Harlem Ave)	Cook	30			Ramp	S-2
32	S1180	I-55	6000W IB RS	Cook	32			Ramp	S-2
33	S1185	I-55	Central Ave / IL 43 (Harlem Ave)	Cook	19			Ramp	S-2
34	S1190	I-55	Central Ave / IL 43 (Harlem Ave)	Cook	21			Ramp	S-2
35	S1195	I-55	IL 43 (Harlem Ave)	Cook	23			Ramp	S-2
36	S1205	I-55	IL 43 (Harlem Ave)	Cook	34			Ramp	S-2
37	S1210	I-55	IL 43 (Harlem Ave)	Cook	25			Ramp	S-2
38	S1215	I-55	IL 43 (Harlem Ave)	Cook	36			Ramp	S-2
39	S1220	I-55	7500 West	Cook	27			Ramp	S-2
40	S1225	I-55	Lawndale Ave	Cook	29			Ramp	S-2
41	S1235	I-55	Lawndale Ave IB	Cook	38			Ramp	S-2
42	S1240	I-55	Lawndale Ave	Cook	31			Ramp	S-2
43	S1245	I-55	Lawndale Ave	Cook	40			Ramp	S-2
44	S1250	I-55	B&O RR (8300 W)	Cook	42			Ramp	S-2
45	S1255	I-55	8600 W	Cook	44			Ramp	S-2
46	S1260	I-55	8800 W	Cook	46			Ramp	S-2
47	S1265	I-55	9100 W	Cook	P50			Ramp	S-2
48	S1270	I-55	9700 W	Cook	R43			Ramp	S-2
49	S1275	I-55	US 12/20/45 (LaGrange Rd)	Cook	R45			Ramp	S-2
50	S1280	I-55	US 12/20/45 (LaGrange Rd)	Cook	R47			Ramp	S-2
51	S1285	I-55	US 12/20/45 (LaGrange Rd)	Cook	R52			Ramp	S-2
52	S1290	I-55	US 12/20/45 (LaGrange Rd) SW	Cook	R54			Ramp	S-2
53	S1295	I-55	E of Willow Springs Rd	Cook	R49			Ramp	S-2
54	S1300	I-55	OB E of Willow Springs Rd	Cook	R49A			Ramp	S-2
55	S1305	I-55	10900 West	Cook	S51			Ramp	S-2
56	S1310	I-55	10900 West	Cook	S56			Ramp	S-2
57	S1315	I-55	I-294 Tollway	Cook	S53			Ramp	S-2
58	S1320	I-55	Joliet Rd	Cook	S55			Ramp	S-2
59	S1325	I-55	E of County Line Rd	Cook	57			Ramp	S-2
60	S2000	I-57	C&W RR	Cook	A3			Ramp	S-2
61	S2010	I-57	IL 1 (Halsted St)	Cook	A5			Ramp	S-2
62	S2015	I-57	IL 1 (Halsted St)	Cook	B7			Ramp	S-2
63	S2020	I-57	100th St	Cook	B4			Ramp	S-2
64	S2025	I-57	104th St	Cook	B6			Ramp	S-2
65	S2030	I-57	107th St	Cook	C9			Ramp	S-2
66	S2035	I-57	111th St	Cook	C8			Ramp	S-2
67	S2040	I-57	111th St	Cook	C11			Ramp	S-2

Ct	Loc #	Main Route	Nearest Cross Street	Co	Cab	Sign Label	Dir	Type of Equipment	RM Pay Item
68	S2050	I-57	111th St	Cook	D13			Ramp	S-2
69	S2055	I-57	119th St	Cook	D12			Ramp	S-2
70	S2060	I-57	119th St	Cook	E14			Ramp	S-2
71	S2065	I-57	119th St	Cook	E15			Ramp	S-2
72	S2075	I-57	127th St	Cook	F16			Ramp	S-2
73	S2080	I-57	127th St	Cook	F19			Ramp	S-2
74	S2085	I-57	127th St	Cook	G18			Ramp	S-2
75	S2095	I-57	Cal Sag Channel	Cook	G20			Ramp	S-2
76	S2100	I-57 IB	B&O RR	Cook	H22			Ramp	S-2
77	S2105	I-57 IB	IHB RR	Cook	H24			Ramp	S-2
78	S2110	I-57 IB	1/2 Mi S of IHB RR	Cook	I26			Ramp	S-2
79	S2115	I-57 OB	1/2 Mi N of IL 83	Cook	I23			Ramp	S-2
80	S2120	I-57 OB	IL 83 (147th St / Sibley Blvd)	Cook	J25			Ramp	S-2
81	S2125	I-57 IB	IL 83 (147th St / Sibley Blvd)	Cook	J28			Ramp	S-2
82	S2135	I-57	I-294 Tollway	Cook	J32			Ramp	S-2
83	S2140	I-57	N of Kedzie Ave	Cook	K27			Ramp	S-2
84	S2145	I-57	155th St	Cook	K29			Ramp	S-2
85	S2155	I-57	US 6 (159th St)	Cook	L33			Ramp	S-2
86	S2160	I-57	US 6 (159th St)	Cook	L34			Ramp	S-2
87	S2165	I-57	US 6 (159th St)	Cook	L35			Ramp	S-2
88	S2170	I-57	US 6 (159th St)	Cook	L36			Ramp	S-2
89	S2175	I-57	163rd St	Cook	M37			Ramp	S-2
90	S2180	I-57	167th St	Cook	N39			Ramp	S-2
91	S2190	I-57	167th St	Cook	N43			Ramp	S-2
92	S2195	I-57	167th St	Cook	O83			Ramp	S-2
93	S2205	I-57	167th St	Cook	O42			Ramp	S-2
94	S2210	I-57	W of Cicero Ave	Cook	T45			Ramp	S-2
95	S2215	I-57	1/2 Mi W of Cicero Ave	Cook	T47			Ramp	S-2
96	S2220	I-57	I-80 Interchange	Cook	T44			Ramp	S-2
97	S2225	I-57	I-80 Interchange	Cook	T46			Ramp	S-2
98	S2230	I-57	I-80 Interchange	Cook	T49			Ramp	S-2
99	S2235	I-57	I-80 Interchange	Cook	U48			Ramp	S-2
100	S2240	I-57	I-80 Interchange	Cook	U51			Ramp	S-2
101	S2245	I-57	I-80 Interchange	Cook	U53			Ramp	S-2
102	S3000	I-190	O'Hare Airport Parking Lot C	Cook	C131			Ramp	S-2
103	S3005	I-190	US 12/45 (Mannheim Rd)	Cook	C127			Ramp	S-2
104	S3007	I-190	US 12/45 (Mannheim Rd)	Cook	C127A			Ramp	S-2
105	S3010	I-190	US 12/45 (Mannheim Rd)	Cook	C129			Ramp	S-2
106	S3015	I-190	US 12/45 (Mannheim Rd)	Cook	C134			Ramp	S-2
107	S3020	I-190	US 12/45 (Mannheim Rd)	Cook	C136			Ramp	S-2
108	S3025	I-190	I-294 Toll Plaza	Cook	C123			Ramp	S-2
109	S3030	I-190	I-294 Toll Plaza	Cook	C125			Ramp	S-2
110	S3035	I-190	I-294 Toll Plaza	Cook	C130			Ramp	S-2
111	S3040	I-190	I-294 Toll Plaza	Cook	C132			Ramp	S-2
112	S3045	I-190	Des Plaines River Rd	Cook	D119			Ramp	S-2
113	S3050	I-190	Des Plaines River Rd	Cook	D121			Ramp	S-2

Ct	Loc #	Main Route	Nearest Cross Street	Co	Cab	Sign Label	Dir	Type of Equipment	RM Pay Item
114	S3055	I-190	Des Plaines River Rd	Cook	D126			Ramp	S-2
115	S3060	I-190	Des Plaines River Rd	Cook	D128			Ramp	S-2
116	S3065	I-90	East River Rd	Cook	D124			Ramp	S-2
117	S3067	I-90	East River Rd	Cook	MCD 6			Ramp	S-2
118	S3070	I-90	Cumberland Ave	Cook	D122			Ramp	S-2
119	S3090	I-90	Canfield Ave	Cook	F111			Ramp	S-2
120	S3100	I-90	IL 43 (Harlem Ave)	Cook	F107			Ramp	S-2
121	S3115	I-90	IL 43 (Harlem Ave)	Cook	F116			Ramp	S-2
122	S3120	I-90	IL 43 (Harlem Ave)	Cook	G105			Ramp	S-2
123	S3130	I-90	Sayre Ave	Cook	G103			Ramp	S-2
124	S3145	I-90	Nagle Ave	Cook	H108			Ramp	S-2
125	S3150	I-90	Bryn Mawr Ave	Cook	H99			Ramp	S-2
126	S3160	I-90	Meade Ave	Cook	H104			Ramp	S-2
127	S3170	I-90	Foster Ave	Cook	I95			Ramp	S-2
128	S3180	I-90	Central Ave	Cook	I93			Ramp	S-2
129	S3190	I-90	Central Ave	Cook	I100A			Ramp	S-2
130	S3195	I-90	Milwaukee Ave	Cook	I98			Ramp	S-2
131	S3200	I-90	Lawrence Ave	Cook	J87			Ramp	S-2
132	S3205	I-90	Lawrence Ave	Cook	J89			Ramp	S-2
133	S3220	I-90	Lawrence Ave	Cook	J96			Ramp	S-2
134	S3225	I-90	IL 50 (Cicero Ave)	Cook	J85			Ramp	S-2
135	S3230	I-90	IL 50 (Cicero Ave)	Cook	J94			Ramp	S-2
136	S3232	I-90/94	Montrose Ave	Cook	MCD 12			Ramp	S-2
137	S3235	I-90/94	Montrose Ave	Cook	J81			Ramp	S-2
138	S3238	I-90/94	Montrose Ave	Cook	J92A			Ramp	S-2
139	S3250	I-90/94	Kostner Ave	Cook	K79			Ramp	S-2
140	S3253	I-90/94	Keeler Ave	Cook	K77A			Ramp	S-2
141	S3255	I-90/94	Keeler Ave	Cook	K90			Ramp	S-2
142	S3260	I-90/94	Pulaski Rd	Cook	K73			Ramp	S-2
143	S3290	I-90/94	Addison Rd	Cook	L67			Ramp	S-2
144	S3295	I-90/94	Addison Rd	Cook	L69			Ramp	S-2
145	S3300	I-90/94	Addison Rd	Cook	L78			Ramp	S-2
146	S3315	I-90/94	Kimball Ave	Cook	L63			Ramp	S-2
147	S3330	I-90/94	Kimball Ave	Cook	L74			Ramp	S-2
148	S3335	I-90/94	Belmont Ave	Cook	L61			Ramp	S-2
149	S3345	I-90/94	Sacramento Blvd	Cook	M55			Ramp	S-2
150	S3375	I-90/94	California Ave	Cook	M64			Ramp	S-2
151	S3380	I-90/94	Diversey Ave	Cook	M53			Ramp	S-2
152	S3395	I-90/94	Fullerton Ave	Cook	N60			Ramp	S-2
153	S3400	I-90/94	Fullerton Ave	Cook	N49			Ramp	S-2
154	S3410	I-90/94	Webster Ave	Cook	N47			Ramp	S-2
155	S3425	I-90/94	Armitage Ave	Cook	O45			Ramp	S-2
156	S3430	I-90/94	Armitage Ave	Cook	O43			Ramp	S-2
157	S3435	I-90/94	Armitage Ave	Cook	O52			Ramp	S-2
158	S3440	I-90/94	North Ave	Cook	P41			Ramp	S-2
159	S3455	I-90/94	North Ave	Cook	O50			Ramp	S-2

Ct	Loc #	Main Route	Nearest Cross Street	Co	Cab	Sign Label	Dir	Type of Equipment	RM Pay Item
160	S3462	I-90/94	Division St	Cook	R39A			Ramp	S-2
161	S3470	I-90/94	Division St	Cook	R46			Ramp	S-2
162	S3475	I-90/94	Augusta Blvd	Cook	R37			Ramp	S-2
163	S3490	I-90/94	Chicago Ave	Cook	R40			Ramp	S-2
164	S3495	I-90/94	Ohio St	Cook	S31			Ramp	S-2
165	S3500	I-90/94	Ohio St	Cook	S33			Ramp	S-2
166	S3505	I-90/94	Ohio St	Cook	S38			Ramp	S-2
167	S3510	I-90/94	Ohio St Feeder	Cook	S32			Ramp	S-2
168	S3515	I-90/94	Ohio St Feeder	Cook	S34			Ramp	S-2
169	S3520	I-90/94	Green St	Cook	S36			Ramp	S-2
170	S3530	I-90/94	Lake St	Cook	Y30			Ramp	S-2
171	S3535	I-90/94	Randolph St	Cook	Y24			Ramp	S-2
172	S3540	I-90/94	Randolph St	Cook	Y26			Ramp	S-2
173	S3545	I-90/94	Randolph St	Cook	Y27			Ramp	S-2
174	S3555	I-90/94	Washington Blvd	Cook	Y20			Ramp	S-2
175	S3558	I-90/94	Washington Blvd	Cook	Y22S			Ramp	S-2
176	S3560	I-90/94	Washington Blvd	Cook	Y22			Ramp	S-2
177	S3565	I-90/94	Washington Blvd	Cook	Y23			Ramp	S-2
178	S3575	I-90/94	Madison Ave	Cook	Y16			Ramp	S-2
179	S3580	I-90/94	Madison Ave	Cook	Y18			Ramp	S-2
180	S3585	I-90/94	Madison Ave	Cook	Y19			Ramp	S-2
181	S3590	I-90/94	Madison Ave	Cook	Y21			Ramp	S-2
182	S3595	I-90/94	Monroe St	Cook	Y15			Ramp	S-2
183	S3605	I-90/94	Monroe St	Cook	Z10			Ramp	S-2
184	S3610	I-90/94	Monroe St	Cook	Z12			Ramp	S-2
185	S3615	I-90/94	Monroe St	Cook	Z14			Ramp	S-2
186	S3620	I-90/94	Adams St	Cook	Z8			Ramp	S-2
187	S3625	I-90/94	Adams St	Cook	Z9			Ramp	S-2
188	S3630	I-90/94	Adams St	Cook	Z11			Ramp	S-2
189	S3640	I-90/94	I-290 / Circle Interchange	Cook	Z1			Ramp	S-2
190	S3645	I-90/94	I-290 / Circle Interchange	Cook	Z2			Ramp	S-2
191	S3650	I-90/94	I-290 / Circle Interchange	Cook	Z3			Ramp	S-2
192	S3655	I-90/94	I-290 / Circle Interchange	Cook	Z4			Ramp	S-2
193	S3660	I-90/94	I-290 / Circle Interchange	Cook	Z5			Ramp	S-2
194	S3665	I-90/94	I-290 / Circle Interchange	Cook	Z6			Ramp	S-2
195	S3670	I-90/94	I-290 / Circle Interchange	Cook	Z7			Ramp	S-2
196	S3675	I-90/94	I-290 / Circle Interchange	Cook	MCD 5			Ramp	S-2
197	S4000	I-94	Wilson Ave	Cook	A2A			Ramp	S-2
198	S4005	I-94	Wilson Ave	Cook	A1			Ramp	S-2
199	S4010	I-94	Wilson Ave	Cook	2			Ramp	S-2
200	S4015	I-94	Wilson Ave	Cook	3			Ramp	S-2
201	S4016	I-94	Wilson Ave	Cook	MCD 10			Ramp	S-2
202	S4018	I-94	Wilson Ave	Cook	MCD 11			Ramp	S-2
203	S4030	I-94	IL 50 (Cicero Ave)	Cook	B6			Ramp	S-2
204	S4035	I-94	Peterson Ave	Cook	C7			Ramp	S-2
205	S4055	I-94	Devon Ave	Cook	D11			Ramp	S-2

Ct	Loc #	Main Route	Nearest Cross Street	Co	Cab	Sign Label	Dir	Type of Equipment	RM Pay Item
206	S4060	I-94	Pratt Ave	Cook	D13			Ramp	S-2
207	S4085	I-94	Niles Center Rd	Cook	E19			Ramp	S-2
208	S4090	I-94	Oakton St	Cook	G18			Ramp	S-2
209	S4095	I-94	Lincoln Ave	Cook	G20			Ramp	S-2
210	S4120	I-94	Church St	Cook	H26			Ramp	S-2
211	S4125	I-94	Golf Rd	Cook	J25			Ramp	S-2
212	S4130	I-94	Old Orchard	Cook	K27			Ramp	S-2
213	S4135	I-94	Old Orchard	Cook	K28			Ramp	S-2
214	S4140	I-94	Glenview Ave	Cook	K30			Ramp	S-2
215	S4145	I-94	Lake Ave	Cook	L29			Ramp	S-2
216	S4150	I-94	Lake Ave	Cook	L32			Ramp	S-2
217	S4155	I-94	Lake Ave	Cook	L34			Ramp	S-2
218	S4160	I-94	US 41 (Skokie Blvd)	Cook	M31			Ramp	S-2
219	S4165	I-94	US 41 (Skokie Blvd)	Cook	M36			Ramp	S-2
220	S4170	I-94	Winnetka Rd	Cook	M33			Ramp	S-2
221	S4175	I-94	Willow Rd	Cook	N35			Ramp	S-2
222	S4180	I-94	Willow Rd	Cook	N37			Ramp	S-2
223	S4185	I-94	Willow Rd	Cook	N38			Ramp	S-2
224	S4190	I-94	Willow Rd	Cook	N40			Ramp	S-2
225	S4195	I-94	1/2 Mi S of Tower Rd	Cook	O42			Ramp	S-2
226	S4200	I-94	Tower Rd	Cook	O39			Ramp	S-2
227	S4205	I-94	Tower Rd	Cook	O44			Ramp	S-2
228	S4210	I-94	1/2 Mi N of Tower Rd	Cook	P46			Ramp	S-2
229	S4215	I-94	1/2 Mi S of IL 68 (Dundee Rd)	Cook	P48			Ramp	S-2
230	S4220	I-94	IL 68 (Dundee Rd)	Cook	R41			Ramp	S-2
231	S4225	I-94	IL 68 (Dundee Rd)	Cook	R50			Ramp	S-2
232	S4230	I-94	IL 68 (Dundee Rd)	Cook	R52			Ramp	S-2
233	S4235	I-94	I-294 Tollway	Cook	R54			Ramp	S-2
234	S4240	I-94	Lake Cook Rd	Cook	S56			Ramp	S-2
235	S5000	I-94	97th St	Cook	A1			Ramp	S-2
236	S5005	I-94	97th St	Cook	M90			Ramp	S-2
237	S5010	I-94	97th St	Cook	N89			Ramp	S-2
238	S5020	I-94	US 12/20 (95th St)	Cook	O87			Ramp	S-2
239	S5025	I-94	US 12/20 (95th St)	Cook	O88			Ramp	S-2
240	S5030	I-94	87th St	Cook	O84			Ramp	S-2
241	S5045	I-94	87th St	Cook	P83			Ramp	S-2
242	S5055	I-94	83rd St	Cook	P80			Ramp	S-2
243	S5060	I-94	83rd St	Cook	P81			Ramp	S-2
244	S5065	I-94	79th St	Cook	P75			Ramp	S-2
245	S5080	I-94	79th St	Cook	P79			Ramp	S-2
246	S5090	I-94	76th St	Cook	P73			Ramp	S-2
247	S5095	I-94	75th St	Cook	R69			Ramp	S-2
248	S5100	I-94	75th St	Cook	R70			Ramp	S-2
249	S5110	I-94	75th St	Cook	R74			Ramp	S-2
250	S5130	I-94	67th St	Cook	R65			Ramp	S-2
251	S5135	I-94	65th St & Wentworth Ave	Cook	S61			Ramp	S-2

Ct	Loc #	Main Route	Nearest Cross Street	Co	Cab	Sign Label	Dir	Type of Equipment	RM Pay Item
252	S5140	I-94	65th St & Wentworth Ave	Cook	S64			Ramp	S-2
253	S5145	I-90/94	59th St	Cook	S57			Ramp	S-2
254	S5150	I-90/94	59th St	Cook	S59			Ramp	S-2
255	S5155	I-90/94	59th St	Cook	S60			Ramp	S-2
256	S5160	I-90/94	59th St	Cook	S62			Ramp	S-2
257	S5165	I-90/94	59th St	Cook	T51			Ramp	S-2
258	S5170	I-90/94	59th St	Cook	T53			Ramp	S-2
259	S5175	I-90/94	59th St	Cook	T55			Ramp	S-2
260	S5180	I-90/94	59th St	Cook	T56			Ramp	S-2
261	S5185	I-90/94	59th St	Cook	T58			Ramp	S-2
262	S5190	I-90/94	55th St	Cook	T45			Ramp	S-2
263	S5195	I-90/94	55th St	Cook	T47			Ramp	S-2
264	S5200	I-90/94	55th St	Cook	T49			Ramp	S-2
265	S5205	I-90/94	55th St	Cook	T50			Ramp	S-2
266	S5210	I-90/94	55th St	Cook	T52			Ramp	S-2
267	S5215	I-90/94	55th St	Cook	T54			Ramp	S-2
268	S5245	I-90/94	45th St	Cook	V35			Ramp	S-2
269	S5250	I-90/94	45th St	Cook	V37			Ramp	S-2
270	S5255	I-90/94	45th St	Cook	V42			Ramp	S-2
271	S5260	I-90/94	45th St	Cook	V44			Ramp	S-2
272	S5265	I-90/94	Root St	Cook	V31			Ramp	S-2
273	S5270	I-90/94	Root St	Cook	V33			Ramp	S-2
274	S5275	I-90/94	Root St	Cook	V36			Ramp	S-2
275	S5280	I-90/94	Root St	Cook	V38			Ramp	S-2
276	S5285	I-90/94	Root St	Cook	V40			Ramp	S-2
277	S5290	I-90/94	39th St	Cook	W29			Ramp	S-2
278	S5295	I-90/94	39th St	Cook	W34			Ramp	S-2
279	S5300	I-90/94	35th St	Cook	W27			Ramp	S-2
280	S5305	I-90/94	35th St	Cook	W30			Ramp	S-2
281	S5310	I-90/94	35th St	Cook	W32			Ramp	S-2
282	S5315	I-90/94	33rd St	Cook	W25			Ramp	S-2
283	S5320	I-90/94	33rd St	Cook	W28			Ramp	S-2
284	S5325	I-90/94	31st St	Cook	W23			Ramp	S-2
285	S5330	I-90/94	31st St	Cook	W26			Ramp	S-2
286	S5335	I-90/94	29th St	Cook	X20			Ramp	S-2
287	S5340	I-90/94	29th St	Cook	X21			Ramp	S-2
288	S5345	I-90/94	29th St	Cook	X22			Ramp	S-2
289	S5350	I-90/94	29th St	Cook	X24			Ramp	S-2
290	S5355	I-90/94	26th St & Princeton Ave	Cook	X19			Ramp	S-2
291	S5360	I-90/94	Ford Ave	Cook	Z12			Ramp	S-2
292	S5365	I-90/94	Ford Ave	Cook	Z14			Ramp	S-2
293	S5370	I-90/94	22nd St & Emerald Ave	Cook	Z10			Ramp	S-2
294	S5375	I-90/94	22nd St & Emerald Ave	Cook	Z13			Ramp	S-2
295	S5380	I-90/94	16th St & Union Ave	Cook	A11			Ramp	S-2
296	S5393	I-90/94	Taylor St	Cook	C6T			Ramp	S-2
297	S5395	I-90/94	Roosevelt Rd	Cook	C8			Ramp	S-2

Ct	Loc #	Main Route	Nearest Cross Street	Co	Cab	Sign Label	Dir	Type of Equipment	RM Pay Item
298	S5400	I-90/94	Taylor St	Cook	C3			Ramp	S-2
299	S5410	I-90/94	Polk St	Cook	D1			Ramp	S-2
300	S6000	I-94	I-80/94 Interchange	Cook	C9			Ramp	S-2
301	S6005	I-94	I-80/94 Interchange	Cook	C12			Ramp	S-2
302	S6010	I-94	I-80/94 Interchange	Cook	C13			Ramp	S-2
303	S6015	I-94	I-80/94 Interchange	Cook	C14			Ramp	S-2
304	S6020	I-94	I-80/94 Interchange	Cook	D11			Ramp	S-2
305	S6025	I-94	I-80/94 Interchange	Cook	D16			Ramp	S-2
306	S6030	I-94	I-80/94 Interchange	Cook	D18			Ramp	S-2
307	S6035	I-94	171st St	Cook	C40			Ramp	S-2
308	S6040	I-94	166th St	Cook	E38			Ramp	S-2
309	S6045	I-94	US 6 (159th St)	Cook	F32			Ramp	S-2
310	S6050	I-94	US 6 (159th St)	Cook	F34			Ramp	S-2
311	S6055	I-94	US 6 (159th St)	Cook	F36			Ramp	S-2
312	S6060	I-94	US 6 (159th St)	Cook	F47			Ramp	S-2
313	S6065	I-94	US 6 (159th St)	Cook	F49			Ramp	S-2
314	S6070	I-94	Penn Central RR	Cook	F45			Ramp	S-2
315	S6075	I-94	Pulaski Rd	Cook	F43			Ramp	S-2
316	S6080	I-94	IL 83 / 147th St / Sibley Blvd	Cook	G28			Ramp	S-2
317	S6085	I-94	IL 83 / 147th St / Sibley Blvd	Cook	G30			Ramp	S-2
318	S6090	I-94	IL 83 / 147th St / Sibley Blvd	Cook	G37			Ramp	S-2
319	S6095	I-94	IL 83 / 147th St / Sibley Blvd	Cook	G39			Ramp	S-2
320	S6100	I-94	IL 83 / 147th St / Sibley Blvd	Cook	G41			Ramp	S-2
321	S6105	I-94	Dolton St	Cook	H24			Ramp	S-2
322	S6110	I-94	Dolton St	Cook	H26			Ramp	S-2
323	S6120	I-94	Dolton St	Cook	H35			Ramp	S-2
324	S6125	I-94	N of B & O RR	Cook	H31			Ramp	S-2
325	S6130	I-94	138th St	Cook	X22			Ramp	S-2
326	S6135	I-94	138th St	Cook	X29			Ramp	S-2
327	S6140	I-94	133rd St	Cook	X20			Ramp	S-2
328	S6145	I-94	130th St	Cook	I16			Ramp	S-2
329	S6150	I-94	130th St	Cook	I18			Ramp	S-2
330	S6155	I-94	130th St	Cook	I25			Ramp	S-2
331	S6160	I-94	130th St	Cook	I27			Ramp	S-2
332	S6165	I-94	128th St	Cook	J23			Ramp	S-2
333	S6170	I-94	124th St	Cook	J21			Ramp	S-2
334	S6175	I-94	125th St	Cook	J19			Ramp	S-2
335	S6180	I-94	115th St	Cook	H12			Ramp	S-2
336	S6185	I-94	115th St	Cook	H14			Ramp	S-2
337	S6190	I-94	115th St	Cook	H15			Ramp	S-2
338	S6195	I-94	115th St	Cook	J17			Ramp	S-2
339	S6200	I-94	111th St	Cook	K8			Ramp	S-2
340	S6205	I-94	111th St	Cook	K10			Ramp	S-2
341	S6210	I-94	111th St	Cook	K11			Ramp	S-2
342	S6215	I-94	111th St	Cook	K13			Ramp	S-2
343	S6220	I-94	107th St	Cook	L7			Ramp	S-2

Ct	Loc #	Main Route	Nearest Cross Street	Co	Cab	Sign Label	Dir	Type of Equipment	RM Pay Item
344	S6225	I-94	107th St	Cook	L9			Ramp	S-2
345	S6230	I-94	103rd St	Cook	L6			Ramp	S-2
346	S6235	I-94	Ellis Ave	Cook	L4			Ramp	S-2
347	S6240	I-94	Ellis Ave	Cook	L5			Ramp	S-2
348	S6245	I-94	Rhodes St	Cook	M3			Ramp	S-2
349	S6250	I-94	Michigan Ave	Cook	M1			Ramp	S-2
350	S6260	I-94	99th St & Lasalle	Cook	M91			Ramp	S-2
351	S6265	I-94	99th St & Lasalle	Cook	M92			Ramp	S-2
352	S7000	I-80/94	Indiana State Line	Cook	A2			Ramp	S-2
353	S7005	I-80/94	Williams St	Cook	A1			Ramp	S-2
354	S7010	I-80/94	Lorenz Ave	Cook	A4			Ramp	S-2
355	S7015	I-80/94	School St	Cook	B3			Ramp	S-2
356	S7020	I-80/94	Torrence Ave SS	Cook	B5			Ramp	S-2
357	S7025	I-80-/94	Torrence Ave SS	Cook	B7			Ramp	S-2
358	S7030	I-80/94	Torrence Ave NS	Cook	B6			Ramp	S-2
359	S7035	I-80/94	Torrence Ave NS	Cook	B8			Ramp	S-2
360	S7040	I-80/94	Paxton Ave	Cook	C10			Ramp	S-2
361	S7045	I-80/94	Paxton Ave	Cook	MCD4			Ramp	S-2
362	S8000	I-290	Franklin St	Cook	B2			Ramp	S-2
363	S8010	I-290	Morgan St	Cook	G1			Ramp	S-2
364	S8015	I-290	Racine Ave	Cook	G3			Ramp	S-2
365	S8020	I-290	Racine Ave	Cook	G4			Ramp	S-2
366	S8025	I-290	Racine Ave	Cook	G5			Ramp	S-2
367	S8030	I-290	Racine Ave	Cook	G6			Ramp	S-2
368	S8035	I-290	Ashland Ave	Cook	G7			Ramp	S-2
369	S8045	I-290	Damen Ave & Paulina St	Cook	G9			Ramp	S-2
370	S8050	I-290	Damen Ave & Paulina St	Cook	G10			Ramp	S-2
371	S8055	I-290	Damen Ave & Paulina St	Cook	H11			Ramp	S-2
372	S8065	I-290	Damen Ave & Paulina St	Cook	H12			Ramp	S-2
373	S8070	I-290	Damen Ave & Paulina St	Cook	H12A			Ramp	S-2
374	S8075	I-290	Oakley Ave	Cook	H13			Ramp	S-2
375	S8080	I-290	Oakley Ave	Cook	H14			Ramp	S-2
376	S8090	I-290	Western Ave	Cook	H17			Ramp	S-2
377	S8100	I-290	Sacramento Blvd	Cook	I18			Ramp	S-2
378	S8115	I-290	Homan Ave	Cook	I23			Ramp	S-2
379	S8125	I-290	Independence Blvd	Cook	J24			Ramp	S-2
380	S8130	I-290	Independence Blvd	Cook	J25			Ramp	S-2
381	S8145	I-290	Kostner Ave	Cook	J29			Ramp	S-2
382	S8150	I-290	IL 50 (Cicero Ave)	Cook	K28			Ramp	S-2
383	S8155	I-290	IL 50 (Cicero Ave)	Cook	K31			Ramp	S-2
384	S8170	I-290	Laramie Ave	Cook	K35			Ramp	S-2
385	S8180	I-290	Central Ave	Cook	L34			Ramp	S-2
386	S8185	I-290	Central Ave	Cook	L345			Ramp	S-2
387	S8190	I-290	Central Ave	Cook	L37			Ramp	S-2
388	S8200	I-290	Austin Blvd	Cook	L36			Ramp	S-2
389	S8205	I-290	Austin Blvd	Cook	M41			Ramp	S-2

Ct	Loc #	Main Route	Nearest Cross Street	Co	Cab	Sign Label	Dir	Type of Equipment	RM Pay Item
390	S8215	I-290	East Ave	Cook	M38			Ramp	S-2
391	S8220	I-290	East Ave	Cook	M45			Ramp	S-2
392	S8225	I-290	East Ave	Cook	MCD 1			Ramp	S-2
393	S8235	I-290	IL 43 (Harlem Ave)	Cook	M47			Ramp	S-2
394	S8245	I-290	Des Plaines Ave	Cook	N42			Ramp	S-2
395	S8250	I-290	Des Plaines Ave	Cook	N51			Ramp	S-2
396	S8260	I-290	Des Plaines River	Cook	O44			Ramp	S-2
397	S8270	I-290	IL 171 (1st Ave)	Cook	O55			Ramp	S-2
398	S8275	I-290	IL 171 (1st Ave)	Cook	O57			Ramp	S-2
399	S8290	I-290	9th Ave	Cook	P61			Ramp	S-2
400	S8300	I-290	17th Ave	Cook	P56			Ramp	S-2
401	S8305	I-290	17th Ave	Cook	P63			Ramp	S-2
402	S8325	I-290	25th Ave	Cook	R67			Ramp	S-2
403	S8335	I-290	Addison Creek	Cook	R62			Ramp	S-2
404	S8380	I-290	Hillside Ave / Wolf Rd Exit	Cook	T77			Ramp	S-2
405	S9000	I-290	Wolf Rd	Cook	V72			Ramp	S-2
406	S9005	I-290	Wolf Rd	Cook	MCD 3			Ramp	S-2
407	S9010	I-290	Butterfield Rd	Cook	V74			Ramp	S-2
408	S9015	I-290	I-294 Tollway	Cook	V76			Ramp	S-2
409	S9020	I-290	I-294 Tollway	Cook	V81			Ramp	S-2
410	S9025	I-290	Maple Ave	Cook	W78			Ramp	S-2
411	S9230	I-290	N of Devon Ave	Cook	L123		OB	Ramp	S-2
412	S9235	I-290	Biesterfield Rd	Cook	L122		IB	Ramp	S-2
413	S9240	I-290	Biesterfield Rd	Cook	L123A		OB	Ramp	S-2
414	S9245	I-290 / IL 53	N of Biesterfield Rd	Cook	M124		IB	Ramp	S-2
415	S9250	I-290 / IL 53	WGN Radio Station Tower	Cook	M126		IB	Ramp	S-2
416	S9255	I-290 / IL 53	1 1/2 Mi S of IL 72 (Higgins Rd)	Cook	M128		IB	Ramp	S-2
417	S9260	I-290 / IL 53	1 Mi S of IL 72 (Higgins Rd)	Cook	N130		IB	Ramp	S-2
418	S9270	I-290 / IL 53	IL 72 (Higgins Rd)	Cook	O127		OB	Ramp	S-2
419	S9275	I-290 / IL 53	IL 72 (Higgins Rd)	Cook	O132		IB	Ramp	S-2
420	S9285	I-290 / IL 53	Woodfield Dr	Cook	P129		OB	Ramp	S-2
421	S9295	I-290 / IL 53	I-90 Tollway	Cook	P131			Ramp	S-2
422	S9300	I-290 / IL 53	I-90 Tollway	Cook	P138			Ramp	S-2
423	S10000	IL 53	I-90 Tollway IB	Cook	133			Ramp	S-2
424	S10003	IL 53	I-90 Tollway OB	Cook	140			Ramp	S-2
425	S10005	IL 53	IL 62 (Algonquin Rd)	Cook	135			Ramp	S-2
426	S10010	IL 53	IL 62 (Algonquin Rd)	Cook	142			Ramp	S-2
427	S10015	IL 53	1/2 Mi N of Algonquin Rd	Cook	144			Ramp	S-2
428	S10020	IL 53	Kirchoff Rd	Cook	146			Ramp	S-2
429	S10025	IL 53	Kirchoff Rd	Cook	137			Ramp	S-2
430	S10030	IL 53	Industrial Ave	Cook	143			Ramp	S-2
431	S10035	IL 53	Euclid St	Cook	139			Ramp	S-2
432	S10040	IL 53	Euclid St	Cook	148			Ramp	S-2
433	S10045	IL 53	Euclid St	Cook	150			Ramp	S-2
434	S10047	IL 53	Euclid St	Cook	141			Ramp	S-2
435	S10050	IL 53	US 14 (Northwest Highway)	Cook	145			Ramp	S-2

Ct	Loc #	Main Route	Nearest Cross Street	Co	Cab	Sign Label	Dir	Type of Equipment	RM Pay Item
436	S10055	IL 53	US 14 (Northwest Highway)	Cook	152			Ramp	S-2
437	S10060	IL 53	Palatine Rd	Cook	147			Ramp	S-2
438	S10065	IL 53	Palatine Rd	Cook	149			Ramp	S-2
439	S10070	IL 53	Palatine Rd	Cook	154			Ramp	S-2
440	S10075	IL 53	Palatine Rd	Cook	156			Ramp	S-2
441	S10080	IL 53	Anderson Dr	Cook	151			Ramp	S-2
442	S10085	IL 53	US 12 (Rand Rd)	Cook	153			Ramp	S-2
443	S10090	IL 53	US 12 (Rand Rd)	Cook	158			Ramp	S-2
444	S10095	IL 53	IL 68 (Dundee Rd)	Cook	155			Ramp	S-2
445	S10100	IL 53	IL 68 (Dundee Rd)	Cook	157			Ramp	S-2
446	S10105	IL 53	IL 68 (Dundee Rd)	Cook	160			Ramp	S-2
447	S10110	IL 53	IL 68 (Dundee Rd)	Cook	162			Ramp	S-2
448	S10115	IL 53	1/2 Mi S of Lake Cook Rd	Cook	159			Ramp	S-2
449	S12000	Lake Shore Dr	S of Marquette Rd	Cook	1			Ramp	S-2
450	S12005	Lake Shore Dr	S of Marquette Rd	Cook	2			Ramp	S-2
451	S12010	Lake Shore Dr	Hayes Dr	Cook	3			Ramp	S-2
452	S12015	Lake Shore Dr	S of 59th St	Cook	4			Ramp	S-2
453	S12020	Lake Shore Dr	S of 55th St	Cook	5			Ramp	S-2
454	S12025	Lake Shore Dr	S of 53rd St	Cook	6			Ramp	S-2
455	S12030	Lake Shore Dr	S of 48th St	Cook	7			Ramp	S-2
456	S12035	Lake Shore Dr	S of 47th St	Cook	8			Ramp	S-2
457	S10240	Lake Shore Dr	S of 47th St	Cook	9			Ramp	S-2
458	S12045	Lake Shore Dr	S of 43rd St	Cook	10			Ramp	S-2
459	S12050	Lake Shore Dr	S of Oakwood Blvd	Cook	11			Ramp	S-2
460	S12055	Lake Shore Dr	S of Oakwood Blvd	Cook	12			Ramp	S-2
461	S12060	Lake Shore Dr	N of Oakwood Blvd	Cook	13			Ramp	S-2
462	S12065	Lake Shore Dr	S of 35th St	Cook	14			Ramp	S-2
463	S12070	Lake Shore Dr	S of 31st St	Cook	15			Ramp	S-2
464	S12075	Lake Shore Dr	N of 31st St	Cook	16			Ramp	S-2
465	S12080	Lake Shore Dr	S of 31st St	Cook	17			Ramp	S-2
466	S12085	Lake Shore Dr	N of 31st St	Cook	18			Ramp	S-2
467	S12090	Lake Shore Dr	25th St	Cook	19			Ramp	S-2
468	S12095	Lake Shore Dr	23rd St	Cook	20			Ramp	S-2
469	S12100	Lake Shore Dr	N of 23rd St	Cook	21			Ramp	S-2
470	S12105	Lake Shore Dr	N of 23rd St	Cook	MCD 7			Ramp	S-2
471	S12106	Lake Shore Dr	18th St	Cook	22		IB	Ramp	S-2
472	S12107	Lake Shore Dr	18th St	Cook	21A		OB	Ramp	S-2
473	S12110	Lake Shore Dr	S of McFetridge Dr	Cook	23			Ramp	S-2
474	S12115	Lake Shore Dr	S of Balbo Ave	Cook	24			Ramp	S-2
475	S12120	Lake Shore Dr	Jackson Blvd	Cook	25			Ramp	S-2
476	S13025	Lake Shore Dr	Randolph St	Cook	26			Ramp	S-2
477	S13030	Lake Shore Dr	Randolph St	Cook	27			Ramp	S-2
478	S13035	Lake Shore Dr	Randolph St	Cook	28			Ramp	S-2
479	S13040	Lake Shore Dr	Randolph St	Cook	29			Ramp	S-2
480	S13045	Lake Shore Dr	Wacker Dr	Cook	30			Ramp	S-2
481	S13050	Lake Shore Dr	Illinois St	Cook	31			Ramp	S-2

Ct	Loc #	Main Route	Nearest Cross Street	Co	Cab	Sign Label	Dir	Type of Equipment	RM Pay Item
482	S13055	Lake Shore Dr	Grand Ave	Cook	32			Ramp	S-2
483	S13060	Lake Shore Dr	Wacker Dr	Cook	33			Ramp	S-2
484	S13065	Lake Shore Dr	Erie St	Cook	34			Ramp	S-2
485	S13070	Lake Shore Dr	S of Chicago Ave	Cook	35			Ramp	S-2
486	S13075	Lake Shore Dr	Chicago Ave	Cook	36			Ramp	S-2
487	S13080	Lake Shore Dr	Chicago Ave	Cook	37			Ramp	S-2
488	S13085	Lake Shore Dr	Chestnut St	Cook	38			Ramp	S-2
489	S13090	Lake Shore Dr	Chestnut St	Cook	39			Ramp	S-2
490	S13095	Lake Shore Dr	Michigan Ave	Cook	40			Ramp	S-2
491	S13100	Lake Shore Dr	Michigan Ave	Cook	41			Ramp	S-2
492	S13105	Lake Shore Dr	Michigan Ave	Cook	42			Ramp	S-2
493	S13110	Lake Shore Dr	Division St	Cook	43			Ramp	S-2
494	S13115	Lake Shore Dr	Division St	Cook	44			Ramp	S-2
495	S13120	Lake Shore Dr	Division St	Cook	45			Ramp	S-2
496	S13125	Lake Shore Dr	North Ave	Cook	46			Ramp	S-2
497	S13130	Lake Shore Dr	North Ave	Cook	47			Ramp	S-2
498	S13135	Lake Shore Dr	North Ave	Cook	48			Ramp	S-2
499	S13140	Lake Shore Dr	North Ave	Cook	49			Ramp	S-2
500	S13145	Lake Shore Dr	North Ave	Cook	50			Ramp	S-2
501	S13150	Lake Shore Dr	Armitage Ave	Cook	51			Ramp	S-2
502	S13155	Lake Shore Dr	Fullerton Parkway	Cook	52			Ramp	S-2
503	S13160	Lake Shore Dr	Fullerton Parkway	Cook	53			Ramp	S-2
504	S13165	Lake Shore Dr	Fullerton Parkway	Cook	54			Ramp	S-2
505	S13170	Lake Shore Dr	Diversey Ave	Cook	55			Ramp	S-2
506	S13175	Lake Shore Dr	Diversey Ave	Cook	56			Ramp	S-2
507	S13180	Lake Shore Dr	Belmont Ave	Cook	57			Ramp	S-2
508	S13185	Lake Shore Dr	Belmont Ave	Cook	58			Ramp	S-2
509	S13190	Lake Shore Dr	Belmont Ave	Cook	59			Ramp	S-2
510	S13195	Lake Shore Dr	Belmont Ave	Cook	60			Ramp	S-2
511	S13200	Lake Shore Dr	Belmont Ave	Cook	61			Ramp	S-2
512	S13205	Lake Shore Dr	Addison St	Cook	62			Ramp	S-2
513	S13210	Lake Shore Dr	Addison St	Cook	63			Ramp	S-2
514	S13215	Lake Shore Dr	IL 19 (Irving Park Rd)	Cook	64			Ramp	S-2
515	S13220	Lake Shore Dr	IL 19 (Irving Park Rd)	Cook	65			Ramp	S-2
516	S13225	Lake Shore Dr	IL 19 (Irving Park Rd)	Cook	66			Ramp	S-2
517	S13230	Lake Shore Dr	IL 19 (Irving Park Rd)	Cook	67			Ramp	S-2
518	S13235	Lake Shore Dr	Montrose Ave	Cook	68			Ramp	S-2
519	S13240	Lake Shore Dr	Montrose Ave	Cook	69			Ramp	S-2
520	S13245	Lake Shore Dr	Wilson Ave	Cook	70			Ramp	S-2
521	S13250	Lake Shore Dr	Wilson Ave	Cook	71			Ramp	S-2
522	S13255	Lake Shore Dr	Wilson Ave	Cook	72			Ramp	S-2
523	S13260	Lake Shore Dr	Lawrence Ave	Cook	73			Ramp	S-2
524	S13265	Lake Shore Dr	Lawrence Ave	Cook	74			Ramp	S-2
525	S13270	Lake Shore Dr	Lawrence Ave	Cook	75			Ramp	S-2
526	S13275	Lake Shore Dr	Foster Ave	Cook	76			Ramp	S-2
527	S13280	Lake Shore Dr	Foster Ave	Cook	77			Ramp	S-2

Ct	Loc #	Main Route	Nearest Cross Street	Co	Cab	Sign Label	Dir	Type of Equipment	RM Pay Item
528	S13285	Lake Shore Dr	Foster Ave	Cook	78			Ramp	S-2
529	S13290	Lake Shore Dr	Bryn Mawr Ave	Cook	79			Ramp	S-2
530	S13295	Lake Shore Dr	Bryn Mawr Ave	Cook	80			Ramp	S-2
531	S13297	Lake Shore Dr	Bryn Mawr Ave	Cook	81			Ramp	S-2
532	S14015	Elgin O'Hare	Meacham Rd	Cook	5			Ramp	S-2
533	S14020	Elgin O'Hare	Plum Grove Rd	Cook	7			Ramp	S-2
534	S14025	Elgin O'Hare	1/2 Mi E of Roselle Rd	Cook	4			Ramp	S-2
535	S14030	Elgin O'Hare	E of Roselle Rd	Cook	6			Ramp	S-2
536	S14035	Elgin O'Hare	W of Roselle Rd	Cook	9			Ramp	S-2
537	S14040	Elgin O'Hare	E of Mitchell Blvd	Cook	11			Ramp	S-2
538	S14045	Elgin O'Hare	E of Wright Blvd	Cook	13			Ramp	S-2
539	S14050	Elgin O'Hare	E of Wright Blvd	Cook	8			Ramp	S-2
540	S14055	Elgin O'Hare	W of Wright Blvd	Cook	15			Ramp	S-2
541	S14060	Elgin O'Hare	IL 19 (Irving Park Rd)	Cook	10			Ramp	S-2
542	S14065	Elgin O'Hare	IL 19 (Irving Park Rd)	Cook	17			Ramp	S-2
543	S14070	Elgin O'Hare	Gary Ave	Cook	19			Ramp	S-2
544	S14075	Elgin O'Hare	Springinsguth Rd	Cook	21			Ramp	S-2
545	S14080	Elgin O'Hare	W of Springinsguth Rd	Cook	12			Ramp	S-2
546	S15000	I-80	I-294 Tollway	Cook	2			Ramp	S-2
547	S15005	I-80	Kedzie Ave	Cook	4E			Ramp	S-2
548	S15010	I-80	1/2 Mi W of Kedzie Ave	Cook	1			Ramp	S-2
549	S15015	I-80	Crawford Ave	Cook	6E			Ramp	S-2
550	S15020	I-80	1/2 Mi E of IL 50 (Cicero Ave)	Cook	8E			Ramp	S-2
551	S15025	I-80	IL 50 (Cicero Ave)	Cook	10			Ramp	S-2
552	S15030	I-80	E of I-57	Cook	3			Ramp	S-2
553	S15035	I-80	W of I-57	Cook	5			Ramp	S-2
554	S15040	I-80	Central Ave	Cook	7			Ramp	S-2
555	S15045	I-80	183rd St	Cook	12			Ramp	S-2
556	S15050	I-80	Ridgeland Ave	Cook	14			Ramp	S-2
557	S15055	I-80	Oak Park Ave	Cook	9			Ramp	S-2
558	S15060	I-80	E of IL 43 (Harlem Ave)	Cook	16			Ramp	S-2
559	S15067	I-80	IL 43 (Harlem Ave)	Cook	MCD 13			Ramp	S-2
560	S20005	IL 59 (Sutton Rd)	US 20 (Lake St)	Cook	1050			Ramp	S-2
561	S20010	I-90/94	51st St	Cook	1121			Ramp	S-2
562	S20015	I-90/94	51st St	Cook	1123			Ramp	S-2
563	S20020	US 6 (159th St)	Pulaski Rd / Crawford Ave	Cook	1170			Ramp	S-2
564	S20070	IL 43 (Harlem Ave)	Techny Rd	Cook	1280			Ramp	S-2
565	S20075	IL 68 (Dundee Rd)	Portwine Rd	Cook	1290			Ramp	S-2
566	S20085	IL 58 (Golf Rd)	Birch Ave	Cook	1260			Ramp	S-2
567	S20090	IL 50 (Cicero Ave)	S of 99th St	Cook	1200			Ramp	S-2
568	S20110	IL 7 (Southwest Highway)	131st St	Cook	1190			Ramp	S-2
569	S20115	US 14 (Northwest Highway)	W of Chatham Pl	Cook	1270			Ramp	S-2
570	S20120	Devon Ave	E of Arlington Heights Rd	Cook	1230			Ramp	S-2
571	S20160	Kedzie Ave	S of Touhy Ave	Cook	1250			Ramp	S-2
572	S20165	IL 72 (Higgins Rd)	E of I-294 Tollway	Cook	1240			Ramp	S-2
573	S20205	IL 83 (147th St / Sibley Blvd)	W of Minerva Ave	Cook	1180			Ramp	S-2

Ct	Loc #	Main Route	Nearest Cross Street	Co	Cab	Sign Label	Dir	Type of Equipment	RM Pay Item
574	S20210	Cossitt Ave	E of Sunset Ave	Cook	1210			Ramp	S-2
575	S20215	US 12/45 (Mannheim Rd)	Roadway Shipping Terminal Ent.	Cook	1220			Ramp	S-2
576	S22000	I-90	Nagle Ave	Cook	1110			Ramp	S-2
577	S22005	I-290	W of US 12/20/45 (Mannheim Rd)	Cook	1113			Ramp	S-2
578	S22025	I-80	3/4 Mi W of Kedzie Ave	Cook	1177			Ramp	S-2
579	S22030	I-57	IL 83 (147th St / Sibley Blvd)	Cook	1178			Ramp	S-2
580	S1330	I-55	W of County Line Rd	DuPage	59			Ramp	S-2
581	S1335	I-55	1 Mi W of County Line	DuPage	61			Ramp	S-2
582	S1340	I-55	Madison St	DuPage	63			Ramp	S-2
583	S1345	I-55	E of IL 83	DuPage	58			Ramp	S-2
584	S1350	I-55	W of IL 83	DuPage	60			Ramp	S-2
585	S1355	I-55	Clarendon Hills Rd	DuPage	65			Ramp	S-2
586	S1360	I-55	1/2 Mi W of Clarendon Hills Rd	DuPage	62			Ramp	S-2
587	S1365	I-55	E of Cass Ave	DuPage	64			Ramp	S-2
588	S1370	I-55	W of Cass Ave	DuPage	66			Ramp	S-2
589	S1375	I-55	1 Mi W of Cass Ave	DuPage	68			Ramp	S-2
590	S1380	I-55	1/2 Mi E of Lemont Rd	DuPage	67			Ramp	S-2
591	S1385	I-55	E of Lemont Rd	DuPage	70			Ramp	S-2
592	S1390	I-55	W of Lemont Rd	DuPage	72			Ramp	S-2
593	S1395	I-55	1/2 Mi W of Lemont Rd	DuPage	74			Ramp	S-2
594	S1400	I-55	Woodward Ave	DuPage	76			Ramp	S-2
595	S9050	I-290	CN RR / C & NW RR	DuPage	X84			Ramp	S-2
596	S9060	I-290	IL 64 (North Ave)	DuPage	X87			Ramp	S-2
597	S9065	I-290	IL 64 (North Ave)	DuPage	X88			Ramp	S-2
598	S9070	I-290	IL 64 (North Ave)	DuPage	X89			Ramp	S-2
599	S9080	I-290	IL 64 (North Ave)	DuPage	X91			Ramp	S-2
600	S9085	I-290	Emroy Ave	DuPage	X92			Ramp	S-2
601	S9090	I-290	York Rd & Lake St	DuPage	Y93			Ramp	S-2
602	S9095	I-290	York Rd & Lake St	DuPage	Y94			Ramp	S-2
603	S9100	I-290	York Rd & Lake St	DuPage	Y95			Ramp	S-2
604	S9105	I-290	York Rd & Lake St	DuPage	Y96			Ramp	S-2
605	S9110	I-290	York Rd & Lake St	DuPage	Y97			Ramp	S-2
606	S9115	I-290	Church Rd	DuPage	Y99			Ramp	S-2
607	S9120	I-290	Grand Ave	DuPage	Y98			Ramp	S-2
608	S9125	I-290	IL 83 (Kingery Highway)	DuPage	A100			Ramp	S-2
609	S9135	I-290	IL 83 (Kingery Highway)	DuPage	A102			Ramp	S-2
610	S9145	I-290	Wooddale Rd	DuPage	B105			Ramp	S-2
611	S9150	I-290	W of Wooddale Rd	DuPage	E107			Ramp	S-2
612	S9155	I-290	Addison Rd	DuPage	E109			Ramp	S-2
613	S9160	I-290	W of Addison Rd	DuPage	E104			Ramp	S-2
614	S9165	I-290	Mill Rd	DuPage	F111			Ramp	S-2
615	S9170	I-290	Itasca Rd	DuPage	G106			Ramp	S-2
616	S9175	I-290	Nordic Rd	DuPage	G110			Ramp	S-2
617	S9180	I-290	Nordic Rd	DuPage	J112			Ramp	S-2
618	S9185	I-290	Nordic Rd	DuPage	MCD 2			Ramp	S-2
619	S9190	I-290	N of IL 19 (Irving Park Rd)	DuPage	J114			Ramp	S-2

Ct	Loc #	Main Route	Nearest Cross Street	Co	Cab	Sign Label	Dir	Type of Equipment	RM Pay Item
620	S9195	I-290	1/2 Mi S of Thorndale Ave	DuPage	J113			Ramp	S-2
621	S9200	I-290	S of Thorndale Ave	DuPage	J116		IB	Ramp	S-2
622	S9205	I-290	S of Thorndale Ave	DuPage	J117		OB	Ramp	S-2
623	S9210	I-290	Thorndale Ave NE	DuPage	L119		IB	Ramp	S-2
624	S9215	I-290	Thorndale Ave NW	DuPage	K118		IB	Ramp	S-2
625	S9225	I-290	Devon Ave	DuPage	L121		OB	Ramp	S-2
626	S11000	I-290/I-355	Schick Rd	DuPage	G108			Ramp	S-2
627	S11005	I-290/I-355	US 20 (Lake St)	DuPage	I1			Ramp	S-2
628	S11010	I-290/I-355	US 20 (Lake St)	DuPage	I2			Ramp	S-2
629	S11015	I-290/I-355	US 20 (Lake St)	DuPage	I4			Ramp	S-2
630	S11020	I-290/I-355	Kings Point Dr	DuPage	I6			Ramp	S-2
631	S14000	Elgin O'Hare	IL 53 (Rohlwing Rd)	DuPage	1			Ramp	S-2
632	S14005	Elgin O'Hare	1/2 Mi W of IL 53 (Rohlwing Rd)	DuPage	2			Ramp	S-2
633	S14010	Elgin O'Hare	E of Meacham Rd	DuPage	3			Ramp	S-2
634	S14085	Elgin O'Hare	Metra RR Bridge	DuPage	14			Ramp	S-2
635	S14090	Elgin O'Hare	US 20 (Lake St)	DuPage	16			Ramp	S-2
636	S20025	IL 53	75th St	DuPage	1310			Ramp	S-2
637	S20030	IL 64 (North Ave)	IL 59 (Sutton Rd)	DuPage	1320			Ramp	S-2
638	S20060	IL 38 (Roosevelt Rd)	W of Finley Rd	DuPage	1330			Ramp	S-2
639	S20095	IL 83 (Kingery Highway)	N of 55th St	DuPage	1340			Ramp	S-2
640	S20125	Wooddale Ave	S of Mark St	DuPage	1350			Ramp	S-2
641	S20220	IL 59	S of 75th St	DuPage	1995			Ramp	S-2
642	S22015	I-290	IL 83 (Kingery Highway)	DuPage	1175			Ramp	S-2
643	S22020	I-55	Cass Ave	DuPage	1176			Ramp	S-2
644	S20035	IL 31 (Lincoln Way)	IL 56 (State St)	Kane	1420			Ramp	S-2
645	S20080	Peplow Rd	N of Ramm Rd	Kane	1430			Ramp	S-2
646	S20130	Galligan Rd	S of Freeman Rd	Kane	1440			Ramp	S-2
647	S20155	Campton Hills Rd	E of Lynn Dr	Kane	1450			Ramp	S-2
648	S4245	US 41 (Skokie Highway)	Lake Cook Rd	Lake	S58			Ramp	S-2
649	S4250	US 41 (Skokie Highway)	1/2 Mi N of Lake Cook Rd	Lake	T60			Ramp	S-2
650	S4255	US 41 (Skokie Highway)	Bob O Link Golf Club	Lake	T45			Ramp	S-2
651	S4260	US 41 (Skokie Highway)	Chantilly Blvd	Lake	T62			Ramp	S-2
652	S4265	US 41 (Skokie Highway)	Clavey Rd	Lake	T43			Ramp	S-2
653	S20000	US 12 / IL 59	IL134(Long Lake/Big Hollow Rd)	Lake	1040			Ramp	S-2
654	S20040	US 45	IL 176	Lake	1500			Ramp	S-2
655	S20045	IL 22 (Half Day Rd)	IL 83	Lake	1520			Ramp	S-2
656	S20065	IL 131 (Green Bay Rd)	S of 20th St	Lake	1530			Ramp	S-2
657	S20100	IL 59	S of Hillcrest Dr	Lake	1540			Ramp	S-2
658	S20135	Wilson Ave	N of Marshall Blvd	Lake	1550			Ramp	S-2
659	S20140	IL 176 (Park Ave)	E of Blue Spruce Ln	Lake	1560			Ramp	S-2
660	S20170	Lake St	W of West St	Lake	1570			Ramp	S-2
661	S20050	IL 31	US 14 (Northwest Highway)	McHenry	1610			Ramp	S-2
662	S20150	US 14	SE of Deep Cut Rd	McHenry	1620			Ramp	S-2
663	S1405	I-55	W of I-355	Will	80			Ramp	S-2
664	S1425	I-55	Joliet Rd	Will	69			Ramp	S-2
665	S1430	I-55	1/2 Mi W of Joliet Rd	Will	71			Ramp	S-2

Ct	Loc #	Main Route	Nearest Cross Street	Co	Cab	Sign Label	Dir	Type of Equipment	RM Pay Item
666	S1435	I-55	W of Upton Rd	Will	82			Ramp	S-2
667	S1440	I-55	2/3 Mi E of IL 53	Will	73			Ramp	S-2
668	S1445	I-55	E of IL 53	Will	84			Ramp	S-2
669	S1450	I-55	W of IL 53	Will	86			Ramp	S-2
670	S1455	I-55	E of Schmidt Rd	Will	88			Ramp	S-2
671	S1460	I-55	W of Schmidt Rd	Will	75			Ramp	S-2
672	S1465	I-55	1/2 Mi E of Naperville Rd	Will	90			Ramp	S-2
673	S1470	I-55	W of Naperville Rd	Will	92			Ramp	S-2
674	S15065	I-80	W of IL 43 (Harlem Ave)	Will	18			Ramp	S-2
675	S15070	I-80	76th St	Will	11			Ramp	S-2
676	S15075	I-80	80th Ave	Will	20			Ramp	S-2
677	S15080	I-80	187th St	Will	13			Ramp	S-2
678	S15085	I-80	E of Metra RR Bridge	Will	15			Ramp	S-2
679	S15090	I-80	W of Metra RR Bridge	Will	17			Ramp	S-2
680	S15095	I-80	E of US 45 (LaGrange Rd)	Will	22			Ramp	S-2
681	S15100	I-80	W of US 45 (LaGrange Rd)	Will	24			Ramp	S-2
682	S20055	US 45 (LaGrange Rd)	US 30 (Lincoln Highway)	Will	1730			Ramp	S-2
683	S20105	Independence Blvd	N of Taylor St	Will	1740			Ramp	S-2
684	S20145	IL 126 (Plainfield Rd)	N of 143rd St	Will	1750			Ramp	S-2
685	S20175	7th St	W of Peppermill Rd	Will	1760			Ramp	S-2
686	S20180	Manhattan Rd	1 Mi N of Elwood	Will	1770			Ramp	S-2
687	S20185	I-57	E of Kennedy Rd	Will	1780			Ramp	S-2
688	S20190	Peotone Beecher Rd	W of Kedzie Ave	Will	1790			Ramp	S-2
689	S20195	I-80	N of Shepley Rd / Holt Rd	Will	1850			Ramp	S-2
690	S20200	I-55	S of IL 113	Will	1860			Ramp	S-2
691	S22040	US 52 (Joliet Rd)	US 45 (LaGrange Rd)	Will	5182			Ramp	S-2

1	S1007	I-55	Martin Luther King Dr	Cook		DMS-7	OB	Sign	S-3
2	S1112	I-55	W of Kedzie Ave	Cook		DMS-5	IB	Sign	S-3
3	S1262	I-55	W of 1st Ave	Cook		DMS-23	IB	Sign	S-3
4	S2052	I-57	119th St	Cook		DMS-29	IB	Sign	S-3
5	S2265	I-57	S of I-80 (183rd St)	Cook		DMS-28	IB	Sign	S-3
6	S3096	I-90	Canfield Ave	Cook		DMS-19	IB	Sign	S-3
7	S3176	I-90	Foster Ave	Cook		DMS-18	IB	Sign	S-3
8	S3281	I-90/94	Pulaski Rd	Cook		DMS-17	IB	Sign	S-3
9	S3331	I-90/94 Reversible	Kimball Ave	Cook		DMS-16	IB	Sign	S-3
10	S3416	I-90/94 Reversible	Webster Ave	Cook		DMS-14	OB	Sign	S-3
11	S3417	I-90/94	Damen Ave	Cook		DMS-15	OB	Sign	S-3
12	S3482	I-90/94	Augusta Blvd	Cook		DMS-13	IB	Sign	S-3
13	S4086	I-94	Niles Center Rd	Cook		DMS-21	IB	Sign	S-3
14	S4206	I-94	Tower Rd	Cook		DMS-22	IB	Sign	S-3
15	S5052	I-94	83 rd St	Cook		DMS-2	IB	Sign	S-3
16	S5053	I-94	83 rd St	Cook		DMS-30	OB	Sign	S-3
17	S5186	I-90/94	57 th St (Locals)	Cook		DMS-03L	IB	Sign	S-3
18	S5187	I-90/94	57th St (Express)	Cook		DMS-03E	IB	Sign	S-3
19	S5196	I-90/94	55 th St (Locals)	Cook		DMS-31L	OB	Sign	S-3

Ct	Loc #	Main Route	Nearest Cross Street	Co	Cab	Sign Label	Dir	Type of Equipment	RM Pay Item
20	S5197	I-90/94	55 th St (Express)	Cook		DMS-31E	OB	Sign	S-3
21	S5292	I-90/94	39 th St (Locals)	Cook		DMS-32L	OB	Sign	S-3
22	S5293	I-90/94	39 th St (Express)	Cook		DMS-32E	OB	Sign	S-3
23	S5296	I-90/94	37 th St (Locals)	Cook		DMS-04L	IB	Sign	S-3
24	S5298	I-90/94	37 th St	Cook		DMS-04E	IB	Sign	S-3
25	S5377	I-90/94	S Branch of Chicago River	Cook		DMS-8	IB	Sign	S-3
26	S5406	I-90/94	Taylor St	Cook		DMS-9	OB	Sign	S-3
27	S5407	I-90/94 Median	Taylor St	Cook		DMS-10	IB	Sign	S-3
28	S5970	IL 394	186 th St	Cook		DMS-27	IB	Sign	S-3
29	S6103	I-94	145 th St	Cook		DMS-26	IB	Sign	S-3
30	S6104	I-94	145 th St	Cook		DMS-25	OB	Sign	S-3
31	S6177	I-94	119 th St	Cook		DMS-20	OB	Sign	S-3
32	S6178	I-94	124 th St	Cook		DMS-6	IB	Sign	S-3
33	S7001	I-80	State Line	Cook		DMS-1	IB	Sign	S-3
34	S8002	I-290	E of Old Post Office	Cook		DMS-12	IB	Sign	S-3
35	S8072	I-290	Damen Ave	Cook		DMS-11	IB	Sign	S-3
36	S1332	I-55	W of County Line Rd	DuPage		DMS-24	IB	Sign	S-3
37	S9252	I-290	N of Biesterfield Rd	DuPage		DMS-35	IB	Sign	S-3
38	S10029	IL 53	Industrial Ave	DuPage		DMS-36	IB	Sign	S-3
39	S1605	I-55	S of US 6	Will		DMS-33	IB	Sign	S-3
40	S1570	I-55	Caton Farm Rd	Will		DMS-34	IB	Sign	S-3

1	S1282	US 12/20/45 (LaGrange Rd) NB	S of I-55	Cook		DMS-104	IB	Sign	S-4
2	S1283	US 12/20/45 (LaGrange Rd) SB	N of I-55	Cook		DMS-105	OB	Sign	S-4
3	S4072	Touhy Ave WB	E of I-94	Cook		DMS-106	OB	Sign	S-4
4	S4073	Touhy Ave EB	W of I-94	Cook		DMS-107	IB	Sign	S-4
5	S22050	Grand Ave EB	77th Ave	Cook		DMS-101	IB	Sign	S-4
6	S22150	Stoney Island Ave SB	98 th Pl	Cook		DMS-108	OB	Sign	S-4
7	S22200	US 6 (159 th St) EB	W of Crawford Ave	Cook		DMS-109	IB	Sign	S-4
8	S22250	US 6 (159 th St) WB	W of Dixie Hwy	Cook		DMS-110	OB	Sign	S-4
9	S22350	US 45 (Mannheim Rd) NB	S of I-290	Cook		DMS-113	IB	Sign	S-4
10	S22400	US 45 (Mannheim Rd) SB	N of I-290	Cook		DMS-114	OB	Sign	S-4
11	S22450	US 45 (Mannheim Rd) SB	N of I-190	Cook		DMS-115	IB	Sign	S-4
12	S9132	IL 83 (Kingery Highway) NB	S of US 20	DuPage		DMS-102	OB	Sign	S-4
13	S9133	IL 83 (Kingery Highway) SB	N of I-290	DuPage		DMS-103	IB	Sign	S-4
14	S22100	US 41 (Skokie Hwy)	S of West Park Ave	Lake		DMS-111	OB	Sign	S-4
15	S22300	US 41 (Skokie Hwy)	S of IL 22 (Half Day Rd)	Lake		DMS-112	OB	Sign	S-4

Count	Grd Date	Loc #	Main Route	Nearest Cross Street	County	RM Pay Item
1		TS5	IL 43 (Harlem Ave)	I-55 N Ramps	Cook	T-1A
2		TS10	I-55	Central Ave	Cook	T-1A
3		TS15	IL 43 (Harlem Ave)	I-55 S Ramps	Cook	T-1A
4		TS20	I-57	Ashland Ave / 119th St	Cook	T-1A
5		TS22	Kedzie Ave	131st St	Cook	T-1A
6		TS25	127th St / I-57 E Ramps	Marshfield Ave	Cook	T-1A
7		TS30	I-57 W Ramps	IL 83 / 147th St / Sibley Blvd	Cook	T-1A
8		TS35	127th St / I-57 W Ramps	Paulina St	Cook	T-1A
9	03	TS45	Dixie Highway	I-80 Tollway	Cook	T-1A
10	03	TS48	171st St	Dixie Highway	Cook	T-1A
11		TS50	I-80	Kedzie Ave N Ramp	Cook	T-1A
12		TS60	IL 43 (Waukegan Rd)	I-94 Edens Tlwy Spur North	Cook	T-1A
13		TS61	IL 43 (Waukegan Rd)	I 94 Edens Tlwy Spur South	Cook	T-1A
14		TS65	I-94 / Estes Ave	IL 50 (Cicero Ave)	Cook	T-1A
15		TS75	I-290 S Frontage Rd / Harrison St	US 12/20/45 (Mannheim Rd)	Cook	T-1A
16		TS77	I-290 EB Exit Ramp F	US 12/20/45 (Mannheim Rd)	Cook	T-1A
17		TS80	I-290 WB Exit Ramps B & G	US 12/20/45 (Mannheim Rd)	Cook	T-1A
18		TS85	I-290	IL 43 (Harlem Ave)	Cook	T-1A
19		TS90	I-290/IL 53 E Frontage Rd	IL 58 (Golf Rd)	Cook	T-1A
20		TS91	I-290/IL 53 W Frontage Rd	IL 58 (Golf Rd)	Cook	T-1A
21		TS95	I-290/IL 53 W Frontage Rd	IL 72 (Higgins Rd)	Cook	T-1A
22		TS96	I-290/IL 53 E Frontage Rd	IL 72 (Higgins Rd)	Cook	T-1A
23		TS100	IL 171 (1st Ave)	I-290 / Harrison St	Cook	T-1A
24		TS105	I-290 / Harrison St	17th Ave	Cook	T-1A
25		TS110	I-290	Austin Blvd	Cook	T-1A
26		TS115	I-290 / Harrison St	Des Plaines Ave	Cook	T-1A
27	02	TS125	IL 50 (Cicero Ave)	128th St	Cook	T-1A
28	05	TS130	22nd St / Cermak Rd	I-294 Tollway E Ramps	Cook	T-1A
29	05	TS135	22nd St / Cermak Rd	I-294 Tollway W Ramps	Cook	T-1A
30		TS140	Willow Rd	I-294 Tollway E Ramps	Cook	T-1A
31		TS145	Willow Rd	I-294 Tollway W Ramps	Cook	T-1A
32	01	TS150	US 6 (159th St)	US 45 (LaGrange Rd)	Cook	T-1A
33		TS155	US 6 (159th St)	IL 1 (Halsted St)	Cook	T-1A
34		TS156	179th St	Wolf Rd	Cook	T-1A
35		TS158	IL 7 (Wolf Rd)	151st St	Cook	T-1A
36		TS159	IL 7 (Wolf Rd)	153rd St	Cook	T-1A
37	04	TS160	US 6 (159th St)	IL 7 (Wolf Rd) North Junction	Cook	T-1A
38	04	TS161	US 6 (Wolf Rd)	US 6 (173rd St) South Junction	Cook	T-1A
39	03	TS162	US 6 (Wolf Rd)	Brookhill Dr	Cook	T-1A
40	06	TS163	IL 7 (159th St)	Will Cook Rd	Cook	T-1A
41	01	TS165	US 6 (159th St)	IL 43 (Harlem Ave)	Cook	T-1A
42	04	TS170	US 6 (159th St)	IL 50 (Cicero Ave)	Cook	T-1A
43	04	TS175	US 6 (159th St)	IL 83 (Torrence Ave)	Cook	T-1A
44	01	TS180	US 6 (159th St)	76th Ave	Cook	T-1A
45	01	TS185	US 6 (159th St)	80th Ave	Cook	T-1A
46	02	TS190	US 6 (159th St)	94th St	Cook	T-1A

Count	Grd Date	Loc #	Main Route	Nearest Cross Street	County	RM Pay Item
47		TS195	US 6/IL 83 (Torrence Ave)	170th St	Cook	T-1A
48	04	TS200	US 6 (159th St)	Carse Ave	Cook	T-1A
49	01	TS205	US 6 (159th St)	Central Ave	Cook	T-1A
50	02	TS210	US 6 (159th St)	Cottage Grove Ave	Cook	T-1A
51	04	TS215	US 6 (159th St)	Crawford Ave / Pukaski Rd	Cook	T-1A
52		TS220	US 6 (159th St)	Dixie Highway	Cook	T-1A
53		TS225	US 6 (159th St)	Ellis Ave	Cook	T-1A
54		TS230	US 6 (159th St)	Greenwood Rd	Cook	T-1A
55	01	TS235	US 6 (159th St)	71st Ct	Cook	T-1A
56	01	TS240	US 6 (159th St)	84th Ave	Cook	T-1A
57	04	TS245	US 6 (159th St)	Kedzie Ave	Cook	T-1A
58	03	TS250	US 6 (159th St)	Myrtle Ave	Cook	T-1A
59	01	TS255	US 6 (159th St)	Oak Park Ave	Cook	T-1A
60	03	TS265	US 6 (159th St)	Park Ave / River Oaks Golf Course Ent	Cook	T-1A
61	03	TS270	US 6 (159th St)	Paxton Ave	Cook	T-1A
62	01	TS275	US 6 (159th St)	Ridgeland Ave	Cook	T-1A
63	03	TS280	US 6 (159th St)	Ring Rd	Cook	T-1A
64	02	TS285	US 6 (159th St)	School St	Cook	T-1A
65	04	TS290	US 6 (159th St)	South Park Ave / Chicago Rd	Cook	T-1A
66		TS293	US 6 (159th St)	Wausau Ave	Cook	T-1A
67	04	TS295	US 6 (159th St)	State St / Indiana Ave	Cook	T-1A
68	02	TS300	US 6 (159th St)	Thornton Blue Island Rd	Cook	T-1A
69		TS305	US 6 (159th St)	Van Dam Rd	Cook	T-1A
70	03	TS310	US 6 (159th St)	Vincennes Ave / Vandrunen Rd	Cook	T-1A
71		TS315	US 6 (159th St)	Wood St	Cook	T-1A
72		TS320	US 6 (159th St)	Woodlawn Ave	Cook	T-1A
73	01	TS325	US 6 (159th St)	Laramie Ave	Cook	T-1A
74	02	TS326	IL 21 (Milwaukee Ave)	US 14 (Dempster St)	Cook	T-1A
75	01	TS330	US 6 (159th St)	88th Ave	Cook	T-1A
76	02	TS345	US 6/IL 83 (Torrence Ave)	River Oaks South Entrance	Cook	T-1A
77	02	TS350	US 6/IL 83 (Torrence Ave)	River Oaks Center Entrance	Cook	T-1A
78	02	TS355	US 6/IL 83 (Torrence Ave)	River Oaks North Entrance	Cook	T-1A
79		TS365	US 12 (Rand Rd)	US 12/45 (Des Plaines River Rd)	Cook	T-1A
80		TS370	US 12 (Rand Rd)	US 12 (Elk Blvd)	Cook	T-1A
81		TS375	US 12 (Rand Rd)	US 58 (Golf Rd)	Cook	T-1A
82	01	TS380	US 12 (Rand Rd)	IL 83 Elmhurst Rd & Foundry Rd	Cook	T-1A
83	04	TS385	US 12 (Rand Rd)	Baldwin Ct / Williams Dr	Cook	T-1A
84	04	TS390	US 12 (Rand Rd)	Camp McDonald Rd	Cook	T-1A
85	04	TS392	US 12 (Rand Rd)	Schoenbeck Rd	Cook	T-1A
86	04	TS395	US 12 (Rand Rd)	Euclid St	Cook	T-1A
87	04	TS400	US 12 (Rand Rd)	Hintz Rd	Cook	T-1A
88	04	TS405	US 12 (Rand Rd)	Kennicott Dr	Cook	T-1A
89	08	TS410	US 12 (Rand Rd)	Lake Cook Road	Cook	T-1A
90	04	TS415	US 12 (Rand Rd)	Clarence Ave / Dryden Ave	Cook	T-1A
91	04	TS419	US 12 (Rand Rd)	Olive St	Cook	T-1A
92	04	TS420	US 12 (Rand Rd)	Thomas Ave / Willow Rd	Cook	T-1A
93	04	TS421	US 12 (Rand Rd)	Beverly Ln	Cook	T-1A

Count	Grd Date	Loc #	Main Route	Nearest Cross Street	County	RM Pay Item
94	04	TS425	US 12 (Rand Rd)	Wolf Rd	Cook	T-1A
95	02	TS427	US 12/20 (95th St)	I-294 Tollway Ramp B	Cook	T-1A
96		TS430	US 12/20 (95th St)	US 12/20/45 (La Grange Rd)	Cook	T-1A
97	01	TS435	US 12/20 (95th St)	IL 50 (Cicero Ave)	Cook	T-1A
98	02	TS440	US 12/20 (95th St)	52nd Ave	Cook	T-1A
99	02	TS445	US 12/20 (95th St)	54th Ave	Cook	T-1A
100	02	TS450	US 12/20 (95th St)	78th Ave	Cook	T-1A
101	01	TS460	US 12/20 (95th St)	Campbell Ave	Cook	T-1A
102	01	TS465	US 12/20 (95th St)	Central Ave	Cook	T-1A
103	02	TS470	US 12/20 (95th St)	Chicago Ridge Mall Drive	Cook	T-1A
104	01	TS475	US 12/20 (95th St)	Cook Ave	Cook	T-1A
105	02	TS480	US 12/20 (95th St)	Crawford Ave / Pukaski Rd	Cook	T-1A
106	01	TS481	US 12/20 (95th St)	Keeler Ave	Cook	T-1A
107	02	TS485	US 12/20 (95th St)	Kedzie Ave	Cook	T-1A
108	01	TS490	US 12/20 (95th St)	Kostner Ave	Cook	T-1A
109	02	TS495	US 12/20 (95th St)	K Mart Entrance	Cook	T-1A
110	01	TS500	US 12/20 (95th St)	Millard Ave	Cook	T-1A
111		TS502	US 20 (Lake St)	Naperville Rd	Cook	T-1A
112		TS503	US 20 (Lake St)	Rose Ln / Lambert	Cook	T-1A
113	02	TS505	US 12/20 (95th St)	Chicago Ridge Mall Drive	Cook	T-1A
114	02	TS510	US 12/20 (95th St)	Oak Park Ave	Cook	T-1A
115	01	TS515	US 12/20 (95th St)	Melvina Ave	Cook	T-1A
116	01	TS520	US 12/20 (95th St)	Ridgeland Ave	Cook	T-1A
117	02	TS525	US 12/20 (95th St)	Roberts Rd	Cook	T-1A
118	03	TS530	US 12/20 (95th St)	IL 7 (Southwest Highway)	Cook	T-1A
119	03	TS535	US 12/20 (95th St)	Western Ave	Cook	T-1A
120	01	TS540	US 12/20 (95th St)	Homan Ave	Cook	T-1A
121		TS741	IL 19 (Irving Park Rd)	Schaes Parkway	Cook	T-1A
122	04	TS742	IL 19 (Irving Park Rd)	Poplar Creek Dr	Cook	T-1A
123		TS743	IL 19 (Irving Park Rd)	Rohrsen Rd	Cook	T-1A
124	04	TS744	IL 19 (Irving Park Rd)	Schaumburg Rd	Cook	T-1A
125	03	TS1007	123rd St / McCarthy Rd	Will Cook Rd	Cook	T-1A
126		TS1009	123rd St / McCarthy Rd	Bell Rd	Cook	T-1A
127	01	TS1010	US 12/20/45 (Mannheim Rd)	US 20 (Lake St)	Cook	T-1A
128		TS1011	123rd St / McCarthy Rd	Wolf Rd	Cook	T-1A
129		TS1015	US 12/20/45 (Mannheim Rd)	IL 38 (Roosevelt Rd)	Cook	T-1A
130	01	TS1020	US 12/20/45 (Mannheim Rd)	Washington Blvd	Cook	T-1A
131	01	TS1022	IL 59 (Sutton Rd)	US 20 (Lake St) N Ramps	Cook	T-1A
132	01	TS1023	IL 59 (Sutton Rd)	US 20 (Lake St) S Ramps	Cook	T-1A
133		TS1025	US 12/20/45 (LaGrange Rd)	31st St	Cook	T-1A
134	01	TS1030	US 12/20/45 (LaGrange Rd)	47th St	Cook	T-1A
135	02	TS1035	US 12/20/45 (LaGrange Rd)	55th St	Cook	T-1A
136	02	TS1040	US 12/20/45 (LaGrange Rd)	67th St	Cook	T-1A
137	02	TS1043	US 12/20/45 (LaGrange Rd)	63rd St	Cook	T-1A
138		TS1045	US 12/20/45 (LaGrange Rd)	87th St	Cook	T-1A
139	01	TS1050	US 12/20/45 (LaGrange Rd)	22nd St / Cermak Rd	Cook	T-1A
140		TS1055	US 12/20/45 (LaGrange Rd)	Countryside Plaza Entrance	Cook	T-1A

Count	Grd Date	Loc #	Main Route	Nearest Cross Street	County	RM Pay Item
141	01	TS1060	US 12/20/45 (LaGrange Rd)	Joliet Rd	Cook	T-1A
142		TS1065	US 12/20/45 (LaGrange Rd)	Plainfield Rd	Cook	T-1A
143	01	TS1070	US 12/20/45 (Mannheim Rd)	Randolph St	Cook	T-1A
144	01	TS1075	US 12/20/45 (Mannheim Rd)	St Charles Rd	Cook	T-1A
145	01	TS1080	US 12/20/45 (Mannheim Rd)	Madison St	Cook	T-1A
146		TS1085	US 12/45 (Lee St)	US 45 (Des Plaines River Rd)	Cook	T-1A
147		TS1090	US 12/45 (Elk Blvd)	US 45 (Des Plaines River Rd)	Cook	T-1A
148	01	TS1095	US 12/45 (Mannheim Rd)	IL 19 (Irving Park Rd)	Cook	T-1A
149		TS1100	US 12/45 (Mannheim Rd)	IL 72 (Higgins Rd)	Cook	T-1A
150		TS1102	IL 72 (Higgins Rd)	Willow Creek Health Club Entrance	Cook	T-1A
151	01	TS1105	US 12/45 (Mannheim Rd)	Armitage Ave	Cook	T-1A
152	01	TS1110	US 12/45 (Mannheim Rd)	Fullerton Ave	Cook	T-1A
153		TS1114	US 12/45 (Mannheim Rd)	Wrightwood Ave	Cook	T-1A
154	01	TS1115	US 12/45 (Mannheim Rd)	Melrose Crossing N Entrance	Cook	T-1A
155	01	TS1120	US 12/45 (Mannheim Rd)	Melrose Crossing S Entrance	Cook	T-1A
156		TS1125	US 12/45 (Mannheim Rd)	Lawrence Ave	Cook	T-1A
157	04	TS1130	US 12/45 (Lee St)	Oakton St	Cook	T-1A
158	04	TS1135	US 12/45 (Mannheim Rd)	Touhy Ave	Cook	T-1A
159		TS1137	US 12/45 (Mannheim Rd)	Lunt Ave	Cook	T-1A
160	01	TS1140	US 12/45 (Mannheim Rd)	United Parkway	Cook	T-1A
161	02	TS1145	US 12/45 (Mannheim Rd)	Montrose Ave / O'Hare Access Rd	Cook	T-1A
162	04/08	TS1150	US 12/IL 53 (Rand Rd)	IL 53 (Hicks Rd)	Cook	T-1A
163		TS1155	US 12/IL 53 (Rand Rd)	IL 53/IL 68 (Dundee Rd)	Cook	T-1A
164	04	TS1157	IL 68 (Dundee Rd)	Lynda Dr / Access Dr	Cook	T-1A
165	04	TS1160	US 12/IL 53 (Rand Rd)	Old Hicks Rd / Coach Rd	Cook	T-1A
166		TS1165	US 14/IL 58 (Dempster St)	US 14/IL 43 (Waukegan Rd)	Cook	T-1A
167		TS1170	US 14 (Northwest Highway)	US 14 (Baldwin Rd)	Cook	T-1A
168		TS1172	US 14 (Northwest Highway)	Sterling Ave	Cook	T-1A
169		TS1175	US 14 (Caldwell Ave)	US 14/IL 43 (Waukegan Rd)	Cook	T-1A
170	04	TS1180	US 14 (Northwest Highway)	IL 53 E Ramp	Cook	T-1A
171	04	TS1185	US 14 (Northwest Highway)	IL 53 W Ramp	Cook	T-1A
172		TS1190	US 14 (Northwest Highway)	Benton St	Cook	T-1A
173	02	TS1200	US 14 (Dempster St)	Cumberland Ave	Cook	T-1A
174	02	TS1205	US 14 (Dempster St)	Dee Rd	Cook	T-1A
175	02	TS1210	US 14 (Dempster St)	Greenwood Rd	Cook	T-1A
176	02	TS1213	US 14 (Dempster St)	Western Ave	Cook	T-1A
177		TS1215	US 14 (Caldwell Ave)	Gross Point Rd	Cook	T-1A
178		TS1220	US 14 (Dempster St)	Harlem Ave	Cook	T-1A
179		TS1225	US 14 (Northwest Highway)	Hicks Rd S Jct / Linden Ave	Cook	T-1A
180	04	TS1230	US 14 (Caldwell Ave)	Howard St	Cook	T-1A
181	04	TS1235	US 14 (Northwest Highway)	Hicks Pl / Lincoln St	Cook	T-1A
182	02	TS1240	US 14 (Dempster St)	Luther Ln	Cook	T-1A
183		TS1245	US 14 (Northwest Highway)	Lake Cook Rd	Cook	T-1A
184	04	TS1250	US 14 (Northwest Highway)	US Post Office Entrance	Cook	T-1A
185		TS1255	US 14 (Northwest Highway)	Mt Prospect Rd	Cook	T-1A
186		TS1260	US 14 (Caldwell Ave)	Oakton St	Cook	T-1A
187		TS1265	US 14 (Dempster St)	Ozark St	Cook	T-1A

Count	Grd Date	Loc #	Main Route	Nearest Cross Street	County	RM Pay Item
188		TS1270	US 14 (Northwest Highway)	Palatine Rd	Cook	T-1A
189	02	TS1275	US 14 (Dempster St)	Potter Rd	Cook	T-1A
190		TS1280	US 14 (Baldwin Rd)	Quentin Rd	Cook	T-1A
191		TS1285	US 14 (Miner St)	Rand Rd	Cook	T-1A
192		TS1290	US 14 (Northwest Highway)	Rohlwing Rd	Cook	T-1A
193		TS1295	US 14 (Dempster St)	Shermer Rd	Cook	T-1A
194		TS1300	US 14 (Northwest Highway)	Smith Rd	Cook	T-1A
195		TS1305	US 14 (Caldwell Ave)	Touhy Ave	Cook	T-1A
196		TS1310	US 14 (Northwest Highway)	Wilke Rd	Cook	T-1A
197		TS1315	US 14 (Northwest Highway)	Plum Grove Rd	Cook	T-1A
198		TS1320	US 20 (Lake St)	Bluff City Rd	Cook	T-1A
199		TS1325	US 20 (Lake St)	Oak Ave	Cook	T-1A
200		TS1330	US 20 (Lake St)	Park Ave	Cook	T-1A
201	01	TS1335	US 20 (Lake St)	44th Ave	Cook	T-1A
202		TS1338	US 20 (Lake St)	I-294 Tollway Ramp	Cook	T-1A
203	04	TS1340	US 30 (Lincoln Highway)	US 30/IL 83 (Glenwood Dyer Rd)	Cook	T-1A
204		TS1345	IL 1 (Chicago Rd)	US 30 (Lincoln Highway)	Cook	T-1A
205	03	TS1350	US 30 (Lincoln Highway)	IL 43 (Harlem Ave)	Cook	T-1A
206	03	TS1355	US 30 (Lincoln Highway)	IL 50 (Cicero Ave)	Cook	T-1A
207		TS1357	IL 50 Cicero Ave	207 th	Cook	T-1A
208		TS1360	US 30 (Lincoln Highway)	Cottage Grove Ave	Cook	T-1A
209	03	TS1365	US 30 (Lincoln Highway)	Division St	Cook	T-1A
210		TS1370	US 30 (Lincoln Highway)	Ford Motor Plant Entrance	Cook	T-1A
211		TS1375	US 30 (Lincoln Highway)	Governors Highway / Crawford Ave	Cook	T-1A
212	03	TS1376	Governors Highway	212th Pl	Cook	T-1A
213		TS1380	US 30 (Lincoln Highway)	Halsted St	Cook	T-1A
214	03	TS1385	US 30 (Lincoln Highway)	Main St	Cook	T-1A
215	03	TS1390	US 30 (Lincoln Highway)	Olympian Way	Cook	T-1A
216	03	TS1395	US 30 (Lincoln Highway)	Orchard Dr	Cook	T-1A
217		TS1400	US 30 (Lincoln Highway)	Ridgeland Ave	Cook	T-1A
218	03	TS1405	US 30/IL 83 (Glenwood Dyer Rd)	Sauk Trail Rd	Cook	T-1A
219	03	TS1410	US 30 (Lincoln Highway)	State St	Cook	T-1A
220		TS1415	US 30 (Lincoln Highway)	Torrence Ave	Cook	T-1A
221	04	TS1420	US 30 (Lincoln Highway)	Western Ave	Cook	T-1A
222		TS1425	US 30 (Lincoln Highway)	Woodlawn Ave	Cook	T-1A
223	03	TS1430	US 30 (Lincoln Highway)	Lindenwood Dr / Lincoln Mall Entrance	Cook	T-1A
224	03	TS1435	US 30 (Lincoln Highway)	Ashland Ave	Cook	T-1A
225		TS1437	US 30 (Lincoln Highway)	Access Rd / Transportation Dr	Cook	T-1A
226		TS1440	US 30 (Lincoln Highway)	Brookwood Dr	Cook	T-1A
227	03	TS1445	US 30 (Lincoln Highway)	Hilltop Ave	Cook	T-1A
228	03	TS1450	US 30 (Lincoln Highway)	Kostner Ave	Cook	T-1A
229	03	TS1455	US 34 (Ogden Ave)	IL 43 (Harlem Ave)	Cook	T-1A
230		TS1460	US 34 (Ogden Ave)	39th St / Miller Rd	Cook	T-1A
231	02	TS1465	US 34 (Ogden Ave)	Gilbert Ave / Nazareth Academy Entrance	Cook	T-1A
232		TS1470	US 34 (Ogden Ave)	Joliet Rd	Cook	T-1A
233	02	TS1480	US 34 (Ogden Ave)	Wolf Rd	Cook	T-1A
234		TS1485	US 41 (Lincoln Ave)	US 41/IL 50 (Cicero Ave)	Cook	T-1A

Count	Grd Date	Loc #	Main Route	Nearest Cross Street	County	RM Pay Item
235		TS1490	IL 58 (Dempster St)	US 41 (Skokie Blvd)	Cook	T-1A
236		TS1495	US 41 (Skokie Blvd)	Church St	Cook	T-1A
237		TS1500	US 41 (Lincoln Ave)	Crawford Ave	Cook	T-1A
238		TS1505	US 41 (Lincoln Ave)	Devon Ave	Cook	T-1A
239	02	TS1510	US 41 (Skokie Blvd)	East Lake Ave	Cook	T-1A
240	02	TS1515	US 41 (Skokie Blvd)	Edens Plaza SC Entrance	Cook	T-1A
241		TS1520	US 41 (Skokie Blvd)	Emerson St	Cook	T-1A
242		TS1525	US 41 (Skokie Blvd)	Golf Rd	Cook	T-1A
243		TS1530	US 41 (Skokie Blvd)	Gross Point Rd	Cook	T-1A
244	02	TS1535	US 41 (Skokie Blvd)	Hibbard Rd	Cook	T-1A
245		TS1540	US 41 (Skokie Blvd)	Howard St	Cook	T-1A
246		TS1545	US 41 (Lincoln Ave)	Kostner Ave	Cook	T-1A
247		TS1555	US 41 (Skokie Blvd)	Foster Ave	Cook	T-1A
248		TS1560	US 41 (Skokie Blvd)	Main St	Cook	T-1A
249	02	TS1565	US 41 (Skokie Blvd)	New Glenview Rd	Cook	T-1A
250		TS1570	US 41 (Skokie Blvd)	Niles Center Rd	Cook	T-1A
251	04	TS1574	Niles Center Rd	Fargo Ave	Cook	T-1A
252		TS1575	US 41 (Skokie Blvd)	Oakton St	Cook	T-1A
253	02	TS1580	US 41 (Skokie Blvd)	Old Glenview Rd	Cook	T-1A
254		TS1590	US 41 (Skokie Blvd)	Old Orchard Rd	Cook	T-1A
255		TS1595	US 41 (Skokie Blvd)	Old Orchard North Entrance	Cook	T-1A
256		TS1600	US 41 (Skokie Blvd)	Old Orchard Center Entrance	Cook	T-1A
257		TS1605	US 41 (Skokie Blvd)	Old Orchard South Entrance	Cook	T-1A
258		TS1610	US 41 (Lincoln Ave)	Pratt Ave	Cook	T-1A
259		TS1613	Crawford Ave	Pratt Ave	Cook	T-1A
260		TS1615	US 41 (Lincoln Ave)	Touhy Ave	Cook	T-1A
261		TS1617	IL 72 (Touhy Ave)	Kilbourn Ave	Cook	T-1A
262	02	TS1620	US 41 (Skokie Blvd)	Wilmette Ave	Cook	T-1A
263		TS1625	US 45 (Des Plaines River Rd)	IL 58 (Golf Rd)	Cook	T-1A
264		TS1626	US 45 (Des Plaines River Rd)	Nazareth Way / Holy Family Hospital	Cook	T-1A
265		TS1630	US 45 (LaGrange Rd)	107th St	Cook	T-1A
266	01	TS1631	111th St	84th Ave	Cook	T-1A
267	03	TS1632	111th St	Kean Ave	Cook	T-1A
268	03	TS1633	104th Ave	107th St	Cook	T-1A
269		TS1635	US 45 (LaGrange Rd)	111th St	Cook	T-1A
270	02	TS1640	US 45 (LaGrange Rd)	131st St	Cook	T-1A
271		TS1645	US 45 (LaGrange Rd)	135th St	Cook	T-1A
272	01	TS1650	US 45 (LaGrange Rd)	143rd St	Cook	T-1A
273	01	TS1655	US 45 (LaGrange Rd)	147th St	Cook	T-1A
274	02	TS1660	US 45 (LaGrange Rd)	149th St	Cook	T-1A
275	02	TS1665	US 45 (LaGrange Rd)	151st St	Cook	T-1A
276	02	TS1670	US 45 (LaGrange Rd)	153rd St	Cook	T-1A
277	04	TS1675	US 45 (Des Plaines River Rd)	Central Rd	Cook	T-1A
278		TS1676	Central Rd	East River Rd	Cook	T-1A
279		TS1677	Central Rd	Oakton Community College Entrance	Cook	T-1A
280	04	TS1680	US 45 (Des Plaines River Rd)	Euclid Ave / West Lake Ave	Cook	T-1A
281	04	TS1685	US 45 (Des Plaines River Rd)	Kensington Rd / Foundry Rd	Cook	T-1A

Count	Grd Date	Loc #	Main Route	Nearest Cross Street	County	RM Pay Item
282		TS1690	US 45 (LaGrange Rd)	McCarthy Rd / 123rd St	Cook	T-1A
283	04	TS1695	US 45 (Des Plaines River Rd)	Old Willow Rd / Seminole Ln	Cook	T-1A
284	01	TS1700	US 45 (LaGrange Rd)	167th St	Cook	T-1A
285	04	TS1701	US 45 (LaGrange Rd)	163rd St	Cook	T-1A
286	02	TS1705	US 45 (LaGrange Rd)	Lakeview Plaza Dr	Cook	T-1A
287	02	TS1710	US 45 (LaGrange Rd)	Carl Sandburg High School Entrance	Cook	T-1A
288	04	TS1712	US 45 (Des Plaines River Rd)	Camp McDonald Rd	Cook	T-1A
289		TS1715	US 45/IL 21 (Milwaukee Ave)	IL 68 (Dundee Rd)	Cook	T-1A
290	04	TS1720	US 45/IL 21 (Milwaukee Ave)	Hintz Rd	Cook	T-1A
291	08	TS1724	US 45/IL 21 (Milwaukee Ave)	Lake Cook Rd S Ramps	Cook	T-1A
292	08	TS1726	US 45/IL 21 (Milwaukee Ave)	Lake Cook Rd N Ramps	Cook	T-1A
293	08	TS1730	US 45/IL 21 (Milwaukee Ave)	Wolf Rd	Cook	T-1A
294	04	TS1735	US 45/IL 21 (Milwaukee Ave)	Apple Dr	Cook	T-1A
295		TS1740	US 45/IL 21 (Milwaukee Ave)	Palatine Rd N Ramps	Cook	T-1A
296		TS1745	US 45/IL 21 (Milwaukee Ave)	Palatine Rd S Ramps	Cook	T-1A
297	01	TS1750	US 45 (LaGrange Rd)	144th Pl	Cook	T-1A
298	04	TS1755	IL 1 (Halsted St)	IL 1 (Halsted St) Cutoff / Parkside Ave	Cook	T-1A
299		TS1760	IL 1 (Halsted St)	IL 1 (Vincennes Rd)	Cook	T-1A
300	03	TS1765	IL 83/147th St/SibleyBlvd	IL 1 (Halsted St)	Cook	T-1A
301	04	TS1770	IL 1 (Chicago Rd)	15th St	Cook	T-1A
302	04	TS1775	IL 1 (Chicago Rd)	16th St	Cook	T-1A
303		TS1780	IL 1 (Chicago Rd)	26th St	Cook	T-1A
304		TS1785	IL 1 (Halsted St)	123rd St	Cook	T-1A
305	04	TS1790	IL 1 (Halsted St)	127th St	Cook	T-1A
306	04	TS1795	IL 1 (Halsted St)	138th St	Cook	T-1A
307	03	TS1800	IL 1 (Halsted St)	149th St	Cook	T-1A
308	03	TS1805	IL 1 (Halsted St)	152nd St	Cook	T-1A
309	03	TS1810	IL 1 (Halsted St)	157th St	Cook	T-1A
310	03	TS1815	IL 1 (Halsted St)	163rd St	Cook	T-1A
311		TS1820	IL 1 (Halsted St)	167th St	Cook	T-1A
312	04	TS1825	IL 1 (Halsted St)	171st St	Cook	T-1A
313		TS1830	IL 1 (Halsted St)	183rd St	Cook	T-1A
314	04	TS1835	IL 1 (Halsted St)	Holbrook Rd	Cook	T-1A
315	04	TS1840	IL 1 (Halsted St)	187th St	Cook	T-1A
316	04	TS1845	IL 1 (Halsted St) Cut Off	IL 1 (Chicago Rd) / Riegel Rd	Cook	T-1A
317	03	TS1850	IL 1 (Halsted St)	Joe Orr Rd	Cook	T-1A
318		TS1855	IL 1 (Halsted St)	Ridge Rd	Cook	T-1A
319		TS1860	IL 1 (Chicago Rd)	Sauk Trail Rd	Cook	T-1A
320		TS1865	IL 1 (Chicago Rd)	Steger Rd	Cook	T-1A
321		TS1870	IL 1 (Halsted St)	Vollmer Rd	Cook	T-1A
322	04	TS1875	IL 1 (Halsted St)	Maple Gate 3	Cook	T-1A
323	04	TS1880	IL 1 (Halsted St)	175th St	Cook	T-1A
324	04	TS1885	IL 1 (Chicago Rd)	Dixie Highway	Cook	T-1A
325		TS1890	IL 7 (Southwest Highway)	IL 43 (Harlem Ave)	Cook	T-1A
326		TS1895	IL 7 (Southwest Highway)	IL 83 (Cal Sag Rd) / 80th Ave	Cook	T-1A
327	03	TS1899	80th Ave	123rd St / McCarthy Rd	Cook	T-1A
328	03	TS1900	IL 7 (Southwest Highway)	111th St	Cook	T-1A

Count	Grd Date	Loc #	Main Route	Nearest Cross Street	County	RM Pay Item
329	04	TS1903	IL 7 (Southwest Highway)	117th St	Cook	T-1A
330		TS1904	IL 7 (Southwest Highway)	114th St / Metra Train Station	Cook	T-1A
331		TS1905	IL 7 (Southwest Highway)	131st St	Cook	T-1A
332	01	TS1910	IL 7 (Southwest Highway)	135th St	Cook	T-1A
333	03	TS1911	131st St	76th Ave	Cook	T-1A
334		TS1913	131st St	86 th Ave	Cook	T-1A
335	01	TS1915	IL 7 (Southwest Highway)	143rd St	Cook	T-1A
336	03	TS1920	IL 7 (143rd St)	West Ave / 100th Ave	Cook	T-1A
337		TS1925	IL 43 (Harlem Ave)	IL 19 (Irving Park Rd)	Cook	T-1A
338	01	TS1930	IL 59 (Sutton Rd)	IL 19 (Irving Park Rd)	Cook	T-1A
339		TS1932	IL 19 (Irving Park Rd)	Madison Dr	Cook	T-1A
340	01	TS1935	IL 19 (Irving Park Rd)	Bartlett Rd	Cook	T-1A
341		TS1937	IL 59 (Sutton Rd)	Gulf Keys Rd	Cook	T-1A
342	01	TS1940	IL 171 (Cumberland Ave)	IL 19 (Irving Park Rd)	Cook	T-1A
343	01	TS1945	IL 19 (Irving Park Rd)	Des Plaines River Rd	Cook	T-1A
344		TS1948	Des Plaines River Rd	Ivanhoe Ave	Cook	T-1A
345		TS1950	IL 19 (Irving Park Rd)	Forest Preserve Dr	Cook	T-1A
346	01	TS1953	IL 19 (Irving Park Rd)	Judd Ave	Cook	T-1A
347		TS1955	IL 19 (Irving Park Rd)	Oriole Ave	Cook	T-1A
348		TS1960	IL 19 (Irving Park Rd)	Ruby St / 25th Ave	Cook	T-1A
349		TS1965	IL 19 (Irving Park Rd)	Springingsuth Rd	Cook	T-1A
350		TS1966	Elgin O'Hare E Frontage Rd	Springingsuth Rd	Cook	T-1A
351		TS1967	Elgin O'Hare W Frontage Rd	Springingsuth Rd	Cook	T-1A
352	01	TS1970	IL 19 (Irving Park Rd)	Wesley Terrace	Cook	T-1A
353	01	TS1975	IL 19 (Irving Park Rd)	Wise Rd	Cook	T-1A
354	01	TS1976	IL 19 (Irving Park Rd)	Mercury Dr	Cook	T-1A
355	01	TS1980	IL 19 (Irving Park Rd)	Sunnydale Blvd	Cook	T-1A
356	01	TS1985	IL 19 (Irving Park Rd)	East Ave	Cook	T-1A
357	05	TS1987	IL 19 (Irving Park Rd)	Taft Ave / Cargo Access Dr	Cook	T-1A
358	02	TS1990	IL 21 (Milwaukee Ave)	IL 43 (Harlem Ave)	Cook	T-1A
359	02	TS1995	IL 21 (Milwaukee Ave)	IL 58 (Golf Rd)	Cook	T-1A
360	02	TS2000	IL 21 (Milwaukee Ave)	Ballard Rd	Cook	T-1A
361	02	TS2005	IL 21 (Milwaukee Ave)	Central Rd	Cook	T-1A
362	02	TS2010	IL 21 (Milwaukee Ave)	Dearlove Rd / Glenview Rd	Cook	T-1A
363	02	TS2015	IL 21 (Milwaukee Ave)	Greenwood Rd	Cook	T-1A
364	02	TS2020	IL 21 (Milwaukee Ave)	Howard St	Cook	T-1A
365	04	TS2025	IL 21 (Milwaukee Ave)	Main St	Cook	T-1A
366	02	TS2030	IL 21 (Milwaukee Ave)	Maryland St	Cook	T-1A
367		TS2035	IL 21 (Milwaukee Ave)	Oak Mill Mall Entrance	Cook	T-1A
368		TS2040	IL 21 (Milwaukee Ave)	Oakton St	Cook	T-1A
369	04	TS2045	IL 21 (Milwaukee Ave)	Sanders Rd	Cook	T-1A
370		TS2050	IL 21 (Milwaukee Ave)	Euclid Ave / West Lake Ave	Cook	T-1A
371	02	TS2055	IL 21 (Milwaukee Ave)	Zenith Dr / Castilian Ct	Cook	T-1A
372	02	TS2060	IL 21 (Milwaukee Ave)	Golf Mill Center Dr Entrance	Cook	T-1A
373	02	TS2065	IL 21 (Milwaukee Ave)	Golf Mill North Dr Entrance	Cook	T-1A
374		TS2070	IL 38 (Roosevelt Rd)	Harrison St / Hamilton Ave	Cook	T-1A
375		TS2075	IL 38 (Roosevelt Rd)	Wolf Rd	Cook	T-1A

Count	Grd Date	Loc #	Main Route	Nearest Cross Street	County	RM Pay Item
376		TS2077	IL 38 (Roosevelt Rd)	Fencil Ln	Cook	T-1A
377		TS2080	IL 43 (Harlem Ave)	IL 43 (Oakton St)	Cook	T-1A
378		TS2085	IL 43 (Waukegan Rd)	IL 43 (Oakton St)	Cook	T-1A
379		TS2087	Oakton St	Niles Civic Center Plaza Entrance	Cook	T-1A
380		TS2090	IL 58 (Golf Rd)	IL 43/IL 58 (Waukegan Rd)	Cook	T-1A
381	02	TS2095	IL 43 (Harlem Ave)	IL 64 (North Ave)	Cook	T-1A
382		TS2100	IL 43 (Waukegan Rd)	IL 68 (Dundee Rd)	Cook	T-1A
383	03	TS2105	IL 43 (Harlem Ave)	IL 83 / 119th St / College Dr	Cook	T-1A
384	03	TS2110	IL 43 (Harlem Ave)	16th St	Cook	T-1A
385		TS2115	IL 43 (Harlem Ave)	23rd St	Cook	T-1A
386		TS2120	IL 43 (Harlem Ave)	25th St	Cook	T-1A
387	01	TS2125	IL 43 (Harlem Ave)	26th St	Cook	T-1A
388	01	TS2130	IL 43 (Harlem Ave)	39th St / Pershing Rd	Cook	T-1A
389	02	TS2135	IL 43 (Harlem Ave)	47th St	Cook	T-1A
390	02	TS2140	IL 43 (Harlem Ave)	57th St	Cook	T-1A
391	02	TS2145	IL 43 (Harlem Ave)	60th St	Cook	T-1A
392	02	TS2150	IL 43 (Harlem Ave)	63rd St	Cook	T-1A
393		TS2155	IL 43 (Harlem Ave)	63rd St Cutoff	Cook	T-1A
394	02	TS2160	IL 43 (Harlem Ave)	65th St	Cook	T-1A
395	02	TS2165	IL 43 (Harlem Ave)	71st St	Cook	T-1A
396	02	TS2170	IL 43 (Harlem Ave)	75th Pl	Cook	T-1A
397	02	TS2175	IL 43 (Harlem Ave)	79th Pl	Cook	T-1A
398	02	TS2180	IL 43 (Harlem Ave)	83rd St	Cook	T-1A
399	02	TS2185	IL 43 (Harlem Ave)	87th St	Cook	T-1A
400	02	TS2190	IL 43 (Harlem Ave)	88th St / Southfield SC Dr Entrance	Cook	T-1A
401	02	TS2195	IL 43 (Harlem Ave)	90th St / Cambridge St	Cook	T-1A
402	03	TS2200	IL 43 (Harlem Ave)	99th St	Cook	T-1A
403	03	TS2205	IL 43 (Harlem Ave)	103rd St	Cook	T-1A
404		TS2210	IL 43 (Harlem Ave)	111th St	Cook	T-1A
405	03	TS2215	IL 43 (Harlem Ave)	115th St	Cook	T-1A
406	03	TS2220	IL 43 (Harlem Ave)	123rd St	Cook	T-1A
407	04	TS2225	IL 43 (Harlem Ave)	127th St	Cook	T-1A
408	04	TS2226	IL 43 (Harlem Ave)	127th St	Cook	T-1A
409	03	TS2230	IL 43 (Harlem Ave)	131st St	Cook	T-1A
410	03	TS2235	IL 43 (Harlem Ave)	135th St	Cook	T-1A
411		TS2240	IL 43 (Harlem Ave)	151st St	Cook	T-1A
412	01	TS2245	IL 43 (Harlem Ave)	175th St	Cook	T-1A
413	01	TS2250	IL 43 (Harlem Ave)	157th St	Cook	T-1A
414	04	TS2255	IL 43 (Harlem Ave)	183rd St	Cook	T-1A
415	03	TS2256	183rd St	Oak Park Ave	Cook	T-1A
416	03	TS2260	IL 43 (Harlem Ave)	Archer Ave / 55th St	Cook	T-1A
417		TS2265	IL 43 (Harlem Ave)	Armitage Ave	Cook	T-1A
418	01	TS2270	IL 43 (Harlem Ave)	Augusta Blvd	Cook	T-1A
419	03	TS2275	IL 43 (Harlem Ave)	Bloomington Rd	Cook	T-1A
420		TS2280	IL 43 (Harlem Ave)	22nd St / Cermak Rd	Cook	T-1A
421		TS2285	IL 43 (Waukegan Rd)	Chestnut St	Cook	T-1A
422	01	TS2290	IL 43 (Harlem Ave)	Chicago Ave	Cook	T-1A

Count	Grd Date	Loc #	Main Route	Nearest Cross Street	County	RM Pay Item
423	01	TS2295	IL 43 (Harlem Ave)	Division St	Cook	T-1A
424		TS2300	IL 43 (Waukegan Rd)	East Lake Ave	Cook	T-1A
425		TS2305	IL 43 (Harlem Ave)	Forest Preserve Dr	Cook	T-1A
426		TS2310	IL 43 (Harlem Ave)	Foster Pl	Cook	T-1A
427	01	TS2315	IL 43 (Harlem Ave)	Garfield Ave / Harrison St	Cook	T-1A
428		TS2325	IL 43 (Harlem Ave)	Lawrence Ave	Cook	T-1A
429	02	TS2330	IL 43 (Harlem Ave)	Howard St	Cook	T-1A
430	02	TS2335	IL 43 (Harlem Ave)	92nd Pl / Stanford Dr	Cook	T-1A
431	02	TS2340	IL 43 (Harlem Ave)	84th St	Cook	T-1A
432	02	TS2345	IL 43 (Harlem Ave)	77th St	Cook	T-1A
433	02	TS2350	IL 43 (Harlem Ave)	Jackson Blvd	Cook	T-1A
434	03	TS2355	IL 43 (Harlem Ave)	41st St / Joliet Rd	Cook	T-1A
435	02	TS2360	IL 43 (Harlem Ave)	Lake St	Cook	T-1A
436	01	TS2362	US 20 (Lake St)	Bonnie Brae Pl	Cook	T-1A
437	01	TS2370	IL 43 (Harlem Ave)	Madison St	Cook	T-1A
438		TS2375	IL 43 (Harlem Ave)	Montrose Ave / Agatite Ave	Cook	T-1A
439		TS2377	IL 43 (Harlem Ave)	Montrose Ave / Persacola Ave	Cook	T-1A
440	01	TS2380	IL 43 (Harlem Ave)	North Blvd & South Blvd	Cook	T-1A
441	01	TS2385	IL 43 (Harlem Ave)	Ontario Ave	Cook	T-1A
442	01	TS2390	IL 43 (Harlem Ave)	Randolph St	Cook	T-1A
443	01	TS2395	IL 43 (Harlem Ave)	Riverside Dr / Longcommon Rd	Cook	T-1A
444	01	TS2400	IL 38 (Roosevelt Rd)	IL 43 (Harlem Ave)	Cook	T-1A
445	01	TS2401	IL 38 (Roosevelt Rd)	Lathrop Ave	Cook	T-1A
446		TS2406	IL 43 (Waukegan Rd)	Founders Rd	Cook	T-1A
447		TS2410	IL 43 (Harlem Ave)	Touhy Ave	Cook	T-1A
448		TS2411	IL 43 (Harlem Ave)	Pioneer Park / Joswiak Park	Cook	T-1A
449	01	TS2415	IL 43 (Harlem Ave)	Washington Blvd	Cook	T-1A
450	01	TS2420	IL 43 (Harlem Ave)	Wheeler Dr	Cook	T-1A
451		TS2425	IL 43 (Harlem Ave)	Willow Rd	Cook	T-1A
452		TS2430	IL 43 (Harlem Ave)	Wilson Ave	Cook	T-1A
453	04	TS2435	IL 43 (Waukegan Rd)	Winnetka Rd	Cook	T-1A
454	02	TS2445	IL 50 (Cicero Ave)	31st St	Cook	T-1A
455	03	TS2450	IL 50 (Cicero Ave)	39th St / Pershing Rd	Cook	T-1A
456	02	TS2451	IL 50 (Cicero Ave)	Burbank Station Entrance	Cook	T-1A
457	02	TS2455	IL 50 (Cicero Ave)	65th St	Cook	T-1A
458	02	TS2456	IL 50 (Cicero Ave)	66th St	Cook	T-1A
459	02	TS2460	IL 50 (Cicero Ave)	67th St / Marquette Ave	Cook	T-1A
460	02	TS2465	IL 50 (Cicero Ave)	73rd St / State Rd	Cook	T-1A
461	02	TS2470	IL 50 (Cicero Ave)	79th St	Cook	T-1A
462	02	TS2475	IL 50 (Cicero Ave)	83rd St	Cook	T-1A
463	02	TS2480	IL 50 (Cicero Ave)	87th St	Cook	T-1A
464	01	TS2485	IL 50 (Cicero Ave)	94th St	Cook	T-1A
465	02	TS2490	IL 50 (Cicero Ave)	99th St	Cook	T-1A
466	02	TS2495	IL 50 (Cicero Ave)	103rd St	Cook	T-1A
467	02	TS2500	IL 50 (Cicero Ave)	107th St	Cook	T-1A
468	02	TS2505	IL 50 (Cicero Ave)	110th St	Cook	T-1A
469	02	TS2510	IL 50 (Cicero Ave)	111th St	Cook	T-1A

Count	Grd Date	Loc #	Main Route	Nearest Cross Street	County	RM Pay Item
470		TS2512	111th St	Laramie Ave / Jordan Dr	Cook	T-1A
471	02	TS2515	IL 50 (Cicero Ave)	113th St / State Bank of Alsip Entrance	Cook	T-1A
472	02	TS2520	IL 50 (Cicero Ave)	115th St	Cook	T-1A
473	02	TS2525	IL 50 (Cicero Ave)	80th St	Cook	T-1A
474	02	TS2530	IL 50 (Cicero Ave)	91st St	Cook	T-1A
475	02	TS2535	IL 50 (Cicero Ave)	76th Pl / Ford City South Entrance	Cook	T-1A
476	02	TS2540	IL 50 (Cicero Ave)	88th Ave	Cook	T-1A
477	02	TS2545	IL 50 (Cicero Ave)	75th Pl / Ford City North Entrance	Cook	T-1A
478	02	TS2550	IL 50 (Cicero Ave)	72nd St	Cook	T-1A
479	02	TS2555	IL 50 (Cicero Ave)	122nd St	Cook	T-1A
480	02	TS2560	IL 50 (Cicero Ave)	123rd St	Cook	T-1A
481	02	TS2565	IL 50 (Cicero Ave)	127th St	Cook	T-1A
482	02	TS2566	127th St	I-294 E Ramps	Cook	T-1A
483	02	TS2567	127th St	I-294 W Ramps	Cook	T-1A
484	03	TS2570	IL 50 (Cicero Ave)	151st St	Cook	T-1A
485	04	TS2575	IL 50 (Cicero Ave)	155th St	Cook	T-1A
486		TS2580	IL 50 (Cicero Ave)	167th St	Cook	T-1A
487	03	TS2585	IL 50 (Cicero Ave)	183rd St	Cook	T-1A
488		TS2590	IL 50 (Cicero Ave)	Devon Ave	Cook	T-1A
489	03	TS2595	IL 50 (Cicero Ave)	Fieldcrest Dr / 166th St	Cook	T-1A
490	03	TS2600	IL 50 (Cicero Ave)	Flossmoor Rd	Cook	T-1A
491		TS2605	IL 50 (Cicero Ave)	Pratt Ave	Cook	T-1A
492	02	TS2610	IL 50 (Cicero Ave)	Roosevelt Rd	Cook	T-1A
493	02	TS2620	IL 50 (Cicero Ave)	Southwest Highway	Cook	T-1A
494		TS2625	IL 50 (Cicero Ave)	Touhy Ave	Cook	T-1A
495	04	TS2630	IL 50 (Cicero Ave)	Matteson Town Center Mall Entrance	Cook	T-1A
496	03	TS2635	IL 50 (Cicero Ave)	Vollmer Rd	Cook	T-1A
497	04	TS2640	US 45 (LaGrange Rd)	131st St	Cook	T-1A
498	02	TS2645	IL 50/IL 83 (Cicero Ave)	IL 83 (Cal Sag Rd)	Cook	T-1A
499	02	TS2649	IL 50/IL 83 (Cicero Ave)	Rivercrest East Entrance	Cook	T-1A
500	02	TS2650	IL 50/IL 83 (Cicero Ave)	135th St	Cook	T-1A
501	02	TS2655	IL 50/IL 83 (Cicero Ave)	Midlothian Turnpike	Cook	T-1A
502	07	TS2660	IL 68/IL 53 (Dundee Rd)	West Frontage Rd	Cook	T-1A
503		TS2665	IL 53 East Ramps	IL 62 (Algonquin Rd)	Cook	T-1A
504		TS2670	IL 53 West Ramps	IL 62 (Algonquin Rd)	Cook	T-1A
505	08	TS2677	IL 53 (Hicks Rd)	Lake Cook Rd	Cook	T-1A
506	04	TS2685	IL 68/IL 53 (Dundee Rd)	Baldwin Ln	Cook	T-1A
507		TS2693	IL 56 (Butterfield Rd)	Darmstadt Rd	Cook	T-1A
508	01	TS2700	IL 59 (Sutton Rd)	IL 58 (Golf Rd)	Cook	T-1A
509		TS2705	IL 58 (Golf Rd)	IL 62 (Algonquin Rd)	Cook	T-1A
510		TS2707	IL 62 (Algonquin Rd)	Lowes Ent	Cook	T-1A
511		TS2708	IL 62 (Algonquin Rd)	Market Place	Cook	T-1A
512		TS2710	IL 58 (Golf Rd)	IL 72 (Higgins Rd)	Cook	T-1A
513		TS2715	IL 58 (Golf Rd)	IL 83 (Elmhurst Rd)	Cook	T-1A
514		TS2720	IL 58 (Golf Rd)	Arlington Heights Rd	Cook	T-1A
515		TS2725	IL 58 (Golf Rd)	Barrington Rd	Cook	T-1A
516	04	TS2730	IL 58 (Golf Rd)	Bartlett Rd	Cook	T-1A

Count	Grd Date	Loc #	Main Route	Nearest Cross Street	County	RM Pay Item
517		TS2735	IL 58 (Dempster St)	Bronx Ave	Cook	T-1A
518		TS2740	IL 58 (Golf Rd)	Busse Rd	Cook	T-1A
519		TS2745	IL 58 (Dempster St)	CTA RR Terminal Entrance	Cook	T-1A
520	02	TS2750	IL 58 (Golf Rd)	Dee Rd	Cook	T-1A
521	02	TS2755	IL 58 (Golf Rd)	East River Rd	Cook	T-1A
522		TS2760	IL 58 (Golf Rd)	Gannon Dr	Cook	T-1A
523	04	TS2765	IL 58 (Golf Rd)	Goebbert Rd	Cook	T-1A
524	04	TS2767	IL 58 (Golf Rd)	International Plaza Rd	Cook	T-1A
525	04	TS2770	IL 58 (Golf Rd)	Gould Dr	Cook	T-1A
526	02	TS2775	IL 58 (Golf Rd)	Greenwood Ave	Cook	T-1A
527		TS2780	IL 58 (Golf Rd)	IL 43 (Harlem Ave)	Cook	T-1A
528	04	TS2785	IL 58 (Golf Rd)	6th Ave	Cook	T-1A
529		TS2790	IL 58 (Golf Rd)	Highland Blvd	Cook	T-1A
530		TS2795	IL 58 (Golf Rd)	Jones Rd / Salem Dr	Cook	T-1A
531	04	TS2800	IL 58 (Golf Rd)	Kraft Food Entrance	Cook	T-1A
532		TS2805	IL 58 (Dempster St)	Lockwood Ave	Cook	T-1A
533		TS2810	IL 58 (Golf Rd)	Meacham Rd	Cook	T-1A
534		TS2815	IL 58 (Golf Rd)	Wilke Rd	Cook	T-1A
535		TS2820	IL 58 (Golf Rd)	Niles Center Rd	Cook	T-1A
536		TS2825	IL 58 (Golf Rd)	Oakton Community College Entrance	Cook	T-1A
537		TS2830	IL 58 (Golf Rd)	Plum Grove Rd	Cook	T-1A
538	02	TS2835	IL 58 (Golf Rd)	Potter Rd	Cook	T-1A
539		TS2840	IL 58 (Golf Rd)	Roselle Rd	Cook	T-1A
540		TS2845	IL 58 (Golf Rd)	Shermer Rd	Cook	T-1A
541	02	TS2850	IL 58 (Golf Rd)	Washington St	Cook	T-1A
542	02	TS2855	IL 58 (Golf Rd)	Western Ave	Cook	T-1A
543	04	TS2860	IL 58 (Golf Rd)	3 Com Dr / Apollo Dr	Cook	T-1A
544		TS2865	IL 58 (Golf Rd)	Wolf Rd / Segers Rd	Cook	T-1A
545		TS2870	IL 58 (Golf Rd)	Moon Lake Rd / Walnut Ln	Cook	T-1A
546	04	TS2875	IL 58 (Golf Rd)	Meier Rd	Cook	T-1A
547		TS2880	IL 58 (Golf Rd)	Valley Lake	Cook	T-1A
548	02	TS2885	IL 58 (Golf Rd)	Four Flags Shopping Center Entrance	Cook	T-1A
549		TS2890	IL 62/IL 68 (Algonquin Rd)	IL59/IL 68 (Dundee Rd)	Cook	T-1A
550		TS2892	IL 59 (Sutton Rd)	Bartlett Rd	Cook	T-1A
551	04	TS2895	IL 59 (Sutton Rd)	IL 72 (Higgins Rd)	Cook	T-1A
552		TS2897	IL 59 (Sutton Rd)	Penny Rd	Cook	T-1A
553		TS2900	IL 59 (Hough Rd/Hawthorne Rd)	Barrington Rd	Cook	T-1A
554		TS2905	IL 59 (Hough Rd/Hawthorne Rd)	Hillside Ave	Cook	T-1A
555	01	TS2910	IL 59 (Sutton Rd)	Schaumburg Rd	Cook	T-1A
556		TS2915	IL 59/IL 68 (Sutton Rd)	IL 62/IL 68 (Algonquin Rd)	Cook	T-1A
557		TS2920	IL 62/IL 68 (Algonquin Rd)	IL 68 (Dundee Rd) / Brinker Rd	Cook	T-1A
558		TS2922	IL 62 (Algonquin Rd)	Palatine Rd	Cook	T-1A
559		TS2925	IL 62 (Algonquin Rd)	IL 83 (Elmhurst Rd)	Cook	T-1A
560		TS2930	IL 62 (Algonquin Rd)	Arbor Dr	Cook	T-1A
561		TS2935	IL 62 (Algonquin Rd)	Arlington Heights Rd	Cook	T-1A
562	04	TS2936	IL 62 (Algonquin Rd)	95 West Radisson Marriot Hotel Entrance	Cook	T-1A
563		TS2938	Arlington Heights Rd	I-90 Tollway N Ramps	Cook	T-1A

Count	Grd Date	Loc #	Main Route	Nearest Cross Street	County	RM Pay Item
564		TS2939	Arlington Heights Rd	I-90 Tollway S Ramps	Cook	T-1A
565		TS2940	IL 62 (Algonquin Rd)	Barrington Rd	Cook	T-1A
566		TS2945	IL 62 (Algonquin Rd)	Busse Rd	Cook	T-1A
567		TS2950	IL 62 (Algonquin Rd)	Dempster St	Cook	T-1A
568	04	TS2955	IL 62 (Algonquin Rd)	Ela Rd	Cook	T-1A
569	04	TS2957	IL 62 (Algonquin Rd)	Winston Dr	Cook	T-1A
570	04	TS2960	IL 62 (Algonquin Rd)	Freeman Rd / Huntington Blvd	Cook	T-1A
571	04	TS2965	IL 62 (Algonquin Rd)	Goebbert Rd	Cook	T-1A
572		TS2966	IL 62 (Algonquin Rd)	Tonne Rd	Cook	T-1A
573		TS2967	IL 62 (Algonquin Rd)	Meijer Entrance	Cook	T-1A
574		TS2970	IL 62 (Algonquin Rd)	Harper College Entrance	Cook	T-1A
575		TS2975	IL 62 (Algonquin Rd)	Linneman Rd	Cook	T-1A
576		TS2980	IL 62 (Algonquin Rd)	Magnolia Dr / Commerce Rd	Cook	T-1A
577		TS2985	IL 62 (Algonquin Rd)	New Wilke Rd	Cook	T-1A
578		TS2990	IL 62 (Algonquin Rd)	Roselle Rd	Cook	T-1A
579	01	TS2995	IL 64 (North Ave)	IL 171 (1st Ave)	Cook	T-1A
580	01	TS3000	IL 64 (North Ave)	5th Ave	Cook	T-1A
581	01	TS3005	IL 64 (North Ave)	7th Ave	Cook	T-1A
582	01	TS3010	IL 64 (North Ave)	9th Ave	Cook	T-1A
583		TS3015	IL 64 (North Ave)	19th Ave / Broadway Ave	Cook	T-1A
584	01	TS3020	IL 64 (North Ave)	25th Ave	Cook	T-1A
585	01	TS3025	IL 64 (North Ave)	76th Ave / Lathrop Ave	Cook	T-1A
586		TS3030	IL 64 (North Ave)	Austin Blvd	Cook	T-1A
587	01	TS3035	IL 64 (North Ave)	Cornell Ave / 35th St	Cook	T-1A
588	01	TS3040	IL 64 (North Ave)	George St	Cook	T-1A
589	02	TS3045	IL 64 (North Ave)	Hawthorne Ave	Cook	T-1A
590	01	TS3050	IL 64 (North Ave)	Indian Boundary Rd / Ruby Rd	Cook	T-1A
591	02	TS3055	IL 64 (North Ave)	Narragansett Ave / Edmer Ave	Cook	T-1A
592	01	TS3060	IL 64 (North Ave)	Natoma Ave / Columbian Ave	Cook	T-1A
593	01	TS3065	IL 64 (North Ave)	Northwest Ave	Cook	T-1A
594		TS3067	US 20 (Lake St)	Railroad Ave	Cook	T-1A
595		TS3070	IL 64 (North Ave)	Oak Park Ave	Cook	T-1A
596	01	TS3075	IL 64 (North Ave)	Railroad Ave	Cook	T-1A
597	02	TS3080	IL 64 (North Ave)	Ridgeland Ave / Mobile Ave	Cook	T-1A
598	01	TS3083	IL 64 (North Ave)	Roy St	Cook	T-1A
599	01	TS3085	IL 64 (North Ave)	Thatcher Ave	Cook	T-1A
600	01	TS3090	IL 64 (North Ave)	Wolf Rd	Cook	T-1A
601	07	TS3095	IL 68 (Dundee Rd)	IL 83 (Elmhurst Rd)	Cook	T-1A
602	07	TS3100	IL 68 (Dundee Rd)	Arlington Heights Rd	Cook	T-1A
603	07	TS3105	IL 68 (Dundee Rd)	Barrington Rd	Cook	T-1A
604	07	TS3110	IL 68 (Dundee Rd)	Buffalo Grove Rd	Cook	T-1A
605	04	TS3112	IL 68 (Dundee Rd)	Buffalo Grove High School Entrance	Cook	T-1A
606	04	TS3115	IL 68 (Dundee Rd)	Charlemagne Dr / Torrey Pines Parkway	Cook	T-1A
607	07	TS3120	IL 68 (Dundee Rd)	Hicks Rd	Cook	T-1A
608	04	TS3122	IL 68 (Dundee Rd)	Denise Dr / Deergrove SC Entrance	Cook	T-1A
609	07	TS3125	IL 68 (Dundee Rd)	Huehl Rd	Cook	T-1A
610	04	TS3130	IL 68 (Dundee Rd)	Kennicott Ave	Cook	T-1A

Count	Grd Date	Loc #	Main Route	Nearest Cross Street	County	RM Pay Item
611	07	TS3135	IL 68 (Dundee Rd)	Landwehr Rd	Cook	T-1A
612	07	TS3137	IL 68 (Dundee Rd)	Anthony Tr	Cook	T-1A
613	07	TS3140	IL 68 (Dundee Rd)	Midway Rd	Cook	T-1A
614	07	TS3145	IL 68 (Dundee Rd)	Old McHenry Rd / Wheeling Rd	Cook	T-1A
615	04	TS3150	IL 68 (Dundee Rd)	Ridge Ave	Cook	T-1A
616	07	TS3155	IL 68 (Dundee Rd)	Golfview Terrace	Cook	T-1A
617	07	TS3160	IL 68 (Dundee Rd)	Pfingsten Rd	Cook	T-1A
618	04	TS3165	IL 68 (Dundee Rd)	Quentin Rd	Cook	T-1A
619		TS3168	IL 68 (Dundee Rd)	Sterling Ave	Cook	T-1A
620	07	TS3170	IL 68 (Dundee Rd)	Sanders Rd	Cook	T-1A
621	07	TS3175	IL 68 (Dundee Rd)	Schoenbeck Rd	Cook	T-1A
622	07	TS3180	IL 68 (Dundee Rd)	Shermer Rd	Cook	T-1A
623	07	TS3185	IL 68 (Dundee Rd)	Skokie Rd	Cook	T-1A
624	07	TS3190	IL 68 (Dundee Rd)	Smith Rd	Cook	T-1A
625	04	TS3195	IL 68 (Dundee Rd)	Western Ave	Cook	T-1A
626	07	TS3200	IL 68 (Dundee Rd)	Wolf Rd	Cook	T-1A
627	07	TS3205	IL 68 (Dundee Rd)	Wilke Rd / E Frontage Rd	Cook	T-1A
628	04	TS3210	IL 68 (Dundee Rd)	Weidner Rd / Crofton Ln	Cook	T-1A
629	04	TS3213	IL 68 (Dundee Rd)	Buffalo Grove Fire House	Cook	T-1A
630		TS3215	IL 72 (Higgins Rd)	Landmeier Rd	Cook	T-1A
631		TS3220	IL 72 (Higgins Rd)	Mall Dr	Cook	T-1A
632		TS3225	IL 72 (Higgins Rd)	Martingale Rd	Cook	T-1A
633		TS3230	IL 72 (Higgins Rd)	Meacham Rd	Cook	T-1A
634		TS3235	IL 72 (Higgins Rd)	Mt Prospect Rd	Cook	T-1A
635		TS3240	IL 72 (Higgins Rd)	Oakton St W Junction	Cook	T-1A
636		TS3245	IL 72 (Higgins Rd)	Plum Grove Rd	Cook	T-1A
637		TS3250	IL 72 (Higgins Rd)	Roselle Rd	Cook	T-1A
638		TS3251	IL 72 (Higgins Rd)	Ash Rd	Cook	T-1A
639		TS3255	IL 72 (Higgins Rd)	Salem Dr	Cook	T-1A
640		TS3260	IL 72 (Touhy Ave)	Wolf Rd	Cook	T-1A
641		TS3265	IL 72 (Higgins Rd)	O'Hare Plaza Entrance # 2	Cook	T-1A
642		TS3270	IL 72 (Higgins Rd)	IL 72 (Touhy Ave)	Cook	T-1A
643		TS3275	IL 72 (Higgins Rd)	Oakton St E Junction	Cook	T-1A
644		TS3280	IL 83 (Busse Rd)	Oakton St	Cook	T-1A
645		TS3285	IL 72 (Higgins Rd)	Arlington Heights Rd	Cook	T-1A
646		TS3290	IL 72 (Higgins Rd)	Barrington Rd	Cook	T-1A
647	04	TS3295	IL 72 (Higgins Rd)	Bartlett Rd	Cook	T-1A
648		TS3300	IL 72 (Higgins Rd)	Canfield Rd	Cook	T-1A
649		TS3305	IL 72 (Higgins Rd)	IL 171 (Cumberland Ave)	Cook	T-1A
650		TS3310	IL 72 (Higgins Rd)	Dee Rd / East River Rd	Cook	T-1A
651		TS3315	IL 72 (Higgins Rd)	Elmhurst Rd	Cook	T-1A
652		TS3318	Elmhurst Rd	Landmeier Rd	Cook	T-1A
653		TS3325	IL 72 (Higgins Rd)	Gannon Dr	Cook	T-1A
654	04	TS3330	IL 72 (Higgins Rd)	Governors Ln / Moon Lake Blvd	Cook	T-1A
655		TS3335	IL 72 (Higgins Rd)	King Rd / Stanley St	Cook	T-1A
656		TS3340	IL 72 (Higgins Rd)	Beverly Rd	Cook	T-1A
657	04	TS3345	IL 83 (Torrence Ave)	IL 83 (Glenwood Dyer Rd)	Cook	T-1A

Count	Grd Date	Loc #	Main Route	Nearest Cross Street	County	RM Pay Item
658	02	TS3350	IL 83 (Elmhurst Rd)	IL 83 (Oakton St)	Cook	T-1A
659		TS3355	IL 83 (Elmhurst Rd)	IL 83 (Old McHenry Rd)	Cook	T-1A
660		TS3360	IL 83 Cal Sag Rd	104 th Ave	Cook	T-1A
661		TS3365	IL 83/IL 171 N Junction	107th St	Cook	T-1A
662		TS3370	IL 83/IL 171 S Junction	111th St	Cook	T-1A
663		TS3375	IL 83 (Cal Sag Rd)	127th St	Cook	T-1A
664	03	TS3380	IL 83 (Torrence Ave)	186th St	Cook	T-1A
665	03	TS3385	IL 83/147th St/SibleyBlvd	Broadway Ave	Cook	T-1A
666	04	TS3390	IL 83 (Elmhurst Rd)	Camp McDonald Rd	Cook	T-1A
667	03	TS3395	IL 83/147th St/SibleyBlvd	Chicago Rd / South Park Ave	Cook	T-1A
668	04	TS3400	IL 83/147th St/SibleyBlvd	Crawford Ave	Cook	T-1A
669		TS3405	IL 83 (Elmhurst Rd)	Dempster St / Thacker St	Cook	T-1A
670		TS3410	IL 83 (Busse Rd)	Devon Ave	Cook	T-1A
671	04	TS3415	IL 83/147th St/SibleyBlvd	Dixie Highway	Cook	T-1A
672		TS3420	IL 83 (Elmhurst Rd)	Euclid St	Cook	T-1A
673		TS3425	IL 83 (Busse Rd)	Greenleaf Ave	Cook	T-1A
674	04	TS3430	IL 83 (Elmhurst Rd)	Hintz Rd	Cook	T-1A
675	03	TS3435	IL 83/147th St/SibleyBlvd	Homan Ave	Cook	T-1A
676		TS3440	IL 83/147th St/SibleyBlvd	Indiana Ave	Cook	T-1A
677	03	TS3445	IL 83/147th St/SibleyBlvd	Keeler Ave	Cook	T-1A
678	04	TS3450	IL 83/147th St/SibleyBlvd	Kedzie Ave	Cook	T-1A
679	03	TS3455	IL 83/147th St/SibleyBlvd	Kilbourn Ave	Cook	T-1A
680		TS3460	IL 83 (Busse Rd)	Landmeier Rd	Cook	T-1A
681	03	TS3465	IL 83/147th St/SibleyBlvd	La Salle Ave / Markham Dr	Cook	T-1A
682	03	TS3470	IL 83/147th St/SibleyBlvd	Loomis St	Cook	T-1A
683	04	TS3475	IL 83/147th St/SibleyBlvd	Michigan City Rd / Lincoln Ave	Cook	T-1A
684	03	TS3480	IL 83 (Torrence Ave)	Michigan City Rd	Cook	T-1A
685		TS3485	IL 83 (Elmhurst Rd)	Palatine Rd	Cook	T-1A
686		TS3490	IL 83 (Busse Rd)	Pratt Rd	Cook	T-1A
687		TS3495	IL 83 (Torrence Ave)	Ridge Rd / 179th St	Cook	T-1A
688	04	TS3500	IL 83 (Elmhurst Rd)	Randhurst Shopping Center Entrance	Cook	T-1A
689	04	TS3505	IL 83 (Cal Sag Rd)	Ridgeland Ave	Cook	T-1A
690	03	TS3510	IL 83/147th St/SibleyBlvd	Robey Ave	Cook	T-1A
691	03	TS3515	IL 83 (Torrence Ave)	Thornton Lansing Rd	Cook	T-1A
692	03	TS3520	IL 83/147th St/SibleyBlvd	Wood St	Cook	T-1A
693		TS3530	IL 83 (Cal Sag Rd / College Dr)	119th St	Cook	T-1A
694		TS3532	IL 83 (Cal Sag Rd / College Dr)	76th Ave	Cook	T-1A
695		TS3535	IL 83 (Elmhurst Rd)	Huntington Commons Dr	Cook	T-1A
696	04	TS3540	IL 83 (Elmhurst Rd)	Willow Rd	Cook	T-1A
697	03	TS3545	IL 171 (Archer Ave)	63rd St	Cook	T-1A
698		TS3550	IL 171 (1st Ave) E Ramps	Joliet Rd	Cook	T-1A
699		TS3555	IL 171 (Archer Ave)	55th St	Cook	T-1A
700	03	TS3557	IL 171 (Archer Ave)	59th St	Cook	T-1A
701	03	TS3560	IL 171 (Archer Ave)	Roberts Rd	Cook	T-1A
702		TS3565	IL 171 (Archer Ave)	State St	Cook	T-1A
703		TS3567	IL 171 (Archer Ave)	Access Dr / Target Entrance	Cook	T-1A
704	03	TS3570	IL 171 (Archer Ave)	Willow Springs Rd	Cook	T-1A

Count	Grd Date	Loc #	Main Route	Nearest Cross Street	County	RM Pay Item
705		TS3572	IL 171 (Archer Ave)	Nolton Ave	Cook	T-1A
706	03	TS3573	Willow Springs Rd	German Church Rd	Cook	T-1A
707	03	TS3575	IL 171 (1st Ave) E Ramps	47th St	Cook	T-1A
708	06	TS3580	IL 394	Steger Rd	Cook	T-1A
709	01	TS3585	IL 171 (1st Ave)	26th St	Cook	T-1A
710	01	TS3590	IL 171 (1st Ave)	31st St	Cook	T-1A
711	03	TS3595	IL 171 (1st Ave)	31st St / Cutoff Golf View Rd	Cook	T-1A
712	01	TS3600	IL 171 (1st Ave)	22nd St / Cermak Rd	Cook	T-1A
713	01	TS3605	IL 171 (1st Ave)	22nd St / Cermak Rd Cutoff	Cook	T-1A
714	01	TS3610	IL 171 (1st Ave)	Chicago Ave	Cook	T-1A
715		TS3615	IL 171 (1st Ave)	Des Plaines River Rd	Cook	T-1A
716	01	TS3620	IL 171 (1st Ave)	Forest Ave / Ridgewood Ave	Cook	T-1A
717	02	TS3625	IL 171 (1st Ave)	Fullerton Ave	Cook	T-1A
718	02	TS3630	IL 171 (1st Ave)	Lake St	Cook	T-1A
719	01	TS3635	IL 171 (1st Ave)	13th St / Madden Medical Center Entrance	Cook	T-1A
720	01	TS3640	IL 171 (1st Ave)	Madison St	Cook	T-1A
721	02	TS3645	IL 171 (1st Ave)	Maybrook Square Entrance	Cook	T-1A
722	01	TS3650	IL 171 (1st Ave)	Roosevelt Rd	Cook	T-1A
723		TS3656	IL 171 (1st Ave)	Warren Ave	Cook	T-1A
724	03	TS3660	IL 171 (1st Ave)	Thatcher Rd Cutoff	Cook	T-1A
725	03	TS3665	IL 171 (1st Ave)	Van Buren St / Comm Edison Entrance	Cook	T-1A
726		TS3670	IL 171 (1st Ave)	Washington Blvd	Cook	T-1A
727	01	TS3675	IL 171 (1st Ave)	G St / Loyola Hospital Entrance	Cook	T-1A
728	01	TS3680	5th Ave	Des Plaines River Rd	Cook	T-1A
729	01	TS3685	5th Ave	Triton College N Entrance	Cook	T-1A
730	01	TS3690	5th Ave	Triton College S Entrance	Cook	T-1A
731		TS3691	31st St	Prairie Ave	Cook	T-1A
732		TS3693	30th St	Maple Ave	Cook	T-1A
733		TS3695	17th Ave / Maple Ave	31st St / Logan Blvd	Cook	T-1A
734	01	TS3700	22nd St / Cermak Rd	17th Ave	Cook	T-1A
735	01	TS3701	22nd St / Cermak Rd	12th Ave	Cook	T-1A
736	01	TS3705	Roosevelt Rd	17th Ave	Cook	T-1A
737	03	TS3715	25th Ave	Lake St	Cook	T-1A
738	03	TS3720	25th Ave	Lexington Dr	Cook	T-1A
739	01	TS3725	Roosevelt Rd	25th Ave	Cook	T-1A
740	03	TS3735	26th St	Des Plaines Ave	Cook	T-1A
741	03	TS3740	26th St	East End Ave	Cook	T-1A
742	03	TS3745	26th St	Highland Blvd	Cook	T-1A
743	03	TS3750	26th St	North Riverside Plaza Entrance	Cook	T-1A
744	03	TS3755	26th St	Ridgeland Ave	Cook	T-1A
745		TS3760	31st St	Des Plaines Ave	Cook	T-1A
746	03	TS3765	31st St	Golfview Ln / 1st Ave Cutoff	Cook	T-1A
747	03	TS3770	31st St	Kemman Ave / Grand Blvd	Cook	T-1A
748		TS3775	31st St	Wolf Rd	Cook	T-1A
749	03	TS3780	39th St / Pershing Rd	Central Ave	Cook	T-1A
750	03	TS3785	39th St / Pershing Rd	Laramie Ave	Cook	T-1A
751	03	TS3790	39th St / Pershing Rd	Oak Park Ave	Cook	T-1A

Count	Grd Date	Loc #	Main Route	Nearest Cross Street	County	RM Pay Item
752	03	TS3795	39th St / Pershing Rd	Ridgeland Ave	Cook	T-1A
753	03	TS3800	39th St / Pershing Rd	Austin Blvd	Cook	T-1A
754	01	TS3805	Central Ave	47th St	Cook	T-1A
755	03	TS3810	47th St	Joliet Rd	Cook	T-1A
756	03	TS3815	47th St	Lawndale Ave	Cook	T-1A
757	03	TS3820	47th St	Plainfield Rd	Cook	T-1A
758		TS3825	47th St	Wolf Rd	Cook	T-1A
759	01	TS3830	55th St	Brainard Ave	Cook	T-1A
760	03	TS3835	IL 171 (Archer Ave)	Center Ave / Lawndale Ave	Cook	T-1A
761	03	TS3840	55th St	County Line Rd	Cook	T-1A
762	03	TS3845	55th St	East Ave	Cook	T-1A
763		TS3850	55th St	Joliet Rd	Cook	T-1A
764	03	TS3855	55th St	Plainfield Rd	Cook	T-1A
765	01/03	TS3860	55th St	Willow Springs Rd	Cook	T-1A
766	01	TS3865	55th St	Wolf Rd	Cook	T-1A
767	01	TS3870	55th St	Laurel Ave	Cook	T-1A
768	03	TS3875	79th St	Austin Blvd	Cook	T-1A
769	03	TS3880	79th St	Central Ave	Cook	T-1A
770		TS3885	79th St	Narragansett Ave	Cook	T-1A
771	03	TS3890	79th St	Roberts Rd	Cook	T-1A
772	03	TS3893	79th St	Willow Springs Rd	Cook	T-1A
773	03	TS3895	79th St	Sayre Ave	Cook	T-1A
774	03	TS3900	79th St	State Rd	Cook	T-1A
775		TS3910	87th St	Kedzie Ave	Cook	T-1A
776		TS3915	87th St	Kostner Ave	Cook	T-1A
777		TS3920	Crawford Ave / Pulaski Rd	Southwest Highway / Columbus Dr	Cook	T-1A
778	02	TS3925	103rd St	Crawford Ave / Pulaski Rd	Cook	T-1A
779		TS3930	103rd St	Kedzie Ave	Cook	T-1A
780		TS3935	Southwest Highway	103rd St / Virginia Ave	Cook	T-1A
781	02	TS3936	123rd St	Crawford Ave / Pulaski Rd	Cook	T-1A
782	01	TS3940	111th St	86th Ave	Cook	T-1A
783		TS3942	111 th St	Poosum Dr College Pkwy	Cook	T-1A
784	04	TS3945	111th St	Central Ave	Cook	T-1A
785	04	TS3950	111th St	Ridgeland Ave	Cook	T-1A
786	03	TS3955	111th St	Roberts Rd	Cook	T-1A
787	02	TS3960	115th St	Crawford Ave / Pulaski Rd	Cook	T-1A
788		TS3965	115th St	Kedzie Ave	Cook	T-1A
789		TS3970	119th St	Vincennes Ave	Cook	T-1A
790	03	TS3975	127th St	76th Ave	Cook	T-1A
791	03	TS3980	127th St	Ashland Ave	Cook	T-1A
792	03	TS3985	127th St	Central Ave	Cook	T-1A
793	02	TS3990	127th St	Crawford Ave / Pulaski Rd	Cook	T-1A
794	04	TS3995	127th St	Kedzie Ave	Cook	T-1A
795	03	TS4000	127th St	Ridgeland Ave	Cook	T-1A
796	03	TS4005	127th St	Throop St	Cook	T-1A
797	03	TS4010	127th St	Wood St	Cook	T-1A
798	03	TS4015	127th St	Bishop St	Cook	T-1A

Count	Grd Date	Loc #	Main Route	Nearest Cross Street	County	RM Pay Item
799	03	TS4030	135th St	Long Ave	Cook	T-1A
800	03	TS4035	135th St	Ridgeland Ave	Cook	T-1A
801	03	TS4045	138th St	Ashland Ave / Wood St	Cook	T-1A
802	03	TS4050	142nd St / Main St	Chicago Ave	Cook	T-1A
803	03	TS4055	142nd St / Main St	Indiana Ave	Cook	T-1A
804	03	TS4060	142nd St / Main St	Lincoln Ave	Cook	T-1A
805	03	TS4075	147th St	Central Ave	Cook	T-1A
806	03	TS4076	147th St	Ridgeland Ave	Cook	T-1A
807	03	TS4080	154th St	Chicago Ave / South Park Ave	Cook	T-1A
808	03	TS4085	167th St	Wood St	Cook	T-1A
809		TS4090	Governors Highway / 175th St	Dixie Highway	Cook	T-1A
810		TS4092	Governors Highway	Metra RR Station Entrance	Cook	T-1A
811	03	TS4095	183rd St	Crawford Ave / Pulaski Rd	Cook	T-1A
812	03	TS4108	183rd St	Ridgeland Ave	Cook	T-1A
813		TS4110	183rd St	Riegal Rd	Cook	T-1A
814	02	TS4115	IL 171 (Cumberland Ave)	Addison St	Cook	T-1A
815		TS4120	Algonquin Rd	Mt Prospect Rd	Cook	T-1A
816		TS4125	Algonquin Rd	Oakton St	Cook	T-1A
817		TS4130	Algonquin Rd	Wolf Rd	Cook	T-1A
818		TS4135	Ashland Ave	Broadway Ave at North Water St	Cook	T-1A
819		TS4140	Ashland Ave	Vermont Ave	Cook	T-1A
820		TS4145	Ballard Rd	Dee Rd	Cook	T-1A
821		TS4146	Ballard Rd	Nesset Dr	Cook	T-1A
822		TS4150	Ballard Rd	Greenwood Rd	Cook	T-1A
823	04	TS4155	Ballard Rd	Potter Rd	Cook	T-1A
824		TS4160	Ballard Rd	US12 (Rand Rd)	Cook	T-1A
825	01	TS4165	Barrington Rd	Bourbon Parkway	Cook	T-1A
826	04	TS4170	Barrington Rd	Bode Rd	Cook	T-1A
827		TS4175	Barrington Rd	Hassel Rd	Cook	T-1A
828		TS4176	Barrington Rd	Central Rd	Cook	T-1A
829	01	TS4180	Barrington Rd	Schaumburg Rd	Cook	T-1A
830		TS4185	Barrington Rd	Mundhank Rd	Cook	T-1A
831	04	TS4188	Barrington Rd	Locust Dr / Lakewood Blvd	Cook	T-1A
832		TS4190	Belmont Ave	80th Ave / Pacific Ave	Cook	T-1A
833	01	TS4200	IL 171 (Cumberland Ave)	Belmont Ave	Cook	T-1A
834	01	TS4203	IL 171 (Cumberland Ave)	Thatcher Woods SC Entrance	Cook	T-1A
835		TS4205	Belmont Ave	Des Plaines River Rd	Cook	T-1A
836		TS4210	Belmont Ave	Forest Preserve Dr	Cook	T-1A
837		TS4215	Belmont Ave	77th Ave / Overhill Ave	Cook	T-1A
838	03	TS4220	Belmont Ave	Burnham Ave	Cook	T-1A
839	03	TS4225	Broadway Ave	Joe Orr Rd / Riegel Rd	Cook	T-1A
840	04	TS4230	Burnham Ave	170th St	Cook	T-1A
841	03	TS4235	Burnham Ave	Ridge Rd	Cook	T-1A
842	04	TS4240	Burnham Ave	Schrum Pl	Cook	T-1A
843	04	TS4245	Busse Highway	Potter Rd	Cook	T-1A
844	04	TS4250	Busse Rd	Dempster St	Cook	T-1A
845		TS4255	Canfield Ave	Devon Ave	Cook	T-1A

Count	Grd Date	Loc #	Main Route	Nearest Cross Street	County	RM Pay Item
846		TS4260	Canfield Ave	Talcott Ave	Cook	T-1A
847	02	TS4270	111th St	Crawford Ave / Pulaski Rd	Cook	T-1A
848	04	TS4280	IL 43 (Harlem Ave)	143rd St	Cook	T-1A
849		TS4285	IL 43 (Harlem Ave)	Foster Shopping Center Entrance	Cook	T-1A
850	03	TS4375	Joe Orr Rd	Ashland Ave	Cook	T-1A
851	03	TS4410	Burnham Ave	152nd St	Cook	T-1A
852	03	TS4415	Burnham Ave	156th St	Cook	T-1A
853	03	TS4425	Burnham Ave	Michigan City Rd	Cook	T-1A
854	03	TS4430	Burnham Ave	154th St / Pulaski Rd	Cook	T-1A
855	04	TS4435	Sibley Blvd / 147th St	Burnham Ave	Cook	T-1A
856	01	TS4660	IL 59 (Sutton Rd)	West Bartlett Rd	Cook	T-1A
857	05	TS4670	IL 59	Stearns Rd	Cook	T-1A
858		TS4695	US 14 (Northwest Highway)	Eastern Ave	Cook	T-1A
859	02	TS4715	IL 43 (Harlem Ave)	48th St / Amoco Oil Entrance	Cook	T-1A
860	03	TS4725	IL 50 (Cicero Ave)	37th St / Citco Oil Entrance	Cook	T-1A
861	01	TS4735	Central Ave	51st St	Cook	T-1A
862	02	TS4740	Central Rd	Dee Rd	Cook	T-1A
863	02	TS4742	Central Rd	Dearlove Rd / Glenview Rd	Cook	T-1A
864	02	TS4745	Central Rd	Greenwood Rd	Cook	T-1A
865	04	TS4755	Central Ave / Carpenter Rd	Pratt Ave	Cook	T-1A
866	03	TS4760	Central Ave	Roosevelt Rd	Cook	T-1A
867		TS4765	Central Rd	Wolf Rd	Cook	T-1A
868	01	TS4775	22nd St / Cermak Rd	57th St	Cook	T-1A
869	01	TS4780	22nd St / Cermak Rd	58th St	Cook	T-1A
870	01	TS4785	22nd St / Cermak Rd	Austin Blvd	Cook	T-1A
871	01	TS4790	22nd St / Cermak Rd	Central Ave	Cook	T-1A
872	01	TS4795	22nd St / Cermak Rd	Cermak Plaza North Entrance	Cook	T-1A
873	01	TS4800	22nd St / Cermak Rd	Des Plaines River Rd	Cook	T-1A
874	01	TS4805	22nd St / Cermak Rd	East Rd	Cook	T-1A
875	01	TS4810	22nd St / Cermak Rd	Home Ave	Cook	T-1A
876	01	TS4815	22nd St / Cermak Rd	Lombard Ave	Cook	T-1A
877	01	TS4820	22nd St / Cermak Rd	North Riverside Plaza W Entrance	Cook	T-1A
878	01	TS4825	22nd St / Cermak Rd	North Riverside Plaza E Entrance	Cook	T-1A
879	01	TS4830	22nd St / Cermak Rd	Oak Park Ave	Cook	T-1A
880	01	TS4835	22nd St / Cermak Rd	Ridgeland Ave	Cook	T-1A
881	01	TS4840	22nd St / Cermak Rd	Riverside Dr / Wesley Ave	Cook	T-1A
882	01	TS4845	22nd St / Cermak Rd	Wolf Rd	Cook	T-1A
883	01	TS4850	22nd St / Cermak Rd	Westbrook Corporate Center Entrance	Cook	T-1A
884	02	TS4851	22nd St / Cermak Rd	Enterprise Dr	Cook	T-1A
885	04	TS4855	Chicago Rd / South Park Ave	Indianwood Dr	Cook	T-1A
886		TS4870	Church St	Niles Center Rd	Cook	T-1A
887		TS4875	McCormick Blvd	Church St	Cook	T-1A
888	02	TS4885	Crawford Ave / Pulaski Rd	99th St	Cook	T-1A
889	02	TS4890	Crawford Ave / Pulaski Rd	119th St	Cook	T-1A
890		TS4892	Crawford Ave / Pulaski Rd	120th St / Jewel Entrance / Aldi Entrance	Cook	T-1A
891	03	TS4900	Crawford Ave / Pulaski Rd	167th St	Cook	T-1A
892	03	TS4905	Crawford Ave / Pulaski Rd	175th St	Cook	T-1A

Count	Grd Date	Loc #	Main Route	Nearest Cross Street	County	RM Pay Item
893		TS4907	Crawford Ave / Pulaski Rd	178th St / Cambridge Dr	Cook	T-1A
894		TS4910	Crawford Ave / Pulaski Rd	Devon Ave	Cook	T-1A
895		TS4915	Crawford Ave / Pulaski Rd	Golf Rd	Cook	T-1A
896	04	TS4920	Crawford Ave / Pulaski Rd	Harrison St / Old Orchard Rd	Cook	T-1A
897	03	TS4930	Crawford Ave / Pulaski Rd	Vollmer Rd	Cook	T-1A
898		TS4935	Crawford Ave / Pulaski Rd	Flossmoor Rd	Cook	T-1A
899	04	TS4940	87th St	California Ave	Cook	T-1A
900	03	TS4945	Crawford Ave / Pulaski Rd	Governors Highway	Cook	T-1A
901		TS4950	Crawford Ave / Hunter Rd	Wilmette Ave / Glenview Rd	Cook	T-1A
902	02	TS4955	Devon Ave	IL 171 (Cumberland Ave)	Cook	T-1A
903	01	TS4960	IL 171 (Cumberland Ave)	Forest Preserve Dr	Cook	T-1A
904	01	TS4965	IL 171 (Cumberland Ave)	Lawrence Ave	Cook	T-1A
905	02	TS4970	IL 171 (Cumberland Ave)	Montrose Ave / East River Rd	Cook	T-1A
906		TS4975	Des Plaines River Rd	Algonquin Rd	Cook	T-1A
907		TS4985	Des Plaines River Rd	Grand Ave	Cook	T-1A
908	01	TS4990	Des Plaines River Rd	Lawrence Ave	Cook	T-1A
909		TS4995	Oakton St	Des Plaines River Rd	Cook	T-1A
910	01	TS5000	Roosevelt Rd	Des Plaines Ave	Cook	T-1A
911		TS5005	Des Plaines River Rd	Touhy Ave	Cook	T-1A
912	01	TS5010	Des Plaines River Rd	Fullerton Ave	Cook	T-1A
913		TS5015	Dempster St	Crawford Ave / Pulaski Rd	Cook	T-1A
914		TS5017	Dempster St	Hamlin Ave	Cook	T-1A
915		TS5020	Dempster St	East Prairie Ave	Cook	T-1A
916	04	TS5025	Dempster St	St Louis Ave / Lincolnwood Dr	Cook	T-1A
917		TS5030	Dempster St	Keeler Ave	Cook	T-1A
918		TS5035	McCormick Blvd	Dempster St	Cook	T-1A
919		TS5040	Devon Ave	Dee Rd	Cook	T-1A
920		TS5045	Devon Ave	McCormick Blvd	Cook	T-1A
921		TS5047	US 41(Lincoln Ave)	Fire Station Exit	Cook	T-1A
922		TS5050	Dixie Highway / Roby St	167th St / 170th St	Cook	T-1A
923	03	TS5055	Dixie Highway	Holbrook Rd	Cook	T-1A
924	03	TS5060	Dixie Highway	Joe Orr Rd	Cook	T-1A
925	01	TS5065	Joliet Rd	East Ave	Cook	T-1A
926	01	TS5066	Joliet Rd	Quarry Mall Entrance	Cook	T-1A
927		TS5067	Joliet Rd	Circuit City Entrance / Quarry Mall Ent	Cook	T-1A
928		TS5070	Plainfield Rd	East Ave	Cook	T-1A
929		TS5075	East End Ave	Sauk Trail Rd	Cook	T-1A
930		TS5080	Elmhurst Rd / York Rd	Devon Ave	Cook	T-1A
931	04	TS5085	Plum Grove Rd	Euclid Ave	Cook	T-1A
932	04	TS5090	Euclid Ave	Wolf Rd	Cook	T-1A
933	01	TS5095	Forest Preserve Dr	Montrose Ave	Cook	T-1A
934	01	TS5100	Forest Preserve Dr	Oak Park Ave	Cook	T-1A
935		TS5105	Flossmoor Rd	Western Ave	Cook	T-1A
936		TS5110	Franklin Ave	Wolf Rd	Cook	T-1A
937		TS5115	Fullerton Ave	Thatcher Rd	Cook	T-1A
938	04	TS5120	Kensington Rd / Foundry Rd	Wolf Rd	Cook	T-1A
939	03	TS5125	Glenwood Dyer Rd	Cottage Grove Rd	Cook	T-1A

Count	Grd Date	Loc #	Main Route	Nearest Cross Street	County	RM Pay Item
940	03	TS5130	Glenwood Dyer Rd	Main St / Glenwood Lansing Rd	Cook	T-1A
941		TS5135	Glenview Rd	Greenwood Rd	Cook	T-1A
942	04	TS5140	Golf Rd	Central Park Ave	Cook	T-1A
943		TS5145	Golf Rd	East Prairie Ave	Cook	T-1A
944	02	TS5150	Golf Rd	Gross Point Rd	Cook	T-1A
945		TS5152	Gross Point Rd	Kenton Ave	Cook	T-1A
946		TS5155	Golf Rd	Harms Rd	Cook	T-1A
947		TS5157	Golf Rd	Woods Dr	Cook	T-1A
948	02	TS5160	Golf Rd	Lavergne Ave	Cook	T-1A
949	02	TS5165	Golf Rd	Lawler Ave	Cook	T-1A
950		TS5170	Golf Rd	McCormick Blvd	Cook	T-1A
951	04	TS5175	Golf Rd	Glenview Country Club Entrance	Cook	T-1A
952	03	TS5180	Governors Highway	Flossmoor Rd	Cook	T-1A
953	04	TS5185	Governors Highway	Kedzie Ave	Cook	T-1A
954		TS5195	Governors Highway	Poplar Ave	Cook	T-1A
955	03	TS5200	Governors Highway	Vollmer Rd	Cook	T-1A
956		TS5205	Grand Ave	Oak St / Struckman Ave	Cook	T-1A
957		TS5210	Grand Ave	Mt Prospect Rd / County Line Rd	Cook	T-1A
958		TS5211	Grand Ave	Northwest Ave	Cook	T-1A
959	02	TS5215	IL 171 (Thatcher Rd)	Grand Ave	Cook	T-1A
960		TS5220	Grand Ave	Wolf Rd	Cook	T-1A
961		TS5235	Greenwood Rd	Lake Ave	Cook	T-1A
962		TS5240	Gross Point Rd	Church St	Cook	T-1A
963		TS5245	Gross Point Rd	Harrison St / Old Orchard Rd	Cook	T-1A
964		TS5250	Gross Point Rd	Laramie Ave / Carol Ave	Cook	T-1A
965		TS5255	Gross Point Rd	Oakton St / Central Ave	Cook	T-1A
966		TS5260	Touhy Ave	Gross Point Rd	Cook	T-1A
967		TS5270	Gunnison St	Nagle Ave	Cook	T-1A
968		TS5275	Gunnison St	Oak Park Ave	Cook	T-1A
969		TS5285	Gross Point Rd / Harts Rd	IL 21 (Milwaukee Ave)	Cook	T-1A
970	04	TS5295	Hicks Rd	Cunningham Dr	Cook	T-1A
971	04	TS5300	Hicks Rd	Euclid Ave	Cook	T-1A
972	04	TS5305	Hicks Rd	Illinois Ave / Industrial Ave	Cook	T-1A
973	04	TS5315	Hicks Rd	Carpenter Dr	Cook	T-1A
974	02	TS5320	Hibbard Rd	Lake Ave	Cook	T-1A
975		TS5325	US 41 (Lincoln Ave)	Howard St	Cook	T-1A
976		TS5330	Howard St	Gross Point Rd / Menards Entrance	Cook	T-1A
977		TS5335	Howard St	Lehigh Ave	Cook	T-1A
978		TS5340	McCormick Blvd	Howard St	Cook	T-1A
979	03	TS5345	Indiana Ave	137th St	Cook	T-1A
980		TS5350	Indiana Ave	138th St	Cook	T-1A
981	02	TS5355	Joliet Rd	Brainard Ave	Cook	T-1A
982	03	TS5360	Joliet Rd	Lawndale Ave	Cook	T-1A
983	02	TS5365	Joliet Rd	Willow Springs Rd	Cook	T-1A
984		TS5370	Joliet Rd	Wolf Rd	Cook	T-1A
985	03	TS5375	Joliet Rd	Universal Oil Products Entrance	Cook	T-1A
986	03	TS5380	Kedzie Ave	119th St / Oakhill Cemetery Entrance	Cook	T-1A

Count	Grd Date	Loc #	Main Route	Nearest Cross Street	County	RM Pay Item
987	03	TS5385	Kedzie Ave	123rd St	Cook	T-1A
988	04	TS5390	Kensington Rd / Foundry Rd	Wheeling Rd	Cook	T-1A
989		TS5395	Kirchoff Rd	Wilke Rd	Cook	T-1A
990		TS5425	Lake Cook Rd	Quentin Rd	Cook	T-1A
991		TS5430	Lake Cook Rd	Sheridan Rd	Cook	T-1A
992		TS5435	Lawrence Ave	East River Rd / Dee Rd	Cook	T-1A
993		TS5440	Lawrence Ave	Forster Rd	Cook	T-1A
994		TS5445	Lee St	Touhy Ave	Cook	T-1A
995	04	TS5448	Oakton St	River Dr	Cook	T-1A
996		TS5450	Lehigh Ave	Oakton St	Cook	T-1A
997		TS5455	Lehigh Ave	Touhy Ave	Cook	T-1A
998	03	TS5460	Madison St	Jackson Blvd	Cook	T-1A
999		TS5465	McCormick Blvd	Main St	Cook	T-1A
1000	04	TS5475	McCormick Blvd	Pratt Ave	Cook	T-1A
1001	04	TS5477	McCormick Blvd	Northeast Parkway	Cook	T-1A
1002		TS5480	McCormick Blvd	Touhy Ave	Cook	T-1A
1003		TS5483	Touhy Ave	Kedzie Ave	Cook	T-1A
1004		TS5485	McCormick Blvd	Oakton St	Cook	T-1A
1005		TS5490	IL 21 (Milwaukee Ave)	Touhy Ave	Cook	T-1A
1006		TS5495	IL 21 (Milwaukee Ave)	IL 43 (Waukegan Rd)	Cook	T-1A
1007	01	TS5500	Montrose Ave	Narragansett Ave	Cook	T-1A
1008		TS5505	Northwest Highway	Oakton St	Cook	T-1A
1009		TS5510	Northwest Highway	Potter Rd	Cook	T-1A
1010	03	TS5515	Oak Park Ave	31st St	Cook	T-1A
1011	01	TS5520	US 34 (Ogden Ave)	Oak Park Ave	Cook	T-1A
1012	01	TS5525	Roosevelt Rd	Oak Park Ave	Cook	T-1A
1013	03	TS5530	Oak Park Ave	151st St	Cook	T-1A
1014	04	TS5535	Oakton St	Florence Dr	Cook	T-1A
1015	02	TS5540	Oakton St	Greenwood Rd	Cook	T-1A
1016		TS5545	Oakton St	Mt Prospect Rd	Cook	T-1A
1017		TS5550	Oakton St	Wolf Rd	Cook	T-1A
1018	01	TS5555	US 34 (Ogden Ave)	31st St	Cook	T-1A
1019		TS5556	US 34 (Ogden Ave)	25th Pl / 26th St	Cook	T-1A
1020		TS5557	IL 50 (Cicero Ave)	Connector Ramp	Cook	T-1A
1021		TS5558	US 34 (Ogden Ave)	Connector Ramp	Cook	T-1A
1022	02	TS5565	US 34 (Ogden Ave)	Austin Blvd	Cook	T-1A
1023	01	TS5570	US 34 (Ogden Ave)	Clarence Ave	Cook	T-1A
1024	01	TS5575	US 34 (Ogden Ave)	Clinton St	Cook	T-1A
1025	01	TS5580	US 34 (Ogden Ave)	East Ave	Cook	T-1A
1026	01	TS5590	US 34 (Ogden Ave)	Home Ave	Cook	T-1A
1027	02	TS5595	US 34 (Ogden Ave)	Ridgeland Ave / 34th St	Cook	T-1A
1028	04	TS5600	Old Plum Grove Rd	Meacham Rd	Cook	T-1A
1029	07	TS5605	Palatine Rd	Kennicott Dr	Cook	T-1A
1030		TS5610	Palatine Rd	Quentin Rd	Cook	T-1A
1031	07	TS5620	Palatine Rd	Schoenbeck Rd	Cook	T-1A
1032	07	TS5625	Palatine Rd	Wheeling Rd	Cook	T-1A
1033	07	TS5630	Palatine Rd	Windsor Dr	Cook	T-1A

Count	Grd Date	Loc #	Main Route	Nearest Cross Street	County	RM Pay Item
1034		TS5640	Palatine Rd	Wolf Rd	Cook	T-1A
1035		TS5645	Palatine Rd	Ela Rd	Cook	T-1A
1036		TS5650	171st St	Park Ave	Cook	T-1A
1037		TS5655	Willow Rd	Pfingsten Rd	Cook	T-1A
1038		TS5665	Plum Grove Rd	Kirchoff Rd	Cook	T-1A
1039		TS5670	Colfax Ave	Quentin Rd	Cook	T-1A
1040	03	TS5675	Ridgeland Ave	96th St	Cook	T-1A
1041	03	TS5680	Ridgeland Ave	98th St	Cook	T-1A
1042	03	TS5690	Ridgeland Ave	Ridgeland Commons SC Entrance	Cook	T-1A
1043		TS5695	Ridge Rd	Ashland Ave / Riegel Ave	Cook	T-1A
1044	03	TS5710	Riegel Ave	Holbrook Rd	Cook	T-1A
1045		TS5715	IL 53 (Rohlwing Rd)	Devon Ave	Cook	T-1A
1046	01	TS5720	Roosevelt Rd	5th Ave	Cook	T-1A
1047	01	TS5725	Roosevelt Rd	9th Ave	Cook	T-1A
1048	01	TS5730	Roosevelt Rd	Austin Ave	Cook	T-1A
1049	01	TS5735	Roosevelt Rd	East Ave	Cook	T-1A
1050		TS5740	Roosevelt Rd	Laramie Ave	Cook	T-1A
1051	01	TS5745	Roosevelt Rd	Mayfield Ave	Cook	T-1A
1052	01	TS5750	Roosevelt Rd	Ridgeland Ave	Cook	T-1A
1053		TS5755	Sauk Trail Rd	State St	Cook	T-1A
1054	04	TS5760	Sauk Trail Rd	Torrence Ave	Cook	T-1A
1055		TS5765	Sheridan Rd	Lake Ave	Cook	T-1A
1056		TS5770	Willow Rd	Shermer Rd	Cook	T-1A
1057		TS5780	State Rd	Central Ave / 80th St	Cook	T-1A
1058	04	TS5785	State St	Illinois St	Cook	T-1A
1059	04	TS5790	State St	Steger Rd	Cook	T-1A
1060		TS5795	St Charles Rd	Taft Ave	Cook	T-1A
1061		TS5800	St Charles Rd	Wolf Rd	Cook	T-1A
1062		TS5810	Talcott Ave	Dee Rd	Cook	T-1A
1063		TS5815	Talcott Ave	Touhy Ave	Cook	T-1A
1064	04	TS5820	IL 83 (Torrence Ave)	Dolton Rd / State St / 146th St	Cook	T-1A
1065		TS5825	Touhy Ave	Crawford Ave	Cook	T-1A
1066		TS5830	Touhy Ave	Dee Rd	Cook	T-1A
1067		TS5835	Touhy Ave	Kostner Ave	Cook	T-1A
1068		TS5840	Touhy Ave	Mobile Ave	Cook	T-1A
1069		TS5841	Touhy Ave	Meade Ave	Cook	T-1A
1070		TS5843	Touhy Ave	Melvina Ave	Cook	T-1A
1071	04	TS5845	Touhy Ave	Riverside Dr	Cook	T-1A
1072		TS5850	Washington Blvd / Randolph St	Lathrop Ave	Cook	T-1A
1073	03	TS5855	Western Ave	91st St	Cook	T-1A
1074		TS5860	Western Ave	98th St	Cook	T-1A
1075	03	TS5865	Western Ave	99th St	Cook	T-1A
1076		TS5870	Western Ave	119th St	Cook	T-1A
1077	03	TS5875	123rd St	Western Ave	Cook	T-1A
1078	03	TS5880	139th St	Western Ave	Cook	T-1A
1079	03	TS5885	Western Ave	Monee Rd	Cook	T-1A
1080	03	TS5890	Western Ave	Steger Rd	Cook	T-1A

Count	Grd Date	Loc #	Main Route	Nearest Cross Street	County	RM Pay Item
1081	03	TS5895	Western Ave	Vollmer Rd	Cook	T-1A
1082	04	TS5900	Western Ave	Illinois St / 16th St	Cook	T-1A
1083		TS5915	Willow Rd	Greenwood Ave	Cook	T-1A
1084		TS5920	Willow Rd	Landwehr Rd	Cook	T-1A
1085		TS5925	Willow Rd	Sanders Rd	Cook	T-1A
1086		TS5930	Willow Rd	Old Willow Rd	Cook	T-1A
1087		TS5931	Willow Rd	Ravina Way	Cook	T-1A
1088		TS5932	Willow Rd	Patriot Blvd	Cook	T-1A
1089		TS5933	Willow Rd	Westleigh Dr Founders Dr	Cook	T-1A
1090		TS5935	Willow Springs Rd	Plainfield Rd	Cook	T-1A
1091		TS5940	Wireton Rd	Francisco Ave	Cook	T-1A
1092	04	TS5944	Wolf Rd	Edward Rd	Cook	T-1A
1093	04	TS5945	Wolf Rd	Camp McDonald Rd	Cook	T-1A
1094	04	TS5950	Wolf Rd	Willow Rd / Old Willow Rd	Cook	T-1A
1095	04	TS5955	Wolf Rd	Howard St	Cook	T-1A
1096	04	TS5965	Wood St	171st St	Cook	T-1A
1097		TS6077	US 20 (Lake St)	North Ave / East Bartlett Rd	Cook	T-1A
1098	04	TS6612	US 45 (LaGrange Rd)	IL 83 (Cal Sag Rd) W Ramps	Cook	T-1A
1099	04	TS6613	US 45 (LaGrange Rd)	IL 83 (Cal Sag Rd) E Ramps	Cook	T-1A
1100		TS7185	Lake Cook Rd	Hart Rd	Cook	T-1A
1101		TS7417	US 45 (La Grange Rd)	183rd St	Cook	T-1A
1102		TS7635	IL 19 (Irving Park Rd)	Rodenburg Rd	Cook	T-1A
1103	04	TS7937	IL 19 (Irving Park Rd)	Wright Blvd	Cook	T-1A
1104		TS7645	IL 43 (Harlem Ave)	Grand Ave / Fullerton Ave	Cook	T-1A
1105	04	TS7655	IL 62 (Algonquin Rd)	Lexington Dr	Cook	T-1A
1106	02	TS7860	Barrington Rd	Tower Dr	Cook	T-1A
1107	04	TS7885	IL 62 (Algonquin Rd)	Quentin Rd	Cook	T-1A
1108		TS7947	IL 43 (Harlem Ave)	34th St / Windsor Ave	Cook	T-1A
1109		TS7950	IL 43 (Harlem Ave)	32nd St	Cook	T-1A
1110		TS8780	IL 58 (Golf Rd)	Woodfield Mall Center Entrance	Cook	T-1A
1111		TS8785	IL 58 (Golf Rd)	Woodfield Mall W Entrance	Cook	T-1A
1112		TS8790	IL 58 (Golf Rd)	Woodfield Mall E Ent / Hyatt Entrance	Cook	T-1A
1113	01	TS8800	IL 64 (North Ave)	Winston Plaza Entrance	Cook	T-1A
1114	02	TS8905	Golf Rd	Lamon Ave / Old Orchard SC E Entrance	Cook	T-1A
1115	01	TS8910	IL 43 (Harlem Ave)	167th St	Cook	T-1A
1116	01	TS8920	IL 43 (Harlem Ave)	171st St	Cook	T-1A
1117	01	TS8935	IL 43 (Harlem Ave)	163rd St / Brementown Rd	Cook	T-1A
1118		TS8940	IL 19 (Irving Park Rd)	Park Blvd	Cook	T-1A
1119		TS9085	IL 72 (Higgins Rd)	Devon Ave	Cook	T-1A
1120		TS9090	IL 72 (Higgins Rd)	Scott St	Cook	T-1A
1121	02	TS9185	Talcott Ave	Cumberland Ave	Cook	T-1A
1122		TS9190	Cumberland (in Park Ridge)	Touhy Ave (in Park Ridge)	Cook	T-1A
1123	02	TS9205	Talcott Ave	Greenwood Rd	Cook	T-1A
1124		TS9215	Northwest Hwy	Meacham Ave	Cook	T-1A
1125		TS9220	Northwest Hwy	Washington St	Cook	T-1A
1126		TS9222	Touhy Ave	Summit	Cook	T-1A
1127		TS9240	Busse Hwy	Meacham Touhy (in Park Ridge)	Cook	T-1A

Count	Grd Date	Loc #	Main Route	Nearest Cross Street	County	RM Pay Item
1128	02	TS9245	Devon Ave	Talcott Ave / Cortland Ave	Cook	T-1A
1129		TS9247	US 14 Northwest Hwy	Summit	Cook	T-1A
1130		TS9250	US 14 Northwest Hwy	Prospect Ave (in Park Ridge)	Cook	T-1A
1131		TS9255	Touhy Ave	Washington St	Cook	T-1A
1132	04	TS9295	Western Ave	26th St	Cook	T-1A
1133	04	TS9297	Western Ave	Norwood Square SC Entrance	Cook	T-1A
1134	04	TS9300	Western Ave	Beacon Blvd	Cook	T-1A
1135	02	TS9335	Crawford Ave / Pulaski Rd	107th St	Cook	T-1A
1136	01	TS9360	22nd St / Cermak Rd	Mid City Bank Ent / N Riverside Plaza	Cook	T-1A
1137		TS9625	IL 83 (Elmhurst Rd)	Lonnquist Blvd	Cook	T-1A
1138		TS9630	IL 83 (Elmhurst Rd)	US 14 (Northwest Highway)	Cook	T-1A
1139		TS9640	US 14 (Northwest Highway)	Emerson St	Cook	T-1A
1140	04	TS9653	Central Rd	Busse Rd	Cook	T-1A
1141		TS9654	3 Com Entrance	Central Rd	Cook	T-1A
1142	04	TS9660	IL 83 (Elmhurst Rd)	Central Rd	Cook	T-1A
1143		TS9665	IL 83 (Elmhurst Rd)	Council Tr	Cook	T-1A
1144		TS9670	IL 83 (Elmhurst Rd)	Lincoln St	Cook	T-1A
1145		TS9690	US 14 (Northwest Highway)	Central Rd	Cook	T-1A
1146	03	TS9727	143rd St	Justamere Rd	Cook	T-1A
1147	03	TS9950	US 6 (159th St)	Oak Forest Hospital Entrance	Cook	T-1A
1148		TS10125	IL 43 (Harlem Ave)	Harlem Irving Plaza	Cook	T-1A
1149		TS10595	IL 43 (Waukegan Rd)	Kraft Food Entrance / Three Lakes Dr	Cook	T-1A
1150	04	TS10635	US 6 (159th St)	Central Park Ave	Cook	T-1A
1151	04	TS10640	US 6 (159th St)	Richmond Ave	Cook	T-1A
1152		TS10880	IL 43 (Waukegan Rd)	Dewes St / River Dr	Cook	T-1A
1153		TS10900	IL 43 (Waukegan Rd)	Carillon Square Entrance	Cook	T-1A
1154		TS10905	IL 43 (Waukegan Rd)	Glenview Rd	Cook	T-1A
1155	01	TS10915	IL 64 (North Ave)	Jewel Foods Plant Entrance	Cook	T-1A
1156	04	TS10920	IL 43 (Waukegan Rd)	Grove St	Cook	T-1A
1157	02/04	TS10970	US 12/45 (Mannheim Rd)	Belmont Ave	Cook	T-1A
1158	01	TS11015	US 12/45 (Mannheim Rd)	Grand Ave	Cook	T-1A
1159	01	TS11030	US 12/45 (Mannheim Rd)	Seymour Ave	Cook	T-1A
1160	01	TS11035	US 12/45 (Mannheim Rd)	Waveland Ave	Cook	T-1A
1161		TS11040	Des Plaines River Rd	King Ave	Cook	T-1A
1162	01	TS11080	55th St	Electro Motive Dr	Cook	T-1A
1163	01	TS11086	55th St	Sergo Dr	Cook	T-1A
1164		TS11130	IL 59 (Sutton Rd)	Shoe Factory Rd	Cook	T-1A
1165		TS11133	IL 72 (Higgins Rd)	Shoe Factory Rd	Cook	T-1A
1166		TS11161	Touhy Ave	Northpoint Plaza Entrance / Circuit City	Cook	T-1A
1167	02	TS11170	IL 58 (Golf Rd)	Michael Manor	Cook	T-1A
1168		TS11175	US 12/45 (Mannheim Rd)	Devon Ave / Zemke Blvd	Cook	T-1A
1169		TS11185	Devon Ave	Kenton Ave / Lemont Ave	Cook	T-1A
1170		TS11190	US 30 (Lincoln Highway)	Matteson Shopping Center Entrance	Cook	T-1A
1171	02	TS11210	IL 58 (Golf Rd)	Milwaukee Plaza Entrance / Toys R Us Ent	Cook	T-1A
1172		TS11245	US 12/45 (Lee St)	US 12/45 (Mannheim Rd)	Cook	T-1A
1173		TS11250	Touhy Ave	Central Ave	Cook	T-1A

Count	Grd Date	Loc #	Main Route	Nearest Cross Street	County	RM Pay Item
1174		TS11270	US 20 (Lake St)	Bartlett Rd	Cook	T-1A
1175		TS11280	IL 59 (Hough Rd)	Main St / Lake Cook Rd	Cook	T-1A
1176		TS11282	Main St / Lake Cook Rd	Applebee's Entrance	Cook	T-1A
1177		TS11285	Barrington Rd	Palatine Rd	Cook	T-1A
1178		TS11290	US 12 (Rand Rd)	IL 53 W Ramps	Cook	T-1A
1179		TS11295	US 12 (Rand Rd)	IL 53 E Ramps	Cook	T-1A
1180		TS11305	Pfingsten Rd	West Lake Ave	Cook	T-1A
1181		TS11310	IL 72 (Higgins Rd / Oakton St)	IL 83 (Busse Rd)	Cook	T-1A
1182		TS11320	Arlington Heights Rd	Northwest Point Blvd S Junction	Cook	T-1A
1183	01	TS11325	IL 43 (Harlem Ave)	161st St	Cook	T-1A
1184	01	TS11330	US 6 (159th St)	Park Center Plaza Entrance	Cook	T-1A
1185	04	TS11345	US 30 (Lincoln Highway)	Mid Continent Dr	Cook	T-1A
1186	03	TS11350	US 6/IL 83 (Torrence Ave)	Landings Shopping Center Entrance	Cook	T-1A
1187		TS11355	Margaret St / Thornton Lansing Rd	Williams St / Vincennes Rd	Cook	T-1A
1188		TS11356	Margaret St / Thornton Lansing Rd	Schwab St	Cook	T-1A
1189		TS11360	Williams St / Vincennes Rd	Eleanor St	Cook	T-1A
1190	03	TS11460	IL 83 (147th St / Sibley Blvd)	Woodlawn Ave	Cook	T-1A
1191	03	TS11465	IL 83 (147th St / Sibley Blvd)	Greenwood Rd	Cook	T-1A
1192	03	TS11470	IL 83 (147th St / Sibley Blvd)	Engle Pl	Cook	T-1A
1193	03	TS11475	IL 83 (147th St / Sibley Blvd)	Cottage Grove Ave	Cook	T-1A
1194	03	TS11635	IL 171 (Archer Ave)	65th St	Cook	T-1A
1195	04	TS11640	US 12/20 (95th St)	Kean Ave	Cook	T-1A
1196	02	TS11645	IL 50 (Cicero Ave)	23rd St	Cook	T-1A
1197		TS11690	IL 68 (Dundee Rd)	Northgate Parkway	Cook	T-1A
1198		TS11695	US 14	Elm St	Cook	T-1A
1199	02	TS11710	US 6 (159th St)	Arroyo Dr	Cook	T-1A
1200		TS11715	Western Ave	Sauk Trail Rd	Cook	T-1A
1201		TS11716	Western Ave	South St / Main St	Cook	T-1A
1202	03	TS11720	IL 50 (Cicero Ave)	175th St	Cook	T-1A
1203	04	TS11725	Dixie Highway	Flossmoor Rd / Cambridge Ave	Cook	T-1A
1204		TS11730	Hicks Rd	Northrop Grummen Corp Entrance	Cook	T-1A
1205		TS11735	Hicks Rd	Hellen Rd	Cook	T-1A
1206		TS11745	IL 394	Sauk Trail Rd	Cook	T-1A
1207		TS11750	US 6 (159th St)	Park Ave	Cook	T-1A
1208		TS11755	Ashland Ave/Wood St	Thornton Blue Island Rd	Cook	T-1A
1209	01	TS11760	US 12/20 (95th St)	76th Ave	Cook	T-1A
1210	03	TS11765	US 12/20 (95th St)	88th Ave	Cook	T-1A
1211	03	TS11770	Ridgeland Ave	IL 7 (Southwest Highway)	Cook	T-1A
1212	01	TS11785	US 12/20 (95th St)	California Ave	Cook	T-1A
1213	01	TS11790	US 12/20 (95th St)	Utica Ave	Cook	T-1A
1214	01	TS11800	22nd St / Cermak Rd	1st Ave Cutoff	Cook	T-1A
1215		TS11805	IL 171 (1st Ave) Frontage Rd	47th St W Ramps	Cook	T-1A
1216		TS11810	IL 171 (1st Ave) Frontage Rd	47th St E Ramps	Cook	T-1A
1217		TS11853	94th Ave	Kedzie Ave	Cook	T-1A
1218	07	TS11860	IL 68 (Dundee Rd)	Ela Rd	Cook	T-1A
1219	04	TS11865	Main St (Vincennes Rd)	Glenwood Rd	Cook	T-1A
1220		TS11870	IL 72 (Touhy Ave)	Lee St SB Ramp / Trammel Crow	Cook	T-1A

Count	Grd Date	Loc #	Main Route	Nearest Cross Street	County	RM Pay Item
1221		TS11965	IL 64 (North Ave)	Polk Plaza Shopping Center Entrance	Cook	T-1A
1222		TS11985	US 14 (Northwest Highway)	Hicks Rd N Junction	Cook	T-1A
1223	04	TS12000	US 6/IL 83 (Torrence Ave)	Bernice Rd / 173rd St	Cook	T-1A
1224		TS12005	Hicks Rd	Old Hicks Rd	Cook	T-1A
1225		TS12010	IL 58 (Dempster St)	Gross Point Rd	Cook	T-1A
1226		TS12015	IL 56 (Butterfield Rd)	Taft Ave	Cook	T-1A
1227		TS12025	Lawrence Ave	25th Ave / Ruby St	Cook	T-1A
1228	02	TS12035	Crawford Ave/Pulaski Rd	93rd St	Cook	T-1A
1229	04	TS12075	IL 72 (Higgins Rd)	Huntington Blvd	Cook	T-1A
1230		TS12090	Touhy Ave	Barclay Pl / Hyatt Dr	Cook	T-1A
1231		TS12102	State St	Armory Dr	Cook	T-1A
1232	03	TS12105	142nd St	Cottage Grove Rd	Cook	T-1A
1233	04	TS12115	IL 1 (Halsted St)	Park Place Plaza Entrance	Cook	T-1A
1234	04	TS12125	IL 83 (Busse Rd)	Howard St	Cook	T-1A
1235	02	TS12135	111th St	Kostner Ave	Cook	T-1A
1236		TS12155	IL 53/IL 68 (Dundee Rd)	IL 53 E Ramps	Cook	T-1A
1237		TS12160	IL 53/IL 68 (Dundee Rd)	IL 53 W Ramps	Cook	T-1A
1238		TS12165	27th Ave	US 20 (Lake St)	Cook	T-1A
1239	04	TS12175	US 12 (Rand Rd)	Winslowe Dr / Park Pl	Cook	T-1A
1240	03	TS12220	IL 171 (Archer Ave)	66th Pl	Cook	T-1A
1241	04	TS12400	IL 50 (Cicero Ave)	Southwick Dr	Cook	T-1A
1242		TS12403	IL 50 (Cicero Ave)	Wal Mart Entrance	Cook	T-1A
1243	04	TS12404	IL 50 (Cicero Ave)	North Gateway Dr	Cook	T-1A
1244	03	TS12530	IL 43 (Harlem Ave)	100th Pl	Cook	T-1A
1245		TS12535	Arlington Heights Rd	White Oak St	Cook	T-1A
1246		TS12540	Arlington Heights Rd	Central Rd	Cook	T-1A
1247		TS12550	Arlington Heights Rd	Sigwalt St	Cook	T-1A
1248		TS12555	Arlington Heights Rd	US 14 (Northwest Highway)	Cook	T-1A
1249		TS12560	Arlington Heights Rd	Miner St	Cook	T-1A
1250		TS12565	Arlington Heights Rd	Euclid St	Cook	T-1A
1251	04	TS12585	Arlington Heights Rd	Lillian Ave	Cook	T-1A
1252		TS12590	Arlington Heights Rd	Palatine Rd	Cook	T-1A
1253	04	TS12595	Arlington Heights Rd	US 12 (Rand Rd)	Cook	T-1A
1254		TS12600	Arlington Heights Rd	North Point SC Entrance	Cook	T-1A
1255		TS12615	Central Rd	Kirchoff Rd	Cook	T-1A
1256		TS12620	Central Rd	Arthur Ave / McKinley Ave	Cook	T-1A
1257	04	TS12625	US 12 (Rand Rd)	Cub Foods Entrance	Cook	T-1A
1258		TS12630	US 12 (Rand Rd)	Palatine Rd	Cook	T-1A
1259	04	TS12635	US 12 (Rand Rd)	Northpoint Center Entrance	Cook	T-1A
1260	04	TS12640	US 12 (Rand Rd)	Arlington Plaza Entrance	Cook	T-1A
1261		TS12660	Euclid St	US 14 (Northwest Highway)	Cook	T-1A
1262		TS12665	US 14 (Northwest Highway)	Arthur Ave / McKinley Ave / Davis St	Cook	T-1A
1263		TS12675	US 14 (Northwest Highway)	Evergreen Ave	Cook	T-1A
1264		TS12680	US 14 (Northwest Highway)	Dunton Ave	Cook	T-1A
1265		TS12685	US 14 (Northwest Highway)	Vail Ave	Cook	T-1A
1266		TS12690	US 14 (Northwest Highway)	Walnut Ave / Ridge Ave	Cook	T-1A
1267	04	TS12700	US 12 (Rand Rd)	Annex of Arlington SC Entrance	Cook	T-1A

Count	Grd Date	Loc #	Main Route	Nearest Cross Street	County	RM Pay Item
1268		TS12770	IL 50 (Cicero Ave)	22nd St / Cermak Rd	Cook	T-1A
1269	03	TS12775	22nd St / Cermak Rd	49th Ave	Cook	T-1A
1270	03	TS12780	22nd St / Cermak Rd	50th Ave	Cook	T-1A
1271		TS12785	22nd St / Cermak Rd	Laramie Ave	Cook	T-1A
1272	01	TS12790	22nd St / Cermak Rd	54th Ave	Cook	T-1A
1273		TS12795	IL 50 (Cicero Ave)	16th St	Cook	T-1A
1274	02	TS12825	IL 50 (Cicero Ave)	19th St	Cook	T-1A
1275	02	TS12830	IL 50 (Cicero Ave)	29th St	Cook	T-1A
1276	04	TS12985	Touhy Ave	Maple St	Cook	T-1A
1277		TS12995	Oakton St	Webster Ln	Cook	T-1A
1278		TS13000	US 12/45 (Lee St)	Algonquin Rd	Cook	T-1A
1279	04	TS13005	IL 62 (Algonquin Rd)	Seymour Ave	Cook	T-1A
1280		TS13020	IL 58 (Golf Rd)	Mt Prospect Rd	Cook	T-1A
1281	02	TS13025	US 12/45 (Lee St)	Prairie Ave	Cook	T-1A
1282	02	TS13026	US 12/45 (Lee St)	Thacker St	Cook	T-1A
1283	02	TS13027	US 12/45 (Graceland Ave)	Thacker St	Cook	T-1A
1284		TS13035	US 12/45 (Lee St)	US 14 (Miner St) / Ellenwood St	Cook	T-1A
1285	02	TS13040	US 14 (Northwest Highway/Miner St)	Pearson St	Cook	T-1A
1286	02	TS13050	US 12/45 (Graceland Ave)	Prairie Ave	Cook	T-1A
1287	02	TS13055	US 12/45 (Graceland Ave)	US 14 (Miner St) / Jefferson St	Cook	T-1A
1288		TS13065	US 12/45 (Mannheim Rd)	Prospect Ave	Cook	T-1A
1289		TS13070	Des Plaines River Rd	Perry St	Cook	T-1A
1290		TS13075	US 14 (Miner St)	Des Plaines River Rd	Cook	T-1A
1291		TS13080	US 14 (Northwest Highway)	State St / Cornell Ave	Cook	T-1A
1292		TS13085	US 12 (Rand Rd)	3rd Ave	Cook	T-1A
1293	04	TS13140	IL 72 (Higgins Rd)	Lively Blvd	Cook	T-1A
1294		TS13145	IL 53 (Rohlwing Rd)	Nerge Rd	Cook	T-1A
1295		TS13150	IL 53 (Rohlwing Rd)	Biesterfield Rd	Cook	T-1A
1296		TS13285	IL 58 Summit	Hiawatha Dr	Cook	T-1A
1297		TS13286	IL 58 Summit	Waverly Dr	Cook	T-1A
1298		TS13440	IL 19 (Irving Park Rd)	Willard St	Cook	T-1A
1299		TS13470	Wolf Rd	Thacker St / Dempster St	Cook	T-1A
1300		TS13685	Des Plaines Ave	Jackson Blvd	Cook	T-1A
1301		TS13687	CTA	Des Plaines Ave	Cook	T-1A
1302	01	TS13700	Roosevelt Rd	Circle Ave	Cook	T-1A
1303	01	TS13745	IL 19 (Irving Park Rd)	Barrington Rd	Cook	T-1A
1304	01	TS13750	IL 19 (Irving Park Rd)	Tradewinds SC Entrance	Cook	T-1A
1305	01	TS13755	IL 19 (Irving Park Rd)	Kingsbury Dr	Cook	T-1A
1306	02	TS13756	IL 19 (Irving Park Rd)	Westview SC Entrance	Cook	T-1A
1307		TS13762	US 20 (Lake St)	Center Ave	Cook	T-1A
1308		TS13765	US 20 (Lake St)	Barrington Rd	Cook	T-1A
1309	02	TS13855	US 34 (Ogden Ave)	Brainard Ave	Cook	T-1A
1310	02	TS13860	US 34 (Ogden Ave)	Waiola Ave	Cook	T-1A
1311	02	TS13865	US 34 (Ogden Ave)	Kensington Ave	Cook	T-1A
1312	02	TS13870	US 34 (Ogden Ave)	Eberle Ave / East Ave	Cook	T-1A
1313	02	TS13871	US 34 (Ogden Ave)	DuBois Blvd	Cook	T-1A
1314	02	TS13872	US 34 (Ogden Ave)	Maple Ave	Cook	T-1A

Count	Grd Date	Loc #	Main Route	Nearest Cross Street	County	RM Pay Item
1315	02	TS13873	US 34 (Ogden Ave)	Prairie Ave	Cook	T-1A
1316	02	TS13880	US 12/20/45 (La Grange Rd)	Harris Ave	Cook	T-1A
1317		TS13885	US 12/20/45 (La Grange Rd)	Cossitt Ave	Cook	T-1A
1318	01	TS13890	47th St	Gilbert Ave / Willow Springs Rd	Cook	T-1A
1319	01	TS13895	47th St	Edgewood Ave	Cook	T-1A
1320	02	TS13900	Brainard Ave	47th St	Cook	T-1A
1321	07	TS13905	US 12/20/45 (La Grange Rd)	Burlington Ave / Hillgrove Ave	Cook	T-1A
1322	02	TS13910	US 12/20/45 (La Grange Rd)	US 34 (Ogden Ave)	Cook	T-1A
1323	02	TS13915	US 12/20/45 (La Grange Rd)	Harding Ave	Cook	T-1A
1324	02	TS13920	US 12/20/45 (La Grange Rd)	Homestead Rd / Pine Ave	Cook	T-1A
1325		TS13923	31st St	Brainard Ave	Cook	T-1A
1326	03	TS13925	31st St	Forest Rd	Cook	T-1A
1327	03	TS13930	31st St	Raymond Ave	Cook	T-1A
1328	03	TS13940	IL 83 (Torrence Ave)	178th St	Cook	T-1A
1329		TS13942	I 80 94	Torrence	Cook	T-1A
1330	02	TS14155	IL 171 (1st Ave)	US 34 (Ogden Ave)	Cook	T-1A
1331	02	TS14157	US 34 (Ogden Ave)	Lawndale Ave	Cook	T-1A
1332	03	TS14160	IL 171 (1st Ave)	Plainfield Rd	Cook	T-1A
1333	02	TS14165	IL 171 (1st Ave)	44th St	Cook	T-1A
1334	02	TS14170	US 34 (Ogden Ave)	Plainfield Rd	Cook	T-1A
1335	02	TS14175	US 34 (Ogden Ave)	Custer Ave	Cook	T-1A
1336		TS14190	5th Ave	Washington Blvd	Cook	T-1A
1337	03	TS14195	5th Ave	Madison St	Cook	T-1A
1338	03	TS14200	5th Ave	Lake St	Cook	T-1A
1339		TS14205	5th Ave	Chicago Ave	Cook	T-1A
1340		TS14215	17th Ave	Madison St	Cook	T-1A
1341		TS14220	9th Ave	Lake St	Cook	T-1A
1342	03	TS14245	9th Ave	Chicago Ave	Cook	T-1A
1343	01	TS14265	IL 64 (North Ave)	15th Ave	Cook	T-1A
1344		TS14270	Golf Rd	Narragansett Ave / Overlook Dr	Cook	T-1A
1345		TS14275	IL 43/IL 58 (Waukegan Rd)	Emerson St	Cook	T-1A
1346		TS14280	IL 43/IL 58 (Waukegan Rd)	Beckwith Rd	Cook	T-1A
1347		TS14285	IL 58 (Dempster St)	Prairie View Park Entrance	Cook	T-1A
1348		TS14325	Oakton St	Austin Ave	Cook	T-1A
1349		TS14330	Oakton St	Menard Ave	Cook	T-1A
1350	01	TS14375	IL 171 (Cumberland Ave)	Foster Ave	Cook	T-1A
1351		TS14395	IL 43 (Harlem Ave)	Cullom Ave	Cook	T-1A
1352	04	TS14400	IL 43 (Waukegan Rd)	Walters Ave	Cook	T-1A
1353		TS14430	IL 43 (Waukegan Rd)	Shermer Rd	Cook	T-1A
1354	04	TS14480	IL 43 (Waukegan Rd)	Christian Heritage School Entrance	Cook	T-1A
1355	04	TS14715	Palatine Rd	Smith St	Cook	T-1A
1356		TS14720	Palatine Rd	Brockway St	Cook	T-1A
1357		TS14725	Palatine Rd	Plum Grove Rd	Cook	T-1A
1358	04	TS14730	Hicks Rd	First Bank Dr / Palatine Mall Entrance	Cook	T-1A
1359		TS14741	IL 62 (Algonquin Rd)	Carriage Way / Essex Way	Cook	T-1A
1360	04	TS14744	IL 62 (Algonquin Rd)	Weber Rd / Old Wilke Rd	Cook	T-1A
1361		TS14750	IL 62 (Algonquin Rd)	Hammond Dr	Cook	T-1A

Count	Grd Date	Loc #	Main Route	Nearest Cross Street	County	RM Pay Item
1362		TS14755	IL 62 (Algonquin Rd)	Motorola E Dr / Village Tree Entrance	Cook	T-1A
1363		TS14760	IL 62 (Algonquin Rd)	Motorola W Dr / Plum Grove Rd	Cook	T-1A
1364		TS14765	IL 62 (Algonquin Rd)	Thoreau Dr / Thorntree Ln	Cook	T-1A
1365	02	TS14780	IL 62 (Algonquin Rd)	Meacham Rd	Cook	T-1A
1366		TS14820	Howard St	Niles Center Rd	Cook	T-1A
1367		TS14835	Touhy Ave	Niles Center Rd / Carpenter Rd	Cook	T-1A
1368	04	TS14840	Touhy Ave	Laramie Ave	Cook	T-1A
1369	04	TS14845	Touhy Ave	Leclair Ave	Cook	T-1A
1370	02	TS14855	US 12/45 (Mannheim Rd)	Hirsch Ave / Soffel Ave	Cook	T-1A
1371	01	TS15105	US 12/45 (Mannheim Rd)	Dorchester Ave / Balmoral Ave	Cook	T-1A
1372	01	TS15110	IL 38 (Roosevelt Rd)	Westchester Blvd	Cook	T-1A
1373	01	TS15115	22nd St / Cermak Rd	Mayfair Ave	Cook	T-1A
1374	01	TS15120	US 12/45 (Mannheim Rd)	Canterbury St	Cook	T-1A
1375		TS20341	Touhy Ave	Lawndale Ave	Cook	T-1A
1376	04	TS20345	Touhy Ave	Lincolnwood Town Center Entrance	Cook	T-1A
1377		TS20355	Niles Center Rd / Carpenter Rd	Village Crossing Entrance D	Cook	T-1A
1378	01	TS20365	US 6 (159th St)	91st Ave / Park Hill Dr	Cook	T-1A
1379	02	TS20366	IL 50/IL 83 (Cicero Ave)	137th St	Cook	T-1A
1380		TS20380	US 14 (Northwest Highway)	Ela Rd	Cook	T-1A
1381		TS20385	Ballard Rd	Bender Rd / East River Rd	Cook	T-1A
1382	04	TS20395	McCormick Blvd	Lincolnwood Town Center Entrance	Cook	T-1A
1383		TS20400	Barrington Rd	St Alexius Hospital / Hoffman Medical	Cook	T-1A
1384		TS20402	IL 58 (Golf Rd)	Hoffman Estates SC Entrance	Cook	T-1A
1385		TS20405	US 45/IL 21 (Milwaukee Ave)	US 45 (Des Plaines River Rd)	Cook	T-1A
1386	02	TS20435	IL 50 (Cicero Ave)	24th St	Cook	T-1A
1387		TS20480	Palatine Rd	Roselle Rd	Cook	T-1A
1388	04	TS20490	US 6 (159th St)	108th Ave	Cook	T-1A
1389	01	TS20491	US 6 (159th St)	Ravinia Way	Cook	T-1A
1390	02	TS20495	IL 50 (Cicero Ave)	120th St	Cook	T-1A
1391	03	TS20525	IL 171 (Archer Ave)	Bulldog Dr / 57th St	Cook	T-1A
1392	04	TS20555	IL 43 (Waukegan Rd)	Niles Civic Center Plaza Entrance	Cook	T-1A
1393	04	TS20560	US 6 (Wolf Rd)	167th St	Cook	T-1A
1394		TS20575	US 20 (Lake St)	Walnut Ave	Cook	T-1A
1395	04	TS20590	US 14 (Northwest Highway)	First Bank Entrance	Cook	T-1A
1396		TS20605	I-290/IL 53	Biesterfield Rd W Ramps	Cook	T-1A
1397		TS20610	I-290/IL 53	Biesterfield Rd E Ramps	Cook	T-1A
1398		TS20615	Brainard Ave	Hegewisch Metra Parking Lot Entrance	Cook	T-1A
1399		TS20935	Touhy Ave	Village Crossing SC Entrance C	Cook	T-1A
1400		TS20945	US 45 (LaGrange Rd/96th Ave)	179th St	Cook	T-1A
1401		TS20955	US 6/IL 83 (Torrence Ave)	166th St / Fieldcrest Dr	Cook	T-1A
1402	02	TS20965	127th St	Kostner Ave	Cook	T-1A
1403	02	TS21015	IL 50 (Cicero Ave)	105th St	Cook	T-1A
1404	03	TS21090	Glenwood Dyer Rd	Stoney Island Ave	Cook	T-1A
1405		TS21100	IL 83 (Old McHenry Rd)	Lexington Dr	Cook	T-1A
1406	02	TS21125	IL 58 (Golf Rd)	Golf Glen Shopping Center Entrance	Cook	T-1A
1407	04	TS21130	Barrington Rd	Old Church Rd	Cook	T-1A
1408		TS21145	Elmhurst Rd	Greenleaf Ave	Cook	T-1A

Count	Grd Date	Loc #	Main Route	Nearest Cross Street	County	RM Pay Item
1409		TS21150	Elmhurst Rd	Pratt Ave	Cook	T-1A
1410		TS21175	31st St	Mayfair Ave	Cook	T-1A
1411	03	TS21185	IL 83 (Torrence Ave)	Glenwood Lansing Rd	Cook	T-1A
1412	04	TS21200	IL 68 (Dundee Rd)	Huntington Ln / Lake Blvd	Cook	T-1A
1413		TS21210	Lake Cook Rd	Ela Rd	Cook	T-1A
1414	03	TS21220	111th St	Austin Blvd	Cook	T-1A
1415		TS21225	Meacham Rd	American Ln	Cook	T-1A
1416		TS21230	Meacham Rd	Remington Ln	Cook	T-1A
1417		TS21235	IL 58 (Golf Rd)	Basswood Rd / Basswood St	Cook	T-1A
1418		TS21237	IL 58 (Golf Rd)	Wilkening Rd	Cook	T-1A
1419		TS21275	Willow Rd	Kraft Food Entrance / Three Lakes Dr	Cook	T-1A
1420	01	TS21280	Barrington Rd	Buttitta Dr / Laurie Ln	Cook	T-1A
1421	02	TS21285	Barrington Rd	Ramblewood Dr	Cook	T-1A
1422		TS21290	IL 58 (Golf Rd)	National Parkway	Cook	T-1A
1423		TS21320	IL 72 (Higgins Rd)	Spring Mill Rd	Cook	T-1A
1424		TS21322	IL 72 (Higgins Rd)	Grand Canyon Parkway	Cook	T-1A
1425	04	TS21325	IL 43 (Harlem Ave)	Oak Park Ave	Cook	T-1A
1426	03	TS21340	IL 83 (Torrence Ave)	176th St	Cook	T-1A
1427	04	TS21355	IL 62 (Algonquin Rd)	Briarwood Dr	Cook	T-1A
1428		TS21370	IL 58 (Golf Rd)	Knollwood Dr	Cook	T-1A
1429		TS21375	IL 58 (Golf Rd)	Harmon Blvd	Cook	T-1A
1430	01	TS21450	IL 19 (Irving Park Rd)	Olde Salem Dr	Cook	T-1A
1431	03	TS21475	IL 171 (Archer Ave)	Bell Rd	Cook	T-1A
1432		TS21510	IL 59 (Sutton Rd)	I-90 Tollway S Ramps	Cook	T-1A
1433		TS21515	IL 43 (Harlem Ave)	Vollmer Rd	Cook	T-1A
1434	03	TS21520	IL 7 (143rd St)	IL 7 (Wolf Rd)	Cook	T-1A
1435	04	TS21522	IL 7 (143rd St)	108th St	Cook	T-1A
1436		TS21535	IL 59 (Sutton Rd)	I-90 Tollway N Ramps / Columbine Blvd	Cook	T-1A
1437	04	TS21550	IL 68 (Dundee Rd)	Barrington Middle School Entrance	Cook	T-1A
1438		TS21555	IL 72 (Higgins Rd)	Sears E Entrance / Trillium Blvd	Cook	T-1A
1439		TS21557	IL 72 (Higgins Rd)	Sears W Entrance	Cook	T-1A
1440		TS21560	IL 72 (Higgins Rd)	Old Sutton Rd	Cook	T-1A
1441		TS21595	IL 62 (Algonquin Rd)	Newport Dr	Cook	T-1A
1442	04	TS21600	Pfingsten Rd	Glenlake Dr / Glenbrook Hosp. Ent	Cook	T-1A
1443	04	TS21605	US 30 (Lincoln Highway)	Ellis St	Cook	T-1A
1444		TS21610	Meacham Rd	Motorola N Dr / Drummer Dr	Cook	T-1A
1445		TS21620	Meacham Rd	Motorola S Dr / Thoreau Dr	Cook	T-1A
1446	02	TS21650	IL 50 (Cicero Ave)	71st St / Wal Mart Entrance	Cook	T-1A
1447		TS21709	IL 19 (Irving Park Rd)	Elgin-O'Hare E Frontage Rd	Cook	T-1A
1448		TS21710	IL 19 (Irving Park Rd)	Elgin O'Hare W Frontage Rd	Cook	T-1A
1449		TS21711	Elgin O'Hare W Frontage Rd	Rodenburg Rd	Cook	T-1A
1450		TS21712	Elgin-O'Hare E Frontage Rd	Rodenburg Rd	Cook	T-1A
1451		TS21720	Elgin-O'Hare E Frontage Rd	Wright Blvd	Cook	T-1A
1452		TS21721	Elgin O'Hare W Frontage Rd	Wright Blvd	Cook	T-1A
1453		TS21730	Elgin O'Hare W Frontage Rd	Meacham Rd	Cook	T-1A
1454		TS21731	Elgin O'Hare W Frontage Rd	Meacham Rd / Medinah Rd	Cook	T-1A
1455		TS21770	Meacham Rd	Tower Rd / McConnor Parkway	Cook	T-1A

Count	Grd Date	Loc #	Main Route	Nearest Cross Street	County	RM Pay Item
1456	01	TS21775	Montrose Ave	Neenah Ave	Cook	T-1A
1457	03	TS21795	Western Ave	Joe Orr Rd / Country Club Dr	Cook	T-1A
1458		TS21805	Palatine Rd	Chambers Dr / Jewel Osco Entrance	Cook	T-1A
1459		TS21845	Main St / Lake Cook Rd	Dundee Ave	Cook	T-1A
1460		TS21850	IL 64 (North Ave)	Wal-Mart Entrance	Cook	T-1A
1461	04	TS21855	IL 43 (Waukegan Rd)	Overlook Dr / Kraft Food Entrance	Cook	T-1A
1462		TS21890	Biesterfield Rd	Beisner Rd	Cook	T-1A
1463	01	TS21920	US 6 (159th St)	Jewel Entrance / Orland Town Center Ent	Cook	T-1A
1464		TS21955	IL 72 (Higgins Rd)	National Parkway	Cook	T-1A
1465		TS22035	75th St	Willow Springs Rd	Cook	T-1A
1466	03	TS22060	US 45 (La Grange Rd)	171st St	Cook	T-1A
1467	03	TS22065	22nd St / Cermak Rd	14th St	Cook	T-1A
1468		TS22095	104th Ave	123rd St / McCarthy Rd	Cook	T-1A
1469	01	TS22120	17th Ave	19th St	Cook	T-1A
1470	01	TS22121	17th Ave	23rd St	Cook	T-1A
1471	02	TS22150	Devon Ave	Greenwood Ave	Cook	T-1A
1472	03	TS22190	State St	Keepataw Dr / Lemont Plaza Entrance	Cook	T-1A
1473	03	TS22195	127th St	State St	Cook	T-1A
1474	01	TS22215	US 12/20/45 (La Grange Rd)	58th St	Cook	T-1A
1475	08	TS22225	IL 58 (Golf Rd)	Rohrsen Rd	Cook	T-1A
1476	03	TS22230	IL 62 (Algonquin Rd)	Willowmere Dr / Willow Creek Comm	Cook	T-1A
1477	03	TS22235	Arlington Heights Rd	Bennett Rd	Cook	T-1A
1478		TS22240	IL 62 (Algonquin Rd)	Penny Rd	Cook	T-1A
1479		TS22263	IL 43 (Harlem Ave)	191st St	Cook	T-1A
1480		TS545	IL 83 (Kingery Highway)	3rd Ave	DuPage	T-1A
1481		TS550	IL 83 (Kingery Highway)	22nd St / Cermak Rd	DuPage	T-1A
1482	05	TS565	IL 83 (Kingery Highway)	63rd St	DuPage	T-1A
1483		TS570	IL 83 (Kingery Highway)	75th St	DuPage	T-1A
1484	05	TS580	IL 83 (Kingery Highway)	Bluff Rd	DuPage	T-1A
1485		TS585	IL 83 (Kingery Highway)	Central Ave	DuPage	T-1A
1486	05	TS587	IL 83 (Kingery Highway)	91st St	DuPage	T-1A
1487		TS590	IL 83 (Kingery Highway)	Foster Ave	DuPage	T-1A
1488	05	TS595	IL 83 (Kingery Highway)	Grove Ave / Sherwood Dr	DuPage	T-1A
1489		TS600	IL 83 (Kingery Highway)	Hillside Dr	DuPage	T-1A
1490	02	TS605	IL 83 (Kingery Highway)	Elmhurst Shopping Center Ent	DuPage	T-1A
1491		TS610	IL 83 (Kingery Highway)	Mark St	DuPage	T-1A
1492	05	TS615	IL 83 (Kingery Highway)	Midway Dr	DuPage	T-1A
1493	05	TS620	IL 83 (Kingery Highway)	Hodges Rd / Oakbrook Ct	DuPage	T-1A
1494	05	TS625	IL 83 (Kingery Highway)	16th St	DuPage	T-1A
1495	02	TS630	IL 83 (Kingery Highway)	Elmhurst Quarry Ent	DuPage	T-1A
1496		TS635	IL 83 (Kingery Highway)	Plainfield Rd	DuPage	T-1A
1497		TS640	IL 83 (Kingery Highway)	Riverside Dr	DuPage	T-1A
1498	02	TS645	IL 83 (Kingery Highway)	St. Charles Rd	DuPage	T-1A
1499		TS650	IL 83 (Kingery Highway)	Thorndale Ave	DuPage	T-1A
1500		TS660	IL 53 (Rohlwing Rd)	Thorndale Ave	DuPage	T-1A
1501	05	TS990	IL 53 (Rohlwing Rd)	Nordic Rd	DuPage	T-1A
1502	05	TS995	IL 53 (Rohlwing Rd)	Ardmore Ave	DuPage	T-1A

Count	Grd Date	Loc #	Main Route	Nearest Cross Street	County	RM Pay Item
1503	05	TS1988	IL 19 (Irving Park Rd)	Division St	DuPage	T-1A
1504	05	TS4595	US 20 (Lake St)	Fairfield Way	DuPage	T-1A
1505	05	TS4600	US 20 (Lake St)	Bloomingtondale Rd	DuPage	T-1A
1506	05	TS4605	US 20 (Lake St)	Circle Dr	DuPage	T-1A
1507	05	TS4610	US 20 (Lake St)	Springbrook Shopping Center	DuPage	T-1A
1508	05	TS5975	I-55 N Frontage Rd	Cass Ave	DuPage	T-1A
1509	05	TS5990	I-290	York Rd N Ramp / Crestview Ave	DuPage	T-1A
1510	05	TS5995	I-290	US 20 (Lake St) & York Rd S Ramp	DuPage	T-1A
1511	05	TS6000	I-290 E Ramp	Thorndale Ave	DuPage	T-1A
1512	05	TS6005	I-290 W Ramp	Thorndale Ave	DuPage	T-1A
1513		TS6015	US 20 (Lake St)	IL 83 W Ramps	DuPage	T-1A
1514		TS6020	US 20 (Lake St)	Addison Rd	DuPage	T-1A
1515		TS6025	US 20 (Lake St)	Church Rd	DuPage	T-1A
1516		TS6030	US 20 (Lake St)	Gary Ave	DuPage	T-1A
1517		TS6035	US 20 (Lake St)	Glen Ellyn Rd	DuPage	T-1A
1518	05	TS6037	US 20 (Lake St)	Euclid Ave / Lake View Dr	DuPage	T-1A
1519		TS6040	US 20 (Lake St)	IL 83 E Ramps / Grand Ave	DuPage	T-1A
1520		TS6043	US 20 (Lake St)	Greenbriar Dr	DuPage	T-1A
1521	05	TS6045	US 20 (Lake St)	Medinah Rd	DuPage	T-1A
1522	05	TS6046	US 34 (Ogden Ave)	Commons Dr	DuPage	T-1A
1523	05	TS6047	US 34 (Ogden Ave)	75th St	DuPage	T-1A
1524	05	TS6048	US 34 (Ogden Ave)	Long Grove Rd	DuPage	T-1A
1525	05	TS6049	US 34 (Ogden Ave)	Eola Rd	DuPage	T-1A
1526	05	TS6050	US 34 (Ogden Ave)	Montgomery Rd	DuPage	T-1A
1527	05	TS6051	US 34 (Ogden Ave)	Frontenac Rd	DuPage	T-1A
1528	05	TS6060	US 20 (Lake St)	IL 53 (Rohlwing Rd)	DuPage	T-1A
1529		TS6065	US 20 (Lake St)	Springfield Dr	DuPage	T-1A
1530		TS6070	US 20 (Lake St)	Villa Ave / Wooddale Rd	DuPage	T-1A
1531		TS6075	US 20 (Lake St)	Walnut St	DuPage	T-1A
1532		TS6080	US 20 (Lake St)	West Ave	DuPage	T-1A
1533	05	TS6085	US 20 (Lake St)	Rosedale Ave	DuPage	T-1A
1534	05	TS6089	IL 59	McCoy Dr / Fox River Commons	DuPage	T-1A
1535	05	TS6090	IL 59	US 34 (Oswego Rd)	DuPage	T-1A
1536	06	TS6092	IL 59	87th St / White Eagle Dr	DuPage	T-1A
1537	05	TS6095	US 34 (Ogden Ave)	Cass Ave	DuPage	T-1A
1538	05	TS6100	US 34 (Ogden Ave)	Pasquinelli Dr / Middaugh Dr	DuPage	T-1A
1539	05	TS6110	US 34 (Ogden Ave)	IL 83 W Ramps	DuPage	T-1A
1540	05	TS6115	US 34 (Ogden Ave)	IL 83 E Ramps	DuPage	T-1A
1541	05	TS6116	US 34 (Ogden Ave)	Oak St / Salt Creek Ln	DuPage	T-1A
1542	05	TS6118	US 34 (Ogden Ave)	York Rd	DuPage	T-1A
1543	05	TS6120	US 34 (Ogden Ave)	Cross St	DuPage	T-1A
1544	05	TS6125	US 34 (Ogden Ave)	Belmont Rd / Finley Rd	DuPage	T-1A
1545	05	TS6130	US 34 (Ogden Ave)	Madison St	DuPage	T-1A
1546	05	TS6135	US 34 (Ogden Ave)	Oakwood Rd	DuPage	T-1A
1547	05	TS6140	IL 19 (Irving Park Rd)	Marshall Rd	DuPage	T-1A
1548		TS6145	IL 19 (Irving Park Rd)	Medinah Rd	DuPage	T-1A
1549	05	TS6150	IL 19 (Irving Park Rd)	Oleary Dr	DuPage	T-1A

Count	Grd Date	Loc #	Main Route	Nearest Cross Street	County	RM Pay Item
1550	05	TS6155	IL 53 (Rohlwing Rd)	IL 19 (Irving Park Rd)	DuPage	T-1A
1551	05	TS6156	IL 53 (Rohlwing Rd)	Bryn Mawr Ave	DuPage	T-1A
1552	05	TS6157	IL 53 (Rohlwing Rd)	West Thorndale Ave	DuPage	T-1A
1553	05	TS6158	IL 53 (Rohlwing Rd)	Norwood Ave	DuPage	T-1A
1554	05	TS6160	IL 19 (Irving Park Rd)	Spruce Ave	DuPage	T-1A
1555		TS6164	IL 19 (Irving Park Rd)	Bloomington Rd	DuPage	T-1A
1556	05	TS6165	IL 19 (Irving Park Rd)	Walnut St	DuPage	T-1A
1557	05	TS6170	IL 19 (Irving Park Rd)	Prospect Ave	DuPage	T-1A
1558	05	TS6175	IL 38 (Roosevelt Rd)	Fabyan Parkway	DuPage	T-1A
1559	05	TS6180	IL 38 (Roosevelt Rd)	Joliet Rd	DuPage	T-1A
1560	05	TS6185	IL 38 (Roosevelt Rd)	Kress Rd	DuPage	T-1A
1561	05	TS6190	IL 38 (Roosevelt Rd)	Meyers Rd	DuPage	T-1A
1562	05	TS6195	IL 38 (Roosevelt Rd)	Summit Ave	DuPage	T-1A
1563	05	TS6200	IL 38 (Roosevelt Rd)	Winfield Rd	DuPage	T-1A
1564	05	TS6205	IL 59 N Ramp Dayton Ave	IL 38 (Roosevelt Rd)	DuPage	T-1A
1565	05	TS6206	IL 59	IL 38 (Roosevelt Rd) S Ramp	DuPage	T-1A
1566	05	TS6210	IL 38 (Roosevelt Rd)	Courtyard Shpping Center	DuPage	T-1A
1567	05	TS6215	IL 64 (North Ave)	IL 53 (Columbine Ave)	DuPage	T-1A
1568	05	TS6220	IL 53	75th St	DuPage	T-1A
1569	05	TS6225	IL 53	Hobson Rd	DuPage	T-1A
1570		TS6230	IL 53	Park Blvd	DuPage	T-1A
1571	05	TS6240	IL 53	Summerhill Dr / Bell Tech	DuPage	T-1A
1572	05	TS6245	IL 53	83rd St	DuPage	T-1A
1573	05	TS6250	IL 53	59th St / Four Lakes Ave	DuPage	T-1A
1574	05	TS6255	IL 53	Woodridge Dr / Seven Bridges Entrance	DuPage	T-1A
1575	05	TS6256	IL 53	High Tr / Seven Bridges Dr	DuPage	T-1A
1576	05	TS6260	IL 59 (Joliet Rd)	IL 56 (Butterfield Rd)	DuPage	T-1A
1577	05	TS6265	IL 56 (Butterfield Rd)	22nd St	DuPage	T-1A
1578	05	TS6270	IL 56 (Butterfield Rd)	Batavia Rd	DuPage	T-1A
1579	05	TS6275	IL 56 (Butterfield Rd)	Finley Rd	DuPage	T-1A
1580	05	TS6290	IL 56 (Butterfield Rd)	Lambert Rd	DuPage	T-1A
1581	05	TS6293	IL 56 (Butterfield Rd)	Fountain Square Rd	DuPage	T-1A
1582	05	TS6295	IL 56 (Butterfield Rd)	Meyers Rd	DuPage	T-1A
1583	05	TS6300	IL 56 (Butterfield Rd)	Midwest Rd / Summit Ave	DuPage	T-1A
1584	05	TS6305	IL 56 (Butterfield Rd)	Park Blvd	DuPage	T-1A
1585	05	TS6310	IL 56 (Butterfield Rd)	Fairfield Ave	DuPage	T-1A
1586	05	TS6315	IL 56 (Butterfield Rd)	Naperville Rd	DuPage	T-1A
1587	05	TS6320	IL 56 (Butterfield Rd)	Winfield Rd	DuPage	T-1A
1588	05	TS6325	IL 56 (Butterfield Rd)	Eola Rd	DuPage	T-1A
1589	05	TS6330	IL 56 (Butterfield Rd)	Herrick Rd / Weisbrook Rd	DuPage	T-1A
1590	05	TS6335	IL 56 (Butterfield Rd)	Orchard Rd	DuPage	T-1A
1591	05	TS6340	IL 56 (Butterfield Rd)	Glenbard South High School	DuPage	T-1A
1592	05	TS6345	IL 56 (Butterfield Rd)	Trans Am Plaza Dr	DuPage	T-1A
1593	05	TS6350	IL 56 (Butterfield Rd)	Woodcreek Dr / Lloyd Ave	DuPage	T-1A
1594	05	TS6352	IL 56 (Butterfield Rd)	Home Depot Entrance / Esplanade Rd	DuPage	T-1A
1595		TS6355	IL 59 (Ingalton Rd)	IL 64 (North Ave)	DuPage	T-1A
1596	05	TS6360	IL 59	75th St	DuPage	T-1A

Count	Grd Date	Loc #	Main Route	Nearest Cross Street	County	RM Pay Item
1597		TS6362	IL 59	Beebe Dr / Costco Entrance	DuPage	T-1A
1598	05	TS6365	IL 59 (Sutton Rd)	Army Trail Rd	DuPage	T-1A
1599		TS6370	IL 59 (Joliet Rd)	Batavia Rd	DuPage	T-1A
1600	05	TS6377	IL 59 (Ingalton Rd)	Struckman Blvd	DuPage	T-1A
1601	05	TS6378	IL 59 (Ingalton Rd)	Apple Valley Dr / Home Depot Entrance	DuPage	T-1A
1602	05	TS6380	IL 59	North Aurora Rd	DuPage	T-1A
1603	05	TS6390	IL 59 (Neltner Blvd)	Forest Ave	DuPage	T-1A
1604	05	TS6395	IL 59 (Joliet Rd)	Continental Dr / Meadow Ave	DuPage	T-1A
1605		TS6400	IL 64 (North Ave)	IL 83 (Kingery Highway)	DuPage	T-1A
1606		TS6405	IL 64 (North Ave)	Addison Rd	DuPage	T-1A
1607		TS6410	IL 64 (North Ave)	Ardmore Ave	DuPage	T-1A
1608	05	TS6415	IL 64 (North Ave)	Berteau Ave	DuPage	T-1A
1609	05	TS6420	IL 64 (North Ave)	Bloomingtondale Rd	DuPage	T-1A
1610	05	TS6425	IL 64 (North Ave)	County Farm Rd	DuPage	T-1A
1611	05	TS6430	IL 64 (North Ave)	Emroy Ave / Melrose Ave	DuPage	T-1A
1612	05	TS6435	IL 64 (North Ave)	Gary Ave	DuPage	T-1A
1613		TS6440	IL 64 (North Ave)	Grace St	DuPage	T-1A
1614	05	TS6445	IL 64 (North Ave)	Kuhn Rd	DuPage	T-1A
1615	05	TS6450	IL 64 (North Ave)	Main St {Glen Ellyn}	DuPage	T-1A
1616		TS6455	IL 64 (North Ave)	Main St {Lombard}	DuPage	T-1A
1617		TS6456	IL 64 (North Ave)	Lombard Rd	DuPage	T-1A
1618	05	TS6460	IL 64 (North Ave)	Myrtle Ave	DuPage	T-1A
1619	05	TS6465	IL 64 (North Ave)	Schmale Rd	DuPage	T-1A
1620		TS6470	IL 64 (North Ave)	Michigan Ave / North Park Mall Entrance	DuPage	T-1A
1621	02	TS6475	IL 64 (North Ave)	Swift Rd	DuPage	T-1A
1622		TS6480	IL 64 (North Ave)	Villa Ave	DuPage	T-1A
1623	05	TS6490	IL 64 (North Ave)	West Ave	DuPage	T-1A
1624		TS6495	IL 64 (North Ave)	Westwood Ave	DuPage	T-1A
1625	05	TS6500	IL 64 (North Ave)	York Rd	DuPage	T-1A
1626		TS6505	IL 64 (North Ave)	Elmhurst Plaza Entrance	DuPage	T-1A
1627		TS7695	US 20 (Lake St)	Bearflag Dr / Ontarioville Rd	DuPage	T-1A
1628		TS7800	IL 56 (Butterfield Rd)	Macarthur Dr	DuPage	T-1A
1629	05	TS7830	IL 53 (Lincoln Ave)	Maple Ave	DuPage	T-1A
1630	05	TS7835	IL 56 (Butterfield Rd)	IL 53	DuPage	T-1A
1631		TS7851	IL 53 (Rohlwing Rd)	Mitchel Ct	DuPage	T-1A
1632	05	TS7855	US 34 (Ogden Ave)	Main St {Lisle}	DuPage	T-1A
1633		TS7870	US 20 (Lake St)	Bartels Rd / Arlington Rd	DuPage	T-1A
1634		TS7875	US 20 (Lake St)	Bryn Mawr Ave	DuPage	T-1A
1635	05	TS8225	IL 38 (Roosevelt Rd)	County Farm Rd	DuPage	T-1A
1636	05	TS8370	US 34 (Ogden Ave)	Fairview Ave	DuPage	T-1A
1637	05	TS8375	22nd St / Cermak Rd	Midwest Rd / Summit Ave	DuPage	T-1A
1638	05	TS8377	22nd St / Cermak Rd	Shops of Oak Brook Entrance	DuPage	T-1A
1639	05	TS8830	US 34 (Ogden Ave)	Washington St	DuPage	T-1A
1640	05	TS8850	IL 59 (Neltner Blvd)	James St	DuPage	T-1A
1641	05	TS8853	IL 59 (Neltner Blvd)	Hawthorn Ln	DuPage	T-1A
1642	05	TS8855	IL 59 (Neltner Blvd)	Washington St	DuPage	T-1A
1643	05	TS8860	IL 59 (Neltner Blvd)	Main St {West Chicago}	DuPage	T-1A

Count	Grd Date	Loc #	Main Route	Nearest Cross Street	County	RM Pay Item
1644	05	TS8970	IL 59 (Neltner Blvd)	22nd St	DuPage	T-1A
1645		TS9022	IL 38 (Roosevelt Rd)	Kautz Rd	DuPage	T-1A
1646	05	TS9035	IL 19 (Irving Park Rd)	Roselle Rd	DuPage	T-1A
1647	05	TS9037	IL 19 (Irving Park Rd)	Lawerence Ave	DuPage	T-1A
1648	05	TS9040	IL 19 (Irving Park Rd)	Park St	DuPage	T-1A
1649	05	TS9100	IL 19 (Irving Park Rd)	Maple Ave	DuPage	T-1A
1650	05	TS9450	IL 59	Diehl Rd	DuPage	T-1A
1651	05	TS9455	IL 59	Bruce Ln / Brookdale Rd	DuPage	T-1A
1652		TS9470	IL 59	I-88 S Ramp	DuPage	T-1A
1653		TS9475	IL 59	I-88 N Ramp	DuPage	T-1A
1654	05	TS10910	US 34 (Ogden Ave)	Warwick Ave / Shopping Center Entrance	DuPage	T-1A
1655		TS11085	IL 59	Ferry Rd	DuPage	T-1A
1656	05	TS11105	US 20 (Lake St)	Swift Rd	DuPage	T-1A
1657	05	TS11180	IL 38 (Roosevelt Rd)	Fairfield Ave	DuPage	T-1A
1658	05	TS11390	IL 64 (North Ave)	Venture Shopping Center	DuPage	T-1A
1659	05	TS11410	IL 56 (Butterfield Rd)	Downers Dr	DuPage	T-1A
1660	05	TS11415	IL 38 (Roosevelt Rd)	Lombard Shopping Center	DuPage	T-1A
1661	05	TS11420	US 34 (Ogden Ave)	Saratoga St	DuPage	T-1A
1662	05	TS11425	US 34 (Ogden Ave)	Main St {Downers Grove}	DuPage	T-1A
1663	05	TS11655	IL 53 (Lincoln Ave)	Main St {Lisle}	DuPage	T-1A
1664	05	TS11660	IL 53 (Lincoln Ave)	Short St	DuPage	T-1A
1665	05	TS11665	IL 53 (Lincoln Ave)	Warrenville Rd	DuPage	T-1A
1666	05	TS11670	IL 53 (Lincoln Ave)	Burlington Ave	DuPage	T-1A
1667	05	TS11675	US 34 (Ogden Ave)	Blackhawk Dr	DuPage	T-1A
1668	05	TS11680	US 34 (Ogden Ave)	US 34 (Ogden Ave) N Ramps	DuPage	T-1A
1669	05	TS11685	US 34 (Ogden Ave)	US 34 (Ogden Ave) S Ramps	DuPage	T-1A
1670	05	TS11825	US 34 (Ogden Ave)	Swartz Ave	DuPage	T-1A
1671	05	TS11830	US 34 (Ogden Ave)	Yackley Rd	DuPage	T-1A
1672	05	TS11835	US 34 (Ogden Ave)	Indiana Ave / Western Ave	DuPage	T-1A
1673	05	TS11840	US 34 (Ogden Ave)	Old Tavern Rd	DuPage	T-1A
1674	06	TS11970	IL 59	83rd St / Montgomery Rd	DuPage	T-1A
1675		TS12020	IL 59 (Neltner Blvd)	Joliet St	DuPage	T-1A
1676	05	TS12021	IL 59	Mack Rd	DuPage	T-1A
1677		TS12045	IL 19 (Irving Park Rd)	York Rd	DuPage	T-1A
1678	05	TS12065	IL 19 (Irving Park Rd)	Church Rd	DuPage	T-1A
1679	05	TS12140	IL 59	Liberty St / Jefferson Ave	DuPage	T-1A
1680		TS12215	IL 83	67th St	DuPage	T-1A
1681	02	TS12250	IL 64 (North Ave)	I-355 Tollway E Ramp	DuPage	T-1A
1682	02	TS12255	IL 64 (North Ave)	I-355 Tollway W Ramp	DuPage	T-1A
1683	05	TS12310	IL 59	Audrey Rd / Aurora Market Place Shop	DuPage	T-1A
1684	05	TS12320	IL 38 (Roosevelt Rd)	Finley Rd	DuPage	T-1A
1685	05	TS12325	IL 38 (Roosevelt Rd)	Main St {Lombard}	DuPage	T-1A
1686	05	TS12335	US 20 (Lake St)	I-355 Tollway E Ramp	DuPage	T-1A
1687	05	TS12340	US 20 (Lake St)	I-355 Tollway W Ramp	DuPage	T-1A
1688	06	TS12360	US 34 (Oswego Rd)	Trade St / Aurora Market Place Shop	DuPage	T-1A
1689		TS12375	IL 64 (North Ave)	Prince Crossing Rd	DuPage	T-1A
1690		TS12376	IL 64 (North Ave)	Fair Oaks Rd	DuPage	T-1A

Count	Grd Date	Loc #	Main Route	Nearest Cross Street	County	RM Pay Item
1691	05	TS12420	US 34 (Ogden Ave)	I-355 Tollway E Ramp	DuPage	T-1A
1692		TS12421	US 34 (Ogden Ave)	I-355 Tollway W Ramp	DuPage	T-1A
1693	05	TS12424	IL 38 (Roosevelt Rd)	Baker Hill Dr	DuPage	T-1A
1694	05	TS12425	IL 38 (Roosevelt Rd)	I-355 Tollway E Ramp	DuPage	T-1A
1695	05	TS12426	IL 38 (Roosevelt Rd)	I-355 Tollway W Ramp	DuPage	T-1A
1696		TS12500	US 20 (Lake St)	Itasca Rd	DuPage	T-1A
1697		TS12505	US 20 (Lake St)	Lombard Ave	DuPage	T-1A
1698		TS12510	US 20 (Lake St)	Mill Rd	DuPage	T-1A
1699		TS12513	US 20 (Lake St)	Marcus Dr	DuPage	T-1A
1700	05	TS12515	US 20 (Lake St)	Kennedy Dr	DuPage	T-1A
1701		TS12520	IL 53 (Rohlfing Rd)	Fullerton Ave	DuPage	T-1A
1702		TS13760	US 20 (Lake St)	Metra Commuter Parking Lot / Church Rd	DuPage	T-1A
1703		TS13770	US 20 (Lake St)	Greenbrook Blvd	DuPage	T-1A
1704	05	TS14065	IL 38 (Roosevelt Rd)	Highland Ave	DuPage	T-1A
1705	05	TS14491	22nd St / Cermak Rd	Oak Brook Center E Entrance	DuPage	T-1A
1706	05	TS14492	22nd St / Cermak Rd	Oak Brook Center W Entrance	DuPage	T-1A
1707	05	TS14493	22nd St / Cermak Rd	Spring Rd	DuPage	T-1A
1708	05	TS14494	22nd St / Cermak Rd	McDonald Dr	DuPage	T-1A
1709	05	TS14495	York Rd	22nd St / Cermak Rd	DuPage	T-1A
1710	05	TS14497	22nd St / Cermak Rd	Windsor Dr	DuPage	T-1A
1711	05	TS15090	IL 19 (Irving Park Rd)	Addison Rd	DuPage	T-1A
1712		TS15100	IL 19 (Irving Park Rd)	Wooddale Rd	DuPage	T-1A
1713	05	TS15175	IL 56 (Butterfield Rd)	Bradford Dr / Briar Brook Dr	DuPage	T-1A
1714	05	TS15178	IL 56 (Butterfield Rd)	Leask Ln	DuPage	T-1A
1715	05	TS15230	IL 38 (Roosevelt Rd)	Lorraine Rd	DuPage	T-1A
1716	05	TS15235	IL 38 (Roosevelt Rd)	President St	DuPage	T-1A
1717	05	TS15240	IL 38 (Roosevelt Rd)	Naperville Rd	DuPage	T-1A
1718		TS15245	IL 38 (Roosevelt Rd)	Main {Wheaton}	DuPage	T-1A
1719		TS15250	IL 38 (Roosevelt Rd)	West St / Warrenville Rd	DuPage	T-1A
1720		TS15255	IL 38 (Roosevelt Rd)	Carleton Ave	DuPage	T-1A
1721	05	TS15260	IL 38 (Roosevelt Rd)	Adare Dr / Saddle Rd	DuPage	T-1A
1722	05	TS15261	IL 38 (Roosevelt Rd)	Marian Joy Entrance	DuPage	T-1A
1723	05	TS15305	IL 38 (Roosevelt Rd)	Villa Oaks Dr	DuPage	T-1A
1724	05	TS15310	IL 38 (Roosevelt Rd)	Ardmore Ave	DuPage	T-1A
1725		TS15315	IL 64 (North Ave)	Westmore Ave	DuPage	T-1A
1726	05	TS20330	IL 53 (Bryant Ave)	DuPage Blvd / Baker Hill Dr	DuPage	T-1A
1727	05	TS20335	IL 53 (Bryant Ave)	Pershing Ave	DuPage	T-1A
1728	05	TS20360	IL 59	Meridian Parkway / Glacier Park Ave	DuPage	T-1A
1729	05	TS20370	IL 56 (Butterfield Rd)	Cromwell Dr	DuPage	T-1A
1730		TS20620	IL 59	New York St / Aurora Ave	DuPage	T-1A
1731	05	TS20625	IL 56 (Butterfield Rd)	I-355 Tollway E Ramp	DuPage	T-1A
1732	05	TS20630	IL 56 (Butterfield Rd)	I-355 Tollway W Ramp	DuPage	T-1A
1733	05	TS20631	IL 38 (Roosevelt Rd)	Nicoll Way	DuPage	T-1A
1734	05	TS20632	IL 38 (Roosevelt Rd)	Park Blvd	DuPage	T-1A
1735	05	TS20634	IL 38 (Roosevelt Rd)	Lambert Rd	DuPage	T-1A
1736	05	TS20635	IL 59	Fox Valley Mall N Entrance	DuPage	T-1A
1737	05	TS20660	IL 56 (Butterfield Rd)	East Loop Dr	DuPage	T-1A

Count	Grd Date	Loc #	Main Route	Nearest Cross Street	County	RM Pay Item
1738	06	TS20910	US 34 (Ogden Ave)	Fox River Commons Entrance	DuPage	T-1A
1739	05	TS21035	22nd St / Cermak Rd	Parkview Dr	DuPage	T-1A
1740		TS21139	IL 59	Vantage Retail / Meijer Entrance	DuPage	T-1A
1741	05	TS21250	IL 38 (Roosevelt Rd)	Blanchard St	DuPage	T-1A
1742	05	TS21255	IL 38 (Roosevelt Rd)	Main St / Glen Ellyn Rd	DuPage	T-1A
1743	05	TS21395	IL 64 (North Ave)	President St / Fireside Dr	DuPage	T-1A
1744	05	TS21505	IL 53 (Bryant Ave)	Sheehan Ave	DuPage	T-1A
1745	05	TS21700	US 34 (Ogden Ave)	Chelsea Ave / Lisle Post Office	DuPage	T-1A
1746	05	TS21830	US 34 (Ogden Ave)	Downers Plaza Shopping Entrance	DuPage	T-1A
1747	05	TS21870	IL 56 (Butterfield Rd)	Technology Dr / Waste Management Ent	DuPage	T-1A
1748		TS21910	US 20 (Lake St)	Elgin O'Hare	DuPage	T-1A
1749	05	TS21930	Aurora Ave	Westridge Ct / Naper West Shopping Ent	DuPage	T-1A
1750		TS22025	US 20 (Lake St)	Rodenburg Rd	DuPage	T-1A
1751	05	TS22110	IL 59	Ingalton Ave / Arbor Ave	DuPage	T-1A
1752	05	TS22115	IL 59 (Ingalton Ave)	Diversey Parkway / St Andrew Golf Ent	DuPage	T-1A
1753	05	TS22125	IL 59 (Sutton Rd)	Schick Rd	DuPage	T-1A
1754	05	TS22135	IL 53 (Rohlwing Rd)	Sidney Ave	DuPage	T-1A
1755	06	TS196	IL 38	IL 47	Kane	T-1A
1756	06	TS665	IL 25 (Dundee Ave)	I-90 Tollway	Kane	T-1A
1757	06	TS670	IL 25 (Liberty St)	Villa St / Business Route US 20	Kane	T-1A
1758	06	TS675	US 20 (Lake St)	IL 31 (LaFox St)	Kane	T-1A
1759		TS677	US 20 (Lake St)	Nesler Rd	Kane	T-1A
1760		TS693	US 20 (Lake St)	Plank Rd / Coombs Rd	Kane	T-1A
1761		TS700	US 30 (Baseline Rd)	US 30/IL 47	Kane	T-1A
1762	06	TS703	IL 47	Keslinger Rd	Kane	T-1A
1763	06	TS705	IL 31	US 30 (Briarcliff Rd) N Ramp	Kane	T-1A
1764	06	TS710	IL 31	US 30 (Briarcliff Rd) S Ramp	Kane	T-1A
1765	06	TS725	US 30 (Baseline Rd) IL 47	Jericho Rd	Kane	T-1A
1766	06	TS727	US 30 (Baseline Rd)	Griffin Dr	Kane	T-1A
1767		TS728	US 30 (Baseline Rd)	Gordon	Kane	T-1A
1768	06	TS730	US 30 (Baseline Rd)	Orchard Rd	Kane	T-1A
1769		TS735	IL 31/IL 56 (Lincoln Way)	I-88/IL 56 Tollway	Kane	T-1A
1770		TS740	IL 19 (Irving Park Rd)	IL 25 (Liberty St)	Kane	T-1A
1771		TS745	IL 58 (Golf Rd) / Summit St	IL 25 (Liberty St)	Kane	T-1A
1772		TS750	IL 25 (River St)	IL 25 (Wilson St)	Kane	T-1A
1773	06	TS755	IL 38 (State St)	IL 25 (Bennet St)	Kane	T-1A
1774	06	TS760	IL 62 (Algonquin Rd)	IL 25 (JFK Memorial Dr)	Kane	T-1A
1775	06	TS765	IL 25 (Dundee Ave)	IL 68 (Barrington Rd)	Kane	T-1A
1776	06	TS770	IL 25 (Dundee Ave)	IL 72 (Higgins Rd)	Kane	T-1A
1777	06	TS775	IL 25 (Dundee Ave)	Brandt Dr	Kane	T-1A
1778	06	TS780	IL 25 (Crissey Ave)	Fabyan Parkway	Kane	T-1A
1779	06	TS785	IL 25 (Wilson St)	IL 25 (Washington Ave)	Kane	T-1A
1780	06	TS795	IL 31 (Batavia Ave / 1st St)	3rd St	Kane	T-1A
1781	06	TS805	IL 38 (State St)	IL 31 (1st St)	Kane	T-1A
1782	06	TS810	IL 31 (State St)	Tollgate Rd / Airport Rd	Kane	T-1A
1783	06	TS815	IL 31 (State St)	Big Timber Rd	Kane	T-1A
1784	06	TS820	IL 31 (State St)	Davis Rd / River Rd	Kane	T-1A

Count	Grd Date	Loc #	Main Route	Nearest Cross Street	County	RM Pay Item
1785	06	TS825	IL 31 (Batavia Ave)	Fabyan Parkway	Kane	T-1A
1786	06	TS830	IL 31 (LaFox St)	Middle St	Kane	T-1A
1787	06	TS835	IL 31 (West Lake St)	Webster St / Aucutt Rd	Kane	T-1A
1788	06	TS845	IL 38 (State St)	East Side Dr	Kane	T-1A
1789	06	TS856	IL 38 (State St)	Bricher Rd / 14th St	Kane	T-1A
1790	06	TS857	IL 38 (Lincoln Highway)	Peck Rd	Kane	T-1A
1791	06	TS858	IL 38 (State St)	Williamsburg Ave	Kane	T-1A
1792		TS859	IL 38	La Fox Rd	Kane	T-1A
1793	06	TS860	US 30/IL 47	Cross St	Kane	T-1A
1794	06	TS862	US 30	Dugan Rd	Kane	T-1A
1795	06	TS865	IL 47	Galena Blvd	Kane	T-1A
1796	06	TS868	IL 47	Bliss Rd / Wheeler Rd	Kane	T-1A
1797		TS869	IL 47	Waubonsee	Kane	T-1A
1798	06	TS877	IL 64 (Main St)	Peck Rd	Kane	T-1A
1799	06	TS878	IL 64 (North Ave)	Burlington Rd	Kane	T-1A
1800	06	TS880	IL 68 (Penny Rd)	IL 72 (Higgins Rd)	Kane	T-1A
1801	06	TS885	IL 72 (Main St)	River St	Kane	T-1A
1802	06	TS890	IL 72 (Main St)	Van Buren St	Kane	T-1A
1803	06	TS895	IL 72 (Main St)	1st St	Kane	T-1A
1804	06	TS900	IL 72 (Main St)	2nd St	Kane	T-1A
1805	06	TS905	IL 72 (Higgins Rd)	Rock Road Dr	Kane	T-1A
1806		TS920	Wilson St	Island Ave / Shimway Ave	Kane	T-1A
1807	06	TS1000	IL 31 (Western Ave)	IL 72 (Main St)	Kane	T-1A
1808	06	TS4305	IL 25 (JFK Memorial Dr)	Golfview Ln	Kane	T-1A
1809	06	TS4310	IL 25 (JFK Memorial Dr)	Kings Rd	Kane	T-1A
1810	06	TS4315	IL 25 (JFK Memorial Dr)	Besinger Dr	Kane	T-1A
1811	06	TS4320	IL 25 (JFK Memorial Dr)	Helm Rd	Kane	T-1A
1812	06	TS4325	IL 25 (JFK Memorial Dr)	Robin Rd	Kane	T-1A
1813	06	TS4330	IL 31 (State St)	Chicago Rawhide Driveway	Kane	T-1A
1814	06	TS4390	IL 25 (JFK Memorial Dr)	Lake Marian Rd / Hazard Rd	Kane	T-1A
1815	06	TS4457	IL 25	West Bartlett Rd / Middle St	Kane	T-1A
1816	06	TS6052	US 34 (Ogden Ave)	Rush-Copley Hospital Entrance	Kane	T-1A
1817		TS6053	US 34 (Ogden Ave)	Ridge Ave / Waterford Dr	Kane	T-1A
1818	06	TS7331	IL 47	Freeman Rd	Kane	T-1A
1819	06	TS7332	IL 47	Del Webb Blvd	Kane	T-1A
1820		TS7339	IL 47	Big Timber Rd	Kane	T-1A
1821	06	TS8975	IL 31 (2nd St)	Illinois St	Kane	T-1A
1822	06	TS8990	IL 64 (Main St)	IL 25 (5th Ave)	Kane	T-1A
1823	06	TS8995	IL 25 (5th Ave)	Illinois Ave	Kane	T-1A
1824	06	TS9010	IL 64 (Main St)	IL 31 (2nd St)	Kane	T-1A
1825	06	TS9015	IL 64 (Main St)	3rd St	Kane	T-1A
1826	06	TS9016	IL 64 (Main St)	7th St	Kane	T-1A
1827	06	TS9017	IL 64 (Main St)	15th St	Kane	T-1A
1828	06	TS9020	IL 64 (Main St)	7th Ave	Kane	T-1A
1829	06	TS9047	IL 38 (State St)	Meijer Entrance	Kane	T-1A
1830	06	TS9065	IL 64 (Main St)	1st Ave	Kane	T-1A
1831	06	TS9070	IL 64 (Main St)	1st St	Kane	T-1A

Count	Grd Date	Loc #	Main Route	Nearest Cross Street	County	RM Pay Item
1832	06	TS9700	IL 31 (West Lake St)	Knell St	Kane	T-1A
1833	06	TS10945	IL 38 (Roosevelt Rd)	Glengarry Dr	Kane	T-1A
1834	06	TS10950	IL 38 (State St)	3rd St	Kane	T-1A
1835	06	TS10952	IL 38 (State St)	7th St	Kane	T-1A
1836	06	TS10955	IL 38 (State St)	Anderson Blvd	Kane	T-1A
1837		TS11481	IL 31	Lovedale	Kane	T-1A
1838		TS11482	IL 31	Airport	Kane	T-1A
1839		TS11483	IL 31	IL 56 (State St)	Kane	T-1A
1840		TS11484	IL 56 (Butterfield Rd)	Hart Rd / Mitchell Rd	Kane	T-1A
1841		TS11485	IL 56 (Butterfield Rd)	Kirk Rd / Farnsworth Ave	Kane	T-1A
1842		TS11975	IL 56 (Butterfield Rd)	IL 25 (RiverRd)	Kane	T-1A
1843		TS13404	IL 72	Tyrrell	Kane	T-1A
1844	06	TS14865	IL 72 (Higgins Rd)	Locust Dr	Kane	T-1A
1845	06	TS14867	IL 72 (Higgins Rd)	Tartans Dr	Kane	T-1A
1846	06	TS14875	IL 72 (Main St)	5th St	Kane	T-1A
1847	06	TS14880	IL 31 (Western Ave)	Spring Hill Mall Entrance / Spruce Dr	Kane	T-1A
1848	06	TS14885	IL 31 (Western Ave)	Aldi Entrance	Kane	T-1A
1849	06	TS14890	IL 31 (Western Ave)	Main St / Huntley Rd	Kane	T-1A
1850	06	TS14895	Huntley Rd	Elm Ave / Mall Entrance "F"	Kane	T-1A
1851	06	TS14900	IL 31 (8th St)	Willow Ln / Strom Dr	Kane	T-1A
1852	06	TS20373	IL 31	Red Gate Rd	Kane	T-1A
1853	06	TS20390	IL 38 (State St)	St Charles Mall Entrance	Kane	T-1A
1854	06	TS20396	IL 31 (Western Ave)	Kane Ave	Kane	T-1A
1855	06	TS21630	IL 31	Boncosky Rd	Kane	T-1A
1856	06	TS21768	IL 72 (Higgins Rd)	Sleepy Hollow Rd / Carrington Dr	Kane	T-1A
1857	06	TS21935	IL 31 (2nd St)	Prairie St	Kane	T-1A
1858	06	TS21972	US 20	I-90 Tollway	Kane	T-1A
1859	06	TS21996	IL 25	Country Club Rd	Kane	T-1A
1860	06	TS22305	IL 72 (Higgins Rd)	Village Quarter Rd	Kane	T-1A
1861		TS695	US 34 (Ogden Ave)	US 30 (Oswego Rd) / Ogden Falls Blvd	Kendall	T-1A
1862	06	TS696	US 34 (Ogden Ave)	Hill Ave / US 30 (Lincoln Highway)	Kendall	T-1A
1863		TS698	US 34 (Ogden Ave)	Hafenrichter Rd / Farnsworth Ave	Kendall	T-1A
1864	06	TS715	US 30	Briarcliff Rd	Kendall	T-1A
1865	06	TS720	US 30 (Oswego Rd)	Douglas Rd	Kendall	T-1A
1866	06	TS722	US 30	Fifth St	Kendall	T-1A
1867	06	TS837	IL 31 (West Lake St)	Caterpillar Rd	Kendall	T-1A
1868	06	TS21390	US 30 (Lincoln Highway)	Wolfs Crossing Rd	Kendall	T-1A
1869	08	TS557	IL 134 (Long Lake Rd)	Wilson Rd	Lake	T-1A
1870	07	TS558	US 12/IL 59	Hartigan Rd / Home Depot Entrance	Lake	T-1A
1871	07	TS559	US 12/IL 59	IL 134 (Long Lake Rd)	Lake	T-1A
1872		TS717	IL 59 (Grand Ave)	Monaville Rd	Lake	T-1A
1873		TS925	IL 176 (Rockland Rd)	I-94 Tollway W Ramps	Lake	T-1A
1874		TS930	IL 176 (Rockland Rd)	I-94 Tollway E Ramps	Lake	T-1A
1875	08	TS935	IL 137 (Buckley Rd)	I-94 Tollway W Ramps	Lake	T-1A
1876	08	TS936	IL 137 (Buckley Rd)	I-94 Tollway E Ramps	Lake	T-1A
1877		TS940	US 12 (Rand Rd)	IL 22 (Main St)	Lake	T-1A
1878		TS941	IL 22 (Main St)	Village Square Entrance	Lake	T-1A

Count	Grd Date	Loc #	Main Route	Nearest Cross Street	County	RM Pay Item
1879	07	TS945	US 12	Grand Ave	Lake	T-1A
1880	07	TS950	US 12 (Rand Rd)	Old Rand Rd N Junction	Lake	T-1A
1881		TS955	US 12 (Rand Rd)	Quentin Rd	Lake	T-1A
1882		TS957	US12 (Rand Rd)	Quentin Rd Collection	Lake	T-1A
1883	08	TS960	US 12 (Rand Rd)	W Lake Shore Dr / Knollwood Dr	Lake	T-1A
1884	07	TS965	US 12 (Rand Rd)	Long Grove Rd	Lake	T-1A
1885	07	TS966	IL 53 (Hicks Rd)	Long Grove Rd	Lake	T-1A
1886	07	TS967	US 12 (Rand Rd)	Old Rand Rd S Junction	Lake	T-1A
1887	07	TS969	US 12 (Rand Rd)	Deer Park Blvd	Lake	T-1A
1888	07	TS975	US 12 (Rand Rd)	Cuba Rd	Lake	T-1A
1889	08	TS2367	IL 43 (Waukegan Rd)	Oakmont Ave	Lake	T-1A
1890	07	TS4685	US 14 (Northwest Highway)	Berry Rd	Lake	T-1A
1891	07	TS4690	US 14 (Northwest Highway)	Western Chicago Aerial Industries Ent	Lake	T-1A
1892	07	TS4700	US 14 (Northwest Highway)	Hart Rd	Lake	T-1A
1893	07	TS6510	US 12/IL 59	IL 120 (Belvidere Rd)	Lake	T-1A
1894	08	TS6511	US 12/IL 59	Old Belvidere Rd	Lake	T-1A
1895	07	TS6515	US 12/IL 59 E Ramps	IL 176 (Liberty St)	Lake	T-1A
1896	07	TS6516	US 12/IL 59 W Ramps	IL 176 (Liberty St)	Lake	T-1A
1897	07	TS6517	IL 176 (Liberty St)	Waconda Crossing SC Entrance	Lake	T-1A
1898	07	TS6520	US 12/IL 59	Bonner Rd	Lake	T-1A
1899	07	TS6525	US 14 (Northwest Highway)	IL 59 (Hough Rd)	Lake	T-1A
1900	07	TS6530	US 14 (Northwest Highway)	Kelsey Rd	Lake	T-1A
1901	07	TS6531	IL 22 (Lake Zurich-Highwood Rd)	Kelsey Rd	Lake	T-1A
1902	08	TS6535	US 41 (Skokie Highway)	IL 21 (Riverside Dr / Milwaukee Ave)	Lake	T-1A
1903	08	TS6540	US 41 (Skokie Highway)	IL 22 (Half Day Rd)	Lake	T-1A
1904	08	TS6543	IL 22 (Half Day Rd)	US 41 (Skokie Highway) NB Exit Ramp	Lake	T-1A
1905	08	TS6545	US 41 (Skokie Highway)	IL 60 (Kennedy Rd / Town Line Rd)	Lake	T-1A
1906	08	TS6550	US 41 (Skokie Highway)	IL 132 (Grand Ave)	Lake	T-1A
1907	08	TS6551	IL 132 (Grand Ave)	First St	Lake	T-1A
1908	08	TS6555	US 41 (Skokie Highway)	IL 137 (Buckley Rd)	Lake	T-1A
1909	08	TS6560	US 41 (Skokie Highway)	IL 173 (Rockland Rd)	Lake	T-1A
1910	08	TS6565	US 41 (Skokie Highway)	Dr. Martin Luther King Dr / 22nd St	Lake	T-1A
1911	08	TS6567	US 41 (Skokie Highway)	Amhurst Parkway	Lake	T-1A
1912	08	TS6570	US 41 (Skokie Highway)	Delaney Rd	Lake	T-1A
1913	08	TS6575	US 41 (Skokie Highway)	Old Elm Rd	Lake	T-1A
1914		TS6580	US 41 (Skokie Highway)	Wadsworth Rd	Lake	T-1A
1915	08	TS6585	US 41 (Skokie Highway)	Westleigh Rd	Lake	T-1A
1916	08	TS6590	US 41 (Skokie Highway)	West Park Ave	Lake	T-1A
1917	08	TS6595	US 45/IL 21 (Milwaukee Ave)	Old Half Day Rd	Lake	T-1A
1918	08	TS6600	US 45/IL 21 (Milwaukee Ave)	IL 22 (Half Day Rd)	Lake	T-1A
1919	07	TS6605	US 45	IL 60 (Town Line Rd)	Lake	T-1A
1920	07	TS6610	US 45	IL 83 (Mundelein Rd)	Lake	T-1A
1921	08	TS6615	US 45	IL 132 (Grand Ave)	Lake	T-1A
1922	08	TS6617	US 45	Sand Lake Rd	Lake	T-1A
1923		TS6618	US 45	Dada Dr Grant Ave	Lake	T-1A
1924	07	TS6620	US 45	IL 173	Lake	T-1A
1925	08	TS6625	US 45 (Lake St)	IL 176 (Park Ave / Maple Ave)	Lake	T-1A

Count	Grd Date	Loc #	Main Route	Nearest Cross Street	County	RM Pay Item
1926		TS6630	US 45/IL 21 (Milwaukee Ave)	Aptakisic Rd	Lake	T-1A
1927	08	TS6635	US 45	Brae Loch Rd	Lake	T-1A
1928	07	TS6640	US 45	Butterfield Rd	Lake	T-1A
1929	07	TS6641	US 45	Oakwood Rd	Lake	T-1A
1930	08	TS6645	US 45	Center St / Deerpath Rd	Lake	T-1A
1931	08	TS6650	US 45/IL 21 (Milwaukee Ave)	Deerfield Rd	Lake	T-1A
1932	08	TS6655	US 45	Deerpath Dr	Lake	T-1A
1933	08	TS6657	US 45	Commuter Lot / Ranney Ave	Lake	T-1A
1934	08	TS6658	US 45	Buffalo Grove Rd / Fairway Dr	Lake	T-1A
1935	08	TS6660	US 45/IL 21 (Milwaukee Ave)	Inverrary Ln	Lake	T-1A
1936	08	TS6665	US 45/IL 21 (Milwaukee Ave)	Knightsbridge Parkway / Jamestown Ln	Lake	T-1A
1937	07	TS6675	US 45	Peterson Rd	Lake	T-1A
1938	08	TS6680	US 45/IL 21 (Milwaukee Ave)	Busch Parkway	Lake	T-1A
1939	08	TS6685	US 45	Washington St	Lake	T-1A
1940	08	TS6695	US 45/IL 21 (Milwaukee Ave)	Marriott Dr	Lake	T-1A
1941	08	TS6700	IL 21 (Milwaukee Ave)	IL 60 (Town Line Rd)	Lake	T-1A
1942	08	TS6705	IL 21 (Milwaukee Ave)	IL 132 (Grand Ave)	Lake	T-1A
1943	08	TS6710	IL 21 (Milwaukee Ave)	IL 137 (Buckley Rd)	Lake	T-1A
1944	07	TS6715	IL 21 (Milwaukee Ave)	IL 176 (Park Ave)	Lake	T-1A
1945		TS6718	IL 21 (Milwaukee Ave)	Hollister Dr N Junction	Lake	T-1A
1946	07	TS6720	IL 21 (Milwaukee Ave)	Hawthorn Center Dr Entrance # 6	Lake	T-1A
1947	08	TS6725	IL 21 (Milwaukee Ave)	Hawthorn Center Dr Entrance # 7	Lake	T-1A
1948	08	TS6730	IL 21 (Milwaukee Ave)	Washington	Lake	T-1A
1949		TS6732	IL 21 (Milwaukee Ave)	Six Flags Riverside Dr	Lake	T-1A
1950	08	TS6735	IL 22 (Half Day Rd)	IL 43 (Waukegan Rd)	Lake	T-1A
1951	07	TS6740	IL 22 (Lake Zurich-Highwood Rd)	IL 59 (Hough Rd / Lake Shore Blvd)	Lake	T-1A
1952		TS6745	IL 22 (Half Day Rd)	IL 83 (Mundelein Rd)	Lake	T-1A
1953	07	TS6750	IL 22 (Main St)	Church St / Midlothian Rd	Lake	T-1A
1954		TS6751	IL 22 (Main St)	Buesching Rd	Lake	T-1A
1955		TS6753	Midothian Rd	Oakwood Rd / Lakewood Ln	Lake	T-1A
1956	07	TS6755	Main St (Lake Zurich)	Old Rand Rd	Lake	T-1A
1957		TS6757	IL 22 (Half Day Rd)	Old Rand Rd	Lake	T-1A
1958		TS6758	IL 22 (Half Day Rd)	East Main (Lake Zurich)	Lake	T-1A
1959		TS6759	IL 22 (Half Day Rd)	West Main (Lake Zurich)	Lake	T-1A
1960	08	TS6760	IL 22 (Half Day Rd)	Old Half Day Rd	Lake	T-1A
1961		TS6765	IL 22 (Half Day Rd)	Quentin Rd	Lake	T-1A
1962	07	TS6767	IL 22 (Half Day Rd)	Kemper Insurance Entrance	Lake	T-1A
1963	08	TS6770	IL 22 (Half Day Rd)	Riverwoods Rd	Lake	T-1A
1964		TS6775	IL 22 (Half Day Rd)	Ela Rd	Lake	T-1A
1965		TS6780	IL 22 (Half Day Rd)	Barclay Blvd	Lake	T-1A
1966		TS6785	IL 22 (Half Day Rd)	Old Mill Grove Rd / Oakwood Rd	Lake	T-1A
1967	08	TS6790	IL 22 (Half Day Rd)	Westminster Way / Hewitt Dr	Lake	T-1A
1968	08	TS6795	IL 43 (Waukegan Rd)	IL 60 (Town Line Rd)	Lake	T-1A
1969	08	TS6800	IL 137 (Buckley Rd)	IL 43 (Waukegan Rd)	Lake	T-1A
1970	08	TS6805	IL 43 (Waukegan Rd)	IL 176 (Park Ave)	Lake	T-1A
1971	08	TS6806	IL 43 (Waukegan Rd)	Westmoreland Rd / Middle Fork Dr	Lake	T-1A
1972	08	TS6810	IL 43 (Waukegan Rd)	Dr. Martin Luther King Dr / 22nd St	Lake	T-1A

Count	Grd Date	Loc #	Main Route	Nearest Cross Street	County	RM Pay Item
1973	08	TS6815	IL 43 (Waukegan Rd)	Abbott Labs Gate # 1	Lake	T-1A
1974	08	TS6820	IL 43 (Waukegan Rd)	Abbott Labs Gate # 2	Lake	T-1A
1975	08	TS6830	IL 43 (Waukegan Rd)	Foster Ave	Lake	T-1A
1976	07	TS6835	IL 83 (Mundelein Rd)	IL 53 (Breese Rd)	Lake	T-1A
1977	07	TS6837	IL 83 (Mundelein Rd)	Robert Parker Coffin Rd	Lake	T-1A
1978	07	TS6839	IL 53 (Breese Rd)	Old McHenry Rd	Lake	T-1A
1979	07	TS6840	IL 59	IL 132 (Grand Ave)	Lake	T-1A
1980	07	TS6845	IL 59	IL 173	Lake	T-1A
1981		TS6847	IL 173	Walmart	Lake	T-1A
1982	07	TS6850	IL 59 (Grand Ave)	Grand Ave / Washington Ave	Lake	T-1A
1983	07	TS6855	IL 59	Grass Lake Rd	Lake	T-1A
1984		TS6857	IL 59	Beach Grove Rd	Lake	T-1A
1985	07	TS6860	IL 59 (Lake Shore Blvd)	Miller Rd	Lake	T-1A
1986	07	TS6865	IL 60 (Town Line Rd)	Butterfield Rd	Lake	T-1A
1987	07	TS6870	IL 60 (Town Line Rd)	Deerpath Dr	Lake	T-1A
1988	07	TS6875	IL 60 (Town Line Rd)	Lakeview Parkway	Lake	T-1A
1989	07	TS6880	IL 60 (Town Line Rd)	Hawthorn Center Dr # 3	Lake	T-1A
1990	07	TS6885	IL 60 (Town Line Rd)	Hawthorn Center Dr # 4	Lake	T-1A
1991	07	TS6890	IL 60 (Town Line Rd)	Hawthorn Center Dr # 5	Lake	T-1A
1992	08	TS6895	IL 60 (Town Line Rd)	St Marys Rd	Lake	T-1A
1993	08	TS6900	IL 60 (Town Line Rd)	Aspen Dr	Lake	T-1A
1994	07	TS6905	IL 60 (Town Line Rd)	Oak Creek Plaza Entrance	Lake	T-1A
1995		TS6908	IL 60	Cedar Lake Rd / Bacon Rd	Lake	T-1A
1996	07	TS6910	IL 60/IL 83	Schank Ave	Lake	T-1A
1997		TS6911	IL 60/IL 83	Connector Rd / Target Entrance	Lake	T-1A
1998	08	TS6912	IL 60	Fairfield Rd	Lake	T-1A
1999	08	TS6915	IL 60/IL 83	IL 176 (Ivanhoe Rd)	Lake	T-1A
2000	07	TS6917	IL 176 (Ivanhoe Rd)	Hawley Rd W Junction	Lake	T-1A
2001	07	TS6920	IL 60/IL 83	Diamond Lake Rd	Lake	T-1A
2002	07	TS6930	IL 60/IL 83	Hawley Rd	Lake	T-1A
2003	07	TS6935	IL 60/IL 83	Willow Springs Rd	Lake	T-1A
2004	08	TS6940	IL 83 (Ivanhoe Rd)	IL 120 (Belvidere Rd)	Lake	T-1A
2005	08	TS6948	IL 83 (Milwaukee Ave)	Monaville Rd	Lake	T-1A
2006	07	TS6950	IL 83 (Milwaukee Ave)	IL 173	Lake	T-1A
2007	07	TS6955	IL 83	Aptakistic Rd	Lake	T-1A
2008	07	TS6957	IL 83	Hilltop Rd	Lake	T-1A
2009	07	TS6960	IL 83 (Mundelein Rd)	Arlington Heights Rd	Lake	T-1A
2010	07	TS6965	IL 83 (Mundelein Rd)	Deerfield Parkway	Lake	T-1A
2011	07	TS6970	IL 83 (Milwaukee Ave)	Grass Lake Rd	Lake	T-1A
2012	07	TS6975	IL 83 (Mundelein Rd)	Buffalo Grove Rd	Lake	T-1A
2013		TS6982	IL 83 (Ivanhoe Rd)	Peterson Rd	Lake	T-1A
2014	07	TS6985	IL 83 (Mundelein Rd)	Buffalo Grove SC Entrance / Highpoint	Lake	T-1A
2015		TS6990	IL 83	Gilmer Rd / Oakwood Rd	Lake	T-1A
2016	07	TS6992	IL 83	Westmoreland Dr	Lake	T-1A
2017	08	TS6995	IL 120 (Belvidere Rd)	IL 134 (Main St)	Lake	T-1A
2018	08	TS7000	IL 120 (Belvidere Rd)	Hainsville Rd	Lake	T-1A
2019	08	TS7005	IL 120 (Belvidere Rd)	Knight Ave	Lake	T-1A

Count	Grd Date	Loc #	Main Route	Nearest Cross Street	County	RM Pay Item
2020	08	TS7010	IL 120 (Belvidere Rd)	Oplaine Rd	Lake	T-1A
2021	08	TS7015	IL 137 (Buckley Rd)	IL 131 (Green Bay Rd)	Lake	T-1A
2022	08	TS7020	IL 131 (Green Bay Rd)	IL 176 (Rockland Rd)	Lake	T-1A
2023	08	TS7030	IL 131 (Green Bay Rd)	Wadsworth Rd	Lake	T-1A
2024		TS7035	IL 131 (Green Bay Rd)	Washington St	Lake	T-1A
2025	08	TS7040	IL 131 (Green Bay Rd)	Yorkhouse Rd	Lake	T-1A
2026	08	TS7045	IL 131 (Green Bay Rd)	10th St	Lake	T-1A
2027		TS7048	IL 173 (Rosecrans Rd)	Hunt Club Rd	Lake	T-1A
2028		TS7049	IL 131 (Green Bay Rd)	21st St	Lake	T-1A
2029		TS7050	IL 131 (Green Bay Rd)	IL 173 (Rosecrans Rd / 17th St)	Lake	T-1A
2030		TS7054	IL 131 (Green Bay Rd)	Russell Rd	Lake	T-1A
2031	08	TS7055	IL 132 (Grand Ave)	Great America Entrance / Lawson Blvd	Lake	T-1A
2032	08	TS7060	IL 132 (Grand Ave)	Hunt Club Rd	Lake	T-1A
2033	08	TS7062	IL 132 (Grand Ave)	Brookside Dr	Lake	T-1A
2034	08	TS7065	IL 132 (Grand Ave)	Oplaine Rd	Lake	T-1A
2035	08	TS7070	IL 132 (Grand Ave)	Sand Lake Rd	Lake	T-1A
2036	08	TS7075	IL 132 (Grand Ave)	Granada Blvd / Lindenhurst Dr	Lake	T-1A
2037	08	TS7080	IL 132 (Grand Ave)	Deep Lake Rd	Lake	T-1A
2038	08	TS7081	IL 132 (Grand Ave)	Munn Rd	Lake	T-1A
2039	08	TS7085	IL 132 (Grand Ave)	Dilleys Rd	Lake	T-1A
2040	08	TS7090	IL 134 (Long Lake Rd)	Fairfield Rd	Lake	T-1A
2041		TS7094	IL 137 (Buckley Rd)	Butterfield Square	Lake	T-1A
2042		TS7095	IL 137 (Buckley Rd)	Butterfield Rd	Lake	T-1A
2043	08	TS7100	IL 137 (Buckley Rd)	Meridian Dr	Lake	T-1A
2044	08	TS7105	IL 137 (Buckley Rd)	Oplaine Rd	Lake	T-1A
2045	08	TS7110	IL 137 (Buckley Rd)	St Marys Rd	Lake	T-1A
2046	08	TS7115	IL 137 (Buckley Rd)	Great Lakes Dr	Lake	T-1A
2047	08	TS7120	IL 137 (Buckley Rd)	Mississippi St	Lake	T-1A
2048	08	TS7125	IL 137 (Buckley Rd)	Abbott Labs Gate # 3	Lake	T-1A
2049		TS7129	IL 173	Savage Deercrest	Lake	T-1A
2050	07	TS7130	IL 173	Deep Lake Rd	Lake	T-1A
2051	08	TS7132	IL 173 (Rosecrans Rd)	Delaney Rd	Lake	T-1A
2052	08	TS7135	IL 176 (Slocum Lake Rd)	Darrell Rd	Lake	T-1A
2053	08	TS7137	IL 176 (Slocum Lake Rd)	Westridge Dr	Lake	T-1A
2054	08	TS7139	IL 176 (Slocum Lake Rd)	Beech St / Eastway Dr	Lake	T-1A
2055	07	TS7140	IL 176 (Wauconda Rd)	Fairfield Rd	Lake	T-1A
2056	07	TS7142	IL 176 (Ivanhoe Rd)	Gilmer Rd	Lake	T-1A
2057	07	TS7145	IL 176 (Park Ave)	Midlothian Rd	Lake	T-1A
2058	07	TS7150	IL 176 (Wauconda Rd)	Old Rand Rd / Main St	Lake	T-1A
2059	07	TS7152	IL 176 (Liberty St)	Lakrdale Row	Lake	T-1A
2060	08	TS7160	IL 137 (Buckley Rd)	Lewis Ave	Lake	T-1A
2061	08	TS7170	IL 137 (Buckley Rd)	Illinois St	Lake	T-1A
2062	08	TS7175	IL 137 (Buckley Rd)	Ray St	Lake	T-1A
2063	08	TS7190	IL 137 (Sheridan Rd)	Beach Rd	Lake	T-1A
2064	08	TS7200	IL 137 (Sheridan Rd)	Yorkhouse Rd	Lake	T-1A
2065	08	TS7820	IL 131 (Green Bay Rd)	IL 120 (Belvidere Rd)	Lake	T-1A
2066	08	TS9375	IL 131 (Green Bay Rd)	14th St / Casimer Pulaski Dr	Lake	T-1A

Count	Grd Date	Loc #	Main Route	Nearest Cross Street	County	RM Pay Item
2067	07	TS9885	IL 83 (Old McHenry Rd)	Pauline Ave / Town Place Parkway	Lake	T-1A
2068	08	TS10661	Sheridan Rd	Old Elm Rd	Lake	T-1A
2069	08	TS10665	IL 43 (Waukegan Rd)	Deerpath Rd	Lake	T-1A
2070	08	TS10670	IL 43 (Waukegan Rd)	Everett Rd / Old Elm Rd	Lake	T-1A
2071	08	TS10675	IL 43 (Waukegan Rd)	Westleigh Rd	Lake	T-1A
2072	08	TS10676	IL 43 (Waukegan Rd)	Gloucester Crossing	Lake	T-1A
2073	08	TS11115	IL 43 (Waukegan Rd)	Bannockburn Office Entrance	Lake	T-1A
2074	08	TS11595	Sheridan Rd	IL 137 (Buckley Rd)	Lake	T-1A
2075	08	TS11596	Sheridan Rd	24th St	Lake	T-1A
2076	08	TS11597	Sheridan Rd	Farragut Ave	Lake	T-1A
2077	08	TS11598	Sheridan Rd	D St	Lake	T-1A
2078	08	TS11605	IL 22 (Half Day Rd)	Elm Rd / Oxford Dr	Lake	T-1A
2079	08	TS11615	IL 21 (Milwaukee Ave)	Hawthorn Center Dr	Lake	T-1A
2080		TS11700	IL 60 (Town Line Rd)	Bradley Rd / Riverwoods Rd	Lake	T-1A
2081	08	TS11701	IL 60 (Town Line Rd)	Grainger Woods W Entrance	Lake	T-1A
2082		TS11705	IL 60 (Town Line Rd)	I-94 Tollway E Ramps	Lake	T-1A
2083		TS11706	IL 60 (Town Line Rd)	I-94 Tollway W Ramps	Lake	T-1A
2084	08	TS11708	IL 60 (Town Line Rd)	Lake Forest Academy	Lake	T-1A
2085	08	TS11875	US 41 (Skokie Highway)	Clavey Rd / Old Skokie Rd	Lake	T-1A
2086	08	TS11876	Skokie Valley Rd	Clavey Rd	Lake	T-1A
2087	08	TS11877	US 41 (Skokie Highway)	Skokie Valley Rd	Lake	T-1A
2088		TS11930	IL 120 (Belvidere Rd)	Hunt Club Rd	Lake	T-1A
2089	08	TS11935	IL 22 (Half Day Rd)	Telegraph Rd	Lake	T-1A
2090	07	TS11940	IL 59 (Grand Ave)	Wilson Rd / Ridge Ave	Lake	T-1A
2091	07	TS11945	US 12	State Park Rd / East St	Lake	T-1A
2092	07	TS12120	IL 21 (Milwaukee Ave)	Rockland Rd	Lake	T-1A
2093	08	TS12275	US 41 (Skokie Highway)	IL 176 (Rockland Rd) E Ramp	Lake	T-1A
2094	08	TS12280	US 41 (Skokie Highway)	IL 176 (Rockland Rd) W Ramp/Shagbark	Lake	T-1A
2095		TS12285	US 12 (Rand Rd)	Whitney Rd / Northlake Commons Ent	Lake	T-1A
2096	07	TS12290	US 12	Eagle Point Rd / Sayton Rd N Junction	Lake	T-1A
2097	07	TS12295	US 12 (Rand Rd)	Ela Rd	Lake	T-1A
2098	07	TS12297	US 12 (Rand Rd)	June Terrace	Lake	T-1A
2099	08	TS12305	US 45	IL 120 (Belvidere Rd)	Lake	T-1A
2100	07	TS12315	IL 83 (Baron Blvd)	Washington St	Lake	T-1A
2101		TS12317	IL 83 (Baron Blvd)	Brighton Ln	Lake	T-1A
2102	08	TS12330	US 45	Winchester Rd	Lake	T-1A
2103	08	TS12380	IL 22 (Half Day Rd)	I-94 Tollway E Ramps	Lake	T-1A
2104	08	TS12385	IL 22 (Half Day Rd)	I-94 Tollway W Ramps	Lake	T-1A
2105	08	TS12390	IL 22 (Half Day Rd)	Ridge Rd E Junction / Willow Rd	Lake	T-1A
2106	08	TS12391	IL 22 (Half Day Rd)	Tennyson Ln / Ridge Rd W Junction	Lake	T-1A
2107	08	TS12915	IL 43 (Waukegan Rd)	McDonalds Entrance / Cadwells Cr	Lake	T-1A
2108	08	TS12920	IL 43 (Waukegan Rd)	Kates Rd	Lake	T-1A
2109	08	TS12925	IL 43 (Waukegan Rd)	Longfellow Ave / Osterman Ave	Lake	T-1A
2110	08	TS12930	IL 43 (Waukegan Rd)	Deerfield Commons Entrance	Lake	T-1A
2111	08	TS12935	IL 43 (Waukegan Rd)	Deerfield Rd	Lake	T-1A
2112	08	TS12937	IL 43 (Waukegan Rd)	Deerfield Fire Station	Lake	T-1A
2113	08	TS12940	IL 43 (Waukegan Rd)	Hazel Ave / Elder Ln	Lake	T-1A

Count	Grd Date	Loc #	Main Route	Nearest Cross Street	County	RM Pay Item
2114	08	TS12945	IL 43 (Waukegan Rd)	Greenwood Ave	Lake	T-1A
2115	08	TS12950	IL 43 (Waukegan Rd)	Deerfield High School Entrance	Lake	T-1A
2116	08	TS12952	IL 43 (Waukegan Rd)	North Ave	Lake	T-1A
2117	07	TS13739	IL 83 (Baron Blvd)	Library Ln	Lake	T-1A
2118	08	TS13740	IL 83 (Baron Blvd)	Center St	Lake	T-1A
2119	07	TS13741	IL 83 (Baron Blvd)	Frederick Rd	Lake	T-1A
2120	08	TS13742	IL 120 (Belvidere Rd)	Lake St / Lake Ave	Lake	T-1A
2121	07	TS13985	IL 21 (Milwaukee Ave)	Winchester Rd	Lake	T-1A
2122	07	TS13990	IL 21 (Milwaukee Ave)	Cook Ave	Lake	T-1A
2123	07	TS13995	IL 21 (Milwaukee Ave)	Church St	Lake	T-1A
2124	07	TS14005	IL 21 (Milwaukee Ave)	Valley Park Dr	Lake	T-1A
2125	07	TS14007	IL 21 (Milwaukee Ave)	Condell Dr	Lake	T-1A
2126		TS14013	IL 21 (Milwaukee Ave)	Artaius Parkway S Junction	Lake	T-1A
2127	07	TS14015	IL 21 (Milwaukee Ave)	Red Top Dr / Greentree Parkway	Lake	T-1A
2128	07	TS14016	IL 21 (Milwaukee Ave)	Adler Park Ent / North Fire Station Ent	Lake	T-1A
2129	07	TS14017	IL 21 (Milwaukee Ave)	Golf Rd	Lake	T-1A
2130	08	TS14018	IL 21 (Milwaukee Ave)	Greggs Parkway / Artaius Parkway N Jnct	Lake	T-1A
2131		TS14020	IL 176 (Park Ave)	Butterfield Rd	Lake	T-1A
2132	07	TS14025	IL 176 (Park Ave)	Garfield Ave	Lake	T-1A
2133	07	TS14030	IL 176 (Park Ave)	Dawes St	Lake	T-1A
2134	07	TS14035	IL 176 (Park Ave)	4th Ave / Wedgemere Ave	Lake	T-1A
2135	07	TS14340	US 45 (Lake St)	Diamond Lake Rd / Forest Dr	Lake	T-1A
2136	07	TS14345	US 45 (Lake St)	Division St	Lake	T-1A
2137	08	TS14350	US 45 (Lake St)	Hawley St	Lake	T-1A
2138	07	TS14370	US 45 (Lake St)	Allanson Rd	Lake	T-1A
2139	07	TS14372	US 45 (Lake St)	Courtland St	Lake	T-1A
2140	08	TS14904	IL 43 (Waukegan Rd)	Casimer Pulaski Dr / McGraw Rd	Lake	T-1A
2141	08	TS14905	IL 43 (Waukegan Rd)	Lakehurst Rd	Lake	T-1A
2142	08	TS14910	IL 43 (Waukegan Rd)	Greenleaf St / Fountain Square Pl	Lake	T-1A
2143	08	TS14915	IL 43 (Waukegan Rd)	North Point Blvd	Lake	T-1A
2144	08	TS14917	IL 43 (Waukegan Rd)	Lakeside Dr / Baxter Entrance	Lake	T-1A
2145	08	TS14925	Greenleaf St	IL 120 (Belvidere Rd) N Ramps	Lake	T-1A
2146	08	TS14930	Greenleaf St	IL 120 (Belvidere Rd) S Ramps	Lake	T-1A
2147	08	TS15020	IL 131 (Green Bay Rd)	IL 132 (Grand Ave)	Lake	T-1A
2148	08	TS15022	IL 131 (Green Bay Rd)	Brookside Ave	Lake	T-1A
2149		TS15025	IL 131 (Green Bay Rd)	Sunset Ave (Bonnie Brook Rd)	Lake	T-1A
2150	08	TS20375	IL 176 (Rockland Rd)	Bradley Rd	Lake	T-1A
2151		TS20425	IL 22 (Half Day Rd)	Buffalo Grove Rd	Lake	T-1A
2152		TS20426	IL 22 (Half Day Rd)	Buffalo Grove Fire Station Entrance	Lake	T-1A
2153	08	TS20485	IL 131 (Green Bay Rd)	Crescent Ave	Lake	T-1A
2154		TS20530	IL 60 (Town Line Rd)	Saunders Rd / Field Dr	Lake	T-1A
2155	07	TS20535	US 12 (Rand Rd)	Pheasant Ridge Rd	Lake	T-1A
2156	08	TS20595	US 12 (Rand Rd)	Old McHenry Rd	Lake	T-1A
2157	08	TS20995	US 45/IL 21 (Milwaukee Ave)	Riverwalk Dr / Columbus Parkway	Lake	T-1A
2158	08	TS21000	IL 132 (Grand Ave)	Gurnee Mills SW Access	Lake	T-1A
2159	08	TS21010	IL 137 (Amstutz Expy)	IL 137 (Buckley Rd)	Lake	T-1A
2160	07	TS21070	US 45	Evergreen Dr	Lake	T-1A

Count	Grd Date	Loc #	Main Route	Nearest Cross Street	County	RM Pay Item
2161	08	TS21085	IL 137 (Amstutz Expy)	Dr Martin Luther King Dr / 22nd St	Lake	T-1A
2162	08	TS21110	IL 132 (Grand Ave)	Gurnee Mills SE Access	Lake	T-1A
2163	08	TS21115	IL 132 (Grand Ave)	Gurnee Mills West Ent / Sams Club Ent	Lake	T-1A
2164	08	TS21117	IL 132 (Grand Ave)	Almond Rd / Hutchins Rd	Lake	T-1A
2165		TS21118	IL 132 (Grand Ave)	Rollings Rd / Oakwood Dr	Lake	T-1A
2166	08	TS21119	IL 132 (Grand Ave)	Stonebrook Dr	Lake	T-1A
2167	08	TS21120	US 41 (Skokie Highway)	Stearns School Rd	Lake	T-1A
2168		TS21181	IL 22 (Half Day Rd)	Main St / Prairie Rd W Junction	Lake	T-1A
2169	07	TS21190	IL 59 (Barrington Rd / Lake Shore)	Kelsey Rd	Lake	T-1A
2170	08	TS21195	IL 132 (Grand Ave)	Belle Plaine Ave	Lake	T-1A
2171		TS21215	IL 22 (Half Day Rd)	Arboretum Way	Lake	T-1A
2172	08	TS21260	US 45 (Lake St)	Motorola Parkway	Lake	T-1A
2173	07	TS21295	US 12 (Rand Rd)	Miller Rd	Lake	T-1A
2174	07	TS21350	IL 59 (Hough Rd)	Cuba Rd	Lake	T-1A
2175	08	TS21405	US 45/IL 21 (Milwaukee Ave)	Tower Parkway	Lake	T-1A
2176	08	TS21410	IL 21 (Milwaukee Ave)	Corporate Woods Parkway	Lake	T-1A
2177	08	TS21411	IL 21 (Milwaukee Ave)	Woodlands Parkway	Lake	T-1A
2178	07	TS21420	US 45 (Lake St)	Dunbar Rd	Lake	T-1A
2179	08	TS21490	IL 21 (Milwaukee Ave)	Lake St	Lake	T-1A
2180	07	TS21525	IL 22 (Lake Zurich Rd)	Old McHenry Rd	Lake	T-1A
2181		TS21543	IL 21 (Milwaukee Ave)	IL 120 (Belvidere Rd) N Ramps	Lake	T-1A
2182		TS21544	IL 21 (Milwaukee Ave)	IL 120 (Belvidere Rd) S Ramps	Lake	T-1A
2183	08	TS21545	IL 21 (Milwaukee Ave)	Gages Lake Rd	Lake	T-1A
2184	08	TS21625	IL 134 (Main St)	Hart Rd	Lake	T-1A
2185	08	TS21635	IL 83 (Milwaukee Ave)	Petite Lake Rd	Lake	T-1A
2186	07	TS21660	US 45	IL 137 (Buckley Rd)	Lake	T-1A
2187	08	TS21662	IL 137 (Buckley Rd)	Harris Rd / Casey Rd	Lake	T-1A
2188	08	TS21695	IL 43 (Waukegan Rd)	Baxter Entrance / Norman Rd S Junction	Lake	T-1A
2189	08	TS21715	IL 43 (Waukegan Rd)	Abbott Labs Gate # 4	Lake	T-1A
2190	08	TS21717	IL 43 (Waukegan Rd)	Atkinson Rd	Lake	T-1A
2191		TS21755	US 45	Grass Lake Rd	Lake	T-1A
2192		TS21756	US 45	Millburn Rd	Lake	T-1A
2193		TS21785	US 12 (Rand Rd)	Plum Grove Rd	Lake	T-1A
2194	07	TS21940	IL 120 (Belvidere Rd)	Gilmer Rd	Lake	T-1A
2195		TS21965	IL 22 (Half Day Rd)	Palazzo Dr / Stevenson HS Entrance	Lake	T-1A
2196	08	TS21969	IL 120 (Belvidere Rd)	Mill Rd	Lake	T-1A
2197	07	TS21975	US 45 (Lake St)	Townline Square SC Ent / Jewel Entrance	Lake	T-1A
2198	08	TS21990	IL 83 (Baron Blvd)	Lake Ave	Lake	T-1A
2199	08	TS21991	IL 83 (Milwaukee Ave)	Home Depot Entrance / Millstone Circle	Lake	T-1A
2200	08	TS21992	IL 83 (Milwaukee Ave)	Hook Dr / Old Rollins Rd	Lake	T-1A
2201		TS21993	IL 83 (Baron Blvd)	Shorewood Rd	Lake	T-1A
2202	07	TS22010	IL 120 (Belvidere Rd)	IL 60	Lake	T-1A
2203	07	TS22040	IL 59 (Barrinton Rd)	Roberts Rd	Lake	T-1A
2204	07	TS22041	IL 59 (Barrinton Rd)	Indian Trail Rd / Essex Pl	Lake	T-1A
2205	08	TS22050	IL 21 (Milwaukee Ave)	Market Place Entrance / Continental Dr	Lake	T-1A
2206	07	TS22102	IL 120 (Belvedere Rd)	Darrell Rd	Lake	T-1A
2207	07	TS22130	IL 59	Devlin Rd	Lake	T-1A

Count	Grd Date	Loc #	Main Route	Nearest Cross Street	County	RM Pay Item
2208	07	TS22205	Gilmer Rd	Midlothian Rd	Lake	T-1A
2209	08	TS22250	IL 120 (Belvidere Rd)	Fairfield Rd	Lake	T-1A
2210	08	TS22255	IL 120 (Belvidere Rd)	Wilson Rd	Lake	T-1A
2211	07	TS1236	US 14 (Northwest Highway)	Algonquin Rd	McHenry	T-1A
2212	07	TS1237	US 14 (Northwest Highway)	Lincoln Ave	McHenry	T-1A
2213		TS1238	US 14 (Northwest Highway)	Foxmoor Rd	McHenry	T-1A
2214	07	TS2996	US 14 (Northwest Highway)	Motorola Entrance	McHenry	T-1A
2215	07	TS5812	US 14 (Northwest Highway)	Wal Mart Entrance	McHenry	T-1A
2216	07	TS7210	US 12	IL 31 / Tyron Grove Rd	McHenry	T-1A
2217	07	TS7215	US 12	IL 173	McHenry	T-1A
2218	07&08	TS7220	US 12	Fox Lake Rd	McHenry	T-1A
2219	07	TS7223	US 12	Wilmot Rd	McHenry	T-1A
2220	07	TS7225	US 12	Winn Rd / Johnsburg Spring Grove Rd	McHenry	T-1A
2221	07	TS7230	US 14 (Northwest Highway)	IL 22	McHenry	T-1A
2222	07	TS7235	US 14 (Northwest Highway)	IL 47 (Eastwood Dr)	McHenry	T-1A
2223	07	TS7236	US 14 (Northwest Highway)	Lake Ave	McHenry	T-1A
2224	07	TS7237	US 14 (Northwest Highway)	West Lake Shore Dr	McHenry	T-1A
2225	07	TS7238	US 14 (Northwest Highway)	Dean St	McHenry	T-1A
2226		TS7240	US 14 (Divisin St)	IL 173 WB (Brink St)	McHenry	T-1A
2227	07	TS7245	US 14 (Northwest Highway)	West Main St {Cary}	McHenry	T-1A
2228	07	TS7246	US 14 (Northwest Highway)	East Main St {Cary}	McHenry	T-1A
2229	07	TS7248	US 14 (Northwest Highway)	Cary Square Shopping Center	McHenry	T-1A
2230	07	TS7260	US 14 (Northwest Highway)	Three Oaks Rd	McHenry	T-1A
2231	07	TS7270	US 14 (Divisin St)	IL 173 EB (Diggins St)	McHenry	T-1A
2232	07	TS7275	US 14 (Northwest Highway)	First St	McHenry	T-1A
2233	07	TS7280	IL 31 (Main St)	IL 62 (Algonquin Rd)	McHenry	T-1A
2234		TS7285	IL 120 (Elm St) W Junction	IL 31 (Front St)	McHenry	T-1A
2235	07	TS7288	IL 31 (Front St)	Prime Parkway / Albany St	McHenry	T-1A
2236	07	TS7289	IL 31 (Front St)	Shamrock Ln	McHenry	T-1A
2237	07	TS7290	IL 120 (Elm St) E Junction	IL 31 (Richmond Rd)	McHenry	T-1A
2238	07	TS7295	IL 31	IL 176 (Terra Cotta Ave)	McHenry	T-1A
2239	07	TS7296	IL 176 (Crystal Lake Rd)	Valley View Rd	McHenry	T-1A
2240	07	TS7300	IL 31 (Front St)	Bull Valley Rd / Charles J Miller Rd	McHenry	T-1A
2241	07	TS7305	IL 31	Crystal Lake Ave	McHenry	T-1A
2242	07	TS7310	IL 31 (Barnard Mill Rd)	Johnsburg Rd	McHenry	T-1A
2243	08	TS7315	IL 31	Three Oaks Rd	McHenry	T-1A
2244	07	TS7320	IL 47	Algonquin Rd / Oakcrest Dr	McHenry	T-1A
2245		TS7322	IL 47	Reed Rd	McHenry	T-1A
2246	07	TS7323	IL 47 (Eastwood Dr)	McConnell Rd	McHenry	T-1A
2247	07	TS7325	IL 47 (Eastwood Dr)	Lake Ave	McHenry	T-1A
2248	07	TS7330	IL 47	Main St / Huntley Rd	McHenry	T-1A
2249	07	TS7335	IL 120 (Elm St)	Chapel Hill Rd	McHenry	T-1A
2250	07	TS7340	IL 120 (Elm St)	River Rd	McHenry	T-1A
2251	07	TS7342	IL 120	Thompson Rd	McHenry	T-1A
2252		TS7345	IL 120	East Wonder Lake Rd / Ridge Rd	McHenry	T-1A
2253	07	TS7740	IL 176 (Crystal Lake Rd)	River Rd	McHenry	T-1A
2254	07	TS7741	IL 176 (Crystal Lake Rd)	Newport Ct	McHenry	T-1A

Count	Grd Date	Loc #	Main Route	Nearest Cross Street	County	RM Pay Item
2255		TS7795	IL 62 (Algonquin Rd)	Eastgate Dr	McHenry	T-1A
2256	07	TS7797	IL 31 (Main St)	Huntington Dr	McHenry	T-1A
2257	07	TS7996	IL 31 (Main St)	Edgewood Dr	McHenry	T-1A
2258		TS11580	IL 62 (Algonquin Rd)	Harrison St	McHenry	T-1A
2259	07	TS11880	IL 176	Roberts Rd	McHenry	T-1A
2260	07	TS11885	IL 31(Richmond Rd)	Pearl St	McHenry	T-1A
2261	07	TS11890	IL 31 (Front St)	Lillian St / Grove Ave	McHenry	T-1A
2262		TS11895	IL 31 (Richmond Rd)	McCullom Lake Rd	McHenry	T-1A
2263		TS11896	IL 31 (Richmond Rd)	Diamond Dr	McHenry	T-1A
2264	07	TS11897	IL 31 (Richmond Rd)	Blake Rd	McHenry	T-1A
2265		TS11900	IL 120 (Elm St)	Ringwood Rd / Curran Rd	McHenry	T-1A
2266		TS11905	IL 120 (Elm St)	Meadow Ln	McHenry	T-1A
2267		TS11910	IL 120 (Elm St)	Industrial Dr / Oak Dr	McHenry	T-1A
2268		TS11915	IL 120 (Elm St)	Crystal Lake Rd	McHenry	T-1A
2269	07	TS11920	IL 120 (Elm St)	Green St	McHenry	T-1A
2270	07	TS11925	IL 120 (Elm St)	Riverside Dr	McHenry	T-1A
2271		TS12170	IL 62 (Algonquin Rd)	Algonquin Town Center Shopping Center	McHenry	T-1A
2272	07	TS15080	Russel Ct	IL 47 (Seminary Ave)	McHenry	T-1A
2273	07	TS15087	IL 47 (Eastwood Ave)	Irving Ave	McHenry	T-1A
2274	07	TS15088	IL 47 (Eastwood Ave)	IL 120 (McHenry Ave)	McHenry	T-1A
2275		TS15089	IL 120 (McHenry Ave)	Raffel Rd	McHenry	T-1A
2276	07	TS20913	US 14 (Division St)	Crowley Rd	McHenry	T-1A
2277	07	TS21240	IL 47	IL 176 S Junction	McHenry	T-1A
2278	07	TS21241	IL 47	IL 176 N Junction	McHenry	T-1A
2279	07	TS21460	US 14 (Division St)	Airport Rd / McGuire Rd	McHenry	T-1A
2280	07	TS21463	US 14 (Division St)	IL 23	McHenry	T-1A
2281	07	TS21470	US 14 (Northwest Highway)	Kishwaukee Valley Rd	McHenry	T-1A
2282	08	TS21640	IL 62 (Algonquin Rd)	Sandbloom Rd / Countryside Dr	McHenry	T-1A
2283	07	TS21815	US 14 (Northwest Highway)	Jandus Cutoff / Lake Julian Ln	McHenry	T-1A
2284	07	TS21970	US 20 (Grant Highway)	IL 23 (State St)	McHenry	T-1A
2285	07	TS21971	IL 23 (State St)	IL 176 (Telegraph St)	McHenry	T-1A
2286	07	TS22100	IL 120 (Rand Rd)	Lily Lake Rd	McHenry	T-1A
2287		TS22155	IL 31	James R Rakow Rd	McHenry	T-1A
2288	08	TS22156	IL 31	Virginia St	McHenry	T-1A
2289	08	TS22157	IL 31	Klasen Rd	McHenry	T-1A
2290	07	TS22220	US 14 (Northwest Highway)	Algonquin-Cary Rd / Silver Lake Rd	McHenry	T-1A
2291	07	TS22242	County Line Rd	Haegers Bend Rd	McHenry	T-1A
2292	07	TS22245	IL 62 (Algonquin Rd)	County Line Rd	McHenry	T-1A
2293	06	TS452	US 30 (Lincoln Highway)	Gougar Rd	Will	T-1A
2294		TS924	IL 1 (Main St)	Crete Monee Rd	Will	T-1A
2295	06	TS4290	US 30 (Plainfield Rd)	Larkin Ave	Will	T-1A
2296	06	TS4295	IL 7 (Larkin Ave)	Theodore St	Will	T-1A
2297	06	TS4730	IL 7 (Larkin Ave)	Hillcrest Shopping Center Entrance	Will	T-1A
2298		TS6385	IL 59 (Brook Forest Ave)	Caton Farm Rd	Will	T-1A
2299	06	TS7350	Weber Rd	Normantown Rd / Budler Rd	Will	T-1A
2300	06	TS7352	I-55	Weber Rd S Ramps	Will	T-1A
2301	06	TS7354	I-55	Weber Rd N Ramps	Will	T-1A

Count	Grd Date	Loc #	Main Route	Nearest Cross Street	County	RM Pay Item
	06	TS7385	I-80	Richards St N Ramp	Will	T-1A
2303		TS7386	US 52 (North St)	Manhattan Rd / Foxford Dr	Will	T-1A
2304	06	TS7390	I-80	Richards St S Ramp	Will	T-1A
2305	06	TS7395	US 30 (Lincoln Highway)	I-80 E Ramps	Will	T-1A
2306	06	TS7400	US 30 (Lincoln Highway)	I-80 W Ramps	Will	T-1A
2307	06	TS7405	US 6 (Channahon Rd)	IL 7 (Larkin Ave/Belt Line Rd)	Will	T-1A
2308	06	TS7410	US 6 (Maple Rd)	Walnut St / Draper Ave	Will	T-1A
2309	06	TS7411	US 45 (96th Ave)	Lincoln Way Ln	Will	T-1A
2310		TS7412	US 45 (96th Ave)	Laraway Rd	Will	T-1A
2311	06	TS7413	US 45 (96th Ave)	Nebraska St	Will	T-1A
2312		TS7414	IL 45 (96th Ave)	Old Frankfort Way	Will	T-1A
2313	06	TS7415	US 30 (North St / Lincoln Highway)	US 45 (96th Ave)	Will	T-1A
2314	06	TS7416	US 30 (North St / Lincoln Highway)	Elsner Rd	Will	T-1A
2315		TS7418	US 30	Pfiever Dr	Will	T-1A
2316	06	TS7420	US 30 (Plainfield Rd)	IL 7 (Theodore St)	Will	T-1A
2317	06	TS7425	US 30 (Joliet Rd)	IL 59 (Division St)	Will	T-1A
2318	06	TS7430	US 30 (Plainfield Rd)	Caton Farm Rd / Gaylord Rd	Will	T-1A
2319		TS7431	US 6 (Southwest Hwy)	I 355 Tlwy W Ramps	Will	T-1A
2320		TS7432	US 6 (Southwest Hwy)	I 355 Tlwy E Ramps	Will	T-1A
2321		TS7433	US 6 (Southwest Hwy)	Cedar	Will	T-1A
2322	06	TS7435	US 30 (Maple Ave)	Cedar Rd	Will	T-1A
2323	06	TS7440	US 30 (Maple Ave)	Nelson Rd	Will	T-1A
2324	06	TS7445	US 30 (Cass St)	Walnut St	Will	T-1A
2325	06	TS7450	US 30 (Lincoln Highway)	Washington St	Will	T-1A
2326	06	TS7455	US 30 (Maple Ave)	Vine St	Will	T-1A
2327	06	TS7460	US 30 (Cass St)	Briggs St	Will	T-1A
2328	06	TS7465	US 30 (Maple Ave)	Vine St / Old New Lenox Rd	Will	T-1A
2329	06	TS7470	US 30 (Joliet Rd)	Renwick Rd / Brown St	Will	T-1A
2330		TS7472	US 30	Lily Cache	Will	T-1A
2331	06	TS7474	IL 59 (Division St)	Renwick Rd	Will	T-1A
2332	06	TS7475	US 30 (Lincoln Highway)	Wolf Rd	Will	T-1A
2333		TS7480	US 45 (LaGrange Rd / 96th Ave)	191st St	Will	T-1A
2334		TS7482	US 45 (LaGrange Rd / 96th Ave)	I-80 S Ramps	Will	T-1A
2335		TS7483	US 45 (LaGrange Rd / 96th Ave)	I-80 N Ramps	Will	T-1A
2336	06	TS7485	US 45 (LaGrange Rd / 96th Ave)	195th St / Willow Ln	Will	T-1A
2337	06	TS7490	US 52 (Doris Ave)	IL 53 (Chicago St)	Will	T-1A
2338	06	TS7495	US 52 (Jefferson St)	IL 59 (Brook Forest Ave)	Will	T-1A
2339	06	TS7496	US 52 (Jefferson St)	Brookshore Dr	Will	T-1A
2340		TS7497	US 52 (Jefferson St)	River Rd	Will	T-1A
2341	06	TS7500	IL 1 (Main St)	Exchange St	Will	T-1A
2342		TS7503	IL 1 (Dixie Highway)	Church Rd	Will	T-1A
2343	06	TS7505	IL 1 (Dixie Highway)	Indiana Ave / 303rd St	Will	T-1A
2344	06	TS7510	IL 7/IL 53 (Broadway St)	IL 7 (Renwick Rd)	Will	T-1A
2345	06	TS7515	IL 7/IL 53 (Broadway St)	IL 7 (Theodore St)	Will	T-1A
2346	06	TS7520	IL 7 (159th St)	Bell Rd W Junction	Will	T-1A
2347	06	TS7525	IL 7 (159th St)	Cedar Rd	Will	T-1A
2348	06	TS7530	IL 7 (Larkin Ave)	Moen Ave	Will	T-1A

Count	Grd Date	Loc #	Main Route	Nearest Cross Street	County	RM Pay Item
2349		TS7532	IL 7 (Larkin Ave)	Meadow Ave	Will	T-1A
2350	06	TS7535	IL 7 (Theodore St)	Arbor Ln / Crest Dr	Will	T-1A
2351	06	TS7540	IL 7 (Larkin Ave)	North Ridge Plaza Drive	Will	T-1A
2352	06	TS7545	IL 7/IL 53)Broadway St)	Stateville Rd / Division St / 16th St	Will	T-1A
2353	06	TS7550	IL 50 (Cicero Ave)	Governors Highway	Will	T-1A
2354	06	TS7555	IL 53 (Baltimore St)	IL 102 (Water St)	Will	T-1A
2355	06	TS7560	IL 53 (Broadway St)	Airport Rd	Will	T-1A
2356	06	TS7565	IL 53 (Independence Ave)	Joliet Rd	Will	T-1A
2357	06	TS7567	Joliet Rd	Bluff Rd / Donovan Rd	Will	T-1A
2358		TS7570	IL 53 (Chicago St)	Laraway Rd	Will	T-1A
2359	06	TS7575	IL 53 (Independence Ave)	Normantown Rd / Devonwood Ave	Will	T-1A
2360	06	TS7580	IL 53	Kankakee River Dr / Peotone Rd	Will	T-1A
2361	06	TS7585	IL 59 (Division St)	IL 126 (Main St)	Will	T-1A
2362	06	TS7586	IL 59 (Division St)	Plainfield-Naperville Rd	Will	T-1A
2363		TS7587	IL 59 (Division St)	Meijer Ent	Will	T-1A
2364		TS7588	IL 59 (Division St)	143rd St / Whiskey Rd	Will	T-1A
2365	06	TS7600	IL 102 (Water St)	Kahler Rd	Will	T-1A
2366	06	TS7605	IL 171 (Archer Ave)	143rd St	Will	T-1A
2367	06	TS7607	IL 171 (Archer Ave)	Smith Rd	Will	T-1A
2368		TS7608	IL 171	I 355 Tlwy Ramp A SB	Will	T-1A
2369		TS7609	IL 171	I 355 Tlwy Ramp D NB	Will	T-1A
2370	06	TS7610	IL 171 (Collins St)	Woodruff Rd	Will	T-1A
2371	06	TS7615	IL 394	Exchange St	Will	T-1A
2372	06	TS7859	IL 53 (Independence Ave)	Honeytree Dr	Will	T-1A
2373	06	TS7866	IL 53 (Independence Ave)	Enterprise Dr	Will	T-1A
2374	06	TS9105	IL 53 (Independence Ave)	135th St / Romeo Rd	Will	T-1A
2375	06	TS9115	IL 53 (Independence Ave)	Belmont Dr	Will	T-1A
2376	06	TS9120	IL 53 (Independence Ave)	Murphy Dr	Will	T-1A
2377		TS9125	135th St / Romeo Rd	New Ave	Will	T-1A
2378		TS9130	IL 53 (Independence Ave)	Taylor Rd	Will	T-1A
2379	06	TS11045	US 45 (96th Ave)	Colorado Ave	Will	T-1A
2380	06	TS11135	IL 53 (Baltimore St)	1st St	Will	T-1A
2381		TS11630	US 45 (96th Ave)	St Francis Rd	Will	T-1A
2382	06	TS11950	US 52/IL 53 (Chicago St)	Patterson Rd	Will	T-1A
2383	06	TS11955	US 30 (Lockport Rd)	IL 59 (Division St)	Will	T-1A
2384	06	TS12260	I 55	US 6 E Ramps	Will	T-1A
2385	06	TS12265	I 55	US 6 W Ramps	Will	T-1A
2386		TS12266	US 6 (Eames St)	Tryon St	Will	T-1A
2387		TS12267	US 6 (Eames St)	Bluff Rd / Navajo Dr	Will	T-1A
2388		TS12268	US 6 (Eames St)	Roberts Rd / Steve Rittof Dr	Will	T-1A
2389	06	TS20561	IL 7/IL 53 (Broadway St)	Caton Farm Rd	Will	T-1A
2390	06	TS20600	US 6 (Channahon Rd)	Brandon Rd	Will	T-1A
2391		TS20970	US 30 (Lincoln Highway)	US 30/IL 126 (Lockport Rd)	Will	T-1A
2392		TS20972	US 30 (Lincoln Highway)	135th St	Will	T-1A
2393		TS20979	US 30 (Lincoln Highway)	127th St	Will	T-1A
2394	06	TS21020	US 6 (Maple Rd)	Briggs St / Fernwood Ave	Will	T-1A
2395		TS21134	US 30 (Lincoln Highway)	Retail Dr / Vancina Ln	Will	T-1A

Count	Grd Date	Loc #	Main Route	Nearest Cross Street	County	RM Pay Item
2396	06	TS21135	US 30 (Lincoln Highway)	School House Rd/Schmuhl Rd	Will	T-1A
2397		TS21393	US 30 (Lincoln Highway)	111th St	Will	T-1A
2398	06	TS21435	IL 53 (Chicago Rd)	Manhattan Rd	Will	T-1A
2399		TS21437	IL 53 (Chicago Rd)	Walter Strawn Dr / East Access Rd	Will	T-1A
2400	06	TS21465	IL 59	103rd St	Will	T-1A
2401		TS21516	IL 43 (Harlem Ave)	Benton	Will	T-1A
2402	06	TS21565	US 45 (LaGrange Rd/96th Ave)	La Porte Rd	Will	T-1A
2403	06	TS21570	IL 53 (Chicago St)	Mills Rd	Will	T-1A
2404	06	TS21590	Joliet Rd	International Blvd / International Parkway	Will	T-1A
2405	06	TS21820	I-80 N Ramp	IL 53 (Chicago St)	Will	T-1A
2406	06	TS21825	US 6/US 52 (McDonough St)	IL 53 (Chicago St)	Will	T-1A
2407	06	TS21860	IL 59	111th St	Will	T-1A
2408	06	TS21861	IL 59	Royal Worthington Dr	Will	T-1A
2409		TS21862	IL 59	127th St	Will	T-1A
2410		TS21863	IL 59	119th St	Will	T-1A
2411		TS21864	IL 59	135th St	Will	T-1A
2412	06	TS21880	US 6 (Channahon Rd)	Caterpillar Center Dr / Johns Manville Ent	Will	T-1A
2413	06	TS21881	US 6 (Channahon Rd)	Caterpillar E Dr	Will	T-1A
2414	06	TS21882	US 6 (Channahon Rd)	Empress Casino Entrance	Will	T-1A
2415	06	TS21883	US 6 (Eames St)	McClintock Rd	Will	T-1A
2416		TS21893	IL 59	Cantore Rd	Will	T-1A
2417		TS21895	IL 59	95th St / Wolfs Crossing Rd	Will	T-1A
2418	06	TS21900	US 6 (Channahon Rd)	Empress Rd	Will	T-1A
2419	06	TS21925	Houbolt Rd	I-80 N Ramps	Will	T-1A
2420	06	TS21926	Houbolt Rd	I-80 S Ramps	Will	T-1A
2421		TS22055	IL 43 (Harlem Ave)	St Francis Rd	Will	T-1A
2422	06	TS22180	US 52 (Jefferson St)	I 55 E Ramps	Will	T-1A
2423	06	TS22185	US 52 (Jefferson St)	I 55 W Ramps	Will	T-1A
2424	06	TS22191	US 52 (Jefferson St)	I 55 East Frontage Rd	Will	T-1A
2425		TS75111	IL 7 (159 th St)	I 355 Tlwy W Ramp	Will	T-1A
2426		TS75112	IL 7 (150 th St)	I 355 Tlwy E Ramp	Will	T-1A
2427		TS78	US 12/20/45 (Mannheim Rd)	Gladys Ave	Cook	T-1B
2428		TS1414	US 30 (Lincoln Highway / 14th St)	Center Ave	Cook	T-1B
2429		TS1668	US 45 (LaGrange)	156 th St Lowes Ent	Cook	T-1B
2430		TS2690	IL 56 (Butterfield Rd)	Washington Blvd	Cook	T-1B
2431		TS2817	IL 58 (Golf Rd)	Continental Towers / Wal Mart Entrance	Cook	T-1B
2432		TS3320	IL 72 (Higgins Rd)	Gabrieski Dr / Air Force Reserve Dr	Cook	T-1B
2433		TS3519	Thorton Lansing Rd	Stony Island Ave / Volbrech Rd	Cook	T-1B
2434		TS4040	135th St	Central Ave	Cook	T-1B
2435		TS5127	IL 394 E Ramp	Glenwood Dyer Rd	Cook	T-1B
2436		TS5128	IL 394 W Ramp	Glenwood Dyer Rd	Cook	T-1B
2437		TS8770	111th St	Oketo Ave	Cook	T-1B
2438		TS11723	183rd St	Central Ave	Cook	T-1B
2439		TS11815	IL 171 (Archer Ave)	123rd St / McCarthy Rd	Cook	T-1B
2440		TS14183	5 th Ave	Main St (St Charles)	Cook	T-1B
2441		TS14861	IL 171 (Archer Ave)	Derby Rd	Cook	T-1B
2442		TS14863	123rd St / McCarthy Rd	Derby Rd	Cook	T-1B

Count	Grd Date	Loc #	Main Route	Nearest Cross Street	County	RM Pay Item
2443		TS21500	IL 83 (Glenwood Dyer Rd)	Burnham Ave	Cook	T-1B
2444		TS21523	143rd St	Will-Cook Rd	Cook	T-1B
2445		TS992	IL 53 (Rohlwing Rd)	Spring Lake Dr / Medinah Dr	DuPage	T-1B
2446		TS5985	I-290 East Ramps	US 20 (Lake St)	DuPage	T-1B
2447		TS6163	IL 19 (Irving Park Rd)	Catalpa Ave	DuPage	T-1B
2448		TS6366	IL 59 (Sutton Rd)	Smith Rd	DuPage	T-1B
2449		TS12373	IL 64 (North Ave)	Atlantic Dr	DuPage	T-1B
2450		TS14496	22 nd St	Jorie Blvd Enterprise Dr	DuPage	T-1B
2451	05	TS20333	IL 53 (Bryant Ave)	Spring Ave	DuPage	T-1B
2452		TS776	US 20/IL 72 S Junction	IL 47	Kane	T-1B
2453		TS777	US 20/IL 72 N Junction	IL 47	Kane	T-1B
2454		TS7333	IL 47	Plank Rd	Kane	T-1B
2455		TS7336	IL 47	I 90 North Ramp	Kane	T-1B
2456		TS7337	IL 47	I 90 South Ramp	Kane	T-1B
2457		TS11980	IL 25	Grant St	Kane	T-1B
2458	06	TS21995	IL 25	Dunham Rd	Kane	T-1B
2459	07	TS6690	US 45	Rollins Rd	Lake	T-1B
2460	08	TS6909	IL 60	Peterson Rd	Lake	T-1B
2461	08	TS6925	IL 60/IL 83	Midlothian Ave	Lake	T-1B
2462	08	TS6943	IL 120 (Belvidere Rd)	Atkinson Rd	Lake	T-1B
2463	08	TS6945	IL 83 (Milwaukee Ave)	IL 132 (Grand Ave)	Lake	T-1B
2464	08	TS6980	IL 83 (Ivanhoe Rd)	IL 137 (Buckley Rd)	Lake	T-1B
2465		TS11707	IL 60 (Town Line Rd)	Conway Farms Entrance	Lake	T-1B
2466	08	TS20350	IL 22 (Half Day Rd)	Lakeside Dr	Lake	T-1B
2467	08	TS21655	US 45	Gages Lake Rd	Lake	T-1B
2468	08	TS21885	US 45	Arbor Blvd	Lake	T-1B
2469	08	TS22052	IL 21 (Milwaukee Ave)	Continental Dr	Lake	T-1B
2470		TS7233	US 14	Ridgefield	McHenry	T-1B
2471		TS7239	US 14	Doty Rd	McHenry	T-1B
2472		TS7242	IL 173	Piscasaw Creek	McHenry	T-1B
2473	07	TS7313	IL 31	Ringwood Rd	McHenry	T-1B
2474		TS7329	IL 47	Kreutzer Rd / Regency Parkway	McHenry	T-1B
2475		TS15085	County Club Rd	IL 47 (Eastwood Dr)	McHenry	T-1B
2476		TS21973	IL 23	Coral Rd / Pleasant Grove Rd	McHenry	T-1B
2477		TS7388	New Lenox Rd	Briggs St	Will	T-1B
2478		TS7393	I-80 Ramps	Briggs St	Will	T-1B
2479		TS7426	IL 59 (Division St)	Fort Beggs Dr	Will	T-1B
2480		TS7493	IL 59	Seil	Will	T-1B
2481		TS7511	IL 7 (159th St)	Gougar Rd	Will	T-1B
2482		TS7514	IL 7 (159th St)	Bell Rd	Will	T-1B
2483		TS7552	IL 50 (Governors Highway)	Court St	Will	T-1B
2484		TS7553	IL 57	Manhattan Monee Rd East	Will	T-1B
2485		TS7554	IL 57	Manhattan Monee Rd West	Will	T-1B
2486		TS7590	IL 59 (Brookforest Ave)	Black Rd	Will	T-1B
2487		TS7593	IL 59 (Brookforest Ave)	Vertin Blvd Target Ent	Will	T-1B
2488		TS7595	IL 59 (Brookforest Ave)	Theodore St	Will	T-1B
2489		TS7626	IL 7 (159th St)	Parker Rd	Will	T-1B

Count	Grd Date	Loc #	Main Route	Nearest Cross Street	County	RM Pay Item
2490		TS20971	US 30 (Lockport St)	Van Dyke Rd	Will	T-1B
2491		TS20974	US 30 (Lincoln Highway)	143rd St / Whiskey Rd	Will	T-1B
1		FL28	US 12 (Lee St)	Park Pl	Cook	T-2A
2		FL490	107th St	Kean Ave	Cook	T-2A
3		FL566	123rd St (McCarthy Rd)	86th St	Cook	T-2A
4		FL1301	US 20 (Lake St)	Elgin-O'Hare	DuPage	T-2A
5		FL1302	IL 53 (Rohlwing Rd)	Elgin-O'Hare	DuPage	T-2A
6		FL1303	Elgin-O'Hare	US 20 (Lake St)	DuPage	T-2A
7		FL1304	Elgin-O'Hare	IL 53 (Rohlwing Rd) Middle Sign	DuPage	T-2A
8		FL1305	Elgin-O'Hare	IL 53 (Rohlwing Rd) West Sign	DuPage	T-2A
9		FL170	IL 31 (Batavia Ave)	Moosehart Entrance	Kane	T-2A
10		FL190	IL 47	IL 64 (North Ave)	Kane	T-2A
11		FL204	IL 47	Burlington Blacktop	Kane	T-2A
12		FL210	IL 47	Main St {Kaneville}	Kane	T-2A
13		FL221	IL 72	State St	Kane	T-2A
14		FL228	IL 47	Plato Rd	Kane	T-2A
15		FL860	IL 38	Meredith	Kane	T-2A
16		FL10697	IL 72 (Higgins Rd)	Big Timber Rd	Kane	T-2A
17		FL765	IL 132 (Grand Ave)	Fairfield Rd	Lake	T-2A
18		FL1210	US 41 (Skokie Highway)	Between Deerfield Rd & West Park Ave	Lake	T-2A
19		FL1306	IL 137 (Buckley Rd)	IL 137 (Amstutz Expressway)	Lake	T-2A
20		FL825	IL 23	Kishwaukee Valley Rd	McHenry	T-2A
21		FL830	IL 47	IL 173	McHenry	T-2A
22		FL835	IL 47	Charles Rd	McHenry	T-2A
23		FL840	IL 120	Charles Rd	McHenry	T-2A
24		FL851	IL 173	Alden Rd	McHenry	T-2A
25	07	FL855	IL 173	Wilmont Rd	McHenry	T-2A
26		FL16	US 6 (Southwest Highway)	Parker Rd	Will	T-2A
27		FL18	US 6 (Southwest Highway)	Cougar Rd	Will	T-2A
28		FL149	US 45 (LaGrange Rd)	Steger Rd	Will	T-2A
29		FL890	US 45 (LaGrange Rd)	Manhattan Monee Rd	Will	T-2A
30		FL895	US 45 / US 52 (Main St)	US 52 (Wilmington-Peotone Rd)	Will	T-2A
31		FL913	IL 50 (Cicero Ave)	Peotone Rd	Will	T-2A
32		FL915	IL 50 (Cicero Ave)	Stuenkel Rd	Will	T-2A
33		FL925	Governors Highway	Stuenkel Rd	Will	T-2A
34		FL930	Manhattan Monee Rd	Cedar Rd	Will	T-2A
35		FL1085	IL 129	Coal City Rd	Will	T-2A
36		FL1086	IL 129	Strip Mine Rd	Will	T-2A
37		FL2515	US 45 (LaGrange Rd)	US 52 (Joliet Rd)	Will	T-2A
38		FL11950	US 52 / IL 53 (Chicago St)	Patterson Rd	Will	T-2A
39		FL20	I-55	I-294 Tollway N Ramp	Cook	T-2B
40		FL21	US 12 (Lee St)	Park Pl	Cook	T-2B
41		FL22	Kedzie Ave	131st St	Cook	T-2B
42		FL27	I-55	I-294 Tollway	Cook	T-2B
43		FL52	I-290 (Congress Parkway)	Old Chicago Post Office	Cook	T-2B
44		FL53	I-290 (Congress Parkway)	Old Chicago Post Office	Cook	T-2B

Count	Grd Date	Loc #	Main Route	Nearest Cross Street	County	RM Pay Item
45		FL54	I-290 (Congress Parkway)	Drawbridge	Cook	T-2B
46		FL55	I-290 (Congress Parkway)	Drawbridge	Cook	T-2B
47		FL158	Wolf Rd	151st St	Cook	T-2B
48		FL330	US 14 (Northwest Highway)	IL 68 (Dundee Rd)	Cook	T-2B
49		FL332	US 14 (Northwest Highway)	UP RR / CN RR	Cook	T-2B
50		FL335	US 14 (Miner St)	Des Plaines River Rd	Cook	T-2B
51		FL480	87th St	Southwest Highway	Cook	T-2B
52		FL530	Ashland Ave / Wood St	140th St	Cook	T-2B
53		FL531	140th St	Ashland Ave	Cook	T-2B
54		FL595	Sheridan Rd	Burnham Pl	Cook	T-2B
55		FL600	Sheridan Rd	Main St	Cook	T-2B
56		FL601	Sheridan Rd	Main St NB	Cook	T-2B
57		FL1008	123 RD WB McCarthy Rd	Walker Rd	Cook	T-2B
58		FL1009	123 rd EB McCarthy Rd	Walker Rd	Cook	T-2B
59		FL1123	IL 83 (Cal Sag Rd)	Ridgeland Ave NB	Cook	T-2B
60		FL1140	US 12/20/45 (Mannheim Rd)	Canterbury / Waterford	Cook	T-2B
61		FL1141	Grand Ave EB Near Right	Elmwood Park (Metra) RR Crossing	Cook	T-2B
62		FL1142	Grand Ave EB Far Right	Elmwood Park (Metra) RR Crossing	Cook	T-2B
63		FL1143	Grand Ave WB Near Right	Elmwood Park (Metra) RR Crossing	Cook	T-2B
64		FL1144	Grand Ave WB Far Right	Elmwood Park (Metra) RR Crossing	Cook	T-2B
65		FL1151	IL 59 SB Near	Lake Cook Rd (North of)	Cook	T-2B
66		FL1152	IL 59 SB Far	Lake Cook Rd (North of)	Cook	T-2B
67		FL1153	Lake Cook Rd WB Near	IL 59 (East of)	Cook	T-2B
68		FL1154	Lake Cook Rd WB Far	IL 59 (East of)	Cook	T-2B
69		FL1222	US 12/20/45 (LaGrange Rd) NB	Weeping Willow Rd	Cook	T-2B
70		FL1223	US 12/20/45 (LaGrange Rd) SB	Weeping Willow Rd	Cook	T-2B
71		FL1251	IL 43 (Waukegan Rd)	Volts Rd	Cook	T-2B
72		FL1290	203 rd	Crawford NB	Cook	T-2B
73		FL1291	203 rd	Crawford SB	Cook	T-2B
74		FL1295	US 14 (Northwest Hwy) WB	Seegers Rd / Broadway	Cook	T-2B
75		FL1296	US 14 (Northwest Hwy) WB Left Side	Seegers Rd / Broadway	Cook	T-2B
76		FL1297	Wolf Rd NB	Camp McDonald Rd	Cook	T-2B
77		FL1298	Oakton St EB	IL 83 (Busse Rd)	Cook	T-2B
78		FL1300	US 14 (Northwest Hwy) EB Minor St	Cumberland Parkway / Metra Dr	Cook	T-2B
79		FL1320	US 20 (Lake St)	Bluff City Blvd	Cook	T-2B
80		FL1321	US 20 (Lake St)	Barrington Rd	Cook	T-2B
81		FL1471	US 34 (Ogden Ave)	W of Joliet Pl	Cook	T-2B
82		FL1472	US 34 (Ogden Ave)	Leland Ave	Cook	T-2B
83		FL1825	IL 1 (Halsted St)	171 st St NB	Cook	T-2B
84		FL2620	IL 50 (Cicero Ave)	Southwest Highway	Cook	T-2B
85		FL2690	IL 56 (Butterfield Rd)	Washington Blvd	Cook	T-2B
86		FL2760	IL 58 (Golf Rd) WB	Gannon Dr	Cook	T-2B
87		FL2761	IL 58 (Golf Rd) EB	Gannon Dr	Cook	T-2B
88		FL3150	IL 62 (Algonquin Rd)	Bateman Rd	Cook	T-2B
89		FL3151	IL 62 (Algonquin Rd)	Bateman Rd	Cook	T-2B
90		FL3160	IL 68 (Dundee Rd) WB	Old Sutton Rd	Cook	T-2B
91		FL3161	IL 68 (Dundee Rd) EB	Old Sutton Rd	Cook	T-2B

Count	Grd Date	Loc #	Main Route	Nearest Cross Street	County	RM Pay Item
92		FL3162	IL 68 (Dundee Rd)	Old Sutton Rd SB	Cook	T-2B
93		FL3163	IL 68 (Dundee Rd)	Old Sutton Rd NB	Cook	T-2B
94		FL3168	IL 68 (Dundee Rd)	Sterling Ave	Cook	T-2B
95		FL3300	IL 72 (Higgins Rd) EB	East of Canfield	Cook	T-2B
96		FL3325	IL 72 (Higgins Rd) WB	Gannon Dr	Cook	T-2B
97		FL3326	IL 72 (Higgins Rd) EB	Gannon Dr	Cook	T-2B
98		FL3555	IL 171 (Archer Ave)	55th St EB	Cook	T-2B
99		FL3556	IL 171 (Archer Ave)	55th St EB	Cook	T-2B
100		FL3357	IL 171 (Archer Ave)	55th St WB	Cook	T-2B
101		FL3558	IL 171 (Archer Ave)	55th St WB	Cook	T-2B
102		FL3575	IL 171 (Archer Ave)	47th St E Ramp NB	Cook	T-2B
103		FL3936	Crawford Ave / Pulaski Rd	123rd St NB	Cook	T-2B
104		FL4034	135th St EB	W of Ridgeland Ave	Cook	T-2B
105		FL4036	135th St WB	W of Ridgeland Ave	Cook	T-2B
106		FL4660	IL 59 NB	West Bartlett Rd	Cook	T-2B
107		FL5240	Francisco	Broadway	Cook	T-2B
108		FL5930	Willow Rd	Old Willow Rd (west of)	Cook	T-2B
109		FL9670	IL 83 (Elmhurst Rd) NB	Lincoln St	Cook	T-2B
110		FL9671	IL 83 (Elmhurst Rd) SB	Lincoln St	Cook	T-2B
111		FL11245	US 12/45 (Lee St)	US 12 45 (Manheim Rd) WB	Cook	T-2B
112		FL11246	US 12 45 Lee St	US 12 45 (Mannheim Rd) NB	Cook	T-2B
113		FL11715	Western Ave	Sauk Trail Rd WB	Cook	T-2B
114		FL11720	IL 50 (Cicero Ave)	175th St	Cook	T-2B
115		FL11725	Dixie Highway	Flossmoor Rd / Cambridge Ave	Cook	T-2B
116		FL11745	IL 394	Sauk Trail Rd NB	Cook	T-2B
117		FL11750	US 6 (159th St) EB	Park Ave Left Side	Cook	T-2B
118		FL11751	US 6 (159th St) WB	Park Ave Right Side	Cook	T-2B
119		FL11755	Ashland Ave / Wood St	Thronton Blue Island Rd	Cook	T-2B
120		FL11760	US 12/20 (95th St)	76th Ave SB to WB	Cook	T-2B
121		FL11765	US 12/20 (95th St)	88th Ave EB	Cook	T-2B
122		FL11770	Southwest Highway NEB	Ridgeland Ave	Cook	T-2B
123		FL11870	IL 72 (Higgins Rd)	Lee St Trammer Crow SB	Cook	T-2B
124		FL12015	IL 56 (Butterfield Rd)	Taft Ave EB	Cook	T-2B
125		FL12025	Lawrence Ave	25th Ave / Ruby Ave EB	Cook	T-2B
126		FL20405	IL 21 (Milwaukee Ave)	US 45 (Des Plaines River Rd)	Cook	T-2B
127		FL21473	IL 171 (Archer Ave)	131st St / Ashbury Dr EB	Cook	T-2B
128		FL21474	IL 171 (Archer Ave)	131st St / Ashbury Dr WB	Cook	T-2B
129		FL21475	IL 171 (Archer Ave)	Bell Rd WB	Cook	T-2B
130		FL21476	IL 171 (Archer Ave)	131st St NB Left Side	Cook	T-2B
131		FL21477	IL 171 (Archer Ave)	131st St NB Right Side	Cook	T-2B
132		FL21478	IL 171 (Archer Ave)	131st St SB Left Side	Cook	T-2B
133		FL21479	IL 171 (Archer Ave)	131st St SB Right Side	Cook	T-2B
134		FL33576	IL 171 (Archer Ave)	47th St E Ramp NB	Cook	T-2B
135		FL587	IL 83 (Kingery Highway)	91st St EB	DuPage	T-2B
136		FL635	IL 59 (Neltner Blvd)	Joliet St	DuPage	T-2B
137		FL640	IL 59 (Neltner Blvd)	Ingalton Ave	DuPage	T-2B
138		FL1002	IL 38 (Roosevelt Rd) WB	Garys Mill Rd	DuPage	T-2B

Count	Grd Date	Loc #	Main Route	Nearest Cross Street	County	RM Pay Item
139		FL1116	IL 38 (Roosevelt Rd) EB	Garys Mill Rd	DuPage	T-2B
140		FL1117	IL 38 (Roosevelt Rd)	Garys Mill Rd NB	DuPage	T-2B
141		FL1118	IL 38 (Roosevelt Rd)	Garys Mill Rd SB	DuPage	T-2B
142		FL1165	IL 83 SB	Red Oak St	DuPage	T-2B
143		FL1166	IL 83 NB	Red Oak St	DuPage	T-2B
144		FL1308	US 20 WB	Garden Rd	DuPage	T-2B
145		FL1309	US 20 EB	Garden Rd	DuPage	T-2B
146		FL1310	IL 19 (Irving Pk) WB	Bloomington Rd	DuPage	T-2B
147		FL8853	IL 59 (Neltner Blvd)	Hawthorn Ln SB	DuPage	T-2B
148		FL15100	IL 19 (Irving Park Rd) WB	Wood Dale Rd	DuPage	T-2B
149		FL15101	IL 19 (Irving Park Rd) EB	Wood Dale Rd	DuPage	T-2B
150		FL140	US 20 (Oak St)	Damisch Rd / Store St {Pingree Grove}	Kane	T-2B
151		FL150	US 20 (Oak St)	W of Marshall Rd	Kane	T-2B
152		FL151	US 20 (Oak St)	Marshall Rd	Kane	T-2B
153		FL160	US 20 (Oak St)	1/2 Mi W of Marshall Rd {Pingree Grove}	Kane	T-2B
154		FL191	IL 47	IL 64 (North Ave) EB	Kane	T-2B
155		FL201	IL 47 SB	Burlington Blacktop	Kane	T-2B
156		FL203	IL 47 NB	Burlington Blacktop	Kane	T-2B
157		FL211	IL 47 NB	Main St {Kaneville}	Kane	T-2B
158		FL212	IL 47 SB	Main St {Kaneville}	Kane	T-2B
159		FL222	IL 47 NB	Plato Rd Right Side	Kane	T-2B
160		FL223	IL 47 NB	Plato Rd Left Side	Kane	T-2B
161		FL224	IL 47 SB	Plato Rd Left Side	Kane	T-2B
162		FL225	IL 47 SB	Plato Rd Right Side	Kane	T-2B
163		FL754	IL 25 (JFK Memorial Dr) NB	Cherokee Rd / Bolz Rd	Kane	T-2B
164		FL762	IL 72 EB	Randall Rd	Kane	T-2B
165		FL763	IL 72 WB	Randall Rd	Kane	T-2B
166		FL857	IL 38 EB	St. Charles Youth Corrections Facility	Kane	T-2B
167		FL858	IL 38 EB	Meredith	Kane	T-2B
168		FL859	IL 38 WB	Meredith	Kane	T-2B
169		FL10698	IL 72 (Higgins Rd)	Big Timber Rd EB	Kane	T-2B
170		FL10699	IL 72 (Higgins Rd)	Big Timber Rd WB	Kane	T-2B
171		FL660	US 12/IL 59	IL 134 (Long Lake Rd)	Lake	T-2B
172		FL661	US 12/IL 59	IL 134 (Long Lake Rd)	Lake	T-2B
173		FL701	IL 53 (Long Grove Rd)	Robert Parker Coffin Rd	Lake	T-2B
174		FL715	IL 59 (Grand Ave)	Monaville Rd	Lake	T-2B
175		FL716	IL 59 (Grand Ave)	Monaville Rd SB	Lake	T-2B
176		FL727	IL 60 (Town Line Rd)	Lake Forest Academy Rd	Lake	T-2B
177		FL740	IL 120 (Belvidere Rd)	Almond LakeS	Lake	T-2B
178		FL741	IL 120 (Belvidere Rd) WB	Almond Rd	Lake	T-2B
179		FL748	IL 120 (Belvidere Rd) WB South	Bacon Rd	Lake	T-2B
180		FL749	IL 120 (Belvidere Rd) WB	Bacon Rd	Lake	T-2B
181		FL766	US 14 (Northwest Highway) SEB	Cuba Rd	Lake	T-2B
182		FL767	US 14 (Northwest Highway) NWB	Cuba Rd	Lake	T-2B
183		FL768	US 14 (Northwest Highway)	Cuba Rd EB	Lake	T-2B
184		FL769	US 14 (Northwest Highway)	Cuba Rd WB	Lake	T-2B
185		FL781	IL 173 (Rosecrans Rd) EB	Kilbourne Rd	Lake	T-2B

Count	Grd Date	Loc #	Main Route	Nearest Cross Street	County	RM Pay Item
186		FL782	IL 173 (Rosecrans Rd) WB	Kilbourne Rd	Lake	T-2B
187		FL783	IL 173 (Rosecrans Rd)	Kilbourne Rd NB	Lake	T-2B
188		FL784	IL 173 (Rosecrans Rd)	Kilbourne Rd SB	Lake	T-2B
189		FL967	US 12 (Rand Rd)	Old Rand Rd SB	Lake	T-2B
190		FL998	US 12 NB	Sullivan Lake Rd / Molidor Rd	Lake	T-2B
191		FL999	US 12 SB	Sullivan Lake Rd / Molidor Rd	Lake	T-2B
192		FL1150	US 14 (Northwest Highway)	Berry Rd	Lake	T-2B
193		FL1193	US 12 (Rand Rd) Off Ramp	IL 59 (Barrington Rd)	Lake	T-2B
194		FL1211	US 41 (Skokie Highway)	Between Deerfield Rd & West Park Ave	Lake	T-2B
195		FL1212	US 41 (Skokie Highway)	West Park Ave NB	Lake	T-2B
196		FL2113	IL 60	Wilson Rd SB	Lake	T-2B
197		FL2116	IL 173 EB	Tiffany Rd	Lake	T-2B
198		FL2117	IL 173 WB	Tiffany Rd	Lake	T-2B
199		FL2118	IL 173	Tiffany Rd SB	Lake	T-2B
200		FL6625	IL 176 (Maple Ave) WB	US 45 (Lake St)	Lake	T-2B
201		FL6627	US 45	Casey Rd WB	Lake	T-2B
202		FL6628	US 45	Casey Rd EB	Lake	T-2B
203		FL6629	US 45 NB	Casey Rd	Lake	T-2B
204		FL6630	US 45 SB	Caset Rd	Lake	T-2B
205		FL6916	IL 176 (Ivanhoe Rd) EB	Hawley Rd	Lake	T-2B
206		FL6917	IL 176 (Ivanhoe Rd) WB	Hawley Rd	Lake	T-2B
207		FL11945	US 12	State Park Rd / East St	Lake	T-2B
208		FL12315	IL 83 (Baron Blvd) SB	Washington St	Lake	T-2B
209		FL21755	US 45	Grass Lake Rd SB	Lake	T-2B
210		FL752	IL 23 (State Rd) NB	River Rd	McHenry	T-2B
211		FL753	IL 23 (State Rd) SB	River Rd	McHenry	T-2B
212		FL760	IL 23 (State Rd)	River Rd EB	McHenry	T-2B
213		FL761	IL 23 (State Rd)	River Rd WB	McHenry	T-2B
214		FL764	US 12 NB	Sunset	McHenry	T-2B
215		FL836	IL 47 SB	O'Brien Rd / Vander Karr Rd	McHenry	T-2B
216		FL837	IL 47 NB	O'Brien Rd / Vander Karr Rd	McHenry	T-2B
217		FL852	IL 173 EB	Alden Rd	McHenry	T-2B
218		FL853	IL 173 WB	Alden Rd	McHenry	T-2B
219		FL7233	US 14 EB	Ridgefield Rd	McHenry	T-2B
220		FL7234	US 14WB	Ridgefield Rd	McHenry	T-2B
221		FL11880	IL 176 (Crystal Lake Rd)	Roberts Rd	McHenry	T-2B
222		FL11881	IL 176 (Crystal Lake Rd) WB	Briarwood	McHenry	T-2B
223		FL11882	IL 176 (Crystal Lake Rd)	Briarwood SB	McHenry	T-2B
224		FL11883	IL 176 (Crystal Lake Rd)	Briarwood NB	McHenry	T-2B
225		FL11948	US 12	Solon Rd NB	McHenry	T-2B
226		FL11949	US 12	Solon Rd SB	McHenry	T-2B
227		FL21968	US 20 NB	Beck Rd	McHenry	T-2B
228		FL21969	US 20 SB	Beck Rd	McHenry	T-2B
229		FL21970	US 20 NB	South Union Rd	McHenry	T-2B
230		FL21971	US 20	Beck Rd WB	McHenry	T-2B
231		FL21972	US 20	Beck Rd EB	McHenry	T-2B
232		FL21973	US 20 NB	Coral Rd	McHenry	T-2B

Count	Grd Date	Loc #	Main Route	Nearest Cross Street	County	RM Pay Item
233		FL21974	US 20 SB	Coral Rd	McHenry	T-2B
234		FL21976	IL 23 (State St) NB	Coral Rd / Pleasant Grove Rd	McHenry	T-2B
235		FL21977	IL 23 (State St) SB	Coral Rd / Pleasant Grove Rd	McHenry	T-2B
236		FL19	US 6 (Southwest Highway)	Parker Rd EB	Will	T-2B
237		FL23	US 6 (Southwest Highway)	Parker Rd WB	Will	T-2B
238		FL145	US 45 (LaGrange Rd) NB	Steger Rd	Will	T-2B
239		FL146	US 45 (LaGrange Rd) SB	Steger Rd	Will	T-2B
240		FL231	US 6 EB	Bell Rd	Will	T-2B
241		FL232	US 6 WB	Bell Rd	Will	T-2B
242		FL865	I-80	Wheeler Ave WB	Will	T-2B
243		FL866	I-80	Wheeler Ave EB	Will	T-2B
244		FL900	US 52 (State St)	North St WB	Will	T-2B
245		FL901	US 52 (State St) SB	North St	Will	T-2B
246		FL902	US 52 (State St) NB	North St	Will	T-2B
247		FL905	US 52 (Manhattan Rd)	Laraway Rd	Will	T-2B
248		FL906	US 52 (Manhattan Rd)	Laraway Rd SB	Will	T-2B
249		FL907	US 52 (Manhattan Rd)	Laraway Rd EB	Will	T-2B
250		FL908	US 52 (Manhattan Rd)	Laraway Rd WB	Will	T-2B
251		FL920	IL 394	Goodenow Rd SB Right Side	Will	T-2B
252		FL921	IL 394	Goodenow Rd NB Left Side	Will	T-2B
253		FL922	IL 394	Goodenow Rd SB Right Side	Will	T-2B
254		FL923	IL 394	Goodenow Rd SB Left Side	Will	T-2B
255		FL927	IL 53 (Bolingbrook Dr)	Royce Rd	Will	T-2B
256		FL1088	IL 129	Strip Mine Rd NB	Will	T-2B
257		FL1089	IL 129	Strip Mine Rd SB	Will	T-2B
258		FL1091	IL 394 SB Left Side	Richton Rd	Will	T-2B
259		FL1092	IL 394 SB Right Side	Richton Rd	Will	T-2B
260		FL1093	IL 394 NB Left Side	Richton Rd	Will	T-2B
261		FL1094	IL 394 NB Right Side	Richton Rd	Will	T-2B
262		FL1096	IL 394 NB Left Side	Burville Rd	Will	T-2B
263		FL1097	IL 394 NB Right Side	Burville Rd	Will	T-2B
264		FL1098	IL 394 SB Left Side	Burville Rd	Will	T-2B
265		FL1099	IL 394 SB Right Side	Burville Rd	Will	T-2B
266		FL1125	I-80	IL 53 (Water St) EB Right Side	Will	T-2B
267		FL1126	I-80	IL 53 (Water St) EB Left Side	Will	T-2B
268		FL1127	I-80	IL 53 (Water St) WB Right Side	Will	T-2B
269		FL1128	I-80	IL 53 (Water St) WB Left Side	Will	T-2B
270		FL1131	IL 53 NB	Manhattan Rd	Will	T-2B
271		FL1132	IL 53 NB	Manhattan Rd	Will	T-2B
272		FL1133	IL 53 SB	Manhattan Rd	Will	T-2B
273		FL1134	IL 53 SB	Manhattan Rd	Will	T-2B
274		FL9126	135th St (Romeo Rd) WB	E of New Ave	Will	T-2B
275		FL11952	US 52 / IL 53 (Chicago St)	Patterson Rd NB	Will	T-2B
276		FL11953	US 52 / IL 53 (Chicago St)	Patterson Rd SB	Will	T-2B
277		FL20600	US 6 (Channahon Rd)	Brandon Rd WB	Will	T-2B

Ct	Loc #	Main Route / Address	Nearest Cross Street / City	Co	Type of Equipment	RM Pay Item
1	XBS1-H	Hillside Base Station (Old)	Hillside	Cook	Base Station	X-1
2	XBS3-F	Edens Base Station	Foster Ave	Cook	Base Station	X-1
3	XBS4-R	District 1 Backup ComCenter	Rodenburg Rd	Cook	Base Station	X-1
4	XF0430	I-57	I-90/94	Cook	Fiber Optic Node	X-1
5	XF0480	I-57	I-80	Cook	Fiber Optic Node	X-1
6	XF0830	REVLAC Building A	I-90/94 @ Ohio St Feeder Ramp	Cook	Fiber Optic Node	X-1
7	XF0880	REVLAC Building E	I-90/94 & I-94	Cook	Fiber Optic Node	X-1
8	XF0923	I-90/94	67 th & State St	Cook	Fiber Optic Node	X-1
9	XF0950	I-90/94	I-55	Cook	Fiber Optic Node	X-1
10	XF1330	I-290	I-90/94 & Halsted St	Cook	Fiber Optic Node	X-1
11	XF1380	I-290	I-88 Tollway	Cook	Fiber Optic Node	X-1
12	XF1750	Hillside Tower Building (New)	Hillside	Cook	Fiber Optic Node	X-1
13	XF1770	Schaumburg Tower	Roselle Rd & Central Rd	Cook	Fiber Optic Node	X-1
14	XG0001	Electrical Field Office	Schaumburg	Cook	Monitoring	X-1
15	XG0002	IDOT Headquarters	Schaumburg	Cook	Monitoring	X-1
16	XG0003	IDOT TSC	Oak Park	Cook	Monitoring	X-1
17	XH290-A	I-290 IB	Ashland Ave	Cook	HAR	X-1
18	XH290-E	I-290 OB	Westchester Blvd	Cook	HAR	X-1
19	XH290-T	I-290 IB	Thorndale Ave	Cook	HAR	X-1
20	XH290-W	I-290OB	Wells St	Cook	HAR	X-1
21	XH55-TW	I-55 IB	I-294	Cook	HAR	X-1
22	XH90-N	I-90 IB	Nagle Ave	Cook	HAR	X-1
23	XH90-TW	I-190 IB	I-294	Cook	HAR	X-1
24	XH94-P	I-94 IB	Pratt Ave	Cook	HAR	X-1
25	XH94-T	I-94 IB	Tower Rd	Cook	HAR	X-1
26	XIB290IB	I-290 IB	Chicago River	Cook	Ice Beacon	X-1
27	XIB290OB	I-290 OB	Chicago River	Cook	Ice Beacon	X-1
28	XIB9094IB	I-90/94 IB	Ohio St	Cook	Ice Beacon	X-1
29	XIB9094OB	I-90/94 OB	Ohio St	Cook	Ice Beacon	X-1
30	XM6105	11801 S Ridgeland Ave	Worth	Cook	Alsip Yard	X-1
31	XM6110	410 E Lincoln Ave	Arlington Heights	Cook	Arlington Heights Yard	X-1
32	XM6115	16915 Van Dam Rd	South Holland	Cook	Bishop Ford Yard	X-1
33	XM6120	6543 S Wentworth Ave	Chicago	Cook	Dan Ryan Yard	X-1
34	XM6125	2 Happ Rd	Northfield	Cook	Edens Yard	X-1
35	XM6130	5201 W Flournoy St	Chicago	Cook	Eisenhower Yard	X-1
36	XM6135	1480 Rodenburg Rd	Roselle	Cook	Rodenburg Yard	X-1
37	XM6140	3501 S Normal Ave	Chicago	Cook	ETP	X-1
38	XM6145	16738 S Lathrop Ave	Harvey	Cook	Harvey Yard	X-1
39	XM6150	East Ave & May St	Hillside	Cook	Hillside Yard	X-1
40	XM6155	1101 Biesterfield Rd	Elk Grove	Cook	District Bridge Office	X-1
41	XM6160	16010 S Crawford Ave	Markham	Cook	I-57 Yard	X-1
42	XM6165	15940 Pulaski Rd	Markham	Cook	Southside Sign Shop	X-1
43	XM6170	5027 N Central Ave	Chicago	Cook	Kennedy Yard	X-1
44	XM6175	1260 W Augusta Blvd	Chicago	Cook	Landscape Yard	X-1
45	XM6180	1916 Techny Rd	Northbrook	Cook	Northbrook Yard	X-1
46	XM6185	7151 Forest Preserve Dr	Chicago	Cook	Northside Sign Shop	X-1

Ct	Loc #	Main Route / Address	Nearest Cross Street / City	Co	Type of Equipment	RM Pay Item
47	XM6190	4051 N Harlem	Chicago	Cook	Northside Yard	X-1
48	XM6195	Joliet Rd & 1st Ave	McCook	Cook	Stevenson Yard	X-1
49	XVAC1	Viaduct Access Control	Governors Highway & 214th St	Cook	Matteson	X-1
50	XVAC2	Viaduct Access Control	Governors Highway & 219th St	Cook	Matteson	X-1
51	XWS30	US 30 & E of Torrence Ave	Chicago Heights	Cook	Weigh Station	X-1
52	XF1450	I-290	I-355 (Tollway)	DuPage	Fiber Optic Node	X-1
53	XM6210	28 W 731 Ogden Ave	Naperville	DuPage	Naperville Yard	X-1
54	XM6215	17 W 125 Butterfield Rd	Villa Park	DuPage	Oak Brook Yard	X-1
55	XWS83	IL 83 & St. Charles Rd	Elmhurst	DuPage	Weigh Station	X-1
56	XBS2-P	Plato Base Station	Plato	Kane	Base Station	X-1
57	XM6310	595 S State St	Elgin	Kane	Elgin Sign Shop	X-1
58	XM6315	777 S State St	Elgin	Kane	IL State Police Dist 2	X-1
59	XM6320	38 W 027 IL 38	St. Charles	Kane	St. Charles Yard	X-1
60	XM6325	525 Shales Parkway	Elgin	Kane	Shales Parkway Storage	X-1
61	XM6410	219 N Baron Blvd	Grayslake	Lake	Grayslake Yard	X-1
62	XM6415	3516 W Washington St	Gurnee	Lake	Gurnee Yard	X-1
63	XM6420	700 S Ela Rd	Lake Zurich	Lake	Lake Zurich Yard	X-1
64	XWS41IB	US 41 & Rosecrans Rd	Rosecrans	Lake	Weigh Station	X-1
65	XWS41OB	US 41 & Wadsworth Rd	Wadsworth	Lake	Weigh Station	X-1
66	XM6505	11916 Catalpa Lane	Woodstock	McHenry	Woodstock Yard	X-1
67	XWS12	US 12 & Burlington Rd	Richmond	McHenry	Weigh Station	X-1
68	XWS14	US 14 & Crowley Rd	Harvard	McHenry	Weigh Station	X-1
69	XBBRAN	Des Plaines River	Brandon St	Will	Monitoring	X-1
70	XBCASS	Des Plaines River	Cass St	Will	Monitoring	X-1
71	XBJACK	Des Plaines River	Jackson St	Will	Monitoring	X-1
72	XBJEFF	Des Plaines River	Jefferson St	Will	Monitoring	X-1
73	XBMCDN	Des Plaines River	McDonough St	Will	Monitoring	X-1
74	XBRUBY	Des Plaines River	Ruby St	Will	Monitoring	X-1
75	XM6605	I-55 & US 6	Minooka	Will	Birds Bridge Yard	X-1
76	XM6610	RR5	Bolingbrook	Will	I-55 Yard	X-1
77	XM6615	IL 53 & Caton Farm Rd	Lockport	Will	Joliet Yard	X-1
78	XM6620	IL 50 & US 6	Monee	Will	Monee Storage Facility	X-1
79	XM6625	1400 W Maple St	New Lenox	Will	New Lenox Yard	X-1
80	XM6630	I-80 & US 30	New Lenox	Will	New Lenox Sign Shop	X-1
81	XRI57IB	I-57	Peotone	Will	Rest Area IB	X-1
82	XRI57OB	I-57	Peotone	Will	Rest Area OB	X-1
83	XWS55IB	I-55 & W of IL 53	Bolingbrook	Will	Weigh Station IB	X-1
84	XWS55OB	I-55 & W of IL 53	Bolingbrook	Will	Weigh Station OB	X-1
85	XWS57IB	I-57 & N of US 52	Peotone	Will	Weigh Station IB	X-1
86	XWS57OB	I-57 & N of US 52	Peotone	Will	Weigh Station IB	X-1
87	XWS80IB	I-80 & E of Townline Rd	Frankfort	Will	Weigh Station IB	X-1
88	XWS80OB	I-80 & E of Townline Rd	Frankfort	Will	Weigh Station OB	X-1
89	XG0004	EMC Dispatch Center	TBD	TBD	Monitoring	X-1

**BDE SPECIAL PROVISIONS
TABLE OF CONTENTS**

DISADVANTAGED BUSINESS ENTERPRISE PARTICIPATION (BDE)582
EQUIPMENT RENTAL RATES (BDE).....589
PAYMENTS TO SUBCONTRACTORS (BDE)590
REFLECTIVE SHEETING ON CHANNELIZING DEVICES (BDE)591
SUBCONTRACTOR MOBILIZATION PAYMENTS (BDE)592
STEEL COST ADJUSTMENT (BDE) (RETURN FORM WITH BID)592

DISADVANTAGED BUSINESS ENTERPRISE PARTICIPATION (DBE)

Effective: September 1, 2000

Revised: January 1, 2007

FEDERAL OBLIGATION. The Department of Transportation, as a recipient of federal financial assistance, is required to take all necessary and reasonable steps to ensure nondiscrimination in the award and administration of contracts. Consequently, the federal regulatory provisions of 49 CFR part 26 apply to this contract concerning the utilization of disadvantaged business enterprises. For the purposes of this Special Provision, a disadvantaged business enterprise (DBE) means a business certified by the Department in accordance with the requirements of 49 CFR part 26 and listed in the DBE Directory or most recent addendum.

STATE OBLIGATION. This Special Provision will also be used by the Department to satisfy the requirements of the Business Enterprise for Minorities, Females, and Persons with Disabilities Act, 30 ILCS 575. When this Special Provision is used to satisfy state law requirements on 100 percent state-funded contracts, the federal government has no involvement in such contracts (not a federal-aid contract) and no responsibility to oversee the implementation of this Special Provision by the Department on those contracts. DBE participation on 100 percent state-funded contracts will not be credited toward fulfilling the Department's annual overall DBE goal required by the US Department of Transportation to comply with the federal DBE program requirements.

CONTRACTOR ASSURANCE. The Contractor makes the following assurance and agrees to include the assurance in each subcontract that the Contractor signs with a subcontractor:

The Contractor, subrecipient, or subcontractor shall not discriminate on the basis of race, color, national origin, or sex in the performance of this contract. The Contractor shall carry out applicable requirements of 49 CFR part 26 in the award and administration of contracts funded in whole or in part with federal or state funds. Failure by the Contractor to carry out these requirements is a material breach of this contract, which may result in the termination of this contract or such other remedy as the recipient deems appropriate.

OVERALL GOAL SET FOR THE DEPARTMENT. As a requirement of compliance with 49 CFR part 26, the Department has set an overall goal for DBE participation in its federally assisted contracts. That goal applies to all federal-aid funds the Department will expend in its federally assisted contracts for the subject reporting fiscal year. The Department is required to make a good faith effort to achieve the overall goal. The dollar amount paid to all approved DBE firms performing work called for in this contract is eligible to be credited toward fulfillment of the Department's overall goal.

CONTRACT GOAL TO BE ACHIEVED BY THE CONTRACTOR. This contract includes a specific DBE utilization goal established by the Department. The goal has been included because the Department has determined that the work of this contract has subcontracting opportunities that may be suitable for performance by DBE companies. This determination is based on an assessment of the type of work, the location of the work, and the availability of DBE companies to do a part of the work. The assessment indicates that, in the absence of unlawful discrimination, and in an arena of fair and open competition, DBE companies can be expected to perform **10.0%** of the work. This percentage is set as the DBE participation goal for this contract. Consequently, in addition to the other award criteria established for this contract,

the Department will award this contract to a bidder who makes a good faith effort to meet this goal of DBE participation in the performance of the work. A bidder makes a good faith effort for award consideration if either of the following is done in accordance with the procedures set forth in this Special Provision:

- (a) The bidder documents that firmly committed DBE participation has been obtained to meet the goal; or
- (b) The bidder documents that a good faith effort has been made to meet the goal, even though the effort did not succeed in obtaining enough DBE participation to meet the goal.

DBE LOCATOR REFERENCES. Bidders may consult the DBE Directory as a reference source for DBE companies certified by the Department. In addition, the Department maintains a letting and item specific DBE locator information system whereby DBE companies can register their interest in providing quotes on particular bid items advertised for letting. Information concerning DBE companies willing to quote work for particular contracts may be obtained by contacting the Department's Bureau of Small Business Enterprises at telephone number (217)785-4611, or by visiting the Department's web site at www.dot.il.gov.

BIDDING PROCEDURES. Compliance with the bidding procedures of this Special Provision is required prior to the award of the contract and the failure of the as-read low bidder to comply will render the bid not responsive.

- (a) In order to assure the timely award of the contract, the as-read low bidder shall submit a Disadvantaged Business Utilization Plan on Department form SBE 2026 within seven working days after the date of letting. To meet the seven day requirement, the bidder may send the Plan by certified mail or delivery service within the seven working day period. If a question arises concerning the mailing date of a Plan, the mailing date will be established by the U.S. Postal Service postmark on the original certified mail receipt from the U.S. Postal Service or the receipt issued by a delivery service. It is the responsibility of the bidder to ensure that the postmark or receipt date is affixed within the seven working days if the bidder intends to rely upon mailing or delivery to satisfy the submission day requirement. The Plan is to be submitted to the Department of Transportation, Bureau of Small Business Enterprises, Contract Compliance Section, 2300 South Dirksen Parkway, Room 319, Springfield, Illinois 62764 (Telefax: (217)785-1524). It is the responsibility of the bidder to obtain confirmation of telefax delivery. The Department will not accept a Utilization Plan if it does not meet the seven day submittal requirement and the bid will be declared not responsive. In the event the bid is declared not responsive due to a failure to submit a Plan or failure to comply with the bidding procedures set forth herein, the Department may elect to cause the forfeiture of the penal sum of the bidder's proposal guaranty, and may deny authorization to bid the project if re-advertised for bids. The Department reserves the right to invite any other bidder to submit a Utilization Plan at any time for award consideration or to extend the time for award.
- (b) The Utilization Plan shall indicate that the bidder either has obtained sufficient DBE participation commitments to meet the contract goal or has not obtained enough DBE participation commitments in spite of a good faith effort to meet the goal. The Utilization

Plan shall further provide the name, telephone number, and telefax number of a responsible official of the bidder designated for purposes of notification of plan approval or disapproval under the procedures of this Special Provision.

- (c) The Utilization Plan shall include a DBE Participation Commitment Statement, Department form SBE 2025, for each DBE proposed for the performance of work to achieve the contract goal. The signatures on these forms must be original signatures. All elements of information indicated on the said form shall be provided, including but not limited to the following:
- (1) The name and address of each DBE to be used;
 - (2) A description, including pay item numbers, of the commercially useful work to be done by each DBE;
 - (3) The price to be paid to each DBE for the identified work specifically stating the quantity, unit price, and total subcontract price for the work to be completed by the DBE. If partial pay items are to be performed by the DBE, indicate the portion of each item, a unit price where appropriate and the subcontract price amount;
 - (4) A commitment statement signed by the bidder and each DBE evidencing availability and intent to perform commercially useful work on the project; and
 - (5) If the bidder is a joint venture comprised of DBE firms and non-DBE firms, the plan must also include a clear identification of the portion of the work to be performed by the DBE partner(s).
- (d) The contract will not be awarded until the Utilization Plan submitted by the bidder is approved. The Utilization Plan will be approved by the Department if the Plan commits sufficient commercially useful DBE work performance to meet the contract goal. The Utilization Plan will not be approved by the Department if the Plan does not commit sufficient DBE performance to meet the contract goal unless the bidder documents that it made a good faith effort to meet the goal. The good faith procedures of Section VIII of this special provision apply. If the Utilization Plan is not approved because it is deficient in a technical matter, unless waived by the Department, the bidder will be notified and will be allowed no less than a five working day period in order to cure the deficiency.

CALCULATING DBE PARTICIPATION. The Utilization Plan values represent work anticipated to be performed and paid for upon satisfactory completion. The Department is only able to count toward the achievement of the overall goal and the contract goal the value of payments made for the work actually performed by DBE companies. In addition, a DBE must perform a commercially useful function on the contract to be counted. A commercially useful function is generally performed when the DBE is responsible for the work and is carrying out its responsibilities by actually performing, managing, and supervising the work involved. The Department and Contractor are governed by the provisions of 49 CFR part 26.55(c) on questions of commercially useful functions as it affects the work. Specific counting guidelines are provided in 49 CFR part 26.55, the provisions of which govern over the summary contained herein.

- (a) DBE as the Contractor: 100 percent goal credit for that portion of the work performed by the DBE's own forces, including the cost of materials and supplies. Work that a DBE subcontracts to a non-DBE firm does not count toward the DBE goals.
- (b) DBE as a joint venture Contractor: 100 percent goal credit for that portion of the total dollar value of the contract equal to the distinct, clearly defined portion of the work performed by the DBE's own forces.
- (c) DBE as a subcontractor: 100 percent goal credit for the work of the subcontract performed by the DBE's own forces, including the cost of materials and supplies, excluding the purchase of materials and supplies or the lease of equipment by the DBE subcontractor from the prime Contractor or its affiliates. Work that a DBE subcontractor in turn subcontracts to a non-DBE firm does not count toward the DBE goal.
- (d) DBE as a trucker: 100 percent goal credit for trucking participation provided the DBE is responsible for the management and supervision of the entire trucking operation for which it is responsible. At least one truck owned, operated, licensed, and insured by the DBE must be used on the contract. Credit will be given for the full value of all such DBE trucks operated using DBE employed drivers. Goal credit will be limited to the value of the reasonable fee or commission received by the DBE if trucks are leased from a non-DBE company.
- (e) DBE as a material supplier:
 - (1) 60 percent goal credit for the cost of the materials or supplies purchased from a DBE regular dealer.
 - (2) 100 percent goal credit for the cost of materials or supplies obtained from a DBE manufacturer.
 - (3) 100 percent credit for the value of reasonable fees and commissions for the procurement of materials and supplies if not a regular dealer or manufacturer.

GOOD FAITH EFFORT PROCEDURES. If the bidder cannot obtain sufficient DBE commitments to meet the contract goal, the bidder must document in the Utilization Plan the good faith efforts made in the attempt to meet the goal. This means that the bidder must show that all necessary and reasonable steps were taken to achieve the contract goal. Necessary and reasonable steps are those which could reasonably be expected to obtain sufficient DBE participation. The Department will consider the quality, quantity, and intensity of the kinds of efforts that the bidder has made. Mere *pro forma* efforts are not good faith efforts; rather, the bidder is expected to have taken those efforts that would be reasonably expected of a bidder actively and aggressively trying to obtain DBE participation sufficient to meet the contract goal.

- (a) The following is a list of types of action that the Department will consider as part of the evaluation of the bidder's good faith efforts to obtain participation. These listed factors are not intended to be a mandatory checklist and are not intended to be exhaustive. Other factors or efforts brought to the attention of the Department may be relevant in appropriate cases, and will be considered by the Department.

- (1) Soliciting through all reasonable and available means (e.g. attendance at pre-bid meetings, advertising and/or written notices) the interest of all certified DBE companies that have the capability to perform the work of the contract. The bidder must solicit this interest within sufficient time to allow the DBE companies to respond to the solicitation. The bidder must determine with certainty if the DBE companies are interested by taking appropriate steps to follow up initial solicitations.
- (2) Selecting portions of the work to be performed by DBE companies in order to increase the likelihood that the DBE goals will be achieved. This includes, where appropriate, breaking out contract work items into economically feasible units to facilitate DBE participation, even when the prime Contractor might otherwise prefer to perform these work items with its own forces.
- (3) Providing interested DBE companies with adequate information about the plans, specifications, and requirements of the contract in a timely manner to assist them in responding to a solicitation.
- (4)
 - a. Negotiating in good faith with interested DBE companies. It is the bidder's responsibility to make a portion of the work available to DBE subcontractors and suppliers and to select those portions of the work or material needs consistent with the available DBE subcontractors and suppliers, so as to facilitate DBE participation. Evidence of such negotiation includes the names, addresses, and telephone numbers of DBE companies that were considered; a description of the information provided regarding the plans and specifications for the work selected for subcontracting; and evidence as to why additional agreements could not be reached for DBE companies to perform the work.
 - b. A bidder using good business judgment would consider a number of factors in negotiating with subcontractors, including DBE subcontractors, and would take a firm's price and capabilities as well as contract goals into consideration. However, the fact that there may be some additional costs involved in finding and using DBE companies is not in itself sufficient reason for a bidder's failure to meet the contract DBE goal, as long as such costs are reasonable. Also, the ability or desire of a bidder to perform the work of a contract with its own organization does not relieve the bidder of the responsibility to make good faith efforts. Bidders are not, however, required to accept higher quotes from DBE companies if the price difference is excessive or unreasonable.
- (5) Not rejecting DBE companies as being unqualified without sound reasons based on a thorough investigation of their capabilities. The bidder's standing within its industry, membership in specific groups, organizations, or associations and political or social affiliations (for example union vs. non-union employee status) are not legitimate causes for the rejection or non-solicitation of bids in the bidder's efforts to meet the project goal.
- (6) Making efforts to assist interested DBE companies in obtaining bonding, lines of credit, or insurance as required by the recipient or Contractor.

- (7) Making efforts to assist interested DBE companies in obtaining necessary equipment, supplies, materials, or related assistance or services.
- (8) Effectively using the services of available minority/women community organizations; minority/women contractors' groups; local, state, and federal minority/women business assistance offices; and other organizations as allowed on a case-by-case basis to provide assistance in the recruitment and placement of DBE companies.
- (b) If the Department determines that the bidder has made a good faith effort to secure the work commitment of DBE companies to meet the contract goal, the Department will award the contract provided that it is otherwise eligible for award. If the Department determines that a good faith effort has not been made, the Department will notify the bidder of that preliminary determination by contacting the responsible company official designated in the Utilization Plan. The preliminary determination shall include a statement of reasons why good faith efforts have not been found, and may include additional good faith efforts that the bidder could take. The notification will designate a five working day period during which the bidder shall take additional efforts. The bidder is not limited by a statement of additional efforts, but may take other action beyond any stated additional efforts in order to obtain additional DBE commitments. The bidder shall submit an amended Utilization Plan if additional DBE commitments to meet the contract goal are secured. If additional DBE commitments sufficient to meet the contract goal are not secured, the bidder shall report the final good faith efforts made in the time allotted. All additional efforts taken by the bidder will be considered as part of the bidder's good faith efforts. If the bidder is not able to meet the goal after taking additional efforts, the Department will make a pre-final determination of the good faith efforts of the bidder and will notify the designated responsible company official of the reasons for an adverse determination.
- (c) The bidder may request administrative reconsideration of a pre-final determination adverse to the bidder within the five working days after the notification date of the determination by delivering the request to the Department of Transportation, Bureau of Small Business Enterprises, Contract Compliance Section, 2300 South Dirksen Parkway, Room 319, Springfield, Illinois 62764 (Telefax: (217)785-1524). Deposit of the request in the United States mail on or before the fifth business day shall not be deemed delivery. The pre-final determination shall become final if a request is not made and delivered. A request may provide additional written documentation and/or argument concerning the issue of whether an adequate good faith effort was made to meet the contract goal. In addition, the request shall be considered a consent by the bidder to extend the time for award. The request will be forwarded to the Department's Reconsideration Officer. The Reconsideration Officer will extend an opportunity to the bidder to meet in person in order to consider all issues of whether the bidder made a good faith effort to meet the goal. After the review by the Reconsideration Officer, the bidder will be sent a written decision within ten working days after receipt of the request for reconsideration, explaining the basis for finding that the bidder did or did not meet the goal or make adequate good faith efforts to do so. A final decision by the Reconsideration Officer that a good faith effort was made shall approve the Utilization Plan submitted by the bidder and shall clear the contract for award. A final decision that a good faith effort was not made shall render the bid not responsive.

CONTRACT COMPLIANCE. Compliance with this Special Provision is an essential part of the contract. The Department is prohibited by federal regulations from crediting the participation of a DBE included in the Utilization Plan toward either the contract goal or the Department's overall goal until the amount to be applied toward the goals has been paid to the DBE. The following administrative procedures and remedies govern the compliance by the Contractor with the contractual obligations established by the Utilization Plan. After approval of the Plan and award of the contract, the Utilization Plan and individual DBE Participation Statements become part of the contract. If the Contractor did not succeed in obtaining enough DBE participation to achieve the advertised contract goal, and the Utilization Plan was approved and contract awarded based upon a determination of good faith, the total dollar value of DBE work calculated in the approved Utilization Plan as a percentage of the awarded contract value shall become the amended contract goal.

- (a) No amendment to the Utilization Plan may be made without prior written approval from the Department's Bureau of Small Business Enterprises. All requests for amendment to the Utilization Plan shall be submitted to the Department of Transportation, Bureau of Small Business Enterprises, Contract Compliance Section, 2300 South Dirksen Parkway, Room 319, Springfield, Illinois 62764. Telephone number (217) 785-4611. Telefax number (217) 785-1524.
- (b) All work indicated for performance by an approved DBE shall be performed, managed, and supervised by the DBE executing the Participation Statement. The Contractor shall not terminate for convenience a DBE listed in the Utilization Plan and then perform the work of the terminated DBE with its own forces, those of an affiliate or those of another subcontractor, whether DBE or not, without first obtaining the written consent of the Bureau of Small Business Enterprises to amend the Utilization Plan. If a DBE listed in the Utilization Plan is terminated for reasons other than convenience, or fails to complete its work on the contract for any reason, the Contractor shall make good faith efforts to find another DBE to substitute for the terminated DBE. The good faith efforts shall be directed at finding another DBE to perform at least the same amount of work under the contract as the DBE that was terminated, but only to the extent needed to meet the contract goal or the amended contract goal. The Contractor shall notify the Bureau of Small Business Enterprises of any termination for reasons other than convenience, and shall obtain approval for inclusion of the substitute DBE in the Utilization Plan. If good faith efforts following a termination of a DBE for cause are not successful, the Contractor shall contact the Bureau and provide a full accounting of the efforts undertaken to obtain substitute DBE participation. The Bureau will evaluate the good faith efforts in light of all circumstances surrounding the performance status of the contract, and determine whether the contract goal should be amended.
- (c) The Contractor shall maintain a record of payments for work performed to the DBE participants. The records shall be made available to the Department for inspection upon request. After the performance of the final item of work or delivery of material by a DBE and final payment therefor to the DBE by the Contractor, but not later than thirty calendar days after payment has been made by the Department to the Contractor for such work or material, the Contractor shall submit a DBE Payment Report on Department form SBE 2115 to the Regional Engineer. If full and final payment has not been made to the DBE, the Report shall indicate whether a disagreement as to the payment required exists between the Contractor and the DBE or if the Contractor

believes that the work has not been satisfactorily completed. If the Contractor does not have the full amount of work indicated in the Utilization Plan performed by the DBE companies indicated in the Plan, the Department will deduct from contract payments to the Contractor the amount of the goal not achieved as liquidated and ascertained damages.

- (d) The Department reserves the right to withhold payment to the Contractor to enforce the provisions of this Special Provision. Final payment shall not be made on the contract until such time as the Contractor submits sufficient documentation demonstrating achievement of the goal in accordance with this Special Provision or after liquidated damages have been determined and collected.
- (e) Notwithstanding any other provision of the contract, including but not limited to Article 109.09 of the Standard Specifications, the Contractor may request administrative reconsideration of a decision to deduct the amount of the goal not achieved as liquidated damages. A request to reconsider shall be delivered to the Contract Compliance Section and shall be handled and considered in the same manner as set forth in paragraph (c) of "Good Faith Effort Procedures" of this Special Provision, except a final decision that a good faith effort was not made during contract performance to achieve the goal agreed to in the Utilization Plan shall be the final administrative decision of the Department.

EQUIPMENT RENTAL RATES (BDE)

Effective: August 2, 2007

Revised: January 2, 2008

Replace the second and third paragraphs of Article 105.07(b)(4)a. of the Standard Specifications with the following:

"Equipment idled which cannot be used on other work, and which is authorized to standby on the project site by the Engineer, will be paid for according to Article 109.04(b)(4)."

Replace Article 109.04(b)(4) of the Standard Specifications with the following:

- "(4) Equipment. Equipment used for extra work shall be authorized by the Engineer. The equipment shall be specifically described, be of suitable size and capacity for the work to be performed, and be in good operating condition. For such equipment, the Contractor will be paid as follows.
 - a. Contractor Owned Equipment. Contractor owned equipment will be paid for by the hour using the applicable FHWA hourly rate from the "Equipment Watch Rental Rate Blue Book" (Blue Book) in effect when the force account work begins. The FHWA hourly rate is calculated as follows.

FHWA hourly rate = (monthly rate/176) x (model year adj.) x (Illinois adj.) + EOC

Where: EOC = Estimated Operating Costs per hour (from the Blue Book)

The time allowed will be the actual time the equipment is operating on the extra work. For the time required to move the equipment to and from the site of the extra work and any authorized idle (standby) time, payment will be made at the following hourly rate: 0.5 x (FHWA hourly rate - EOC).

All time allowed shall fall within the working hours authorized for the extra work.

The rates above include the cost of fuel, oil, lubrication, supplies, small tools, necessary attachments, repairs, overhaul and maintenance of any kind, depreciation, storage, overhead, profits, insurance, and all incidentals. The rates do not include labor.

The Contractor shall submit to the Engineer sufficient information for each piece of equipment and its attachments to enable the Engineer to determine the proper equipment category. If a rate is not established in the Blue Book for a particular piece of equipment, the Engineer will establish a rate for that piece of equipment that is consistent with its cost and use in the industry.

- b. Rented Equipment. Whenever it is necessary for the Contractor to rent equipment to perform extra work, the rental and transportation costs of the equipment plus five percent for overhead will be paid. In no case shall the rental rates exceed those of established distributors or equipment rental agencies.

All prices shall be agreed to in writing before the equipment is used.”

PAYMENTS TO SUBCONTRACTORS (BDE)

Effective: June 1, 2000

Revised: January 1, 2006

Federal regulations found at 49 CFR §26.29 mandate the Department to establish a contract clause to require Contractors to pay subcontractors for satisfactory performance of their subcontracts and to set the time for such payments.

State law also addresses the timing of payments to be made to subcontractors and material suppliers. Section 7 of the Prompt Payment Act, 30 ILCS 540/7, requires that when a Contractor receives any payment from the Department, the Contractor shall make corresponding, proportional payments to each subcontractor and material supplier performing work or supplying material within 15 calendar days after receipt of the Department payment. Section 7 of the Act further provides that interest in the amount of two percent per month, in addition to the payment due, shall be paid to any subcontractor or material supplier by the Contractor if the payment required by the Act is withheld or delayed without reasonable cause. The Act also provides that the time for payment required and the calculation of any interest due applies to transactions between subcontractors and lower-tier subcontractors and material suppliers throughout the contracting chain.

This Special Provision establishes the required federal contract clause, and adopts the 15 calendar day requirement of the State Prompt Payment Act for purposes of compliance with the federal regulation regarding payments to subcontractors. This contract is subject to the following payment obligations.

When progress payments are made to the Contractor according to Article 109.07 of the Standard Specifications, the Contractor shall make a corresponding payment to each subcontractor and material supplier in proportion to the work satisfactorily completed by each subcontractor and for the material supplied to perform any work of the contract. The proportionate amount of partial payment due to each subcontractor and material supplier throughout the contracting chain shall be determined by the quantities measured or otherwise determined as eligible for payment by the Department and included in the progress payment to the Contractor. Subcontractors and material suppliers shall be paid by the Contractor within 15 calendar days after the receipt of payment from the Department. The Contractor shall not hold retainage from the subcontractors. These obligations shall also apply to any payments made by subcontractors and material suppliers to their subcontractors and material suppliers; and to all payments made to lower tier subcontractors and material suppliers throughout the contracting chain. Any payment or portion of a payment subject to this provision may only be withheld from the subcontractor or material supplier to whom it is due for reasonable cause.

This Special Provision does not create any rights in favor of any subcontractor or material supplier against the State or authorize any cause of action against the State on account of any payment, nonpayment, delayed payment, or interest claimed by application of the State Prompt Payment Act. The Department will not approve any delay or postponement of the 15 day requirement except for reasonable cause shown after notice and hearing pursuant to Section 7(b) of the State Prompt Payment Act. State law creates other and additional remedies available to any subcontractor or material supplier, regardless of tier, who has not been paid for work properly performed or material furnished. These remedies are a lien against public funds set forth in Section 23(c) of the Mechanics Lien Act, 770 ILCS 60/23(c), and a recovery on the Contractor's payment bond according to the Public Construction Bond Act, 30 ILCS 550.

REFLECTIVE SHEETING ON CHANNELIZING DEVICES (BDE)

Effective: April 1, 2007

Revise the seventh paragraph of Article 1106.02 of the Standard Specifications to read:

“At the time of manufacturing, the retroreflective prismatic sheeting used on channelizing devices shall meet or exceed the initial minimum coefficient of retroreflection as specified in the following table. Measurements shall be conducted according to ASTM E 810, without averaging. Sheeting used on cones, drums and flexible delineators shall be reboundable as tested according to ASTM D 4956. Prestriped sheeting for rigid substrates on barricades shall be white and orange.

Initial Minimum Coefficient of Retroreflection candelas/foot candle/sq ft (candelas/lux/sq m) of material				
Observation Angle (deg.)	Entrance Angle (deg.)	White	Orange	Fluorescent Orange
0.2	-4	365	160	150
0.2	+30	175	80	70
0.5	-4	245	100	95
0.5	+30	100	50	40"

Revise the first sentence of the first paragraph of Article 1106.02(c) of the Standard Specifications to read:

“Barricades and vertical panels shall have alternating white and orange stripes sloping downward at 45 degrees toward the side on which traffic will pass.”

Revise the third sentence of the first paragraph of Article 1106.02(d) of the Standard Specifications to read:

“The bottom panels shall be 8 x 24 in. (200 x 600 mm) with alternating white and orange stripes sloping downward at 45 degrees toward the side on which traffic will pass.”

SUBCONTRACTOR MOBILIZATION PAYMENTS (BDE)

Effective: April 2, 2005

To account for the preparatory work and operations necessary for the movement of subcontractor personnel, equipment, supplies, and incidentals to the project site and for all other work or operations that must be performed or costs incurred when beginning work approved for subcontracting in accordance with Article 108.01 of the Standard Specifications, the Contractor shall make a mobilization payment to each subcontractor.

This mobilization payment shall be made at least 14 days prior to the subcontractor starting work. The amount paid shall be equal to 3 percent of the amount of the subcontract reported on form BC 260A submitted for the approval of the subcontractor's work.

This provision shall be incorporated directly or by reference into each subcontract approved by the Department.

STEEL COST ADJUSTMENT (BDE) (RETURN FORM WITH BID)

Effective: April 2, 2004

Revised: April 1, 2007

Description. Steel cost adjustments will be made to provide additional compensation to the Contractor, or a credit to the Department, for fluctuations in steel prices when optioned by the Contractor. The bidder shall indicate on the attached form whether or not this special provision will be part of the contract and submit the completed form with his/her bid. Failure to submit the form, or failure to fill out the form completely, shall make this contract exempt of steel cost adjustments.

Types of Steel Products. An adjustment will be made for fluctuations in the cost of steel used in the manufacture of the following items:

- Metal Piling (excluding temporary sheet piling)
- Structural Steel
- Reinforcing Steel

Other steel materials such as dowel bars, tie bars, mesh reinforcement, guardrail, steel traffic signal and light poles, towers and mast arms, metal railings (excluding wire fence), frames and grates, and other miscellaneous items will be subject to a steel cost adjustment when the pay item they are used in has a contract value of \$10,000 or greater.

Documentation. Sufficient documentation shall be furnished to the Engineer to verify the following:

- (a) Evidence that increased or decreased steel costs have been passed on to the Contractor.
- (b) The dates and quantity of steel, in lb (kg), shipped from the mill to the fabricator.
- (c) The quantity of steel, in lb (kg), incorporated into the various items of work covered by this special provision. The Department reserves the right to verify submitted quantities.

Method of Adjustment. Steel cost adjustments will be computed as follows:

$$SCA = Q \times D$$

Where: SCA = steel cost adjustment, in dollars
Q = quantity of steel incorporated into the work, in lb (kg)
D = price factor, in dollars per lb (kg)

$$D = CBP_M - CBP_L$$

Where: CBP_M = The average of the Consumer Buying Price indices for Shredded Auto Scrap (Chicago) and No. 1 Heavy Melt (Chicago) as published by the American Metal Market (AMM) for the day the steel is shipped from the mill. The indices will be converted from dollars per ton to dollars per lb (kg).

CBP_L = The average of the Consumer Buying Price indices for Shredded Auto Scrap (Chicago) and No. 1 Heavy Melt (Chicago) as published by the AMM for the day the contract is let. The indices will be converted from dollars per ton to dollars per lb (kg).

The unit weights (masses) of steel that will be used to calculate the steel cost adjustment for the various items are shown in the attached table.

No steel cost adjustment will be made for any products manufactured from steel having a mill shipping date prior to the letting date.

If the Contractor fails to provide the required documentation, the method of adjustment will be calculated as described above; however, the CBP_M will be based on the date the steel arrives at the job site. In this case, an adjustment will only be made when there is a decrease in steel costs.

Basis of Payment. Steel cost adjustments may be positive or negative but will only be made when there is a difference between the CBP_L and CBP_M in excess of five percent, as calculated by:

$$\text{Percent Difference} = \{(CBP_L - CBP_M) \div CBP_L\} \times 100$$

Steel cost adjustments will be calculated by the Engineer and will be paid or deducted when all other contract requirements for the items of work are satisfied. Adjustments will only be made for fluctuations in the cost of the steel as described herein. No adjustment will be made for changes in the cost of manufacturing, fabrication, shipping, storage, etc.

The adjustments shall not apply during contract time subject to liquidated damages for completion of the entire contract.

Attachment

Item	Unit Mass (Weight)
Metal Piling (excluding temporary sheet piling)	
Furnishing Metal Pile Shells 12 in. (305 mm), 0.179 in. (3.80 mm) wall thickness)	23 lb/ft (34 kg/m)
Furnishing Metal Pile Shells 12 in. (305 mm), 0.250 in. (6.35 mm) wall thickness)	32 lb/ft (48 kg/m)
Furnishing Metal Pile Shells 14 in. (356 mm), 0.250 in. (6.35 mm) wall thickness)	37 lb/ft (55 kg/m)
Other piling	See plans
Structural Steel	See plans for weights (masses)
Reinforcing Steel	See plans for weights (masses)
Dowel Bars and Tie Bars	6 lb (3 kg) each
Mesh Reinforcement	63 lb/100 sq ft (310 kg/sq m)
Guardrail	
Steel Plate Beam Guardrail, Type A w/steel posts	20 lb/ft (30 kg/m)
Steel Plate Beam Guardrail, Type B w/steel posts	30 lb/ft (45 kg/m)
Steel Plate Beam Guardrail, Types A and B w/wood posts	8 lb/ft (12 kg/m)
Steel Plate Beam Guardrail, Type 2	305 lb (140 kg) each
Steel Plate Beam Guardrail, Type 6	1260 lb (570 kg) each
Traffic Barrier Terminal, Type 1 Special (Tangent)	730 lb (330 kg) each
Traffic Barrier Terminal, Type 1 Special (Flared)	410 lb (185 kg) each
Steel Traffic Signal and Light Poles, Towers and Mast Arms	
Traffic Signal Post	11 lb/ft (16 kg/m)
Light Pole, Tenon Mount and Twin Mount, 30 - 40 ft (9 - 12 m)	14 lb/ft (21 kg/m)
Light Pole, Tenon Mount and Twin Mount, 45 - 55 ft (13.5 - 16.5 m)	21 lb/ft (31 kg/m)
Light Pole w/Mast Arm, 30 - 50 ft (9 - 15.2 m)	13 lb/ft (19 kg/m)
Light Pole w/Mast Arm, 55 - 60 ft (16.5 - 18 m)	19 lb/ft (28 kg/m)
Light Tower w/Luminaire Mount, 80 - 110 ft (24 - 33.5 m)	31 lb/ft (46 kg/m)
Light Tower w/Luminaire Mount, 120 - 140 ft (36.5 - 42.5 m)	65 lb/ft (97 kg/m)
Light Tower w/Luminaire Mount, 150 - 160 ft (45.5 - 48.5 m)	80 lb/ft (119 kg/m)
Metal Railings (excluding wire fence)	
Steel Railing, Type SM	64 lb/ft (95 kg/m)
Steel Railing, Type S-1	39 lb/ft (58 kg/m)
Steel Railing, Type T-1	53 lb/ft (79 kg/m)
Steel Bridge Rail	52 lb/ft (77 kg/m)
Frames and Grates	
Frame	250 lb (115 kg)
Lids and Grates	150 lb (70 kg)

Return With Bid

**ILLINOIS DEPARTMENT
OF TRANSPORTATION**

**OPTION FOR
STEEL COST ADJUSTMENT**

The bidder shall submit this completed form with his/her bid. Failure to submit the form, or failure to fill out the form completely, shall make this contract exempt of steel cost adjustments. After award, this form, when submitted shall become part of the contract.

Contract No.: _____

Company Name: _____

Contractor's Option:

Is your company opting to include this special provision as part of the contract plans?

Yes

No

Signature: _____ **Date:** _____

ILLINOIS DEPARTMENT OF LABOR

PREVAILING WAGES FOR VARIOUS COUNTIES EFFECTIVE AUGUST 2008

The Prevailing rates of wages are included in the Contract proposals which are subject to Check Sheet #5 of the Supplemental Specifications and Recurring Special Provisions. The rates have been ascertained and certified by the Illinois Department of Labor for the locality in which the work is to be performed and for each craft or type of work or mechanic needed to execute the work of the Contract. As required by Prevailing Wage Act (820 ILCS 130/0.01, et seq.) and Check Sheet #5 of the Contract, not less than the rates of wages ascertained by the Illinois Department of Labor and as revised during the performance of a Contract shall be paid to all laborers, workers and mechanics performing work under the Contract. Post the scale of wages in a prominent and easily accessible place at the site of work.

If the Illinois Department of Labor revises the prevailing rates of wages to be paid as listed in the specification of rates, the contractor shall post the revised rates of wages and shall pay not less than the revised rates of wages. Current wage rate information shall be obtained by visiting the Illinois Department of Labor web site at <http://www.state.il.us/agency/idol/> or by calling 312-793-2814. It is the responsibility of the contractor to review the rates applicable to the work of the contract at regular intervals in order to insure the timely payment of current rates. Provision of this information to the contractor by means of the Illinois Department of Labor web site satisfies the notification of revisions by the Department to the contractor pursuant to the Act, and the contractor agrees that no additional notice is required. The contractor shall notify each of its subcontractors of the revised rates of wages.

Cook County Prevailing Wage for August 2008

Trade Name	RG	TYP	C	Base	FRMAN	*M-F>8	OSA	OSH	H/W	Pensn	Vac	Trng
=====	==	==	=	=====	=====	=====	==	==	=====	=====	=====	=====
ASBESTOS ABT-GEN		ALL		34.750	35.250	1.5	1.5	2.0	8.830	6.170	0.000	0.270
ASBESTOS ABT-MEC		BLD		26.180	27.930	1.5	1.5	2.0	8.760	6.410	0.000	0.310
BOILERMAKER		BLD		39.450	43.000	2.0	2.0	2.0	6.720	8.490	0.000	0.300
BRICK MASON		BLD		38.030	41.830	1.5	1.5	2.0	8.000	9.970	0.000	0.550
CARPENTER		ALL		37.770	39.770	1.5	1.5	2.0	8.960	6.910	0.000	0.490
CEMENT MASON		ALL		41.850	43.850	2.0	1.5	2.0	7.850	7.410	0.000	0.170
CERAMIC TILE FNSHER		BLD		32.150	0.000	2.0	1.5	2.0	6.150	7.370	0.000	0.380
COMM. ELECT.		BLD		35.440	37.940	1.5	1.5	2.0	7.400	7.660	0.000	0.700
ELECTRIC PWR EQMT OP		ALL		38.600	44.970	1.5	1.5	2.0	9.110	11.34	0.000	0.290
ELECTRIC PWR GRNDMAN		ALL		30.110	44.970	1.5	1.5	2.0	7.120	8.850	0.000	0.230
ELECTRIC PWR LINEMAN		ALL		38.600	44.970	1.5	1.5	2.0	9.110	11.34	0.000	0.290
ELECTRICIAN		ALL		39.400	42.000	1.5	1.5	2.0	10.83	8.740	0.000	0.750
ELEVATOR CONSTRUCTOR		BLD		43.925	49.420	2.0	2.0	2.0	8.775	6.960	2.640	0.000
FENCE ERECTOR		ALL		28.640	30.140	1.5	1.5	2.0	7.750	5.970	0.000	0.350
GLAZIER		BLD		37.000	38.500	1.5	1.5	2.0	7.340	12.05	0.000	0.690
HT/FROST INSULATOR		BLD		37.400	39.150	1.5	1.5	2.0	8.760	10.11	0.000	0.310
IRON WORKER		ALL		40.250	42.250	2.0	2.0	2.0	9.950	14.74	0.000	0.300
LABORER		ALL		34.750	35.500	1.5	1.5	2.0	8.830	6.170	0.000	0.270
LATHER		BLD		37.770	39.770	1.5	1.5	2.0	8.960	6.910	0.000	0.490
MACHINIST		BLD		40.530	42.530	1.5	1.5	2.0	7.000	7.670	0.650	0.000
MARBLE FINISHERS		ALL		28.650	0.000	1.5	1.5	2.0	7.920	9.970	0.000	0.550
MARBLE MASON		BLD		38.030	41.830	1.5	1.5	2.0	8.000	9.970	0.000	0.550
MATERIAL TESTER I		ALL		24.750	0.000	1.5	1.5	2.0	8.830	6.170	0.000	0.270
MATERIALS TESTER II		ALL		29.750	0.000	1.5	1.5	2.0	8.830	6.170	0.000	0.270
MILLWRIGHT		ALL		37.770	39.770	1.5	1.5	2.0	8.960	6.910	0.000	0.490
OPERATING ENGINEER		BLD	1	43.800	47.800	2.0	2.0	2.0	9.600	6.550	1.900	1.000
OPERATING ENGINEER		BLD	2	42.500	47.800	2.0	2.0	2.0	9.600	6.550	1.900	1.000
OPERATING ENGINEER		BLD	3	39.950	47.800	2.0	2.0	2.0	9.600	6.550	1.900	1.000
OPERATING ENGINEER		BLD	4	38.200	47.800	2.0	2.0	2.0	9.600	6.550	1.900	1.000
OPERATING ENGINEER		FLT	1	47.250	47.250	1.5	1.5	2.0	6.850	5.600	1.900	0.000
OPERATING ENGINEER		FLT	2	45.750	47.250	1.5	1.5	2.0	6.850	5.600	1.900	0.000
OPERATING ENGINEER		FLT	3	40.700	47.250	1.5	1.5	2.0	6.850	5.600	1.900	0.000
OPERATING ENGINEER		FLT	4	33.850	47.250	1.5	1.5	2.0	6.850	5.600	1.900	0.000
OPERATING ENGINEER		HWY	1	42.000	46.000	1.5	1.5	2.0	9.600	6.550	1.900	1.000
OPERATING ENGINEER		HWY	2	41.450	46.000	1.5	1.5	2.0	9.600	6.550	1.900	1.000
OPERATING ENGINEER		HWY	3	39.400	46.000	1.5	1.5	2.0	9.600	6.550	1.900	1.000
OPERATING ENGINEER		HWY	4	38.000	46.000	1.5	1.5	2.0	9.600	6.550	1.900	1.000
OPERATING ENGINEER		HWY	5	36.800	46.000	1.5	1.5	2.0	9.600	6.550	1.900	1.000
ORNAMNTL IRON WORKER		ALL		39.050	41.300	2.0	2.0	2.0	7.950	13.19	0.000	0.500
PAINTER		ALL		36.900	41.510	1.5	1.5	1.5	7.350	8.400	0.000	0.420
PAINTER SIGNS		BLD		28.970	32.520	1.5	1.5	1.5	2.600	2.310	0.000	0.000
PILEDRIVER		ALL		37.770	39.770	1.5	1.5	2.0	8.960	6.910	0.000	0.490
PIPEFITTER		BLD		40.000	42.000	1.5	1.5	2.0	8.660	7.550	0.000	1.120
PLASTERER		BLD		38.100	40.390	1.5	1.5	2.0	7.500	8.440	0.000	0.400
PLUMBER		BLD		41.000	43.000	1.5	1.5	2.0	8.840	5.560	0.000	0.980
ROOFER		BLD		35.000	38.000	1.5	1.5	2.0	6.800	3.870	0.000	0.330
SHEETMETAL WORKER		BLD		33.400	36.070	1.5	1.5	2.0	6.460	7.850	0.000	0.590
SIGN HANGER		BLD		26.510	27.360	1.5	1.5	2.0	4.200	2.280	0.000	0.000
SPRINKLER FITTER		BLD		40.500	42.500	1.5	1.5	2.0	8.500	6.850	0.000	0.500
STEEL ERECTOR		ALL		40.250	42.250	2.0	2.0	2.0	9.950	14.74	0.000	0.300
STONE MASON		BLD		38.030	41.830	1.5	1.5	2.0	8.000	9.970	0.000	0.550
TERRAZZO FINISHER		BLD		33.810	0.000	1.5	1.5	2.0	6.150	9.850	0.000	0.310
TERRAZZO MASON		BLD		37.390	40.390	1.5	1.5	2.0	6.150	11.11	0.000	0.350
TILE MASON		BLD		38.630	42.630	2.0	1.5	2.0	6.150	9.010	0.000	0.500
TRAFFIC SAFETY WRKR		HWY		24.300	25.900	1.5	1.5	2.0	3.780	1.875	0.000	0.000
TRUCK DRIVER	E	ALL	1	30.700	31.350	1.5	1.5	2.0	6.750	5.450	0.000	0.150
TRUCK DRIVER	E	ALL	2	30.950	31.350	1.5	1.5	2.0	6.750	5.450	0.000	0.150
TRUCK DRIVER	E	ALL	3	31.150	31.350	1.5	1.5	2.0	6.750	5.450	0.000	0.150

TRUCK DRIVER	E	ALL	4	31.350	31.350	1.5	1.5	2.0	6.750	5.450	0.000	0.150
TRUCK DRIVER	W	ALL	1	32.550	33.100	1.5	1.5	2.0	6.500	4.350	0.000	0.000
TRUCK DRIVER	W	ALL	2	32.700	33.100	1.5	1.5	2.0	6.500	4.350	0.000	0.000
TRUCK DRIVER	W	ALL	3	32.900	33.100	1.5	1.5	2.0	6.500	4.350	0.000	0.000
TRUCK DRIVER	W	ALL	4	33.100	33.100	1.5	1.5	2.0	6.500	4.350	0.000	0.000
TUCKPOINTER		BLD		38.200	39.200	1.5	1.5	2.0	6.580	9.550	0.000	0.280

Legend:

M-F>8 (Overtime is required for any hour greater than 8 worked each day, Monday through Friday.)

OSA (Overtime is required for every hour worked on Saturday)

OSH (Overtime is required for every hour worked on Sunday and Holidays)

H/W (Health & Welfare Insurance)

Pensn (Pension)

Vac (Vacation)

Trng (Training)

Explanations

COOK COUNTY

TRUCK DRIVERS (WEST) - That part of the county West of Barrington Road.

The following list is considered as those days for which holiday rates of wages for work performed apply: New Years Day, Memorial/Decoration Day, Fourth of July, Labor Day, Veterans Day, Thanksgiving Day, Christmas Day. Generally, any of these holidays which fall on a Sunday is celebrated on the following Monday. This then makes work performed on that Monday payable at the appropriate overtime rate for holiday pay. Common practice in a given local may alter certain days of celebration such as the day after Thanksgiving for Veterans Day. If in doubt, please check with IDOL.

EXPLANATION OF CLASSES

ASBESTOS - GENERAL - removal of asbestos material/mold and hazardous materials from any place in a building, including mechanical systems where those mechanical systems are to be removed. This includes the removal of asbestos materials/mold and hazardous materials from ductwork or pipes in a building when the building is to be demolished at the time or at some close future date.

ASBESTOS - MECHANICAL - removal of asbestos material from mechanical systems, such as pipes, ducts, and boilers, where the mechanical systems are to remain.

CERAMIC TILE FINISHER

The grouting, cleaning, and polishing of all classes of tile, whether for interior or exterior purposes, all burned, glazed or unglazed products; all composition materials, granite tiles, warning detectable tiles, cement tiles, epoxy composite materials, pavers, glass, mosaics, fiberglass, and all substitute materials, for tile made in

tile-like units; all mixtures in tile like form of cement, metals, and other materials that are for and intended for use as a finished floor surface, stair treads, promenade roofs, walks, walls, ceilings, swimming pools, and all other places where tile is to form a finished interior or exterior. The mixing of all setting mortars including but not limited to thin-set mortars, epoxies, wall mud, and any other sand and cement mixtures or adhesives when used in the preparation, installation, repair, or maintenance of tile and/or similar materials. The handling and unloading of all sand, cement, lime, tile, fixtures, equipment, adhesives, or any other materials to be used in the preparation, installation, repair, or maintenance of tile and/or similar materials. Ceramic Tile Finishers shall fill all joints and voids regardless of method on all tile work, particularly and especially after installation of said tile work. Application of any and all protective coverings to all types of tile installations including, but not be limited to, all soap compounds, paper products, tapes, and all polyethylene coverings, plywood, masonite, cardboard, and any new type of products that may be used to protect tile installations, Blastrac equipment, and all floor scarifying equipment used in preparing floors to receive tile. The clean up and removal of all waste and materials. All demolition of existing tile floors and walls to be re-tiled.

COMMUNICATIONS ELECTRICIAN - Installation, operation, inspection, maintenance, repair and service of radio, television, recording, voice sound vision production and reproduction, telephone and telephone interconnect, facsimile, data apparatus, coaxial, fibre optic and wireless equipment, appliances and systems used for the transmission and reception of signals of any nature, business, domestic, commercial, education, entertainment, and residential purposes, including but not limited to, communication and telephone, electronic and sound equipment, fibre optic and data communication systems, and the performance of any task directly related to such installation or service whether at new or existing sites, such tasks to include the placing of wire and cable and electrical power conduit or other raceway work within the equipment room and pulling wire and/or cable through conduit and the installation of any incidental conduit, such that the employees covered hereby can complete any job in full.

MARBLE FINISHER

Loading and unloading trucks, distribution of all materials (all stone, sand, etc.), stocking of floors with material, performing all rigging for heavy work, the handling of all material that may be needed for the installation of such materials, building of scaffolding, polishing if needed, patching, waxing of material if damaged, pointing up, caulking, grouting and cleaning of marble, holding water on diamond or Carborundum blade or saw for setters cutting, use of tub saw or any other saw needed for preparation of material, drilling of holes for wires that anchor material set by setters, mixing up of molding plaster for installation of material, mixing up thin set for the installation of material, mixing up of sand to cement for the installatin of material and such other work as may be required in helping a Marble Setter in the handling of all material in the erection or installation of interior marble, slate, travertine, art marble, serpentine, alberene stone, blue stone, granite and other stones (meaning as to stone any foreign or domestic materials as are specified and used in building interiors and experiors and customarily known as stone in the trade), carrara, sanionyx, vitrolite and similar opaque glass and the laying of all marble tile, terrazzo tile, slate tile and precast tile, steps, risers treads, base, or any other materials that may be used as substitutes for any of the aforementioned materials and which are used on interior

and exterior which were installed in a similar manner.

MATERIAL TESTER I: Hand coring and drilling for testing of materials; field inspection of uncured concrete and asphalt.

MATERIAL TESTER II: Field inspection of welds, structural steel, fireproofing, masonry, soil, facade, reinforcing steel, formwork, cured concrete, and concrete and asphalt batch plants; adjusting proportions of bituminous mixtures.

TERRAZZO FINISHER

The handling of sand, cement, marble chips, and all other materials that may be used by the Mosaic Terrazzo Mechanic, and the mixing, grinding, grouting, cleaning and sealing of all Marble, Mosaic, and Terrazzo work, floors, base, stairs, and wainscoting by hand or machine, and in addition, assisting and aiding Marble, Masonic, and Terrazzo Mechanics.

OPERATING ENGINEERS - BUILDING

Class 1. Mechanic; Asphalt Plant; Asphalt Spreader; Autograde; Backhoes with Caisson attachment; Batch Plant; Benoto; Boiler and Throttle Valve; Caisson Rigs; Central Redi-Mix Plant; Combination Back Hoe Front End-loader Machine; Compressor and Throttle Valve; Concrete Breaker (Truck Mounted); Concrete Conveyor; Concrete Paver; Concrete Placer; Concrete Placing Boom; Concrete Pump (Truck Mounted); Concrete Tower; Cranes, All; Cranes, Hammerhead; Cranes, (GCI and similar Type); Creter Crane; Crusher, Stone, etc.; Derricks, All; Derricks, Traveling; Formless Curb and Gutter Machine; Grader, Elevating; Grouting Machines; Highlift Shovels or Front Endloader 2-1/4 yd. and over; Hoists, Elevators, outside type rack and pinion and similar machines; Hoists, one, two and three Drum; Hoists, Two Tugger One Floor; Hydraulic Backhoes; Hydraulic Boom Trucks; Hydro Vac (and similar equipment); Locomotives, All; Motor Patrol; Pile Drivers and Skid Rig; Post Hole Digger; Pre-Stress Machine; Pump Cretes Dual Ram; Pump Cretes; Squeeze Cretes-screw Type Pumps; Raised and Blind Hole Drill; Roto Mill Grinder; Scoops - Tractor Drawn; Slip-form Paver; Straddle Buggies; Tournapull; Tractor with Boom and Side Boom; Trenching Machines.

Class 2. Boilers; Broom, All Power Propelled; Bulldozers; Concrete Mixer (Two Bag and Over); Conveyor, Portable; Forklift Trucks; Greaser Engineer; Highlift Shovels or Front Endloaders under 2-1/4 yd.; Hoists, Automatic; Hoists, inside Freight Elevators; Hoists, Sewer Dragging Machine; Hoists, Tugger Single Drum; Laser Screed; Rock Drill self-propelled; Rock Drill (truck mounted); Rollers, All; Steam Generators; Tractors, All; Tractor Drawn Vibratory Roller; Winch Trucks with "A" Frame.

Class 3. Air Compressor; Combination - Small Equipment Operator; Generators; Heaters, Mechanical; Hoists, Inside Elevators - (Rheostat Manual Controlled); Hydraulic Power Units (Pile Driving, Extracting, and Drilling); Pumps, over 3" (1 to 3 not to exceed a total of 300 ft.); Pumps, Well Points; Welding Machines (2 through 5); Winches, 4 small Electric Drill Winches; Bobcat (up to and including 3/4 cu. yd.).

Class 4. Bobcats and/or other Skid Steer Loaders; Oilers; and Brick Forklift.

OPERATING ENGINEERS - FLOATING

Class 1. Craft foreman (Master Mechanic), diver/wet tender, engineer (hydraulic dredge).

Class 2. Crane/backhoe operator, mechanic/welder, assistant engineer (hydraulic dredge), leverman (hydraulic dredge), and diver tender.

Class 3. Deck equipment operator (machineryman), maintenance of crane (over 50 ton capacity) or backhoe (96,000 pounds or more), tug/launch operator, loader, dozer and like equipment on barge, breakwater wall, slip/dock or scow, deck machinery, etc.

Class 4. Deck equipment operator machineryman/fireman), (4 equipment units or more) and crane maintenance 50 ton capacity and under or backhoe weighing 96,000 pounds or less, assistant tug operator.

OPERATING ENGINEERS - HEAVY AND HIGHWAY CONSTRUCTION

Class 1. Craft Foreman; Asphalt Plant; Asphalt Heater and Planer Combination; Asphalt Heater Scarfire; Asphalt Spreader; Autograder/GOMACO or other similar type machines; ABG Paver; Backhoes with Caisson attachment; Ballast Regulator; Belt Loader; Caisson Rigs; Car Dumper; Central Redi-Mix Plant; Combination Backhoe Front Endloader Machine, (1 cu. yd. Backhoe Bucket or over or with attachments); Concrete Breaker (Truck Mounted); Concrete Conveyor; Concrete Paver over 27E cu. ft.; Concrete Placer; Concrete Tube Float; Cranes, all attachments; Cranes, Hammerhead, Linden, Peco & Machines of a like nature; Crete Crane; Crusher, Stone, etc.; Derricks, All; Derrick Boats; Derricks, Traveling; Dowell machine with Air Compressor; Dredges; Field Mechanic-Welder; Formless Curb and Gutter Machine; Gradall and Machines of a like nature; Grader, Elevating; Grader, Motor Grader, Motor Patrol, Auto Patrol, Form Grader, Pull Grader, Subgrader; Guard Rail Post Driver Mounted; Hoists, One, Two and Three Drum; Hydraulic Backhoes; Backhoes with shear attachments; Mucking Machine; Pile Drivers and Skid Rig; Pre-Stress Machine; Pump Cretes Dual Ram; Rock Drill - Crawler or Skid Rig; Rock Drill - Truck Mounted; Roto Mill Grinder; Slip-Form Paver; Soil Test Drill Rig (Truck Mounted); Straddle Buggies; Hydraulic Telescoping Form (Tunnel); Tractor Drawn Belt Loader (with attached pusher - two engineers); Tractor with Boom; Tractaire with Attachments; Trenching Machine; Truck Mounted Concrete Pump with Boom; Raised or Blind Hole; Drills (Tunnel Shaft); Underground Boring and/or Mining Machines; Wheel Excavator; Widener (APSCO).

Class 2. Batch Plant; Bituminous Mixer; Boiler and Throttle Valve; Bulldozers; Car Loader Trailing Conveyors; Combination Backhoe Front Endloader Machine (less than 1 cu. yd. Backhoe Bucket or over or with attachments); Compressor and Throttle Valve; Compressor, Common Receiver (3); Concrete Breaker or Hydro Hammer; Concrete Grinding Machine; Concrete Mixer or Paver 7S Series to and including 27 cu. ft.; Concrete Spreader; Concrete Curing Machine, Burlap Machine, Belting Machine and Sealing Machine; Concrete Wheel Saw; Conveyor Muck Cars (Haglund or Similar Type); Drills, All; Finishing Machine - Concrete; Greaser Engineer; Highlift Shovels or Front Endloader; Hoist - Sewer Dragging Machine; Hydraulic Boom Trucks (All Attachments); Hydro-Blaster; All Locomotives, Dinky; Pump Cretes; Squeeze Cretes-Screw Type Pumps, Gypsum Bulker and Pump; Roller, Asphalt; Rotary Snow Plows; Rototiller, Seaman, etc., self-propelled; Scoops - Tractor Drawn; Self-Propelled Compactor; Spreader - Chip - Stone, etc.; Scraper; Scraper - Prime Mover in Tandem (Regardless of Size); Tank Car Heater; Tractors, Push, Pulling Sheeps Foot, Disc, Compactor, etc.; Tug Boats.

Class 3. Boilers; Brooms, All Power Propelled; Cement Supply Tender; Compressor, Common Receiver (2); Concrete Mixer (Two Bag and Over); Conveyor, Portable; Farm-Type Tractors Used for Mowing, Seeding, etc.; Fireman on Boilers; Forklift Trucks; Grouting Machine; Hoists, Automatic; Hoists, All Elevators; Hoists, Tugger Single Drum; Jeep Diggers; Pipe Jacking Machines; Post-Hole Digger; Power Saw, Concrete Power Driven; Pug Mills; Rollers, other than asphalt; Seed and Straw Blower; Steam Generators; Stump Machine; Winch Trucks with "A" Frame; Work Boats; Tamper - Form-Motor Driven.

Class 4. Air Compressor; Combination - Small Equipment Operator; Directional Boring Machine; Generators; Heaters, Mechanical; Hydraulic Power Unit (Pile Driving, Extracting, or Drilling); Hydro-Blaster; Light Plants, All (1 through 5); Pumps, over 3" (1 to 3 not to exceed a total of 300 ft.); Pumps, Well Points; Tractaire; Welding Machines (2 through 5); Winches, 4 Small Electric Drill Winches.

Class 5. Bobcats (all); Brick Forklifts, Oilers.

TRAFFIC SAFETY

Work associated with barricades, horses and drums used to reduce lane usage on highway work, the installation and removal of temporary lane markings, and the installation and removal of temporary road signs.

TRUCK DRIVER - BUILDING, HEAVY AND HIGHWAY CONSTRUCTION - EAST & WEST

Class 1. Two or three Axle Trucks. A-frame Truck when used for transportation purposes; Air Compressors and Welding Machines, including those pulled by cars, pick-up trucks and tractors; Ambulances; Batch Gate Lockers; Batch Hopperman; Car and Truck Washers; Carry-alls; Fork Lifts and Hoisters; Helpers; Mechanics Helpers and Greasers; Oil Distributors 2-man operation; Pavement Breakers; Pole Trailer, up to 40 feet; Power Mower Tractors; Self-propelled Chip Spreader; Skipman; Slurry Trucks, 2-man operation; Slurry Truck Conveyor Operation, 2 or 3 man; TEamsters Unskilled dumpman; and Truck Drivers hauling warning lights, barricades, and portable toilets on the job site.

Class 2. Four axle trucks; Dump Crets and Adgetors under 7 yards; Dumpsters, Track Trucks, Euclids, Hug Bottom Dump Turnapulls or Turnatrailers when pulling other than self-loading equipment or similar equipment under 16 cubic yards; Mixer Trucks under 7 yards; Ready-mix Plant Hopper Operator, and Winch Trucks, 2 Axles.

Class 3. Five axle trucks; Dump Crets and Adgetors 7 yards and over; Dumpsters, Track Trucks, Euclids, Hug Bottom Dump Turnatrailers or turnapulls when pulling other than self-loading equipment or similar equipment over 16 cubic yards; Explosives and/or Fission Material Trucks; Mixer Trucks 7 yards or over; Mobile Cranes while in transit; Oil Distributors, 1-man operation; Pole Trailer, over 40 feet; Pole and Expandable Trailers hauling material over 50 feet long; Slurry trucks, 1-man operation; Winch trucks, 3 axles or more; Mechanic--Truck Welder and Truck Painter.

Class 4. Six axle trucks; Dual-purpose vehicles, such as mounted crane trucks with hoist and accessories; Foreman; Master Mechanic; Self-loading equipment like P.B. and trucks with scoops on the front.

Other Classifications of Work:

For definitions of classifications not otherwise set out, the Department generally has on file such definitions which are available. If a task to be performed is not subject to one of the classifications of pay set out, the Department will upon being contacted state which neighboring county has such a classification and provide such rate, such rate being deemed to exist by reference in this document. If no neighboring county rate applies to the task, the Department shall undertake a special determination, such special determination being then deemed to have existed under this determination. If a project requires these, or any classification not listed, please contact IDOL at 618/993-7271 for wage rates or clarifications.

LANDSCAPING

Landscaping work falls under the existing classifications for laborer, operating engineer and truck driver. The work performed by landscape plantsman and landscape laborer is covered by the existing classification of laborer. The work performed by landscape operators (regardless of equipment used or its size) is covered by the classifications of operating engineer. The work performed by landscape truck drivers (regardless of size of truck driven) is covered by the classifications of truck driver.

Du Page County Prevailing Wage for August 2008

Trade Name	RG	TYP	C	Base	FRMAN	*M-F>8	OSA	OSH	H/W	Pensn	Vac	Trng
=====	==	==	=	=====	=====	=====	==	==	=====	=====	=====	=====
ASBESTOS ABT-GEN		ALL		34.750	35.250	1.5	1.5	2.0	8.830	6.170	0.000	0.270
ASBESTOS ABT-MEC		BLD		26.180	27.930	1.5	1.5	2.0	8.760	6.410	0.000	0.310
BOILERMAKER		BLD		39.450	43.000	2.0	2.0	2.0	6.720	8.490	0.000	0.300
BRICK MASON		BLD		38.030	41.830	1.5	1.5	2.0	8.000	9.970	0.000	0.550
CARPENTER		ALL		37.770	39.770	1.5	1.5	2.0	8.960	6.910	0.000	0.490
CEMENT MASON		ALL		38.000	40.000	2.0	1.5	2.0	7.250	11.70	0.000	0.380
CERAMIC TILE FNSHER		BLD		32.150	0.000	2.0	1.5	2.0	6.150	7.370	0.000	0.380
COMMUNICATION TECH		BLD		31.000	33.100	1.5	1.5	2.0	7.300	11.11	0.000	0.470
ELECTRIC PWR EQMT OP		ALL		29.180	37.490	1.5	1.5	2.0	4.750	8.180	0.000	0.220
ELECTRIC PWR GRNDMAN		ALL		22.610	37.490	1.5	1.5	2.0	4.750	6.330	0.000	0.170
ELECTRIC PWR LINEMAN		ALL		34.710	37.490	1.5	1.5	2.0	4.750	9.720	0.000	0.260
ELECTRIC PWR TRK DRV		ALL		23.350	37.490	1.5	1.5	2.0	4.750	6.540	0.000	0.180
ELECTRICIAN		BLD		34.250	37.680	1.5	1.5	2.0	8.300	13.15	3.770	0.510
ELEVATOR CONSTRUCTOR		BLD		43.925	49.420	2.0	2.0	2.0	8.775	6.960	2.640	0.000
FENCE ERECTOR	NE	ALL		28.640	30.140	1.5	1.5	2.0	7.750	5.970	0.000	0.350
FENCE ERECTOR	W	ALL		38.120	40.030	2.0	2.0	2.0	8.140	14.49	0.000	0.230
GLAZIER		BLD		37.000	38.500	1.5	1.5	2.0	7.340	12.05	0.000	0.690
HT/FROST INSULATOR		BLD		37.400	39.150	1.5	1.5	2.0	8.760	10.11	0.000	0.310
IRON WORKER	E	ALL		40.250	42.250	2.0	2.0	2.0	9.950	14.74	0.000	0.300
IRON WORKER	W	ALL		38.120	40.030	2.0	2.0	2.0	8.140	14.49	0.000	0.230
LABORER		ALL		34.750	35.500	1.5	1.5	2.0	8.830	6.170	0.000	0.270
LATHER		BLD		37.770	39.770	1.5	1.5	2.0	8.960	6.910	0.000	0.490
MACHINIST		BLD		40.530	42.530	1.5	1.5	2.0	7.000	7.670	0.650	0.000
MARBLE FINISHERS		ALL		28.650	0.000	1.5	1.5	2.0	7.920	9.970	0.000	0.550
MARBLE MASON		BLD		38.030	41.830	1.5	1.5	2.0	8.000	9.970	0.000	0.550
MATERIAL TESTER I		ALL		24.750	0.000	1.5	1.5	2.0	8.830	6.170	0.000	0.270
MATERIALS TESTER II		ALL		29.750	0.000	1.5	1.5	2.0	8.830	6.170	0.000	0.270
MILLWRIGHT		ALL		37.770	39.770	1.5	1.5	2.0	8.960	6.910	0.000	0.490
OPERATING ENGINEER		BLD	1	43.800	47.800	2.0	2.0	2.0	9.600	6.550	1.900	1.000
OPERATING ENGINEER		BLD	2	42.500	47.800	2.0	2.0	2.0	9.600	6.550	1.900	1.000
OPERATING ENGINEER		BLD	3	39.950	47.800	2.0	2.0	2.0	9.600	6.550	1.900	1.000
OPERATING ENGINEER		BLD	4	38.200	47.800	2.0	2.0	2.0	9.600	6.550	1.900	1.000
OPERATING ENGINEER		HWY	1	42.000	46.000	1.5	1.5	2.0	9.600	6.550	1.900	1.000
OPERATING ENGINEER		HWY	2	41.450	46.000	1.5	1.5	2.0	9.600	6.550	1.900	1.000
OPERATING ENGINEER		HWY	3	39.400	46.000	1.5	1.5	2.0	9.600	6.550	1.900	1.000
OPERATING ENGINEER		HWY	4	38.000	46.000	1.5	1.5	2.0	9.600	6.550	1.900	1.000
OPERATING ENGINEER		HWY	5	36.800	46.000	1.5	1.5	2.0	9.600	6.550	1.900	1.000
ORNAMNTL IRON WORKER	E	ALL		39.050	41.300	2.0	2.0	2.0	7.950	13.19	0.000	0.500
ORNAMNTL IRON WORKER	W	ALL		38.120	40.030	2.0	2.0	2.0	8.140	14.49	0.000	0.230
PAINTER		ALL		37.830	39.830	1.5	1.5	1.5	6.750	6.750	0.000	0.500
PAINTER SIGNS		BLD		28.970	32.520	1.5	1.5	1.5	2.600	2.310	0.000	0.000
PILEDRIVER		ALL		37.770	39.770	1.5	1.5	2.0	8.960	6.910	0.000	0.490
PIPEFITTER		BLD		39.500	41.500	1.5	1.5	2.0	9.200	10.24	0.000	1.060
PLASTERER		BLD		32.000	33.500	1.5	1.5	2.0	6.450	6.770	0.000	0.570
PLUMBER		BLD		39.500	41.500	1.5	1.5	2.0	9.200	10.24	0.000	1.060
ROOFER		BLD		35.000	38.000	1.5	1.5	2.0	6.800	3.870	0.000	0.330
SHEETMETAL WORKER		BLD		40.210	42.210	1.5	1.5	2.0	7.410	9.620	0.000	0.680
SPRINKLER FITTER		BLD		40.500	42.500	1.5	1.5	2.0	8.500	6.850	0.000	0.500
STEEL ERECTOR	E	ALL		40.250	42.250	2.0	2.0	2.0	9.950	14.74	0.000	0.300
STEEL ERECTOR	W	ALL		38.120	40.030	2.0	2.0	2.0	8.140	14.49	0.000	0.230
STONE MASON		BLD		38.030	41.830	1.5	1.5	2.0	8.000	9.970	0.000	0.550
TERRAZZO FINISHER		BLD		33.810	0.000	1.5	1.5	2.0	6.150	9.850	0.000	0.310
TERRAZZO MASON		BLD		37.390	40.390	1.5	1.5	2.0	6.150	11.11	0.000	0.350
TILE MASON		BLD		38.630	42.630	2.0	1.5	2.0	6.150	9.010	0.000	0.500
TRAFFIC SAFETY WRKR		HWY		24.300	25.900	1.5	1.5	2.0	3.780	1.875	0.000	0.000
TRUCK DRIVER		ALL	1	32.550	33.100	1.5	1.5	2.0	6.500	4.350	0.000	0.150
TRUCK DRIVER		ALL	2	32.700	33.100	1.5	1.5	2.0	6.500	4.350	0.000	0.150
TRUCK DRIVER		ALL	3	32.900	33.100	1.5	1.5	2.0	6.500	4.350	0.000	0.150

TRUCK DRIVER	ALL	4	33.100	33.100	1.5	1.5	2.0	6.500	4.350	0.000	0.150
TUCKPOINTER	BLD		38.200	39.200	1.5	1.5	2.0	6.580	9.550	0.000	0.280

Legend:

M-F>8 (Overtime is required for any hour greater than 8 worked each day, Monday through Friday.)

OSA (Overtime is required for every hour worked on Saturday)

OSH (Overtime is required for every hour worked on Sunday and Holidays)

H/W (Health & Welfare Insurance)

Pensn (Pension)

Vac (Vacation)

Trng (Training)

Explanations

DUPAGE COUNTY

IRON WORKERS AND FENCE ERECTOR (WEST) - West of Route 53.

The following list is considered as those days for which holiday rates of wages for work performed apply: New Years Day, Memorial/Decoration Day, Fourth of July, Labor Day, Veterans Day, Thanksgiving Day, Christmas Day. Generally, any of these holidays which fall on a Sunday is celebrated on the following Monday. This then makes work performed on that Monday payable at the appropriate overtime rate for holiday pay. Common practice in a given local may alter certain days of celebration such as the day after Thanksgiving for Veterans Day. If in doubt, please check with IDOL.

EXPLANATION OF CLASSES

ASBESTOS - GENERAL - removal of asbestos material/mold and hazardous materials from any place in a building, including mechanical systems where those mechanical systems are to be removed. This includes the removal of asbestos materials/mold and hazardous materials from ductwork or pipes in a building when the building is to be demolished at the time or at some close future date.

ASBESTOS - MECHANICAL - removal of asbestos material from mechanical systems, such as pipes, ducts, and boilers, where the mechanical systems are to remain.

TRAFFIC SAFETY - work associated with barricades, horses and drums used to reduce lane usage on highway work, the installation and removal of temporary lane markings, and the installation and removal of temporary road signs.

CERAMIC TILE FINISHER

The grouting, cleaning, and polishing of all classes of tile, whether for interior or exterior purposes, all burned, glazed or unglazed products; all composition materials, granite tiles, warning detectable tiles, cement tiles, epoxy composite materials, pavers, glass, mosaics, fiberglass, and all substitute materials, for tile made in

tile-like units; all mixtures in tile like form of cement, metals, and other materials that are for and intended for use as a finished floor surface, stair treads, promenade roofs, walks, walls, ceilings, swimming pools, and all other places where tile is to form a finished interior or exterior. The mixing of all setting mortars including but not limited to thin-set mortars, epoxies, wall mud, and any other sand and cement mixtures or adhesives when used in the preparation, installation, repair, or maintenance of tile and/or similar materials. The handling and unloading of all sand, cement, lime, tile, fixtures, equipment, adhesives, or any other materials to be used in the preparation, installation, repair, or maintenance of tile and/or similar materials. Ceramic Tile Finishers shall fill all joints and voids regardless of method on all tile work, particularly and especially after installation of said tile work. Application of any and all protective coverings to all types of tile installations including, but not be limited to, all soap compounds, paper products, tapes, and all polyethylene coverings, plywood, masonite, cardboard, and any new type of products that may be used to protect tile installations, Blastrac equipment, and all floor scarifying equipment used in preparing floors to receive tile. The clean up and removal of all waste and materials. All demolition of existing tile floors and walls to be re-tiled.

COMMUNICATIONS TECHNICIAN

Low voltage installation, maintenance and removal of telecommunication facilities (voice, sound, data and video) including telephone and data inside wire, interconnect, terminal equipment, central offices, PABX, fiber optic cable and equipment, micro waves, V-SAT, bypass, CATV, WAN (wide area networks), LAN (local area networks), and ISDN (integrated system digital network), pulling of wire in raceways, but not the installation of raceways.

MARBLE FINISHER

Loading and unloading trucks, distribution of all materials (all stone, sand, etc.), stocking of floors with material, performing all rigging for heavy work, the handling of all material that may be needed for the installation of such materials, building of scaffolding, polishing if needed, patching, waxing of material if damaged, pointing up, caulking, grouting and cleaning of marble, holding water on diamond or Carborundum blade or saw for setters cutting, use of tub saw or any other saw needed for preparation of material, drilling of holes for wires that anchor material set by setters, mixing up of molding plaster for installation of material, mixing up thin set for the installation of material, mixing up of sand to cement for the installation of material and such other work as may be required in helping a Marble Setter in the handling of all material in the erection or installation of interior marble, slate, travertine, art marble, serpentine, alberene stone, blue stone, granite and other stones (meaning as to stone any foreign or domestic materials as are specified and used in building interiors and exteriors and customarily known as stone in the trade), carrara, sanionyx, vitrolite and similar opaque glass and the laying of all marble tile, terrazzo tile, slate tile and precast tile, steps, risers treads, base, or any other materials that may be used as substitutes for any of the aforementioned materials and which are used on interior and exterior which sare installed in a similar manner.

MATERIAL TESTER I: Hand coring and drilling for testing of materials; field inspection of uncured concrete and asphalt.

MATERIAL TESTER II: Field inspection of welds, structural steel,

fireproofing, masonry, soil, facade, reinforcing steel, formwork, cured concrete, and concrete and asphalt batch plants; adjusting proportions of bituminous mixtures.

TRUCK DRIVER - BUILDING, HEAVY AND HIGHWAY CONSTRUCTION

Class 1. Two or three Axle Trucks. A-frame Truck when used for transportation purposes; Air Compressors and Welding Machines, including those pulled by cars, pick-up trucks and tractors; Ambulances; Batch Gate Lockers; Batch Hopperman; Car and Truck Washers; Carry-alls; Fork Lifts and Hoisters; Helpers; Mechanics Helpers and Greasers; Oil Distributors 2-man operation; Pavement Breakers; Pole Trailer, up to 40 feet; Power Mower Tractors; Self-propelled Chip Spreader; Skipman; Slurry Trucks, 2-man operation; Slurry Truck Conveyor Operation, 2 or 3 man; Teamsters Unskilled dumpman; and Truck Drivers hauling warning lights, barricades, and portable toilets on the job site.

Class 2. Four axle trucks; Dump Crets and Adgetors under 7 yards; Dumpsters, Track Trucks, Euclids, Hug Bottom Dump Turnapulls or Turnatrailers when pulling other than self-loading equipment or similar equipment under 16 cubic yards; Mixer Trucks under 7 yards; Ready-mix Plant Hopper Operator, and Winch Trucks, 2 Axles.

Class 3. Five axle trucks; Dump Crets and Adgetors 7 yards and over; Dumpsters, Track Trucks, Euclids, Hug Bottom Dump Turnatrailers or turnapulls when pulling other than self-loading equipment or similar equipment over 16 cubic yards; Explosives and/or Fission Material Trucks; Mixer Trucks 7 yards or over; Mobile Cranes while in transit; Oil Distributors, 1-man operation; Pole Trailer, over 40 feet; Pole and Expandable Trailers hauling material over 50 feet long; Slurry trucks, 1-man operation; Winch trucks, 3 axles or more; Mechanic--Truck Welder and Truck Painter.

Class 4. Six axle trucks; Dual-purpose vehicles, such as mounted crane trucks with hoist and accessories; Foreman; Master Mechanic; Self-loading equipment like P.B. and trucks with scoops on the front.

OPERATING ENGINEERS - BUILDING

Class 1. Mechanic; Asphalt Plant; Asphalt Spreader; Autograde; Backhoes with Caisson attachment; Batch Plant; Benoto; Boiler and Throttle Valve; Caisson Rigs; Central Redi-Mix Plant; Combination Back Hoe Front End-loader Machine; Compressor and Throttle Valve; Concrete Breaker (Truck Mounted); Concrete Conveyor; Concrete Paver; Concrete Placer; Concrete Placing Boom; Concrete Pump (Truck Mounted); Concrete Tower; Cranes, All; Cranes, Hammerhead; Cranes, (GCI and similar Type); Creter Crane; Crusher, Stone, etc.; Derricks, All; Derricks, Traveling; Formless Curb and Gutter Machine; Grader, Elevating; Grouting Machines; Highlift Shovels or Front Endloader 2-1/4 yd. and over; Hoists, Elevators, outside type rack and pinion and similar machines; Hoists, one, two and three Drum; Hoists, Two Tugger One Floor; Hydraulic Backhoes; Hydraulic Boom Trucks; Hydro Vac (and similar equipment); Locomotives, All; Motor Patrol; Pile Drivers and Skid Rig; Post Hole Digger; Pre-Stress Machine; Pump Cretes Dual Ram; Pump Cretes; Squeeze Cretes-screw Type Pumps; Raised and Blind Hole Drill; Roto Mill Grinder; Scoops - Tractor Drawn; Slip-form Paver; Straddle Buggies; Tournapull; Tractor with Boom and Side Boom; Trenching Machines.

Class 2. Boilers; Broom, All Power Propelled; Bulldozers; Concrete Mixer (Two Bag and Over); Conveyor, Portable; Fortlist Trucks; Greaser Engineer; Highlift Shovels or Front Endloaders under 2-1/4

yd.; Hoists, Automatic; Hoists, inside Freight Elevators; Hoists, Sewer Dragging Machine; Hoists, Tugger Single Drum; Laser Screed; Rock Drill (self-propelled); Rock Drill (truck mounted); Rollers, All; Steam Generators; Tractors, All; Tractor Drawn Vibratory Roller; Winch Trucks with "A" Frame.

Class 3. Air Compressor; Combination - Small Equipment Operator; Generators; Heaters, Mechanical; Hoists, Inside Elevators - (Rheostat Manual Controlled); Hydraulic Power Units (Pile Driving, Extracting, and Drilling); Pumps, over 3" (1 to 3 not to exceed a total of 300 ft.); Pumps, Well Points; Welding Machines (2 through 5); Winches, 4 small Electric Drill Winches; Bobcat (up to and including 3/4 cu. yd.).

Class 4. Bobcats and/or other Skid Steer Loaders; Oilers; and Brick Forklift.

OPERATING ENGINEERS - HEAVY AND HIGHWAY CONSTRUCTION

Class 1. Craft Foreman; Asphalt Plant; Asphalt Heater and Planer Combination; Asphalt Heater Scarfire; Asphalt Spreader; Autograder/GOMACO or other similar type machines; ABG Paver; Backhoes with Caisson attachment; Ballast Regulator; Belt Loader; Caisson Rigs; Car Dumper; Central Redi-Mix Plant; Combination Backhoe Front Endloader Machine, (1 cu. yd. Backhoe Bucket or over or with attachments); Concrete Breaker (Truck Mounted); Concrete Conveyor; Concrete Paver over 27E cu. ft.; Concrete Placer; Concrete Tube Float; Cranes, all attachments; Cranes, Hammerhead, Linden, Peco & Machines of a like nature; Crete Crane; Crusher, Stone, etc.; Derricks, All; Derrick Boats; Derricks, Traveling; Dowell machine with Air Compressor; Dredges; Field Mechanic-Welder; Formless Curb and Gutter Machine; Gradall and Machines of a like nature; Grader, Elevating; Grader, Motor Grader, Motor Patrol, Auto Patrol, Form Grader, Pull Grader, Subgrader; Guard Rail Post Driver Mounted; Hoists, One, Two and Three Drum; Hydraulic Backhoes; Backhoes with shear attachments; Mucking Machine; Pile Drivers and Skid Rig; Pre-Stress Machine; Pump Cretes Dual Ram; Rock Drill - Crawler or Skid Rig; Rock Drill - Truck Mounted; Roto Mill Grinder; Slip-Form Paver; Soil Test Drill Rig (Truck Mounted); Straddle Buggies; Hydraulic Telescoping Form (Tunnel); Tractor Drawn Belt Loader (with attached pusher - two engineers); Tractor with Boom; Tractaire with Attachments; Trenching Machine; Truck Mounted Concrete Pump with Boom; Raised or Blind Hole; Drills (Tunnel Shaft); Underground Boring and/or Mining Machines; Wheel Excavator; Widener (APSCO).

Class 2. Batch Plant; Bituminous Mixer; Boiler and Throttle Valve; Bulldozers; Car Loader Trailing Conveyors; Combination Backhoe Front Endloader Machine (less than 1 cu. yd. Backhoe Bucket or over or with attachments); Compressor and Throttle Valve; Compressor, Common Receiver (3); Concrete Breaker or Hydro Hammer; Concrete Grinding Machine; Concrete Mixer or Paver 7S Series to and including 27 cu. ft.; Concrete Spreader; Concrete Curing Machine, Burlap Machine, Belting Machine and Sealing Machine; Concrete Wheel Saw; Conveyor Muck Cars (Haglund or Similar Type); Drills, All; Finishing Machine - Concrete; Greaser Engineer; Highlift Shovels or Front Endloader; Hoist - Sewer Dragging Machine; Hydraulic Boom Trucks (All Attachments); Hydro-Blaster; All Locomotives, Dinky; Pump Cretes; Squeeze Cretes-Screw Type Pumps, Gypsum Bulker and Pump; Roller, Asphalt; Rotary Snow Plows; Rototiller, Seaman, etc., self-propelled; Scoops - Tractor Drawn; Self-Propelled Compactor; Spreader - Chip - Stone, etc.; Scraper; Scraper - Prime Mover in Tandem (Regardless of Size); Tank Car Heater; Tractors, Push, Pulling Sheeps Foot, Disc, Compactor, etc.; Tug Boats.

Class 3. Boilers; Brooms, All Power Propelled; Cement Supply Tender; Compressor, Common Receiver (2); Concrete Mixer (Two Bag and Over); Conveyor, Portable; Farm-Type Tractors Used for Mowing, Seeding, etc.; Fireman on Boilers; Forklift Trucks; Grouting Machine; Hoists, Automatic; Hoists, All Elevators; Hoists, Tugger Single Drum; Jeep Diggers; Pipe Jacking Machines; Post-Hole Digger; Power Saw, Concrete Power Driven; Pug Mills; Rollers, other than asphalt; Seed and Straw Blower; Steam Generators; Stump Machine; Winch Trucks with "A" Frame; Work Boats; Tamper - Form-Motor Driven.

Class 4. Air Compressor; Combination - Small Equipment Operator; Directional Boring Machine; Generators; Heaters, Mechanical; Hydraulic Power Unit (Pile Driving, Extracting, or Drilling); Hydro-Blaster; Light Plants, All (1 through 5); Pumps, over 3" (1 to 3 not to exceed a total of 300 ft.); Pumps, Well Points; Tractaire; Welding Machines (2 through 5); Winches, 4 Small Electric Drill Winches.

Class 5. Bobcats (all); Brick Forklifts, Oilers.

TERRAZZO FINISHER

The handling of sand, cement, marble chips, and all other materials that may be used by the Mosaic Terrazzo Mechanic, and the mixing, grinding, grouting, cleaning and sealing of all Marble, Mosaic, and Terrazzo work, floors, base, stairs, and wainscoting by hand or machine, and in addition, assisting and aiding Marble, Masonic, and Terrazzo Mechanics.

Other Classifications of Work:

For definitions of classifications not otherwise set out, the Department generally has on file such definitions which are available. If a task to be performed is not subject to one of the classifications of pay set out, the Department will upon being contacted state which neighboring county has such a classification and provide such rate, such rate being deemed to exist by reference in this document. If no neighboring county rate applies to the task, the Department shall undertake a special determination, such special determination being then deemed to have existed under this determination. If a project requires these, or any classification not listed, please contact IDOL at 618/993-7271 for wage rates or clarifications.

LANDSCAPING

Landscaping work falls under the existing classifications for laborer, operating engineer and truck driver. The work performed by landscape plantsman and landscape laborer is covered by the existing classification of laborer. The work performed by landscape operators (regardless of equipment used or its size) is covered by the classifications of operating engineer. The work performed by landscape truck drivers (regardless of size of truck driven) is covered by the classifications of truck driver.

Kane County Prevailing Wage for August 2008

Trade Name	RG	TYP	C	Base	FRMAN	*M-F>8	OSA	OSH	H/W	Pensn	Vac	Trng
=====	==	==	=	=====	=====	=====	==	==	=====	=====	=====	=====
ASBESTOS ABT-GEN		ALL		34.750	35.250	1.5	1.5	2.0	8.830	6.170	0.000	0.270
ASBESTOS ABT-MEC		BLD		26.180	27.930	1.5	1.5	2.0	8.760	6.410	0.000	0.310
BOILERMAKER		BLD		39.450	43.000	2.0	2.0	2.0	6.720	8.490	0.000	0.300
BRICK MASON		BLD		38.030	41.830	1.5	1.5	2.0	8.000	9.970	0.000	0.550
CARPENTER		ALL		37.770	39.770	1.5	1.5	2.0	8.960	6.920	0.000	0.490
CEMENT MASON		ALL		39.000	41.000	2.0	1.5	2.0	7.250	10.81	0.000	0.150
CERAMIC TILE FNSHER		BLD		32.150	0.000	2.0	1.5	2.0	6.150	7.370	0.000	0.380
COMMUNICATION TECH	N	BLD		29.960	31.760	1.5	1.5	2.0	5.842	6.290	0.000	0.375
COMMUNICATION TECH	S	BLD		33.360	35.460	1.5	1.5	2.0	9.090	8.670	0.000	0.670
ELECTRIC PWR EQMT OP		ALL		29.180	37.490	1.5	1.5	2.0	4.750	8.180	0.000	0.220
ELECTRIC PWR GRNDMAN		ALL		22.610	37.490	1.5	1.5	2.0	4.750	6.330	0.000	0.170
ELECTRIC PWR LINEMAN		ALL		34.710	37.490	1.5	1.5	2.0	4.750	9.720	0.000	0.260
ELECTRIC PWR TRK DRV		ALL		23.350	37.490	1.5	1.5	2.0	4.750	6.540	0.000	0.180
ELECTRICIAN	N	ALL		40.470	44.510	1.5	1.5	2.0	9.920	9.300	0.000	0.500
ELECTRICIAN	S	BLD		40.390	44.430	1.5	1.5	2.0	8.890	10.10	0.000	0.810
ELEVATOR CONSTRUCTOR		BLD		43.925	49.420	2.0	2.0	2.0	8.775	6.960	2.640	0.000
FENCE ERECTOR		ALL		38.120	40.030	2.0	2.0	2.0	8.140	14.49	0.000	0.230
GLAZIER		BLD		37.000	38.500	1.5	1.5	2.0	7.340	12.05	0.000	0.690
HT/FROST INSULATOR		BLD		37.400	39.150	1.5	1.5	2.0	8.760	10.11	0.000	0.310
IRON WORKER		ALL		38.120	40.030	2.0	2.0	2.0	8.140	14.49	0.000	0.230
LABORER		ALL		34.750	35.500	1.5	1.5	2.0	8.870	6.130	0.000	0.270
LATHER		BLD		37.770	39.770	1.5	1.5	2.0	8.960	6.920	0.000	0.490
MACHINIST		BLD		40.530	42.530	1.5	1.5	2.0	7.000	7.670	0.650	0.000
MARBLE FINISHERS		ALL		28.650	0.000	1.5	1.5	2.0	7.920	9.970	0.000	0.550
MARBLE MASON		BLD		38.030	41.830	1.5	1.5	2.0	8.000	9.970	0.000	0.550
MATERIAL TESTER I		ALL		24.750	0.000	1.5	1.5	2.0	8.870	6.130	0.000	0.270
MATERIALS TESTER II		ALL		29.750	0.000	1.5	1.5	2.0	8.870	6.130	0.000	0.270
MILLWRIGHT		ALL		36.520	38.520	1.5	1.5	2.0	7.960	5.920	0.000	0.490
OPERATING ENGINEER		BLD	1	43.800	47.800	2.0	2.0	2.0	9.600	6.550	1.900	1.000
OPERATING ENGINEER		BLD	2	42.500	47.800	2.0	2.0	2.0	9.600	6.550	1.900	1.000
OPERATING ENGINEER		BLD	3	39.950	47.800	2.0	2.0	2.0	9.600	6.550	1.900	1.000
OPERATING ENGINEER		BLD	4	38.200	47.800	2.0	2.0	2.0	9.600	6.550	1.900	1.000
OPERATING ENGINEER		HWY	1	42.000	46.000	1.5	1.5	2.0	9.600	6.550	1.900	1.000
OPERATING ENGINEER		HWY	2	41.450	46.000	1.5	1.5	2.0	9.600	6.550	1.900	1.000
OPERATING ENGINEER		HWY	3	39.400	46.000	1.5	1.5	2.0	9.600	6.550	1.900	1.000
OPERATING ENGINEER		HWY	4	38.000	46.000	1.5	1.5	2.0	9.600	6.550	1.900	1.000
OPERATING ENGINEER		HWY	5	36.800	46.000	1.5	1.5	2.0	9.600	6.550	1.900	1.000
ORNAMNTL IRON WORKER		ALL		38.120	40.030	2.0	2.0	2.0	8.140	14.49	0.000	0.230
PAINTER		ALL		37.830	39.830	1.5	1.5	1.5	6.750	6.750	0.000	0.500
PAINTER SIGNS		BLD		28.970	32.520	1.5	1.5	1.5	2.600	2.310	0.000	0.000
PILEDRIVER		ALL		37.770	39.770	1.5	1.5	2.0	8.960	6.920	0.000	0.490
PIPEFITTER		BLD		39.500	41.500	1.5	1.5	2.0	9.200	10.24	0.000	1.060
PLASTERER		BLD		38.100	40.390	1.5	1.5	2.0	7.500	8.440	0.000	0.400
PLUMBER		BLD		39.500	41.500	1.5	1.5	2.0	9.200	10.24	0.000	1.060
ROOFER		BLD		35.000	38.000	1.5	1.5	2.0	6.800	3.870	0.000	0.330
SHEETMETAL WORKER		BLD		40.210	42.210	1.5	1.5	2.0	7.410	9.620	0.000	0.680
SIGN HANGER		BLD		26.070	27.570	1.5	1.5	2.0	3.800	3.550	0.000	0.000
SPRINKLER FITTER		BLD		40.500	42.500	1.5	1.5	2.0	8.500	6.850	0.000	0.500
STEEL ERECTOR		ALL		38.120	40.030	2.0	2.0	2.0	8.140	14.49	0.000	0.230
STONE MASON		BLD		38.030	41.830	1.5	1.5	2.0	8.000	9.970	0.000	0.550
TERRAZZO FINISHER		BLD		33.810	0.000	1.5	1.5	2.0	6.150	9.850	0.000	0.310
TERRAZZO MASON		BLD		37.390	40.390	1.5	1.5	2.0	6.150	11.11	0.000	0.350
TILE MASON		BLD		38.630	42.630	2.0	1.5	2.0	6.150	9.010	0.000	0.500
TRAFFIC SAFETY WRKR		HWY		24.300	25.900	1.5	1.5	2.0	3.780	1.875	0.000	0.000
TRUCK DRIVER		ALL	1	32.550	33.100	1.5	1.5	2.0	6.500	4.350	0.000	0.150
TRUCK DRIVER		ALL	2	32.700	33.100	1.5	1.5	2.0	6.500	4.350	0.000	0.150
TRUCK DRIVER		ALL	3	32.900	33.100	1.5	1.5	2.0	6.500	4.350	0.000	0.150
TRUCK DRIVER		ALL	4	33.100	33.100	1.5	1.5	2.0	6.500	4.350	0.000	0.150

mosaics, fiberglass, and all substitute materials, for tile made in tile-like units; all mixtures in tile like form of cement, metals, and other materials that are for and intended for use as a finished floor surface, stair treads, promenade roofs, walks, walls, ceilings, swimming pools, and all other places where tile is to form a finished interior or exterior. The mixing of all setting mortars including but not limited to thin-set mortars, epoxies, wall mud, and any other sand and cement mixtures or adhesives when used in the preparation, installation, repair, or maintenance of tile and/or similar materials. The handling and unloading of all sand, cement, lime, tile, fixtures, equipment, adhesives, or any other materials to be used in the preparation, installation, repair, or maintenance of tile and/or similar materials. Ceramic Tile Finishers shall fill all joints and voids regardless of method on all tile work, particularly and especially after installation of said tile work. Application of any and all protective coverings to all types of tile installations including, but not be limited to, all soap compounds, paper products, tapes, and all polyethylene coverings, plywood, masonite, cardboard, and any new type of products that may be used to protect tile installations, Blastrac equipment, and all floor scarifying equipment used in preparing floors to receive tile. The clean up and removal of all waste and materials. All demolition of existing tile floors and walls to be re-tiled.

COMMUNICATIONS TECHNICIAN

Construction, installation, maintenance and removal of telecommunication facilities (voice, sound, data and video), telephone, security systems, fire alarm systems that are a component of a multiplex system and share a common cable, and data inside wire, interconnect, terminal equipment, central offices, PABX and equipment, micro waves, V-SAT, bypass, CATV, WAN (wide area network), LAN (local area networks), and ISDN (integrated system digital network), pulling of wire in raceways, but not the installation of raceways.

MARBLE FINISHER

Loading and unloading trucks, distribution of all materials (all stone, sand, etc.), stocking of floors with material, performing all rigging for heavy work, the handling of all material that may be needed for the installation of such materials, building of scaffolding, polishing if needed, patching, waxing of material if damaged, pointing up, caulking, grouting and cleaning of marble, holding water on diamond or Carborundum blade or saw for setters cutting, use of tub saw or any other saw needed for preparation of material, drilling of holes for wires that anchor material set by setters, mixing up of molding plaster for installation of material, mixing up thin set for the installation of material, mixing up of sand to cement for the installatin of material and such other work as may be required in helping a Marble Setter in the handling of all material in the erection or installation of interior marble, slate, travertine, art marble, serpentine, alberene stone, blue stone, granite and other stones (meaning as to stone any foreign or domestic materials as are specified and used in building interiors and experiors and customarily known as stone in the trade), carrara, sanionyx, vitrolite and similar opaque glass and the laying of all marble tile, terrazzo tile, slate tile and precast tile, steps, risers treads, base, or any other materials that may be used as substitutes for any of the aforementioned materials and which are used on interior and experior which sare installed in a similar manner.

MATERIAL TESTER I: Hand coring and drilling for testing of materials;

field inspection of uncured concrete and asphalt.

MATERIAL TESTER II: Field inspection of welds, structural steel, fireproofing, masonry, soil, facade, reinforcing steel, formwork, cured concrete, and concrete and asphalt batch plants; adjusting proportions of bituminous mixtures.

TRAFFIC SAFETY - work associated with barricades, horses and drums used to reduce lane usage on highway work, the installation and removal of temporary lane markings, and the installation and removal of temporary road signs.

TRUCK DRIVER - BUILDING, HEAVY AND HIGHWAY CONSTRUCTION

Class 1. Two or three Axle Trucks. A-frame Truck when used for transportation purposes; Air Compressors and Welding Machines, including those pulled by cars, pick-up trucks and tractors; Ambulances; Batch Gate Lockers; Batch Hopperman; Car and Truck Washers; Carry-alls; Fork Lifts and Hoisters; Helpers; Mechanics Helpers and Greasers; Oil Distributors 2-man operation; Pavement Breakers; Pole Trailer, up to 40 feet; Power Mower Tractors; Self-propelled Chip Spreader; Skipman; Slurry Trucks, 2-man operation; Slurry Truck Conveyor Operation, 2 or 3 man; Teamsters; Unskilled dumpman; and Truck Drivers hauling warning lights, barricades, and portable toilets on the job site.

Class 2. Four axle trucks; Dump Crets and Adgetors under 7 yards; Dumpsters, Track Trucks, Euclids, Hug Bottom Dump Turnapulls or Turnatrailers when pulling other than self-loading equipment or similar equipment under 16 cubic yards; Mixer Trucks under 7 yards; Ready-mix Plant Hopper Operator, and Winch Trucks, 2 Axles.

Class 3. Five axle trucks; Dump Crets and Adgetors 7 yards and over; Dumpsters, Track Trucks, Euclids, Hug Bottom Dump Turnatrailers or turnapulls when pulling other than self-loading equipment or similar equipment over 16 cubic yards; Explosives and/or Fission Material Trucks; Mixer Trucks 7 yards or over; Mobile Cranes while in transit; Oil Distributors, 1-man operation; Pole Trailer, over 40 feet; Pole and Expandable Trailers hauling material over 50 feet long; Slurry trucks, 1-man operation; Winch trucks, 3 axles or more; Mechanic--Truck Welder and Truck Painter.

Class 4. Six axle trucks; Dual-purpose vehicles, such as mounted crane trucks with hoist and accessories; Foreman; Master Mechanic; Self-loading equipment like P.B. and trucks with scoops on the front.

OPERATING ENGINEERS - BUILDING

Class 1. Mechanic; Asphalt Plant; Asphalt Spreader; Autograde; Backhoes with Caisson attachment; Batch Plant; Benoto; Boiler and Throttle Valve; Caisson Rigs; Central Redi-Mix Plant; Combination Back Hoe Front End-loader Machine; Compressor and Throttle Valve; Concrete Breaker (Truck Mounted); Concrete Conveyor; Concrete Paver; Concrete Placer; Concrete Placing Boom; Concrete Pump (Truck Mounted); Concrete Tower; Cranes, All; Cranes, Hammerhead; Cranes, (GCI and similar Type); Creter Crane; Crusher, Stone, etc.; Derricks, All; Derricks, Traveling; Formless Curb and Gutter Machine; Grader, Elevating; Grouting Machines; Highlift Shovels or Front Endloader 2-1/4 yd. and over; Hoists, Elevators, outside type rack and pinion and similar machines; Hoists, one, two and three Drum; Hoists, Two Tugger One Floor; Hydraulic Backhoes; Hydraulic Boom Trucks; Hydro Vac (and similar equipment); Locomotives, All; Motor Patrol; Pile Drivers and Skid Rig; Post Hole Digger; Pre-Stress Machine; Pump Cretes Dual Ram; Pump Cretes; Squeeze Cretes-screw Type Pumps; Raised and Blind

Hole Drill; Roto Mill Grinder; Scoops - Tractor Drawn; Slip-form Paver; Straddle Buggies; Tournapull; Tractor with Boom and Side Boom; Trenching Machines.

Class 2. Boilers; Broom, All Power Propelled; Bulldozers; Concrete Mixer (Two Bag and Over); Conveyor, Portable; Forklift Trucks; Greaser Engineer; Highlift Shovels or Front Endloaders under 2-1/4 yd.; Hoists, Automatic; Hoists, inside Freight Elevators; Hoists, Sewer Dragging Machine; Hoists, Tugger Single Drum; Laser Screed; Rock Drill (self-propelled); Rock Drill (truck mounted); Rollers, All; Steam Generators; Tractors, All; Tractor Drawn Vibratory Roller; Winch Trucks with "A" Frame.

Class 3. Air Compressor; Combination - Small Equipment Operator; Generators; Heaters, Mechanical; Hoists, Inside Elevators - (Rheostat Manual Controlled); Hydraulic Power Units (Pile Driving, Extracting, and Drilling); Pumps, over 3" (1 to 3 not to exceed a total of 300 ft.); Pumps, Well Points; Welding Machines (2 through 5); Winches, 4 small Electric Drill Winches; Bobcat (up to and including 3/4 cu. yd.).

Class 4. Bobcats and/or other Skid Steer Loaders; Oilers; and Brick Forklift.

OPERATING ENGINEERS - HEAVY AND HIGHWAY CONSTRUCTION

Class 1. Craft Foreman; Asphalt Plant; Asphalt Heater and Planer Combination; Asphalt Heater Scarfire; Asphalt Spreader; Autograder/GOMACO or other similar type machines; ABG Paver; Backhoes with Caisson attachment; Ballast Regulator; Belt Loader; Caisson Rigs; Car Dumper; Central Redi-Mix Plant; Combination Backhoe Front Endloader Machine, (1 cu. yd. Backhoe Bucket or over or with attachments); Concrete Breaker (Truck Mounted); Concrete Conveyor; Concrete Paver over 27E cu. ft.; Concrete Placer; Concrete Tube Float; Cranes, all attachments; Cranes, Hammerhead, Linden, Peco & Machines of a like nature; Crete Crane; Crusher, Stone, etc.; Derricks, All; Derrick Boats; Derricks, Traveling; Dowell machine with Air Compressor; Dredges; Field Mechanic-Welder; Formless Curb and Gutter Machine; Gradall and Machines of a like nature; Grader, Elevating; Grader, Motor Grader, Motor Patrol, Auto Patrol, Form Grader, Pull Grader, Subgrader; Guard Rail Post Driver Mounted; Hoists, One, Two and Three Drum; Hydraulic Backhoes; Backhoes with shear attachments; Mucking Machine; Pile Drivers and Skid Rig; Pre-Stress Machine; Pump Cretes Dual Ram; Rock Drill - Crawler or Skid Rig; Rock Drill - Truck Mounted; Roto Mill Grinder; Slip-Form Paver; Soil Test Drill Rig (Truck Mounted); Straddle Buggies; Hydraulic Telescoping Form (Tunnel); Tractor Drawn Belt Loader (with attached pusher - two engineers); Tractor with Boom; Tractaire with Attachments; Trenching Machine; Truck Mounted Concrete Pump with Boom; Raised or Blind Hole; Drills (Tunnel Shaft); Underground Boring and/or Mining Machines; Wheel Excavator; Widener (APSCO).

Class 2. Batch Plant; Bituminous Mixer; Boiler and Throttle Valve; Bulldozers; Car Loader Trailing Conveyors; Combination Backhoe Front Endloader Machine (less than 1 cu. yd. Backhoe Bucket or over or with attachments); Compressor and Throttle Valve; Compressor, Common Receiver (3); Concrete Breaker or Hydro Hammer; Concrete Grinding Machine; Concrete Mixer or Paver 7S Series to and including 27 cu. ft.; Concrete Spreader; Concrete Curing Machine, Burlap Machine, Belting Machine and Sealing Machine; Concrete Wheel Saw; Conveyor Muck Cars (Haglund or Similar Type); Drills, All; Finishing Machine - Concrete; Greaser Engineer; Highlift Shovels or Front Endloader; Hoist - Sewer Dragging Machine; Hydraulic Boom Trucks (All

Attachments); Hydro-Blaster; All Locomotives, Dinky; Pump Cretes; Squeeze Cretes-Screw Type Pumps, Gypsum Bulker and Pump; Roller, Asphalt; Rotary Snow Plows; Rototiller, Seaman, etc., self-propelled; Scoops - Tractor Drawn; Self-Propelled Compactor; Spreader - Chip - Stone, etc.; Scraper; Scraper - Prime Mover in Tandem (Regardless of Size); Tank Car Heater; Tractors, Push, Pulling Sheeps Foot, Disc, Compactor, etc.; Tug Boats.

Class 3. Boilers; Brooms, All Power Propelled; Cement Supply Tender; Compressor, Common Receiver (2); Concrete Mixer (Two Bag and Over); Conveyor, Portable; Farm-Type Tractors Used for Mowing, Seeding, etc.; Fireman on Boilers; Forklift Trucks; Grouting Machine; Hoists, Automatic; Hoists, All Elevators; Hoists, Tugger Single Drum; Jeep Diggers; Pipe Jacking Machines; Post-Hole Digger; Power Saw, Concrete Power Driven; Pug Mills; Rollers, other than asphalt; Seed and Straw Blower; Steam Generators; Stump Machine; Winch Trucks with "A" Frame; Work Boats; Tamper - Form-Motor Driven.

Class 4. Air Compressor; Combination - Small Equipment Operator; Directional Boring Machine; Generators; Heaters, Mechanical; Hydraulic Power Unit (Pile Driving, Extracting, or Drilling); Hydro-Blaster; Light Plants, All (1 through 5); Pumps, over 3" (1 to 3 not to exceed a total of 300 ft.); Pumps, Well Points; Tractaire; Welding Machines (2 through 5); Winches, 4 Small Electric Drill Winches.

Class 5. Bobcats (all); Brick Forklifts; Oilers.

TERRAZZO FINISHER

The handling of sand, cement, marble chips, and all other materials that may be used by the Mosaic Terrazzo Mechanic, and the mixing, grinding, grouting, cleaning and sealing of all Marble, Mosaic, and Terrazzo work, floors, base, stairs, and wainscoting by hand or machine, and in addition, assisting and aiding Marble, Masonic, and Terrazzo Mechanics.

Other Classifications of Work:

For definitions of classifications not otherwise set out, the Department generally has on file such definitions which are available. If a task to be performed is not subject to one of the classifications of pay set out, the Department will upon being contacted state which neighboring county has such a classification and provide such rate, such rate being deemed to exist by reference in this document. If no neighboring county rate applies to the task, the Department shall undertake a special determination, such special determination being then deemed to have existed under this determination. If a project requires these, or any classification not listed, please contact IDOL at 618/993-7271 for wage rates or clarifications.

LANDSCAPING

Landscaping work falls under the existing classifications for laborer, operating engineer and truck driver. The work performed by landscape plantsman and landscape laborer is covered by the existing classification of laborer. The work performed by landscape operators (regardless of equipment used or its size) is covered by the classifications of operating engineer. The work performed by landscape truck drivers (regardless of size of truck driven) is covered by the classifications of truck driver.

Lake County Prevailing Wage for August 2008

Trade Name	RG	TYP	C	Base	FRMAN	*M-F>8	OSA	OSH	H/W	Pensn	Vac	Trng
=====	==	==	=	=====	=====	=====	==	==	=====	=====	=====	=====
ASBESTOS ABT-GEN		ALL		34.750	35.250	1.5	1.5	2.0	8.830	6.170	0.000	0.270
ASBESTOS ABT-MEC		BLD		26.180	27.930	1.5	1.5	2.0	8.760	6.410	0.000	0.310
BOILERMAKER		BLD		39.450	43.000	2.0	2.0	2.0	6.720	8.490	0.000	0.300
BRICK MASON		BLD		38.030	41.830	1.5	1.5	2.0	8.000	9.970	0.000	0.550
CARPENTER		ALL		37.770	39.770	1.5	1.5	2.0	8.960	6.910	0.000	0.490
CEMENT MASON		ALL		38.500	40.500	2.0	1.5	2.0	8.250	10.33	0.000	0.150
CERAMIC TILE FNSHER		BLD		32.150	0.000	2.0	1.5	2.0	6.150	7.370	0.000	0.380
COMMUNICATION TECH		BLD		31.400	33.500	1.5	1.5	2.0	8.170	8.480	1.570	0.460
ELECTRIC PWR EQMT OP		ALL		29.180	37.490	1.5	1.5	2.0	4.750	8.180	0.000	0.220
ELECTRIC PWR GRNDMAN		ALL		22.610	37.490	1.5	1.5	2.0	4.750	6.330	0.000	0.170
ELECTRIC PWR LINEMAN		ALL		34.710	37.490	1.5	1.5	2.0	4.750	9.720	0.000	0.260
ELECTRIC PWR TRK DRV		ALL		23.350	37.490	1.5	1.5	2.0	4.750	6.540	0.000	0.180
ELECTRICIAN		BLD		36.680	40.350	1.5	1.5	2.0	10.27	11.01	1.470	0.520
ELEVATOR CONSTRUCTOR		BLD		43.925	49.420	2.0	2.0	2.0	8.775	6.960	2.640	0.000
FENCE ERECTOR		ALL		28.640	30.140	1.5	1.5	2.0	7.750	5.970	0.000	0.350
GLAZIER		BLD		37.000	38.500	1.5	1.5	2.0	7.340	12.05	0.000	0.690
HT/FROST INSULATOR		BLD		37.400	39.150	1.5	1.5	2.0	8.760	10.11	0.000	0.310
IRON WORKER		ALL		40.250	42.250	2.0	2.0	2.0	9.950	14.74	0.000	0.300
LABORER		ALL		34.750	35.500	1.5	1.5	2.0	8.830	6.170	0.000	0.270
LATHER		BLD		37.770	39.770	1.5	1.5	2.0	8.960	6.910	0.000	0.490
MACHINIST		BLD		40.530	42.530	1.5	1.5	2.0	7.000	7.670	0.650	0.000
MARBLE FINISHERS		ALL		28.650	0.000	1.5	1.5	2.0	7.920	9.970	0.000	0.550
MARBLE MASON		BLD		38.030	41.830	1.5	1.5	2.0	8.000	9.970	0.000	0.550
MATERIAL TESTER I		ALL		24.750	0.000	1.5	1.5	2.0	8.830	6.170	0.000	0.270
MATERIALS TESTER II		ALL		29.750	0.000	1.5	1.5	2.0	8.830	6.170	0.000	0.270
MILLWRIGHT		ALL		37.770	39.770	1.5	1.5	2.0	8.960	6.910	0.000	0.490
OPERATING ENGINEER		BLD	1	43.800	47.800	2.0	2.0	2.0	9.600	6.550	1.900	1.000
OPERATING ENGINEER		BLD	2	42.500	47.800	2.0	2.0	2.0	9.600	6.550	1.900	1.000
OPERATING ENGINEER		BLD	3	39.950	47.800	2.0	2.0	2.0	9.600	6.550	1.900	1.000
OPERATING ENGINEER		BLD	4	38.200	47.800	2.0	2.0	2.0	9.600	6.550	1.900	1.000
OPERATING ENGINEER		FLT	1	47.250	47.250	1.5	1.5	2.0	6.850	5.600	1.900	0.000
OPERATING ENGINEER		FLT	2	45.750	47.250	1.5	1.5	2.0	6.850	5.600	1.900	0.000
OPERATING ENGINEER		FLT	3	40.700	47.250	1.5	1.5	2.0	6.850	5.600	1.900	0.000
OPERATING ENGINEER		FLT	4	33.850	47.250	1.5	1.5	2.0	6.850	5.600	1.900	0.000
OPERATING ENGINEER		HWY	1	42.000	46.000	1.5	1.5	2.0	9.600	6.550	1.900	1.000
OPERATING ENGINEER		HWY	2	41.450	46.000	1.5	1.5	2.0	9.600	6.550	1.900	1.000
OPERATING ENGINEER		HWY	3	39.400	46.000	1.5	1.5	2.0	9.600	6.550	1.900	1.000
OPERATING ENGINEER		HWY	4	38.000	46.000	1.5	1.5	2.0	9.600	6.550	1.900	1.000
OPERATING ENGINEER		HWY	5	36.800	46.000	1.5	1.5	2.0	9.600	6.550	1.900	1.000
ORNAMNTL IRON WORKER		ALL		39.050	41.300	2.0	2.0	2.0	7.950	13.19	0.000	0.500
PAINTER		ALL		36.900	41.510	1.5	1.5	1.5	7.350	8.400	0.000	0.420
PAINTER SIGNS		BLD		28.970	32.520	1.5	1.5	1.5	2.600	2.310	0.000	0.000
PILEDRIVER		ALL		37.770	39.770	1.5	1.5	2.0	8.960	6.910	0.000	0.490
PIPEFITTER		BLD		40.000	42.000	1.5	1.5	2.0	8.660	7.550	0.000	1.120
PLASTERER		BLD		36.840	39.050	2.0	1.5	2.0	8.250	10.33	0.000	0.150
PLUMBER		BLD		39.500	41.500	1.5	1.5	2.0	9.040	8.250	0.000	0.400
ROOFER		BLD		35.000	38.000	1.5	1.5	2.0	6.800	3.870	0.000	0.330
SHEETMETAL WORKER		BLD		33.400	36.070	1.5	1.5	2.0	6.460	7.850	0.000	0.590
SIGN HANGER		BLD		26.510	27.360	1.5	1.5	2.0	4.200	2.280	0.000	0.000
SPRINKLER FITTER		BLD		40.500	42.500	1.5	1.5	2.0	8.500	6.850	0.000	0.500
STEEL ERECTOR		ALL		40.250	42.250	2.0	2.0	2.0	9.950	14.74	0.000	0.300
STONE MASON		BLD		38.030	41.830	1.5	1.5	2.0	8.000	9.970	0.000	0.550
TERRAZZO FINISHER		BLD		33.810	0.000	1.5	1.5	2.0	6.150	9.850	0.000	0.310
TERRAZZO MASON		BLD		37.390	40.390	1.5	1.5	2.0	6.150	11.11	0.000	0.350
TILE MASON		BLD		38.630	42.630	2.0	1.5	2.0	6.150	9.010	0.000	0.500
TRAFFIC SAFETY WRKR		HWY		24.300	25.900	1.5	1.5	2.0	3.780	1.875	0.000	0.000
TRUCK DRIVER		ALL	1	32.200	32.750	1.5	1.5	2.0	5.700	5.500	0.000	0.150
TRUCK DRIVER		ALL	2	32.350	32.750	1.5	1.5	2.0	5.700	5.500	0.000	0.150

TRUCK DRIVER	ALL	3	32.550	32.750	1.5	1.5	2.0	5.700	5.500	0.000	0.150
TRUCK DRIVER	ALL	4	32.750	32.750	1.5	1.5	2.0	5.700	5.500	0.000	0.150
TUCKPOINTER	BLD		38.200	39.200	1.5	1.5	2.0	6.580	9.550	0.000	0.280

Legend:

M-F>8 (Overtime is required for any hour greater than 8 worked each day, Monday through Friday.)

OSA (Overtime is required for every hour worked on Saturday)

OSH (Overtime is required for every hour worked on Sunday and Holidays)

H/W (Health & Welfare Insurance)

Pensn (Pension)

Vac (Vacation)

Trng (Training)

Explanations

LAKE COUNTY

The following list is considered as those days for which holiday rates of wages for work performed apply: New Years Day, Memorial/Decoration Day, Fourth of July, Day, Veterans Day, Thanksgiving Day, Christmas Day. Generally, any of these holidays which fall on a Sunday is celebrated on the following Monday. This then makes work performed on that Monday payable at the appropriate overtime rate for holiday pay. Common practice in a given local may alter certain days of celebration such as the day after Thanksgiving for Veterans Day. If in doubt, please check with IDOL.

EXPLANATION OF CLASSES

ASBESTOS - GENERAL - removal of asbestos material/mold and hazardous materials from any place in a building, including mechanical systems where those mechanical systems are to be removed. This includes the removal of asbestos materials/mold and hazardous materials from ductwork or pipes in a building when the building is to be demolished at the time or at some close future date.

ASBESTOS - MECHANICAL - removal of asbestos material from mechanical systems, such as pipes, ducts, and boilers, where the mechanical systems are to remain.

CERAMIC TILE FINISHER

The grouting, cleaning, and polishing of all classes of tile, whether for interior or exterior purposes, all burned, glazed or unglazed products; all composition materials, granite tiles, warning detectable tiles, cement tiles, epoxy composite materials, pavers, glass, mosaics, fiberglass, and all substitute materials, for tile made in tile-like units; all mixtures in tile like form of cement, metals, and other materials that are for and intended for use as a finished floor surface, stair treads, promenade roofs, walks, walls, ceilings, swimming pools, and all other places where tile is to form a finished

interior or exterior. The mixing of all setting mortars including but not limited to thin-set mortars, epoxies, wall mud, and any other sand and cement mixtures or adhesives when used in the preparation, installation, repair, or maintenance of tile and/or similar materials. The handling and unloading of all sand, cement, lime, tile, fixtures, equipment, adhesives, or any other materials to be used in the preparation, installation, repair, or maintenance of tile and/or similar materials. Ceramic Tile Finishers shall fill all joints and voids regardless of method on all tile work, particularly and especially after installation of said tile work. Application of any and all protective coverings to all types of tile installations including, but not be limited to, all soap compounds, paper products, tapes, and all polyethylene coverings, plywood, masonite, cardboard, and any new type of products that may be used to protect tile installations, Blastrac equipment, and all floor scarifying equipment used in preparing floors to receive tile. The clean up and removal of all waste and materials. All demolition of existing tile floors and walls to be re-tiled.

COMMUNICATION TECHNICIAN

Low voltage construction, installation, maintenance and removal of telecommunication facilities (voice, sound, data and video) including outside plant, telephone, security systems and data inside wire, interconnect, terminal equipment, central offices, PABX, fiber optic cable and equipment, micro waves, V-SAT, bypass, CATV, WAN (wide area network), LAN (local area networks), and ISDN (integrated system digital network), pulling of wire in raceways, but not the installation of raceways.

MARBLE FINISHER

Loading and unloading trucks, distribution of all materials (all stone, sand, etc.), stocking of floors with material, performing all rigging for heavy work, the handling of all material that may be needed for the installation of such materials, building of scaffolding, polishing if needed, patching, waxing of material if damaged, pointing up, caulking, grouting and cleaning of marble, holding water on diamond or Carborundum blade or saw for setters cutting, use of tub saw or any other saw needed for preparation of material, drilling of holes for wires that anchor material set by setters, mixing up of molding plaster for installation of material, mixing up thin set for the installation of material, mixing up of sand to cement for the installation of material and such other work as may be required in helping a Marble Setter in the handling of all material in the erection or installation of interior marble, slate, travertine, art marble, serpentine, alberene stone, blue stone, granite and other stones (meaning as to stone any foreign or domestic materials as are specified and used in building interiors and exteriors and customarily known as stone in the trade), carrara, sanionyx, vitrolite and similar opaque glass and the laying of all marble tile, terrazzo tile, slate tile and precast tile, steps, risers treads, base, or any other materials that may be used as substitutes for any of the aforementioned materials and which are used on interior and exterior which are installed in a similar manner.

MATERIAL TESTER I: Hand coring and drilling for testing of materials; field inspection of uncured concrete and asphalt.

MATERIAL TESTER II: Field inspection of welds, structural steel, fireproofing, masonry, soil, facade, reinforcing steel, formwork, cured concrete, and concrete and asphalt batch plants; adjusting proportions of bituminous mixtures.

TRAFFIC SAFETY - work associated with barricades, horses and drums used to reduce lane usage on highway work, the installation and removal of temporary lane markings, and the installation and removal of temporary road signs.

TRUCK DRIVER - BUILDING, HEAVY AND HIGHWAY CONSTRUCTION

Class 1. Two or three Axle Trucks. A-frame Truck when used for transportation purposes; Air Compressors and Welding Machines, including those pulled by cars, pick-up trucks and tractors; Ambulances; Batch Gate Lockers; Batch Hopperman; Car and Truck Washers; Carry-alls; Fork Lifts and Hoisters; Helpers; Mechanics Helpers and Greasers; Oil Distributors 2-man operation; Pavement Breakers; Pole Trailer, up to 40 feet; Power Mower Tractors; Self-propelled Chip Spreader; Skipman; Slurry Trucks, 2-man operation; Slurry Truck Conveyor Operation, 2 or 3 man; Teamsters; Unskilled dumpman; and Truck Drivers hauling warning lights, barricades, and portable toilets on the job site.

Class 2. Four axle trucks; Dump Crets and Adgetors under 7 yards; Dumpsters, Track Trucks, Euclids, Hug Bottom Dump Turnapulls or Turnatrailers when pulling other than self-loading equipment or similar equipment under 16 cubic yards; Mixer Trucks under 7 yards; Ready-mix Plant Hopper Operator, and Winch Trucks, 2 Axles.

Class 3. Five axle trucks; Dump Crets and Adgetors 7 yards and over; Dumpsters, Track Trucks, Euclids, Hug Bottom Dump Turnatrailers or turnapulls when pulling other than self-loading equipment or similar equipment over 16 cubic yards; Explosives and/or Fission Material Trucks; Mixer Trucks 7 yards or over; Mobile Cranes while in transit; Oil Distributors, 1-man operation; Pole Trailer, over 40 feet; Pole and Expandable Trailers hauling material over 50 feet long; Slurry trucks, 1-man operation; Winch trucks, 3 axles or more; Mechanic--Truck Welder and Truck Painter.

Class 4. Six axle trucks; Dual-purpose vehicles, such as mounted crane trucks with hoist and accessories; Foreman; Master Mechanic; Self-loading equipment like P.B. and trucks with scoops on the front.

OPERATING ENGINEERS - BUILDING

Class 1. Mechanic; Asphalt Plant; Asphalt Spreader; Autograde; Backhoes with Caisson attachment; Batch Plant; Benoto; Boiler and Throttle Valve; Caisson Rigs; Central Redi-Mix Plant; Combination Back Hoe Front End-loader Machine; Compressor and Throttle Valve; Concrete Breaker (Truck Mounted); Concrete Conveyor; Concrete Paver; Concrete Placer; Concrete Placing Boom; Concrete Pump (Truck Mounted); Concrete Tower; Cranes, All; Cranes, Hammerhead; Cranes, (GCI and similar Type); Creter Crane; Crusher, Stone, etc.; Derricks, All; Derricks, Traveling; Formless Curb and Gutter Machine; Grader, Elevating; Grouting Machines; Highlift Shovels or Front Endloader 2-1/4 yd. and over; Hoists, Elevators, outside type rack and pinion and similar machines; Hoists, one, two and three Drum; Hoists, Two Tugger One Floor; Hydraulic Backhoes; Hydraulic Boom Trucks; Hydro Vac (and similar equipment); Locomotives, All; Motor Patrol; Pile Drivers and Skid Rig; Post Hole Digger; Pre-Stress Machine; Pump Cretes Dual Ram; Pump Cretes; Squeeze Cretes-screw Type Pumps; Raised and Blind Hole Drill; Roto Mill Grinder; Scoops - Tractor Drawn; Slip-form Paver; Straddle Buggies; Tournapull; Tractor with Boom and Side Boom; Trenching Machines.

Class 2. Boilers; Broom, All Power Propelled; Bulldozers; Concrete Mixer (Two Bag and Over); Conveyor, Portable; Forklift Trucks; Greaser Engineer; Highlift Shovels or Front Endloaders under 2-1/4

yd.; Hoists, Automatic; Hoists, inside Freight Elevators; Hoists, Sewer Dragging Machine; Hoists, Tugger Single Drum; Laser Screed; Rock Drill (self-propelled); Rock Drill (truck mounted); Rollers, All; Steam Generators; Tractors, All; Tractor Drawn Vibratory Roller; Winch Trucks with "A" Frame.

Class 3. Air Compressor; Combination - Small Equipment Operator; Generators; Heaters, Mechanical; Hoists, Inside Elevators - (Rheostat Manual Controlled); Hydraulic Power Units (Pile Driving, Extracting, and Drilling); Pumps, over 3" (1 to 3 not to exceed a total of 300 ft.); Pumps, Well Points; Welding Machines (2 through 5); Winches, 4 small Electric Drill Winches; Bobcat (up to and including 3/4 cu. yd.).

Class 4. Bobcats and/or other Skid Steer Loaders; Oilers; and Brick Forklift.

OPERATING ENGINEERS - FLOATING

Class 1. Craft foreman (Master Mechanic), diver/wet tender, engineer (hydraulic dredge).

Class 2. Crane/backhoe operator, mechanic/welder, assistant engineer (hydraulic dredge), leverman (hydraulic dredge), and diver tender.

Class 3. Deck equipment operator (machineryman), maintenance of crane (over 50 ton capacity) or backhoe (96,000 pounds or more), tug/launch operator, loader, dozer and like equipment on barge, breakwater wall, slip/dock or scow, deck machinery, etc.

Class 4. Deck equipment operator (machineryman/fireman), (4 equipment units or more) and crane maintenance 50 ton capacity and under or backhoe weighing 96,000 pounds or less, assistant tug operator.

OPERATING ENGINEERS - HEAVY AND HIGHWAY CONSTRUCTION

Class 1. Craft Foreman; Asphalt Plant; Asphalt Heater and Planer Combination; Asphalt Heater Scarfire; Asphalt Spreader; Autograder/GOMACO or other similar type machines; ABG Paver; Backhoes with Caisson attachment; Ballast Regulator; Belt Loader; Caisson Rigs; Car Dumper; Central Redi-Mix Plant; Combination Backhoe Front Endloader Machine, (1 cu. yd. Backhoe Bucket or over or with attachments); Concrete Breaker (Truck Mounted); Concrete Conveyor; Concrete Paver over 27E cu. ft.; Concrete Placer; Concrete Tube Float; Cranes, all attachments; Cranes, Hammerhead, Linden, Peco & Machines of a like nature; Crete Crane; Crusher, Stone, etc.; Derricks, All; Derrick Boats; Derricks, Traveling; Dowell machine with Air Compressor; Dredges; Field Mechanic-Welder; Formless Curb and Gutter Machine; Gradall and Machines of a like nature; Grader, Elevating; Grader, Motor Grader, Motor Patrol, Auto Patrol, Form Grader, Pull Grader, Subgrader; Guard Rail Post Driver Mounted; Hoists, One, Two and Three Drum; Hydraulic Backhoes; Backhoes with shear attachments; Mucking Machine; Pile Drivers and Skid Rig; Pre-Stress Machine; Pump Cretes Dual Ram; Rock Drill - Crawler or Skid Rig; Rock Drill - Truck Mounted; Roto Mill Grinder; Slip-Form Paver; Soil Test Drill Rig (Truck Mounted); Straddle Buggies; Hydraulic Telescoping Form (Tunnel); Tractor Drawn Belt Loader (with attached pusher - two engineers); Tractor with Boom; Tractaire with Attachments; Trenching Machine; Truck Mounted Concrete Pump with Boom; Raised or Blind Hole; Drills (Tunnel Shaft); Underground Boring and/or Mining Machines; Wheel Excavator; Widener (APSCO).

Class 2. Batch Plant; Bituminous Mixer; Boiler and Throttle Valve; Bulldozers; Car Loader Trailing Conveyors; Combination Backhoe Front Endloader Machine (less than 1 cu. yd. Backhoe Bucket or over or with

attachments); Compressor and Throttle Valve; Compressor, Common Receiver (3); Concrete Breaker or Hydro Hammer; Concrete Grinding Machine; Concrete Mixer or Paver 7S Series to and including 27 cu. ft.; Concrete Spreader; Concrete Curing Machine, Burlap Machine, Belting Machine and Sealing Machine; Concrete Wheel Saw; Conveyor Muck Cars (Haglund or Similar Type); Drills, All; Finishing Machine - Concrete; Greaser Engineer; Highlift Shovels or Front Endloader; Hoist - Sewer Dragging Machine; Hydraulic Boom Trucks (All Attachments); Hydro-Blaster; All Locomotives, Dinky; Pump Cretes; Squeeze Cretes-Screw Type Pumps, Gypsum Bulker and Pump; Roller, Asphalt; Rotary Snow Plows; Rototiller, Seaman, etc., self-propelled; Scoops - Tractor Drawn; Self-Propelled Compactor; Spreader - Chip - Stone, etc.; Scraper; Scraper - Prime Mover in Tandem (Regardless of Size); Tank Car Heater; Tractors, Push, Pulling Sheeps Foot, Disc, Compactor, etc.; Tug Boats.

Class 3. Boilers; Brooms, All Power Propelled; Cement Supply Tender; Compressor, Common Receiver (2); Concrete Mixer (Two Bag and Over); Conveyor, Portable; Farm-Type Tractors Used for Mowing, Seeding, etc.; Fireman on Boilers; Forklift Trucks; Grouting Machine; Hoists, Automatic; Hoists, All Elevators; Hoists, Tugger Single Drum; Jeep Diggers; Pipe Jacking Machines; Post-Hole Digger; Power Saw, Concrete Power Driven; Pug Mills; Rollers, other than asphalt; Seed and Straw Blower; Steam Generators; Stump Machine; Winch Trucks with "A" Frame; Work Boats; Tamper - Form-Motor Driven.

Class 4. Air Compressor; Combination - Small Equipment Operator; Directional Boring Machine; Generators; Heaters, Mechanical; Hydraulic Power Unit (Pile Driving, Extracting, or Drilling); Hydro-Blaster; Light Plants, All (1 through 5); Pumps, over 3" (1 to 3 not to exceed a total of 300 ft.); Pumps, Well Points; Tractaire; Welding Machines (2 through 5); Winches, 4 Small Electric Drill Winches.

Class 5. Bobcats (all); Brick Forklifts; Oilers.

TERRAZZO FINISHER

The handling of sand, cement, marble chips, and all other materials that may be used by the Mosaic Terrazzo Mechanic, and the mixing, grinding, grouting, cleaning and sealing of all Marble, Mosaic, and Terrazzo work, floors, base, stairs, and wainscoting by hand or machine, and in addition, assisting and aiding Marble, Masonic, and Terrazzo Mechanics.

Other Classifications of Work:

For definitions of classifications not otherwise set out, the Department generally has on file such definitions which are available. If a task to be performed is not subject to one of the classifications of pay set out, the Department will upon being contacted state which neighboring county has such a classification and provide such rate, such rate being deemed to exist by reference in this document. If no neighboring county rate applies to the task, the Department shall undertake a special determination, such special determination being then deemed to have existed under this determination. If a project requires these, or any classification not listed, please contact IDOL at 618/993-7271 for wage rates or clarifications.

LANDSCAPING

Landscaping work falls under the existing classifications for laborer, operating engineer and truck driver. The work performed by landscape

plantsman and landscape laborer is covered by the existing classification of laborer. The work performed by landscape operators (regardless of equipment used or its size) is covered by the classifications of operating engineer. The work performed by landscape truck drivers (regardless of size of truck driven) is covered by the classifications of truck driver.

Mchenry County Prevailing Wage for August 2008

Trade Name	RG	TYP	C	Base	FRMAN	*M-F>8	OSA	OSH	H/W	Pensn	Vac	Trng
=====	==	==	=	=====	=====	=====	==	==	=====	=====	=====	=====
ASBESTOS ABT-GEN		ALL		34.750	35.250	1.5	1.5	2.0	8.830	6.170	0.000	0.270
ASBESTOS ABT-MEC		BLD		26.180	27.930	1.5	1.5	2.0	8.760	6.410	0.000	0.310
BOILERMAKER		BLD		39.450	43.000	2.0	2.0	2.0	6.720	8.490	0.000	0.300
BRICK MASON		BLD		38.030	41.830	1.5	1.5	2.0	8.000	9.970	0.000	0.550
CARPENTER		ALL		37.770	39.770	1.5	1.5	2.0	8.960	6.920	0.000	0.490
CEMENT MASON		ALL		39.000	41.000	2.0	1.5	2.0	7.250	10.81	0.000	0.150
CERAMIC TILE FNSHER		BLD		32.150	0.000	2.0	1.5	2.0	6.150	7.370	0.000	0.380
COMMUNICATION TECH		BLD		29.960	31.760	1.5	1.5	2.0	5.842	6.290	0.000	0.375
ELECTRIC PWR EQMT OP		ALL		29.180	37.490	1.5	1.5	2.0	4.750	8.180	0.000	0.220
ELECTRIC PWR GRNDMAN		ALL		22.610	37.490	1.5	1.5	2.0	4.750	6.330	0.000	0.170
ELECTRIC PWR LINEMAN		ALL		34.710	37.490	1.5	1.5	2.0	4.750	9.720	0.000	0.260
ELECTRIC PWR TRK DRV		ALL		23.350	37.490	1.5	1.5	2.0	4.750	6.540	0.000	0.180
ELECTRICIAN		ALL		40.470	44.510	1.5	1.5	2.0	9.920	9.300	0.000	0.500
ELEVATOR CONSTRUCTOR		BLD		43.925	49.420	2.0	2.0	2.0	8.775	6.960	2.640	0.000
FENCE ERECTOR	E	ALL		28.640	30.140	1.5	1.5	2.0	7.750	5.970	0.000	0.350
FENCE ERECTOR	S	ALL		38.120	40.030	2.0	2.0	2.0	8.140	14.49	0.000	0.230
GLAZIER		BLD		37.000	38.500	1.5	1.5	2.0	7.340	12.05	0.000	0.690
HT/FROST INSULATOR		BLD		37.400	39.150	1.5	1.5	2.0	8.760	10.11	0.000	0.310
IRON WORKER	E	ALL		40.250	42.250	2.0	2.0	2.0	9.950	14.74	0.000	0.300
IRON WORKER	S	ALL		38.120	40.030	2.0	2.0	2.0	8.140	14.49	0.000	0.230
IRON WORKER	W	ALL		31.190	32.790	2.0	2.0	2.0	7.200	16.97	0.000	1.200
LABORER		ALL		34.750	35.500	1.5	1.5	2.0	8.870	6.130	0.000	0.270
LATHER		BLD		37.770	39.770	1.5	1.5	2.0	8.960	6.920	0.000	0.490
MACHINIST		BLD		40.530	42.530	1.5	1.5	2.0	7.000	7.670	0.650	0.000
MARBLE FINISHERS		ALL		28.650	0.000	1.5	1.5	2.0	7.920	9.970	0.000	0.550
MARBLE MASON		BLD		38.030	41.830	1.5	1.5	2.0	8.000	9.970	0.000	0.550
MATERIAL TESTER I		ALL		24.750	0.000	1.5	1.5	2.0	8.870	6.130	0.000	0.270
MATERIALS TESTER II		ALL		29.750	0.000	1.5	1.5	2.0	8.870	6.130	0.000	0.270
MILLWRIGHT		ALL		36.520	38.520	1.5	1.5	2.0	7.960	5.920	0.000	0.490
OPERATING ENGINEER		BLD	1	43.800	47.800	2.0	2.0	2.0	9.600	6.550	1.900	1.000
OPERATING ENGINEER		BLD	2	42.500	47.800	2.0	2.0	2.0	9.600	6.550	1.900	1.000
OPERATING ENGINEER		BLD	3	39.950	47.800	2.0	2.0	2.0	9.600	6.550	1.900	1.000
OPERATING ENGINEER		BLD	4	38.200	47.800	2.0	2.0	2.0	9.600	6.550	1.900	1.000
OPERATING ENGINEER		HWY	1	42.000	46.000	1.5	1.5	2.0	9.600	6.550	1.900	1.000
OPERATING ENGINEER		HWY	2	41.450	46.000	1.5	1.5	2.0	9.600	6.550	1.900	1.000
OPERATING ENGINEER		HWY	3	39.400	46.000	1.5	1.5	2.0	9.600	6.550	1.900	1.000
OPERATING ENGINEER		HWY	4	38.000	46.000	1.5	1.5	2.0	9.600	6.550	1.900	1.000
OPERATING ENGINEER		HWY	5	36.800	46.000	1.5	1.5	2.0	9.600	6.550	1.900	1.000
ORNAMNTL IRON WORKER	E	ALL		39.050	41.300	2.0	2.0	2.0	7.950	13.19	0.000	0.500
ORNAMNTL IRON WORKER	S	ALL		38.120	40.030	2.0	2.0	2.0	8.140	14.49	0.000	0.230
PAINTER		ALL		37.830	39.830	1.5	1.5	1.5	6.750	6.750	0.000	0.500
PAINTER SIGNS		BLD		28.970	32.520	1.5	1.5	1.5	2.600	2.310	0.000	0.000
PILEDRIVER		ALL		37.770	39.770	1.5	1.5	2.0	8.960	6.920	0.000	0.490
PIPEFITTER		BLD		40.000	42.000	1.5	1.5	2.0	8.660	7.550	0.000	1.120
PLASTERER		BLD		38.100	40.390	1.5	1.5	2.0	7.500	8.440	0.000	0.400
PLUMBER		BLD		39.500	41.500	1.5	1.5	2.0	9.040	8.250	0.000	0.400
ROOFER		BLD		35.000	38.000	1.5	1.5	2.0	6.800	3.870	0.000	0.330
SHEETMETAL WORKER		BLD		40.210	42.210	1.5	1.5	2.0	7.410	9.620	0.000	0.680
SIGN HANGER		BLD		26.070	27.570	1.5	1.5	2.0	3.800	3.550	0.000	0.000
SPRINKLER FITTER		BLD		40.500	42.500	1.5	1.5	2.0	8.500	6.850	0.000	0.500
STEEL ERECTOR	E	ALL		40.250	42.250	2.0	2.0	2.0	9.950	14.74	0.000	0.300
STEEL ERECTOR	S	ALL		38.120	40.030	2.0	2.0	2.0	8.140	14.49	0.000	0.230
STONE MASON		BLD		38.030	41.830	1.5	1.5	2.0	8.000	9.970	0.000	0.550
TERRAZZO FINISHER		BLD		33.810	0.000	1.5	1.5	2.0	6.150	9.850	0.000	0.310
TERRAZZO MASON		BLD		37.390	40.390	1.5	1.5	2.0	6.150	11.11	0.000	0.350
TILE MASON		BLD		38.630	42.630	2.0	1.5	2.0	6.150	9.010	0.000	0.500
TRAFFIC SAFETY WRKR		HWY		24.300	25.900	1.5	1.5	2.0	3.780	1.875	0.000	0.000
TRUCK DRIVER		ALL	1	32.200	32.750	1.5	1.5	2.0	5.700	5.500	0.000	0.150

TRUCK DRIVER	ALL	2	32.350	32.750	1.5	1.5	2.0	5.700	5.500	0.000	0.150
TRUCK DRIVER	ALL	3	32.550	32.750	1.5	1.5	2.0	5.700	5.500	0.000	0.150
TRUCK DRIVER	ALL	4	32.750	32.750	1.5	1.5	2.0	5.700	5.500	0.000	0.150
TUCKPINTER	BLD		38.200	39.200	1.5	1.5	2.0	6.580	9.550	0.000	0.280

Legend :

M-F>8 (Overtime is required for any hour greater than 8 worked each day, Monday through Friday.)

OSA (Overtime is required for every hour worked on Saturday)

OSH (Overtime is required for every hour worked on Sunday and Holidays)

H/W (Health & Welfare Insurance)

Pensn (Pension)

Vac (Vacation)

Trng (Training)

Explanations

MCHENRY COUNTY

FENCE ERECTOR (EAST) - That part of the county East and Northeast of a line following Route 31 North to Route 14, northwest to Route 47 north to the Wisconsin State Line.

IRONWORKERS (EAST) - That part of the county East of Rts. 47 and 14.

IRONWORKERS (SOUTH) - That part of the county South of Route 14 and East of Route 47.

IRONWORKERS (WEST) - That part of the county West of Route 47.

The following list is considered as those days for which holiday rates of wages for work performed apply: New Years Day, Memorial/Decoration Day, Fourth of July, Labor Day, Veterans Day, Thanksgiving Day, Christmas Day. Generally, any of these holidays which fall on a Sunday is celebrated on the following Monday. This then makes work performed on that Monday payable at the appropriate overtime rate for holiday pay. Common practice in a given local may alter certain days of celebration such as the day after Thanksgiving for Veterans Day. If in doubt, please check with IDOL.

EXPLANATION OF CLASSES

ASBESTOS - GENERAL - removal of asbestos material/mold and hazardous materials from any place in a building, including mechanical systems where those mechanical systems are to be removed. This includes the removal of asbestos materials/mold and hazardous materials from ductwork or pipes in a building when the building is to be demolished at the time or at some close future date.

ASBESTOS - MECHANICAL - removal of asbestos material from mechanical systems, such as pipes, ducts, and boilers, where the mechanical systems are to remain.

CERAMIC TILE FINISHER

The grouting, cleaning, and polishing of all classes of tile, whether for interior or exterior purposes, all burned, glazed or unglazed products; all composition materials, granite tiles, warning detectable tiles, cement tiles, epoxy composite materials, pavers, glass, mosaics, fiberglass, and all substitute materials, for tile made in tile-like units; all mixtures in tile like form of cement, metals, and other materials that are for and intended for use as a finished floor surface, stair treads, promenade roofs, walks, walls, ceilings, swimming pools, and all other places where tile is to form a finished interior or exterior. The mixing of all setting mortars including but not limited to thin-set mortars, epoxies, wall mud, and any other sand and cement mixtures or adhesives when used in the preparation, installation, repair, or maintenance of tile and/or similar materials. The handling and unloading of all sand, cement, lime, tile, fixtures, equipment, adhesives, or any other materials to be used in the preparation, installation, repair, or maintenance of tile and/or similar materials. Ceramic Tile Finishers shall fill all joints and voids regardless of method on all tile work, particularly and especially after installation of said tile work. Application of any and all protective coverings to all types of tile installations including, but not be limited to, all soap compounds, paper products, tapes, and all polyethylene coverings, plywood, masonite, cardboard, and any new type of products that may be used to protect tile installations, Blastrac equipment, and all floor scarifying equipment used in preparing floors to receive tile. The clean up and removal of all waste and materials. All demolition of existing tile floors and walls to be re-tiled.

COMMUNICATIONS TECHNICIAN

Construction, installation, maintenance and removal of telecommunication facilities (voice, sound, data and video), telephone, security systems, fire alarm systems that are a component of a multiplex system and share a common cable, and data inside wire, interconnect, terminal equipment, central offices, PABX and equipment, micro waves, V-SAT, bypass, CATV, WAN (wide area network), LAN (local area networks), and ISDN (integrated system digital network), pulling of wire in raceways, but not the installation of raceways.

MARBLE FINISHER

Loading and unloading trucks, distribution of all materials (all stone, sand, etc.), stocking of floors with material, performing all rigging for heavy work, the handling of all material that may be needed for the installation of such materials, building of scaffolding, polishing if needed, patching, waxing of material if damaged, pointing up, caulking, grouting and cleaning of marble, holding water on diamond or Carborundum blade or saw for setters cutting, use of tub saw or any other saw needed for preparation of material, drilling of holes for wires that anchor material set by setters, mixing up of molding plaster for installation of material, mixing up thin set for the installation of material, mixing up of sand to cement for the installation of material and such other work as may be required in helping a Marble Setter in the handling of all material in the erection or installation of interior marble, slate, travertine, art marble, serpentine, alberene stone, blue stone, granite and other stones (meaning as to stone any foreign or domestic materials as are specified and used in building interiors and exteriors and customarily known as stone in the trade), carrara,

sanionyx, vitrolite and similar opaque glass and the laying of all marble tile, terrazzo tile, slate tile and precast tile, steps, risers treads, base, or any other materials that may be used as substitutes for any of the aforementioned materials and which are used on interior and exterior which are installed in a similar manner.

MATERIAL TESTER I: Hand coring and drilling for testing of materials; field inspection of uncured concrete and asphalt.

MATERIAL TESTER II: Field inspection of welds, structural steel, fireproofing, masonry, soil, facade, reinforcing steel, formwork, cured concrete, and concrete and asphalt batch plants; adjusting proportions of bituminous mixtures.

TRAFFIC SAFETY - work associated with barricades, horses and drums used to reduce lane usage on highway work, the installation and removal of temporary lane markings, and the installation and removal of temporary road signs.

TRUCK DRIVER - BUILDING, HEAVY AND HIGHWAY CONSTRUCTION

Class 1. Two or three Axle Trucks. A-frame Truck when used for transportation purposes; Air Compressors and Welding Machines, including those pulled by cars, pick-up trucks and tractors; Ambulances; Batch Gate Lockers; Batch Hopperman; Car and Truck Washers; Carry-alls; Fork Lifts and Hoisters; Helpers; Mechanics Helpers and Greasers; Oil Distributors 2-man operation; Pavement Breakers; Pole Trailer, up to 40 feet; Power Mower Tractors; Self-propelled Chip Spreader; Skipman; Slurry Trucks, 2-man operation; Slurry Truck Conveyor Operation, 2 or 3 man; Teamsters; Unskilled dumpman; and Truck Drivers hauling warning lights, barricades, and portable toilets on the job site.

Class 2. Four axle trucks; Dump Crets and Adgetors under 7 yards; Dumpsters, Track Trucks, Euclids, Hug Bottom Dump Turnapulls or Turnatrailers when pulling other than self-loading equipment or similar equipment under 16 cubic yards; Mixer Trucks under 7 yards; Ready-mix Plant Hopper Operator, and Winch Trucks, 2 Axles.

Class 3. Five axle trucks; Dump Crets and Adgetors 7 yards and over; Dumpsters, Track Trucks, Euclids, Hug Bottom Dump Turnatrailers or turnapulls when pulling other than self-loading equipment or similar equipment over 16 cubic yards; Explosives and/or Fission Material Trucks; Mixer Trucks 7 yards or over; Mobile Cranes while in transit; Oil Distributors, 1-man operation; Pole Trailer, over 40 feet; Pole and Expandable Trailers hauling material over 50 feet long; Slurry trucks, 1-man operation; Winch trucks, 3 axles or more; Mechanic--Truck Welder and Truck Painter.

Class 4. Six axle trucks; Dual-purpose vehicles, such as mounted crane trucks with hoist and accessories; Foreman; Master Mechanic; Self-loading equipment like P.B. and trucks with scoops on the front.

OPERATING ENGINEERS - BUILDING

Class 1. Mechanic; Asphalt Plant; Asphalt Spreader; Autograde; Backhoes with Caisson attachment; Batch Plant; Benoto; Boiler and Throttle Valve; Caisson Rigs; Central Redi-Mix Plant; Combination Back Hoe Front End-loader Machine; Compressor and Throttle Valve; Concrete Breaker (Truck Mounted); Concrete Conveyor; Concrete Paver; Concrete Placer; Concrete Placing Boom; Concrete Pump (Truck Mounted); Concrete Tower; Cranes, All; Cranes, Hammerhead; Cranes, (GCI and similar Type); Creter Crane; Crusher, Stone, etc.; Derricks, All; Derricks, Traveling; Formless Curb and Gutter Machine; Grader,

Elevating; Grouting Machines; Highlift Shovels or Front Endloader 2-1/4 yd. and over; Hoists, Elevators, outside type rack and pinion and similar machines; Hoists, one, two and three Drum; Hoists, Two Tugger One Floor; Hydraulic Backhoes; Hydraulic Boom Trucks; Hydro Vac (and similar equipment); Locomotives, All; Motor Patrol; Pile Drivers and Skid Rig; Post Hole Digger; Pre-Stress Machine; Pump Cretes Dual Ram; Pump Cretes; Squeeze Cretes-screw Type Pumps; Raised and Blind Hole Drill; Roto Mill Grinder; Scoops - Tractor Drawn; Slip-form Paver; Straddle Buggies; Tournapull; Tractor with Boom and Side Boom; Trenching Machines.

Class 2. Boilers; Broom, All Power Propelled; Bulldozers; Concrete Mixer (Two Bag and Over); Conveyor, Portable; Forklift Trucks; Greaser Engineer; Highlift Shovels or Front Endloaders under 2-1/4 yd.; Hoists, Automatic; Hoists, inside Freight Elevators; Hoists, Sewer Dragging Machine; Hoists, Tugger Single Drum; Laser Screed; Rock Drill (self-propelled); Rock Drill (truck mounted); Rollers, All; Steam Generators; Tractors, All; Tractor Drawn Vibratory Roller; Winch Trucks with "A" Frame.

Class 3. Air Compressor; Combination - Small Equipment Operator; Generators; Heaters, Mechanical; Hoists, Inside Elevators - (Rheostat Manual Controlled); Hydraulic Power Units (Pile Driving, Extracting, and Drilling); Pumps, over 3" (1 to 3 not to exceed a total of 300 ft.); Pumps, Well Points; Welding Machines (2 through 5); Winches, 4 small Electric Drill Winches; Bobcat (up to and including 3/4 cu. yd.).

Class 4. Bobcats and/or other Skid Steer Loaders; Oilers; and Brick Forklift.

OPERATING ENGINEERS - HEAVY AND HIGHWAY CONSTRUCTION

Class 1. Craft Foreman; Asphalt Plant; Asphalt Heater and Planer Combination; Asphalt Heater Scarfire; Asphalt Spreader; Autograder/GOMACO or other similar type machines; ABG Paver; Backhoes with Caisson attachment; Ballast Regulator; Belt Loader; Caisson Rigs; Car Dumper; Central Redi-Mix Plant; Combination Backhoe Front Endloader Machine, (1 cu. yd. Backhoe Bucket or over or with attachments); Concrete Breaker (Truck Mounted); Concrete Conveyor; Concrete Paver over 27E cu. ft.; Concrete Placer; Concrete Tube Float; Cranes, all attachments; Cranes, Hammerhead, Linden, Peco & Machines of a like nature; Crete Crane; Crusher, Stone, etc.; Derricks, All; Derrick Boats; Derricks, Traveling; Dowell machine with Air Compressor; Dredges; Field Mechanic-Welder; Formless Curb and Gutter Machine; Gradall and Machines of a like nature; Grader, Elevating; Grader, Motor Grader, Motor Patrol, Auto Patrol, Form Grader, Pull Grader, Subgrader; Guard Rail Post Driver Mounted; Hoists, One, Two and Three Drum; Hydraulic Backhoes; Backhoes with shear attachments; Mucking Machine; Pile Drivers and Skid Rig; Pre-Stress Machine; Pump Cretes Dual Ram; Rock Drill - Crawler or Skid Rig; Rock Drill - Truck Mounted; Roto Mill Grinder; Slip-Form Paver; Soil Test Drill Rig (Truck Mounted); Straddle Buggies; Hydraulic Telescoping Form (Tunnel); Tractor Drawn Belt Loader (with attached pusher - two engineers); Tractor with Boom; Tractaire with Attachments; Trenching Machine; Truck Mounted Concrete Pump with Boom; Raised or Blind Hole; Drills (Tunnel Shaft); Underground Boring and/or Mining Machines; Wheel Excavator; Widener (APSCO).

Class 2. Batch Plant; Bituminous Mixer; Boiler and Throttle Valve; Bulldozers; Car Loader Trailing Conveyors; Combination Backhoe Front Endloader Machine (less than 1 cu. yd. Backhoe Bucket or over or with attachments); Compressor and Throttle Valve; Compressor, Common

Receiver (3); Concrete Breaker or Hydro Hammer; Concrete Grinding Machine; Concrete Mixer or Paver 7S Series to and including 27 cu. ft.; Concrete Spreader; Concrete Curing Machine, Burlap Machine, Belting Machine and Sealing Machine; Concrete Wheel Saw; Conveyor Muck Cars (Haglund or Similar Type); Drills, All; Finishing Machine - Concrete; Greaser Engineer; Highlift Shovels or Front Endloader; Hoist - Sewer Dragging Machine; Hydraulic Boom Trucks (All Attachments); Hydro-Blaster; All Locomotives, Dinky; Pump Cretes; Squeeze Cretes-Screw Type Pumps, Gypsum Bulker and Pump; Roller, Asphalt; Rotary Snow Plows; Rototiller, Seaman, etc., self-propelled; Scoops - Tractor Drawn; Self-Propelled Compactor; Spreader - Chip - Stone, etc.; Scraper; Scraper - Prime Mover in Tandem (Regardless of Size); Tank Car Heater; Tractors, Push, Pulling Sheeps Foot, Disc, Compactor, etc.; Tug Boats.

Class 3. Boilers; Brooms, All Power Propelled; Cement Supply Tender; Compressor, Common Receiver (2); Concrete Mixer (Two Bag and Over); Conveyor, Portable; Farm-Type Tractors Used for Mowing, Seeding, etc.; Fireman on Boilers; Forklift Trucks; Grouting Machine; Hoists, Automatic; Hoists, All Elevators; Hoists, Tugger Single Drum; Jeep Diggers; Pipe Jacking Machines; Post-Hole Digger; Power Saw, Concrete Power Driven; Pug Mills; Rollers, other than asphalt; Seed and Straw Blower; Steam Generators; Stump Machine; Winch Trucks with "A" Frame; Work Boats; Tamper - Form-Motor Driven.

Class 4. Air Compressor; Combination - Small Equipment Operator; Directional Boring Machine; Generators; Heaters, Mechanical; Hydraulic Power Unit (Pile Driving, Extracting, or Drilling); Hydro-Blaster; Light Plants, All (1 through 5); Pumps, over 3" (1 to 3 not to exceed a total of 300 ft.); Pumps, Well Points; Tractaire; Welding Machines (2 through 5); Winches, 4 Small Electric Drill Winches.

Class 5. Bobcats (all); Brick Forklifts; Oilers.

TERRAZZO FINISHER

The handling of sand, cement, marble chips, and all other materials that may be used by the Mosaic Terrazzo Mechanic, and the mixing, grinding, grouting, cleaning and sealing of all Marble, Mosaic, and Terrazzo work, floors, base, stairs, and wainscoting by hand or machine, and in addition, assisting and aiding Marble, Masonic, and Terrazzo Mechanics.

Other Classifications of Work:

For definitions of classifications not otherwise set out, the Department generally has on file such definitions which are available. If a task to be performed is not subject to one of the classifications of pay set out, the Department will upon being contacted state which neighboring county has such a classification and provide such rate, such rate being deemed to exist by reference in this document. If no neighboring county rate applies to the task, the Department shall undertake a special determination, such special determination being then deemed to have existed under this determination. If a project requires these, or any classification not listed, please contact IDOL at 618/993-7271 for wage rates or clarifications.

LANDSCAPING

Landscaping work falls under the existing classifications for laborer, operating engineer and truck driver. The work performed by landscape plantsman and landscape laborer is covered by the existing

classification of laborer. The work performed by landscape operators (regardless of equipment used or its size) is covered by the classifications of operating engineer. The work performed by landscape truck drivers (regardless of size of truck driven) is covered by the classifications of truck driver.

Will County Prevailing Wage for August 2008

Trade Name	RG	TYP	C	Base	FRMAN	*M-F>8	OSA	OSH	H/W	Pensn	Vac	Trng
=====	==	==	=	=====	=====	=====	==	==	=====	=====	=====	=====
ASBESTOS ABT-GEN		ALL		34.750	35.250	1.5	1.5	2.0	8.830	6.170	0.000	0.270
ASBESTOS ABT-MEC		BLD		26.180	27.930	1.5	1.5	2.0	8.760	6.410	0.000	0.310
BOILERMAKER		BLD		39.450	43.000	2.0	2.0	2.0	6.720	8.490	0.000	0.300
BRICK MASON		BLD		38.030	41.830	1.5	1.5	2.0	8.000	9.970	0.000	0.550
CARPENTER		ALL		37.550	41.310	1.5	1.5	2.0	7.850	10.56	0.000	0.490
CEMENT MASON		ALL		39.500	41.500	2.0	2.0	2.0	7.250	10.43	0.000	0.150
CERAMIC TILE FNSHER		BLD		32.150	0.000	2.0	1.5	2.0	6.150	7.370	0.000	0.380
COMMUNICATION TECH		BLD		32.000	33.500	1.5	1.5	2.0	9.170	9.360	0.000	0.320
ELECTRIC PWR EQMT OP		ALL		38.600	44.970	1.5	1.5	2.0	9.110	11.34	0.000	0.290
ELECTRIC PWR GRNDMAN		ALL		30.110	44.970	1.5	1.5	2.0	7.120	8.850	0.000	0.230
ELECTRIC PWR LINEMAN		ALL		38.600	44.970	1.5	1.5	2.0	9.110	11.34	0.000	0.290
ELECTRICIAN		BLD		38.000	41.420	1.5	1.5	2.0	9.670	12.68	0.000	0.380
ELEVATOR CONSTRUCTOR		BLD		43.925	49.420	2.0	2.0	2.0	8.775	6.960	2.640	0.000
GLAZIER		BLD		37.000	38.500	1.5	1.5	2.0	7.340	12.05	0.000	0.690
HT/FROST INSULATOR		BLD		37.400	39.150	1.5	1.5	2.0	8.760	10.11	0.000	0.310
IRON WORKER		ALL		32.000	33.000	2.0	2.0	2.0	8.040	13.92	0.000	0.550
LABORER		ALL		34.750	35.500	1.5	1.5	2.0	8.830	6.170	0.000	0.270
LATHER		ALL		37.550	41.310	1.5	1.5	2.0	7.850	10.56	0.000	0.490
MACHINIST		BLD		40.530	42.530	1.5	1.5	2.0	7.000	7.670	0.650	0.000
MARBLE FINISHERS		ALL		28.650	0.000	1.5	1.5	2.0	7.920	9.970	0.000	0.550
MARBLE MASON		BLD		38.030	41.830	1.5	1.5	2.0	8.000	9.970	0.000	0.550
MATERIAL TESTER I		ALL		24.750	0.000	1.5	1.5	2.0	8.830	6.170	0.000	0.270
MATERIALS TESTER II		ALL		29.750	0.000	1.5	1.5	2.0	8.830	6.170	0.000	0.270
MILLWRIGHT		ALL		37.550	41.310	1.5	1.5	2.0	7.850	10.56	0.000	0.490
OPERATING ENGINEER		BLD	1	43.800	47.800	2.0	2.0	2.0	9.600	6.550	1.900	1.000
OPERATING ENGINEER		BLD	2	42.500	47.800	2.0	2.0	2.0	9.600	6.550	1.900	1.000
OPERATING ENGINEER		BLD	3	39.950	47.800	2.0	2.0	2.0	9.600	6.550	1.900	1.000
OPERATING ENGINEER		BLD	4	38.200	47.800	2.0	2.0	2.0	9.600	6.550	1.900	1.000
OPERATING ENGINEER		FLT	1	47.250	47.250	1.5	1.5	2.0	6.850	5.600	1.900	0.000
OPERATING ENGINEER		FLT	2	45.750	47.250	1.5	1.5	2.0	6.850	5.600	1.900	0.000
OPERATING ENGINEER		FLT	3	40.700	47.250	1.5	1.5	2.0	6.850	5.600	1.900	0.000
OPERATING ENGINEER		FLT	4	33.850	47.250	1.5	1.5	2.0	6.850	5.600	1.900	0.000
OPERATING ENGINEER		HWY	1	42.000	46.000	1.5	1.5	2.0	9.600	6.550	1.900	1.000
OPERATING ENGINEER		HWY	2	41.450	46.000	1.5	1.5	2.0	9.600	6.550	1.900	1.000
OPERATING ENGINEER		HWY	3	39.400	46.000	1.5	1.5	2.0	9.600	6.550	1.900	1.000
OPERATING ENGINEER		HWY	4	38.000	46.000	1.5	1.5	2.0	9.600	6.550	1.900	1.000
OPERATING ENGINEER		HWY	5	36.800	46.000	1.5	1.5	2.0	9.600	6.550	1.900	1.000
PAINTER		ALL		35.400	39.820	1.5	1.5	2.0	6.550	7.400	0.000	0.340
PAINTER SIGNS		BLD		28.970	32.520	1.5	1.5	1.5	2.600	2.310	0.000	0.000
PILEDRIVER		ALL		37.550	41.310	1.5	1.5	2.0	7.850	10.56	0.000	0.490
PIPEFITTER		BLD		37.600	39.600	1.5	1.5	2.0	8.660	6.900	0.000	0.940
PLASTERER		BLD		38.100	40.390	1.5	1.5	2.0	7.500	8.440	0.000	0.400
PLUMBER		BLD		42.000	44.000	1.5	1.5	2.0	8.500	9.000	0.000	1.010
ROOFER		BLD		35.000	38.000	1.5	1.5	2.0	6.800	3.870	0.000	0.330
SHEETMETAL WORKER		BLD		40.210	42.210	1.5	1.5	2.0	7.410	9.620	0.000	0.680
SPRINKLER FITTER		BLD		40.500	42.500	1.5	1.5	2.0	8.500	6.850	0.000	0.500
STONE MASON		BLD		38.030	41.830	1.5	1.5	2.0	8.000	9.970	0.000	0.550
TERRAZZO FINISHER		BLD		33.810	0.000	1.5	1.5	2.0	6.150	9.850	0.000	0.310
TERRAZZO MASON		BLD		37.390	40.390	1.5	1.5	2.0	6.150	11.11	0.000	0.350
TILE MASON		BLD		38.630	42.630	2.0	1.5	2.0	6.150	9.010	0.000	0.500
TRAFFIC SAFETY WRKR		HWY		24.300	25.900	1.5	1.5	2.0	3.780	1.875	0.000	0.000
TRUCK DRIVER		ALL	1	35.650	36.200	1.5	1.5	2.0	6.250	4.275	0.000	0.250
TRUCK DRIVER		ALL	2	35.800	36.200	1.5	1.5	2.0	6.250	4.275	0.000	0.250
TRUCK DRIVER		ALL	3	36.000	36.200	1.5	1.5	2.0	6.250	4.275	0.000	0.250
TRUCK DRIVER		ALL	4	36.200	36.200	1.5	1.5	2.0	6.250	4.275	0.000	0.250
TUCKPOINTER		BLD		38.200	39.200	1.5	1.5	2.0	6.580	9.550	0.000	0.280

Legend:

M-F>8 (Overtime is required for any hour greater than 8 worked each day, Monday through Friday.)

OSA (Overtime is required for every hour worked on Saturday)

OSH (Overtime is required for every hour worked on Sunday and Holidays)

H/W (Health & Welfare Insurance)

Pensn (Pension)

Vac (Vacation)

Trng (Training)

Explanations

WILL COUNTY

IRONWORKERS (SOUTH) - That part of the county South of a diagonal line through Braidwood and Goodenow.

The following list is considered as those days for which holiday rates of wages for work performed apply: New Years Day, Memorial/Decoration Day, Fourth of July, Labor Day, Veterans Day, Thanksgiving Day, Christmas Day. Generally, any of these holidays which fall on a Sunday is celebrated on the following Monday. This then makes work performed on that Monday payable at the appropriate overtime rate for holiday pay. Common practice in a given local may alter certain days of celebration such as the day after Thanksgiving for Veterans Day. If in doubt, please check with IDOL.

EXPLANATION OF CLASSES

ASBESTOS - GENERAL - removal of asbestos material/mold and hazardous materials from any place in a building, including mechanical systems where those mechanical systems are to be removed. This includes the removal of asbestos materials/mold and hazardous materials from ductwork or pipes in a building when the building is to be demolished at the time or at some close future date.

ASBESTOS - MECHANICAL - removal of asbestos material from mechanical systems, such as pipes, ducts, and boilers, where the mechanical systems are to remain.

CERAMIC TILE FINISHER

The grouting, cleaning, and polishing of all classes of tile, whether for interior or exterior purposes, all burned, glazed or unglazed products; all composition materials, granite tiles, warning detectable tiles, cement tiles, epoxy composite materials, pavers, glass, mosaics, fiberglass, and all substitute materials, for tile made in tile-like units; all mixtures in tile like form of cement, metals, and other materials that are for and intended for use as a finished floor surface, stair treads, promenade roofs, walks, walls, ceilings, swimming pools, and all other places where tile is to form a finished interior or exterior. The mixing of all setting mortars including but not limited to thin-set mortars, epoxies, wall mud, and any other sand and cement mixtures or adhesives when used in the preparation,

installation, repair, or maintenance of tile and/or similar materials. The handling and unloading of all sand, cement, lime, tile, fixtures, equipment, adhesives, or any other materials to be used in the preparation, installation, repair, or maintenance of tile and/or similar materials. Ceramic Tile Finishers shall fill all joints and voids regardless of method on all tile work, particularly and especially after installation of said tile work. Application of any and all protective coverings to all types of tile installations including, but not be limited to, all soap compounds, paper products, tapes, and all polyethylene coverings, plywood, masonite, cardboard, and any new type of products that may be used to protect tile installations, Blastrac equipment, and all floor scarifying equipment used in preparing floors to receive tile. The clean up and removal of all waste and materials. All demolition of existing tile floors and walls to be re-tiled.

COMMUNICATIONS TECHNICIAN

Installation, operation, inspection, maintenance, repair and service of radio, television, recording, voice, sound and vision production and reproduction, telephone and telephone interconnect, facsimile, equipment and appliances used for domestic, commercial, educational and entertainment purposes, pulling of wire through conduit but not the installation of conduit.

MARBLE FINISHER

Loading and unloading trucks, distribution of all materials (all stone, sand, etc.), stocking of floors with material, performing all rigging for heavy work, the handling of all material that may be needed for the installation of such materials, building of scaffolding, polishing if needed, patching, waxing of material if damaged, pointing up, caulking, grouting and cleaning of marble, holding water on diamond or Carborundum blade or saw for setters cutting, use of tub saw or any other saw needed for preparation of material, drilling of holes for wires that anchor material set by setters, mixing up of molding plaster for installation of material, mixing up thin set for the installation of material, mixing up of sand to cement for the installation of material and such other work as may be required in helping a Marble Setter in the handling of all material in the erection or installation of interior marble, slate, travertine, art marble, serpentine, alberene stone, blue stone, granite and other stones (meaning as to stone any foreign or domestic materials as are specified and used in building interiors and exteriors and customarily known as stone in the trade), carrara, sanionyx, vitrolite and similar opaque glass and the laying of all marble tile, terrazzo tile, slate tile and precast tile, steps, risers treads, base, or any other materials that may be used as substitutes for any of the aforementioned materials and which are used on interior and exterior which are installed in a similar manner.

MATERIAL TESTER I: Hand coring and drilling for testing of materials; field inspection of uncured concrete and asphalt.

MATERIAL TESTER II: Field inspection of welds, structural steel, fireproofing, masonry, soil, facade, reinforcing steel, formwork, cured concrete, and concrete and asphalt batch plants; adjusting proportions of bituminous mixtures.

TRAFFIC SAFETY - work associated with barricades, horses and drums used to reduce lane usage on highway work, the installation and removal of temporary lane markings, and the installation and removal of temporary road signs.

TRUCK DRIVER - BUILDING, HEAVY AND HIGHWAY CONSTRUCTION

Class 1. Two or three Axle Trucks. A-frame Truck when used for transportation purposes; Air Compressors and Welding Machines, including those pulled by cars, pick-up trucks and tractors; Ambulances; Batch Gate Lockers; Batch Hopperman; Car and Truck Washers; Carry-alls; Fork Lifts and Hoisters; Helpers; Mechanics Helpers and Greasers; Oil Distributors 2-man operation; Pavement Breakers; Pole Trailer, up to 40 feet; Power Mower Tractors; Self-propelled Chip Spreader; Skipman; Slurry Trucks, 2-man operation; Slurry Truck Conveyor Operation, 2 or 3 man; Teamsters; Unskilled dumpman; and Truck Drivers hauling warning lights, barricades, and portable toilets on the job site.

Class 2. Four axle trucks; Dump Crets and Adgetors under 7 yards; Dumpsters, Track Trucks, Euclids, Hug Bottom Dump Turnapulls or Turnatrailers when pulling other than self-loading equipment or similar equipment under 16 cubic yards; Mixer Trucks under 7 yards; Ready-mix Plant Hopper Operator, and Winch Trucks, 2 Axles.

Class 3. Five axle trucks; Dump Crets and Adgetors 7 yards and over; Dumpsters, Track Trucks, Euclids, Hug Bottom Dump Turnatrailers or turnapulls when pulling other than self-loading equipment or similar equipment over 16 cubic yards; Explosives and/or Fission Material Trucks; Mixer Trucks 7 yards or over; Mobile Cranes while in transit; Oil Distributors, 1-man operation; Pole Trailer, over 40 feet; Pole and Expandable Trailers hauling material over 50 feet long; Slurry trucks, 1-man operation; Winch trucks, 3 axles or more; Mechanic--Truck Welder and Truck Painter.

Class 4. Six axle trucks; Dual-purpose vehicles, such as mounted crane trucks with hoist and accessories; Foreman; Master Mechanic; Self-loading equipment like P.B. and trucks with scoops on the front.

OPERATING ENGINEERS - BUILDING

Class 1. Mechanic; Asphalt Plant; Asphalt Spreader; Autograde; Backhoes with Caisson attachment; Batch Plant; Benoto; Boiler and Throttle Valve; Caisson Rigs; Central Redi-Mix Plant; Combination Back Hoe Front End-loader Machine; Compressor and Throttle Valve; Concrete Breaker (Truck Mounted); Concrete Conveyor; Concrete Paver; Concrete Placer; Concrete Placing Boom; Concrete Pump (Truck Mounted); Concrete Tower; Cranes, All; Cranes, Hammerhead; Cranes, (GCI and similar Type); Creter Crane; Crusher, Stone, etc.; Derricks, All; Derricks, Traveling; Formless Curb and Gutter Machine; Grader, Elevating; Grouting Machines; Highlift Shovels or Front Endloader 2-1/4 yd. and over; Hoists, Elevators, outside type rack and pinion and similar machines; Hoists, one, two and three Drum; Hoists, Two Tugger One Floor; Hydraulic Backhoes; Hydraulic Boom Trucks; Hydro Vac (and similar equipment); Locomotives, All; Motor Patrol; Pile Drivers and Skid Rig; Post Hole Digger; Pre-Stress Machine; Pump Cretes Dual Ram; Pump Cretes; Squeeze Cretes-screw Type Pumps; Raised and Blind Hole Drill; Roto Mill Grinder; Scoops - Tractor Drawn; Slip-form Paver; Straddle Buggies; Tournapull; Tractor with Boom and Side Boom; Trenching Machines.

Class 2. Boilers; Broom, All Power Propelled; Bulldozers; Concrete Mixer (Two Bag and Over); Conveyor, Portable; Forklist Trucks; Greaser Engineer; Highlift Shovels or Front Endloaders under 2-1/4 yd.; Hoists, Automatic; Hoists, inside Freight Elevators; Hoists, Sewer Dragging Machine; Hoists, Tugger Single Drum; Laser Screed; Rock Drill (self-propelled); Rock Drill (truck mounted); Rollers, All; Steam Generators; Tractors, All; Tractor Drawn Vibratory Roller;

Winch Trucks with "A" Frame.

Class 3. Air Compressor; Combination - Small Equipment Operator; Generators; Heaters, Mechanical; Hoists, Inside Elevators - (Rheostat Manual Controlled); Hydraulic Power Units (Pile Driving, Extracting, and Drilling); Pumps, over 3" (1 to 3 not to exceed a total of 300 ft.); Pumps, Well Points; Welding Machines (2 through 5); Winches, 4 small Electric Drill Winches; Bobcat (up to and including 3/4 cu. yd.).

Class 4. Bobcats and/or other Skid Steer Loaders; Oilers; and Brick Forklift.

OPERATING ENGINEERS - FLOATING

Class 1. Craft foreman (Master Mechanic), diver/wet tender, engineer (hydraulic dredge).

Class 2. Crane/backhoe operator, mechanic/welder, assistant engineer (hydraulic dredge), leverman (hydraulic dredge), and diver tender.

Class 3. Deck equipment operator (machineryman), maintenance of crane (over 50 ton capacity) or backhoe (96,000 pounds or more), tug/launch operator, loader, dozer and like equipment on barge, breakwater wall, slip/dock or scow, deck machinery, etc.

Class 4. Deck equipment operator (machineryman/fireman), (4 equipment units or more) and crane maintenance 50 ton capacity and under or backhoe weighing 96,000 pounds or less, assistant tug operator.

OPERATING ENGINEERS - HEAVY AND HIGHWAY CONSTRUCTION

Class 1. Craft Foreman; Asphalt Plant; Asphalt Heater and Planer Combination; Asphalt Heater Scarfire; Asphalt Spreader; Autograder/GOMACO or other similar type machines; ABG Paver; Backhoes with Caisson attachment; Ballast Regulator; Belt Loader; Caisson Rigs; Car Dumper; Central Redi-Mix Plant; Combination Backhoe Front Endloader Machine, (1 cu. yd. Backhoe Bucket or over or with attachments); Concrete Breaker (Truck Mounted); Concrete Conveyor; Concrete Paver over 27E cu. ft.; Concrete Placer; Concrete Tube Float; Cranes, all attachments; Cranes, Hammerhead, Linden, Peco & Machines of a like nature; Crete Crane; Crusher, Stone, etc.; Derricks, All; Derrick Boats; Derricks, Traveling; Dowell machine with Air Compressor; Dredges; Field Mechanic-Welder; Formless Curb and Gutter Machine; Gradall and Machines of a like nature; Grader, Elevating; Grader, Motor Grader, Motor Patrol, Auto Patrol, Form Grader, Pull Grader, Subgrader; Guard Rail Post Driver Mounted; Hoists, One, Two and Three Drum; Hydraulic Backhoes; Backhoes with shear attachments; Mucking Machine; Pile Drivers and Skid Rig; Pre-Stress Machine; Pump Cretes Dual Ram; Rock Drill - Crawler or Skid Rig; Rock Drill - Truck Mounted; Roto Mill Grinder; Slip-Form Paver; Soil Test Drill Rig (Truck Mounted); Straddle Buggies; Hydraulic Telescoping Form (Tunnel); Tractor Drawn Belt Loader (with attached pusher - two engineers); Tractor with Boom; Tractaire with Attachments; Trenching Machine; Truck Mounted Concrete Pump with Boom; Raised or Blind Hole; Drills (Tunnel Shaft); Underground Boring and/or Mining Machines; Wheel Excavator; Widener (APSCO).

Class 2. Batch Plant; Bituminous Mixer; Boiler and Throttle Valve; Bulldozers; Car Loader Trailing Conveyors; Combination Backhoe Front Endloader Machine (less than 1 cu. yd. Backhoe Bucket or over or with attachments); Compressor and Throttle Valve; Compressor, Common Receiver (3); Concrete Breaker or Hydro Hammer; Concrete Grinding Machine; Concrete Mixer or Paver 7S Series to and including 27 cu.

ft.; Concrete Spreader; Concrete Curing Machine, Burlap Machine, Belting Machine and Sealing Machine; Concrete Wheel Saw; Conveyor Muck Cars (Haglund or Similar Type); Drills, All; Finishing Machine - Concrete; Greaser Engineer; Highlift Shovels or Front Endloader; Hoist - Sewer Dragging Machine; Hydraulic Boom Trucks (All Attachments); Hydro-Blaster; All Locomotives, Dinky; Pump Cretes; Squeeze Cretes-Screw Type Pumps, Gypsum Bulker and Pump; Roller, Asphalt; Rotary Snow Plows; Rototiller, Seaman, etc., self-propelled; Scoops - Tractor Drawn; Self-Propelled Compactor; Spreader - Chip - Stone, etc.; Scraper; Scraper - Prime Mover in Tandem (Regardless of Size); Tank Car Heater; Tractors, Push, Pulling Sheeps Foot, Disc, Compactor, etc.; Tug Boats.

Class 3. Boilers; Brooms, All Power Propelled; Cement Supply Tender; Compressor, Common Receiver (2); Concrete Mixer (Two Bag and Over); Conveyor, Portable; Farm-Type Tractors Used for Mowing, Seeding, etc.; Fireman on Boilers; Forklift Trucks; Grouting Machine; Hoists, Automatic; Hoists, All Elevators; Hoists, Tugger Single Drum; Jeep Diggers; Pipe Jacking Machines; Post-Hole Digger; Power Saw, Concrete Power Driven; Pug Mills; Rollers, other than asphalt; Seed and Straw Blower; Steam Generators; Stump Machine; Winch Trucks with "A" Frame; Work Boats; Tamper - Form-Motor Driven.

Class 4. Air Compressor; Combination - Small Equipment Operator; Directional Boring Machine; Generators; Heaters, Mechanical; Hydraulic Power Unit (Pile Driving, Extracting, or Drilling); Hydro-Blaster; Light Plants, All (1 through 5); Pumps, over 3" (1 to 3 not to exceed a total of 300 ft.); Pumps, Well Points; Tractaire; Welding Machines (2 through 5); Winches, 4 Small Electric Drill Winches.

Class 5. Bobcats (all); Brick Forklifts; Oilers.

TERRAZZO FINISHER

The handling of sand, cement, marble chips, and all other materials that may be used by the Mosaic Terrazzo Mechanic, and the mixing, grinding, grouting, cleaning and sealing of all Marble, Mosaic, and Terrazzo work, floors, base, stairs, and wainscoting by hand or machine, and in addition, assisting and aiding Marble, Masonic, and Terrazzo Mechanics.

Other Classifications of Work:

For definitions of classifications not otherwise set out, the Department generally has on file such definitions which are available. If a task to be performed is not subject to one of the classifications of pay set out, the Department will upon being contacted state which neighboring county has such a classification and provide such rate, such rate being deemed to exist by reference in this document. If no neighboring county rate applies to the task, the Department shall undertake a special determination, such special determination being then deemed to have existed under this determination. If a project requires these, or any classification not listed, please contact IDOL at 618/993-7271 for wage rates or clarifications.

LANDSCAPING

Landscaping work falls under the existing classifications for laborer, operating engineer and truck driver. The work performed by landscape plantsman and landscape laborer is covered by the existing classification of laborer. The work performed by landscape operators (regardless of equipment used or its size) is covered by the

classifications of operating engineer. The work performed by landscape truck drivers (regardless of size of truck driven) is covered by the classifications of truck driver.