

F.A.S. RTE.	SECTION	COUNTY	TOTAL SHEETS	SHEET NO.
145B	03-00125-01-GE	FULTON	48	14
STA.	TO STA.			
FED. ROAD DIST. NO.	ILLINOIS	FED. AID PROJECT		

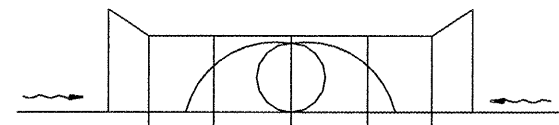

FRONT VIEW

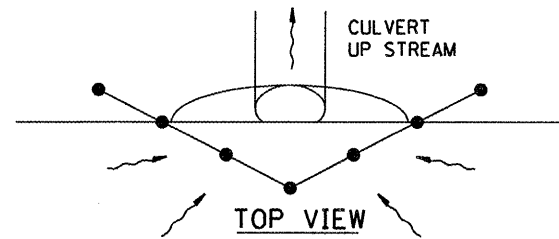

TOP VIEW

UPSTREAM PIPE CULVERT EROSION CONTROL

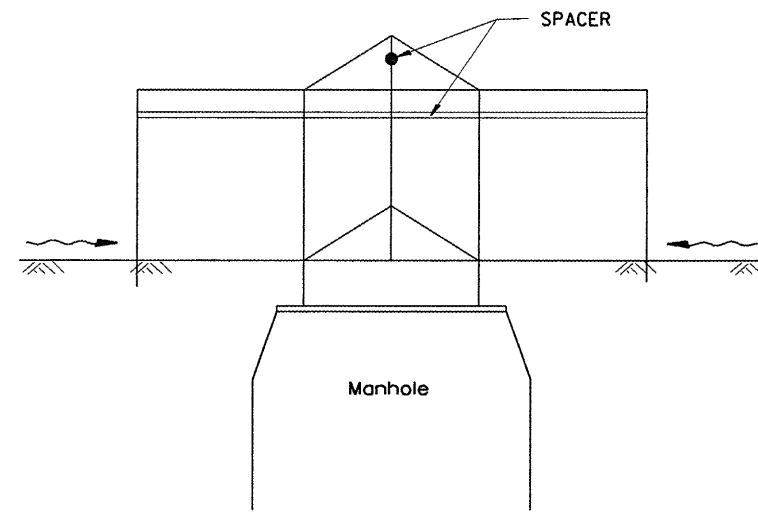

SIDE VIEW  
A-A

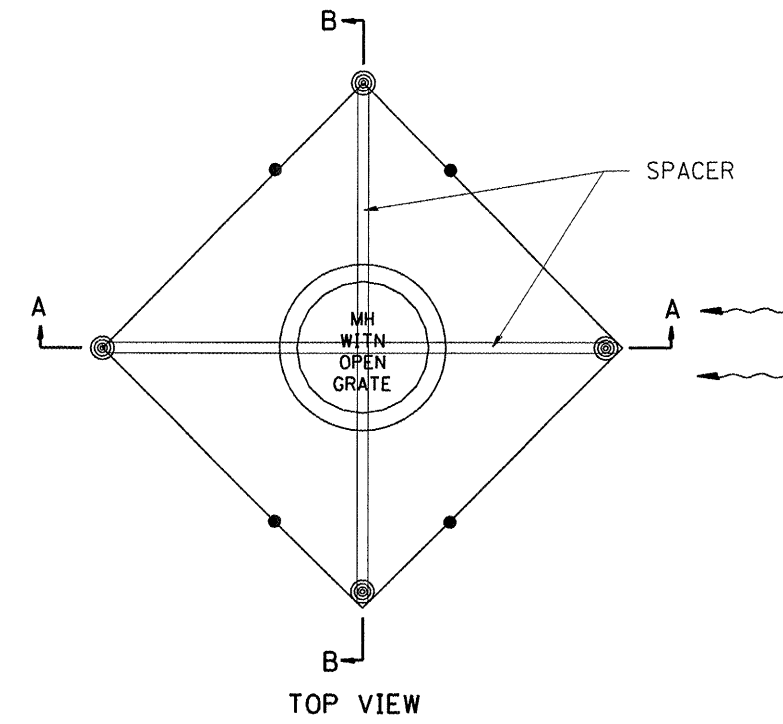

TOP VIEW

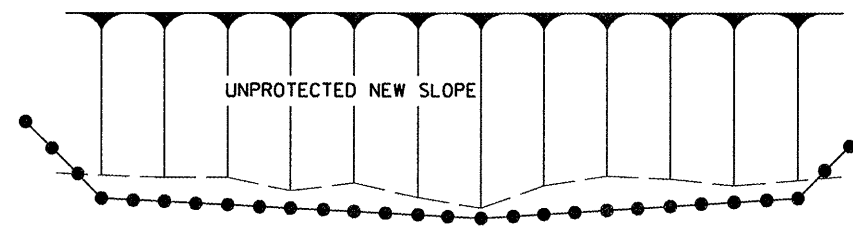

TOP VIEW

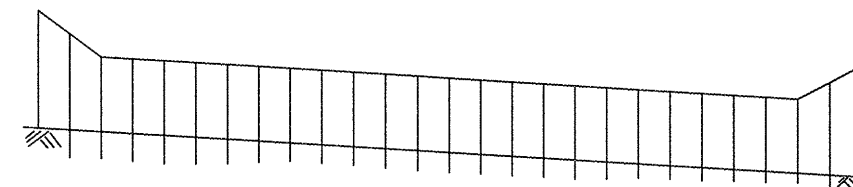

FRONT VIEW

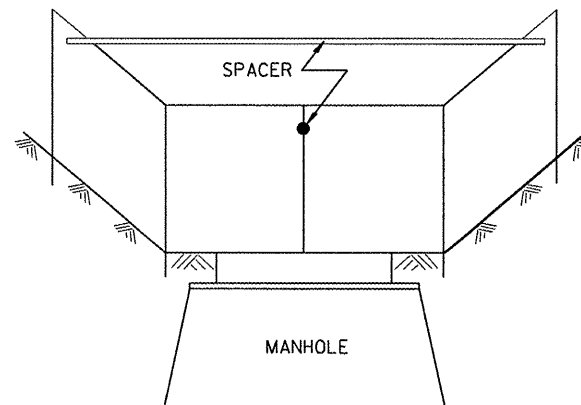

Front View  
B-B

EROSION CONTROL  
AT  
OPEN GRATE MAN HOLE

GENERAL NOTES:

1. This work shall be performed in accordance with Sections 280 & 1081, of the Standard Specifications.
2. Additional Timber or Metal Post shall be installed, as needed.

IDOT DISTRICT DETAIL 280001-D4

REVISIONS	
NAME	DATE

TYPICAL APPLICATION  
OF  
SILT FILTER FENCE

SCALE: VERT.  
HORIZ.  
DATE

DRAWN BY  
CHECKED BY