

STATE OF ILLINOIS
DEPARTMENT OF TRANSPORTATION

ROUTE NO.	SECTION	COUNTY	SHEETS	PAGE	SHEET NO. S17
F. A. P. 846	4B-1-R	WILL	39	39	SHEETS S17
FED. ROAD DIST. NO. 7	ILLINOIS	FED. AID PROJECT			

CONTRACT NO. 60D26

NOTES

Bar splicer assemblies shall be of an approved type and shall develop in tension at least 125 percent of the yield strength of the lapped reinforcement bars.
Splicer rods shall be of minimum 60 ksi yield strength, threaded or coiled full length.
All reinforcement bars shall be lapped and tied to the splicer rods or dowel bars.
Bar splicer assemblies shall be epoxy coated according to the requirements for reinforcement bars.
Other systems of similar design may be submitted to the Engineer for approval. Approval shall be based on certified test results from an approved testing laboratory that the proposed bar splicer assembly satisfies the following requirements:

- ① Minimum Capacity (Tension in kips) = $1.25 \times f_y \times A_t$
 - ② Minimum *Pull-out Strength (Tension in kips) = $0.66 \times f_y \times A_t$
- Where f_y = Yield strength of lapped reinforcement bars in ksi.
 A_t = Tensile stress area of lapped reinforcement bars.
* = 28 day concrete

BAR SPLICER ASSEMBLIES			
Bar Size to be Spliced	Splicer Rod or Dowel Bar Length	Strength Requirements	
		Min. Capacity kips - tension	Min. Pull-Out Strength kips - tension
#4	1'-8"	14.7	7.9
#5	2'-0"	23.0	12.3
#6	2'-7"	33.1	17.4
#7	3'-5"	45.1	23.8
#8	4'-6"	58.9	31.3
#9	5'-9"	75.0	39.6
#10	7'-3"	95.0	50.3
#11	9'-0"	117.4	61.8

The diameter of this part is the same as the diameter of the bar spliced.

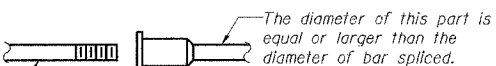

ROLLED THREAD DOWEL BAR

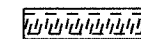

**** ONE PIECE**

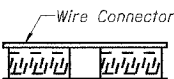

WELDED SECTIONS

BAR SPLICER ASSEMBLY ALTERNATIVES

** Heavy Hex Nuts conforming to ASTM A 563, Grade C, D or DH may be used.

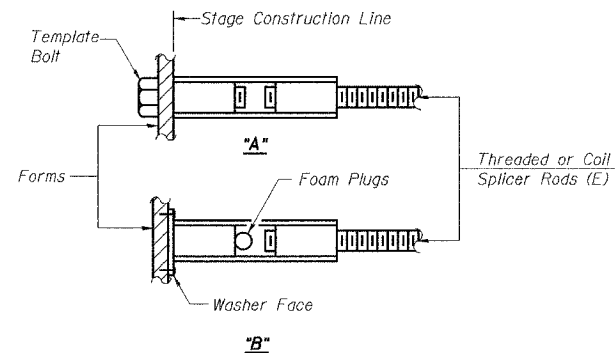

INSTALLATION AND SETTING METHODS

"A" : Set bar splicer assembly by means of a template bolt.
"B" : Set bar splicer assembly by nailing to wood forms or cementing to steel forms.
(E) : Indicates epoxy coating.

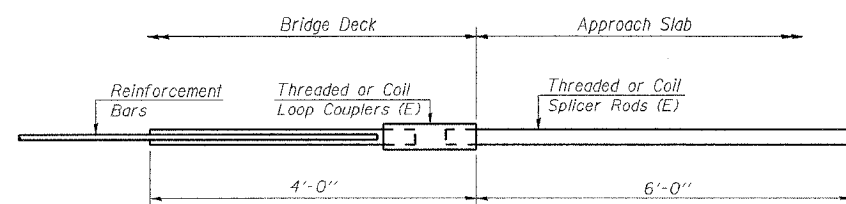

FOR INTEGRAL OR SEMI-INTEGRAL ABUTMENTS

Bar Splicer for #5 bar
Min. Capacity = 23.0 kips - tension
Min. Pull-out Strength = 12.3 kips - tension
No. Required =

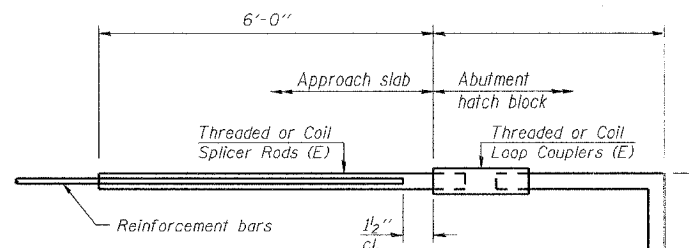

FOR STUB ABUTMENTS

Bar Splicer for #5 bar
Min. Capacity = 23.0 kips - tension
Min. Pull-out Strength = 12.3 kips - tension
No. Required = 96

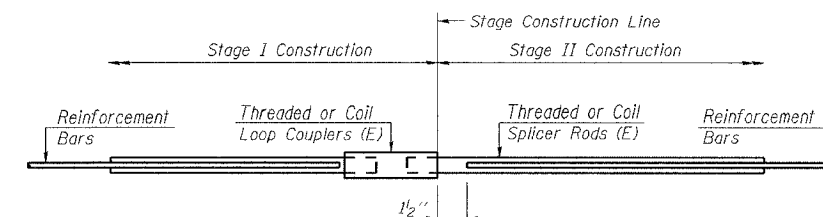

STANDARD

Bar Size	No. Assemblies Required	Location

THIS SHEET IS FOR INFORMATION ONLY

DESIGNED	NDS/GMK
CHECKED	MTP/SMK/GBC
DRAWN	NDS/GMK
CHECKED	SMK/GBC

ILLINOIS DEPARTMENT OF TRANSPORTATION
BAR SPLICER ASSEMBLY DETAILS
FAP 846
SB IL. ROUTE 53 OVER PRAIRIE CREEK
STATION 1305+00 SECTION 4B-1-R
WILL COUNTY
STRUCTURE NO. 099-0242
SCALE: NONE
DATE: JUNE 2007
AEI DELTA ENGINEERING INC.
CONSULTING ENGINEERS, CHICAGO, ILLINOIS