

STATE OF ILLINOIS
DEPARTMENT OF TRANSPORTATION

ROUTE NO.	SECTION	COUNTY	DISTRICT	SHEET NO.	SHEET NO. - 30
1545		DUPAGE	97	51	39 - SHEETS
FED. ROAD DIST. NO.		ILLINOIS	FED. AID PROJ. NO.	CONTRACT NO. 83961	
• 00-00115-00-BR					

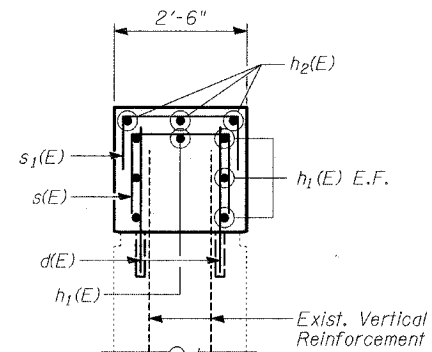

SECTION A-A

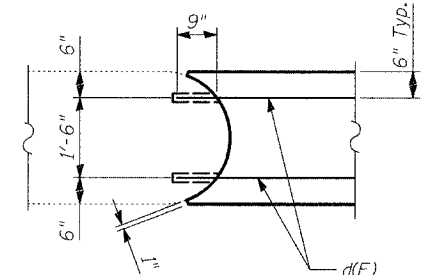

SECTION B-B

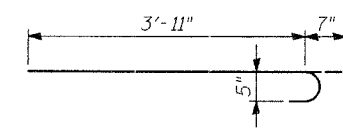

BAR n(E)

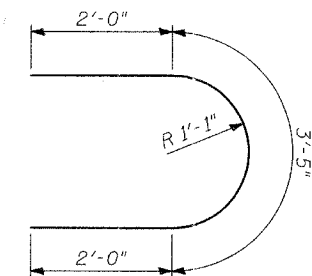

BAR u(E)

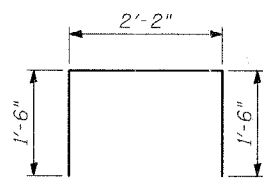

BAR s(E)

PIER 1 BILL OF MATERIAL

Bar	No.	Size	Length	Shape
d(E)	100	#5	3'-3"	—
h(E)	22	#5	6'-6"	—
h1(E)	14	#5	24'-3"	—
h2(E)	7	#5	6'-8"	—
n(E)	17	#5	4'-6"	—
s(E)	54	#5	5'-2"	—
t(E)	16	#5	5'-8"	—
u(E)	17	#5	7'-5"	—
v(E)	19	#5	11'-9"	—
w(E)	8	#5	7'-0"	—

Reinforcement Bars, Epoxy Coated	Pound	1,770
Concrete Structures	Cu. Yd.	22.2
Bar Splicers	Each	7
Rock Excavation for Structures	Cu. Yd.	3
Structure Excavation	Cu. Yd.	11

PIER 2 BILL OF MATERIAL

Bar	No.	Size	Length	Shape
d(E)	100	#5	3'-3"	—
h(E)	22	#5	6'-6"	—
h1(E)	14	#5	24'-3"	—
h2(E)	7	#5	6'-8"	—
n(E)	17	#5	4'-6"	—
s(E)	54	#5	5'-2"	—
t(E)	16	#5	5'-8"	—
u(E)	17	#5	7'-5"	—
v(E)	19	#5	11'-9"	—
w(E)	8	#5	7'-0"	—

Reinforcement Bars, Epoxy Coated	Pound	1,770
Concrete Structures	Cu. Yd.	22.2
Bar Splicers	Each	7
Rock Excavation for Structures	Cu. Yd.	2
Structure Excavation	Cu. Yd.	11

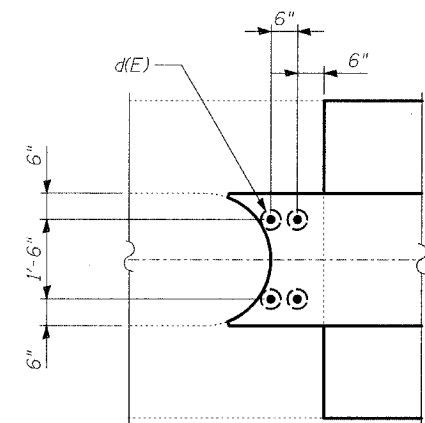

SECTION C-C

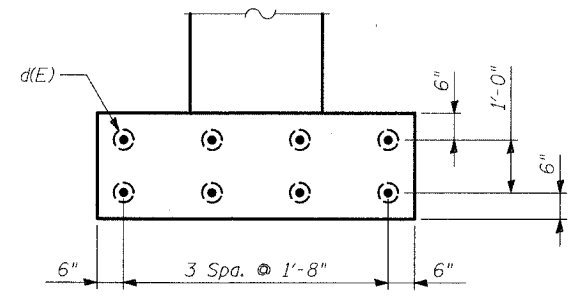

SECTION D-D

TYLIN INTERNATIONAL

DESIGNED	- PL
CHECKED	- DJE
DRAWN	- PL
CHECKED	- DJE

PIER DETAILS

BAILEY ROAD OVER THE
WEST BRANCH OF THE DUPAGE RIVER
FAU 1545
SECTION 00-00115-00-BR STA. 2+99.15
DUPAGE COUNTY
S.N. 022-3028