

PLUMBING FIXTURE CONNECTION SCHEDULE							
MARK	DESCRIPTION	WASTE	TRAP	VENT	COLD WATER	HOT WATER	REMARKS
SK-1	SINGLE BOWL SINK	2"	1 1/2"	1 1/2"	1/2"	1/2"	MAN. FAUCET
NOTE: 1. SIZES LISTED ARE MINIMUM CONNECTIONS REQUIRED TO FIXTURES.							

DRAIN SCHEDULE					
MARK	MANUFACTURER	MODEL NO.	OUTLET SIZE	STRAINER MATERIAL	REMARKS
FD-2	J.R.SMITH	2110	4"	CAST IRON	MECHANICAL ROOM AND MECH./PUMP ROOM
FD-3	J.R.SMITH	3710SC	4"	CAST IRON	ELEVATOR SUMP IN ELECTRICAL ROOM
NOTE:					

MISCELLANEOUS EQUIPMENT					
MARK	MANUFACTURER	MODEL NO.	CONNECTIONS	INSTALLATION	USE/LOCATION
RPBP-2	FEBCO	860	1"	HORIZONTAL	FOUNTAIN/MECHANICAL ROOM
SP-1	STANCOR	SE50	2"	IN PIT	SUMP PUMP/ELEVATOR PIT
NOTE:					

ELECTRIC WATER HEATER SCHEDULE							
MARK	MANUFACTURER	MODEL NO.	STORAGE	RECOVERY	ELEMENT	VOLT/PH	REMARKS
WH-2	BRADFORD WHITE	ES-4000-1-S-10	-	-	4.1 KW	208/3	UNDER SK-1
NOTE: RECOVERY BASED ON 90° RISE							

SYMBOLS & ABBREVIATIONS

PLUMBING

PLUMBING ABBREVIATION

AD	AREA DRAIN
AP	ACCESS PANEL
BT	BATH TUB
CO	CLEAN OUT
CW	COLD WATER
EW	ELECTRIC WATER COOLER
FCO	FLOOR CLEANOUT
FD	FLOOR DRAIN
F.F.	FINISH FLOOR
FS	FLOOR SINK
HW	HOT WATER
HWR	HOT WATER RETURN
HWRP	HOT WATER RECIRCULATING PUMP
HY	HYDRANT
INV. EL.	INVERT ELEVATION
LAV	LAVATORY
MB	MOP SERVICE BASIN
PR	PLUMBING RISER
RPBP	BACKFLOW PREVENTER (REDUCED PRESSURE)
SH	SHOWER
SK	SINK
TD	TRENCH DRAIN
TYP.	TYPICAL
V	VENT
VTR	VENT THRU ROOF
W	WASTE
WH	WATER HEATER
WS	WATER SOFTNER
WCO	WALL CLEANOUT
WC	WATER CLOSET
VS	VENT STACK
UR	URINAL

PIPING SPECIALTIES

	GATE VALVE
	CHECK VALVE
	CIRCUIT SETTER
	BALL VALVE
	BALANCING COCK
	UNION
	STRAINER
	REDUCE PRESSURE BACKFLOW PREVENTER
	THERMOMETER
	GAUGE
	PRESSURE/TEMPERATURE TEST PLUG
	FLOW MEASURING DEVICE
	INDICATES PLUMBING RISER & DRAWING REFERENCE
	CW COLD WATER
	HW HOT WATER (10's)
	HWR HOT WATER RETURN
	V SANITARY VENT
	ST STORM
	S or W SOIL or WASTE
	VTR VENT THRU ROOF AND FLASH
	CO CLEANOUT
	FCO FLOOR CLEANOUT
	WCO WALL CLEANOUT
	FD FLOOR DRAIN
	FS FLOOR SINK
	HB HOSE BIBB
	ELBOW, TURNED UP
	ELBOW, TURNED DOWN
	BRANCH CONNECTION, TOP
	BRANCH CONNECTION, BOTTOM
	DIRECTION OF FLOW
	PIPE CAP OR BLIND FLANGE
	ACCESS PANEL

*NOT ALL OF THESE ITEMS ABOVE ARE ON THE PROJECT

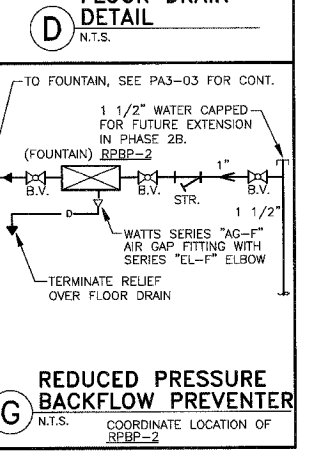
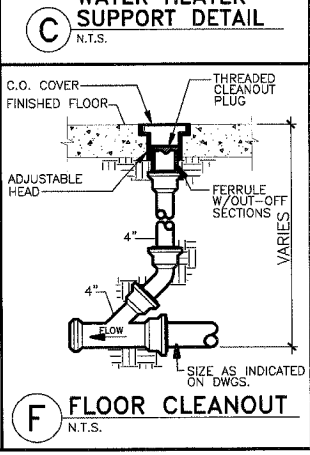
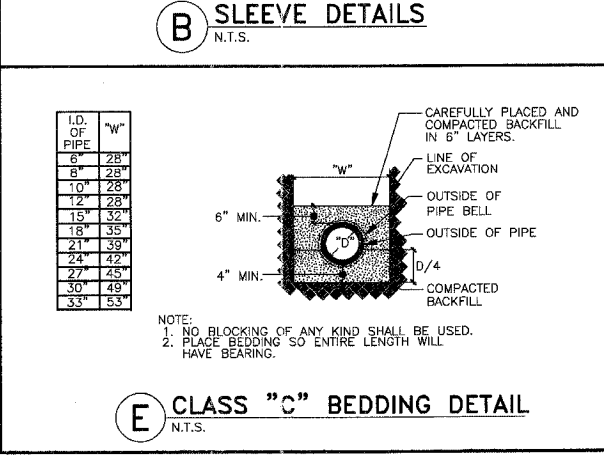
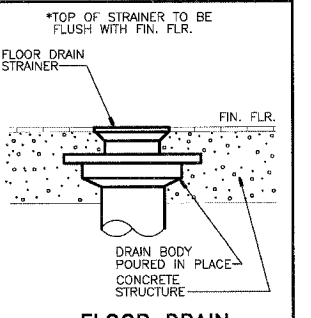
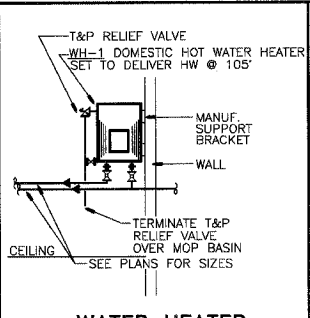
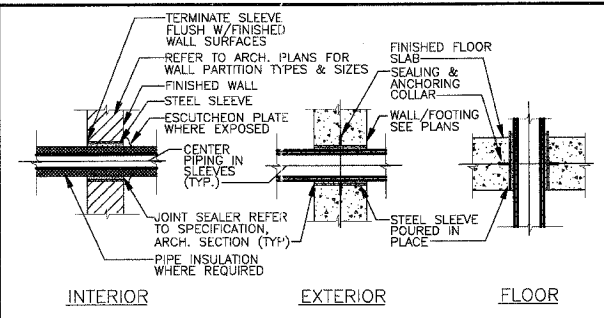
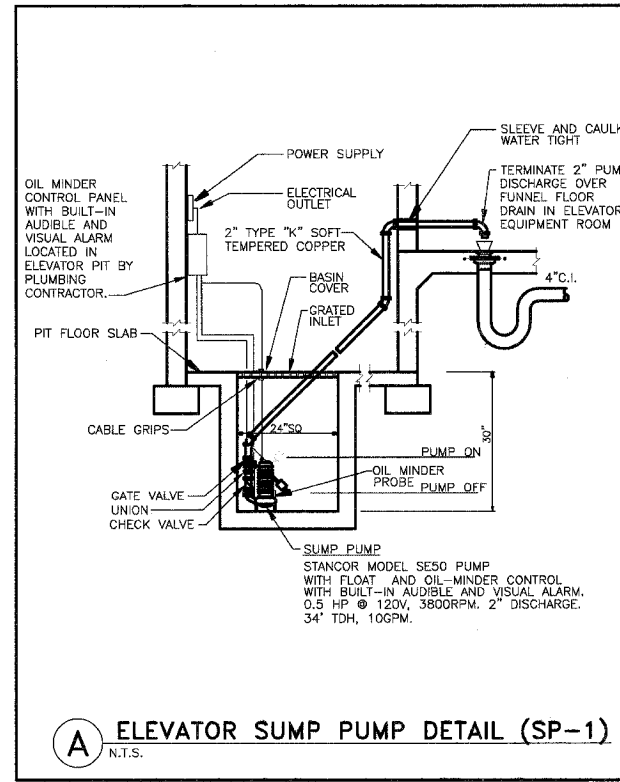

211 N. Broadway
Suite 1000
St. Louis, MO 63102
(314) 241-9188
FAX (314) 241-0125

KAI

**PHASE 2A
LEWIS AND CLARK MEMORIAL TOWER
VILLAGE OF HARTFORD, ILLINOIS
HARTFORD, ILLINOIS 62049**

SHEET TITLE:
LEGEND, SCHEDULES AND DETAILS PLUMBING

DATE	
REVISIONS	
REV. NO.	
KENNEDY PROJECT NO	KAI- 10-02048
ISSUE DATE	12-JULY-05
SHEET NO	PA4-01

© 2005 KENNEDY ASSOCIATES INCORPORATED