

PLAN
 OPTIONAL CONCRETE PIER FOUNDATION
 1 DETAIL

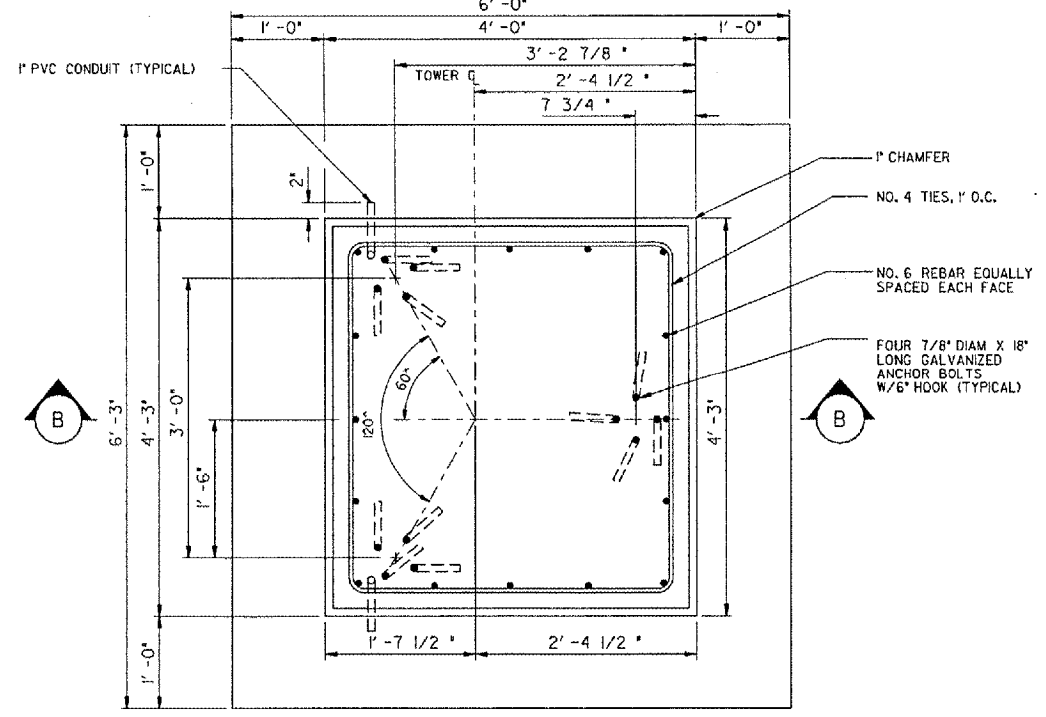

PLAN
 OPTIONAL CONCRETE BLOCK FOUNDATION
 2 DETAIL

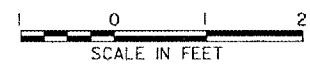
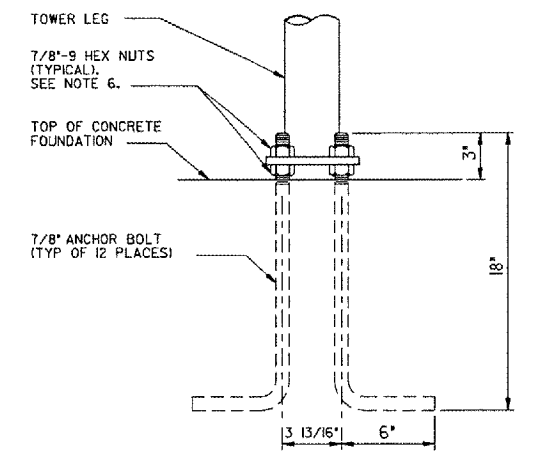
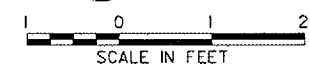

ANCHOR BOLT LAYOUT
 3 DETAIL
 SCALE: NONE

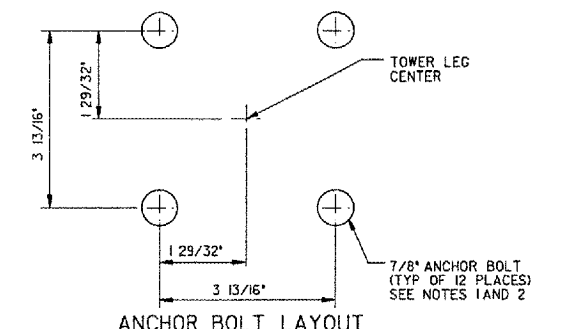

ANCHOR BOLT LAYOUT
 4 DETAIL
 SCALE: NONE

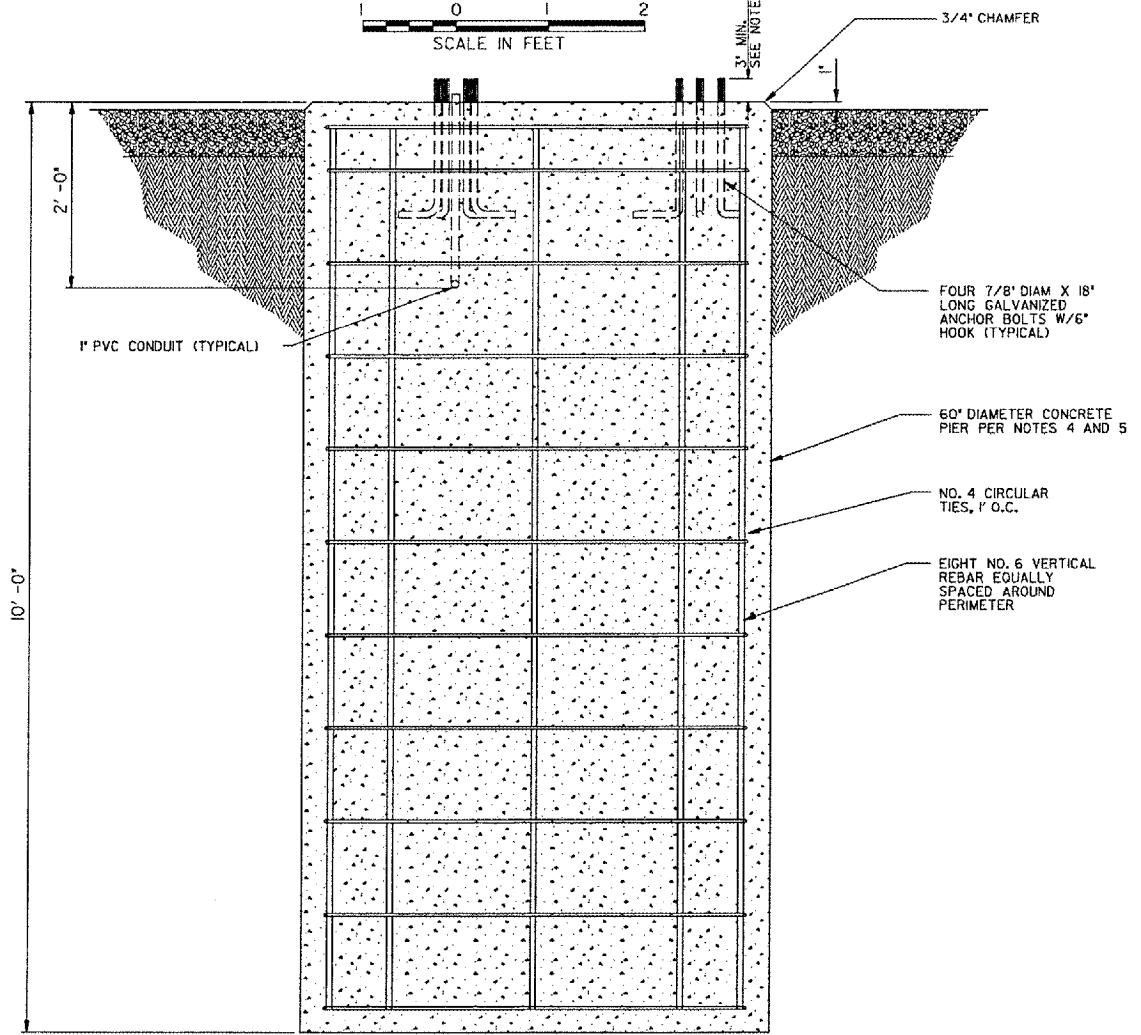

ELEVATION
 SECTION
 A

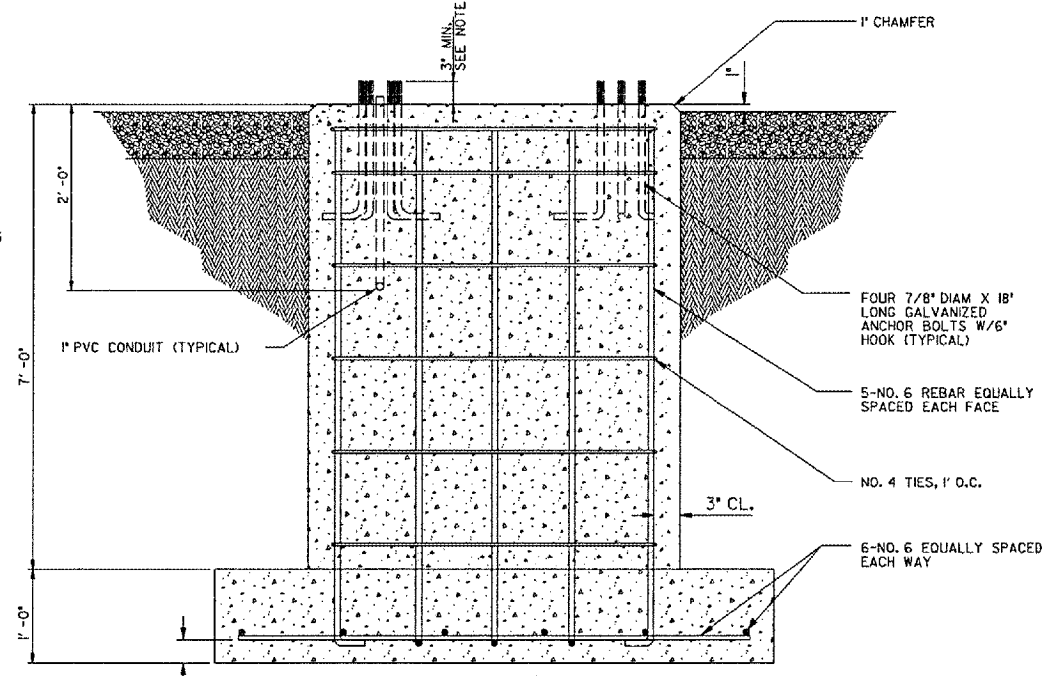

ELEVATION
 SECTION
 B

DEPARTMENT OF TRANSPORTATION FEDERAL AVIATION ADMINISTRATION GREAT LAKES REGION CHICAGO, ILLINOIS			
GLIDE SLOPE ANTENNA TOWER FOUNDATION DETAILS RUNWAY 02			
DEKALB	DEKALB TAYLOR MUNICIPAL AIRPORT	IL	
REVIEWED BY	SUBMITTED BY	APPROVED BY	
PROJ. ENGR.	ISSUED BY	PLATFORM MGR.	
DATE	TAD	DATE	JAN
DRAWN	TAD	CHICAGO HAS IMPLEMENTATION CENTER	
EGS		DRAWING NO.	REV
		DKB-D-GS02-C02	

DATE	DESCRIPTION	CHK	RESUME DATE	APVD

PLOT DATE = 03/26/2007, 01:08 PM
 FILE NAME = I:\Airports\DEKALB\803-06\ELCA\Airpor\1\Sheets\Micro-Station\Sheets\GS TWR FDN DTLS.dgn
 PLOT SCALE = 200 13/16" / 1" / IN.
 USER NAME = hde