

STATE OF ILLINOIS
DEPARTMENT OF TRANSPORTATION

ROUTE NO.	SECTION	COUNTY	TOTAL SHEETS	SHEET NO.	SHEET NO. 8
FAI 90/94	*	COOK	419	235	8 SHEETS
FED. ROAD DIST. NO.	ILLINOIS	FED. AID PROJECT			

* 2005-008F
Contract #62580

NOTES

Bar splicer assemblies shall be of an approved type and shall develop in tension at least 125 percent of the yield strength of the lapped reinforcement bars.
Splicer rods shall be of minimum 60 ksi yield strength, threaded or coiled full length.
All reinforcement bars shall be lapped and tied to the splicer rods or dowel bars.
Bar splicer assemblies shall be epoxy coated according to the requirements for reinforcement bars.
Other systems of similar design may be submitted to the Engineer for approval. Approval shall be based on certified test results from an approved testing laboratory that the proposed bar splicer assembly satisfies the following requirements:

- Minimum Capacity = $1.25 \times f_y \times A_t$
(Tension in kips)
- Minimum *Pull-out Strength = $1.25 \times f_{s,allow} \times A_t$
(Tension in kips)

Where f_y = Yield strength of lapped reinforcement bars in ksi.
 $f_{s,allow}$ = Allowable tensile stress in lapped reinforcement bars in ksi (Service Load)
 A_t = Tensile stress area of lapped reinforcement bars.
* = 28 day concrete

Bar Size to be Spliced	Splicer Rod or Dowel Bar Length	Strength Requirements	
		Min. Capacity kips - tension	Min. Pull-Out Strength kips - tension
#4	1'-8"	14.7	5.9
#5	2'-0"	23.0	9.2
#6	2'-7"	33.1	13.3
#7	3'-5"	45.1	18.0
#8	4'-6"	58.9	23.6
#9	5'-9"	75.0	30.0
#10	7'-3"	95.0	38.0
#11	9'-0"	117.4	46.8

Bar splicer assemblies shall be according to Section 508 of the Standard Specifications, except as noted. The furnishing and installation of bar splicer assemblies will be measured and paid for at the contract unit price each for "BAR SPLICERS."

The diameter of this part is equal or larger than the diameter of bar spliced.

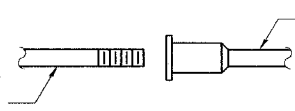

ROLLED THREAD DOWEL BAR



** ONE PIECE

Wire Connector

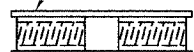

WELDED SECTIONS

BAR SPLICER ASSEMBLY ALTERNATIVES

** Heavy Hex Nuts conforming to ASTM A 563, Grade C, D or DH may be used.

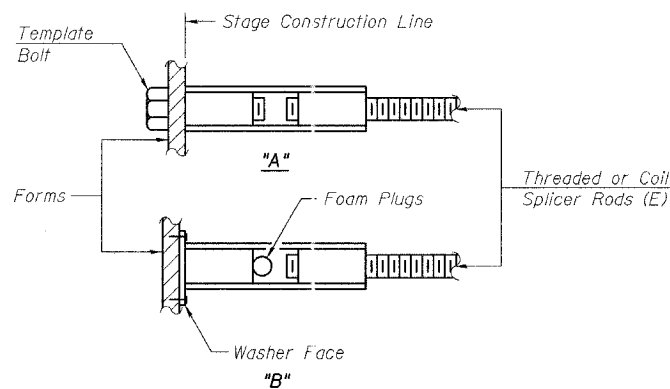

INSTALLATION AND SETTING METHODS

"A": Set bar splicer assembly by means of a template bolt.
"B": Set bar splicer assembly by nailing to wood forms or cementing to steel forms.
(E) : Indicates epoxy coating.

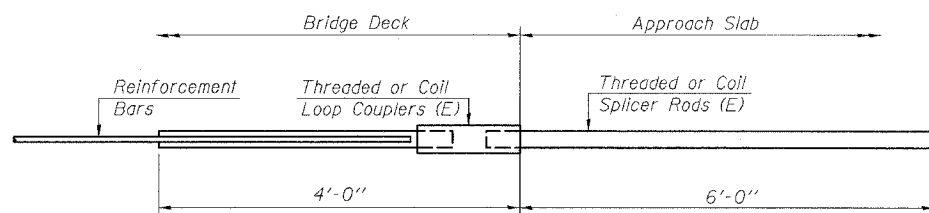

FOR INTEGRAL OR SEMI-INTEGRAL ABUTMENTS

Bar Splicer for #5 bar
Min. Capacity = 23.0 kips - tension
Min. Pull-out Strength = 9.2 kips - tension
No. Required = N/A

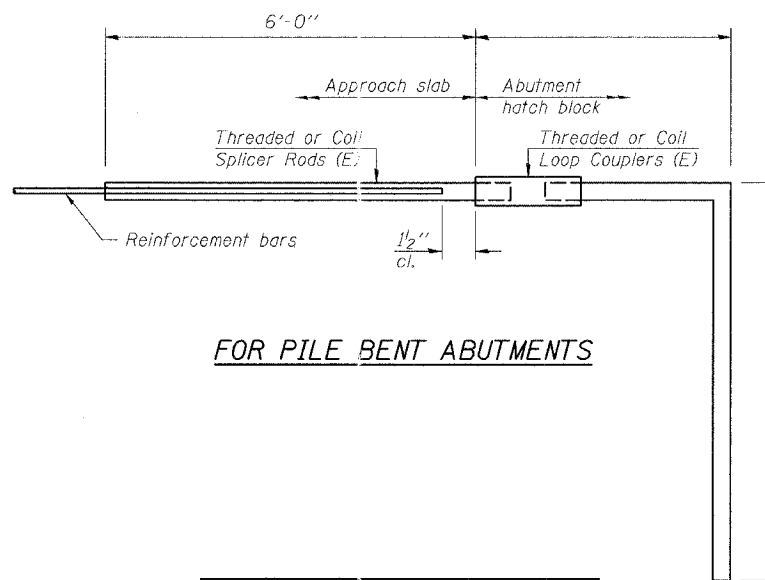

FOR PILE BENT ABUTMENTS

Bar Splicer for #5 bar
Min. Capacity = 23.0 kips - tension
Min. Pull-out Strength = 9.2 kips - tension
No. Required = N/A

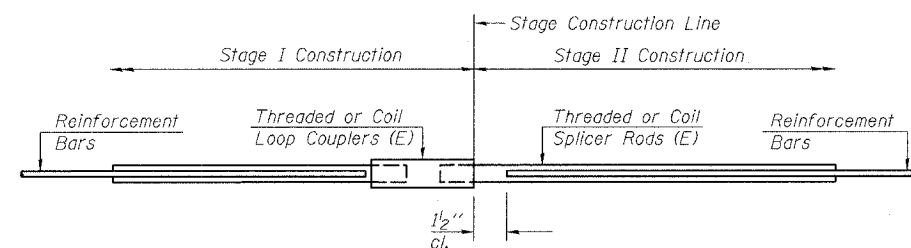

STANDARD

Bar Size	No. Assemblies Required	Location
#5	24	Deck

REVISIONS	
NAME	DATE

ILLINOIS DEPARTMENT OF TRANSPORTATION
BAR SPLICER ASSEMBLY DETAILS
F.A.I. ROUTE 90/94 NORTHBOUND (DAN RYAN EXPRESSWAY)
16TH STREET TO 18TH STREET
COOK COUNTY
S.N. 016-1111 - PIER 2

SCALE: VERT. _____
HORIZ. _____
DATE: 3/28/05
DRAWN BY: LANDREY
DESIGNED BY: SANFORD
CHECKED BY: _____
COMPUTER FILE NO. 04286-W05-NB-BS0
PROJECT 04286-W05
6/28/05-MML

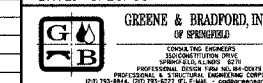

FILE NAME = \$FILES
PLOT SCALE = \$PLOTSCALE
PLOT TIME = \$PLOTTIME
PLOT OPERATOR = \$PLOTOPERATOR