

TYPICAL JOINT CROSS SECTION

EXISTING RAIL POSTS IN AREA OF REMOVAL TO BE REMOVED, STORED, AND REINSTALLED. SEE RAIL POST DETAILS.

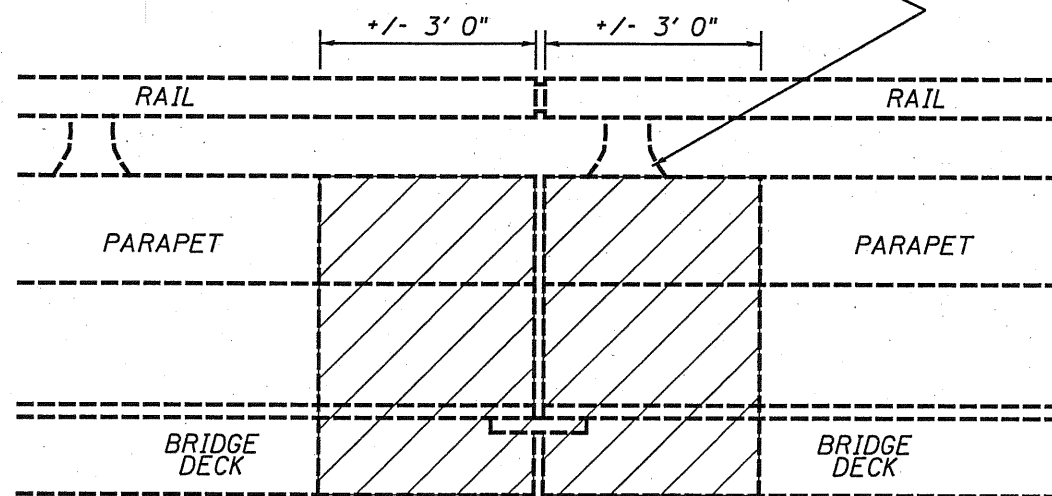

TYPICAL ELEVATION VIEW, INSIDE PARAPET FACE

NOTE: THE REMOVAL AREA SHALL BE DEFINED BY THE EXISTING COLD JOINT BETWEEN THE EXISTING EXPANSION JOINT CONCRETE AND THE EXISTING MICROSILICA BRIDGE DECK. 3' 0" WAS USED FOR QUANTITY CALCULATIONS.

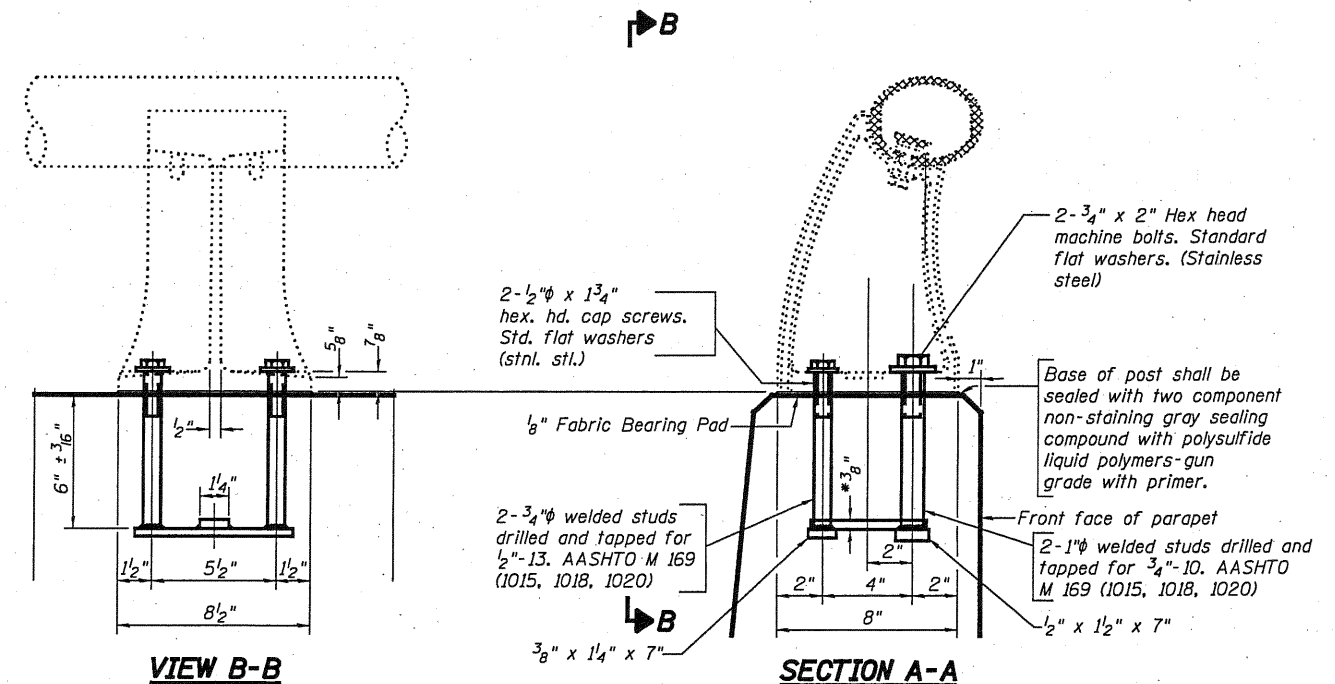

RAIL POST DETAILS

Notes:
All Posts shall be normal to parapet.
In lieu of the cast-in-place anchor device shown, the Contractor has the option of drilling and setting stainless steel anchor rods of the same diameter and grade as the specified cap screws according to Article 509.06 of the Standard Specifications. Embedment shall be according to the manufacturer's specifications.
Removal and re-erection of the existing aluminum handrail, rail post, and all new applicable hardware, including labor and installation shall be included in the cost of Concrete Removal.

CONCRETE REMOVAL DETAILS
SN 054-0042
EXP. JT. REPLACEMENT
LOGAN COUNTY