

BID PROPOSAL INSTRUCTIONS

ABOUT IDOT PROPOSALS: All proposals are potential bidding proposals. Each proposal contains all certifications and affidavits, a proposal signature sheet and a proposal bid bond.

PREQUALIFICATION

Any contractor who desires to become pre-qualified to bid on work advertised by IDOT must submit the properly completed pre-qualification forms to the Bureau of Construction no later than 4:30 p.m. prevailing time twenty-one days prior to the letting of interest. This pre-qualification requirement applies to first time contractors, contractors renewing expired ratings, contractors maintaining continuous pre-qualification or contractors requesting revised ratings. To be eligible to bid, existing pre-qualification ratings must be effective through the date of letting.

WHO CAN BID ?

Bids will be accepted from only those companies that request and receive written Authorization to Bid from IDOT's Central Bureau of Construction.

REQUESTS FOR AUTHORIZATION TO BID

Contractors wanting to bid on items included in a particular letting must submit the properly completed "Request for Authorization to Bid/or Not For Bid Status" (BDE 124) and the ORIGINAL "Affidavit of Availability" (BC 57) to the proper office no later than 4:30 p.m. prevailing time, three (3) days prior to the letting date.

WHAT CONSTITUTES WRITTEN AUTHORIZATION TO BID?

When a prospective prime bidder submits a "Request for Authorization to Bid/or Not For Bid Status"(BDE 124) he/she must indicate at that time which items are being requested For Bidding purposes. Only those items requested For Bidding will be analyzed. After the request has been analyzed, the bidder will be issued an **Authorization to Bid or Not for Bid Report**, approved by the Central Bureau of Construction and the Chief Procurement Officer that indicates which items have been approved For Bidding. If **Authorization to Bid** cannot be approved, the **Authorization to Bid or Not for Bid Report** will indicate the reason for denial.

ABOUT AUTHORIZATION TO BID

Firms that have not received an Authorization to Bid or Not For Bid Report within a reasonable time of complete and correct original document submittal should contact the Department as to the status. Firms unsure as to authorization status should call the Prequalification Section of the Bureau of Construction at the number listed at the end of these instructions.

ADDENDA AND REVISIONS

It is the bidder's responsibility to determine which, if any, addenda or revisions pertain to any project they may be bidding. Failure to incorporate all relevant addenda or revisions may cause the bid to be declared unacceptable.

Each addendum or revision will be included with the Electronic Plans and Proposals. Addenda and revisions will also be placed on the Addendum/Revision Checklist and each subscription service subscriber will be notified by e-mail of each addendum and revision issued.

The Internet is the Department's primary way of doing business. The subscription service emails are an added courtesy the Department provides. It is suggested that bidders check IDOT's website at <http://www.dot.il.gov/desenv/delett.html> before submitting final bid information.

IDOT IS NOT RESPONSIBLE FOR ANY E-MAIL FAILURES.

Addenda questions may be directed to the Contracts Office at (217)782-7806 or DOT.D&Econtracts@illinois.gov

Technical questions about downloading these files may be directed to Tim Garman at (217)524-1642 or Timothy.Garman@illinois.gov.

STANDARD GUIDELINES FOR SUBMITTING BIDS

- All pages should be single sided.
- Use the Cover Page that is provided in the Bid Proposal (posted on the IDOT Web Site) as the first page of your submitted bid. It has the item number in large bold type in the upper left-hand corner and lines provided for your company name and address in the upper right-hand corner.
- Do not use report covers, presentation folders or special bindings and do not staple multiple times on left side like a book. Use only 1 staple in the upper left hand corner. Make sure all elements of your bid are stapled together including the bid bond or guaranty check (if required).
- Do not include any certificates of eligibility, your authorization to bid, Addendum Letters or affidavit of availability.
- Do not include the Subcontractor Documentation with your bid (pages i – iii and pages a – g). This documentation is required only if you are awarded the project.
- Use the envelope cover sheet (provided with the proposal) as the cover for the proposal envelope.
- Do not rely on overnight services to deliver your proposal prior to 10 AM on letting day. It will not be read if it is delivered after 10 AM.
- Do not submit your Substance Abuse Prevention Program (SAPP) with your bid. If you are awarded the contract this form is to be submitted to the district engineer at the pre-construction conference.

BID SUBMITTAL CHECKLIST

- Cover page** (the sheet that has the item number on it) – This should be the first page of your bid proposal, **followed by your bid (the Schedule of Prices/Pay Items)**. If you are using special software or CBID to generate your schedule of prices, do not include the blank pages of the schedule of prices that came with the proposal package.
- Page 4 (Item 9)** – Check “YES” if you will use a subcontractor(s) with an annual value over \$50,000. Include the subcontractor(s) name, address, general type of work to be performed and the dollar amount. If you will use subcontractor(s) but are uncertain who or the dollar amount; check “YES” but leave the lines blank.
- After page 4** – Insert the following documents: The **Illinois Office Affidavit** (Not applicable to federally funded projects) followed by Cost Adjustments for Steel, Bituminous and Fuel (if applicable) and the Contractor Letter of Assent (if applicable). The general rule should be, if you don’t know where it goes, put it after page 4.
- Page 10 (Paragraph J)** – Check “YES” or “NO” whether your company has any business in Iran.
- Page 10 (Paragraph K)** – (Not applicable to federally funded projects) List the name of the apprenticeship and training program sponsor holding the certificate of registration from the US Department of Labor. If no applicable program exists, please indicate the work/job category **Your bid will not be read if this is not completed.** Do not include certificates with your bid. Keep the certificates in your office in case they are requested by IDOT.
- Page 11 (Paragraph L)** – A copy of your State Board of Elections certificate of registration is no longer required with your bid.
- Page 11 (Paragraph M)** – Indicate if your company has hired a lobbyist in connection with the job for which you are submitting the bid proposal.
- Page 12 (Paragraph C)** – This is a work sheet to determine if a completed Form A is required. It is not part of the form and you do not need to make copies for each completed Form A.
- Pages 14-17 (Form A)** – One Form A (4 pages) is required for each applicable person in your company. Copies of the forms can be used and only need to be changed when the information changes. The certification signature and date must be original for each letting. **Do not staple the forms together.** If you answered “NO” to all of the questions in Paragraph C (page 12), complete the first section (page 14) with your company information and then sign and date the Not Applicable statement on page 17.
- Page 18 (Form B)** - If you check “YES” to having other current or pending contracts it is acceptable to use the phrase, “See Affidavit of Availability on file”. **Ownership Certification** (at the bottom of the page) - Check N/A if the Form A(s) you submitted accounts for 100 percent of the company ownership. Check YES if any percentage of ownership falls outside of the parameters that require reporting on the Form A. Checking NO indicates that the Form A(s) you submitted is not correct and you will be required to submit a revised Form A.
- Page 20 (Workforce Projection)** – Be sure to include the Duration of the Project. It is acceptable to use the phrase “Per Contract Specifications”.

Proposal Bid Bond – (Insert after the proposal signature page) Submit your proposal Proposal Bid Bond (if applicable) using the current Proposal Bid Bond form provided in the proposal package. The Power of Attorney page should be stapled to the Proposal Bid Bond. If you are using an electronic bond, include your bid bond number on the Proposal Bid Bond and attach the Proof of Insurance printed from the Surety’s Web Site.

Disadvantaged Business Utilization Plan and/or Good Faith Effort – The last items in your bid should be the DBE Utilization Plan (SBE 2026), followed by the DBE Participation Statement (SBE 2025) and supporting paperwork. If you have documentation of a Good Faith Effort, it is to follow the SBE Forms.

The Bid Letting is now available in streaming Audio/Video from the IDOT Web Site. A link to the stream will be placed on the main page of the current letting on the day of the Letting. The stream will not begin until 10 AM. The actual reading of the bids does not begin until approximately 10:30 AM.

Following the Letting, the As-Read Tabulation of Bids will be posted by the end of the day. You will find the link on the main Web page for the current letting.

QUESTIONS: pre-letting up to execution of the contract

Contractor pre-qualification	217-782-3413
Small Business, Disadvantaged Business Enterprise (DBE)	217-785-4611
Contracts, Bids, Letting process or Internet downloads	217-782-7806
Estimates Unit.....	217-785-3483
Aeronautics.....	217-785-8515
IDNR (Land Reclamation, Water Resources, Natural Resources).....	217-782-6302

QUESTIONS: following contract execution

Subcontractor documentation, payments	217-782-3413
Railroad Insurance	217-785-0275

RETURN WITH BID

14

Proposal Submitted By
Name
Address
City

Letting November 8, 2013

NOTICE TO PROSPECTIVE BIDDERS

This proposal can be used for bidding purposes by only those companies that request and receive written AUTHORIZATION TO BID from IDOT's Central Bureau of Construction.

BIDDERS NEED NOT RETURN THE ENTIRE PROPOSAL

**Notice to Bidders,
Specifications,
Proposal, Contract
and Contract Bond**



**Illinois Department
of Transportation**

Springfield, Illinois 62764

**Contract No. 63863
KANE County
Section 09-00286-00-BR (Aurora)
Route FAU 1503 (Indian Trail Road)
Project BRM-9003(510)
District 1 Construction Funds**

PLEASE MARK THE APPROPRIATE BOX BELOW:

- A Bid Bond is included.
- A Cashier's Check or a Certified Check is included

Prepared by

F

Checked by

(Printed by authority of the State of Illinois)

Page intentionally left blank

RETURN WITH BID



PROPOSAL

TO THE DEPARTMENT OF TRANSPORTATION

1. Proposal of _____

Taxpayer Identification Number (Mandatory) _____

For the improvement identified and advertised for bids in the Invitation for Bids as:

**Contract No. 63863
KANE County
Section 09-00286-00-BR (Aurora)
Project BRM-9003(510)
Route FAU 1503 (Indian Trail Road)
District 1 Construction Funds**

Work consists of widening and deck replacement of the two structures carrying Indian Trail Road over the Fox River in the City of Aurora. Project will include pavement removal, PCC pavement, sidewalk, curb and gutter, storm sewer, lighting and all incidental work to complete the project.

2. The undersigned bidder will furnish all labor, material and equipment to complete the above described project in a good and workmanlike manner as provided in the contract documents provided by the Department of Transportation. This proposal will become part of the contract and the terms and conditions contained in the contract documents will govern performance and payments.

RETURN WITH BID

3. **ASSURANCE OF EXAMINATION AND INSPECTION/WAIVER.** The undersigned bidder further declares that he/she has carefully examined the proposal, plans, specifications, addenda form of contract and contract bond, and special provisions, and that he/she has inspected in detail the site of the proposed work, and that he/she has familiarized themselves with all of the local conditions affecting the contract and the detailed requirements of construction, and understands that in making this bid proposal he/she waives all right to plead any misunderstanding regarding the same.

4. **EXECUTION OF CONTRACT AND CONTRACT BOND.** The undersigned bidder further agrees to execute a contract for this work and present the same to the department within fifteen (15) days after the contract has been mailed to him/her. The undersigned further agrees that he/she and his/her surety will execute and present within fifteen (15) days after the contract has been mailed to him/her contract bond satisfactory to and in the form prescribed by the Department of Transportation, in the penal sum of the full amount of the contract, or as specified in the special provisions, guaranteeing the faithful performance of the work in accordance with the terms of the contract.

5. **PROPOSAL GUARANTY.** Accompanying this proposal is either a bid bond on the department form, executed by a corporate surety company satisfactory to the department, or a proposal guaranty check consisting of a bank cashier's check or a properly certified check for not less than 5 per cent of the amount bid or for the amount specified in the following schedule:

<u>Amount of Bid</u>		<u>Proposal Guaranty</u>	<u>Amount of Bid</u>		<u>Proposal Guaranty</u>	
Up to	\$5,000	\$150	\$2,000,000	to	\$3,000,000	\$100,000
\$5,000	to	\$300	\$3,000,000	to	\$5,000,000	\$150,000
\$10,000	to	\$1,000	\$5,000,000	to	\$7,500,000	\$250,000
\$50,000	to	\$3,000	\$7,500,000	to	\$10,000,000	\$400,000
\$100,000	to	\$5,000	\$10,000,000	to	\$15,000,000	\$500,000
\$150,000	to	\$7,500	\$15,000,000	to	\$20,000,000	\$600,000
\$250,000	to	\$12,500	\$20,000,000	to	\$25,000,000	\$700,000
\$500,000	to	\$25,000	\$25,000,000	to	\$30,000,000	\$800,000
\$1,000,000	to	\$50,000	\$30,000,000	to	\$35,000,000	\$900,000
\$1,500,000	to	\$75,000	over		\$35,000,000	\$1,000,000

Bank cashier's checks or properly certified checks accompanying bid proposals will be made payable to the Treasurer, State of Illinois.

If a combination bid is submitted, the proposal guaranties which accompany the individual bid proposals making up the combination will be considered as also covering the combination bid.

The amount of the proposal guaranty check is _____ \$(_____). If this proposal is accepted and the undersigned will fail to execute a contract bond as required herein, it is hereby agreed that the amount of the proposal guaranty will become the property of the State of Illinois, and shall be considered as payment of damages due to delay and other causes suffered by the State because of the failure to execute said contract and contract bond; otherwise, the bid bond will become void or the proposal guaranty check will be returned to the undersigned.

Attach Cashier's Check or Certified Check Here

In the event that one proposal guaranty check is intended to cover two or more bid proposals, the amount must be equal to the sum of the proposal guaranties which would be required for each individual bid proposal. If the guaranty check is placed in another bid proposal, state below where it may be found.

The proposal guaranty check will be found in the bid proposal for:

Item _____

Section No. _____

County _____

Mark the proposal cover sheet as to the type of proposal guaranty submitted.

RETURN WITH BID

6. **COMBINATION BIDS.** The undersigned bidder further agrees that if awarded the contract for the sections contained in the following combination, he/she will perform the work in accordance with the requirements of each individual contract comprising the combination bid specified in the schedule below, and that the combination bid shall be prorated against each section in proportion to the bid submitted for the same. If an error is found to exist in the gross sum bid for one or more of the individual sections included in a combination, the combination bid shall be corrected as provided in the specifications.

When a combination bid is submitted, the schedule below must be completed in each proposal comprising the combination.

If alternate bids are submitted for one or more of the sections comprising the combination, a combination bid must be submitted for each alternate.

Schedule of Combination Bids

Combination No.	Sections Included in Combination	Combination Bid	
		Dollars	Cents

7. **SCHEDULE OF PRICES.** The undersigned bidder submits herewith, in accordance with the rules and instructions, a schedule of prices for the items of work for which bids are sought. The unit prices bid are in U.S. dollars and cents, and all extensions and summations have been made. The bidder understands that the quantities appearing in the bid schedule are approximate and are provided for the purpose of obtaining a gross sum for the comparison of bids. If there is an error in the extension of the unit prices, the unit prices will govern. Payment to the contractor awarded the contract will be made only for actual quantities of work performed and accepted or materials furnished according to the contract. The scheduled quantities of work to be done and materials to be furnished may be increased, decreased or omitted as provided elsewhere in the contract.
8. **AUTHORITY TO DO BUSINESS IN ILLINOIS.** Section 20-43 of the Illinois Procurement Code (the Code) (30 ILCS 500/20-43) provides that a person (other than an individual acting as a sole proprietor) must be a legal entity authorized to do business in the State of Illinois prior to submitting the bid.
9. **EXECUTION OF CONTRACT:** The Department of Transportation will, in accordance with the rules governing Department procurements, execute the contract and shall be the sole entity having the authority to accept performance and make payments under the contract. Execution of the contract by the Chief Procurement Officer (CPO) or the State Purchasing Officer (SPO) is for approval of the procurement process and execution of the contract by the Department. Neither the CPO nor the SPO shall be responsible for administration of the contract or determinations respecting performance or payment there under except as otherwise permitted in the Code.
10. **The services of a subcontractor will be used.**

Check box Yes
 Check box No

For known subcontractors with subcontracts with an annual value of more than \$50,000, the contract shall include their name, address, general type of work to be performed, and the dollar allocation for each subcontractor.
 (30 ILCS 500/20-120)

COUNTY NAME	CODE	DIST	SECTION NUMBER	PROJECT NUMBER	ROUTE
KANE	089	01	09-00286-00-BR (AURORA)	BRM-9003/510/000	FAU 1503

ITEM NUMBER	PAY ITEM DESCRIPTION	UNIT OF MEASURE	QUANTITY	UNIT PRICE		TOTAL PRICE	
				DOLLARS	CENTS	DOLLARS	CTS
A2000112	T-ACERX FREM AB 1-1/2	EACH	6.000 X	=			
A2001012	T-ACER RUBRUM 1-1/2	EACH	8.000 X	=			
A2002280	T-ALNUS RUGOSA CL 5'	EACH	5.000 X	=			
A2002912	T-CELTIS OCCID 1-1/2	EACH	2.000 X	=			
A2004610	T-GLEDIT TRI IN PER 2	EACH	3.000 X	=			
A2005814	T-PLATANUS OCC 1-3/4	EACH	3.000 X	=			
A2006512	T-QUERCUS BICOL 1-1/2	EACH	10.000 X	=			
A2006912	T-QUERCUS PALUS 1-1/2	EACH	4.000 X	=			
A2007112	T-QUERCUS RUBRA 1-1/2	EACH	6.000 X	=			
A2007814	T-TILIA AMER 1-3/4	EACH	2.000 X	=			
K0029634	WEED CONTR PRE-EM GRN	POUND	5.000 X	=			
XX008424	LIGHT FIX ASSY TYPE A	EACH	10.000 X	=			
XX008425	LIGHT FIX ASSY TYPE B	EACH	8.000 X	=			
X0324198	REMOV ASB CEM CONDUIT	FOOT	3,556.000 X	=			
X0325862	CONC BR RAILING	FOOT	1,757.000 X	=			

FAU 1503
 09-00286-00-BR (AURORA)
 KANE

ILLINOIS DEPARTMENT OF TRANSPORTATION
 SCHEDULE OF PRICES
 CONTRACT NUMBER - 63863

ECMS002 DTGECM03 ECMR003 PAGE 2
 RUN DATE - 10/02/13
 RUN TIME - 183103

ITEM NUMBER	PAY ITEM DESCRIPTION	UNIT OF MEASURE	QUANTITY	UNIT PRICE		TOTAL PRICE	
				DOLLARS	CENTS	DOLLARS	CTS
X0540000	BRICK PAVERS	SQ FT	640.000 X	=			
X2510635	HD EROS CONT BLANK SP	SQ YD	18,500.000 X	=			
X4240440	PC CONC SIDEWALK 6 SP	SQ FT	780.000 X	=			
X5091755	PARAPET RAILING SPL	FOOT	1,441.000 X	=			
X5150110	NAME PLATES SPL	EACH	4.000 X	=			
X5860110	GRANULAR BACKFILL STR	CU YD	708.800 X	=			
X6020084	MANHOLE SPECIAL	EACH	2.000 X	=			
X6310190	TBT T1 SPL FLAR MOD	EACH	2.000 X	=			
X7010216	TRAF CONT & PROT SPL	L SUM	1.000 X	=			
Z0001899	JACK & REM EX BEARING	EACH	91.000 X	=			
Z0004556	HMA SURFACE RM (DECK)	SQ YD	4,352.000 X	=			
Z0007101	C&D LEAD PT CL RS N1	L SUM	1.000 X	=			
Z0007102	C&D LEAD PT CL RS N2	L SUM	1.000 X	=			
Z0007430	TEMP SIDEWALK	SQ FT	895.000 X	=			
Z0010501	CLEAN & PT STL BR N1	L SUM	1.000 X	=			

FAU 1503
09-00286-00-BR
KANE

(AURORA)

ILLINOIS DEPARTMENT OF TRANSPORTATION
SCHEDULE OF PRICES
CONTRACT NUMBER - 63863

ECMS002 DTGECM03 ECMR003 PAGE 3
RUN DATE - 10/02/13
RUN TIME - 183103

ITEM NUMBER	PAY ITEM DESCRIPTION	UNIT OF MEASURE	QUANTITY	UNIT PRICE		TOTAL PRICE	
				DOLLARS	CENTS	DOLLARS	CTS
Z0010502	CLEAN & PT STL BR N2	L SUM	1.000 X	=			
Z0012754	STR REP CON DP = < 5	SQ FT	668.000 X	=			
Z0013798	CONSTRUCTION LAYOUT	L SUM	1.000 X	=			
Z0018010	DRAINAGE SCUPPR DS-33	EACH	32.000 X	=			
Z0022800	FENCE REMOVAL	FOOT	370.000 X	=			
Z0030850	TEMP INFO SIGNING	SQ FT	204.000 X	=			
Z0033028	MAINTAIN LIGHTING SYS	CAL MO	24.000 X	=			
Z0048665	RR PROT LIABILITY INS	L SUM	1.000 X	=			
Z0062456	TEMP PAVEMENT	SQ YD	103.000 X	=			
Z0068426	STEEL CASINGS 66	FOOT	24.000 X	=			
Z0076600	TRAINEES	HOUR	1,500.000 X	=	0.80		1,200.00
Z0076604	TRAINEES TPG	HOUR	1,500.000 X	=	10.00		15,000.00
20100110	TREE REMOV 6-15	UNIT	478.000 X	=			
20100210	TREE REMOV OVER 15	UNIT	166.000 X	=			
20101000	TEMPORARY FENCE	FOOT	220.000 X	=			

FAU 1503
 09-00286-00-BR (AURORA)
 KANE

ILLINOIS DEPARTMENT OF TRANSPORTATION
 SCHEDULE OF PRICES
 CONTRACT NUMBER - 63863

ECMS002 DTGECM03 ECMR003 PAGE 4
 RUN DATE - 10/02/13
 RUN TIME - 183103

ITEM NUMBER	PAY ITEM DESCRIPTION	UNIT OF MEASURE	QUANTITY	UNIT PRICE		TOTAL PRICE	
				DOLLARS	CENTS	DOLLARS	CTS
20200100	EARTH EXCAVATION	CU YD	1,437.600 X	=			
20201200	REM & DISP UNS MATL	CU YD	140.000 X	=			
20400800	FURNISHED EXCAVATION	CU YD	1,320.700 X	=			
20800150	TRENCH BACKFILL	CU YD	184.000 X	=			
21001000	GEOTECH FAB F/GR STAB	SQ YD	190.000 X	=			
21101615	TOPSOIL F & P 4	SQ YD	18,500.000 X	=			
25000210	SEEDING CL 2A	ACRE	1.800 X	=			
25000310	SEEDING CL 4	ACRE	2.500 X	=			
25000400	NITROGEN FERT NUTR	POUND	344.000 X	=			
25000600	POTASSIUM FERT NUTR	POUND	344.000 X	=			
28000250	TEMP EROS CONTR SEED	POUND	383.000 X	=			
28000305	TEMP DITCH CHECKS	FOOT	150.000 X	=			
28000400	PERIMETER EROS BAR	FOOT	3,050.000 X	=			
28000500	INLET & PIPE PROTECT	EACH	4.000 X	=			
28000510	INLET FILTERS	EACH	11.000 X	=			

ITEM NUMBER	PAY ITEM DESCRIPTION	UNIT OF MEASURE	QUANTITY	UNIT PRICE		TOTAL PRICE	
				DOLLARS	CENTS	DOLLARS	CTS
28100107	STONE RIPRAP CL A4	SQ YD	1,027.000 X	=			
28100111	STONE RIPRAP CL A6	SQ YD	50.000 X	=			
28200200	FILTER FABRIC	SQ YD	1,025.000 X	=			
30300001	AGG SUBGRADE IMPROVE	CU YD	64.000 X	=			
30300112	AGG SUBGRADE IMPR 12	SQ YD	4,130.000 X	=			
31101200	SUB GRAN MAT B 4	SQ YD	1,185.000 X	=			
40600100	BIT MATLS PR CT	GALLON	200.000 X	=			
40600300	AGG PR CT	TON	4.000 X	=			
40603335	HMA SC "D" N50	TON	275.000 X	=			
42000540	PCC PVT 12	SQ YD	3,790.000 X	=			
42001300	PROTECTIVE COAT	SQ YD	5,388.000 X	=			
42300400	PCC DRIVEWAY PAVT 8	SQ YD	430.000 X	=			
42400300	PC CONC SIDEWALK 6	SQ FT	6,515.000 X	=			
42400800	DETECTABLE WARNINGS	SQ FT	220.000 X	=			
44000100	PAVEMENT REM	SQ YD	4,135.000 X	=			

FAU 1503
 09-00286-00-BR
 KANE

(AURORA)

ILLINOIS DEPARTMENT OF TRANSPORTATION
 SCHEDULE OF PRICES
 CONTRACT NUMBER - 63863

ECMS002 DTGECM03 ECMR003
 RUN DATE - 10/02/13
 RUN TIME - 183103

ITEM NUMBER	PAY ITEM DESCRIPTION	UNIT OF MEASURE	QUANTITY	UNIT PRICE		TOTAL PRICE	
				DOLLARS	CENTS	DOLLARS	CTS
44000157	HMA SURF REM 2	SQ YD	2,420.000 X	=	=	=	=
44000200	DRIVE PAVEMENT REM	SQ YD	455.000 X	=	=	=	=
44000500	COMB CURB GUTTER REM	FOOT	1,995.000 X	=	=	=	=
44000600	SIDEWALK REM	SQ FT	6,110.000 X	=	=	=	=
44003100	MEDIAN REMOVAL	SQ FT	1,110.000 X	=	=	=	=
44004000	PAVED DITCH REMOVAL	FOOT	300.000 X	=	=	=	=
50102400	CONC REM	CU YD	153.500 X	=	=	=	=
50104400	CONC HDWL REM	EACH	5.000 X	=	=	=	=
50104701	REM EX CONC DECK N1	EACH	1.000 X	=	=	=	=
50104702	REM EX CONC DECK N2	EACH	1.000 X	=	=	=	=
50157300	PROTECTIVE SHIELD	SQ YD	134.000 X	=	=	=	=
50200100	STRUCTURE EXCAVATION	CU YD	767.200 X	=	=	=	=
50200300	COFFERDAM EXCAVATION	CU YD	179.700 X	=	=	=	=
50200400	ROCK EXC STRUCT	CU YD	370.100 X	=	=	=	=
50201101	COFFERDAM TYP 1 LOC 1	EACH	1.000 X	=	=	=	=

ITEM NUMBER	PAY ITEM DESCRIPTION	UNIT OF MEASURE	QUANTITY	UNIT PRICE		TOTAL PRICE	
				DOLLARS	CENTS	DOLLARS	CTS
50201121	COFFERDAM TYP 2 LOC 1	EACH	1.000 X	=			
50201122	COFFERDAM TYP 2 LOC 2	EACH	1.000 X	=			
50201123	COFFERDAM TYP 2 LOC 3	EACH	1.000 X	=			
50201124	COFFERDAM TYP 2 LOC 4	EACH	1.000 X	=			
50300225	CONC STRUCT	CU YD	1,137.400 X	=			
50300255	CONC SUP-STR	CU YD	2,183.100 X	=			
50300260	BR DECK GROOVING	SQ YD	5,179.000 X	=			
50300265	SEAL COAT CONC	CU YD	151.000 X	=			
50300300	PROTECTIVE COAT	SQ YD	7,433.000 X	=			
50500105	F & E STRUCT STEEL	L SUM	1.000 X	=			
50500505	STUD SHEAR CONNECTORS	EACH	24,572.000 X	=			
50800205	REINF BARS, EPOXY CTD	POUND	684,130.000 X	=			
50800515	BAR SPLICERS	EACH	238.000 X	=			
51201610	FUR STL PILE HP12X63	FOOT	974.000 X	=			
51202305	DRIVING PILES	FOOT	974.000 X	=			

FAU 1503
 09-00286-00-BR (AURORA)
 KANE

ILLINOIS DEPARTMENT OF TRANSPORTATION
 SCHEDULE OF PRICES
 CONTRACT NUMBER - 63863

ECMS002 DTGECM03 ECMR003 PAGE 8
 RUN DATE - 10/02/13
 RUN TIME - 183103

ITEM NUMBER	PAY ITEM DESCRIPTION	UNIT OF MEASURE	QUANTITY	UNIT PRICE		TOTAL PRICE	
				DOLLARS	CENTS	DOLLARS	CTS
51203610	TEST PILE ST HP12X63	EACH	5.000 X	=	=	=	=
51204650	PILE SHOES	EACH	54.000 X	=	=	=	=
51500100	NAME PLATES	EACH	2.000 X	=	=	=	=
52000110	PREF JT STRIP SEAL	FOOT	383.000 X	=	=	=	=
52100020	ELAST BEARING ASSY T2	EACH	90.000 X	=	=	=	=
52100520	ANCHOR BOLTS 1	EACH	234.000 X	=	=	=	=
54213663	PRC FLAR END SEC 18	EACH	1.000 X	=	=	=	=
54213687	PRC FLAR END SEC 42 f	EACH	1.000 X	=	=	=	=
550A0330	STORM SEW CL A 2 10	FOOT	10.000 X	=	=	=	=
550A0340	STORM SEW CL A 2 12	FOOT	275.000 X	=	=	=	=
550A0380	STORM SEW CL A 2 18	FOOT	137.000 X	=	=	=	=
550A0470	STORM SEW CL A 2 42	FOOT	385.000 X	=	=	=	=
550A0770	STORM SEW CL A 3 42	FOOT	41.000 X	=	=	=	=
55100200	STORM SEWER REM 6	FOOT	32.000 X	=	=	=	=
55100500	STORM SEWER REM 12	FOOT	119.000 X	=	=	=	=

FAU 1503
 09-00286-00-BR
 KANE

(AURORA)

ILLINOIS DEPARTMENT OF TRANSPORTATION
 SCHEDULE OF PRICES
 CONTRACT NUMBER - 63863

ECMS002 DTGECM03 ECMR003 PAGE 9
 RUN DATE - 10/02/13
 RUN TIME - 183103

ITEM NUMBER	PAY ITEM DESCRIPTION	UNIT OF MEASURE	QUANTITY	UNIT PRICE		TOTAL PRICE	
				DOLLARS	CENTS	DOLLARS	CTS
55101800	STORM SEWER REM 42	FOOT	177.000 X	=			
58700300	CONCRETE SEALER	SQ FT	2,447.000 X	=			
59000200	EPOXY CRACK INJECTION	FOOT	650.000 X	=			
59100100	GEOCOMPOSITE WALL DR	SQ YD	169.000 X	=			
59300100	CONTR LOW-STRENG MATL	CU YD	43.200 X	=			
60201105	CB TA 4 DIA T11F&G	EACH	5.000 X	=			
60218400	MAN TA 4 DIA T1F CL	EACH	2.000 X	=			
60223800	MAN TA 6 DIA T1F CL	EACH	1.000 X	=			
60224005	MAN TA 6 DIA T8G	EACH	3.000 X	=			
60236800	INLETS TA T11F&G	EACH	6.000 X	=			
60250200	CB ADJUST	EACH	2.000 X	=			
60251500	CB ADJ NEW T11F&G	EACH	1.000 X	=			
60260100	INLETS ADJUST	EACH	1.000 X	=			
60500040	REMOV MANHOLES	EACH	1.000 X	=			
60500050	REMOV CATCH BAS	EACH	2.000 X	=			

FAU 1503
 09-00286-00-BR (AURORA)
 KANE

ILLINOIS DEPARTMENT OF TRANSPORTATION
 SCHEDULE OF PRICES
 CONTRACT NUMBER - 63863

ECMS002 DTGECM03 ECMR003 PAGE 10
 RUN DATE - 10/02/13
 RUN TIME - 183103

ITEM NUMBER	PAY ITEM DESCRIPTION	UNIT OF MEASURE	QUANTITY	UNIT PRICE		TOTAL PRICE	
				DOLLARS	CENTS	DOLLARS	CTS
60500060	REMOV INLETS	EACH	3.000 X	=	=	=	=
60603800	COMB CC&G TB6.12	FOOT	2,090.000 X	=	=	=	=
63000003	SPBGR TY A 9FT POSTS	FOOT	320.000 X	=	=	=	=
63100070	TRAF BAR TERM T5	EACH	1.000 X	=	=	=	=
63100085	TRAF BAR TERM T6	EACH	4.000 X	=	=	=	=
63200310	GUARDRAIL REMOV	FOOT	435.000 X	=	=	=	=
66900200	NON SPL WASTE DISPOSL	CU YD	500.000 X	=	=	=	=
67000400	ENGR FIELD OFFICE A	CAL MO	24.000 X	=	=	=	=
67100100	MOBILIZATION	L SUM	1.000 X	=	=	=	=
70103815	TR CONT SURVEILLANCE	CAL DA	150.000 X	=	=	=	=
70106800	CHANGEABLE MESSAGE SN	CAL MO	72.000 X	=	=	=	=
70300100	SHORT TERM PAVT MKING	FOOT	1,000.000 X	=	=	=	=
70300510	PAVT MARK TAPE T3 L&S	SQ FT	75.000 X	=	=	=	=
70300520	PAVT MARK TAPE T3 4	FOOT	4,075.000 X	=	=	=	=
70300540	PAVT MARK TAPE T3 6	FOOT	165.000 X	=	=	=	=

ITEM NUMBER	PAY ITEM DESCRIPTION	UNIT OF MEASURE	QUANTITY	UNIT PRICE		TOTAL PRICE	
				DOLLARS	CENTS	DOLLARS	CTS
70300570	PAVT MARK TAPE T3 24	FOOT	60.000 X	=	=	=	=
70301000	WORK ZONE PAVT MK REM	SQ FT	1,970.000 X	=	=	=	=
78000200	THPL PVT MK LINE 4	FOOT	450.000 X	=	=	=	=
78005100	EPOXY PVT MK LTR-SYM	SQ FT	235.000 X	=	=	=	=
78005110	EPOXY PVT MK LINE 4	FOOT	5,720.000 X	=	=	=	=
78005130	EPOXY PVT MK LINE 6	FOOT	270.000 X	=	=	=	=
78005180	EPOXY PVT MK LINE 24	FOOT	130.000 X	=	=	=	=
78200410	GUARDRAIL MKR TYPE A	EACH	28.000 X	=	=	=	=
78201000	TERMINAL MARKER - DA	EACH	2.000 X	=	=	=	=
80400100	ELECT SERV INSTALL	EACH	1.000 X	=	=	=	=
80400200	ELECT UTIL SERV CONN	L SUM	1.000 X	3,000	00	3,000	00
81028190	UNDRGRD C GALVS 1 1/2	FOOT	450.000 X	=	=	=	=
81028240	UNDRGRD C GALVS 4	FOOT	404.000 X	=	=	=	=
81028340	UNDRGRD C PVC 1 1/2	FOOT	1,122.000 X	=	=	=	=
81101000	CON AT ST 4 GALVS	FOOT	4,530.000 X	=	=	=	=

ITEM NUMBER	PAY ITEM DESCRIPTION	UNIT OF MEASURE	QUANTITY	UNIT PRICE		TOTAL PRICE	
				DOLLARS	CENTS	DOLLARS	CTS
81200220	CON EMB STR 1.5 PVC	FOOT	1,781.000 X	=	=	=	=
81400100	HANDHOLE	EACH	17.000 X	=	=	=	=
81400200	HD HANDHOLE	EACH	1.000 X	=	=	=	=
81702140	EC C XLP USE 1C 4	FOOT	13,412.000 X	=	=	=	=
82500335	LT CONT PEDM 240V100	EACH	1.000 X	=	=	=	=
83600200	LIGHT POLE FDN 24D	FOOT	162.000 X	=	=	=	=
84200500	REM LT UNIT SALV	EACH	6.000 X	=	=	=	=
84200804	REM POLE FDN	EACH	6.000 X	=	=	=	=
85000200	MAIN EX TR SIG INSTAL	EACH	2.000 X	=	=	=	=
88600600	DET LOOP REPL	FOOT	275.000 X	=	=	=	=
89502380	REMOV EX HANDHOLE	EACH	9.000 X	=	=	=	=

TOTAL \$

NOTE:
 *** PLEASE TURN PAGE FOR IMPORTANT NOTES ***

FAU 1503
09-00286-00-BR
KANE

(AURORA)

ILLINOIS DEPARTMENT OF TRANSPORTATION
SCHEDULE OF PRICES
CONTRACT NUMBER - 63863

ECMS002 DTGECM03 ECMR003 PAGE 13
RUN DATE - 10/02/13
RUN TIME - 183103

NOTE:

1. EACH PAY ITEM SHOULD HAVE A UNIT PRICE AND A TOTAL PRICE.
2. THE UNIT PRICE SHALL GOVERN IF NO TOTAL PRICE IS SHOWN OR IF THERE IS A DISCREPANCY BETWEEN THE PRODUCT OF THE UNIT PRICE MULTIPLIED BY THE QUANTITY.
3. IF A UNIT PRICE IS OMITTED, THE TOTAL PRICE WILL BE DIVIDED BY THE QUANTITY IN ORDER TO ESTABLISH A UNIT PRICE.
4. A BID MAY BE DECLARED UNACCEPTABLE IF NEITHER A UNIT PRICE NOR A TOTAL PRICE IS SHOWN.

RETURN WITH BID

STATE REQUIRED ETHICAL STANDARDS GOVERNING CONTRACT PROCUREMENT: ASSURANCES, CERTIFICATIONS AND DISCLOSURES

I. GENERAL

A. Article 50 of the Code establishes the duty of all State CPOs, SPOs, and their designees to maximize the value of the expenditure of public moneys in procuring goods, services, and contracts for the State of Illinois and to act in a manner that maintains the integrity and public trust of State government. In discharging this duty, they are charged by law to use all available information, reasonable efforts, and reasonable actions to protect, safeguard, and maintain the procurement process of the State of Illinois.

B. In order to comply with the provisions of Article 50 and to carry out the duty established therein, all bidders are to adhere to ethical standards established for the procurement process, and to make such assurances, disclosures and certifications required by law. Except as otherwise required in subsection III, paragraphs J-M, by execution of the Proposal Signature Sheet, the bidder indicates that each of the mandated assurances have been read and understood, that each certification is made and understood, and that each disclosure requirement has been understood and completed.

C. In addition to all other remedies provided by law, failure to comply with any assurance, failure to make any disclosure or the making of a false certification shall be grounds for the CPO to void the contract, and may result in the suspension or debarment of the bidder or subcontractor. If a false certification is made by a subcontractor the contractor's submitted bid and the executed contract may not be declared void unless the contractor refuses to terminate the subcontract upon the State's request after a finding that the subcontractor's certification was false.

I acknowledge, understand and accept these terms and conditions.

II. ASSURANCES

The assurances hereinafter made by the bidder are each a material representation of fact upon which reliance is placed should the Department enter into the contract with the bidder.

A. Conflicts of Interest

Section 50-13. Conflicts of Interest.

(a) Prohibition. It is unlawful for any person holding an elective office in this State, holding a seat in the General Assembly, or appointed to or employed in any of the offices or agencies of state government and who receives compensation for such employment in excess of 60% of the salary of the Governor of the State of Illinois, or who is an officer or employee of the Capital Development Board or the Illinois State Toll Highway Authority, or who is the spouse or minor child of any such person to have or acquire any contract, or any direct pecuniary interest in any contract therein, whether for stationery, printing, paper, or any services, materials, or supplies, that will be wholly or partially satisfied by the payment of funds appropriated by the General Assembly of the State of Illinois or in any contract of the Capital Development Board or the Illinois State Toll Highway Authority.

(b) Interests. It is unlawful for any firm, partnership, association or corporation, in which any person listed in subsection (a) is entitled to receive (i) more than 7 1/2% of the total distributable income or (ii) an amount in excess of the salary of the Governor, to have or acquire any such contract or direct pecuniary interest therein.

(c) Combined interests. It is unlawful for any firm, partnership, association, or corporation, in which any person listed in subsection (a) together with his or her spouse or minor children is entitled to receive (i) more than 15%, in the aggregate, of the total distributable income or (ii) an amount in excess of 2 times the salary of the Governor, to have or acquire any such contract or direct pecuniary interest therein.

(d) Securities. Nothing in this Section invalidates the provisions of any bond or other security previously offered or to be offered for sale or sold by or for the State of Illinois.

(e) Prior interests. This Section does not affect the validity of any contract made between the State and an officer or employee of the State or member of the General Assembly, his or her spouse, minor child or any combination of those persons if that contract was in existence before his or her election or employment as an officer, member, or employee. The contract is voidable, however, if it cannot be completed within 365 days after the officer, member, or employee takes office or is employed.

The current salary of the Governor is \$177,412.00. Sixty percent of the salary is \$106,447.20.

RETURN WITH BID

The bidder assures the Department that the award and execution of the contract would not cause a violation of Section 50-13, or that an effective exemption has been issued by the Board of Ethics to any individual subject to the Section 50-13 prohibitions pursuant to the provisions of Section 50-20 of the Code. Information concerning the exemption process is available from the Department upon request.

B. Negotiations

Section 50-15. Negotiations.

It is unlawful for any person employed in or on a continual contractual relationship with any of the offices or agencies of State government to participate in contract negotiations on behalf of that office or agency with any firm, partnership, association, or corporation with whom that person has a contract for future employment or is negotiating concerning possible future employment.

The bidder assures the Department that the award and execution of the contract would not cause a violation of Section 50-15, and that the bidder has no knowledge of any facts relevant to the kinds of acts prohibited therein.

C. Inducements

Section 50-25. Inducement.

Any person who offers or pays any money or other valuable thing to any person to induce him or her not to bid for a State contract or as recompense for not having bid on a State contract is guilty of a Class 4 felony. Any person who accepts any money or other valuable thing for not bidding for a State contract or who withholds a bid in consideration of the promise for the payment of money or other valuable thing is guilty of a Class 4 felony.

The bidder assures the Department that the award and execution of the contract would not cause a violation of Section 50-25, and that the bidder has no knowledge of any facts relevant to the kinds of acts prohibited therein.

D. Revolving Door Prohibition

Section 50-30. Revolving door prohibition.

CPOs, SPOs, procurement compliance monitors, their designees whose principal duties are directly related to State procurement, and executive officers confirmed by the Senate are expressly prohibited for a period of 2 years after terminating an affected position from engaging in any procurement activity relating to the State agency most recently employing them in an affected position for a period of at least 6 months. The prohibition includes, but is not limited to: lobbying the procurement process; specifying; bidding; proposing bid, proposal, or contract documents; on their own behalf or on behalf of any firm, partnership, association, or corporation. This Section applies only to persons who terminate an affected position on or after January 15, 1999.

The bidder assures the Department that the award and execution of the contract would not cause a violation of Section 50-30, and that the bidder has no knowledge of any facts relevant to the kinds of acts prohibited therein.

E. Reporting Anticompetitive Practices

Section 50-40. Reporting anticompetitive practices.

When, for any reason, any vendor, bidder, contractor, CPO, SPO, designee, elected official, or State employee suspects collusion or other anticompetitive practice among any bidders, offerors, contractors, proposers, or employees of the State, a notice of the relevant facts shall be transmitted to the Attorney General and the CPO.

The bidder assures the Department that it has not failed to report any relevant facts concerning the practices addressed in Section 50-40 which may involve the contract for which the bid is submitted.

F. Confidentiality

Section 50-45. Confidentiality.

Any CPO, SPO, designee, or executive officer who willfully uses or allows the use of specifications, competitive bid documents, proprietary competitive information, proposals, contracts, or selection information to compromise the fairness or integrity of the procurement, bidding, or contract process shall be subject to immediate dismissal, regardless of the Personnel code, any contract, or any collective bargaining agreement, and may in addition be subject to criminal prosecution.

The bidder assures the Department that it has no knowledge of any fact relevant to the practices addressed in Section 50-45 which may involve the contract for which the bid is submitted.

RETURN WITH BID

G. Insider Information

Section 50-50. Insider information.

It is unlawful for any current or former elected or appointed State official or State employee to knowingly use confidential information available only by virtue of that office or employment for actual or anticipated gain for themselves or another person.

The bidder assures the Department that it has no knowledge of any facts relevant to the practices addressed in Section 50-50 which may involve the contract for which the bid is submitted.

I acknowledge, understand and accept these terms and conditions for the above assurances.

III. CERTIFICATIONS

The certifications hereinafter made by the bidder are each a material representation of fact upon which reliance is placed should the Department enter into the contract with the bidder. Section 50-2 of the Code provides that every person that has entered into a multi-year contract and every subcontractor with a multi-year subcontract shall certify, by July 1 of each fiscal year covered by the contract after the initial fiscal year, to the responsible CPO whether it continues to satisfy the requirements of Article 50 pertaining to the eligibility for a contract award. If a contractor or subcontractor is not able to truthfully certify that it continues to meet all requirements, it shall provide with its certification a detailed explanation of the circumstances leading to the change in certification status. A contractor or subcontractor that makes a false statement material to any given certification required under Article 50 is, in addition to any other penalties or consequences prescribed by law, subject to liability under the Whistleblower Reward and Protection Act for submission of a false claim.

A. Bribery

Section 50-5. Bribery.

(a) Prohibition. No person or business shall be awarded a contract or subcontract under this Code who:

(1) has been convicted under the laws of Illinois or any other state of bribery or attempting to bribe an officer or employee of the State of Illinois or any other state in that officer's or employee's official capacity; or

(2) has made an admission of guilt of that conduct that is a matter of record but has not been prosecuted for that conduct.

(b) Businesses. No business shall be barred from contracting with any unit of State or local government, or subcontracting under such a contract, as a result of a conviction under this Section of any employee or agent of the business if the employee or agent is no longer employed by the business and:

(1) the business has been finally adjudicated not guilty; or

(2) the business demonstrates to the governmental entity with which it seeks to contract, or which is signatory to the contract which the subcontract relates, and that entity finds that the commission of the offense was not authorized, requested, commanded, or performed by a director, officer, or high managerial agent on behalf of the business as provided in paragraph (2) of subsection (a) of Section 5-4 of the Criminal Code of 2012.

(c) Conduct on behalf of business. For purposes of this Section, when an official, agent, or employee of a business committed the bribery or attempted bribery on behalf of the business and in accordance with the direction or authorization of a responsible official of the business, the business shall be chargeable with the conduct.

(d) Certification. Every bid submitted to and contract executed by the State, and every subcontract subject to Section 20-120 of the Code shall contain a certification by the contractor or the subcontractor, respectively, that the contractor or subcontractor is not barred from being awarded a contract or subcontract under this Section and acknowledges that the CPO may declare the related contract void if any certifications required by this Section are false. A contractor who makes a false statement, material to the certification, commits a Class 3 felony.

The contractor or subcontractor certifies that it is not barred from being awarded a contract under Section 50.5.

B. Felons

Section 50-10. Felons.

(a) Unless otherwise provided, no person or business convicted of a felony shall do business with the State of Illinois or any State agency, or enter into a subcontract, from the date of conviction until 5 years after the date of completion of the sentence for that felony, unless no person held responsible by a prosecutorial office for the facts upon which the conviction was based continues to have any involvement with the business.

(b) Certification. Every bid submitted to and contract executed by the State and every subcontract subject to Section 20-120 of the Code shall contain a certification by the bidder or contractor or subcontractor, respectively, that the bidder, contractor, or subcontractor is not barred from being awarded a contract or subcontract under this Section and acknowledges that the CPO may declare the related contract void if any of the certifications required by this Section are false.

RETURN WITH BID

C. Debt Delinquency

Section 50-11 and 50-12. Debt Delinquency.

The contractor or bidder or subcontractor, respectively, certifies that it, or any affiliate, is not barred from being awarded a contract or subcontract under the Code. Section 50-11 prohibits a person from entering into a contract with a State agency, or entering into a subcontract, if it knows or should know that it, or any affiliate, is delinquent in the payment of any debt to the State as defined by the Debt Collection Board. Section 50-12 prohibits a person from entering into a contract with a State agency, or entering into a subcontract, if it, or any affiliate, has failed to collect and remit Illinois Use Tax on all sales of tangible personal property into the State of Illinois in accordance with the provisions of the Illinois Use Tax Act. The bidder or contractor or subcontractor, respectively, further acknowledges that the CPO may declare the related contract void if this certification is false or if the bidder, contractor, or subcontractor, or any affiliate, is determined to be delinquent in the payment of any debt to the State during the term of the contract.

D. Prohibited Bidders, Contractors and Subcontractors

Section 50-10.5 and 50-60(c). Prohibited bidders, contractors and subcontractors.

The bidder or contractor or subcontractor, respectively, certifies in accordance with 30 ILCS 500/50-10.5 that no officer, director, partner or other managerial agent of the contracting business has been convicted of a felony under the Sarbanes-Oxley Act of 2002 or a Class 3 or Class 2 felony under the Illinois Securities Law of 1953 or if in violation of Subsection (c) for a period of five years from the date of conviction. Every bid submitted to and contract executed by the State and every subcontract subject to Section 20-120 of the Code shall contain a certification by the bidder, contractor, or subcontractor, respectively, that the bidder, contractor, or subcontractor is not barred from being awarded a contract or subcontract under this Section and acknowledges that the CPO shall declare the related contract void if any of the certifications completed pursuant to this Section are false.

E. Section 42 of the Environmental Protection Act

The bidder or contractor or subcontractor, respectively, certifies in accordance with 30 ILCS 500/50-14 that the bidder, contractor, or subcontractor, is not barred from being awarded a contract or entering into a subcontract under this Section which prohibits the bidding on or entering into contracts with the State of Illinois or a State agency, or entering into any subcontract, that is subject to the Code by a person or business found by a court or the Pollution Control Board to have committed a willful or knowing violation of Section 42 of the Environmental Protection Act for a period of five years from the date of the order. The bidder or contractor or subcontractor, respectively, acknowledges that the CPO may declare the contract void if this certification is false.

F. Educational Loan

Section 3 of the Educational Loan Default Act provides no State agency shall contract with an individual for goods or services if that individual is in default, as defined in Section 2 of this Act, on an educational loan. Any contract used by any State agency shall include a statement certifying that the individual is not in default on an educational loan as provided in this Section.

The bidder, if an individual as opposed to a corporation, partnership or other form of business organization, certifies that the bidder is not in default on an educational loan as provided in Section 3 of the Act.

G. Bid-Rigging/Bid Rotating

Section 33E-11 of the Criminal Code of 2012 provides:

(a) Every bid submitted to and public contract executed pursuant to such bid by the State or a unit of local government shall contain a certification by the prime contractor that the prime contractor is not barred from contracting with any unit of State or local government as a result of a violation of either Section 33E-3 or 33E-4 of this Article.

(b) A contractor who makes a false statement, material to the certification, commits a Class 3 felony.

A violation of Section 33E-3 would be represented by a conviction of the crime of bid-rigging which, in addition to Class 3 felony sentencing, provides that any person convicted of this offense or any similar offense of any state or the United States which contains the same elements as this offense shall be barred for 5 years from the date of conviction from contracting with any unit of State or local government. No corporation shall be barred from contracting with any unit of State or local government as a result of a conviction under this Section of any employee or agent of such corporation if the employee so convicted is no longer employed by the corporation and: (1) it has been finally adjudicated not guilty or (2) if it demonstrates to the governmental entity with which it seeks to contract and that entity finds that the commission of the offense was neither authorized, requested, commanded, nor performed by a director, officer or a high managerial agent in behalf of the corporation.

RETURN WITH BID

A violation of Section 33E-4 would be represented by a conviction of the crime of bid-rotating which, in addition to Class 2 felony sentencing, provides that any person convicted of this offense or any similar offense of any state or the United States which contains the same elements as this offense shall be permanently barred from contracting with any unit of State or local government. No corporation shall be barred from contracting with any unit of State or local government as a result of a conviction under this Section of any employee or agent of such corporation if the employee so convicted is no longer employed by the corporation and: (1) it has been finally adjudicated not guilty or (2) if it demonstrates to the governmental entity with which it seeks to contract and that entity finds that the commission of the offense was neither authorized, requested, commanded, nor performed by a director, officer or a high managerial agent in behalf of the corporation.

The bidder certifies that it is not barred from contracting with the Department by reason of a violation of either Section 33E-3 or Section 33E-4.

H. International Anti-Boycott

Section 5 of the International Anti-Boycott Certification Act provides every contract entered into by the State of Illinois for the manufacture, furnishing, or purchasing of supplies, material, or equipment or for the furnishing of work, labor, or services, in an amount exceeding the threshold for small purchases according to the purchasing laws of this State or \$10,000.00, whichever is less, shall contain certification, as a material condition of the contract, by which the contractor agrees that neither the contractor nor any substantially-owned affiliated company is participating or shall participate in an international boycott in violation of the provisions of the U.S. Export Administration Act of 1979 or the regulations of the U.S. Department of Commerce promulgated under that Act.

The bidder makes the certification set forth in Section 5 of the Act.

I. Drug Free Workplace

The Illinois "Drug Free Workplace Act" applies to this contract and it is necessary to comply with the provisions of the "Act" if the contractor is a corporation, partnership, or other entity (including a sole proprietorship) which has 25 or more employees.

The bidder certifies that if awarded a contract in excess of \$5,000 it will provide a drug free workplace in compliance with the provisions of the Act.

J. Disclosure of Business Operations in Iran

Section 50-36 of the Code, 30ILCS 500/50-36 provides that each bid, offer, or proposal submitted for a State contract shall include a disclosure of whether or not the Company acting as the bidder, offeror, or proposing entity, or any of its corporate parents or subsidiaries, within the 24 months before submission of the bid, offer, or proposal had business operations that involved contracts with or provision of supplies or services to the Government of Iran, companies in which the Government of Iran has any direct or indirect equity share, consortiums or projects commissioned by the Government of Iran, or companies involved in consortiums or projects commissioned by the Government of Iran and either of the following conditions apply:

- (1) More than 10% of the Company's revenues produced in or assets located in Iran involve oil-related activities or mineral-extraction activities; less than 75% of the Company's revenues produced in or assets located in Iran involve contracts with or provision of oil-related or mineral-extraction products or services to the Government of Iran or a project or consortium created exclusively by that government; and the Company has failed to take substantial action.
- (2) The Company has, on or after August 5, 1996, made an investment of \$20 million or more, or any combination of investments of at least \$10 million each that in the aggregate equals or exceeds \$20 million in any 12-month period, which directly or significantly contributes to the enhancement of Iran's ability to develop petroleum resources of Iran.

The terms "Business operations", "Company", "Mineral-extraction activities", "Oil-related activities", "Petroleum resources", and "Substantial action" are all defined in the Code.

Failure to make the disclosure required by the Code shall cause the bid, offer or proposal to be considered not responsive. The disclosure will be considered when evaluating the bid or awarding the contract. The name of each Company disclosed as doing business or having done business in Iran will be provided to the State Comptroller.

Check the appropriate statement:

/ ___ / Company has no business operations in Iran to disclose.

/ ___ / Company has business operations in Iran as disclosed the attached document.

RETURN WITH BID

K. Apprenticeship and Training Certification (Does not apply to federal aid projects)

In accordance with the provisions of Section 30-22 (6) of the Code, the bidder certifies that it is a participant, either as an individual or as part of a group program, in the approved apprenticeship and training programs applicable to each type of work or craft that the bidder will perform with its own forces. The bidder further certifies for work that will be performed by subcontract that each of its subcontractors submitted for approval either (a) is, at the time of such bid, participating in an approved, applicable apprenticeship and training program; or (b) will, prior to commencement of performance of work pursuant to this contract, begin participation in an approved apprenticeship and training program applicable to the work of the subcontract. The Department, at any time before or after award, may require the production of a copy of each applicable Certificate of Registration issued by the United States Department of Labor evidencing such participation by the contractor and any or all of its subcontractors. Applicable apprenticeship and training programs are those that have been approved and registered with the United States Department of Labor. The bidder shall list in the space below, the official name of the program sponsor holding the Certificate of Registration for all of the types of work or crafts in which the bidder is a participant and that will be performed with the bidder's forces. Types of work or craft work that will be subcontracted shall be included and listed as subcontract work. The list shall also indicate any type of work or craft job category that does not have an applicable apprenticeship or training program. **The bidder is responsible for making a complete report and shall make certain that each type of work or craft job category that will be utilized on the project as reported on the Construction Employee Workforce Projection (Form BC-1256) and returned with the bid is accounted for and listed.**

NA-FEDERAL

The requirements of this certification and disclosure are a material part of the contract, and the contractor shall require this certification provision to be included in all approved subcontracts. In order to fulfill this requirement, it shall not be necessary that an applicable program sponsor be currently taking or that it will take applications for apprenticeship, training or employment during the performance of the work of this contract.

RETURN WITH BID

L. Political Contributions and Registration with the State Board of Elections

Sections 20-160 and 50-37 of the Code regulate political contributions from business entities and any affiliated entities or affiliated persons bidding on or contracting with the state. Generally under Section 50-37, any business entity, and any affiliated entity or affiliated person of the business entity, whose current year contracts with all state agencies exceed an awarded value of \$50,000, are prohibited from making any contributions to any political committees established to promote the candidacy of the officeholder responsible for the awarding of the contracts or any other declared candidate for that office for the duration of the term of office of the incumbent officeholder or a period 2 years after the termination of the contract, whichever is longer. Any business entity and affiliated entities or affiliated persons whose state contracts in the current year do not exceed an awarded value of \$50,000, but whose aggregate pending bids and proposals on state contracts exceed \$50,000, either alone or in combination with contracts not exceeding \$50,000, are prohibited from making any political contributions to any political committee established to promote the candidacy of the officeholder responsible for awarding the pending contract during the period beginning on the date the invitation for bids or request for proposals is issued and ending on the day after the date of award or selection if the entity was not awarded or selected. Section 20-160 requires certification of registration of affected business entities in accordance with procedures found in Section 9-35 of The Election Code.

By submission of a bid, the contractor business entity acknowledges and agrees that it has read and understands Sections 20-160 and 50-37 of the Code, and that it makes the following certification:

The undersigned bidder certifies that it has registered as a business with the State Board of Elections and acknowledges a continuing duty to update the registration in accordance with the above referenced statutes. If the business entity is required to register, the CPO shall verify that it is in compliance on the date the bid or proposal is due. The CPO shall not accept a bid or proposal if the business entity is not in compliance with the registration requirements.

These requirements and compliance with the above referenced statutory sections are a material part of the contract, and any breach thereof shall be cause to void the contract under Section 50-60 of the Code. This provision does not apply to Federal-aid contracts.

M. Lobbyist Disclosure

Section 50-38 of the Code requires that any bidder or offeror on a State contract that hires a person required to register under the Lobbyist Registration Act to assist in obtaining a contract shall:

- (i) Disclose all costs, fees, compensation, reimbursements, and other remunerations paid or to be paid to the lobbyist related to the contract,
- (ii) Not bill or otherwise cause the State of Illinois to pay for any of the lobbyist's costs, fees, compensation, reimbursements, or other remuneration, and
- (iii) Sign a verification certifying that none of the lobbyist's costs, fees, compensation, reimbursements, or other remuneration were billed to the State.

This information, along with all supporting documents, shall be filed with the agency awarding the contract and with the Secretary of State. The CPO shall post this information, together with the contract award notice, in the online Procurement Bulletin.

Pursuant to Subsection (c) of this Section, no person or entity shall retain a person or entity to attempt to influence the outcome of a procurement decision made under the Code for compensation contingent in whole or in part upon the decision or procurement. Any person who violates this subsection is guilty of a business offense and shall be fined not more than \$10,000.

Bidder acknowledges that it is required to disclose the hiring of any person required to register pursuant to the Illinois Lobbyist Registration Act (25 ILCS 170) in connection with this contract.

Bidder has not hired any person required to register pursuant to the Illinois Lobbyist Registration Act in connection with this contract.

Or

Bidder has hired the following persons required to register pursuant to the Illinois Lobbyist Registration Act in connection with the contract:

Name and address of person: _____
All costs, fees, compensation, reimbursements and other remuneration paid to said person: _____

I acknowledge, understand and accept these terms and conditions for the above certifications.

RETURN WITH BID

IV. DISCLOSURES

- A. The disclosures hereinafter made by the bidder are each a material representation of fact upon which reliance is placed should the Department enter into the contract with the bidder. The bidder further certifies that the Department has received the disclosure forms for each bid.

The CPO may void the bid, or contract, respectively, if it is later determined that the bidder or subcontractor rendered a false or erroneous disclosure. A contractor or subcontractor may be suspended or debarred for violations of the Code. Furthermore, the CPO may void the contract and the surety providing the performance bond shall be responsible for completion of the contract.

B. Financial Interests and Conflicts of Interest

1. Section 50-35 of the Code provides that all bids of more than \$25,000 shall be accompanied by disclosure of the financial interests of the bidder. This disclosed information for the successful bidder, will be maintained as public information subject to release by request pursuant to the Freedom of Information Act, filed with the Procurement Policy Board, and shall be incorporated as a material term of the contract. Furthermore, pursuant to Section 5-5, the Procurement Policy Board may review a proposal, bid, or contract and issue a recommendation to void a contract or reject a proposal or bid based on any violation of the Code or the existence of a conflict of interest as provided in subsections (b) and (d) of Section 50-35.

The financial interests to be disclosed shall include ownership or distributive income share that is in excess of 5%, or an amount greater than 60% of the annual salary of the Governor, of the bidding entity or its parent entity, whichever is less, unless the contractor or bidder is a publicly traded entity subject to Federal 10K reporting, in which case it may submit its 10K disclosure in place of the prescribed disclosure. If a bidder is a privately held entity that is exempt from Federal 10K reporting, but has more than 200 shareholders, it may submit the information that Federal 10K companies are required to report, and list the names of any person or entity holding any ownership share that is in excess of 5%. The disclosure shall include the names, addresses, and dollar or proportionate share of ownership of each person making the disclosure, their instrument of ownership or beneficial relationship, and notice of any potential conflict of interest resulting from the current ownership or beneficial interest of each person making the disclosure having any of the relationships identified in Section 50-35 and on the disclosure form.
The current annual salary of the Governor is \$177,412.00.

In addition, all disclosures shall indicate any other current or pending contracts, proposals, leases, or other ongoing procurement relationships the bidding entity has with any other unit of state government and shall clearly identify the unit and the contract, proposal, lease, or other relationship.

2. Disclosure Forms. Disclosure Form A is attached for use concerning the individuals meeting the above ownership or distributive share requirements. A separate Disclosure Form A must be submitted with the bid for each individual meeting the above requirements. In addition, a second form (Disclosure Form B) provides for the disclosure of current or pending procurement relationships with other (non-IDOT) state agencies and a total ownership certification. **The forms must be included with each bid.**

C. Disclosure Form Instructions

Form A Instructions for Financial Information & Potential Conflicts of Interest

If the bidder is a publicly traded entity subject to Federal 10K reporting, the 10K Report may be submitted to meet the requirements of Form A. If a bidder is a privately held entity that is exempt from Federal 10K reporting, but has more than 200 shareholders, it may submit the information that Federal 10K companies are required to report, and list the names of any person or entity holding any ownership share that is in excess of 5%. If a bidder is not subject to Federal 10K reporting, the bidder must determine if any individuals are required by law to complete a financial disclosure form. To do this, the bidder should answer each of the following questions. A "YES" answer indicates Form A must be completed. If the answer to each of the following questions is "NO", then the NOT APPLICABLE STATEMENT on Form A must be signed and dated by a person that is authorized to execute contracts for the bidding company. Note: These questions are for assistance only and are not required to be completed.

1. Does anyone in your organization have a direct or beneficial ownership share of greater than 5% of the bidding entity or parent entity? YES ___ NO ___
2. Does anyone in your organization have a direct or beneficial ownership share of less than 5%, but which has a value greater than 60% of the annual salary of the Governor? YES ___ NO ___
3. Does anyone in your organization receive more than 60% of the annual salary of the Governor of the bidding entity's or parent entity's distributive income? YES ___ NO ___
4. Does anyone in your organization receive greater than 5% of the bidding entity's or parent entity's total distributive income, but which is less than 60% of the annual salary of the Governor? YES ___ NO ___

(Note: Only one set of forms needs to be completed per person per bid even if a specific individual would require a yes answer to more than one question.)

A "YES" answer to any of these questions requires the completion of Form A. The bidder must determine each individual in the bidding entity or the bidding entity's parent company that would cause the questions to be answered "Yes". Each form must be signed and dated by a person that is authorized to execute contracts for your organization. **Photocopied or stamped signatures are not acceptable.** The person signing can be, but does not have to be, the person for which the form is being completed. The bidder is responsible for the accuracy of any information provided.

If the answer to each of the above questions is "NO", then the NOT APPLICABLE STATEMENT of Form A must be signed and dated by a person that is authorized to execute contracts for your company.

RETURN WITH BID

Form B: Instructions for Identifying Other Contracts & Procurement Related Information

Disclosure Form B must be completed for each bid submitted by the bidding entity. *Note: Checking the NOT APPLICABLE STATEMENT on Form A does not allow the bidder to ignore Form B. Form B must be completed, checked, and dated or the bidder may be considered nonresponsive and the bid will not be accepted.*

The Bidder shall identify, by checking Yes or No on Form B, whether it has any pending contracts (including leases), bids, proposals, or other ongoing procurement relationship with any other (non-IDOT) State of Illinois agency. If "No" is checked, the bidder only needs to complete the check box on the bottom of Form B. If "Yes" is checked, the bidder must do one of the following:

Option I: If the bidder did not submit an Affidavit of Availability to obtain authorization to bid, the bidder must list all non-IDOT State of Illinois agency pending contracts, leases, bids, proposals, and other ongoing procurement relationships. These items may be listed on Form B or on an attached sheet(s). Do not include IDOT contracts. Contracts with cities, counties, villages, etc. are not considered State of Illinois agency contracts and are not to be included. Contracts with other State of Illinois agencies such as the Department of Natural Resources or the Capital Development Board must be included. Bidders who submit Affidavits of Availability are suggested to use Option II.

Option II: If the bidder is required and has submitted an Affidavit of Availability in order to obtain authorization to bid, the bidder may write or type "See Affidavit of Availability" which indicates that the Affidavit of Availability is incorporated by reference and includes all non-IDOT State of Illinois agency pending contracts, leases, bids, proposals, and other ongoing procurement relationships. For any contracts that are not covered by the Affidavit of Availability, the bidder must identify them on Form B or on an attached sheet(s). These might be such things as leases.

RETURN WITH BID

ILLINOIS DEPARTMENT OF TRANSPORTATION

Form A Financial Information & Potential Conflicts of Interest Disclosure

Contractor Name
Legal Address
City, State, Zip
Telephone Number Email Address Fax Number (if available)

Disclosure of the information contained in this Form is required by the Section 50-35 of the Code (30 ILCS 500). Vendors desiring to enter into a contract with the State of Illinois must disclose the financial information and potential conflict of interest information as specified in this Disclosure Form. This information shall become part of the publicly available contract file. This Form A must be completed for bids in excess of \$25,000, and for all open-ended contracts. A publicly traded company may submit a 10K disclosure (or equivalent if applicable) in satisfaction of the requirements set forth in Form A. See Disclosure Form Instructions.

The current annual salary of the Governor is \$177,412.00.

DISCLOSURE OF FINANCIAL INFORMATION

- 1. Disclosure of Financial Information. The individual named below has an interest in the BIDDER (or its parent) in terms of ownership or distributive income share in excess of 5%, or an interest which has a value of more than 60% of the annual salary of the Governor. (Make copies of this form as necessary and attach a separate Disclosure Form A for each individual meeting these requirements)

FOR INDIVIDUAL (type or print information)
NAME:
ADDRESS
Type of ownership/distributable income share:
stock sole proprietorship Partnership other: (explain on separate sheet):
% or \$ value of ownership/distributable income share:

- 2. Disclosure of Potential Conflicts of Interest. Check "Yes" or "No" to indicate which, if any, of the following potential conflict of interest relationships apply. If the answer to any question is "Yes", please attach additional pages and describe.

(a) State employment, currently or in the previous 3 years, including contractual employment of services. Yes ___ No ___

If your answer is yes, please answer each of the following questions.

- 1. Are you currently an officer or employee of either the Capitol Development Board or the Illinois State Toll Highway Authority? Yes ___ No ___
2. Are you currently appointed to or employed by any agency of the State of Illinois? If you are currently appointed to or employed by any agency of the State of Illinois, and your annual salary exceeds 60% of the annual salary of the Governor provide the name the State agency for which you are employed and your annual salary.

RETURN WITH BID

3. If you are currently appointed to or employed by any agency of the State of Illinois, and your annual salary exceeds 60% of the annual salary of the Governor, are you entitled to receive (i) more than 7 1/2% of the total distributable income of your firm, partnership, association or corporation, or (ii) an amount in excess of 100% of the annual salary of the Governor? Yes ___ No ___
4. If you are currently appointed to or employed by any agency of the State of Illinois, and your annual salary exceeds 60% of the annual salary of the Governor, are you and your spouse or minor children entitled to receive (i) more than 15% in aggregate of the total distributable income of your firm, partnership, association or corporation, or (ii) an amount in excess of two times the salary of the Governor? Yes ___ No ___

(b) State employment of spouse, father, mother, son, or daughter, including contractual employment for services in the previous 2 years.

Yes ___ No ___

If your answer is yes, please answer each of the following questions.

1. Is your spouse or any minor children currently an officer or employee of the Capitol Development Board or the Illinois State Toll Highway Authority? Yes ___ No ___
2. Is your spouse or any minor children currently appointed to or employed by any agency of the State of Illinois? If your spouse or minor children is/are currently appointed to or employed by any agency of the State of Illinois, and his/her annual salary exceeds 60% of the annual salary of the Governor, provide the name of the spouse and/or minor children, the name of the State agency for which he/she is employed and his/her annual salary. _____
-
3. If your spouse or any minor children is/are currently appointed to or employed by any agency of the State of Illinois, and his/her annual salary exceeds 60% of the annual salary of the Governor, are you entitled to receive (i) more than 7 1/2% of the total distributable income of your firm, partnership, association or corporation, or (ii) an amount in excess 100% of the annual salary of the Governor? Yes ___ No ___
4. If your spouse or any minor children are currently appointed to or employed by any agency of the State of Illinois, and his/her annual salary exceeds 60% of the annual salary of the Governor, are you and your spouse or any minor children entitled to receive (i) more than 15% in the aggregate of the total distributable income from your firm, partnership, association or corporation, or (ii) an amount in excess of two times the salary of the Governor? Yes ___ No ___

(c) Elective status; the holding of elective office of the State of Illinois, the government of the United States, any unit of local government authorized by the Constitution of the State of Illinois or the statutes of the State of Illinois currently or in the previous 3 years. Yes ___ No ___

(d) Relationship to anyone holding elective office currently or in the previous 2 years; spouse, father, mother, son, or daughter. Yes ___ No ___

(e) Appointive office; the holding of any appointive government office of the State of Illinois, the United State of America, or any unit of local government authorized by the Constitution of the State of Illinois or the statutes of the State of Illinois, which office entitles the holder to compensation in excess of the expenses incurred in the discharge of that office currently or in the previous 3 years. Yes ___ No ___

(f) Relationship to anyone holding appointive office currently or in the previous 2 years; spouse, father, mother, son, or daughter. Yes ___ No ___

(g) Employment, currently or in the previous 3 years, as or by any registered lobbyist of the State government. Yes ___ No ___

RETURN WITH BID

(h) Relationship to anyone who is or was a registered lobbyist in the previous 2 years; spouse, father, mother, son, or daughter. Yes ___ No ___

(i) Compensated employment, currently or in the previous 3 years, by any registered election or reelection committee registered with the Secretary of State or any county clerk of the State of Illinois, or any political action committee registered with either the Secretary of State or the Federal Board of Elections. Yes ___ No ___

(j) Relationship to anyone; spouse, father, mother, son, or daughter; who was a compensated employee in the last 2 years by any registered election or re-election committee registered with the Secretary of State or any county clerk of the State of Illinois, or any political action committee registered with either the Secretary of State or the Federal Board of Elections. Yes ___ No ___

3. Communication Disclosure.

Disclose the name and address of each lobbyist and other agent of the bidder or offeror who is not identified in Section 2 of this form, who is has communicated, is communicating, or may communicate with any State officer or employee concerning the bid or offer. This disclosure is a continuing obligation and must be promptly supplemented for accuracy throughout the process and throughout the term of the contract. If no person is identified, enter "None" on the line below:

Name and address of person(s): _____

RETURN WITH BID

4. Debarment Disclosure. For each of the persons identified under Sections 2 and 3 of this form, disclose whether any of the following has occurred within the previous 10 years: debarment from contracting with any governmental entity; professional licensure discipline; bankruptcies; adverse civil judgments and administrative findings; and criminal felony convictions. This disclosure is a continuing obligation and must be promptly supplemented for accuracy throughout the procurement process and term of the contract. If no person is identified, enter "None" on the line below:

Name of person(s): _____

Nature of disclosure: _____

APPLICABLE STATEMENT

This Disclosure Form A is submitted on behalf of the INDIVIDUAL named on previous page. Under penalty of perjury, I certify the contents of this disclosure to be true and accurate to the best of my knowledge.

Completed by: _____
Signature of Individual or Authorized Representative Date

NOT APPLICABLE STATEMENT

Under penalty of perjury, I have determined that no individuals associated with this organization meet the criteria that would require the completion of this Form A.

This Disclosure Form A is submitted on behalf of the CONTRACTOR listed on the previous page.

Signature of Authorized Representative Date

The bidder has a continuing obligation to supplement these disclosures under Sec. 50-35 of the Code.

RETURN WITH BID

ILLINOIS DEPARTMENT OF TRANSPORTATION

Form B Other Contracts & Financial Related Information Disclosure

Contractor Name, Legal Address, City, State, Zip, Telephone Number, Email Address, Fax Number (if available)

Disclosure of the information contained in this Form is required by the Section 50-35 of the Code (30 ILCS 500). This information shall become part of the publicly available contract file. This Form B must be completed for bids in excess of \$25,000, and for all open-ended contracts.

DISCLOSURE OF OTHER CONTRACTS AND PROCUREMENT RELATED INFORMATION

1. Identifying Other Contracts & Procurement Related Information. The BIDDER shall identify whether it has any pending contracts (including leases), bids, proposals, or other ongoing procurement relationship with any other State of Illinois agency: Yes ___ No ___

If "No" is checked, the bidder only needs to complete the signature box on the bottom of this page.

2. If "Yes" is checked. Identify each such relationship by showing State of Illinois agency name and other descriptive information such as bid or project number (attach additional pages as necessary). SEE DISCLOSURE FORM INSTRUCTIONS:

THE FOLLOWING STATEMENT MUST BE CHECKED

Signature of Authorized Representative, Date

OWNERSHIP CERTIFICATION

Please certify that the following statement is true if the individuals for all submitted Form A disclosures do not total 100% of ownership.

Any remaining ownership interest is held by individuals receiving less than \$106,447.20 of the bidding entity's or parent entity's distributive income or holding less than a 5% ownership interest.

Yes No N/A (Form A disclosure(s) established 100% ownership)

RETURN WITH BID

SPECIAL NOTICE TO CONTRACTORS

The following requirements of the Illinois Department of Human Rights' Rules and Regulations are applicable to bidders on all construction contracts advertised by the Illinois Department of Transportation:

CONSTRUCTION EMPLOYEE UTILIZATION PROJECTION

- (a) All bidders on construction contracts shall complete and submit, along with and as part of their bids, a Bidder's Employee Utilization Form (Form BC-1256) setting forth a projection and breakdown of the total workforce intended to be hired and/or allocated to such contract work by the bidder including a projection of minority and female employee utilization in all job classifications on the contract project.
- (b) The Department of Transportation shall review the Employee Utilization Form, and workforce projections contained therein, of the contract awardee to determine if such projections reflect an underutilization of minority persons and/or women in any job classification in accordance with the Equal Employment Opportunity Clause and Section 7.2 of the Illinois Department of Human Rights' Rules and Regulations for Public Contracts adopted as amended on September 17, 1980. If it is determined that the contract awardee's projections reflect an underutilization of minority persons and/or women in any job classification, it shall be advised in writing of the manner in which it is underutilizing and such awardee shall be considered to be in breach of the contract unless, prior to commencement of work on the contract project, it submits revised satisfactory projections or an acceptable written affirmative action plan to correct such underutilization including a specific timetable geared to the completion stages of the contract.
- (c) The Department of Transportation shall provide to the Department of Human Rights a copy of the contract awardee's Employee Utilization Form, a copy of any required written affirmative action plan, and any written correspondence related thereto. The Department of Human Rights may review and revise any action taken by the Department of Transportation with respect to these requirements.



RETURN WITH BID

Contract No. 63863
 KANE County
 Section 09-00286-00-BR (Aurora)
 Project BRM-9003(510)
 Route FAU 1503 (Indian Trail Road)
 District 1 Construction Funds

PART I. IDENTIFICATION

Dept. Human Rights # _____ Duration of Project: _____

Name of Bidder: _____

PART II. WORKFORCE PROJECTION

A. The undersigned bidder has analyzed minority group and female populations, unemployment rates and availability of workers for the location in which this contract work is to be performed, and for the locations from which the bidder recruits employees, and hereby submits the following workforce projection including a projection for minority and female employee utilization in all job categories in the workforce to be allocated to this contract:

TABLE A

TOTAL Workforce Projection for Contract												
JOB CATEGORIES	TOTAL EMPLOYEES		MINORITY EMPLOYEES						TRAINEES			
			BLACK		HISPANIC		*OTHER MINOR.		APPRENTICES		ON THE JOB TRAINEES	
	M	F	M	F	M	F	M	F	M	F	M	F
OFFICIALS (MANAGERS)												
SUPERVISORS												
FOREMEN												
CLERICAL												
EQUIPMENT OPERATORS												
MECHANICS												
TRUCK DRIVERS												
IRONWORKERS												
CARPENTERS												
CEMENT MASONS												
ELECTRICIANS												
PIPEFITTERS, PLUMBERS												
PAINTERS												
LABORERS, SEMI-SKILLED												
LABORERS, UNSKILLED												
TOTAL												

TABLE B

CURRENT EMPLOYEES TO BE ASSIGNED TO CONTRACT			
TOTAL EMPLOYEES		MINORITY EMPLOYEES	
M	F	M	F

TABLE C

TOTAL Training Projection for Contract								
EMPLOYEES IN TRAINING	TOTAL EMPLOYEES		BLACK		HISPANIC		*OTHER MINOR.	
	M	F	M	F	M	F	M	F
APPRENTICES								
ON THE JOB TRAINEES								

*Other minorities are defined as Asians (A) or Native Americans (N). Please specify race of each employee shown in Other Minorities column.

FOR DEPARTMENT USE ONLY

Note: See instructions on page 2

RETURN WITH BID

**Contract No. 63863
KANE County
Section 09-00286-00-BR (Aurora)
Project BRM-9003(510)
Route FAU 1503 (Indian Trail Road)
District 1 Construction Funds**

PART II. WORKFORCE PROJECTION - continued

- B. Included in "Total Employees" under Table A is the total number of **new hires** that would be employed in the event the undersigned bidder is awarded this contract.

The undersigned bidder projects that: (number) _____ new hires would be recruited from the area in which the contract project is located; and/or (number) _____ new hires would be recruited from the area in which the bidder's principal office or base of operation is located.

- C. Included in "Total Employees" under Table A is a projection of numbers of persons to be employed directly by the undersigned bidder as well as a projection of numbers of persons to be employed by subcontractors.

The undersigned bidder estimates that (number) _____ persons will be directly employed by the prime contractor and that (number) _____ persons will be employed by subcontractors.

PART III. AFFIRMATIVE ACTION PLAN

- A. The undersigned bidder understands and agrees that in the event the foregoing minority and female employee utilization projection included under **PART II** is determined to be an underutilization of minority persons or women in any job category, and in the event that the undersigned bidder is awarded this contract, he/she will, prior to commencement of work, develop and submit a written Affirmative Action Plan including a specific timetable (geared to the completion stages of the contract) whereby deficiencies in minority and/or female employee utilization are corrected. Such Affirmative Action Plan will be subject to approval by the contracting agency and the **Department of Human Rights**.
- B. The undersigned bidder understands and agrees that the minority and female employee utilization projection submitted herein, and the goals and timetable included under an Affirmative Action Plan if required, are deemed to be part of the contract specifications.

Company _____ Telephone Number _____

Address _____

NOTICE REGARDING SIGNATURE

The Bidder's signature on the Proposal Signature Sheet will constitute the signing of this form. The following signature block needs to be completed only if revisions are required.

Signature: _____ Title: _____ Date: _____

- Instructions: All tables must include subcontractor personnel in addition to prime contractor personnel.
- Table A - Include both the number of employees that would be hired to perform the contract work and the total number currently employed (Table B) that will be allocated to contract work, and include all apprentices and on-the-job trainees. The "Total Employees" column should include all employees including all minorities, apprentices and on-the-job trainees to be employed on the contract work.
- Table B - Include all employees currently employed that will be allocated to the contract work including any apprentices and on-the-job trainees currently employed.
- Table C - Indicate the racial breakdown of the total apprentices and on-the-job trainees shown in Table A.

RETURN WITH BID

ADDITIONAL FEDERAL REQUIREMENTS

In addition to the Required Contract Provisions for Federal-Aid Construction Contracts (FHWA 1273), all bidders make the following certifications.

- A. By the execution of this proposal, the signing bidder certifies that the bidding entity has not, either directly or indirectly, entered into any agreement, participated in any collusion, or otherwise taken any action, in restraint of free competitive bidding in connection with the submitted bid. This statement made by the undersigned bidder is true and correct under penalty of perjury under the laws of the United States.
- B. CERTIFICATION, EQUAL EMPLOYMENT OPPORTUNITY:
1. Have you participated in any previous contracts or subcontracts subject to the equal opportunity clause. YES _____ NO _____
 2. If answer to #1 is yes, have you filed with the Joint Reporting Committee, the Director of OFCC, any Federal agency, or the former President's Committee on Equal Employment Opportunity, all reports due under the applicable filing requirements of those organizations? YES _____ NO _____

RETURN WITH BID

**Contract No. 63863
KANE County
Section 09-00286-00-BR (Aurora)
Project BRM-9003(510)
Route FAU 1503 (Indian Trail Road)
District 1 Construction Funds**

PROPOSAL SIGNATURE SHEET

The undersigned bidder hereby makes and submits this bid on the subject Proposal, thereby assuring the Department that all requirements of the Invitation for Bids and rules of the Department have been met, that there is no misunderstanding of the requirements of paragraph 3 of this Proposal, and that the contract will be executed in accordance with the rules of the Department if an award is made on this bid.

(IF AN INDIVIDUAL)

Firm Name _____
Signature of Owner _____
Business Address _____

(IF A CO-PARTNERSHIP)

Firm Name _____
By _____
Business Address _____
Name and Address of All Members of the Firm: _____

(IF A CORPORATION)

Corporate Name _____
By _____
Signature of Authorized Representative _____
Typed or printed name and title of Authorized Representative _____
Attest _____
Signature _____
(IF A JOINT VENTURE, USE THIS SECTION FOR THE MANAGING PARTY AND THE SECOND PARTY SHOULD SIGN BELOW)
Business Address _____

(IF A JOINT VENTURE)

Corporate Name _____
By _____
Signature of Authorized Representative _____
Typed or printed name and title of Authorized Representative _____
Attest _____
Signature _____
Business Address _____

If more than two parties are in the joint venture, please attach an additional signature sheet.



Return with Bid

Division of Highways
Proposal Bid Bond
(Effective November 1, 1992)

Item No. _____

Letting Date _____

KNOW ALL MEN BY THESE PRESENTS, That We _____

as PRINCIPAL, and _____

_____ as SURETY, are held jointly, severally and firmly bound unto the STATE OF ILLINOIS in the penal sum of 5 percent of the total bid price, or for the amount specified in the bid proposal under "Proposal Guaranty" in effect on the date of the Invitation for Bids, whichever is the lesser sum, well and truly to be paid unto said STATE OF ILLINOIS, for the payment of which we bind ourselves, our heirs, executors, administrators, successors and assigns.

THE CONDITION OF THE FOREGOING OBLIGATION IS SUCH, that whereas, the PRINCIPAL has submitted a bid proposal to the STATE OF ILLINOIS, acting through the Department of Transportation, for the improvement designated by the Transportation Bulletin Item Number and Letting Date indicated above.

NOW, THEREFORE, if the Department shall accept the bid proposal of the PRINCIPAL; and if the PRINCIPAL shall, within the time and as specified in the bidding and contract documents, submit a DBE Utilization Plan that is accepted and approved by the Department; and if, after award by the Department, the PRINCIPAL shall enter into a contract in accordance with the terms of the bidding and contract documents including evidence of the required insurance coverages and providing such bond as specified with good and sufficient surety for the faithful performance of such contract and for the prompt payment of labor and material furnished in the prosecution thereof; or if, in the event of the failure of the PRINCIPAL to make the required DBE submission or to enter into such contract and to give the specified bond, the PRINCIPAL pays to the Department the difference not to exceed the penalty hereof between the amount specified in the bid proposal and such larger amount for which the Department may contract with another party to perform the work covered by said bid proposal, then this obligation shall be null and void, otherwise, it shall remain in full force and effect.

IN THE EVENT the Department determines the PRINCIPAL has failed to comply with any requirement as set forth in the preceding paragraph, then Surety shall pay the penal sum to the Department within fifteen (15) days of written demand therefor. If Surety does not make full payment within such period of time, the Department may bring an action to collect the amount owed. Surety is liable to the Department for all its expenses, including attorney's fees, incurred in any litigation in which it prevails either in whole or in part.

In TESTIMONY WHEREOF, the said PRINCIPAL and the said SURETY have caused this instrument to be signed by

their respective officers this _____ day of _____ A.D., _____ .

PRINCIPAL

SURETY

(Company Name)

(Company Name)

By _____ (Signature & Title)

By: _____ (Signature of Attorney-in-Fact)

Notary Certification for Principal and Surety

STATE OF ILLINOIS,
County of _____

I, _____, a Notary Public in and for said County, do hereby certify that

_____ and _____
(Insert names of individuals signing on behalf of PRINCIPAL & SURETY)

who are each personally known to me to be the same persons whose names are subscribed to the foregoing instrument on behalf of PRINCIPAL and SURETY, appeared before me this day in person and acknowledged respectively, that they signed and delivered said instrument as their free and voluntary act for the uses and purposes therein set forth.

Given under my hand and notarial seal this _____ day of _____ A.D. _____

My commission expires _____

Notary Public

In lieu of completing the above section of the Proposal Bid Form, the Principal may file an Electronic Bid Bond. By signing the proposal and marking the check box next to the Signature and Title line below, the Principal is ensuring the identified electronic bid bond has been executed and the Principal and Surety are firmly bound unto the State of Illinois under the conditions of the bid bond as shown above.

Electronic Bid Bond ID# _____

Company / Bidder Name _____

Signature and Title _____



(1) Policy

It is public policy that disadvantageded businesses as defined in 49 CFR Part 26 and the Special Provision shall have the maximum opportunity to participate in the performance of contracts financed in whole or in part with Federal or State funds. Consequently the requirements of 49 CFR Part 26 apply to this contract.

(2) Obligation

The contractor agrees to ensure that disadvantageded businesses as defined in 49 CFR Part 26 and the Special Provision have the maximum opportunity to participate in the performance of contracts or subcontracts financed in whole or in part with Federal or State funds. The contractor shall take all necessary and reasonable steps in accordance with 49 CFR Part 26 and the Special Provision to ensure that said businesses have the maximum opportunity to compete for and perform under this contract. The contractor shall not discriminate on the basis of race, color, national origin or sex in the award and performance of contracts.

(3) Project and Bid Identification

Complete the following information concerning the project and bid:

Route _____	Total Bid _____
Section _____	Contract DBE Goal _____ (Percent) _____ (Dollar Amount)
Project _____	
County _____	
Letting Date _____	
Contract No. _____	
Letting Item No. _____	

(4) Assurance

I, acting in my capacity as an officer of the undersigned bidder (or bidders if a joint venture), hereby assure the Department that on this project my company : (check one)

- Meets or exceeds contract award goals and has provided documented participation as follows:
Disadvantaged Business Participation _____ percent

Attached are the signed participation statements, forms SBE 2025, required by the Special Provision evidencing availability and use of each business participating in this plan and assuring that each business will perform a commercially useful function in the work of the contract.

- Failed to meet contract award goals and has included good faith effort documentation to meet the goals and that my company has provided participation as follows:

Disadvantaged Business Participation _____ percent

The contract goals should be accordingly modified or waived. Attached is all information required by the Special Provision in support of this request including good faith effort. Also attached are the signed participation statements, forms SBE 2025, required by the Special Provision evidencing availability and use of each business participating in this plan and assuring that each business will perform a commercially useful function in the work of the contract.

Company

By _____

Title _____

Date _____

The "as read" Low Bidder is required to comply with the Special Provision.

Submit only one utilization plan for each project. The utilization plan shall be submitted in accordance with the special provision.

Bureau of Small Business Enterprises
2300 South Dirksen Parkway
Springfield, Illinois 62764

Local Let Projects
Submit forms to the
Local Agency



Illinois Department of Transportation

DBE Participation Statement

Subcontractor Registration _____

Letting _____

Participation Statement

Item No. _____

(1) Instructions

Contract _____

This form must be completed for each disadvantaged business participating in the Utilization Plan. This form shall be submitted in accordance with the special provision and will be attached to the Utilization Plan form.. If additional space is needed complete an additional form for the firm.

(2) Work

Table with 5 columns: Pay Item No., Description, Quantity, Unit Price, Total. Includes a 'Total' row at the bottom right.

(3) Partial Payment Items

For any of the above items which are partial pay items, specifically describe the work and subcontract dollar amount:

(4) Commitment

The undersigned certify that the information included herein is true and correct, and that the DBE firm listed below has agreed to perform a commercially useful function in the work of the contract item(s) listed above and to execute a contract with the prime contractor. The undersigned further understand that no changes to this statement may be made without prior approval from the Department’s Bureau of Small Business Enterprises and that complete and accurate information regarding actual work performed on this project and the payment therefore must be provided to the Department.

Signature for Prime Contractor
Title
Date
Contact
Phone
Firm Name
Address
City/State/Zip

Signature for DBE Firm
Title
Date
Contact Person
Phone
Firm Name
Address
City/State/Zip

E
WC

The Department of Transportation is requesting disclosure of information that is necessary to accomplish the statutory purpose as outlined under the state and federal law. Disclosure of this information is REQUIRED. Failure to provide any information will result in the contract not being awarded. This form has been approved by the State Forms Management Center.

PROPOSAL ENVELOPE



PROPOSALS

for construction work advertised for bids by the
Illinois Department of Transportation

Item No.	Item No.	Item No.

Submitted By:

Name:
Address:
Phone No.

Bidders should use an IDOT proposal envelope or affix this form to the front of a 10" x 13" envelope for the submittal of bids. If proposals are mailed, they should be enclosed in a second or outer envelope addressed to:

Engineer of Design and Environment - Room 326
Illinois Department of Transportation
2300 South Dirksen Parkway
Springfield, Illinois 62764

NOTICE

Individual bids, including Bid Bond and/or supplemental information if required, should be securely stapled.

CONTRACTOR OFFICE COPY OF CONTRACT SPECIFICATIONS

NOTICE

None of the following material needs to be returned with the bid package unless the special provisions require documentation and/or other information to be submitted.

**Contract No. 63863
KANE County
Section 09-00286-00-BR (Aurora)
Project BRM-9003(510)
Route FAU 1503 (Indian Trail Road)
District 1 Construction Funds**



Illinois Department of Transportation

SUBCONTRACTOR DOCUMENTATION

Public Acts 96-0795, 96-0920, and 97-0895 enacted substantial changes to the provisions of the Code (30 ILCS 500). Among the changes are provisions affecting subcontractors. The Contractor awarded this contract will be required as a material condition of the contract to implement and enforce the contract requirements applicable to subcontractors that entered into a contractual agreement with a total value of \$50,000 or more with a person or entity who has a contract subject to the Code and approved in accordance with article 108.01 of the Standard Specifications for Road and Bridge Construction.

If the Contractor seeks approval of subcontractors to perform a portion of the work, and approval is granted by the Department, the Contractor shall provide a copy of the subcontract to the Illinois Department of Transportation's CPO upon request within 15 calendar days after execution of the subcontract.

Financial disclosures required pursuant to Sec. 50-35 of the Code must be submitted for all applicable subcontractors. The subcontract shall contain the certifications required to be made by subcontractors pursuant to Article 50 of the Code. This Notice to Bidders includes a document incorporating all required subcontractor certifications and disclosures for use by the Contractor in compliance with this mandate. The document is entitled State Required Ethical Standards Governing Subcontractors.

RETURN WITH SUBCONTRACT

STATE ETHICAL STANDARDS GOVERNING SUBCONTRACTORS

Article 50 of the Code establishes the duty of all State CPOs, SPOs, and their designees to maximize the value of the expenditure of public moneys in procuring goods, services, and contracts for the State of Illinois and to act in a manner that maintains the integrity and public trust of State government. In discharging this duty, they are charged by law to use all available information, reasonable efforts, and reasonable actions to protect, safeguard, and maintain the procurement process of the State of Illinois.

The certifications hereinafter made by the subcontractor are each a material representation of fact upon which reliance is placed should the Department approve the subcontractor. The CPO may terminate or void the contract approval if it is later determined that the bidder or subcontractor rendered a false or erroneous certification. If a false certification is made by a subcontractor the contractor's submitted bid and the executed contract may not be declared void unless the contractor refuses to terminate the subcontract upon the State's request after a finding that the subcontractor's certification was false.

Section 50-2 of the Code provides that every person that has entered into a multi-year contract and every subcontractor with a multi-year subcontract shall certify, by July 1 of each fiscal year covered by the contract after the initial fiscal year, to the responsible CPO whether it continues to satisfy the requirements of Article 50 pertaining to the eligibility for a contract award. If a contractor or subcontractor is not able to truthfully certify that it continues to meet all requirements, it shall provide with its certification a detailed explanation of the circumstances leading to the change in certification status. A contractor or subcontractor that makes a false statement material to any given certification required under Article 50 is, in addition to any other penalties or consequences prescribed by law, subject to liability under the Whistleblower Reward and Protection Act for submission of a false claim.

A. Bribery

Section 50-5. Bribery.

(a) Prohibition. No person or business shall be awarded a contract or subcontract under this Code who:

(1) has been convicted under the laws of Illinois or any other state of bribery or attempting to bribe an officer or employee of the State of Illinois or any other state in that officer's or employee's official capacity; or

(2) has made an admission of guilt of that conduct that is a matter of record but has not been prosecuted for that conduct.

(b) Businesses. No business shall be barred from contracting with any unit of State or local government, or subcontracting under such a contract, as a result of a conviction under this Section of any employee or agent of the business if the employee or agent is no longer employed by the business and:

(1) the business has been finally adjudicated not guilty; or

(2) the business demonstrates to the governmental entity with which it seeks to contract, or which is signatory to the contract to which the subcontract relates, and that entity finds that the commission of the offense was not authorized, requested, commanded, or performed by a director, officer, or high managerial agent on behalf of the business as provided in paragraph (2) of subsection (a) of Section 5-4 of the Criminal Code of 2012.

(c) Conduct on behalf of business. For purposes of this Section, when an official, agent, or employee of a business committed the bribery or attempted bribery on behalf of the business and in accordance with the direction or authorization of a responsible official of the business, the business shall be chargeable with the conduct.

(d) Certification. Every bid submitted to and contract executed by the State, and every subcontract subject to Section 20-120 of the Code shall contain a certification by the contractor or the subcontractor, respectively, that the contractor or subcontractor is not barred from being awarded a contract or subcontract under this Section and acknowledges that the CPO may declare the related contract void if any certifications required by this Section are false. A contractor who makes a false statement, material to the certification, commits a Class 3 felony.

The contractor or subcontractor certifies that it is not barred from being awarded a contract under Section 50.5.

B. Felons

Section 50-10. Felons.

(a) Unless otherwise provided, no person or business convicted of a felony shall do business with the State of Illinois or any State agency, or enter into a subcontract, from the date of conviction until 5 years after the date of completion of the sentence for that felony, unless no person held responsible by a prosecutorial office for the facts upon which the conviction was based continues to have any involvement with the business.

(b) Certification. Every bid submitted to and contract executed by the State and every subcontract subject to Section 20-120 of the Code shall contain a certification by the bidder or contractor or subcontractor, respectively, that the bidder, contractor, or subcontractor is not barred from being awarded a contract or subcontract under this Section and acknowledges that the CPO may declare the related contract void if any of the certifications required by this Section are false.

RETURN WITH SUBCONTRACT

C. Debt Delinquency

Section 50-11 and 50-12. Debt Delinquency.

The contractor or bidder or subcontractor, respectively, certifies that it, or any affiliate, is not barred from being awarded a contract or subcontract under the Code. Section 50-11 prohibits a person from entering into a contract with a State agency, or entering into a subcontract, if it knows or should know that it, or any affiliate, is delinquent in the payment of any debt to the State as defined by the Debt Collection Board. Section 50-12 prohibits a person from entering into a contract with a State agency, or entering into a subcontract, if it, or any affiliate, has failed to collect and remit Illinois Use Tax on all sales of tangible personal property into the State of Illinois in accordance with the provisions of the Illinois Use Tax Act. The bidder or contractor or subcontractor, respectively, further acknowledges that the CPO may declare the related contract void if this certification is false or if the bidder, contractor, or subcontractor, or any affiliate, is determined to be delinquent in the payment of any debt to the State during the term of the contract.

D. Prohibited Bidders, Contractors and Subcontractors

Section 50-10.5 and 50-60(c). Prohibited bidders, contractors and subcontractors.

The bidder or contractor or subcontractor, respectively, certifies in accordance with 30 ILCS 500/50-10.5 that no officer, director, partner or other managerial agent of the contracting business has been convicted of a felony under the Sarbanes-Oxley Act of 2002 or a Class 3 or Class 2 felony under the Illinois Securities Law of 1953 or if in violation of Subsection (c) for a period of five years from the date of conviction. Every bid submitted to and contract executed by the State and every subcontract subject to Section 20-120 of the Code shall contain a certification by the bidder, contractor, or subcontractor, respectively, that the bidder, contractor, or subcontractor is not barred from being awarded a contract or subcontract under this Section and acknowledges that the CPO shall declare the related contract void if any of the certifications completed pursuant to this Section are false.

E. Section 42 of the Environmental Protection Act

The bidder or contractor or subcontractor, respectively, certifies in accordance with 30 ILCS 500/50-14 that the bidder, contractor, or subcontractor, is not barred from being awarded a contract or entering into a subcontract under this Section which prohibits the bidding on or entering into contracts with the State of Illinois or a State agency, or entering into any subcontract, that is subject to the Code by a person or business found by a court or the Pollution Control Board to have committed a willful or knowing violation of Section 42 of the Environmental Protection Act for a period of five years from the date of the order. The bidder or contractor or subcontractor, respectively, acknowledges that the CPO may declare the contract void if this certification is false.

The undersigned, on behalf of the subcontracting company, has read and understands the above certifications and makes the certifications as required by law.

_____ Name of Subcontracting Company		
_____ Authorized Officer	_____ Date	

RETURN WITH SUBCONTRACT
SUBCONTRACTOR DISCLOSURES

I. DISCLOSURES

- A.** The disclosures hereinafter made by the subcontractor are each a material representation of fact upon which reliance is placed. The subcontractor further certifies that the Department has received the disclosure forms for each subcontract.

The CPO may void the bid, contract, or subcontract, respectively, if it is later determined that the bidder or subcontractor rendered a false or erroneous disclosure. A contractor or subcontractor may be suspended or debarred for violations of the Code. Furthermore, the CPO may void the contract.

B. Financial Interests and Conflicts of Interest

1. Section 50-35 of the Code provides that all subcontracts with a total value of \$50,000 or more, from subcontractors identified in Section 20-120 of the Code, shall be accompanied by disclosure of the financial interests of the subcontractor. This disclosed information for the subcontractor, will be maintained as public information subject to release by request pursuant to the Freedom of Information Act, filed with the Procurement Policy Board, and shall be incorporated as a material term of the Prime Contractor's contract. Furthermore, pursuant to this Section, the Procurement Policy Board may recommend to allow or void a contract or subcontract based on a potential conflict of interest.

The financial interests to be disclosed shall include ownership or distributive income share that is in excess of 5%, or an amount greater than 60% of the annual salary of the Governor, of the subcontracting entity or its parent entity, whichever is less, unless the subcontractor is a publicly traded entity subject to Federal 10K reporting, in which case it may submit its 10K disclosure in place of the prescribed disclosure. If a subcontractor is a privately held entity that is exempt from Federal 10K reporting, but has more than 200 shareholders, it may submit the information that Federal 10K companies are required to report, and list the names of any person or entity holding any ownership share that is in excess of 5%. The disclosure shall include the names, addresses, and dollar or proportionate share of ownership of each person making the disclosure, their instrument of ownership or beneficial relationship, and notice of any potential conflict of interest resulting from the current ownership or beneficial interest of each person making the disclosure having any of the relationships identified in Section 50-35 and on the disclosure form.

The current annual salary of the Governor is \$177,412.00.

In addition, all disclosures shall indicate any other current or pending contracts, subcontracts, proposals, leases, or other ongoing procurement relationships the subcontracting entity has with any other unit of state government and shall clearly identify the unit and the contract, subcontract, proposal, lease, or other relationship.

2. Disclosure Forms. Disclosure Form A is attached for use concerning the individuals meeting the above ownership or distributive share requirements. A separate Disclosure Form A must be submitted with the bid for each individual meeting the above requirements. In addition, a second form (Disclosure Form B) provides for the disclosure of current or pending procurement relationships with other (non-IDOT) state agencies and a total ownership certification. **The forms must be included with each bid.**

C. Disclosure Form Instructions

Form A Instructions for Financial Information & Potential Conflicts of Interest

If the subcontractor is a publicly traded entity subject to Federal 10K reporting, the 10K Report may be submitted to meet the requirements of Form A. If a subcontractor is a privately held entity that is exempt from Federal 10K reporting, but has more than 200 shareholders, it may submit the information that Federal 10K companies are required to report, and list the names of any person or entity holding any ownership share that is in excess of 5%. If a subcontractor is not subject to Federal 10K reporting, the subcontractor must determine if any individuals are required by law to complete a financial disclosure form. To do this, the subcontractor should answer each of the following questions. A "YES" answer indicates Form A must be completed. If the answer to each of the following questions is "NO", then the **NOT APPLICABLE STATEMENT** on the second page of Form A must be signed and dated by a person that is authorized to execute contracts for the subcontracting company. Note: These questions are for assistance only and are not required to be completed.

1. Does anyone in your organization have a direct or beneficial ownership share of greater than 5% of the bidding entity or parent entity? YES ___ NO ___
2. Does anyone in your organization have a direct or beneficial ownership share of less than 5%, but which has a value greater than 60% of the annual salary of the Governor? YES ___ NO ___
3. Does anyone in your organization receive more than 60% of the annual salary of the Governor of the subcontracting entity's or parent entity's distributive income? YES ___ NO ___

(Note: Distributive income is, for these purposes, any type of distribution of profits. An annual salary is not distributive income.)

4. Does anyone in your organization receive greater than 5% of the subcontracting entity's or parent entity's total distributive income, but which is less than 60% of the annual salary of the Governor? YES ___ NO ___

(Note: Only one set of forms needs to be completed per person per subcontract even if a specific individual would require a yes answer to more than one question.)

A "YES" answer to any of these questions requires the completion of Form A. The subcontractor must determine each individual in the subcontracting entity or the subcontracting entity's parent company that would cause the questions to be answered "Yes". Each form must be signed and dated by a person that is authorized to execute contracts for your organization. **Photocopied or stamped signatures are not acceptable.** The person signing can be, but does not have to be, the person for which the form is being completed. The subcontractor is responsible for the accuracy of any information provided.

If the answer to each of the above questions is "NO", then the **NOT APPLICABLE STATEMENT** on page 2 of Form A must be signed and dated by a person that is authorized to execute contracts for your company.

RETURN WITH SUBCONTRACT

Form B: Instructions for Identifying Other Contracts & Procurement Related Information

Disclosure Form B must be completed for each subcontract submitted by the subcontracting entity. *Note: Checking the NOT APPLICABLE STATEMENT on Form A does not allow the subcontractor to ignore Form B. Form B must be completed, checked, and dated or the subcontract will not be approved.*

The Subcontractor shall identify, by checking Yes or No on Form B, whether it has any pending contracts, subcontracts, leases, bids, proposals, or other ongoing procurement relationship with any other (non-IDOT) State of Illinois agency. If "No" is checked, the subcontractor only needs to complete the check box on the bottom of Form B. If "Yes" is checked, the subcontractor must list all non-IDOT State of Illinois agency pending contracts, subcontracts, leases, bids, proposals, and other ongoing procurement relationships. These items may be listed on Form B or on an attached sheet(s). Contracts with cities, counties, villages, etc. are not considered State of Illinois agency contracts and are not to be included. Contracts or subcontracts with other State of Illinois agencies such as the Department of Natural Resources or the Capital Development Board must be included.

ILLINOIS DEPARTMENT OF TRANSPORTATION

Form A Subcontractor: Financial Information & Potential Conflicts of Interest Disclosure

Subcontractor Name, Legal Address, City, State, Zip, Telephone Number, Email Address, Fax Number (if available)

Disclosure of the information contained in this Form is required by the Section 50-35 of the Code (30 ILCS 500). Subcontractors desiring to enter into a subcontract of a State of Illinois contract must disclose the financial information and potential conflict of interest information as specified in this Disclosure Form.

The current annual salary of the Governor is \$177,412.00.

DISCLOSURE OF FINANCIAL INFORMATION

1. Disclosure of Financial Information. The individual named below has an interest in the SUBCONTRACTOR (or its parent) in terms of ownership or distributive income share in excess of 5%, or an interest which has a value of more than 60% of the annual salary of the Governor.

FOR INDIVIDUAL (type or print information) NAME: ADDRESS Type of ownership/distributable income share: stock sole proprietorship Partnership other: (explain on separate sheet): % or \$ value of ownership/distributable income share:

2. Disclosure of Potential Conflicts of Interest. Check "Yes" or "No" to indicate which, if any, of the following potential conflict of interest relationships apply. If the answer to any question is "Yes", please attach additional pages and describe.

(a) State employment, currently or in the previous 3 years, including contractual employment of services. Yes ___ No ___

If your answer is yes, please answer each of the following questions.

1. Are you currently an officer or employee of either the Capitol Development Board or the Illinois State Toll Highway Authority? Yes ___ No ___

2. Are you currently appointed to or employed by any agency of the State of Illinois? If you are currently appointed to or employed by any agency of the State of Illinois, and your annual salary exceeds 60% of the annual salary of the Governor, provide the name the State agency for which you are employed and your annual salary.

RETURN WITH SUBCONTRACT

3. If you are currently appointed to or employed by any agency of the State of Illinois, and your annual salary exceeds 60% of the annual salary of the Governor, are you entitled to receive (i) more than 7 1/2% of the total distributable income of your firm, partnership, association or corporation, or (ii) an amount in excess of 100% of the annual salary of the Governor?
Yes ___ No ___

4. If you are currently appointed to or employed by any agency of the State of Illinois, and your annual salary exceeds 60% of the annual salary of the Governor, are you and your spouse or minor children entitled to receive (i) more than 15 % in the aggregate of the total distributable income of your firm, partnership, association or corporation, or (ii) an amount in excess of two times the salary of the Governor?
Yes ___ No ___

(b) State employment of spouse, father, mother, son, or daughter, including contractual employment services in the previous 2 years.

Yes ___ No ___

If your answer is yes, please answer each of the following questions.

1. Is your spouse or any minor children currently an officer or employee of the Capitol Development Board or the Illinois State Toll Highway Authority?
Yes ___ No ___

2. Is your spouse or any minor children currently appointed to or employed by any agency of the State of Illinois? If your spouse or minor children is/are currently appointed to or employed by any agency of the State of Illinois, and his/her annual salary exceeds 60% of the annual salary of the Governor, provide the name of your spouse and/or minor children, the name of the State agency for which he/she is employed and his/her annual salary. _____

3. If your spouse or any minor children is/are currently appointed to or employed by any agency of the State of Illinois, and his/her annual salary exceeds 60% of the annual salary of the Governor, are you entitled to receive (i) more than 7 1/2% of the total distributable income of your firm, partnership, association or corporation, or (ii) an amount in excess of 100% of the annual salary of the Governor?
Yes ___ No ___

4. If your spouse or any minor children are currently appointed to or employed by any agency of the State of Illinois, and his/her annual salary exceeds 60% of the annual salary of the Governor, are you and your spouse or minor children entitled to receive (i) more than 15 % in the aggregate of the total distributable income of your firm, partnership, association or corporation, or (ii) an amount in excess of two times the salary of the Governor?
Yes ___ No ___

(c) Elective status; the holding of elective office of the State of Illinois, the government of the United States, any unit of local government authorized by the Constitution of the State of Illinois or the statutes of the State of Illinois currently or in the previous 3 years.
Yes ___ No ___

(d) Relationship to anyone holding elective office currently or in the previous 2 years; spouse, father, mother, son, or daughter.
Yes ___ No ___

(e) Appointive office; the holding of any appointive government office of the State of Illinois, the United States of America, or any unit of local government authorized by the Constitution of the State of Illinois or the statutes of the State of Illinois, which office entitles the holder to compensation in excess of the expenses incurred in the discharge of that office currently or in the previous 3 years.
Yes ___ No ___

(f) Relationship to anyone holding appointive office currently or in the previous 2 years; spouse, father, mother, son, or daughter.
Yes ___ No ___

(g) Employment, currently or in the previous 3 years, as or by any registered lobbyist of the State government.
Yes ___ No ___

RETURN WITH SUBCONTRACT

(h) Relationship to anyone who is or was a registered lobbyist in the previous 2 years; spouse, father, mother, son, or daughter. Yes ___ No ___

(i) Compensated employment, currently or in the previous 3 years, by any registered election or reelection committee registered with the Secretary of State or any county clerk of the State of Illinois, or any political action committee registered with either the Secretary of State or the Federal Board of Elections. Yes ___ No ___

(j) Relationship to anyone; spouse, father, mother, son, or daughter; who was a compensated employee in the last 2 years by any registered election or re-election committee registered with the Secretary of State or any county clerk of the State of Illinois, or any political action committee registered with either the Secretary of State or the Federal Board of Elections. Yes ___ No ___

3 Communication Disclosure.

Disclose the name and address of each lobbyist and other agent of the bidder or offeror who is not identified in Section 2 of this form, who is has communicated, is communicating, or may communicate with any State officer or employee concerning the bid or offer. This disclosure is a continuing obligation and must be promptly supplemented for accuracy throughout the process and throughout the term of the contract. If no person is identified, enter "None" on the line below:

Name and address of person(s): _____

RETURN WITH SUBCONTRACT

4. Debarment Disclosure. For each of the persons identified under Sections 2 and 3 of this form, disclose whether any of the following has occurred within the previous 10 years: debarment from contracting with any governmental entity; professional licensure discipline; bankruptcies; adverse civil judgments and administrative findings; and criminal felony convictions. This disclosure is a continuing obligation and must be promptly supplemented for accuracy throughout the procurement process and term of the contract. If no person is identified, enter "None" on the line below:

Name of person(s): _____

Nature of disclosure: _____

APPLICABLE STATEMENT

This Disclosure Form A is submitted on behalf of the INDIVIDUAL named on previous page. Under penalty of perjury, I certify the contents of this disclosure to be true and accurate to the best of my knowledge.

Completed by: _____ Date _____
Signature of Individual or Authorized Officer

NOT APPLICABLE STATEMENT

Under penalty of perjury, I have determined that no individuals associated with this organization meet the criteria that would require the completion of this Form A.

This Disclosure Form A is submitted on behalf of the SUBCONTRACTOR listed on the previous page.

_____ Date _____
Signature of Authorized Officer

RETURN WITH SUBCONTRACT

ILLINOIS DEPARTMENT OF TRANSPORTATION

Form B
Subcontractor: Other Contracts & Financial Related Information Disclosure

Form with fields: Subcontractor Name, Legal Address, City, State, Zip, Telephone Number, Email Address, Fax Number (if available)

Disclosure of the information contained in this Form is required by the Section 50-35 of the Code (30 ILCS 500). This information shall become part of the publicly available contract file. This Form B must be completed for subcontracts with a total value of \$50,000 or more, from subcontractors identified in Section 20-120 of the Code, and for all open-ended contracts.

DISCLOSURE OF OTHER CONTRACTS, SUBCONTRACTS, AND PROCUREMENT RELATED INFORMATION

1. Identifying Other Contracts & Procurement Related Information. The SUBCONTRACTOR shall identify whether it has any pending contracts, subcontracts, including leases, bids, proposals, or other ongoing procurement relationship with any other State of Illinois agency: Yes ___ No ___

If "No" is checked, the subcontractor only needs to complete the signature box on the bottom of this page.

2. If "Yes" is checked. Identify each such relationship by showing State of Illinois agency name and other descriptive information such as bid or project number (attach additional pages as necessary). SEE DISCLOSURE FORM INSTRUCTIONS:

THE FOLLOWING STATEMENT MUST BE CHECKED

Signature box with fields: Signature of Authorized Officer, Date

OWNERSHIP CERTIFICATION

Please certify that the following statement is true if the individuals for all submitted Form A disclosures do not total 100% of ownership

Any remaining ownership interest is held by individuals receiving less than \$106,447.20 of the bidding entity's or parent entity's distributive income or holding less than a 5% ownership interest.

Yes No N/A (Form A disclosure(s) established 100% ownership)



NOTICE TO BIDDERS

- 1. TIME AND PLACE OF OPENING BIDS.** Sealed proposals for the improvement described herein will be received by the Department of Transportation. Electronic bids are to be submitted to the electronic bidding system (ics-Integrated Contractors Exchange). Paper-based bids are to be submitted to the Chief Procurement Officer for the Department of Transportation in care of the Chief Contracts Official at the Harry R. Hanley Building, 2300 South Dirksen Parkway, in Springfield, Illinois until 10:00 o'clock a.m. November 8, 2013. All bids will be gathered, sorted, publicly opened and read in the auditorium at the Department of Transportation's Harry R. Hanley Building shortly after the 10:00 a.m. cut off time.
- 2. DESCRIPTION OF WORK.** The proposed improvement is identified and advertised for bids in the Invitation for Bids as:

**Contract No. 63863
KANE County
Section 09-00286-00-BR (Aurora)
Project BRM-9003(510)
Route FAU 1503 (Indian Trail Road)
District 1 Construction Funds**

Work consists of widening and deck replacement of the two structures carrying Indian Trail Road over the Fox River in the City of Aurora. Project will include pavement removal, PCC pavement, sidewalk, curb and gutter, storm sewer, lighting and all incidental work to complete the project.

- 3. INSTRUCTIONS TO BIDDERS.** (a) This Notice, the invitation for bids, proposal and letter of award shall, together with all other documents in accordance with Article 101.09 of the Standard Specifications for Road and Bridge Construction, become part of the contract. Bidders are cautioned to read and examine carefully all documents, to make all required inspections, and to inquire or seek explanation of the same prior to submission of a bid.

(b) State law, and, if the work is to be paid wholly or in part with Federal-aid funds, Federal law requires the bidder to make various certifications as a part of the proposal and contract. By execution and submission of the proposal, the bidder makes the certification contained therein. A false or fraudulent certification shall, in addition to all other remedies provided by law, be a breach of contract and may result in termination of the contract.
- 4. AWARD CRITERIA AND REJECTION OF BIDS.** This contract will be awarded to the lowest responsive and responsible bidder considering conformity with the terms and conditions established by the Department in the rules, Invitation for Bids and contract documents. The issuance of plans and proposal forms for bidding based upon a prequalification rating shall not be the sole determinant of responsibility. The Department reserves the right to determine responsibility at the time of award, to reject any or all proposals, to readvertise the proposed improvement, and to waive technicalities.

By Order of the
Illinois Department of Transportation

Ann L. Schneider,
Secretary

INDEX
FOR
SUPPLEMENTAL SPECIFICATIONS
AND RECURRING SPECIAL PROVISIONS

Adopted January 1, 2013

This index contains a listing of SUPPLEMENTAL SPECIFICATIONS, frequently used RECURRING SPECIAL PROVISIONS, and LOCAL ROADS AND STREETS RECURRING SPECIAL PROVISIONS.

ERRATA Standard Specifications for Road and Bridge Construction (Adopted 1-1-12) (Revised 1-1-13)

SUPPLEMENTAL SPECIFICATIONS

<u>Std. Spec. Sec.</u>	<u>Page No.</u>
105 Control of Work	1
107 Legal Regulations and Responsibility to Public	2
202 Earth and Rock Excavation	4
211 Topsoil and Compost	5
407 Hot-Mix Asphalt Pavement (Full-Depth)	6
420 Portland Cement Concrete Pavement	10
424 Portland Cement Concrete Sidewalk	12
503 Concrete Structures	13
504 Precast Concrete Structures	14
540 Box Culverts	15
603 Adjusting Frames and Grates of Drainage and Utility Structures	16
610 Shoulder Inlets with Curb	18
642 Shoulder Rumble Strips	19
643 Impact Attenuators	20
701 Work Zone Traffic Control and Protection	22
706 Impact Attenuators, Temporary	24
780 Pavement Striping	26
860 Master Controller	27
1006 Metals	28
1042 Precast Concrete Products	29
1073 Controller	30
1083 Elastomeric Bearings	31
1101 General Equipment	32
1106 Work Zone Traffic Control Devices	34

RECURRING SPECIAL PROVISIONS

The following RECURRING SPECIAL PROVISIONS indicated by an "X" are applicable to this contract and are included by reference:

<u>CHECK SHEET #</u>	<u>PAGE NO.</u>
1 X Additional State Requirements for Federal-Aid Construction Contracts (Eff. 2-1-69) (Rev. 1-1-10)	35
2 X Subletting of Contracts (Federal-Aid Contracts) (Eff. 1-1-88) (Rev. 5-1-93)	38
3 X EEO (Eff. 7-21-78) (Rev. 11-18-80)	39
4 Specific Equal Employment Opportunity Responsibilities Non Federal-Aid Contracts (Eff. 3-20-69) (Rev. 1-1-94)	49
5 Required Provisions - State Contracts (Eff. 4-1-65) (Rev. 1-1-13)	54
6 Asbestos Bearing Pad Removal (Eff. 11-1-03)	59
7 Asbestos Waterproofing Membrane and Asbestos Hot-Mix Asphalt Surface Removal (Eff. 6-1-89) (Rev. 1-1-09)	60
8 X Haul Road Stream Crossings, Other Temporary Stream Crossings, and In-Stream Work Pads (Eff. 1-2-92) (Rev. 1-1-98)	61
9 Construction Layout Stakes Except for Bridges (Eff. 1-1-99) (Rev. 1-1-07)	62
10 X Construction Layout Stakes (Eff. 5-1-93) (Rev. 1-1-07)	65
11 Use of Geotextile Fabric for Railroad Crossing (Eff. 1-1-95) (Rev. 1-1-07)	68
12 Subsealing of Concrete Pavements (Eff. 11-1-84) (Rev. 1-1-07)	70
13 Hot-Mix Asphalt Surface Correction (Eff. 11-1-87) (Rev. 1-1-09)	74
14 Pavement and Shoulder Resurfacing (Eff. 2-1-00) (Rev. 1-1-09)	76
15 PCC Partial Depth Hot-Mix Asphalt Patching (Eff. 1-1-98) (Rev. 1-1-07)	77
16 Patching with Hot-Mix Asphalt Overlay Removal (Eff. 10-1-95) (Rev. 1-1-07)	79
17 Polymer Concrete (Eff. 8-1-95) (Rev. 1-1-08)	80
18 PVC Pipeliner (Eff. 4-1-04) (Rev. 1-1-07)	82
19 Pipe Underdrains (Eff. 9-9-87) (Rev. 1-1-07)	83
20 X Guardrail and Barrier Wall Delineation (Eff. 12-15-93) (Rev. 1-1-12)	84
21 Bicycle Racks (Eff. 4-1-94) (Rev. 1-1-12)	88
22 Temporary Modular Glare Screen System (Eff. 1-1-00) (Rev. 1-1-07)	90
23 Temporary Portable Bridge Traffic Signals (Eff. 8-1-03) (Rev. 1-1-07)	92
24 Work Zone Public Information Signs (Eff. 9-1-02) (Rev. 1-1-07)	94
25 Night Time Inspection of Roadway Lighting (Eff. 5-1-96)	95
26 English Substitution of Metric Bolts (Eff. 7-1-96)	96
27 English Substitution of Metric Reinforcement Bars (Eff. 4-1-96) (Rev. 1-1-03)	97
28 Calcium Chloride Accelerator for Portland Cement Concrete (Eff. 1-1-01) (Rev. 1-1-13)	98
29 Portland Cement Concrete Inlay or Overlay for Pavements (Eff. 11-1-08) (Rev. 1-1-13)	99
30 Quality Control of Concrete Mixtures at the Plant (Eff. 8-1-00) (Rev. 1-1-11)	102
31 Quality Control/Quality Assurance of Concrete Mixtures (Eff. 4-1-92) (Rev. 1-1-11)	110
32 Digital Terrain Modeling for Earthwork Calculations (Eff. 4-1-07)	122

LOCAL ROADS AND STREETS RECURRING SPECIAL PROVISIONS

The following LOCAL ROADS AND STREETS RECURRING SPECIAL PROVISIONS indicated by an "X" are applicable to this contract and are included by reference:

Table of Contents

<u>CHECK SHEET #</u>	<u>PAGE NO.</u>
LRS 1 Reserved	125
LRS 2 <input checked="" type="checkbox"/> Furnished Excavation	126
LRS 3 <input type="checkbox"/> Work Zone Traffic Control Surveillance	127
LRS 4 <input checked="" type="checkbox"/> Flaggers in Work Zones	128
LRS 5 <input type="checkbox"/> Contract Claims	129
LRS 6 <input type="checkbox"/> Bidding Requirements and Conditions for Contract Proposals	130
LRS 7 <input type="checkbox"/> Bidding Requirements and Conditions for Material Proposals	136
LRS 8 Reserved	142
LRS 9 <input type="checkbox"/> Bituminous Surface Treatments	143
LRS 10 Reserved	144
LRS 11 <input type="checkbox"/> Employment Practices	145
LRS 12 <input type="checkbox"/> Wages of Employees on Public Works (Eff. 1-1-99) (Rev. 1-1-13).....	147
LRS 13 <input type="checkbox"/> Selection of Labor	149
LRS 14 <input type="checkbox"/> Paving Brick and Concrete Paver Pavements and Sidewalks	150
LRS 15 <input type="checkbox"/> Partial Payments	153
LRS 16 <input type="checkbox"/> Protests on Local Lettings	154
LRS 17 <input type="checkbox"/> Substance Abuse Prevention Program.....	155
LRS 18 <input type="checkbox"/> Multigrade Cold Mix Asphalt	156

SPECIAL PROVISIONS

INDEX OF SHEETS

LOCATION OF PROJECT 1

DESCRIPTION OF PROJECT 1

MAINTENANCE OF ROADWAYS 1

TRAFFIC CONTROL PLAN 2

COMPLETION DATE PLUS WORKING DAYS..... 2

AGGREGATE SUBGRADE IMPROVEMENT (D-1)..... 3

TRAFFIC CONTROL AND PROTECTION, (SPECIAL) 5

STATUS OF UTILITIES TO BE ADJUSTED 7

TEMPORARY INFORMATION SIGNING 8

COARSE AGGREGATE FOR BACKFILL, TRENCH BACKFILL AND BEDDING (D-1) 9

HMA MIXTURE DESIGN REQUIREMENTS (D-1)..... 10

FRICTION SURFACE AGGREGATE (D1)..... 13

GROUND TIRE RUBBER (GTR) MODIFIED ASPHALT BINDER (D-1)..... 16

EMBANKMENT I 18

PORTLAND CEMENT CONCRETE SIDEWALK 6 INCH, SPECIAL 19

CONCRETE FINISHES 20

FURNISHING MOCK-UPS 21

FURNISHING AND ERECTING PRECAST CONCRETE PILASTERS AND MEDALLIONS 22

CONCRETE BRIDGE RAILING 24

PARAPET RAILING, SPECIAL 24

DRAINAGE SCUPPER 26

NAME PLATES (SPECIAL) 27

MANHOLE, SPECIAL 30

FENCE REMOVAL 30

BITUMINOUS PRIME COAT FOR HOT-MIX ASPHALT PAVEMENT (FULL DEPTH) (D-1)..... 30

RECLAIMED ASPHALT PAVEMENT AND RECLAIMED ASPHALT SHINGLES (D-1) 31

FINE AGGREGATE FOR HOT- MIX ASPHALT (HMA) (D-1) 41

EXISTING BRIDGE PLANS 41

DEWATERING	41
SEDIMENT FILTER BAGS	43
SEDIMENT CONTROL, SILT CURTAIN.....	43
STEEL CASING 66".....	45
BRICK PAVERS	46
TRAFFIC BARRIER TERMINAL, TYPE 1, SPECIAL (FLARED), MODIFIED.....	48
GENERAL ELECTRICAL REQUIREMENTS	49
LIGHT FIXTURE ASSEMBLY – TYPE A	60
LIGHT FIXTURE ASSEMBLY – TYPE B	61
MAINTENANCE OF LIGHTING SYSTEMS	63
TRAFFIC SIGNAL SPECIFICATIONS	67
UTILITY HANGER.....	122
REMOVAL OF ASBESTOS CEMENT CONDUIT	123
TEMPORARY PAVEMENT.....	124
TEMPORARY SIDEWALK.....	124
HEAVY DUTY EROSION CONTROL BLANKET (SPECIAL).....	125
WEED CONTROL, PRE-EMERGENT GRANULAR HERBICIDE	126
PUBLIC CONVENIENCE AND SAFETY (DIST 1)	127
TRAFFIC SIGNAL SPECIFICATIONS FOR DETECTOR REPLACEMENT AND/OR INSTALLATION ON ROADWAY GRINDING, RESURFACING, & PATCHING OPERATIONS....	127
IDOT TRAINING PROGRAM GRADUATE ON-THE-JOB TRAINING SPECIAL PROVISION (TPG)	

STORM WATER POLLUTION PREVENTION PLAN (SWPPP).....	
IDNR PERMIT	
ARMY CORP PERMIT	
KD-SWCD PERMIT	
GEOTECHNICAL REPORT	
EXISTING DESIGN PLANS.....	

GUIDE BRIDGE SPECIAL PROVISION INDEX/CHECK SHEET

Effective as of the: September 20, 2013 Letting

Pg #	✓	File Name	Title	Effective	Revised
		GBSP 4	Polymer Modified Portland Cement Mortar	June 7, 1994	July 26, 2013
		GBSP 12	Drainage System	June 10, 1994	Jan 1, 2007
		GBSP 13	High-Load Multi-Rotational Bearings	Oct 13, 1988	Oct 30, 2012
240	X	GBSP 14	Jack and Remove Existing Bearings	April 20, 1994	Jan 1, 2007
		GBSP 15	Three Sided Precast Concrete Structure	July 12, 1994	Oct 15, 2011
		GBSP 16	Jacking Existing Superstructure	Jan 11, 1993	Jan 1, 2007
		GBSP 17	Bonded Preformed Joint Seal	July 12, 1994	Jan 1, 2007
		GBSP 18	Modular Expansion Joint	May 19, 1994	July 26, 2013
		GBSP 21	Cleaning and Painting Contact Surface Areas of Existing Steel Structures	June 30, 2003	May 18, 2011
242	X	GBSP 25	Cleaning and Painting Existing Steel Structures	Oct 2, 2001	April 19, 2012
264	X	GBSP 26	Containment and Disposal of Lead Paint Cleaning Residues	Oct 2, 2001	April 30, 2010
288	X	GBSP 28	Deck Slab Repair	May 15, 1995	Oct 15, 2011
		GBSP 29	Bridge Deck Microsilica Concrete Overlay	May 15, 1995	Oct 30, 2012
		GBSP 30	Bridge Deck Latex Concrete Overlay	May 15, 1995	Jan 18, 2011
		GBSP 31	Bridge Deck High-Reactivity Metakaolin (HRM) Conc Overlay	Jan 21, 2000	Oct 30, 2012
		GBSP 32	Temporary Sheet Piling	Sept 2, 1994	Jan 31, 2012
		GBSP 33	Pedestrian Truss Superstructure	Jan 13, 1998	Aug 17, 2012
		GBSP 34	Concrete Wearing Surface	June 23, 1994	Feb 6, 2013
		GBSP 35	Silicone Bridge Joint Sealer	Aug 1, 1995	Oct 15, 2011
		GBSP 38	Mechanically Stabilized Earth Retaining Walls	Feb 3, 1999	July 26, 2013
		GBSP 42	Drilled Soldier Pile Retaining Wall	Sept 20, 2001	Aug 17, 2012
		GBSP 43	Driven Soldier Pile Retaining Wall	Nov 13, 2002	Aug 17, 2012
		GBSP 44	Temporary Soil Retention System	Dec 30, 2002	May 11, 2009
		GBSP 45	Bridge Deck Thin Polymer Overlay	May 7, 1997	Feb 6, 2013
		GBSP 46	Geotextile Retaining Walls	Sept 19, 2003	July 26, 2013
		GBSP 47	High Performance Concrete Structures	Aug 5, 2002	Jan 1, 2007
		GBSP 51	Pipe Underdrain for Structures	May 17, 2000	Jan 22, 2010
294	X	GBSP 53	Structural Repair of Concrete	Mar 15, 2006	July 26, 2013
		GBSP 55	Erection of Curved Steel Structures	June 1, 2007	
		GBSP 56	Setting Piles in Rock	Nov 14, 1996	April 19, 2012
		GBSP 57	Temporary Mechanically Stabilized Earth Retaining Walls	Jan 6, 2003	July 26, 2013
		GBSP 59	Diamond Grinding and Surface Testing Bridge Sections	Dec 6, 2004	July 9, 2008
		GBSP 60	Containment and Disposal of Non-Lead Paint Cleaning Residues	Nov 25, 2004	Mar 6, 2009
		GBSP 61	Slipform Parapet	June 1, 2007	Aug 17, 2012
		GBSP 62	Concrete Deck Beams	June 13, 2008	Oct 9, 2009
		GBSP 64	Segmental Concrete Block Wall	Jan 7, 1999	Oct 30, 2012
		GBSP 65	Precast Modular Retaining Walls	Mar 19, 2001	Oct 30, 2012
		GBSP 66	Wave Equation Analysis of Piles	Nov 14, 2008	
		GBSP 67	Structural Assessment Reports for Contractor's Means and Methods	Mar 6, 2009	
		GBSP 70	Braced Excavation	Aug 9, 1995	May 18, 2011
		GBSP 71	Aggregate Column Ground Improvement	Jan 15, 2009	Oct 15, 2011

		GBSP 72	Bridge Deck Fly Ash or GGBF Slag Concrete Overlay	Jan 18, 2011	Oct 15, 2011
305	X	GBSP 73	Cofferdams	Oct 15, 2011	
		GBSP 74	Permanent Steel Sheet Piling (LRFD)	Jan 31, 2012	Aug 17, 2012
		GBSP 75	Bond Breaker for Prestressed Concrete Bulb-T Beams	April 19, 2012	
307	X	GBSP 76	Granular Backfill for Structures	April 19, 2012	Oct 30, 2012
309	X	GBSP 77	Weep Hole Drains for Abutments, Wingwalls, Retaining Walls And Culverts	April 19, 2012	

LIST ANY ADDITIONAL SPECIAL PROVISIONS BELOW

The following Guide Bridge Special Provisions have been incorporated into the 2012 Standard Specifications:

File Name	Title	Std Spec Location
GBSP22	Cleaning and Painting New Metal Structures	506
GBSP36	Surface Preparation and Painting Req. for Weathering Steel	506
GBSP50	Removal of Existing Non-composite Bridge Decks	501
GBSP58	Mechanical Splicers	508
GBSP63	Demolition Plans for Removal of Existing Structures	501
GBSP68	Piling	512
GBSP69	Freeze-Thaw Aggregates for Concrete Superstructures Poured on Grade	1004

The following Guide Bridge Special Provisions have been discontinued or have been superseded:

File Name	Title	Disposition:
GBSP37	Underwater Structure Excavation Protection	Replaced by GBSP73
GBSP11	Permanent Steel Sheet Piling	Replaced by GBSP74
GBSP52	Porous Granular Embankment (Special)	Replaced by GBSP76

INDEX LOCAL ROADS AND STREETS SPECIAL PROVISIONS

<u>LR #</u>	<u>Pg #</u>	<u>Special Provision Title</u>	<u>Effective</u>	<u>Revised</u>
LR SD12		<input type="checkbox"/> Slab Movement Detection Device	Nov. 11, 1984	Jan. 1, 2007
LR SD13		<input type="checkbox"/> Required Cold Milled Surface Texture	Nov. 1, 1987	Jan. 1, 2007
LR SD406		<input type="checkbox"/> Safety Edge	April 1, 2011	
LR 105	310	<input checked="" type="checkbox"/> Cooperation with Utilities	Jan. 1, 1999	Jan. 1, 2007
LR 107-2		<input type="checkbox"/> Railroad Protective Liability Insurance for Local Lettings	Mar. 1, 2005	Jan. 1, 2006
LR 107-4	313	<input checked="" type="checkbox"/> Insurance	Feb. 1, 2007	Aug. 1, 2007
LR 107-7		<input type="checkbox"/> Wages of Employees on Public Works	Jan. 1, 1999	Jan. 2, 2013
LR 108		<input type="checkbox"/> Combination Bids	Jan. 1, 1994	Mar. 1, 2005
LR 109		<input type="checkbox"/> Equipment Rental Rates	Jan. 1, 2012	
LR 212		<input type="checkbox"/> Shaping Roadway	Aug. 1, 1969	Jan. 1, 2002
LR 355-1		<input type="checkbox"/> Bituminous Stabilized Base Course, Road Mix or Traveling Plant Mix	Oct. 1, 1973	Jan. 1, 2007
LR 355-2		<input type="checkbox"/> Bituminous Stabilized Base Course, Plant Mix	Feb. 20, 1963	Jan. 1, 2007
LR 400-1		<input type="checkbox"/> Bituminous Treated Earth Surface	Jan. 1, 2007	Apr. 1, 2012
LR 400-2		<input type="checkbox"/> Bituminous Surface Plant Mix (Class B)	Jan. 1, 2008	
LR 400-3		<input type="checkbox"/> Hot In-Place Recycling (HIR) – Surface Recycling	Jan. 1, 2012	
LR 400-4		<input type="checkbox"/> Full-Depth Reclamation (FDR) with Emulsified Asphalt	Apr. 1, 2012	Jun. 1, 2012
LR 400-5		<input type="checkbox"/> Cold In-Place Recycling (CIR) With Emulsified Asphalt	Apr. 1, 2012	Jun. 1, 2012
LR 400-6		<input type="checkbox"/> Cold In Place Recycling (CIR) with Foamed Asphalt	June 1, 2012	
LR 400-7		<input type="checkbox"/> Full-Depth Reclamation (FDR) with Foamed Asphalt	June 1, 2012	
LR 402		<input type="checkbox"/> Salt Stabilized Surface Course	Feb. 20, 1963	Jan. 1, 2007
LR 403-1		<input type="checkbox"/> Surface Profile Milling of Existing, Recycled or Reclaimed Flexible Pavement	Apr. 1, 2012	Jun. 1, 2012
LR 403-2		<input type="checkbox"/> Bituminous Hot Mix Sand Seal Coat	Aug. 1, 1969	Jan. 1, 2007
LR 406		<input type="checkbox"/> Filling HMA Core Holes with Non-shrink Grout	Jan. 1, 2008	
LR 420		<input type="checkbox"/> PCC Pavement (Special)	May 12, 1964	Jan. 2, 2007
LR 442		<input type="checkbox"/> Bituminous Patching Mixtures for Maintenance Use	Jan. 1, 2004	Jun. 1, 2007
LR 451		<input type="checkbox"/> Crack Filling Bituminous Pavement with Fiber-Asphalt	Oct. 1, 1991	Jan. 1, 2007
LR 503-1		<input type="checkbox"/> Furnishing Class SI Concrete	Oct. 1, 1973	Jan. 1, 2002
LR 503-2		<input type="checkbox"/> Furnishing Class SI Concrete (Short Load)	Jan. 1, 1989	Jan. 1, 2002
LR 542		<input type="checkbox"/> Pipe Culverts, Type _____ (Furnished)	Sep. 1, 1964	Jan. 1, 2007
LR 663		<input type="checkbox"/> Calcium Chloride Applied	Jun. 1, 1958	Jan. 1, 2007
LR 702		<input type="checkbox"/> Construction and Maintenance Signs	Jan. 1, 2004	Jun. 1, 2007
LR 1000-1		<input type="checkbox"/> Cold In-Place Recycling (CIR) and Full Depth Reclamation (FDR) with Emulsified Asphalt Mix Design Procedures	Apr. 1, 2012	Jun. 1, 2012
LR 1000-2		<input type="checkbox"/> Cold In-Place Recycling (CIR) and Full Depth Reclamation (FDR) with Foamed Asphalt Mix Design Procedures	June 1, 2012	
LR 1004		<input type="checkbox"/> Coarse Aggregate for Bituminous Surface Treatment	Jan. 1, 2002	Jan. 1, 2007
LR 1030		<input type="checkbox"/> Growth Curve	Mar. 1, 2008	Jan. 1, 2010
LR 1032-1		<input type="checkbox"/> Emulsified Asphalts	Jan. 1, 2007	Feb. 7, 2008
LR 1102		<input type="checkbox"/> Road Mix or Traveling Plan Mix Equipment	Jan. 1, 2007	

BDE SPECIAL PROVISIONS
For the November 8, 2013 Letting

The following special provisions indicated by an "x" are applicable to this contract. An * indicates a new or revised special provision for the letting.

<u>File Name</u>	<u>Pg.</u>	<u>Special Provision Title</u>	<u>Effective</u>	<u>Revised</u>
80240		Above Grade Inlet Protection	July 1, 2009	Jan. 1, 2012
80099		Accessible Pedestrian Signals (APS)	April 1, 2003	Jan. 1, 2007
80274		Aggregate Subgrade Improvement	April 1, 2012	Jan. 1, 2013
80309	314	X Anchor Bolts	Jan. 1, 2013	
80192		Automated Flagger Assistance Device	Jan. 1, 2008	
80173		Bituminous Materials Cost Adjustments	Nov. 2, 2006	Aug. 1, 2013
80241		Bridge Demolition Debris	July 1, 2009	
80276		Bridge Relief Joint Sealer	Jan. 1, 2012	Aug. 1, 2012
50261		Building Removal-Case I (Non-Friable and Friable Asbestos)	Sept. 1, 1990	April 1, 2010
50481		Building Removal-Case II (Non-Friable Asbestos)	Sept. 1, 1990	April 1, 2010
50491		Building Removal-Case III (Friable Asbestos)	Sept. 1, 1990	April 1, 2010
50531		Building Removal-Case IV (No Asbestos)	Sept. 1, 1990	April 1, 2010
80292		Coarse Aggregate in Bridge Approach Slabs/Footings	April 1, 2012	April 1, 2013
80310	315	X Coated Galvanized Steel Conduit	Jan. 1, 2013	
80198		Completion Date (via calendar days)	April 1, 2008	
80199		Completion Date (via calendar days) Plus Working Days	April 1, 2008	
80293		Concrete Box Culverts with Skews > 30 Degrees and Design Fills ≤ 5 Feet	April 1, 2012	
80294		Concrete Box Culverts with Skews ≤ 30 Degrees Regardless of Design Fill and Skews > 30 Degrees with Design Fills > 5 Feet	April 1, 2012	
80311		Concrete End Sections for Pipe Culverts	Jan. 1, 2013	
80277		Concrete Mix Design – Department Provided	Jan. 1, 2012	
80261	316	X Construction Air Quality – Diesel Retrofit	June 1, 2010	
80029	319	X Disadvantaged Business Enterprise Participation	Sept. 1, 2000	Aug. 2, 2011
80312	329	X Drain Pipe, Tile, Drainage Mat, and Wall Drain	Jan. 1, 2013	
80313		Fabric Bearing Pads	Jan. 1, 2013	
80265		Friction Aggregate	Jan. 1, 2011	
80229	330	X Fuel Cost Adjustment	April 1, 2009	July 1, 2009
80303	334	X Granular Materials	Nov. 1, 2012	
80304		Grooving for Recessed Pavement Markings	Nov. 1, 2012	Jan. 1, 2013
80169		High Tension Cable Median Barrier	Jan. 1, 2007	Jan. 1, 2013
80246	335	X Hot-Mix Asphalt – Density Testing of Longitudinal Joints	Jan. 1, 2010	April 1, 2012
* 80322		Hot-Mix Asphalt – Mixture Design Composition and Volumetric Requirements	Nov 1, 2013	
* 80323		Hot-Mix Asphalt – Mixture Design Verification and Production	Nov 1, 2013	
* 80315		Insertion Lining of Culverts	Jan. 1, 2013	Nov. 1, 2013
80320	337	X Liquidated Damages	April 1, 2013	
* 80324		LRFD Pipe Culvert Burial Tables	Nov 1, 2013	
* 80325	338	X LRFD Storm Sewer Burial Tables	Nov 1, 2013	
80045		Material Transfer Device	June 15, 1999	Jan. 1, 2009
80297		Modified Urethane Pavement Marking	April 1, 2012	
80165		Moisture Cured Urethane Paint System	Nov. 1, 2006	Jan. 1, 2010
80253		Movable Traffic Barrier	Jan. 1, 2010	Jan. 1, 2013
80231		Pavement Marking Removal	April 1, 2009	
80298		Pavement Marking Tape Type IV	April 1, 2012	
80254		Pavement Patching	Jan. 1, 2010	
80321	348	X Pavement Removal	April 1, 2013	
80022	349	X Payments to Subcontractors	June 1, 2000	Jan. 1, 2006

<u>File Name</u>	<u>Pg.</u>		<u>Special Provision Title</u>	<u>Effective</u>	<u>Revised</u>
80316	351	X	Placing and Consolidating Concrete	Jan. 1, 2013	
80278	354	X	Planting Woody Plants	Jan. 1, 2012	Aug. 1, 2012
80305			Polyurea Pavement Markings	Nov. 1, 2012	Jan. 1, 2013
* 80279	356	X	Portland Cement Concrete	Jan. 1, 2012	Nov. 1, 2013
* 80326	399	X	Portland Cement Concrete Equipment	Nov. 1, 2013	
80300			Preformed Plastic Pavement Marking Type D - Inlaid	April 1, 2012	
80218			Preventive Maintenance – Bituminous Surface Treatment	Jan. 1, 2009	April 1, 2012
80219			Preventive Maintenance – Cape Seal	Jan. 1, 2009	April 1, 2012
80220			Preventive Maintenance – Micro-Surfacing	Jan. 1, 2009	April 1, 2012
80221			Preventive Maintenance – Slurry Seal	Jan. 1, 2009	April 1, 2012
* 80328	399A	X	Progress Payments	Nov. 2, 2013	
* 80281	400	X	Quality Control/Quality Assurance of Concrete Mixtures	Jan. 1, 2012	Nov. 1, 2013
34261			Railroad Protective Liability Insurance	Dec. 1, 1986	Jan. 1, 2006
80157	416	X	Railroad Protective Liability Insurance (5 and 10)	Jan. 1, 2006	
* 80306			Reclaimed Asphalt Pavement (RAP) and Reclaimed Asphalt Shingles (RAS)	Nov. 1, 2012	Nov. 1, 2013
* 80327	48	X	Reinforcement bars	Nov. 1, 2013	
80283	420	X	Removal and Disposal of Regulated Substances	Jan. 1, 2012	Nov. 2, 2012
80319			Removal and Disposal of Surplus Materials	Nov. 2, 2012	
80224			Restoring Bridge Approach Pavements Using High-Density Foam	Jan. 1, 2009	Jan. 1, 2012
80307			Seeding	Nov. 1, 2012	
80127			Steel Cost Adjustment	April 2, 2004	April 1, 2009
80255			Stone Matrix Asphalt	Jan. 1, 2010	Aug. 1, 2013
80143	429	X	Subcontractor Mobilization Payments	April 2, 2005	April 1, 2011
80317			Surface Testing of Hot-Mix Asphalt Overlays (NOTE: This special provision was previously named "Surface Testing of Pavements".)	Jan. 1, 2013	
80308			Synthetic Fibers in Concrete Gutter, Curb, Median and Paved Ditch	Nov. 1, 2012	
80286	430	X	Temporary Erosion and Sediment Control	Jan. 1, 2012	
80225			Temporary Raised Pavement Marker	Jan. 1, 2009	
80256			Temporary Water Filled Barrier	Jan. 1, 2010	Jan. 1, 2013
80301	431	X	Tracking the Use of Pesticides	Aug. 1, 2012	
80273	432	X	Traffic Control Deficiency Deduction	Aug. 1, 2011	
20338	433	X	Training Special Provisions	Oct. 15, 1975	
80318			Traversable Pipe Grate	Jan. 1, 2013	April 1, 2013
80270			Utility Coordination and Conflicts	April 1, 2011	Jan. 1, 2012
* 80288	436	X	Warm Mix Asphalt	Jan. 1, 2012	Nov. 1, 2013
80302	440	X	Weekly DBE Trucking Reports	June 2, 2012	
80289			Wet Reflective Thermoplastic Pavement Marking	Jan. 1, 2012	
80071			Working Days	Jan. 1, 2002	

The following special provisions have been deleted from use:

80271 Safety Edge

The following special provisions are either in the 2013 Standard Specifications, the 2013 Recurring Special Provisions, or the special provisions Portland Cement Concrete, QC/QA of Concrete Mixtures, or Placing and Consolidating Concrete:

<u>File Name</u>	<u>Special Provision Title</u>	<u>New Location</u>	<u>Effective</u>	<u>Revised</u>
80275	Agreement to Plan Quantity	Article 202.07	Jan. 1, 2012	
80291	Calcium Chloride Accelerator for Class PP-2 Concrete	Recurring CS #28	April 1, 2012	
80237	Construction Air Quality – Diesel Vehicle Emissions Control	Articles 105.03 and 107.41	April 1, 2009	Jan. 2, 2012

<u>File Name</u>	<u>Special Provision Title</u>	<u>New Location</u>	<u>Effective</u>	<u>Revised</u>
80239	Construction Air Quality—Idling Restrictions	Articles 105.03 and 107.41	April 1, 2009	
80177	Digital Terrain Modeling for Earthwork Calculations	Recurring CS #32	April 1, 2007	
80272	Drainage and Inlet Protection Under Traffic	Articles 603.02 and 603.07	April 1, 2011	Jan. 1, 2012
80228	Flagger at Side Roads and Entrances	Articles 701.13 and 701.20	April 1, 2009	
80109	Impact Attenuators	Section 643	Nov. 1, 2003	Jan. 1, 2012
80110	Impact Attenuators, Temporary	Section 706	Nov. 1, 2003	Jan. 1, 2012
80203	Metal Hardware Cast into Concrete	Articles 503.02, 504.02, and 1006.13	April 1, 2008	Jan. 1, 2012
80290	Payrolls and Payroll Records	Recurring CS #5	Jan. 2, 2012	
80299	Portland Cement Concrete Inlay or Overlay	Recurring CS #29	April 1, 2012	
80280	Portland Cement Concrete Sidewalk	Article 424.07	Jan. 1, 2012	
80152	Self-Consolidating Concrete for Cast-In-Place Construction	The following special provisions: Portland Cement Concrete, QC/QA of Concrete Mixtures and Placing and Consolidating Concrete	Nov. 1, 2005	April 1, 2012
80132	Self-Consolidating Concrete for Precast and Precast Prestressed Products	The following special provisions: Portland Cement Concrete, QC/QA of Concrete Mixtures and Placing and Consolidating Concrete	July 1, 2004	April 1, 2012
80284	Shoulder Rumble Strips	Article 642.05	Jan. 1, 2012	
80285	Sidewalk, Corner or Crosswalk Closure	Articles 701.03, 701.15, and 1106.02	Jan. 1, 2012	
80075	Surface Testing of Pavements (Section 406 overlay portion will remain a special provision and will now be called "Surface Testing of HMA Overlays".)	Articles 407.09, 407.12, 420.10, 420.20, and 1101.10	April 1, 2002	Jan. 1, 2007
80287	Type G Inlet Box	Article 610.09	Jan. 1, 2012	

The following special provisions require additional information from the designer. The additional information needs to be included in a separate document attached to this check sheet. The Project Development and Implementation section will then include the information in the applicable special provision. The Special Provisions are:

- Bridge Demolition Debris
- Building Removal-Case I
- Building Removal-Case II
- Building Removal-Case III
- Building Removal-Case IV
- Completion Date
- Completion Date Plus Working Days
- DBE Participation
- Material Transfer Device
- Railroad Protective Liability Insurance
- Training Special Provisions
- Working Days

STATE OF ILLINOIS

SPECIAL PROVISIONS

The following Special Provisions supplement the Illinois Department of Transportation's (IDOT) "Standard Specifications for Road and Bridge Construction," adopted January 1, 2012, (hereinafter referred to as the "Standard Specifications"); the "Manual on Uniform Traffic Control Devices for Streets and Highways" the "Manual of Test Procedures of Materials", in effect on the date of invitation for bids; the "Supplemental Specifications and Recurring Special Provisions," latest edition as indicated on the Check Sheet included herein, and Standard Specifications for Water and Sewer Main Construction in Illinois latest edition which apply to and govern the construction of Indian Trail Bridges over the Fox River, Section 09-00286-00-BR, Project BRM-9003(510), Contract 63863, City of Aurora, Kane County. In case of conflict with any part or parts of the Standard Specifications, these Special Provisions shall take precedence and shall govern.

LOCATION OF PROJECT

Improvements are located on Indian Trail Road from IL Route 31 to IL Route 25 for a Net Length of 1,582.82 feet (0.299 miles) and a Gross Length of 1,582.82 feet (0.299 miles) in the City of Aurora, Kane County, Illinois.

DESCRIPTION OF PROJECT

Work to be performed under this contract consists of widening and deck removal and replacement of the two bridges carrying Indian Trail Road over the Fox River and pavement reconstruction within the project limits. This work will include, but not be limited to, removal of existing concrete deck, concrete structures, concrete superstructure, concrete bridge railing, bridge approach pavement, cofferdams, removal and disposal of unsuitable material, pavement removal, hot-mix asphalt surface removal, pcc pavement, pcc sidewalk, curb and gutter, erosion control, lighting, and all incidental and collateral work necessary to complete the project as shown on the plans and described herein.

MAINTENANCE OF ROADWAYS

Effective: September 30, 1985

Revised: November 1, 1996

Beginning on the date that the Contractor begins work on this project, he shall assume responsibility for normal maintenance of all existing roadways within the limits of the improvement. This normal maintenance shall include all repair work deemed necessary by the Engineer, but shall not include snow removal operations. Traffic control and protection for maintenance of roadways will be provided by the Contractor as required by the Engineer.

If items of work have not been provided for in the contract, or otherwise specified for payment,

such items, including the accompanying traffic control and protection required by the Engineer, will be paid for in accordance with Article 109.04 of the Standard Specifications.

TRAFFIC CONTROL PLAN

Effective: September 30, 1985

Revised: January 1, 2007

Traffic Control shall be according to the applicable sections of the Standard Specifications, the Supplemental Specifications, the "Illinois Manual on Uniform Traffic Control Devices for Streets and Highways", any special details and Highway Standards contained in the plans, and the Special Provisions contained herein.

Special attention is called to Article 107.09 of the Standard Specifications and the following Highway Standards, Details, Quality Standard for Work Zone Traffic Control Devices, Recurring Special Provisions and Special Provisions contained herein, relating to traffic control.

The Contractor shall contact the District One Bureau of Traffic Control Supervisor at (847) 705-4470 at least 72 hours in advance of beginning work.

Standards

701101, 701106, 701427, 701602, 701606, 701801, and 701901

Details

Temporary Detour Plan

Typical Pavement Marking

: Pavement Marking Letters and Symbols for Traffic Staging

Traffic Control and Protection for Side Roads, Intersections and Driveways

Pavement Marking Letters and Symbols for Traffic Staging

Special Provisions

Flagger at Side Roads and Entrances

Maintenance of Roadways

Temporary Information Signing

Traffic Control and Protection (Special)

Public Convenience and Safety (District One)

Traffic Control Deficiency Deductions (BDE)

Work Zone Traffic Control (LRS#3)

Flaggers in Work Zones (LRS#4)

COMPLETION DATE PLUS WORKING DAYS

Effective: September 30, 1985

Revised: January 1, 2007

Revise Article 108.05 (b) of the Standard Specifications as follows:

"When a completion date plus working days is specified, the Contractor shall complete all contract items and safely open all roadways to traffic by 11:59 PM on, August 1, 2015 except as specified herein.

The Contractor will be allowed to complete all clean-up work and punch list items within 10 working days after the completion date for opening the roadway to traffic. Under extenuating circumstances the Engineer may direct that certain items of work, not affecting the safe opening of the roadway to traffic, may be completed within the working days allowed for clean up work and punch list items. Temporary lane closures for this work may be allowed at the discretion of the Engineer.

Article 108.09 or the Special Provision for "Failure to Complete the Work on Time", if included in this contract, shall apply to both the completion date and the number of working days.

AGGREGATE SUBGRADE IMPROVEMENT (D-1)

Effective: February 22, 2012
Revised: January 1, 2013

Add the following Section to the Standard Specifications:

"SECTION 303. AGGREGATE SUBGRADE IMPROVEMENT

303.01 Description. This work shall consist of constructing an aggregate subgrade improvement.

303.02 Materials. Materials shall be according to the following.

Item	Article/Section
(a) Coarse Aggregate	1004.06
(b) Reclaimed Asphalt Pavement (RAP) (Notes 1, 2)	1031

Note 1. Crushed RAP, from either full depth or single lift removal, may be mechanically blended with aggregate gradations CS 01 or CS 02 but shall not exceed 40 percent of the total product. The top size of the Coarse RAP shall be less than 4 in. (100 mm) and well graded.

Note 2. RAP having 100 percent passing the 1 1/2 in. (37.5 mm) sieve and being well graded, may be used as capping aggregate in the top 3 in. (75 mm) when aggregate gradations CS 01 or CS 02 are used in lower lifts. When RAP is blended with any of the coarse aggregates, the blending shall be done with mechanically calibrated feeders.

303.03 Equipment. The vibratory machine shall be according to Article 1101.01, or as approved by the Engineer.

303.04 Soil Preparation. The stability of the soil shall be according to the Department's Subgrade Stability Manual for the aggregate thickness specified.

303.05 Placing Aggregate. The maximum nominal lift thickness of aggregate gradations CS 01 or CS 02 shall be 24 in. (600 mm).

303.06 Capping Aggregate. The top surface of the aggregate subgrade shall consist of a minimum 3 in. (75 mm) of aggregate gradations CA 06 or CA 10. When Reclaimed Asphalt Pavement (RAP) is used, it shall be crushed and screened where 100 percent is passing the 1 1/2 in. (37.5 mm) sieve and being well graded. RAP that has been fractionated to size will not be permitted for use in capping. Capping aggregate will not be required when the aggregate subgrade improvement is used as a cubic yard pay item for undercut applications. When RAP is blended with any of the coarse aggregates, the blending shall be done with mechanically calibrated feeders.

303.07 Compaction. All aggregate lifts shall be compacted to the satisfaction of the Engineer. If the moisture content of the material is such that compaction cannot be obtained, sufficient water shall be added so that satisfactory compaction can be obtained.

303.08 Finishing and Maintenance of Aggregate Subgrade Improvement. The aggregate subgrade improvement shall be finished to the lines, grades, and cross sections shown on the plans, or as directed by the Engineer. The aggregate subgrade improvement shall be maintained in a smooth and compacted condition.

303.09 Method of Measurement. This work will be measured for payment according to Article 311.08.

303.10 Basis of Payment. This work will be paid for at the contract unit price per cubic yard (cubic meter) for AGGREGATE SUBGRADE IMPROVEMENT or at the contract unit price per square yard (square meter) for AGGREGATE SUBGRADE IMPROVEMENT, of the thickness specified.

Add the following to Section 1004 of the Standard Specifications:

"1004.06 Coarse Aggregate for Aggregate Subgrade Improvement. The aggregate shall be according to Article 1004.01 and the following.

- (a) Description. The coarse aggregate shall be crushed gravel, crushed stone, or crushed concrete.
- (b) Quality. The coarse aggregate shall consist of sound durable particles reasonably free of deleterious materials.
- (c) Gradation.
 - (1) The coarse aggregate gradation for total subgrade thickness less than or equal to 12 in. (300 mm) shall be CS 01.

The coarse aggregate gradation for total subgrade thickness more than 12 in. (300 mm) shall be CS 01 or CS 02.

Grad No.	COARSE AGGREGATE SUBGRADE GRADATIONS				
	Sieve Size and Percent Passing				
	8"	6"	4"	2"	#4
CS 01	100	97 ± 3	90 ± 10	45 ± 25	20 ± 20
CS 02		100	80 ± 10	25 ± 15	

Grad No.	COARSE AGGREGATE SUBGRADE GRADATIONS (Metric)				
	Sieve Size and Percent Passing				
	200 mm	150 mm	100 mm	50 mm	4.75 mm
CS 01	100	97 ± 3	90 ± 10	45 ± 25	20 ± 20
CS 02		100	80 ± 10	25 ± 15	

(2) The 3 in. (75 mm) capping aggregate shall be gradation CA 6 or CA 10."

TRAFFIC CONTROL AND PROTECTION, (SPECIAL)

Indian Trail may be closed to thru traffic within the project limits as indicated in the plans and as described herein. The roadway may be closed starting March 3, 2014 and must be safely re-opened to traffic on September 29, 2014. Local access to the properties along Indian Trail streets must be maintained at all times. The roadway may also be closed starting March 2, 2015 and must be safely re-opened to traffic in accordance with the special provision for Completion Date Plus Working Days.

The following is a suggested construction sequence:

- Install erosion sediment control as indicated in the plans.
- Install cofferdams at west bridge and perform substructure widening prior to March 3, 2014 road closure. Remove Cofferdams prior to April 1, 2014 fish spawning season (See IDNR permit).
- Install Temporary Detour starting March 3, 2013.
- Superstructure work at west bridge (SN 045-3088) and roadway improvements west of SN 045-3088.
- Install temporary items on the roadway on the island as shown in the Construction Detail Suggested Maintenance of Roadway Detail.
- Open roadway to through traffic on or prior to September 29, 2014.
- Install cofferdams at east bridge and perform substructure widening prior to March 2, 2015 road closure. Remove cofferdams prior to April 1, 2015 fish spawning season (See IDNR permit).
- Install Temporary Detour starting March 2, 2015.
- Superstructure work at east bridge (SN 045-3089) and roadway improvements east of SN 045-3089 and on the island.
- Open roadway to through traffic in accordance with the special provision for Completion Date Plus Working Days.

Detour information signing shall be installed as shown in the plans one (1) week prior to each of the closings of Indian Trail. The Contractor shall notify the City of Aurora and the Illinois Department of Transportation 2 weeks in advance of each closing of the road. The Contractor will be required to cover and maintain the signs to the satisfaction of the Engineer. The Contractor should take particular note of the applicable portions of Article 107.14 of the Standard Specifications. All signs, except those referring to daily lane closures, shall be post mounted in accordance with Standard 720001 for all projects that exceed a four-day duration.

The Contractor shall furnish, erect, maintain and remove all signs, barricades, flaggers and other traffic control devices as may be necessary for the purpose of regulating, warning or guiding traffic. Placement and maintenance of all traffic control devices shall be in accordance with the applicable parts of Section 701 of the Standard Specifications, the Illinois Manual on Uniform Traffic Control Devices for Streets and Highways and the Highway Standards contained herein.

The Fox River Trail Bike Path under the west bridge (SN 045-3088) may be closed in the limits of the improvements for a maximum of two separate closures with a maximum of two consecutive calendar days allowed for each closure. Advance warning signs providing the closure date(s) must be placed one (1) week in advance of the closure. The closure signs must be placed 500' from the bridge in each direction, at the limits of the Right of Way or Temporary Construction Easement and as shown on the plans.

A branch of the Fox River must be available for waterborne traffic for the complete duration of the project.

Overhead protection must be provided at the Fox River Trail under the west bridge (SN 045-3088) as indicated on the plans while work is being performed on or adjacent to the west bridge and at the direction of the Engineer. The method of overhead protection shall generally conform to Article 501.03 and must be reviewed and approved by the Engineer. The shield shall provide a clear vertical height of 8'-6" over the Fox River Trail. The cost for the overhead protection will be included in the cost of the item PROTECTIVE SHIELD.

This item of work will be measured on a lump sum basis for furnishing, installing, maintaining, replacing, relocating and removing the traffic control devices required in the plans and these Special Provisions. All labor, materials, transportation, handling and incidentals necessary to furnish, install, maintain, replace, relocate and remove all traffic control devices for the temporary detour shall be included in this item.

Basis of Payment: This work will be included in the pay item TRAFFIC CONTROL AND PROTECTION, (SPECIAL), which price shall be payment in full for all labor, materials, transportation, handling and incidentals necessary to furnish, install, maintain, replace, relocate and remove all traffic control devices indicated in the plans and specifications. The salvage value of the materials removed shall be reflected in the bid price for this item.

STATUS OF UTILITIES TO BE ADJUSTED

Effective: January 30, 1987

Revised: January 24, 2013

Utilities companies involved in this project have provided the following estimated durations:

Name of Utility	Type	Location	Estimated Duration of Time for the Completion of Relocation or Adjustments
ComEd Attn: Joe Stacho (630) 424-5704	Aerial Electric	Approximately 350' south of Centerline of Indian Trail	No Adjustments Required
ComEd Attn: Joe Stacho (630) 424-5704	Underground Electric-4 duct	North sidewalk/parkway and emedded in north sidewalk of bridges	To be relocated to temporary location prior to February 15, 2014. Permanent relocation during construction – will be hung under new bridge decks in new conduits;5-6 Mo. duration
AT&T 1000 Commerce Dr. Oakbrook, IL. 60523 Hector Garcia (630) 573-5465 Mitchell Cullen (630) 573-6447	Underground Phone and Fiber Optic-6 duct	South parkway/sidewalk and embedded within south sidewalks of bridges	To be relocated to temporary location prior to December 15, 2013. Permanent relocation during construction – will be hung under new bridge decks in new conduits; 2 Mo. duration
Fox Metro Water Reclamation District 682 State Route 31 Oswego, Illinois 60543 Attn: Thomas F. Muth 630-892-4378	Underground 24" diameter sanitary sewer	Crosses Indian Trail near Station 103+55	No Adjustments Required
City of Aurora 44 East Downer Place Aurora, IL 60507 Chris Lirot (630) 256-3242 Lonnie Avery (630) 256-3231	Underground 14" Diameter Sanitary Sewer	Crosses under West Bridge near Station 95+00	No Adjustments Required. Proposed storm sewer crossing includes steel casing protecting the storm sewer.
City of Aurora 44 East Downer Place Aurora, IL 60507 Chris Lirot (630) 256-3242	Underground electrical for existing street lighting	North and South sidewalks and parkways, also embedded in existing bridge	To be abandoned off the bridges and removed with the bridge decks.

Lonnie Avery (630) 256-3231		sidewalks, throughout limits.	

The above represents the best information available to the Department and is included for the convenience of the bidder. The applicable portions of Articles 105.07 and 107.31 of the Standard Specifications shall apply.

In accordance with 605 ILCS 5/9-113 of the Illinois Compiled Statutes, utility companies have 90 days to complete the relocation of their facilities after receipt of written notice from the Department. The 90-day written notice will be sent to the utility companies after the following occurs:

- 1) Proposed right of way is clear for contract award.
- 2) Final plans have been sent to and received by the utility company.
- 3) Utility permit is received by the Department and the Department is ready to issue said permit.
- 4) If a permit has not been submitted, a 15 day letter is sent to the utility company notifying them they have 15 days to provide their permit application. After allowing 15 days for submission of the permit the 90 day notice is sent to the utility company.

Any time within the 90 day relocation period the utility company may request a waiver for additional time to complete their relocation. The Department has 10 days to review and respond to a waiver request.

TEMPORARY INFORMATION SIGNING

Effective: November 13, 1996

Revised: January 2, 2007

Description.

This work shall consist of furnishing, installing, maintaining, relocating for various states of construction and eventually removing temporary informational signs. Included in this item may be ground mount signs, skid mount signs, truss mount signs, bridge mount signs, and overlay sign panels which cover portions of existing signs.

Materials.

Materials shall be according to the following Articles of Section 1000 - Materials:

	<u>Item</u>	<u>Article/Section</u>
a.)	Sign Base (Notes 1 & 2)	1090
b.)	Sign Face (Note 3)	1091
c.)	Sign Legends	1092
d.)	Sign Supports	1093
e.)	Overlay Panels (Note 4)	1090.02

Note 1. The Contractor may use 5/8 inch (16 mm) instead of 3/4 inch (19 mm) thick

- plywood.
- Note 2. Type A sheeting can be used on the plywood base.
- Note 3. All sign faces shall be Type A except all orange signs shall meet the requirements of Article 1106.01.
- Note 4. The overlay panels shall be 0.08 inch (2 mm) thick.

GENERAL CONSTRUCTION REQUIREMENTS

Installation.

The sign sizes and legend sizes shall be verified by the Contractor prior to fabrication.

Signs which are placed along the roadway and/or within the construction zone shall be installed according to the requirements of Article 701.14 and Article 720.04. The signs shall be 7 ft (2.1 m) above the near edge of the pavement and shall be a minimum of 2 ft (600 mm) beyond the edge of the paved shoulder. A minimum of two (2) posts shall be used.

The attachment of temporary signs to existing sign structures or sign panels shall be approved by the Engineer. Any damage to the existing signs due to the Contractor's operations shall be repaired or signs replaced, as determined by the Engineer, at the Contractor's expense.

Signs which are placed on overhead bridge structures shall be fastened to the handrail with stainless steel bands. These signs shall rest on the concrete parapet where possible. The Contractor shall furnish mounting details for approval by the Engineer.

Method Of Measurement.

This work shall be measured for payment in square feet (square meters) edge to edge (horizontally and vertically).

All hardware, posts or skids, supports, bases for ground mounted signs, connections, which are required for mounting these signs will be included as part of this pay item.

Basis Of Payment.

This work shall be paid for at the contract unit price per square foot (square meter) for TEMPORARY INFORMATION SIGNING.

COARSE AGGREGATE FOR BACKFILL, TRENCH BACKFILL AND BEDDING (D-1)

Effective: November 1, 2011

This work shall be according to Section 1004.05 of the Standard Specifications except for the following:

Reclaimed Asphalt Pavement (RAP) maybe blended with gravel, crushed gravel, crushed stone crushed concrete, crushed slag, chats, crushed sand stone or wet bottom boiler slag. The RAP materials shall be crushed and screened. Unprocessed RAP grindings will not be permitted. The RAP shall be uniformly graded and shall pass the 1.0 in. (25 mm) screen. When RAP is blended with any of the coarse aggregate listed above, the blending shall be done mechanically with calibrated feeders. The feeders

shall have an accuracy of ± 2.0 percent of the actual quantity of material delivered. The final blended product shall not contain more than 40 percent by weight RAP.

The coarse aggregate listed above shall meet CA 6 and CA 10 gradations prior to being blended with the processed and uniformly graded RAP.

HMA MIXTURE DESIGN REQUIREMENTS (D-1)

Effective: January 1, 2013.
 Revised: January 16, 2013

1) Design Composition and Volumetric Requirements

Revise Article 1030.04(a)(1) of the Standard Specifications to read.

“(1) High ESAL Mixtures. The Job Mix Formula (JMF) shall fall within the following limits.

High ESAL, MIXTURE COMPOSITION (% PASSING) ^{1/}										
Sieve Size	IL-25.0 mm		IL-19.0 mm		IL-12.5 mm		IL-9.5 mm		IL-4.75 mm	
	min	max	min	max	min	max	min	max	min	max
1 1/2 in (37.5 mm)		100								
1 in. (25 mm)	90	100		100						
3/4 in. (19 mm)		90	82	100		100				
1/2 in. (12.5 mm)	45	75	50	85	90	100		100		100
3/8 in. (9.5 mm)						89	90	100		100
#4 (4.75 mm)	24	42 ^{2/}	24	50 ^{2/}	28	65	28	65	90	100
#8 (2.36 mm)	16	31	20	36	28	48 ^{3/}	32	52 ^{3/}	70	90
#16 (1.18 mm)	10	22	10	25	10	32	10	32	50	65
#50 (300 μ m)	4	12	4	12	4	15	4	15	15	30
#100 (150 μ m)	3	9	3	9	3	10	3	10	10	18
#200 (75 μ m)	3	6	3	6	4	6	4	6	7	9
Ratio Dust/Asphalt Binder		1.0		1.0		1.0		1.0		1.0 ^{4/}

- 1/ Based on percent of total aggregate weight.
- 2/ The mixture composition shall not exceed 40 percent passing the #4 (4.75 mm) sieve for binder courses with Ndesign ≥ 90.
- 3/ The mixture composition shall not exceed 44 percent passing the #8 (2.36 mm) sieve for surface courses with Ndesign ≥ 90.
- 4/ Additional minus No. 200 (0.075 mm) material required by the mix design shall be mineral filler, unless otherwise approved by the Engineer."

Delete Article 1030.04(a)(4) of the Standard Specifications.

Revise Article 1030.04(b)(1) of the Standard Specifications to read.

"(1) High ESAL Mixtures. The target value for the air voids of the HMA shall be 4.0 percent and for IL-4.75 it shall be 3.5 percent at the design number of gyrations. The VMA and VFA of the HMA design shall be based on the nominal maximum size of the aggregate in the mix, and shall conform to the following requirements.

VOLUMETRIC REQUIREMENTS High ESAL						
Ndesign	Voids in the Mineral Aggregate (VMA), % minimum					Voids Filled with Asphalt Binder (VFA), %
	IL-25.0	IL-19.0	IL-12.5	IL-9.5	IL-4.75 ^{1/}	
50	12.0	13.0	14.0	15	18.5	65 – 78 ^{2/}
70					65 - 75	
90						
105						

1/ Maximum Draindown for IL-4.75 shall be 0.3%

2/ VFA for IL-4.75 shall be 72-85%"

Delete Article 1030.04(b)(4) of the Standard Specifications.

Revise the Control Limits Table in Article 1030.05(d)(4) of the Standard Specifications to read.

"CONTROL LIMITS					
Parameter	High ESAL	High ESAL	All Other	IL-4.75	IL-4.75
	Low ESAL	Low ESAL			
	Individual Test	Moving Avg. of 4	Individual Test	Individual Test	Moving Avg. of 4

% Passing: ^{1/}					
1/2 in. (12.5 mm)	± 6 %	± 4 %	± 15 %		
No. 4 (4.75 mm)	± 5 %	± 4 %	± 10 %		
No. 8 (2.36 mm)	± 5 %	± 3 %			
No. 16 (1.18 mm)				± 4 %	± 3 %
No. 30 (600 µm)	± 4 %	± 2.5 %			
Total Dust Content No. 200 (75 µm)	± 1.5 %	± 1.0 %	± 2.5 %	± 1.5 %	± 1.0 %
Asphalt Binder Content	± 0.3 %	± 0.2 %	± 0.5 %	± 0.3 %	± 0.2 %
Voids	± 1.2 %	± 1.0 %	± 1.2 %	± 1.2 %	± 1.0 %
VMA	-0.7 % ^{2/}	-0.5 % ^{2/}		-0.7 % ^{2/}	-0.5 % ^{2/}

1/ Based on washed ignition oven

2/ Allowable limit below minimum design VMA requirement"

2) Design Verification and Production

Description. The following states the requirements for Hamburg Wheel and Tensile Strength testing for High ESAL, IL-4.75, and SMA hot mix asphalt (HMA) mixes during mix design verification and production.

When the options of Warm Mix Asphalt, Reclaimed Asphalt Shingles, or Reclaimed Asphalt Pavement are used by the Contractor, the Hamburg Wheel and tensile strength requirements in this special provision will be superseded by the special provisions for Warm Mix Asphalt, Reclaimed Asphalt Shingles, or Reclaimed Asphalt Pavement as applicable.

Mix Design Testing. Add the following to Article 1030.04 of the Standard Specifications:

" (d) Verification Testing. High ESAL, IL-4.75, and SMA mix designs submitted for verification will be tested to ensure that the resulting mix designs will pass the required criteria for the Hamburg Wheel Test (IL mod AASHTO T-324) and the Tensile Strength Test (IL mod AASHTO T-283). The Department will perform a verification test on gyratory specimens compacted by the Contractor. If the mix fails the Department's verification test, the Contractor shall make the necessary changes to the mix and resubmit compacted specimens to the Department for verification. If the mix fails again, the mix design will be rejected.

All new and renewal mix designs will be required to be tested, prior to submittal for Department verification meeting the following requirements:

(1)Hamburg Wheel Test criteria.

Asphalt Binder Grade	# Repetitions	Max Rut Depth (mm)
PG 70 -XX (or higher)	20,000	12.5
PG 64 -XX (or lower)	10,000	12.5

Note: For SMA Designs (N-80) the maximum rut depth is 6.0 mm at 20,000 repetitions.
For IL 4.75mm Designs (N-50) the maximum rut depth is 9.0mm at 15,000 repetitions.

(2) Tensile Strength Criteria. The minimum allowable conditioned tensile strength shall be 415 kPa (60 psi) for non-polymer modified performance graded (PG) asphalt binder and 550 kPa (80 psi) for polymer modified PG asphalt binder. The maximum allowable unconditioned tensile strength shall be 1380 kPa (200 psi)."

Production Testing. Add the following to Article 1030.06 of the Standard Specifications:

" (c) Hamburg Wheel Test. All HMA mixtures shall be sampled within the first 500 tons (450 metric tons) on the first day of production or during start up with a split reserved for the Department. The mix sample shall be tested according to the Illinois Modified AASHTO T 324 and shall meet the requirements specified herein. Mix production shall not exceed 1500 tons (1350 metric tons) or one day's production, whichever comes first, until the testing is completed and the mixture is found to be in conformance. The requirement to cease mix production may be waived if the plant produced mixture demonstrates conformance prior to start of mix production for a contract.

The Department may conduct additional Hamburg Wheel Tests on production material as determined by the Engineer. If the mixture fails to meet the Hamburg Wheel criteria, no further mixture will be accepted until the Contractor takes such action as is necessary to furnish a mixture meeting the criteria"

Basis of Payment. Revise the seventh paragraph of Article 406.14 of the Standard Specifications to read:

"For all mixes designed and verified under the Hamburg Wheel criteria, the cost of furnishing and introducing anti-stripping additives in the HMA will not be paid for separately, but shall be considered as included in the contract unit price of the HMA item involved.

No additional compensation will be awarded to the Contractor because of reduced production rates associated with the addition of the anti-stripping additive."

FRICITION SURFACE AGGREGATE (D1)

Effective: January 1, 2011
Revised: February 26, 2013

Revise Article 1004.01(a)(4) of the Standard Specifications to read:

"(4) Crushed Stone. Crushed stone shall be the angular fragments resulting from crushing undisturbed, consolidated deposits of rock by mechanical means. Crushed stone shall be divided into the following, when specified.

- a. Carbonate Crushed Stone. Carbonate crushed stone shall be either dolomite or limestone. Dolomite shall contain 11.0 percent or more magnesium oxide (MgO). Limestone shall contain less than 11.0 percent magnesium oxide (MgO).
- b. Crystalline Crushed Stone. Crystalline crushed stone shall be either metamorphic or igneous stone, including but is not limited to, quartzite, granite, rhyolite and diabase."

Revise Article 1004.03(a) of the Standard Specifications to read:

"1004.03 **Coarse Aggregate for Hot-Mix Asphalt (HMA).** The aggregate shall be according to Article 1004.01 and the following revisions.

(a) Description. The coarse aggregate for HMA shall be according to the following table.

Use	Mixture	Aggregates Allowed
Class A	Seal or Cover	<u>Allowed Alone or in Combination:</u> Gravel Crushed Gravel Carbonate Crushed Stone Crystalline Crushed Stone Crushed Sandstone Crushed Slag (ACBF) Crushed Steel Slag Crushed Concrete
HMA All Other	Shoulders	<u>Allowed Alone or in Combination:</u> Gravel Crushed Gravel Carbonate Crushed Stone Crystalline Crushed Stone Crushed Sandstone Crushed Slag (ACBF) ^{1/} Crushed Steel Slag ^{1/} Crushed Concrete
HMA High ESAL Low ESAL	C Surface IL-12.5, IL-9.5, or IL-9.5L	<u>Allowed Alone or in Combination:</u> Crushed Gravel Carbonate Crushed Stone Crystalline Crushed Stone Crushed Sandstone Crushed Slag (ACBF) ^{1/} Crushed Steel Slag ^{1/} Crushed Concrete

Use	Mixture	Aggregates Allowed	
HMA High ESAL	D Surface IL-12.5 or IL-9.5	<u>Allowed Alone or in Combination:</u> Crushed Gravel Carbonate Crushed Stone (other than Limestone) Crystalline Crushed Stone Crushed Sandstone Crushed Slag (ACBF) ^{1/} Crushed Steel Slag ^{1/} Crushed Concrete	
		<u>Other Combinations Allowed:</u>	
		<i>Up to...</i>	<i>With...</i>
		25% Limestone	Dolomite
		50% Limestone	Any Mixture D aggregate other than Dolomite
75% Limestone	Crushed Slag (ACBF) ^{1/} or Crushed Sandstone		
HMA High ESAL	F Surface IL-12.5 or IL-9.5	<u>Allowed Alone or in Combination:</u> Crystalline Crushed Stone Crushed Sandstone Crushed Slag (ACBF) ^{1/} Crushed Steel Slag ^{1/} No Limestone or no Crushed Gravel alone.	
		<u>Other Combinations Allowed:</u>	
		<i>Up to...</i>	<i>With...</i>

Use	Mixture	Aggregates Allowed	
		50% Crushed Gravel, or Dolomite	Crushed Sandstone, Crushed Slag (ACBF) ^{1/} , Crushed Steel Slag ^{1/} , or Crystalline Crushed Stone
HMA High ESAL	SMA Ndesign 80 Surface	Crystalline Crushed Stone Crushed Sandstone Crushed Steel Slag	

1/ When either slag is used, the blend percentages listed shall be by volume.

Add to Article 1004.03 (b) of the Standard Specifications to read:

“When using Crushed Concrete, the quality shall be determined as follows. The Contractor shall obtain a representative sample from the stockpile, witnessed by the Engineer, at a frequency of 2500 tons (2300 metric tons). The sample shall be a minimum of 50 lb (25 kg). The Contractor shall submit the sample to the District Office. The District will forward the sample to the BMPR Aggregate Lab for MicroDeval Testing, according to Illinois Modified AASHTO T 327. A maximum loss of 15.0 percent by weight will be applied for acceptance. The stockpile shall be sealed until test results are complete and found to meet the specifications above.”

GROUND TIRE RUBBER (GTR) MODIFIED ASPHALT BINDER (D-1)

Effective: June 26, 2006
 Revised: January 1, 2013

Add the following to the end of article 1032.05 of the Standard Specifications:

“(c) Ground Tire Rubber (GTR) Modified Asphalt Binder. A quantity of 10.0 to 14.0 percent GTR (Note 1) shall be blended by dry unit weight with a PG 64-28 to make a GTR 70-28 or a PG 58-28 to make a GTR 64-28. The base PG 64-28 and PG 58-28 asphalt binders shall meet the requirements of Article 1032.05(a). Compatible polymers may be added during production. The GTR modified asphalt binder shall meet the requirements of the following table.

Test	Asphalt Grade GTR 70-28	Asphalt Grade GTR 64-28
Flash Point (C.O.C.), AASHTO T 48, °F (°C), min.	450 (232)	450 (232)
Rotational Viscosity, AASHTO T 316 @ 275 °F (135 °C), Poises, Pa·s, max.	30 (3)	30 (3)
Softening Point, AASHTO T 53, °F (°C), min.	135 (57)	130 (54)
Elastic Recovery, ASTM D 6084, Procedure A (sieve waived) @ 77 °F, (25 °C), aged, ss, 100 mm elongation, 5 cm/min., cut immediately, %, min.	65	65

Note 1. GTR shall be produced from processing automobile and/or light truck tires by the ambient grinding method. GTR shall not exceed 1/16 in. (2 mm) in any dimension and shall contain no free metal particles or other materials. A mineral powder (such as talc) meeting the requirements of AASHTO M 17 may be added, up to a maximum of four percent by weight of GTR to reduce sticking and caking of the GTR particles. When tested in accordance with Illinois modified AASHTO T 27, a 50 g sample of the GTR shall conform to the following gradation requirements:

Sieve Size	Percent Passing
No. 16 (1.18 mm)	100
No. 30 (600 µm)	95 ± 5
No. 50 (300 µm)	> 20

Add the following to the end of Note 1. of article 1030.03 of the Standard Specifications:

“A dedicated storage tank for the Ground Tire Rubber (GTR) modified asphalt binder shall be provided. This tank must be capable of providing continuous mechanical mixing throughout by continuous agitation and recirculation of the asphalt binder to provide a uniform mixture. The tank shall be heated and capable of maintaining the temperature of the asphalt binder at 300 °F to 350 °F (149 °C to 177 °C). The asphalt binder metering systems of dryer drum plants shall be calibrated with the actual GTR modified asphalt binder material with an accuracy of ± 0.40 percent.”

Revise 1030.02(c) of the Standard Specifications to read:

“(c) RAP Materials (Note 3)1031”

Add the following note to 1030.02 of the Standard Specifications:

Note 3. When using reclaimed asphalt pavement and/or reclaimed asphalt shingles, the maximum asphalt binder replacement percentage shall be according to the most recent special provision for recycled materials.

EMBANKMENT I

Effective: March 1, 2011

Description. This work shall be according to Section 205 of the Standard Specifications except for the following.

Material. All material shall be approved by the District Geotechnical Engineer. The proposed material must meet the following requirements.

- a) The laboratory Standard Dry Density shall be a minimum of 90 lb/cu ft (1450 kg/cu m) when determined according to AASHTO.T 99 (Method C).
- b) The organic content shall be less than ten percent determined according to AASHTO T 194 (Wet Combustion).
- c) Soils which demonstrate the following properties shall be restricted to the interior of the embankment and shall be covered on both the sides and top of the embankment by a minimum of 3 ft (900 mm) of soil not considered detrimental in terms of erosion potential or excess volume change.
 - 1) A grain size distribution with less than 35 percent passing the number 75 um (#200) sieve.
 - 2) A plasticity index (PI) of less than 12.
 - 3) A liquid limit (LL) in excess of 50.
- d) Reclaimed asphalt shall not be used within the ground water table or as a fill if ground water is present.

CONSTRUCTION REQUIREMENTS

Samples. Embankment material shall be sampled, tested, and approved before use. The contractor shall identify embankment sources, and provide equipment as the Engineer requires, for the collection of samples from those sources. Samples will be furnished to the Geotechnical Engineer a minimum of three weeks prior to use in order that laboratory tests for approval and compaction can be performed. Embankment material placement cannot begin until tests are completed and approval given.

Placing Material. In addition to Article 202.03, broken concrete, reclaimed asphalt with no expansive aggregate, or uncontaminated dirt and sand generated from construction or demolition activities shall be placed in 6 inches (150 mm) lifts and disked with the underlying lift until a uniform homogenous material is formed. This process also applies to the overlaying lifts. The disk must have a minimum blade diameter of 24 inches (600 mm).

When embankments are to be constructed on hillsides or existing slopes that are steeper than 3H:1V, steps shall be keyed into the existing slope by stepping and benching as shown in the plans or as directed by the engineer.

Compaction. Soils classification for moisture content control will be determined by the Soils Inspector using visual field examination techniques and the IDH Textural Classification Chart.

When tested for density in place each lift shall have a maximum moisture content as follows.

- a) A maximum of 110 percent of the optimum moisture for all forms of clay soils.
- b) A maximum of 105 percent of the optimum moisture for all forms of clay loam soils.

Stability. The requirement for embankment stability in Article 205.04 will be measured with a Dynamic Cone Penetrometer (DCP) according to the test method in the IDOT Geotechnical Manual. The penetration rate must be equal or less than 1.5 inches (38 mm) per blow.

Basis of Payment. This work will not be paid separately but will be considered as included in the various items of excavation.

PORTLAND CEMENT CONCRETE SIDEWALK 6 INCH, SPECIAL

Description: Portland Cement Concrete Sidewalk 6 Inch, Special shall be installed at the locations indicated in the contract documents and in accordance with Section 424 of the Standard Specifications and the details in the plans.

Portland Cement Concrete Sidewalk 6 Inch, Special shall be reinforced with #5 epoxy coated reinforcement bars at 12" centers in both directions with clear cover of 3 inches. The reinforcement shall not be paid for separately, but shall be included in the cost of Portland Cement Concrete Sidewalk 6 Inch, Special.

Method of Measurement: This item shall be measured in place and measured per square foot.

Basis of Payment: This work will be paid for at the contract unit price per square foot for PORTLAND CEMENT CONCRETE SIDEWALK 6 INCH, SPECIAL, which price shall include all materials, reinforcement bars, labor, and equipment necessary to perform the work as shown in the plans.

CONCRETE FINISHES

Description: This specification describes the individual requirements for concrete finishes on the following items:

- a) CONCRETE BRIDGE RAILING (SPECIAL) – Precast Pilasters, and Caps (precast normal weight concrete)
- b) CONCRETE BRIDGE RAILING (SPECIAL) – Cast-In-Place Concrete parapet (CIP normal weight concrete)
- c) CONCRETE SUPERSTRUCTURE – Cast in place concrete at fascia of deck as indicated on the plans. (CIP normal weight concrete)

Submittals: The Contractor shall submit each coating manufacturer's Product Data Sheets (PDS), Material Safety Data Sheets (MSDS) and warranty information to the Engineer for approval.

Surface Preparation: All concrete surfaces shall be prepared in accordance with the coating manufacturer's recommendations, as applicable. At a minimum, all surfaces shall be brush-blasted and followed by a clean water rinse to clean and open the surfaces.

Materials:

- a) Stain – All exposed surfaces of the CONCRETE BRIDGE RAILING and outside fascia of deck as shown in the plans.
Both parts of the CONCRETE BRIDGE RAILING and deck fascia as shown in the plans shall be stained with a modified, water-based acrylic, penetrating pigmented sealer. It shall be applied in two separate coats to a minimum dry film thickness of 4 mils, dry to a satin finish and provide a significant degree of water repellency. In addition, it must provide a minimum of a five year warranty against loss of water repellency, flaking or peeling and fading and future recoating will only require a thorough pressure-wash cleaning prior to application of future coats.

Colors: The finish color samples that are required as a part of FURNISHING MOCK-UPS shall be matched to the following paint color palette:

- Federal Color 36424
- Federal Color 36642
- Federal Color 37150
- Federal Color 37769
- Federal Color 37780

Note that if the precast pilasters and caps of the CONCRETE BRIDGE RAILING (Special) will be manufactured directly by the Contractor from the same ready-mix concrete that will be used for the cast-in-place portions of the railing, only one set of finish color samples will be required. Otherwise, one set of finish color samples will be required for both the pilasters/caps and parapets.

Method of Measurement: Concrete Finishes will not be measured for payment.

Basis for Payment: This work will not be paid for separately, but shall be included in the cost of the respective items that require a concrete finish as defined in this specification and as shown on the plans.

FURNISHING MOCK-UPS

Description: This work shall consist of furnishing all labor, equipment and materials necessary to produce/acquire and deliver mock-up items as described in this specification and as shown in the contract plans.

General: Mock-up items will be required to represent the following contract items:

- (a) PARAPET RAILING, SPECIAL
- (b) CONCRETE BRIDGE RAILING (color samples only – see below)

The Contractor shall deliver one (1) 4 foot long section of the aluminum Parapet Railing, Special with a vertical post on each end to the City of Aurora. See Special Provision for Parapet Railing, Special.

Submittals: Mock-up items shall require submittals to the Engineer that are identical to those of the respective contract items. Five (5) finish color samples of the precast railing portions and of the cast-in-place railing portions shall be provided (One of each color choice indicated in special provision for CONCRETE FINISHES). Four (4) of the cast-in-place samples will include the form liner textured surfaces as indicated in the special provision for Concrete Bridge Railing (One of each of the four textures indicated). The other two samples will have normal finish. A stain color and form liner textured surface will be selected from these samples for the stain to be applied and form liner textured surfaces, respectively, as shown in the plans and as indicated in these special provisions. The size of each sample shall be approximately 12" x 12" x 2" thick. See CONCRETE FINISHES and CONCRETE BRIDGE RAILING for finishing requirements. The approved combination of finish color and textured surface samples shall be used as the basis for the final components of Concrete Bridge Railing, and portions of the Concrete Superstructure to receive stain. The 4 foot long section of aluminum Parapet Railing, Special and concrete color samples described above shall be delivered to the City of Aurora at City Hall, 44 East Downer Place, Aurora, Illinois 60507 for approval no later than 90 days prior to installation of the precast concrete railing elements.

Materials: The materials and finishes used in all mock-ups shall be as specified in their respective contract specification and on the contract plans. The final installed contract items requiring a mock-up must be produced or manufactured using materials that are identical to those used in creating the approved color samples and mock-ups. No substitutions shall be allowed.

Approvals: The Engineer, upon direction from the City of Aurora, shall have the sole authority to approve the color samples and mock-up as a basis to begin fabrication, manufacture, production or acquisition of contract items requiring mock-ups.

Method of Measurement: Mock-Ups will not be measured for payment.

Basis of Payment: This work will not be paid for separately, but shall be included with the unit price bid for CONCRETE BRIDGE RAILING and PARAPET RAILING, SPECIAL.

FURNISHING AND ERECTING PRECAST CONCRETE PILASTERS AND MEDALLIONS

Description: This work shall consist of furnishing the materials, constructing the individual precast concrete elements to the dimensions shown in the contract plans, erection, any necessary materials and equipment required to temporarily support the precast elements, all inserts and connectors required to permanently join the precast elements to the supporting cast-in-place concrete elements and any field modification of the precast elements that may be required.

General: The precast concrete elements shall consist of class PC concrete, epoxy-coated steel reinforcement bars or epoxy coated welded wire fabric, inserts and connectors of the capacity and finish specified on the plans including formliner surfaces and surface treatments/textures where specified.

Submittals: The precast concrete supplier shall submit the following to the Engineer for approval no later than 90 days prior to installation of the precast concrete elements:

- a) Concrete mix design for the precast concrete pilasters. See "Materials" Section of this special provision.
- b) Shop drawings in accordance with Article 1042.03(b) of the Standard Specifications. Shop drawings must include reinforcement bending and placement details; precast lifting points and piece weights; and insert/connector manufacturers with types, finishes and capacities for each respective precast concrete element.
- c) All details of architectural treatment for the exposed surfaces of the precast concrete elements shall be shown as well as the manufacturer and pattern number of the all required formliners. See Special Provision for Concrete Bridge Railing for form liner textured surface.
- d) A finish color sample as specified in FURNISHING MOCK-UPS.

The initial submittal shall include three sets of shop drawings. One set of drawings will be returned to the Contractor with any corrections indicated. After approval, the Contractor shall furnish the Engineer with eight sets of corrected prints and one mylar set for distribution by the Department. No work or ordering of materials for the structure shall be done until all submittals have been approved by the Engineer.

Materials: The precast concrete elements shall conform to the following:

- a) Steel insert or connection hardware shall be galvanized according to AASHTO M 232 or

AASHTO M 111 as applicable.

- b) All precast modules shall be manufactured with Class PC concrete according to Section 504, Article 1042.02 and Article 1042.03.
- c) Reinforcing steel shall be according to Article 1006.10(a)(2). Welded steel wire fabric for concrete reinforcement shall be according to Article 1006.10(b)(1). Welded steel wire fabric shall be epoxy coated.
- d) Non-shrink grout shall be according to ASTM C-1107.

Fabrication: All precast units shall be manufactured according to Section 1042 of the Standard Specifications and the following requirements and tolerances with respect to the dimensions shown on the approved shop plans.

- a) The minimum reinforcement cover shall be 1 1/2 in.
- b) The precast concrete reinforcement shall be epoxy coated, including welded steel wire fabric.
- c) All dimensions shall be within a +/- 1/8 in. tolerance from the dimensions shown on the plans.
- d) All hardware embedded in panels shall be within 1/4 inch of the dimensions shown on the plans.
- e) Angular distortion with regard to pilaster squareness, defined as the difference between the two diagonals, shall not exceed 1/4 inch.
- f) Surface defects on formed surfaces measured on a length of 3 ft. shall not be more than 0.1 in.
- g) The precast concrete pilasters and medallions shall be installed vertical, measured both transversely and longitudinally.

Construction Requirements: The Contractor shall obtain technical assistance from the precast supplier to develop the proper methods for precast handling in the field and coordinate requirements for temporary support of precast during erection and subsequent cast-in-place concrete placement. The Contractor must also coordinate with the precast supplier on how best to deal with dimensional variations present in the field that are the result of changes in or unknown field conditions.

Method of Measurement: Furnishing and Erecting Precast Concrete Pilasters and Medallions will not be measured for payment.

Basis of Payment: This work shall include all labor, equipment and materials required to manufacture mock-up and permanent precast elements, deliver precast items to the site, temporarily support, make any necessary field modifications and make final connections to permanent supporting cast-in-place concrete elements and will be included in the unit price bid for CONCRETE BRIDGE RAILING.

CONCRETE BRIDGE RAILING

Description: This item shall include the furnishing of all materials and the necessary labor to construct and erect the completed railing as specified on the plans and as specified herein.

Construction: Concrete Bridge Railing (Special), shall be constructed in accordance with the applicable portions of Section 503, 504, 508, and 1020 of the Standard Specifications, the special provision for Furnishing and Erecting Precast Concrete Pilasters and Medallions and as detailed on the plans.

All concrete for the cast in place portions of the railing shall be Class BS according to Article 1020.04 of the Standard Specifications.

Surface finishing shall conform to CONCRETE FINISH. The surface of the concrete railing shall be finished according to Article 503.16 (b).

Form Liner Textured Surface:

Form liner textured surface shall be provided at the locations indicated in the plans. The form liner shall have a maximum relief of 1/4" and be from or equivalent to the following manufacturers and patterns:

- a) Custom Rock pattern T307 (Fractured Granite)
- b) Fitzgerald pattern 17982 (Splitfaced Stone)
- c) Fitzgerald pattern 16989 (Split Slate)
- d) Greenstreak pattern 377 (Flamed Granite)

One of the above patterns will be selected by the City for use. See Special Provision for Furnishing Mock-Ups.

Method of Measurement: This work shall be measured in place per lineal foot of railing.

Basis of Payment: This work will be paid for at the contract unit price bid per foot for CONCRETE BRIDGE RAILING, which price shall be full compensation for all labor, equipment and materials required for performing the work as specified herein and detailed on the plans.

PARAPET RAILING, SPECIAL

Description: This item shall include the furnishing of all materials and the necessary labor to construct and erect the completed aluminum parapet railing as specified on the plans and as specified herein. The line and grade of the railing shall be true to that shown on the plans and not follow any defects in the superstructure. Railing posts shall be vertical. Tops of railings shall be parallel to the grade line.

Materials: Materials shall meet the applicable requirements of Section 509.02 of the Standard Specifications. All aluminum railing elements shall be according to ASTM B221 (B 221M), Alloy 6061-T6.

Construction: This item shall meet the applicable construction requirements of Article 509 of the Standard Specifications and the details in the plans. Welding procedures for aluminum components shall be qualified and performed in accordance with AWS D1.2/D1.2M: 2008 Structural Welding Code – Aluminum.

Powder Coating: All posts, railings, splices and anchor plates shall be powder coated. The powder coating system to be used shall be approved by the Engineer prior to the coating process and shall conform to the following:

- a) SUBMITTALS
 - i. Manufacturer's Installation Instructions: Indicate special procedures and perimeter conditions requiring special attention.
 - ii. Manufacturer's Certificate: Certify that products meet or exceed specified requirements.
 - iii. Maintenance Data: Include cleaning procedures and repair and patching techniques.
 - iv. Provide 6 inch x 6 inch sample of the final powder coat color and finish.
- b) QUALITY ASSURANCE
 - i. Maintain one copy of each referenced document that applies to application on site.
 - ii. Manufacturer Qualifications: Company specializing in manufacturing the Products specified in this section with minimum three years documented experience.
 - iii. Applicator Qualifications: Company specializing in performing the work of this section with minimum 3 years documented experience.
- c) WARRANTY
 - i. Manufacturer's warranty.
 - ii. Warranty: Include coverage for bond to substrate.
- d) MAINTENANCE PRODUCTS
 - i. Provide 1 gallon (4 l) of color matched exterior grade polyurethane paint for each color specified, for Contracting Authority's maintenance use.
 - ii. Label each container with manufacturer's name, product number, color number.
- e) MATERIALS
 - iii. Coatings - General: Provide complete multi-coat systems formulated and recommended by manufacturer for the applications indicated, number of coats specified does not include primer or filler coat.
 - iv. Top Coat Color: The Contractor shall provide the Engineer for selection by the City with one (1) 4' long sample of the aluminum railing in the following top coat color: Reddish brown, munsell no. 2.5YR 3/4. The City will select the final top coat color for the railing from the following two (2) choices after they review the sample (See FURNISHING MOCK-UPS special provision):
 - Reddish brown, munsell no. 2.5YR 3/4
 - Gloss BlackThe City will select a top coat color and inform the Contractor prior to fabrication of the railing.
 - v. Primers: As recommended by coating manufacturer for specific substrate.

f) MANUFACTURERS

- vi. Valspar Powder Coat
- vii. PPG Architectural Finishes, Inc; Product Environchron Powder Coat
- viii. Tiger Dry-Lac; Polyester TGIC Powder Coating

g) EXAMINATION

- ix. Verify that substrate surfaces are ready to receive work as instructed by the coating manufacturer. Obtain and follow manufacturer's instructions for examination and testing of substrates.

h) PREPARATION

- x. Clean surfaces of loose foreign matter and prepare surfaces according to manufacturer's specifications.

i) PRIMING

- xi. Apply primer to all surfaces, unless specifically not required by coating manufacturer. Apply in accordance with coating manufacturer's instructions.

j) COATING APPLICATION

- xii. Apply coatings in accordance with manufacturer's instructions, to thicknesses specified by manufacturer.
- xiii. Apply in uniform thickness coats, without runs, drips, pinholes, brush marks, or variations in color, texture, or finish. Finish edges, crevices, corners, and other changes in dimension with full coating thickness.

- k) The Contractor shall provide evidence that the system has surpassed a 6,000 hour salt spray test with zero failure on the scribe mark.

The Contractor shall repair areas of the coating damaged during shipping and installation at the direction of the Engineer. The Contractor shall follow coating manufacturer procedures for touching up damaged areas in the field. Items adjacent to repair areas shall be masked off and protected from overspray during touching-up process.

Method of Measurement: Railing will be measured in feet. The length paid for will be the overall length along the top longitudinal railing.

Basis of Payment: This will be paid for at the contract unit price per foot for PARAPET RAILING, SPECIAL, which price shall include all materials, fabrication, transportation, erection, cleaning, powder coating and field touch-ups to the powder coated finish.

DRAINAGE SCUPPER

Description: This work shall consist of furnishing and installing Drainage Scuppers as detailed in the plans.

Method of Measurement: This work shall be measured per each.

Basis of Payment: This work will be a paid for at the contract unit price per each for DRAINAGE SCUPPER, of the specified type, which price shall include all materials, labor, and equipment necessary to perform the work as detailed in the plans.

NAME PLATES (SPECIAL)

Description: This work shall consist of furnishing and installing four (4) bronze signs in accordance with the applicable portions of Section 515 of the Standard Specifications, the details in the plans and these special provisions.

The lettering and details of the sign shall be in accordance with the following:

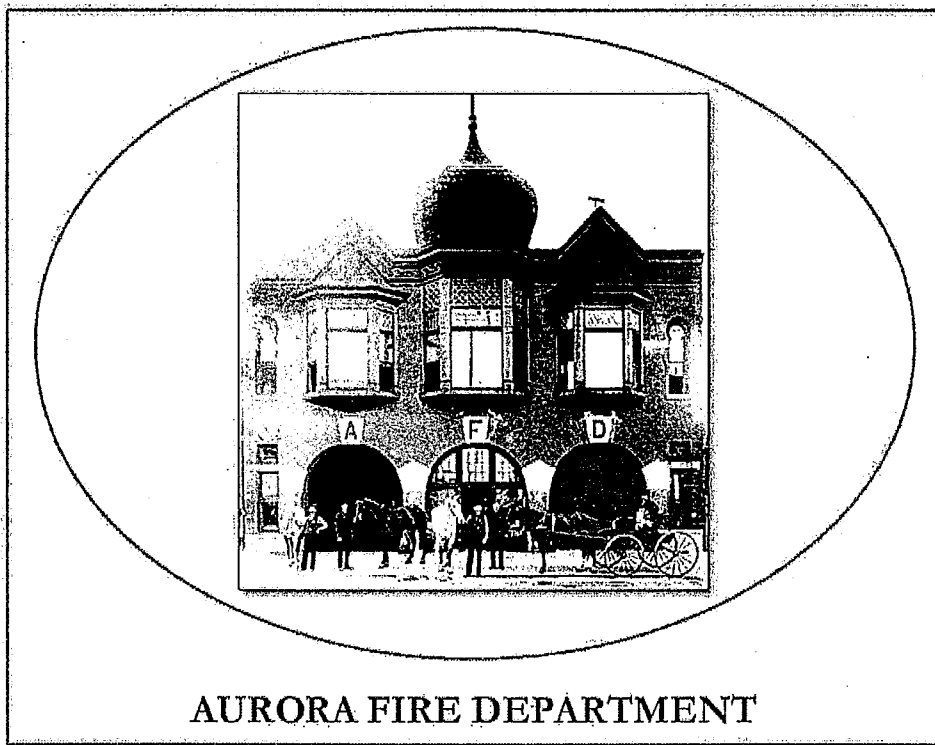

GRAPHIC I

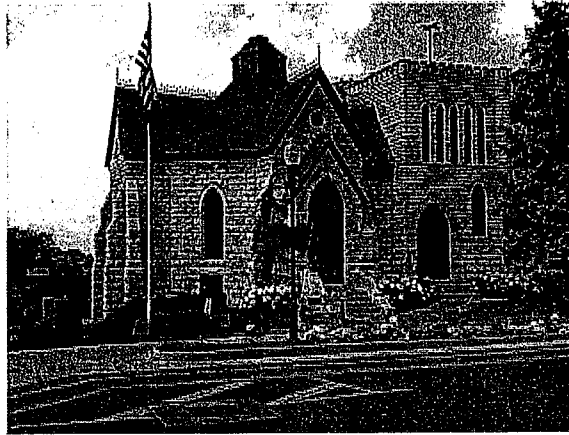

GRAND ARMY OF THE REPUBLIC

GRAPHIC II

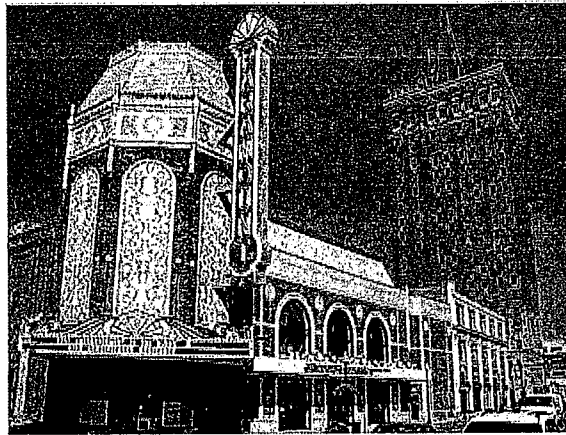

PARAMOUNT THEATER

GRAPHIC III

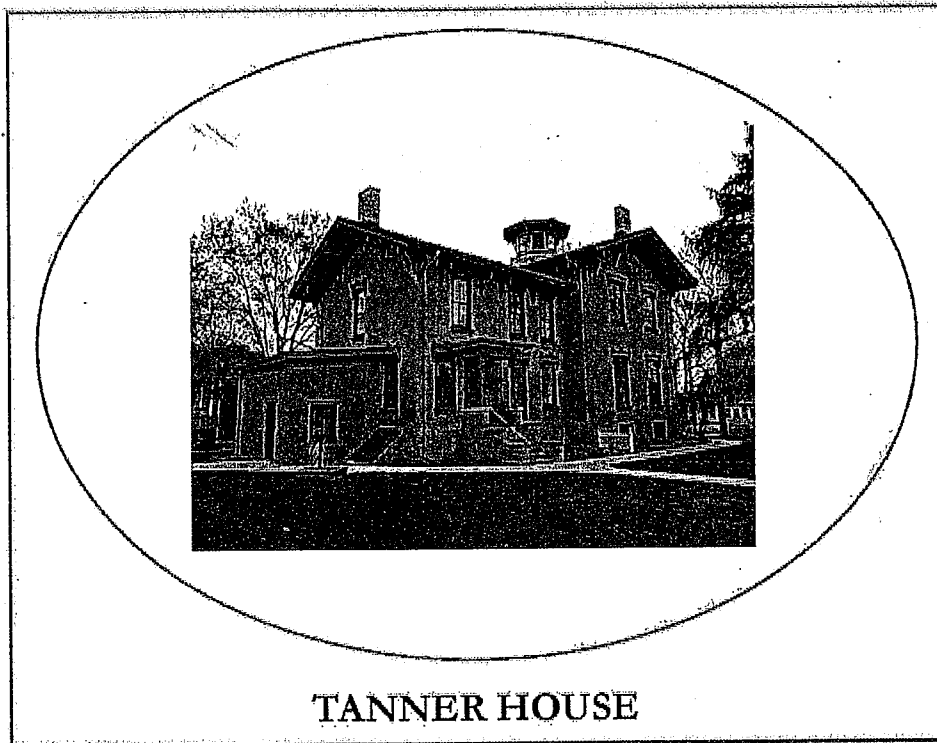

GRAPHIC IV

The bronze signs shall depict the buildings schematically as the raised portions on the signs. The trees, cars, people, adjacent buildings and other extraneous items shown in the graphics above will not be included on the sign. The lettering font shall be Garamond. The Contractor shall submit shop drawings of the signs to the Engineer for Owner approval prior to fabrication. The shop drawings shall include the below two options for each of the signs;

1. Rectangular sign generally conforming to the graphics indicated in this special provisions and the dimensions indicated on the bridge railing details in the plans;
2. Oval sign generally conforming to the graphics indicated in this special provision. The lettering text would be provided on a separate rectangular plaque below the oval graphic sign. The Oval pictorial sign and lettering sign must fit within the dimensions indicated on the bridge railing details in the plans

Method of Measurement: This work shall be measured per each.

Basis of Payment: This work will be a paid for at the contract unit price per each for NAME PLATES (SPECIAL), which price shall include all materials, labor, and equipment necessary to perform the work as detailed in the plans and described herein.

MANHOLE, SPECIAL

Description: This work shall consist of furnishing and installing a Manhole, Special as detailed in the plans. This item shall conform to the details in the plans, the applicable portions of Section 602 of the Standard Specifications and Highway Standard 602406.

Flat stock High Density Polyethylene (HDPE) shall meet ASTM D-3350-93 class 345464C.

Method of Measurement: This work shall be measured per each.

Basis of Payment: This work will be a paid for at the contract unit price per each for MANHOLE, SPECIAL, of the specified type, which price shall include all materials, labor, and equipment necessary to perform the work as detailed in the plans.

FENCE REMOVAL

Description: This work shall consist of removing portions of an existing chain link fence as detailed in the plans. This item includes complete removal and disposal of fence posts, rails, screening and post foundations within the limits indicated on the plans.

Method of Measurement: This work shall be measured per linear foot.

Basis of Payment: This work will be a paid for at the contract unit price per linear foot for FENCE REMOVAL, which price shall include all materials, labor, and equipment necessary to perform the work as detailed in the plans.

BITUMINOUS PRIME COAT FOR HOT-MIX ASPHALT PAVEMENT (FULL DEPTH) (D-1)

Effective: May 1, 2007

Revise Article 407.06(b) of the Standard Specifications to read:

“A bituminous prime coat shall be applied between each lift of HMA according to Article 406.05(b) at a rate of 0.02 to 0.05 gal/sq yd (0.1 to 0.2 L/sq m), the exact rate to be determined by the Engineer.”

Revise the second paragraph of Article 407.12 of the Standard Specifications to read:

“Prime Coat will be paid for at the contract unit price per GALLON (liter) or per TON (metric ton) for BITUMINOUS MATERIALS (PRIME COAT).”

RECLAIMED ASPHALT PAVEMENT AND RECLAIMED ASPHALT SHINGLES (D-1)

Effective: November 1, 2012

Revise: January 2, 2013

Revise Section 1031 of the Standard Specifications to read:

"SECTION 1031. RECLAIMED ASPHALT PAVEMENT AND RECLAIMED ASPHALT SHINGLES

1031.01 Description. Reclaimed asphalt pavement and reclaimed asphalt shingles shall be according to the following.

- (a) Reclaimed Asphalt Pavement (RAP). RAP is the material resulting by cold milling or crushing an existing hot-mix asphalt (HMA) pavement. RAP will be considered processed FRAP after completion of both crushing and screening to size. The Contractor shall supply written documentation that the RAP originated from routes or airfields under federal, state, or local agency jurisdiction.
- (b) Reclaimed Asphalt Shingles (RAS). Reclaimed asphalt shingles (RAS). RAS is from the processing and grinding of preconsumer or post-consumer shingles. RAS shall be a clean and uniform material with a maximum of 0.5 percent unacceptable material, as defined in Bureau of Materials and Physical Research Policy Memorandum "Reclaimed Asphalt Shingle (RAS) Sources", by weight of RAS. All RAS used shall come from a Bureau of Materials and Physical Research approved processing facility where it shall be ground and processed to 100 percent passing the 3/8 in. (9.5 mm) sieve and 90 percent passing the #4 (4.75 mm) sieve . RAS shall meet the testing requirements specified herein. In addition, RAS shall meet the following Type 1 or Type 2 requirements.
 - (1) Type 1. Type 1 RAS shall be processed, preconsumer asphalt shingles salvaged from the manufacture of residential asphalt roofing shingles.
 - (2) Type 2. Type 2 RAS shall be processed post-consumer shingles only, salvaged from residential, or four unit or less dwellings not subject to the National Emission Standards for Hazardous Air Pollutants (NESHAP).

1031.02 Stockpiles. RAP and RAS stockpiles shall be according to the following.

- (a) RAP Stockpiles. The Contractor shall construct individual, sealed RAP stockpiles meeting one of the following definitions. No additional RAP shall be added to the pile after the pile has been sealed. Stockpiles shall be sufficiently separated to prevent intermingling at the base. All stockpiles (including unprocessed RAP and Processed FRAP) shall be identified by signs indicating the type as listed below (i.e. "Non- Quality, FRAP #4 or Type 2 RAS", etc...).
- (1) Fractionated RAP (FRAP). FRAP shall consist of RAP from Class I, Superpave HMA (High and Low ESAL) or equivalent mixtures. The coarse aggregate in FRAP

shall be crushed aggregate and may represent more than one aggregate type and/or quality but shall be at least C quality. All FRAP shall be processed prior to testing sized into fractions with the separation occurring on or between the #4 (4.75 mm) and 1/2 in. (12.5 mm) sieves. Agglomerations shall be minimized such that 100 percent of the RAP in the coarse fraction shall pass the maximum sieve size specified for the mix the RAP will be used in.

- (2) Restricted FRAP (B quality) stockpiles shall consist of RAP from Class I, Superpave (High ESAL), or HMA (High ESAL). If approved by the Engineer, the aggregate from a maximum 3.0 inch single combined pass of surface/binder milling will be classified as B quality. All millings from this application will be processed into FRAP as described previously.
- (3) Conglomerate. Conglomerate RAP stockpiles shall consist of RAP from Class I, Superpave HMA (High and Low ESAL) or equivalent mixtures. The coarse aggregate in this RAP shall be crushed aggregate and may represent more than one aggregate type and/or quality but shall be at least C quality. This RAP may have an inconsistent gradation and/or asphalt binder content prior to processing. All conglomerate RAP shall be processed (FRAP) prior to testing. Conglomerate RAP stockpiles shall not contain steel slag or other expansive material as determined by the Department.
- (4) Conglomerate "D" Quality (DQ). Conglomerate DQ RAP stockpiles shall consist of RAP from HMA shoulders, bituminous stabilized subbases or Superpave (Low ESAL)/HMA (Low ESAL) IL-19.0L binder mixture. The coarse aggregate in this RAP may be crushed or round but shall be at least D quality. This RAP may have an inconsistent gradation and/or asphalt binder content. Conglomerate DQ RAP stockpiles shall not contain steel slag or other expansive material as determined by the Department.
- (5) Non-Quality. RAP stockpiles that do not meet the requirements of the stockpile categories listed above shall be classified as "Non-Quality".

RAP/FRAP containing contaminants, such as earth, brick, sand, concrete, sheet asphalt, bituminous surface treatment (i.e. chip seal), pavement fabric, joint sealants, plant cleanout etc., will be unacceptable unless the contaminants are removed to the satisfaction of the Engineer. Sheet asphalt shall be stockpiled separately.

- (b) RAS Stockpiles. The Contractor shall construct individual, sealed RAS stockpiles meeting one of the following definitions. No additional RAS shall be added to the pile after the pile has been sealed. Type 1 and Type 2 RAS shall be stockpiled separately and shall be sufficiently separated to prevent intermingling at the base. Each stockpile shall be signed indicating what type of RAS is present.

However, a RAS source may submit a written request to the Department for approval to blend mechanically a specified ratio of type 1 RAS with type 2 RAS. The source will not be permitted to change the ratio of the blend without the Department prior written approval. The Engineer's written approval will be required, to mechanically blend RAS with any fine aggregate produced under the AGCS, up to an equal weight of RAS, to

improve workability. The fine aggregate shall be "B Quality" or better from an approved Aggregate Gradation Control System source. The fine aggregate shall be one that is approved for use in the HMA mixture and accounted for in the mix design and during HMA production.

Records identifying the shingle processing facility supplying the RAS, RAS type and lot number shall be maintained by project contract number and kept for a minimum of three years.

1031.03 Testing. RAP/FRAP and RAS testing shall be according to the following.

(a) RAP/FRAP Testing. When used in HMA, the RAP/FRAP shall be sampled and tested either during processing or after stockpiling.

(1) During Stockpiling. For testing during stockpiling, washed extraction samples shall be run at the minimum frequency of one sample per 500 tons (450 metric tons) for the first 2000 tons (1800 metric tons) and one sample per 2000 tons (1800 metric tons) thereafter. A minimum of five tests shall be required for stockpiles less than 4000 tons (3600 metric tons).

(2) After Stockpiling. For testing after stockpiling, the Contractor shall submit a plan for approval to the District proposing a satisfactory method of sampling and testing the RAP/FRAP pile either in-situ or by restockpiling. The sampling plan shall meet the minimum frequency required above and detail the procedure used to obtain representative samples throughout the pile for testing.

Before extraction, each field sample whether RAP or FRAP, shall be split to obtain two samples of test sample size. One of the two test samples from the final split shall be labeled and stored for Department use. The Contractor shall extract the other test sample according to Department procedure. The Engineer reserves the right to test any sample (split or Department-taken) to verify Contractor test results.

(b) RAS Testing. RAS shall be sampled and tested either during or after stockpiling.

During stockpiling, washed extraction, and testing for unacceptable materials shall be run at the minimum frequency of one sample per 200 tons (180 metric tons) for the first 1000 tons (900 metric tons) and one sample per 1000 tons (900 metric tons) thereafter. A minimum of five samples are required for stockpiles less than 1000 tons (900 metric tons). Once a ≤ 1000 ton (900 metric ton), five-sample/test stockpile has been established it shall be sealed. Additional incoming RAS shall be stockpiled in a separate working pile as designated in the Quality Control plan and only added to the sealed stockpile when the test results of the working pile are complete and are found to meet the tolerances specified herein for the original sealed RAS stockpile.

Before extraction, each field sample shall be split to obtain two samples of test sample size. One of the two test samples from the final split shall be labeled and stored for Department use. The Contractor shall extract the other test sample according to

Department procedures. The Engineer reserves the right to test any sample (split or Department-taken) to verify Contractor test results.

1031.04 Evaluation of Tests. Evaluation of tests results shall be according to the following.

- (a) Evaluation of RAP/FRAP Test Results. All of the extraction results shall be compiled and averaged for asphalt binder content and gradation and, when applicable (for slag) G_{mm} . Individual extraction test results, when compared to the averages, will be accepted if within the tolerances listed below.

Parameter	RAP or FRAP	Conglomerate "D" Quality RAP
1 in. (25 mm)		± 5 %
1/2 in. (12.5 mm)	± 8 %	± 15 %
No. 4 (4.75 mm)	± 6 %	± 13 %
No. 8 (2.36 mm)	± 5 %	
No. 16 (1.18 mm)		± 15 %
No. 30 (600 μm)	± 5 %	
No. 200 (75 μm)	± 2.0 %	± 4.0 %
Asphalt Binder	± 0.4 % ^{1/}	± 0.5 %
G_{mm}	± 0.03 ^{2/}	

1/ The tolerance for FRAP shall be ± 0.3 %.

2/ For slag and steel slag

If more than 20 percent of the individual sieves and/or asphalt binder content tests are out of the above tolerances, the RAP/FRAP shall not be used in HMA unless the RAP/FRAP representing the failing tests is removed from the stockpile. All test data and acceptance ranges shall be sent to the District for evaluation.

With the approval of the Engineer, the ignition oven may be substituted for extractions according to the Illinois Test Procedure, "Calibration of the Ignition Oven for the Purpose of Characterizing Reclaimed Asphalt Pavement (RAP)".

- (b) Evaluation of RAS Test Results. All of the test results, with the exception of percent unacceptable materials, shall be compiled and averaged for asphalt binder content and gradation. Individual test results, when compared to the averages, will be accepted if within the tolerances listed below.

Parameter	RAS
No. 8 (2.36 mm)	± 5 %
No. 16 (1.18 mm)	± 5 %
No. 30 (600 μm)	± 4 %

No. 200 (75 μ m)	\pm 2.0 %
Asphalt Binder Content	\pm 1.5 %

If more than 20 percent of the individual sieves and/or asphalt binder content tests are out of the above tolerances, the RAS shall not be used in Department projects unless the RAS, RAP or FRAP representing the failing tests is removed from the stockpile. All test data and acceptance ranges shall be sent to the District for evaluation.

1031.05 Quality Designation of Aggregate in RAP/FRAP.

(a) RAP. The aggregate quality of the RAP for homogenous, conglomerate, and conglomerate "D" quality stockpiles shall be set by the lowest quality of coarse aggregate in the RAP stockpile and are designated as follows.

- (1) RAP from Class I, Superpave (High ESAL)/HMA (High ESAL), or (Low ESAL) IL-9.5L surface mixtures are designated as containing Class B quality coarse aggregate.
- (2) RAP from Superpave (High ESAL)/HMA (Low ESAL) IL-19.0L binder mixture is designated as Class D quality coarse aggregate.
- (3) RAP from Class I, Superpave (High ESAL)/HMA (High ESAL) binder mixtures, bituminous base course mixtures, and bituminous base course widening mixtures are designated as containing Class C quality coarse aggregate.
- (4) RAP from bituminous stabilized subbase and BAM shoulders are designated as containing Class D quality coarse aggregate.

(b) FRAP. If the Engineer has documentation of the quality of the FRAP aggregate, the Contractor shall use the assigned quality provided by the Engineer.

If the quality is not known, the quality shall be determined as follows. Fractionated RAP stockpiles containing plus #4 (4.75 mm) sieve coarse aggregate shall have a maximum tonnage of 5,000 tons (4,500 metric tons). The Contractor shall obtain a representative sample witnessed by the Engineer. The sample shall be a minimum of 50 lb (25 kg). The sample shall be extracted according to Illinois Modified AASHTO T 164 by a consultant prequalified by the Department for the specified testing. The consultant shall submit the test results along with the recovered aggregate to the District Office. The cost for this testing shall be paid by the Contractor. The District will forward the sample to the BMRP Aggregate Lab for MicroDeval Testing, according to Illinois Modified AASHTO T 327. A maximum loss of 15.0 percent will be applied for all HMA applications. The fine aggregate portion of the fractionated RAP shall not be used in any HMA mixtures that require a minimum of "B" quality aggregate or better, until the coarse aggregate fraction has been determined to be acceptable thru a MicroDeval Testing.

1031.06 Use of RAS, RAP or FRAP in HMA. The use of RAS, RAP or FRAP shall be a Contractor's option when constructing HMA in all contracts.

(a) RAP/FRAP. The use of RAP/FRAP in HMA shall be as follows.

- (1) Coarse Aggregate Size (after extraction). The coarse aggregate in all RAP shall be equal to or less than the nominal maximum size requirement for the HMA mixture to be produced.
- (2) Steel Slag Stockpiles. RAP/FRAP stockpiles containing steel slag or other expansive material, as determined by the Department, shall be homogeneous and will be approved for use in HMA (High ESAL and Low ESAL) mixtures regardless of lift or mix type.
- (3) Use in HMA Surface Mixtures (High and Low ESAL). RAP/FRAP stockpiles for use in HMA surface mixtures (High and Low ESAL) shall have coarse aggregate that is Class B quality or better. RAP/FRAP shall be considered equivalent to limestone for frictional considerations unless produced/screened to minus 3/8 inch.
- (4) Use in HMA Binder Mixtures (High and Low ESAL), HMA Base Course, and HMA Base Course Widening. RAP/FRAP stockpiles for use in HMA binder mixtures (High and Low ESAL), HMA base course, and HMA base course widening shall be FRAP in which the coarse aggregate is Class C quality or better.
- (5) Use in Shoulders and Subbase. RAP/FRAP stockpiles for use in HMA shoulders and stabilized subbase (HMA) shall be RAP, Restricted FRAP, conglomerate, or conglomerate DQ.

(b) RAS. RAS meeting Type 1 or Type 2 requirements will be permitted in all HMA applications as specified herein.

(c) RAP/FRAP and/or RAS Usage Limits. Type 1 or Type 2 RAS may be used alone or in conjunction with RAP or FRAP in HMA mixtures up to a maximum of 5.0% by weight of the total mix.

When the Contractor chooses the RAP option, the percentage of the percentage of virgin asphalt binder replaced by the asphalt binder from the RAP shall not exceed the percentages indicated in the table below for a given N Design:

Max Asphalt Binder Replacement RAP Only
 Table 1

HMA Mixtures ^{1/, 2/}	Maximum % Asphalt Binder replacement (ABR)			
	Ndesign	Binder/Leveling Binder	Surface	Polymer Modified
30L		25	15	10
50		25	15	10
70		15	10	10
90		10	10	10

105	10	10	10
4.75 mm N-50			15
SMA N-80			10

- 1/ For HMA "All Other" (shoulder and stabilized subbase) N-30, the percent asphalt binder replacement shall not exceed 50% of the total asphalt binder in the mixture.
- 2/ When the asphalt binder replacement exceeds 15 percent, the high and low virgin asphalt binder grades shall each be reduced by one grade (i.e. 25 percent binder replacement would require a virgin asphalt binder grade of PG64-22 to be reduced to a PG58-28). When constructing full depth HMA and the ABR is less than 15 percent, the required virgin asphalt binder grade shall be PG64-28.

When the Contractor chooses either the RAS or FRAP option, the percent binder replacement shall not exceed the amounts indicated in the tables below for a given N Design.

Max Asphalt Binder Replacement RAS or FRAP
 Table 2

HMA Mixtures ^{1/, 2/}	Maximum % ABR		
Ndesign	Binder/Leveling Binder	Surface	Polymer ^{3/, 4/} Modified
30L	35	30	15
50	30	25	15
70	30	20	15
90	20	15	15
105	20	15	15
4.75 mm N-50			25
SMA N-80			15

- 1/ For HMA "All Other" (shoulder and stabilized subbase) N-30, the percent asphalt binder replacement shall not exceed 50% of the total asphalt binder in the mixture.
- 2/ When the asphalt binder replacement exceeds 15 percent for all mixes, except for SMA and IL-4.75, the high and low virgin asphalt binder grades shall each be reduced by one grade (i.e. 25 percent binder replacement will require a virgin asphalt binder grade of PG64-22 to be reduced to a PG58-28). When constructing full depth HMA and the ABR is less than 15 percent, the required virgin asphalt binder grade shall be PG64-28.
- 3/ When the ABR for SMA is 15 percent or less, the required virgin asphalt binder grade shall be SBS PG76-22.

4/ When the ABR for IL-4.75 mix is 15 percent or less, the required virgin asphalt binder grade shall be SBS PG76-22. When the ABR for the IL-4.75 mix exceeds 15 percent, the virgin asphalt binder grade shall be SBS PG70-28.

When the Contractor chooses the RAS with FRAP combination, the percent asphalt binder replacement shall split equally between the RAS and the FRAP, and the total replacement shall not exceed the amounts indicated in the tables below for a given N Design.

Max Asphalt Binder Replacement RAS and FRAP Combination
 Table 3

HMA Mixtures ^{1/, 2/}	Maximum % ABR		
	Binder/Leveling Binder	Surface	Polymer Modified ^{3/, 4/}
Ndesign			
30L	50	40	30
50	40	35	30
70	40	30	30
90	40	30	30
105	40	30	30
4.75 mm N-50			40
SMA N-80			30

1/ For HMA "All Other" (shoulder and stabilized subbase) N-30, the percent asphalt binder replacement shall not exceed 50% of the total asphalt binder in the mixture.

2/ When the binder replacement exceeds 15 percent for all mixes, except for SMA and IL-4.75, the high and low virgin asphalt binder grades shall each be reduced by one grade (i.e. 25 percent binder replacement will require a virgin asphalt binder grade of PG64-22 to be reduced to a PG58-28).

3/ When the ABR for SMA is 15 percent or less, the required virgin asphalt binder shall be SBS PG76-22. When the ABR for SMA exceeds 15%, the virgin asphalt binder grade shall be SBS PG70-28.

4/ When the ABR for IL-4.75 mix is 15 percent or less, the required virgin asphalt binder grade shall be SBS PG76-22. When the ABR for the IL-4.75 mix exceeds 15 percent, the virgin asphalt binder grade shall be SBS PG70-28.

1031.07 HMA Mix Designs. At the Contractor's option, HMA mixtures may be constructed utilizing RAP/FRAP and/or RAS material meeting the above detailed requirements.

All HMA mixtures will be required to be tested, prior to submittal for Department verification, according to Illinois Modified AASHTO T324 (Hamburg Wheel) and shall meet the following requirements:

Asphalt Binder Grade	# Repetitions	Max Rut Depth (mm)
PG76-XX	20,000	12.5
PG70-XX	20,000	12.5
PG64-XX	10,000	12.5
PG58-XX	10,000	12.5
PG52-XX	10,000	12.5
PG46-XX	10,000	12.5

Note: For SMA Designs (N-80) the maximum rut depth is 6.0 mm at 20,000 repetitions.
 For IL 4.75 mm Designs (N-50) the maximum rut depth is 9.0 mm at 15,000 repetitions.

1031.08 HMA Production. All HMA mixtures shall be sampled within the first 500 tons (450 metric tons) on the first day of production or during start up with a split reserved for the Department. The mix sample shall be tested according to the Illinois Modified AASHTO T 324 and shall meet the requirements specified herein. Mix production shall not exceed 1500 tons (1350 metric tons) or one day's production, whichever comes first, until the testing is completed and the mixture is found to be in conformance. The requirement to cease mix production may be waived if the plant produced mixture demonstrates conformance prior to start of mix production for a contract.

To remove or reduce agglomerated material, a scalping screen, gator, crushing unit, or comparable sizing device approved by the Engineer shall be used in the RAS, RAP and FRAP feed system to remove or reduce oversized material. If material passing the sizing device adversely affects the mix production or quality of the mix, the sizing device shall be set at a size specified by the Engineer.

If the RAS, RAP and FRAP control tolerances or QC/QA test results require corrective action, the Contractor shall cease production of the mixture containing RAS, RAP or FRAP and either switch to the virgin aggregate design or submit a new RAS, RAP or FRAP design.

- (a) RAP/FRAP. The coarse aggregate in all RAP/FRAP used shall be equal to or less than the maximum size requirement for the HMA mixture being produced.
- (b) RAS. RAS shall be incorporated into the HMA mixture either by a separate weight depletion system or by using the RAP weigh belt. Either feed system shall be interlocked with the aggregate feed or weigh system to maintain correct proportions for all rates of production and batch sizes. The portion of RAS shall be controlled accurately to within ± 0.5 percent of the amount of RAS utilized. When using the weight depletion system, flow indicators or sensing devices shall be provided and interlocked with the plant controls such that the mixture production is halted when RAS flow is interrupted.
- (c) RAS, RAP and FRAP. HMA plants utilizing RAS, RAP and FRAP shall be capable of automatically recording and printing the following information.

- (1) Dryer Drum Plants.

- a. Date, month, year, and time to the nearest minute for each print.
 - b. HMA mix number assigned by the Department.
 - c. Accumulated weight of dry aggregate (combined or individual) in tons (metric tons) to the nearest 0.1 ton (0.1 metric ton).
 - d. Accumulated dry weight of RAS, RAP and FRAP in tons (metric tons) to the nearest 0.1 ton (0.1 metric ton).
 - e. Accumulated mineral filler in revolutions, tons (metric tons), etc. to the nearest 0.1 unit.
 - f. Accumulated asphalt binder in gallons (liters), tons (metric tons), etc. to the nearest 0.1 unit.
 - g. Residual asphalt binder in the RAS, RAP and FRAP material as a percent of the total mix to the nearest 0.1 percent.
 - h. Aggregate RAS, RAP and FRAP moisture compensators in percent as set on the control panel. (Required when accumulated or individual aggregate and RAS, RAP and FRAP are printed in wet condition.)
 - i. When producing mixtures with FRAP and/or RAS, a positive dust control system shall be utilized.
 - j. Accumulated mixture tonnage.
 - k. Dust Removed (accumulated to the nearest 0.1 ton)
- (2) Batch Plants.
- a. Date, month, year, and time to the nearest minute for each print.
 - b. HMA mix number assigned by the Department.
 - c. Individual virgin aggregate hot bin batch weights to the nearest pound (kilogram).
 - d. Mineral filler weight to the nearest pound (kilogram).
 - f. RAS, RAP and FRAP weight to the nearest pound (kilogram).
 - g. Virgin asphalt binder weight to the nearest pound (kilogram).
 - h. Residual asphalt binder in the RAS, RAP and FRAP material as a percent of the total mix to the nearest 0.1 percent.

The printouts shall be maintained in a file at the plant for a minimum of one year or as directed by the Engineer and shall be made available upon request. The printing system will be inspected by the Engineer prior to production and verified at the beginning of each construction season thereafter.

1031.09 RAP in Aggregate Surface Course and Aggregate Shoulders. The use of RAP or FRAP in aggregate surface course and aggregate shoulders shall be as follows.

- (a) Stockpiles and Testing. RAP stockpiles may be any of those listed in Article 1031.02, except "Non-Quality" and "FRAP". The testing requirements of Article 1031.03 shall not apply.
- (b) Gradation. One hundred percent of the RAP material shall pass the 1 1/2 in. (37.5mm) sieve. The RAP material shall be reasonably well graded from coarse to fine. RAP material that is gap-graded, FRAP, or single sized will not be accepted for use as Aggregate Surface Course and Aggregate Shoulders."

FINE AGGREGATE FOR HOT- MIX ASPHALT (HMA) (D-1)

Effective: May 1, 2007

Revised: January 1, 2012

"(a) Description. Fine aggregate for HMA shall consist of sand, stone sand, chats, slag sand, or steel slag sand. For gradation FA 22, uncrushed material will not be permitted."

Revise Article 1003.03 (c) of the Standard Specifications to read:

" (c) Gradation. The fine aggregate gradation for all HMA shall be FA1, FA 2, FA 20, FA 21 or FA 22. When Reclaimed Asphalt Pavement (RAP) is incorporated in the HMA design, the use of FA 21 Gradation will not be permitted.

EXISTING BRIDGE PLANS

The existing bridges are owned by the City of Aurora. The Illinois Department of Transportation is not the owner of record for this bridge. The existing bridge plans provided in these documents are included only as general information. They are not as-built or record plans. See General Notes in the Bridge Plans. Those seeking more clearly detailed historic documents must contact the owner of record to make arrangements for access to this information.

DEWATERING

This work shall consist of dewatering the work area within the cofferdams and as required by the Engineer. Coordinate this work with the Guide Bridge Special Provision "Cofferdams" of the location and type specified, and the details in the plans.

Construction Requirements. Care shall be taken when installing and removing temporary works to limit unnecessary agitation of sediment into the stream. Whenever possible, work shall

be scheduled for low flow seasons.

Methods used shall be done within the City's right-of-way or temporary construction easements (if applicable).

Dewatering plans shall be able to accommodate any flow event by allowing water to return to the natural channel. Flooding of adjacent property will not be allowed. Any damage to the work previously completed by the Contractor by any flow event shall be repaired to the satisfaction of the Engineer.

Repairing damage caused by any flow event will not be grounds for extra compensation.

Normal flow shall be conveyed past the work area by means of a pump bypass or stream diversion. All such bypasses shall be completed and stabilized prior to diverting flow.

In-channel excavations shall be done from the top of banks wherever possible. Where this is not possible, see the details in the plans and the Guide Bridge Special Provision for "Cofferdams" for any equipment working from within the channel. Upon completion, all areas disturbed during construction shall be restored to preconstruction configurations and stabilized to the satisfaction of the Engineer.

All excavated channel materials that will be subsequently used as backfill shall be placed in a temporary stockpile located outside the floodplain. A sediment barrier shall be installed between the storage pile and the stream channel. Excavated material is only allowed as backfill in areas outside the channel and above normal high water.

All excavated materials that will not be used on site must be immediately removed to a disposal site having an erosion and sediment pollution control plan approved by the Engineer.

Pumped water from excavated areas must be filtered prior to discharging back into streams. Filter bags, portable settling tanks or sediment basin are acceptable methods of filtering. The use of filter bags is an acceptable method only if the filter bag is located on less than a 5% grade. This area must be sufficiently stable with vegetation or riprap, as determined by the Engineer.

All disturbed areas within the existing channel should be completed and stabilized before flow is redirected into it. Suitable protections should be provided for the stream channel from any disturbed areas that have not yet achieved stabilization.

Method of Measurement. This work will not be measured separately for payment.

Basis of Payment. The cost for this work will be included in the contract unit price bid for COFFERDAMS, of the type and location indicated. Additional excavation outside the excavation limits shown in the plans necessary for dewatering will not be paid for separately and will be included in the cost of Cofferdams.

SEDIMENT FILTER BAGS

Filter Bags must be used to filter water pumped from disturbed areas prior to discharging back into the stream. They may also be used to filter water pumped from the sediment storage areas of sediment basins.

Materials. Filter bags shall be made from non-woven geotextile material sewn with high strength, double stitched "J" type seams. They shall be capable of trapping particles larger than 150 microns.

Construction Requirements. Filter bags shall be installed according to the details shown in the erosion control plan and details.

A suitable means of accessing the bag with machinery required for disposal purposes must be provided. Filter bags shall be replaced when they become ½ full. Spare bags shall be kept available for replacement of those that have failed or are filled.

Bags shall be located in well-vegetated (grassy) areas, and discharges onto stable, erosion resistant areas. Where this is not possible, a geotextile lined flow path shall be provided. Bags shall not be placed on slopes greater than 5%.

Pumping rates vary depending on the size of the filter bag, and the type and amount of sediment discharged to the bag. The pumping rate shall be no greater than 750 gpm or ½ the maximum specified by the manufacturer, whichever is less. The maximum pumping rate shall be approved by the Engineer.

Pump intakes shall be floating and screened.

The pump discharge hose shall be inserted into the bags in the manner specified by the manufacturer and securely clamped.

Filter bags shall be inspected daily. If any problem is detected, pumping shall cease immediately and not resume until the problem is corrected to the satisfaction of the Engineer.

Basis of Payment. Sediment filter bags will not be paid for separately but shall be included in the contract unit price bid for COFFERDAMS, of the type and location indicated.

SEDIMENT CONTROL, SILT CURTAIN

Description. This work shall consist of the furnishing, installing, maintaining, and removal of a flotation silt curtain assembly, designed to collect sediment from in-stream work areas at locations shown on the plans, or as directed by the Engineer.

Materials. The silt curtain should be of appropriate size to perform the required function of isolating the work area from the rest of the stream, with length being at least 1 ft greater than the depth of water in all locations. The silt curtain assembly shall consist of the silt barrier with flotation segments or appropriate suspension devices and weighing devices and all required

anchorage devices. It shall be in good working condition and meet the approval of the Engineer. A detail drawing in the plans depicts the curtain assembly.

The silt curtain shall meet the following physical and performance properties:

	<u>Testing Method</u>	<u>Requirement</u>
Grab tensile warp strength	ASTM D-4632	≥240 lbs.
Elongation @ Break	ASTM D-4632	≥60%
Trapezoidal Tear	ASTM D-4533	≥90 lbs.
Puncture Strength	ASTM D-4833	≥65 lbs.
UV Stability @ 500 hrs	ASTM D-4355	≥70%
Permittivity	ASTM D-4491	≤0.1 sec ⁻¹
Water Flow Rate	ASTM D-4491	≤11 gpm/ft ²
AOS (US sieve #)	ASTM D-4751	≤140 sieve
Material construction		Nonwoven

All values are minimum average roll values.

Installation. The silt curtains shall be installed according to the manufacturer directions, and in a manner approved by the Engineer. Additional anchorage may be required as shown on the plans.

Requirements. The Contractor shall inspect the work site to review the stream characteristics where the work is to occur.

The silt curtain assembly shall be installed in the stream in a configuration that prevents silt from traveling beyond the work area, but does not cause flooding upstream of the work area. The silt curtain shall be installed in a manner sufficient to withstand ten-year flood water levels. The silt curtain shall not be installed across the entire stream.

Routine maintenance includes continually maintaining a properly working silt curtain. Also included is the regular removal and disposal of excess sediment in contact with either side of the curtain, as directed by the Engineer.

Pumping of water contained within the silt curtain or any other structure shall be done in a manner approved by the Engineer. Direct pumping of water back into the stream shall not be permitted. All water pumping operations must be approved by the Engineer.

The silt curtain assembly shall remain in place until the Engineer instructs the Contractor of the date and the required procedure for removal. The silt curtain assembly shall remain the property of the Contractor.

Basis of Payment. Sediment Control, Silt Fence will not be paid for separately but shall be included in the contract unit price bid for COFFERDAMS, of the type and location indicated.

STEEL CASING 66"

Description

This work shall consist of furnishing spiral welded, steel casing of the thickness listed in the table below and of the outer diameter specified on the plans or as directed by the Engineer. The sleeve shall meet ASTM A139 and ANSI/AWWA C200 (AWWA Standard for Steel Water Pipe—6 in. (150 mm) and Larger), Grade B, minimum yield strength of 35,000 psi. Sleeves shall extend at least ten feet (10') beyond the outer edge of the existing pavement or sewer pipe, as indicated in the detail drawings, unless otherwise approved by the Engineer. All work shall be done in accordance with Section 552 of the Standard Specifications.

After installation of the steel sleeve is completed, the proposed storm sewer shall be constructed in place within the sleeve. The storm sewer shall be inserted and centered by use of stainless steel casing spacers at a maximum spacing of 6 feet. Casing spacer shall be made from T-304 stainless steel of a minimum thickness of 14 gauge. Each shell section shall be a maximum of 12" wide, and shall be a two-piece design. Each shell section shall have a stud bar and receiver bar TIG welded to the shell. Studs shall be T-304 and threaded as 5/8-11x7" long. Each stud bar shall include up to three studs, and shall allow a maximum of 1" adjustment to circumference to compensate for the variations in large diameter (non-uniform) pipe. The shell shall be lined with a 0.090" thick, ribbed PVC extrusion with a retaining section that overlaps the edges of the shell and prevents slippage. Bearing surfaces (runners) shall be ultra high molecular weight polyethylene (UHMW) to provide high abrasion resistance and a low coefficient of friction (0.12). The runners shall be attached to support structures (risers) at appropriate positions to properly support the carrier within the casing and to ease installation. The runners shall be mechanically bolted to the riser. The bolt heads are welded to the inside of the risers for strength. Risers shall be made of T-304 stainless steel of a maximum 10 gauge. All risers shall be MIG welded to the shell. Bottom risers 6" and over in height shall be reinforced. All reinforcing plates shall be 10 ga. T-304 stainless steel and shall be MIG welded to mating parts. Standard positioning within the casing pipe shall be sized such that the carrier rests near the bottom of the casing pipe and the height of the risers and runners are to provide a bottom clearance not less than one-half inch between the casing pipe and the extreme outside diameter of the joint bell of the carrier pipe. All welds and metal surfaces shall be chemically passivated.

The cost for casing spacers, filling of the annular space (if required), and furnishing and installing the steel sleeve shall be incidental to the contract unit price for the steel casing. Unless otherwise shown on the plans, steel sleeves [casings] shall be of the size and thickness shown in the table below:

Standard Sizes of Steel Sleeves Used As Casings*

Carrier Pipe ID in Inches	Casing Wall Thickness in Inches	Casing Outside Diameter Inches
42	0.938	66

Method of Measurement and Basis of Payment

The cost of furnishing and installation of the steel sleeve, and all incidental work necessary for its installation, including casing spacers, will be paid for at the contract unit price per FOOT for STEEL CASING [SPECIFIED SIZE]. The cost for storm sewer constructed within the casing will be paid for at its unit price.

BRICK PAVERS

Description: This item shall be in accordance with the special provision, plans, and details. This work consists of providing all equipment, materials and labor necessary to construct a brick paver median on a prepared concrete paver bed, and sand setting bed as specified at the locations marked on the Plans and as directed by the Engineer. Removal of existing median shall be paid for separately.

Paving Patterns: The paving pattern shall be running bond. See plans for paver layout.

1. Brick Pavers

Unilock Series 3000 brick pavers shall be used. Selection shall be approved by the Engineer and City representative.

A. Brick pavers shall be approximately 11.70" x 5.85" x 2.73" in size. Length, width or height of bricks shall not differ by more than 1/16 of an inch from specified dimensions.

B. Paver color will be Mocha Brown.

2. Base

A. Concrete Paver Bed

Concrete base shall be constructed in accordance with Section 420 of the Standard Specifications. Provide weep holes as indicated on the plans. Fill weep holes with clean stone aggregate to drain. The Concrete Paver Bed will be included in the unit cost per sq. ft. BRICK PAVERS.

3. Filter Fabric

Filter Fabric shall be installed on top of the Concrete Paver Bed. Fabric shall be as specified in Section 282. Fabric shall be laid flat without wrinkles or folds, it shall be cut as required to fit around obstacles. Strips of fabric shall overlap 6 inches at the seams. Fabric shall be wrapped up the side face of the concrete curb, plastic paver restraint, concrete trim, utility grates, boxes and poles and sidewalks. Fabric shall extend under the sand setting bed a minimum of 18" from all edges as described above. After installation of the polymeric sand setting bed, the fabric shall be trimmed to 1/2" below finish grade.

4. Protection Layer

The protection layer shall be a Neo-Asphalt Adhesive Bedding. Karnak #237-2% AF Neo-Asphalt (Adhesive).

5. Sand Course

Bedding and joint sand shall be clean, non-plastic, free from deleterious foreign matter. The sand shall be natural or manufactured from the crushed rock. Limestone screenings or stone dust shall not be used. Grading of sand samples for the setting bed shall meet the requirements of Section 1003 for FA 2. Mason sand shall not be used.

6. Paver Joint Material

Paver joint materials shall be Polymeric Sand, or approved equal, clean, and free from deleterious foreign matter. Limestone screenings, stone dust, or plain sand shall not be used.

7. Installation

- A. No paver setting work shall be performed when the underlayment has free moisture, ice, or snow, or when the sand or base materials are frozen.
- B. Sand setting bed shall be spread over the subbase as a setting bed for pavers. Sand shall be spread 1 in. thick and leveled to required slope and grade. Minimum thickness of sand shall be 1 in. after leveling. Bed shall not be compacted until pavers are installed. Surface tolerance shall be within 1/8" in. of required grade.
- C. Place pavers by hand in straight courses with hand tight joints and uniform top surface. Joints between the pavers shall be uniformly 2 to 3 mm wide. Good alignment shall be kept and patterns shall be as shown on plans and details.
- D. Protect the alignment and elevations of the newly laid pavers with plywood sheeting at all times. Advance the plywood as work progresses and maintain plywood protection over all areas subject to movement of materials, workers and equipment.
- E. Pavers shall be cut only when necessary and used in courses as indicated on plans and details. Cutting shall be done with a masonry saw and shall be neat and straight, with no blemishes to the paver's surface. Fill gaps at the inside edge of the soldier course border with cut pavers.
- F. Joints in the underlayment, if any, shall not reflect up through the setting bed and paver system.
- G. Use a low amplitude, high frequency plate vibrator to vibrate the pavers into the sand. Compaction equipment shall have a minimum centrifugal compaction force of 13kN.
- H. The pavers shall be compacted after setting; the sand shall be swept into the dry joints and vibrated until they are full. This will require at least two or three passes with the vibrator.
- I. All work to within 1 yard of the laying face must be left fully compacted with sand filled joints at the completion of each day.
- J. Sweep off excess sand when the job is complete.

- K. The final surface elevations of pavers shall be within 1/8" in. of required grade.
- L. The surface elevation of pavers shall be 1/4" above adjacent drainage inlets, curbs, concrete collars or channels.
- M. After removal of excess sand, check final elevations for conformance to the drawings.

Method of Measurement: Brick Paver shall be measured in place in square feet.

Basis of Payment: Brick pavers shall be paid for at the contract unit price per SQUARE FOOT for BRICK PAVERS which price shall include furnishing all equipment, material and labor necessary to construct the sand course, weed barrier fabric, asphalt base, brick pavers, and sand joints.

TRAFFIC BARRIER TERMINAL, TYPE 1, SPECIAL (FLARED), MODIFIED

This item shall be in accordance with the applicable portions of Section 631 of the Standard Specifications, Highway Standard B.L.R. 23-4, Highway Standard 631026 and the details in the plans.

Basis of Payment: This work shall be paid for at the contract unit price per each for TRAFFIC BARRIER TERMINAL, TYPE 1, SPECIAL (FLARED), MODIFIED which price shall be payment in full for all labor, materials, transportation, handling and incidentals necessary to furnish and install this item.

GENERAL ELECTRICAL REQUIREMENTS

Effective: January 1, 2012

Add the following to Article 801 of the Standard Specifications:

“Maintenance transfer and Preconstruction Inspection:

General. Before performing any excavation, removal, or installation work (electrical or otherwise) at the site, the Contractor shall request a maintenance transfer and preconstruction site inspection, to be held in the presence of the Engineer and a representative of the party or parties responsible for maintenance of any lighting and/or traffic control systems which may be affected by the work. The request for the maintenance transfer and preconstruction inspection shall be made no less than seven (7) calendar days prior to the desired inspection date. The maintenance transfer and preconstruction inspection shall:

Establish the procedures for formal transfer of maintenance responsibility required for the construction period.

Establish the approximate location and operating condition of lighting and/or traffic control systems which may be affected by the work

Marking of Existing Cable Systems. The party responsible for maintenance of any existing lighting and/or traffic control systems at the project site will, at the Contractor's request, mark and/or stake, once per location, all underground cable routes owned or maintained by the State. A project may involve multiple "locations" where separated electrical systems are involved (i.e. different controllers). The markings shall be taken to have a horizontal tolerance of at least 304.8 mm (one (1) foot) to either side. The request for the cable locations and marking shall be made at the same time the request for the maintenance transfer and preconstruction inspection is made. The Contractor shall exercise extreme caution where existing buried cable runs are involved. The markings of existing systems are made strictly for assistance to the Contractor and this does not relieve the Contractor of responsibility for the repair or replacement of any cable run damaged in the course of his work, as specified elsewhere herein. Note that the contractor shall be entitled to only one request for location marking of existing systems and that multiple requests may only be honored at the contractor's expense. No locates will be made after maintenance is transferred, unless it is at the contractor's expense.

Condition of Existing Systems. The Contractor shall conduct an inventory of all existing electrical system equipment within the project limits, which may be affected by the work, making note of any parts which are found broken or missing, defective or malfunctioning. Megger and load readings shall be taken for all existing circuits which will remain in place or be modified. If a circuit is to be taken out in its entirety, then readings do not have to be taken. The inventory and test data shall be reviewed with and approved by the Engineer and a record of the inventory shall be submitted to the Engineer for the record. Without such a record,

all systems transferred to the Contractor for maintenance during construction shall be returned at the end of construction in complete, fully operating condition.”

Add the following to the 1st paragraph of Article 801.05(a) of the Standard Specifications:

“Items from multiple disciplines shall not be combined on a single submittal and transmittal. Items for lighting, signals, surveillance and CCTV must be in separate submittals since they may be reviewed by various personnel in various locations.”

Revise the second sentence of the 5th paragraph of Article 801.05(a) of the Standard Specifications to read:

“The Engineer will stamp the submittals indicating their status as ‘Approved’, ‘Approved as Noted’, ‘Disapproved’, or ‘Information Only’.

Revise the 6th paragraph of Article 801.05(a) of the Standard Specifications to read:

“Resubmittals. All submitted items reviewed and marked ‘Approved as Noted’, or ‘Disapproved’ are to be resubmitted in their entirety with a disposition of previous comments to verify contract compliance at no additional cost to the state unless otherwise indicated within the submittal comments.”

Revise Article 801.11(a) of the Standard Specifications to read:

“Lighting Operation and Maintenance Responsibility. The scope of work shall include the assumption of responsibility for the continuing operation and maintenance the of existing, proposed, temporary, sign and navigation lighting, or other lighting systems and all appurtenances affected by the work as specified elsewhere herein. Maintenance of lighting systems is specified elsewhere and will be paid for separately

“Energy and Demand Charges. The payment of basic energy and demand charges by the electric utility for existing lighting which remains in service will continue as a responsibility of the Owner, unless otherwise indicated. Unless otherwise indicated or required by the Engineer duplicate lighting systems (such as temporary lighting and proposed new lighting) shall not be operated simultaneously at the Owner’s expense and lighting systems shall not be kept in operation during long daytime periods at the Owner’s expense. Upon written authorization from the Engineer to place a proposed new lighting system in service, whether the system has passed final acceptance or not, (such as to allow temporary lighting to be removed), the Owner will accept responsibility for energy and demand charges for such lighting, effective the date of authorization. All other energy and demand payments to the utility shall be the responsibility of the Contractor until final acceptance.”

Add the following to Section 801 of the Standard Specifications:

"Lighting Cable Identification. Each wire installed shall be identified with its complete circuit number at each termination, splice, junction box or other location where the wire is accessible."

"Lighting Cable Fuse Installation. Standard fuse holders shall be used on non-frangible (non-breakaway) light pole installations and quick-disconnect fuse holders shall be used on frangible (breakaway) light pole installations. Wires shall be carefully stripped only as far as needed for connection to the device. Over-stripping shall be avoided. An oxide inhibiting lubricant shall be applied to the wire for minimum connection resistance before the terminals are crimped-on. Crimping shall be performed in accordance with the fuse holder manufacturer's recommendations. The exposed metal connecting portion of the assembly shall be taped with two half-lapped wraps of electrical tape and then covered by the specified insulating boot. The fuse holder shall be installed such that the fuse side is connected to the pole wire (load side) and the receptacle side of the holder is connected to the line side."

Revise the 2nd paragraph of Article 801.16 of the Standard Specifications to read:

"When the work is complete, and seven days before the request for a final inspection, the full-size set of contract drawings. Stamped "RECORD DRAWINGS", shall be submitted to the Engineer for review and approval and shall be stamped with the date and the signature of the Contractor's supervising Engineer or electrician. The record drawings shall be submitted in PDF format on CDROM as well as hardcopy for review and approval. In addition to the record drawings, copies of the final catalog cuts which have been Approved or Approved as Noted shall be submitted in PDF format along with the record drawings. The PDF files shall clearly indicate either by filename or PDF table of contents the respective pay item number. Specific part or model numbers of items which have been selected shall be clearly visible."

Add the following to Article 801.16 of the Standard Specifications:

"In addition to the specified record drawings, the Contactor shall record GPS coordinates of the following electrical components being installed, modified or being affected in other ways by this contract:

- Last light pole on each circuit
- Handholes
- Conduit roadway crossings
- Controllers
- Control Buildings
- Structures with electrical connections, i.e. DMS, lighted signs.

- Electric Service locations
- CCTV Camera installations
- Fiber Optic Splice Locations

Datum to be used shall be North American 1983.

Data shall be provided electronically and in print form. The electronic format shall be compatible with MS Excel. Latitude and Longitude shall be in decimal degrees with a minimum of 6 decimal places. Each coordinate shall have the following information:

1. Description of item
2. Designation or approximate station if the item is undesignated
3. Latitude
4. Longitude

Examples:

Equipment Description	Equipment Designation	Latitude	Longitude
CCTV Camera pole	ST42	41.580493	87.793378
FO mainline splice handhole	HHL-ST31	41.558532	87.792571
Handhole	HH at STA 234+35	41.765532	87.543571
Electric Service	Elec Srv	41.602248	87.794053
Conduit crossing	SB IL83 to EB I290 ramp SIDE A	41.584593	87.793378
Conduit crossing	SB IL83 to EB I290 ramp SIDE B	41.584600	87.793432
Light Pole	DA03	41.558532	87.792571
Lighting Controller	X	41.651848	87.762053
Sign Structure	FGD	41.580493	87.793378

Video Collection-Point	VCP-IK	41.558 532	- 87.78977 1
Fiber splice connection	Toll Plaza34	41.606 928	- 87.79405 3

Prior to the collection of data, the contractor shall provide a sample data collection of at least six data points of known locations to be reviewed and verified by the Engineer to be accurate within 100 feet. Upon verification, data collection can begin. Data collection can be made as construction progresses, or can be collected after all items are installed. If the data is unacceptable the contractor shall make corrections to the data collection equipment and or process and submit the data for review and approval as specified.

Accuracy. Data collected is to be mapping grade. A handheld mapping grade GPS device shall be used for the data collection. The receiver shall support differential correction and data shall have a minimum 5 meter accuracy after post processing.

GPS receivers integrated into cellular communication devices, recreational and automotive GPS devices are not acceptable.

The GPS shall be the product of an established major GPS manufacturer having been in the business for a minimum of 6 years.”

Luminaire

Add the following to Article 1067(h) of the Standard Specifications:

“Independent Testing. Independent testing of luminaires shall be required whenever the pay item quantity of luminaires of a given pay item, as indicated on the plans, is 50 or more. For each luminaire type to be so tested, one luminaire plus one luminaire for each 50 luminaires shall be tested. Example: *A plan pay item quantity of 75 luminaires for a specific pay item would dictate that 2 be tested; 135 luminaires would dictate that three be tested.*” If the luminaire performance table is missing from the contract documents, the luminaire(s) shall be tested and the test results shall be evaluated against the manufacturer’s data as provided in the approved material submittal. The test luminaire(s) results shall be equal to or better than the published data. If the test results indicated performance not meeting the published data, the test luminaire will be designated as failed and corrective action as described herein shall be performed.

The Contractor shall be responsible for all costs associated with the specified testing, including but not limited to shipping, travel and lodging costs as well as the

costs of the tests themselves, all as part of the bid unit price for this item. Travel, lodging and other associated costs for travel by the Engineer shall be direct-billed to or shall be pre-paid by the Contractor, requiring no direct reimbursement to the Engineer or the independent witness, as applicable”

The Contractor shall select one of the following options for the required testing with the Engineer's approval:

- a. Engineer Factory Selection for Independent Lab: The Contractor may select this option if the luminaire manufacturing facility is within the state of Illinois. The Contractor shall propose an independent test laboratory for approval by the Engineer. The selected luminaires shall be marked by the Engineer and shipped to the independent laboratory for tests.
- b. Engineer Witness of Independent Lab Test: The Contractor may select this option if the independent testing laboratory is within the state of Illinois. The Engineer shall select, from the project luminaires at the manufacturer's facility or at the Contractor's storage facility, luminaires for testing by the independent laboratory.
- c. Independent Witness of Manufacturer Testing: The independent witness shall select from the project luminaires at the manufacturers facility or at the Contractor's storage facility, the luminaires for testing. The Contractor shall propose a qualified independent agent, familiar with the luminaire requirements and test procedures, for approval by the Engineer, to witness the required tests as performed by the luminaire manufacturer.

The independent witness shall as a minimum meet the following requirements:

- ▶ Have been involved with roadway lighting design for at least 15 years.
- ▶ Not have been the employee of a luminaire or ballast manufacturer within the last 5 years.
- ▶ Not associated in any way (plan preparation, construction or supply) with the particular project being tested.
- ▶ Be a member of IESNA in good standing.
- ▶ Provide a list of professional references.

This list is not an all-inclusive list and the Engineer will make the final determination as to the acceptability of the proposed independent witness.

- d. Should any of the tested luminaires fail to satisfy the specifications and perform according to approved submittal information, the luminaire shall be unacceptable and be replaced by alternate equipment meeting the specifications with the submittal and testing process repeated in their entirety; or corrections made to achieve required performance. In the case of corrections, the Contractor shall advise the Engineer of corrections made and shall request a repeat of the specified testing and, if the corrections are

deemed reasonable by the Engineer, the testing process shall be repeated. The number of luminaires to be tested shall be the same quantity as originally tested; i.e. if three luminaires were tested originally, one, two or three failed, another three must be tested after corrective action is taken.

Add the following table(s) to Article 1067 of the Standard Specifications:

IDOT DISTRICT 1 LUMINAIRE PERFORMANCE TABLE

GIVEN CONDITIONS		
ROADWAY DATA	Pavement Width	52 (ft)
	Number of Lanes	4
	I.E.S. Surface Classification	R3
	Q-Zero Value	.07
LIGHT POLE DATA	Mounting Height	35 (ft)
	Mast Arm Length	12 (ft)
	Pole Set-Back From Edge of Pavement	9 (ft)
LUMINAIRE DATA	Lamp Type	LED
	Lamp Lumens	12,000
	I.E.S. Vertical Distribution	Medium
	I.E.S. Control Of Distribution	Cutoff
	I.E.S. Lateral Distribution	Type III
	Total Light Loss Factor	.75
LAYOUT DATA	Spacing	175 (ft)
	Configuration	Opposed
	Luminaire Overhang over edge of pavement	None

NOTE: Variations from the above specified I.E.S. distribution pattern may be requested and acceptance of variations will be subject to review by the Engineer based on how well the performance requirements are met.

PERFORMANCE REQUIREMENTS		
--------------------------	--	--

NOTE: These performance requirements shall be the minimum acceptable standards of photometric performance for the luminaire, based on the given conditions listed above.

LUMINANCE	Average Luminance, L_{AVE}	0.6 Cd/m ²
	Uniformity Ratio, L_{AVE}/L_{MIN}	4.0 (Max)
	Uniformity Ratio, L_{MAX}/L_{MIN}	6.0 (Max)
	Veiling Luminance Ratio, L_V/L_{AVE}	0.4 (Max)

Underground Raceways
Effective: January 1, 2012

Revise Article 810.04 of the Standard Specifications to read:

"Installation. All underground conduit shall have a minimum depth of 30-inches (700 mm) below the finished grade."

Add the following to Article 810.04 of the Standard Specifications:

"All metal conduit installed underground shall be Rigid Steel Conduit unless otherwise indicated on the plans."

Add the following to Article 810.04 of the Standard Specifications:

"All raceways which extend outside of a structure or duct bank but are not terminated in a cabinet, junction box, pull box, handhole, post, pole, or pedestal shall extend a minimum of 300 mm (12") or the length shown on the plans beyond the structure or duct bank. The end of this extension shall be capped and sealed with a cap designed for the conduit to be capped. The ends of rigid metal conduit to be capped shall be threaded, the threads protected with full galvanizing, and capped with a threaded galvanized steel cap. The ends of rigid nonmetallic conduit and coilable nonmetallic conduit shall be capped with a rigid PVC cap of not less than 3 mm (0.125") thick. The cap shall be sealed to the conduit using a room-temperature-vulcanizing (RTV) sealant compatible with the material of both the cap and the conduit. A washer or similar metal ring shall be glued to the inside center of the cap with epoxy, and the pull cord shall be tied to this ring."

Add the following to Article 810.04(c) of the Standard Specifications:

"Coilable non-metallic conduit shall be machine straightened to remove the longitudinal curvature caused by coiling the conduit onto reels prior to installing in trench, encasing in concrete or embedding in structure. The straightening shall not deform the cross-section of the conduit such that any two measured outside diameters, each from any location and at any orientation around the longitudinal axis along the conduit differ by more than 6 mm (0.25)". The longitudinal axis of the straightened conduit shall not deviate by more than 20 mm per meter (0.25" per foot" from a straight line. The HDPE and straightening mechanism manufacturer operating temperatures shall be followed.

Wire and Cable

Effective: January 1, 2012

Add the following to the first paragraph of Article 1066.02(a):

“The cable shall be rated at a minimum of 90°C dry and 75°C wet and shall be suitable for installation in wet and dry locations, and shall be resistant to oils and chemicals.”

Revise the Aerial Electric Cable Properties table of Article 1066.03(a)(3) to read:

Aerial Electric Cable Properties

Phase Conductor		Messenger wire			
Size AWG	Stranding	Average Insulation Thickness		Minimum Size AWG	Stranding
		mm	mils		
6	7	1.1	(45)	6	6/1
4	7	1.1	(45)	4	6/1
2	7	1.1	(45)	2	6/1
1/0	19	1.5	(60)	1/0	6/1
2/0	19	1.5	(60)	2/0	6/1
3/0	19	1.5	(60)	3/0	6/1
4/0	19	1.5	(60)	4/0	6/1

Add the following to Article 1066.03(b) of the Standard Specifications:

“Cable sized No. 2 AWG and smaller shall be U.L. listed Type RHH/RHW and may be Type RHH/RHW/USE. Cable sized larger than No. 2 AWG shall be U.L. listed Type RHH/RHW/USE.”

Revise Article 1066.04 to read:

“Aerial Cable Assembly. The aerial cable shall be an assembly of insulated aluminum conductors according to Section 1066.02 and 1066.03. Unless otherwise indicated, the cable assembly shall be composed of three insulated conductors and a steel reinforced bare aluminum conductor (ACSR) to be used as the ground conductor. Unless otherwise indicated, the code word designation of this cable assembly is “Palomino”. The steel reinforced aluminum conductor

shall conform to ASTM B-232. The cable shall be assembled according to ANSI/ICEA S-76-474.”

Revise the second paragraph of Article 1066.05 to read:

“The tape shall have reinforced metallic detection capabilities consisting of a woven reinforced polyethylene tape with a metallic core or backing.”

ELECTRIC UTILITY SERVICE CONNECTION (COMED)

Effective: January 1, 2012

Description. This item shall consist of payment for work performed by ComEd in providing or modifying electric service as indicated. THIS MAY INVOLVE WORK AT MORE THAN ONE ELECTRIC SERVICE. For summary of the Electrical Service Drop Locations see the schedule contained elsewhere herein.

CONSTRUCTION REQUIREMENTS

General. It shall be the Contractor's responsibility to contact ComEd. The Contractor shall coordinate his work fully with the ComEd both as to the work required and the timing of the installation. No additional compensation will be granted under this or any other item for extra work caused by failure to meet this requirement. Please contact ComEd, New Business Center Call Center, at 866 NEW ELECTRIC (1-866-639-3532) to begin the service connection process. The Call Center Representatives will create a work order for the service connection. The representative will ask the requestor for information specific to the request. The representative will assign the request based upon the location of project.

The Contractor should make particular note of the need for the earliest attention to arrangements with ComEd for service. In the event of delay by ComEd, no extension of time will be considered applicable for the delay unless the Contractor can produce written evidence of a request for electric service within 30 days of execution.

Method Of Payment. The Contractor will be reimbursed to the exact amount of money as billed by ComEd for its services. Work provided by the Contractor for electric service will be paid separately as described under ELECTRIC SERVICE INSTALLATION. No extra compensation shall be paid to the Contractor for any incidental materials and labor required to fulfill the requirements as shown on the plans and specified herein.

For bidding purposes, this item shall be estimated as \$3,000.00

Basis Of Payment. This work will be paid for at the contract lump sum price for ELECTRIC UTILITY SERVICE CONNECTION which shall be reimbursement in full for electric utility service charges.

ELECTRIC SERVICE INSTALLATION

Effective: January 1, 2012

Description. This item shall consist of all material and labor required to extend, connect or modify the electric services, as indicated or specified, which is over and above the work performed by the utility. Unless otherwise indicated, the cost for the utility work, if any, will be reimbursed to the Contractor separately under ELECTRIC UTILITY SERVICE CONNECTION. This item may apply to the work at more than one service location and each will be paid separately.

Materials. Materials shall be in accordance with the Standard Specifications.

CONSTRUCTION REQUIREMENTS

General. The Contractor shall ascertain the work being provided by the electric utility and shall provide all additional material and work not included by other contract pay items required to complete the electric service work in complete compliance with the requirements of the utility.

No additional compensation will be allowed for work required for the electric service, even though not explicitly shown on the Drawings or specified herein

Method Of Measurement. Electric Service Installation shall be counted, each.

Basis Of Payment. This work will be paid for at the contract unit price each for ELECTRIC SERVICE INSTALLATION which shall be payment in full for the work specified herein.

LIGHT FIXTURE ASSEMBLY – TYPE A

Description: This work shall consist of furnishing and installing complete lighting units including luminaires, arms, pole, lamps, receptacle, splices, fuses, fuse holders, and wiring in accordance with the applicable portions of Sections 821, 830, 1065, 1066 and 1067 of the Standard Specifications, manufacturer's specifications, and the details in the plans. The material for the pole, banner arms, flag holders, final, mast arm and support arm shall be steel in accordance with the manufacturer specifications and applicable portions of article 1069.03 of the Standard Specifications for Galvanized steel poles except that the pole shall not be galvanized. Base plate shall be AASHTO M 270 Grade 50 or 50S (M 270M Grade 345 or 345S).

Pole shall be steel, asymmetrical fluted and tapered with standard intricacies to emulate the look as shown on the drawings and in conformance with the pole models provided below. Pole shall have FHWA and AASHTO approved decorative break-away clamshell base. Pole shall have hand hole for accessing fuses and wiring. Straight pipe arm shall be mounted to pole top tenon. Pole assembly shall be UL Listed for the intended purpose.

The mounting height of the roadway luminaire shall be 35-feet above top of pavement ± 0.75 -feet. Pole height shall be determined by the manufacturer considering concrete foundation dimensions (including breakaway devices) and arm dimensions.

Pole Assembly Manufacturers/Models may be selected from the following:

Valmont Type: VALS 35/ 12LA 4W – FLAG-BANNER-FNC-ALAHAMBRA-FINIAL-FHWA HUNTINGTON BASE BKYCPLG-1 805 COA 573A BLK.

Spring City Type: LTPS350012F- 1FH13PMB – BANAQTCSTSG- HUNT083540-4VBC7-10 COUPLING RALBLK.

Cyclone Lighting Type: PV69-35-SA-BM36-RALXXXXTX -M533-C1-CP3854-T556-RALXXXXTX –CLAM SHELL 1" X 36" (33+3).

Luminaires shall operate on 120VAC. Luminaires shall be water-tight with 100 mph winds. Manufacturer shall guarantee that no water will build up in the assemblies and provide a 5-year warrantee for field service and factory modifications as necessary to correct water problems if such should develop.

Roadway luminaires shall be LED with 4000K color temperature. Nominal fixture input power shall be 150W. Distribution shall be Cut-Off Type III. Luminaires shall be UL Listed for the intended purpose and be listed Wet Location.

Roadway Luminaire Manufacturers/Models may be selected from the following:

American Electric Lighting Type: Autobahn ATB2-60LEDE70-MVOLT-R3 with specified options.

Beacon Type: VP-L-64NB-135-4K-T3-UNV with specified options.

General Electric Type: Evolve ERS3-0-LXEX-540 with specified options.

Each exposed component of the lighting unit shall be coated with custom color powder coat. The entire surface of the coating for each component shall be tested according to ASTM standards. Provide color chip samples for Owner's selection process.

Basis of Payment: This work will be paid for at the contract unit price each for LIGHT FIXTURE ASSEMBLY – TYPE A.

LIGHT FIXTURE ASSEMBLY – TYPE B

Description: This work shall consist of furnishing and installing complete lighting units including luminaires, arms, pole, lamps, splices, fuses, fuse holders, and wiring in accordance with the applicable portions of Sections 821, 830, 1065, 1066 and 1067 of the Standard Specifications, manufacturer's specifications, and the details in the plans. The material for the pole, banner arms, flag holders, final, decorative nut covers, mast arm and support arm shall be steel in accordance with the manufacturer specifications and applicable portions of article 1069.03 of the Standard Specifications for Galvanized steel poles except that the pole shall not

be galvanized. Base plate and leveling plate shall be AASHTO M 270 Grade 50 or 50S (M 270M Grade 345 or 345S).

Pole shall be steel, asymmetrical fluted and tapered with standard intricacies to emulate the look as shown on the drawings and in conformance with the pole models provided below. Pole shall have decorative nut covers. Pole shall have hand hole for accessing fuses and wiring. Straight pipe arm shall be mounted to pole top tenon. Pole assembly shall be UL Listed for the intended purpose.

The mounting height of the roadway luminaire shall be 35-feet above top of pavement ± 0.75 -feet. Pole height shall be determined by the manufacturer considering mounting on elevated structure of the bridge and arm dimensions. The decorative nut covers, flag holders and banner arms shall conform to the details in the plans and the manufacturer's specifications.

Pole Assembly Manufacturers/Models may be selected from the following:

Valmont Type: VALS 35/ 12LA 4W – FLAG-BANNER-FNC-ALAHAMBRA-FINIAL-DECO NUT COVERS 805 COA 573A BLK.

Spring City Type: LTPS350012F-1FH13PMB – BANAQTCSTSG-L-NC RALBLK.

Cyclone Lighting Type: PV69-35-SA-BM36-RALXXXTX -M533-C1-CP3854-T556-RALXXXTX.

Luminaires shall operate on 120VAC. Luminaires shall be water-tight with 100 mph winds. Manufacturer shall guarantee that no water will build up in the assemblies and provide a 5-year warrantee for field service and factory modifications as necessary to correct water problems if such should develop.

Roadway luminaires shall be LED with 4000K color temperature. Nominal fixture input power shall be 150W. Distribution shall be Cut-Off Type III. Luminaires shall be UL Listed for the intended purpose and be listed Wet Location.

Roadway Luminaire Manufacturers/Models may be selected from the following:

American Electric Lighting Type: Autobahn ATB2-60LEDE70-MVOLT-R3 with specified options.

Beacon Type: VP-L-64NB-135-4K-T3-UNV with specified options.

General Electric Type: Evolve ERS3-0-LXEX-540 with specified options.

Each exposed component of the lighting unit shall be coated with custom color powder coat. The entire surface of the coating for each component shall be tested according to ASTM standards. Provide color chip samples for Owner's selection process.

Basis of Payment: This work will be paid for at the contract unit price each for LIGHT FIXTURE ASSEMBLY – TYPE B.

MAINTENANCE OF LIGHTING SYSTEMS

Replace Article 801.11 and 801.12 of the Standard Specifications with the following:

Effective the date the Contractor's activities (electrical or otherwise) at the job site begin, the Contractor shall be responsible for the proper operation and maintenance of all existing and proposed lighting systems which are part of, or which may be affected by the work until final acceptance or as otherwise determined by the Engineer.

Before performing any excavation, removal, or installation work (electrical or otherwise) at the site, the Contractor shall initiate a request for a maintenance transfer and preconstruction inspection, as specified elsewhere herein, to be held in the presence of the Engineer and a representative of the party or parties responsible for maintenance of any lighting systems which may be affected by the work. The request for the maintenance preconstruction inspection shall be made no less than seven (7) calendar days prior to the desired inspection date.

Existing lighting systems, when depicted on the plans, are intended only to indicate the general equipment installation of the systems involved and shall not be construed as an exact representation of the field conditions. It remains the Contractor's responsibility to visit the site to confirm and ascertain the exact condition of the electrical equipment and systems to be maintained.

Maintenance of Existing Lighting Systems

Existing lighting systems. Existing lighting systems shall be defined as any lighting system or part of a lighting system in service at the time of contract Letting. The contract drawings indicate the general extent of any existing lighting, but whether indicated or not, it remains the Contractor's responsibility to ascertain the extent of effort required for compliance with these specifications and failure to do so will not be justification for extra payment or reduced responsibilities.

Extent of Maintenance.

Partial Maintenance. Unless otherwise indicated, if the number of circuits affected by the contract is equal to or less than 40% of the total number of circuits in a given controller and the controller is not part of the contract work, the Contractor needs only to maintain the affected circuits. The affected circuits shall be isolated by means of in-line waterproof fuse holders as specified elsewhere and as approved by the Engineer.

Full Maintenance. If the number of circuits affected by the contract is greater than 40% of the total number of circuits in a given controller, or if the controller is modified in any way under the contract work, the Contractor shall maintain the entire controller and all associated circuits.

Maintenance of Proposed Lighting Systems

Proposed Lighting Systems. Proposed lighting systems shall be defined as any lighting system or part of a lighting system, temporary or permanent, which is to be constructed under this contract.

The Contractor shall be fully responsible for maintenance of all items installed under this contract. Maintenance shall include, but not be limited to, any equipment failures or malfunctions as well as equipment damage either by the motoring public, Contractor operations, vandalism, or other means. The potential cost of replacing or repairing any malfunctioning, damaged, or vandalized equipment shall be included in the bid price of this item and will not be paid for separately.

Lighting System Maintenance Operations

The Contractor's responsibility shall include all applicable responsibilities of the Electrical Maintenance Contract, State of Illinois, Department of Transportation, Division of Highways, District One. These responsibilities shall include the maintenance of lighting units (including sign lighting), cable runs and lighting controls. In the case of a pole knockdown or sign light damage, the Contractor shall promptly clear the lighting unit and circuit discontinuity and restore the system to service. The equipment shall then be re-set by the contractor within the time limits specified herein.

If the equipment damaged by normal vehicular traffic, not contractor operations, is beyond repair and cannot be re-set, the contractor shall replace the equipment in kind with payment made for such equipment under Article 109.04. If the equipment damaged by any construction operations, not normal vehicular traffic, is beyond repair and cannot be re-set, the contractor shall replace the equipment in kind and the cost of the equipment shall be included in the cost of this pay item and shall not be paid for separately.

Responsibilities shall also include weekly night-time patrol of the lighting system, with patrol reports filed immediately with the Engineer and with deficiencies corrected within 24 hours of the patrol. Patrol reports shall be presented on standard forms as designated by the Engineer. Uncorrected deficiencies may be designated by the Engineer as necessitating emergency repairs as described elsewhere herein.

The following chart lists the maximum response, service restoration, and permanent repair time the Contractor will be allowed to perform corrective action on specific lighting system equipment.

INCIDENT OR PROBLEM	SERVICE RESPONSE TIME	SERVICE RESTORATION TIME	PERMANENT REPAIR TIME
Control cabinet out	1 hour	4 hours	7 Calendar days
Hanging mast arm	1 hour to clear	na	7 Calendar days
Radio problem	1 hour	4 hours	7 Calendar

			days
Motorist caused damage or leaning light pole 10 degrees or more	1 hour to clear	4 hours	7 Calendar days
Circuit out – Needs to reset breaker	1 hour	4 hours	na
Circuit out – Cable trouble	1 hour	24 hours	21 Calendar days
Outage of 3 or more successive lights	1 hour	4 hours	na
Outage of 75% of lights on one tower	1 hour	4 hours	na
Outage of light nearest RR crossing approach, Islands and gores	1 hour	4 hours	na
Outage (single or multiple) found on night outage survey or reported to EMC	na	na	7 Calendar days
Navigation light outage	na	na	24 hours

- **Service Response Time** -- amount of time from the initial notification to the Contractor until a patrolman physically arrives at the location.
- **Service Restoration Time** – amount of time from the initial notification to the Contractor until the time the system is fully operational again (In cases of motorist caused damage the undamaged portions of the system are operational.)
- **Permanent Repair Time** – amount of time from initial notification to the Contractor until the time permanent repairs are made if the Contractor was required to make temporary repairs to meet the service restoration requirement.

Failure to provide this service will result in liquidated damages of \$500 per day per occurrence. In addition, the Department reserves the right to assign any work not completed within this timeframe to the Electrical Maintenance Contractor. All costs associated to repair this uncompleted work shall be the responsibility of the Contractor. Failure to pay these costs to the Electrical Maintenance Contractor within one month after the incident will result in additional liquidated damages of \$500 per month per occurrence. Unpaid bills will be deducted from any monies owed to the Contractor. Repeated failures and/or a gross failure of maintenance shall result in the State’s Electrical Maintenance Contractor being directed to correct all deficiencies and the resulting costs deducted from any monies owed the contractor.

Damage caused by the Contractor’s operations shall be repaired at no additional cost to the Contract.

Operation of Lighting

The lighting shall be operational every night, dusk to dawn when the roadway is open to traffic. Duplicate lighting systems (such as temporary lighting and proposed new lighting) shall not be

operated simultaneously. Lighting systems shall not be kept in operation during long daytime periods. It shall be the responsibility of the Contractor to provide connection of the new lighting on the reconstructed bridge to the existing lighting on the existing bridge over the winter shutdown (if applicable). All cost of the connection shall be included in the item MAINTENANCE OF LIGHTING SYSTEM.

Method of Measurement

The contractor shall demonstrate to the satisfaction of the Engineer that the lighting system is fully operational prior to submitting a pay request. Failure to do so will be grounds for denying the pay request. Months in which the lighting systems are not maintained and not operational will not be paid for. Payment shall not be made retroactively for months in which lighting systems were not operational.

Basis of Payment. Maintenance of lighting systems shall be paid for at the contract unit price per calendar month for **MAINTENANCE OF LIGHTING SYSTEM**, which shall include all work as described herein.

TRAFFIC SIGNAL SPECIFICATIONS

Effective: May 22, 2002

Revised: January 1, 2012

These Traffic Signal Special Provisions and the "District One Standard Traffic Signal Design Details" supplement the requirements of the State of Illinois "Standard Specifications for Road and Bridge Construction." The intent of these Special Provisions is to prescribe the materials and construction methods commonly used for traffic signal installations. All material furnished shall be new. The locations and the details of all installations shall be as indicated on the Plans or as directed by the Engineer. Traffic signal construction and maintenance work shall be performed by personnel holding IMSA Traffic Signal Technician Level II certification. The work to be done under this contract consists of furnishing and installing all traffic signal work as specified in the Plans and as specified herein in a manner acceptable and approved by the Engineer.

SECTION 720 SIGNING

MAST ARM SIGN PANELS

Add the following to Article 720.02 of the Standard Specifications:

Signs attached to poles or posts (such as mast arm signs) shall have mounting brackets and sign channels which are equal to and completely interchangeable with those used by the District Sign Shops. Signfix Aluminum Channel Framing System is currently recommended, but other brands of mounting hardware are acceptable based upon the Department's approval.

DIVISION 800 ELECTRICAL

SUBMITTALS.

Revise Article 801.05 of the Standard Specifications to read:

All material approval requests shall be submitted in accordance with the District's current Electrical Product Data and Documentation Submittal Guidelines. General requirements include:

1. Material approval requests shall be made at the preconstruction meeting,

including major traffic signal items listed in the table in Article 801.05. Material or equipment which is similar or identical shall be the product of the same manufacturer, unless necessary for system continuity. Traffic signal materials and equipment shall bear the U.L. label whenever such labeling is available.

2. Product data and shop drawings shall be assembled by pay item and separated from of other pay item submittals. Only the top sheet of each pay item submittal will be stamped by the Department with the review status, except shop drawings for mast arm pole assemblies and the like will be stamped with the review status on each sheet.
3. Partial or incomplete submittals will be returned without review.
4. Certain non-standard mast arm poles and structures will require additional review from IDOT's Central Office. Examples include ornamental/decorative and non-standard length mast arm pole assemblies. The Contractor shall account for the additional review time in his schedule.
5. The contract number or permit number, project location/limits and corresponding pay code number must be on each sheet of correspondence,, catalog cuts and mast arm poles and assemblies drawings.
6. Where certifications and/or warranties are specified, the information submitted for approval shall include certifications and warranties. Certifications involving inspections, and/or tests of material shall be complete with all test data, dates, and times.
7. After the Engineer reviews the submittals for conformance with the design concept of the project, the Engineer will stamp the drawings indicating their status as 'Approved', 'Approved-As-Noted', 'Disapproved', or 'Incomplete'. Since the Engineer's review is for conformance with the design concept only, it is the Contractor's responsibility to coordinate the various items into a working system as specified. The Contractor shall not be relieved from responsibility for errors or omissions in the shop, working, layout drawings, or other documents by the Department's approval thereof. The Contractor must still be in full compliance with contract and specification requirements.
8. All submitted items reviewed and marked 'APPROVED AS NOTED', 'DISAPPROVED', or 'INCOMPLETE' are to be resubmitted in their entirety, unless otherwise indicated within the submittal comments, with a disposition of previous comments to verify contract compliance at no additional cost to the contract.
9. Exceptions to and deviations from the requirements of the Contract Documents will not be allowed. It is the Contractor's responsibility to note any deviations from Contract requirements at the time of submittal and to make any requests for deviations in writing to the Engineer. In general, substitutions will not be acceptable. Requests for substitutions must demonstrate that the proposed substitution is superior to the material or equipment required by the Contract Documents. No exceptions, deviations or substitutions will be permitted without the approval of the Engineer.

INSPECTION OF ELECTRICAL SYSTEMS.

Add the following to Article 801.10 of the Standard Specifications:

(c) All cabinets including temporary traffic signal cabinets shall be assembled by an approved equipment supplier in District One. The Department reserves the right to request any controller and cabinet to be tested at the equipment supplier facilities prior to field installation, at no extra cost to this contract.

MAINTENANCE AND RESPONSIBILITY.

Revise Article 801.11 of the Standard Specifications to read:

- a. Existing traffic signal installations and/or any electrical facilities at all or various locations may be altered or reconstructed totally or partially as part of the work on this Contract. The Contractor is hereby advised that all traffic control equipment, presently installed at these locations, may be the property of the State of Illinois, Department of Transportation, Division of Highways, County, Private Developer, or the Municipality in which they are located. Once the Contractor has begun any work on any portion of the project, all traffic signals within the limits of this contract or those which have the item "Maintenance of Existing Traffic Signal Installation," "Temporary Traffic Signal Installation(s)" and/or "Maintenance of Existing Flashing Beacon Installation," shall become the full responsibility of the Contractor. Automatic Traffic Enforcement equipment is not owned by the State and the Contractor shall not be responsible for maintaining it during construction. The Contractor shall supply the Engineer, Area Traffic Signal Maintenance and Operations Engineer, IDOT ComCenter and the Department's Electrical Maintenance Contractor with two 24-hour emergency contact names and telephone numbers.
- b. When the project has a pay item for "Maintenance of Existing Traffic Signal Installation," "Temporary Traffic Signal Installation(s)" and/or "Maintenance of Existing Flashing Beacon Installation," the Contractor must notify both the Area Traffic Signal Maintenance and Operations Engineer at (847) 705-4424 and the Department's Electrical Maintenance Contractor, of their intent to begin any physical construction work on the Contract or any portion thereof. This notification must be made a minimum of seven (7) working days prior to the start of construction to allow sufficient time for inspection of the existing traffic signal installation(s) and transfer of maintenance to the Contractor. If work is started prior to an inspection, maintenance of the traffic signal installation(s) will be transferred to the Contractor without an inspection. The Contractor will become responsible for repairing or replacing all equipment that is not operating properly or is damaged at no cost to the owner of the traffic signal. Final repairs or replacement of damaged equipment must meet the approval of the Engineer prior to or at the time of final inspection otherwise the traffic signal installation will not be accepted.
- c. Contracts such as pavement grinding or patching which result in the destruction of traffic signal loops do not require maintenance transfer, but require a notification of

intent to work and an inspection. A minimum of seven (7) working days prior to the loop removal, the Contractor shall notify the Area Traffic Signal Maintenance and Operations Engineer at (847) 705-4424 and the Department's Electrical Maintenance Contractor, at which time arrangements will be made to adjust the traffic controller timing to compensate for the absence of detection. Damaged Automatic Traffic Enforcement equipment, including cameras, detectors, or other peripheral equipment, shall be replaced by others, per Permit agreement, at no cost to the contract. See additional requirements in these specifications under Inductive Loop Detector.

- d. The Contractor is advised that the existing and/or temporary traffic signal installation must remain in operation during all construction stages, except for the most essential down time. Any shutdown of the traffic signal installation, which exceeds fifteen (15) minutes, must have prior approval of the Engineer. Approval to shutdown the traffic signal installation will only be granted during the period extending from 10:00 a.m. to 3:00 p.m. on weekdays. Shutdowns shall not be allowed during inclement weather or holiday periods.
- e. The Contractor shall be fully responsible for the safe and efficient operation of the traffic signals. Any inquiry, complaint or request by the Department, the Department's Electrical Maintenance Contractor or the public, shall be investigated and repairs begun within one hour. Failure to provide this service will result in liquidated damages of \$500 per day per occurrence. In addition, the Department reserves the right to assign any work not completed within this timeframe to the Electrical Maintenance Contractor. All costs associated to repair this uncompleted work shall be the responsibility of the Contractor. Failure to pay these costs to the Electrical Maintenance Contractor within one month after the incident will result in additional liquidated damages of \$500 per month per occurrence. Unpaid bills will be deducted from the cost of the Contract. The District's Electrical Maintenance Contractor may inspect any signaling device on the Department's highway system at any time without notification.
- f. Any proposed activity in the vicinity of a highway-rail grade crossing must adhere to the guidelines set forth in the current edition of the Manual on Uniform Traffic Control Devices (MUTCD) regarding work in temporary traffic control zones in the vicinity of highway-rail grade crossings which states that lane restrictions, flagging, or other operations shall not create conditions where vehicles can be queued across the railroad tracks. If the queuing of vehicles across the tracks cannot be avoided, a uniformed law enforcement officer or flagger shall be provided at the crossing to prevent vehicles from stopping on the tracks, even if automatic warning devices are in place.

DAMAGE TO TRAFFIC SIGNAL SYSTEM.

Add the following to Article 801.12(b) of the Standard Specifications to read:

Any traffic signal control equipment damaged or not operating properly from any cause

whatsoever shall be replaced with new equipment meeting current District One traffic signal specifications and provided by the Contractor at no additional cost to the Contract and/or owner of the traffic signal system, all as approved by the Engineer. Final replacement of damaged equipment must meet the approval of the Engineer prior to or at the time of final inspection otherwise the traffic signal installation will not be accepted. Cable splices outside the controller cabinet shall not be allowed.

Automatic Traffic Enforcement equipment, such as Red Light Enforcement cameras, detectors, and peripheral equipment, damaged or not operating properly from any cause whatsoever, shall be the responsibility of the municipality or the Automatic Traffic Enforcement company per Permit agreement.

TRAFFIC SIGNAL INSPECTION (TURN-ON).

Revise Article 801.15(b) of the Standard Specifications to read:

It is the intent to have all electric work completed and equipment field tested by the vendor prior to the Department's "turn-on" field inspection. If in the event the Engineer determines work is not complete and the inspection will require more than two (2) hours to complete, the inspection shall be canceled and the Contractor will be required to reschedule at another date. The maintenance of the traffic signals will not be accepted until all punch list work is corrected and re-inspected.

When the road is open to traffic, except as otherwise provided in Section 850 of the Standard Specifications, the Contractor may request a turn-on and inspection of the completed traffic signal installation at each separate location. This request must be made to the Area Traffic Signal Maintenance and Operations Engineer at (847) 705-4424 a minimum of seven (7) working days prior to the time of the requested inspection. The Department will not grant a field inspection until notification is provided from the Contractor that the equipment has been field tested and the intersection is operating according to Contract requirements. The Department's facsimile number is (847) 705-4089. The Contractor must invite local fire department personnel to the turn-on when Emergency Vehicle Preemption (EVP) is included in the project. When the contract includes the item RE-OPTIMIZE TRAFFIC SIGNAL SYSTEM, OPTIMIZE TRAFFIC SIGNAL SYSTEM, or TEMPORARY TRAFFIC SIGNAL TIMINGS, the Contractor must notify the SCAT Consultant of the turn-on/detour implementation schedule, as well as stage changes and phase changes during construction.

The Contractor must have all traffic signal work completed and the electrical service installation connected by the utility company prior to requesting an inspection and turn-on of the traffic signal installation. The Contractor shall be responsible to provide a police officer to direct traffic at the time of testing.

The Contractor shall provide a representative from the control equipment vendor's office to attend the traffic signal inspection for both permanent and temporary traffic signal turn-ons. Upon demonstration that the signals are operating and all work is completed in accordance with the Contract and to the satisfaction of the Engineer, the Engineer will then allow the signals to be placed in continuous operation. The Agency that is responsible for the maintenance of each traffic signal installation will assume the maintenance upon successful completion of this

inspection.

The District requires the following from the Contractor at traffic signal turn-ons.

1. One set of signal plans of record with field revisions marked in red ink.
2. Written notification from the Contractor and the equipment vendor of satisfactory field testing.
3. A knowledgeable representative of the controller equipment supplier shall be required at the traffic signal turn-on. The representative shall be knowledgeable of the cabinet design and controller functions.
4. A copy of the approved material letter.
5. One (1) copy of the operation and service manuals of the signal controller and associated control equipment.
6. Five (5) copies 11" x 17" (280 mm X 430 mm) of the cabinet wiring diagrams.
7. The controller manufacturer shall supply a printed form, not to exceed 11" x 17" (280 mm X 430 mm) for recording the traffic signal controller's timings; backup timings; coordination splits, offsets, and cycles; TBC Time of Day, Week and Year Programs; Traffic Responsive Program, Detector Phase Assignment, Type and Detector Switching; and any other functions programmable from the keyboard. The form shall include a location, date, manufacturer's name, controller model and software version. The form shall be approved by the Engineer and a minimum of three (3) copies must be furnished at each turn-on. The manufacturer must provide all programming information used within the controller at the time of turn-on.
8. All manufacturer and contractor warranties and guarantees required by Article 801.14.

Acceptance of the traffic signal equipment by the Department shall be based upon inspection results at the traffic signal "turn on." If approved, traffic signal acceptance shall be verbal at the "turn on" inspection followed by written correspondence from the Engineer. The Contractor shall be responsible for all traffic signal equipment and associated maintenance thereof until Departmental acceptance is granted.

All equipment and/or parts to keep the traffic signal installation operating shall be furnished by the Contractor. No spare traffic signal equipment is available from the Department.

All punch list work shall be completed within two (2) weeks after the final inspection. The Contractor shall notify the Electrical Maintenance Contractor to inspect all punch list work. Failure to meet these time constraints shall result in liquidated damage charges of \$500 per month per incident.

All cost of work and materials required to comply with the above requirements shall be included in the pay item bid prices, under which the subject materials and signal equipment are paid, and no additional compensation will be allowed. Materials and signal equipment not complying with the above requirements shall be subject to removal and disposal at the Contractor's expense.

RECORD DRAWINGS

The requirements listed for Electrical Installation shall apply for Traffic Signal Installations in

Article 801.16. Revise the 2nd paragraph of Article 801.16 of the Standard Specifications to read:

- a. "When the work is complete, and seven days before the request for a final inspection, the full-size set of contract drawings. Stamped "RECORD DRAWINGS", shall be submitted to the Engineer for review and approval and shall be stamped with the date and the signature of the Contractor's supervising Engineer or electrician. The record drawings shall be submitted in PDF format on CDROM as well as hardcopy for review and approval.
- b. In addition to the record drawings, copies of the final catalog cuts which have been Approved or Approved as Noted shall be submitted in PDF format along with the record drawings. The PDF files shall clearly indicate the pay item either by filename or PDF Table of Contents referencing the respective pay item number for multi-item PDF files. Specific part or model numbers of items which have been selected shall be clearly visible."
- c. Additional requirements are listed in the District's Electrical Product Data and Documentation Guidelines.

Add the following to Article 801.16 of the Standard Specifications:

"In addition to the specified record drawings, the Contactor shall record GPS coordinates of the following traffic signal components being installed, modified or being affected in other ways by this contract:

- All Mast Arm Poles and Posts
- Handholes
- Conduit roadway crossings
- Controller Cabinets
- Communication Cabinets
- Electric Service Disconnect locations
- CCTV Camera installations
- Fiber Optic Splice Locations

Datum to be used shall be North American 1983.

Data shall be provided electronically and in print form. The electronic format shall be compatible with MS Excel. Latitude and Longitude shall be in decimal degrees with a minimum of 6 decimal places. Each coordinate shall have the following information:

5. Description of item
6. Designation or approximate station if the item is undesignated
7. Latitude
8. Longitude

Examples:

Description	Designation	Latitude	Longitude
Mast Arm Pole Assembly (dual, combo, etc)	MP (SW, NW, SE or NE corner)	41.580493	- 87.793378
FO mainline splice handhole	HHL-ST31	41.558532	- 87.792571
Handhole	HH	41.765532	- 87.543571
Electric Service	Elec Srv	41.602248	- 87.794053
Conduit crossing	SB IL83 to EB I290 ramp SIDE A	41.584593	- 87.793378
PTZ Camera	PTZ	41.584600	- 87.793432
Signal Post	Post	41.558532	- 87.792571
Controller Cabinet	CC	41.651848	- 87.762053
Master Controller Cabinet	MCC	41.580493	- 87.793378
Communication Cabinet	ComC	41.558532	- 87.789771
Fiber splice connection	Toll Plaza34	41.606928	- 87.794053

Prior to the collection of data, the contractor shall provide a sample data collection of at least six data points of known locations to be reviewed and verified by the Engineer to be accurate within 100 feet. Upon verification, data collection can begin. Data collection can be made as construction progresses, or can be collected after all items are installed. If the data is unacceptable the contractor shall make corrections to the data collection equipment and or process and submit the data for review and approval as specified.

Accuracy. Data collected is to be mapping grade. A handheld mapping grade GPS device shall be used for the data collection. The receiver shall support differential correction and data shall have a minimum 5 meter accuracy after post processing.

GPS receivers integrated into cellular communication devices, recreational and automotive GPS devices are not acceptable.

The GPS shall be the product of an established major GPS manufacturer having been in the business for a minimum of 6 years."

Delete the last sentence of the 3rd paragraph of Article 801.16.

LOCATING UNDERGROUND FACILITIES.

Revise Section 803 to the Standard Specifications to read:

If this Contract requires the services of an Electrical Contractor, the Contractor shall be responsible at his/her own expense for locating existing IDOT electrical facilities prior to performing any work. If this Contract does not require the services of an Electrical Contractor, the Contractor may request one free locate for existing IDOT electrical facilities from the District One Electrical Maintenance Contractor prior to the start of any work. Additional requests may be at the expense of the Contractor. The location of underground traffic facilities does not relieve the Contractor of their responsibility to repair any facilities damaged during construction at their expense.

The exact location of all utilities shall be field verified by the Contractor before the installation of any components of the traffic signal system. For locations of utilities, locally owned equipment, and leased enforcement camera system facilities, the local Counties or Municipalities may need to be contacted: in the City of Chicago contact Digger at (312) 744-7000 and for all other locations contact J.U.L.I.E. at 1-800-892-0123 or 811.

RESTORATION OF WORK AREA.

Add the following article to Section 801 of the Standard Specifications:

801.17 Restoration of work area. Restoration of the traffic signal work area shall be included in the related pay items such as foundation, conduit, handhole, trench and backfill, underground raceways, etc. All roadway surfaces such as shoulders, medians, sidewalks, pavement, etc. shall be replaced in kind. All damage to mowed lawns shall be replaced with an approved sod, and all damage to unmowed fields shall be seeded. All brick pavers disturbed in the work area shall be restored to their original configuration as directed by the Engineer. All damaged brick pavers shall be replaced with a comparable material approved by the Engineer. Restoration of the work area shall be included in the contract without any extra compensation allowed to the Contractor.

ELECTRIC SERVICE INSTALLATION.

Revise Section 805 of the Standard Specifications to read:

Description.

This work shall consist of all materials and labor required to install, modify, or extend the electric service installation. All installations shall meet the requirements of the details in the "District One Standard Traffic Signal Design Details" and applicable portions of the Specifications.

General.

The electric service installation shall be the electric service disconnecting means and it shall be identified as suitable for use as service equipment.

The electric utility contact information is noted on the plans and represents the current information at the time of contract preparation. The Contractor must request in writing for

service and/or service modification within 10 days of contract award and must follow-up with the electric utility to assure all necessary documents and payment are received by the utility. The Contractor shall forward copies of all correspondence between the contractor and utility company to the Engineer and Area Traffic Signal Maintenance and Operations Engineer. The service agreement and sketch shall be submitted for signature to the IDOT's Traffic Operations Programs Engineer.

Materials.

- a. General. The completed control panel shall be constructed in accordance with UL Std. 508A, Industrial Control Panel, and carry the UL label. Wire terminations shall be UL listed.
- b. Enclosures.
 1. Pole Mounted Cabinet. The cabinet shall be UL 50, NEMA Type 4X, unfinished single door design, fabricated from minimum 0.080-inch (2.03 mm) thick Type 5052 H-32 aluminum. Seams shall be continuous welded and ground smooth. Stainless steel screws and clamps shall secure the cover and assure a watertight seal. The cover shall be removable by pulling the continuous stainless steel hinge pin. The cabinet shall have an oil-resistant gasket and a lock kit shall be provided with an internal O-ring in the locking mechanism assuring a watertight and dust-tight seal. The cabinet shall be sized to adequately house all required components with extra space for arrangement and termination of wiring. A minimum size of 14-inches (350 mm) high, 9-inches (225 mm) wide and 8-inches (200 mm) in depth is required. The cabinet shall be channel mounted to a wooden utility pole using assemblies recommended by the manufacturer.
 2. Ground Mounted Cabinet. The cabinet shall be UL 50, NEMA Type 3R unfinished single door design with back panel. The cabinet shall be fabricated from Type 5052 H-32 aluminum with the frame and door 0.125-inch (3.175 mm) thick, the top 0.250-inch (6.350 mm) thick and the bottom 0.500-inch (12.70 mm) thick. Seams shall be continuous welded and ground smooth. The door and door opening shall be double flanged. The door shall be approximately 80% of the front surface, with a full length tamperproof stainless steel .075-inch (1.91 mm) thick hinge bolted to the cabinet with stainless steel carriage bolts and nylocks nuts. The locking mechanism shall be slam-latch type with a keyhole cover. The cabinet shall be sized to adequately house all required components with extra space for arrangement and termination of wiring. A minimum size of 40-inches (1000 mm) high, 16-inches (400 mm) wide and 15-inches (375 mm) in depth is required. The cabinet shall be mounted upon a square Type A concrete foundation as indicated on the plans. The foundation is paid for separately.
- c. Surge Protector. Overvoltage protection, with LED indicator, shall be provided for the 120 volt load circuit by the means MOV and thermal fusing technology. The response time shall be <math><5n</math> seconds and operate within a range of -40C to +85C. The surge protector shall be UL 1449 Listed.

- d. **Circuit Breakers.** Circuit breakers shall be standard UL listed molded case, thermal-magnetic bolt-on type circuit breakers with trip free indicating handles. 120 volt circuit breakers shall have an interrupting rating of not less than 65,000 rms symmetrical amperes. Unless otherwise indicated, the main disconnect circuit breaker for the traffic signal controller shall be rated 60 amperes, 120 V and the auxiliary circuit breakers shall be rated 10 amperes, 120 V.
- e. **Fuses, Fuseholders and Power Indicating Light.** Fuses shall be small-dimensional cylindrical fuses of the dual element time-delay type. The fuses shall be rated for 600 V AC and shall have a UL listed interrupting rating of not less than 10,000 rms symmetrical amperes at rated voltage. The power indicating light shall be LED type with a green colored lens and shall be energized when electric utility power is present.
- f. **Ground and Neutral Bus Bars.** A single copper ground and neutral bus bar, mounted on the equipment panel shall be provided. Ground and neutral conductors shall be separated on the bus bar. Compression lugs, plus 2 spare lugs, shall be sized to accommodate the cables with the heads of the connector screws painted green for ground connections and white for neutral connections.
- g. **Utility Services Connection.** The Contractor shall notify the Utility Company marketing representative a minimum of 30 working days prior to the anticipated date of hook-up. This 30 day advance notification will begin only after the Utility Company marketing representative has received service charge payments from the Contractor. Prior to contacting the Utility Company marketing representative for service connection, the service installation controller cabinet and cable must be installed for inspection by the Utility Company.
- h. **Ground Rod.** Ground rods shall be copper-clad steel, a minimum of 10 feet (3.0m) in length, and 3/4 inch (20mm) in diameter. Ground rod resistance measurements to ground shall be 25 ohms or less. If necessary additional rods shall be installed to meet resistance requirements at no additional cost to the contract.

Installation.

- a. **General.** The Contractor shall confirm the orientation of the traffic service installation and its door side with the engineer, prior to installation. All conduit entrances into the service installation shall be sealed with a pliable waterproof material.
- b. **Pole Mounted.** Brackets designed for pole mounting shall be used. All mounting hardware shall be stainless steel. Mounting height shall be as noted on the plans or as directed by the Engineer.
- c. **Ground Mounted.** The service installation shall be mounted plumb and level on the foundation and fastened to the anchor bolts with hot-dipped galvanized or stainless steel nuts and washers. The space between the bottom of the enclosure and the top of the foundation shall be caulked at the base with silicone.

Basis of Payment.

The service installation shall be paid for at the contract unit price each for SERVICE INSTALLATION of the type specified which shall be payment in full for furnishing and installing the service installation complete. The CONCRETE FOUNDATION, TYPE A, which includes the ground rod, shall be paid for separately. SERVICE INSTALLATION, POLE MOUNTED shall include the 3/4 inch (20mm) grounding conduit, ground rod, and pole mount assembly. Any charges by the utility companies shall be approved by the engineer and paid for as an addition to the contract according to Article 109.05 of the Standard Specifications.

GROUNDING OF TRAFFIC SIGNAL SYSTEMS.

Revise Section 806 of the Standard Specifications to read:

General.

All traffic signal systems, equipment and appurtenances shall be properly grounded in strict conformance with the NEC. See IDOT District One Traffic Signal detail plan sheets for additional information.

The grounding electrode system shall include a ground rod installed with each traffic signal controller concrete foundation and all mast arm and post concrete foundations. An additional ground rod will be required at locations where measured resistance exceeds 25 ohms. Ground rods are included in the applicable concrete foundation or service installation pay item and will not be paid for separately.

Testing shall be according to Article 801.13 (a) (4) and (5).

- (a) The grounded conductor (neutral conductor) shall be white color coded. This conductor shall be bonded to the equipment grounding conductor only at the Electric Service Installation. All power cables shall include one neutral conductor of the same size.
- (b) The equipment grounding conductor shall be green color coded. The following is in addition to Article 801.04 of the Standard Specifications.
 - 1. Equipment grounding conductors shall be bonded to the grounded conductor (neutral conductor) only at the Electric Service Installation. The equipment grounding conductor is paid for separately and shall be continuous. The Earth shall not be used as the equipment grounding conductor.
 - 2. Equipment grounding conductors shall be bonded, using a Listed grounding connector, to all traffic signal mast arm poles, traffic signal posts, pedestrian posts, pull boxes, handhole frames and covers, conduits, and other metallic enclosures throughout the traffic signal wiring system, except where noted herein. Bonding shall be made with a splice and pigtail connection, using a sized compression type copper sleeve, sealant tape, and heat-shrinkable cap. A Listed electrical joint compound shall be applied to all conductors' terminations, connector threads and contact points. Conduit grounding bushings shall be installed at all conduit terminations.

3. All metallic and non-metallic raceways containing traffic signal circuit runs shall have a continuous equipment grounding conductor, except raceways containing only detector loop lead-in circuits, circuits under 50 volts and/or fiber optic cable will not be required to include an equipment grounding conductor.
 4. Individual conductor splices in handholes shall be soldered and sealed with heat shrink. When necessary to maintain effective equipment grounding, a full cable heat shrink shall be provided over individual conductor heat shrinks.
- (c) The grounding electrode conductor shall be similar to the equipment grounding conductor in color coding (green) and size. The grounding electrode conductor is used to connect the ground rod to the equipment grounding conductor and is bonded to ground rods via exothermic welding, listed pressure connectors, listed clamps or other approved listed means.

GROUNDING EXISTING HANDHOLE FRAME AND COVER.

Description.

This work shall consist of all materials and labor required to bond the equipment grounding conductor to the existing handhole frame and handhole cover. All installations shall meet the requirements of the details in the "District One Standard Traffic Signal Design Details," and applicable portions of the Standard Specifications and these specifications.

The equipment grounding conductor shall be bonded to the handhole frame and to the handhole cover. Two (2) ½-inch diameter x 1 ¼-inch long hex-head stainless steel bolts, spaced 1.75-inches apart center-to-center shall be fully welded to the frame and to the cover to accommodate a heavy duty Listed grounding compression terminal (Burdny type YGHA or approved equal). The grounding compression terminal shall be secured to the bolts with stainless steel split-lock washers and nylon-insert locknuts.

Welding preparation for the stainless steel bolt hex-head to the frame and to the cover shall include thoroughly cleaning the contact and weldment area of all rust, dirt and contaminants. The Contractor shall assure a solid strong weld. The welds shall be smooth and thoroughly cleaned of flux and spatter. The grounding installation shall not affect the proper seating of the cover when closed.

The grounding cable shall be paid for separately.

Method of Measurement.

Units measured for payment will be counted on a per handhole basis, regardless of the type of handhole and its location.

Basis of Payment.

This work shall be paid for at the contract unit price each for GROUNDING EXISTING HANDHOLE FRAME AND COVER which shall be payment in full for grounding the handhole complete.

COILABLE NON-METALLIC CONDUIT.

Description.

This work shall consist of furnishing and installing empty coilable non-metallic conduit (CNC) for detector loop raceways.

General.

The CNC installation shall be in accordance with Sections 810 and 811 of the Standard Specifications except for the following:

Add the following to Article 810.03 of the Standard Specifications:

CNC meeting the requirements of NEC Article 353 shall be used for detector loop raceways to the handholes.

Add the following to Article 811.03 of the Standard Specifications:

On temporary traffic signal installations with detector loops, CNC meeting the requirements of NEC Article 353 shall be used for detector loop raceways from the saw-cut to 10 feet (3m) up the wood pole, unless otherwise shown on the plans

Basis of Payment.

All installations of CNC for loop detection shall be included in the contract and not paid for separately.

HANDHOLES.

Add the following to Section 814 of the Standard Specifications:

All handholes shall be concrete, poured in place, with inside dimensions of 21-1/2 inches (549mm) minimum. Frames and lid openings shall match this dimension. The cover of the handhole frame shall be labeled "Traffic Signals" with legible raised letters.

For grounding purposes the handhole frame shall have provisions for a 7/16 inch (15.875mm) diameter stainless bolt cast into the frame. The covers shall have a stainless steel threaded stint extended from the eye hook assembly for the purpose of attaching the grounding conductor to the handhole cover.

The minimum wall thickness for heavy duty hand holes shall be 12 inches (300mm).

All conduits shall enter the handhole at a depth of 30 inches (760mm) except for the conduits for detector loops when the handhole is less than 5 feet (1.52 m) from the detector loop. All conduit ends should be sealed with a waterproof sealant to prevent the entrance of contaminants into the handhole.

Steel cable hooks shall be coated with hot-dipped galvanization in accordance with AASHTO

Specification M111. Hooks shall be a minimum of 1/2 inch (12.7 mm) diameter with two 90 degree bends and extend into the handhole at least 6 inches (150 mm). Hooks shall be placed a minimum of 12 inches (300 mm) below the lid or lower if additional space is required.

GROUNDING CABLE.

The cable shall meet the requirements of Section 817 of the "Standard Specifications," except for the following:

Add the following to Article 817.02 (b) of the Standard Specifications:

Unless otherwise noted on the Plans, traffic signal grounding conductor shall be one conductor, #6 gauge copper, with a green color coded XLP jacket.

The traffic signal grounding conductor shall be bonded, using a Listed grounding connector (Burndy type KC/K2C, as applicable, or approved equal), to all proposed and existing traffic signal mast arm poles and traffic/pedestrian signal posts, including push button posts. The grounding conductor shall be bonded to all proposed and existing pull boxes, handhole frames and covers and other metallic enclosures throughout the traffic signal wiring system and noted herein and detailed on the plans. The grounding conductor shall be bonded to conduit terminations using rated grounding bushings. Bonding to existing handhole frames and covers shall be paid for separately.

Add the following to Article 817.05 of the Standard Specifications:

Basis of Payment.

Grounding cable shall be measured in place for payment in foot (meter). Payment shall be at the contract unit price for ELECTRIC CABLE IN CONDUIT, GROUNDING, NO. 6, 1C, which price includes all associated labor and material including grounding clamps, splicing, exothermic welds, grounding connectors, conduit grounding bushings, and other hardware.

RAILROAD INTERCONNECT CABLE.

The cable shall meet the requirements of Section 873 of the Standard Specifications, except for the following:

Add to Article 873.02 of the Standard Specifications:

The railroad interconnect cable shall be three conductor stranded #14 copper cable in a clear polyester binder, shielded with #36 AWG tinned copper braid with 85% coverage, and insulated with .016" polyethylene (black, blue, red). The jacket shall be black 0.045 PVC or polyethylene.

Add the following to Article 873.05 of the Standard Specifications:

Basis of Payment.

This work shall be paid for at the contract unit price per foot (meter) for ELECTRIC CABLE IN

CONDUIT, RAILROAD, NO. 14 3C, which price shall be payment in full for furnishing, installing, and making all electrical connections in the traffic signal controller cabinet. Connections in the railroad controller cabinet shall be performed by railroad personnel.

FIBER OPTIC TRACER CABLE.

The cable shall meet the requirements of Section 817 of the "Standard Specifications," except for the following:

Add the following to Article 817.03 of the Standard Specifications:

In order to trace the fiber optic cable after installation, the tracer cable shall be installed in the same conduit as the fiber optic cable in locations shown on the plans. The tracer cable shall be continuous, extended into the controller cabinet and terminated on a barrier type terminal strip mounted on the side wall of the controller cabinet. The barrier type terminal strip and tracer cable shall be clearly marked and identified. All tracer cable splices shall be kept to a minimum and shall incorporate maximum lengths of cable supplied by the manufacturer. The tracer cable will be allowed to be spliced at handholes only. The tracer cable splice shall use a Western Union Splice soldered with resin core flux and shall be soldered using a soldering iron. Blow torches or other devices which oxidize copper cable shall not be allowed for soldering operations. All exposed surfaces of the solder shall be smooth. The splice shall be covered with a black shrink tube meeting UL 224 guidelines, Type V and rated 600v, minimum length 4 inches (100 mm) and with a minimum 1 inch (25 mm) coverage over the XLP insulation, underwater grade.

Add the following to Article 817.05 of the Standard Specifications:

Basis of Payment.

The tracer cable shall be paid for separately as ELECTRIC CABLE IN CONDUIT, TRACER, NO. 14 1C per foot (meter), which price shall include all associated labor and material for installation.

MAINTENANCE OF EXISTING TRAFFIC SIGNAL INSTALLATION.

Revise Articles 850.02 and 850.03 of the Standard Specifications to read:

Procedure.

The energy charges for the operation of the traffic signal installation shall be paid for by others. Full maintenance responsibility shall start as soon as the Contractor begins any physical work on the Contract or any portion thereof.

The Contractor shall have electricians with IMSA Level II certification on staff to provide signal maintenance.

This item shall include maintenance of all traffic signal equipment at the intersection, including emergency vehicle pre-emption equipment, master controllers, uninterruptible power supply

(UPS and batteries), telephone service installations, communication cables, conduits to adjacent intersections, and other traffic signal equipment, but shall not include Automatic Traffic Enforcement equipment, such as Red Light Enforcement cameras, detectors, or peripheral equipment, not owned by the State.

Maintenance.

The maintenance shall be according to MAINTENANCE AND RESPONSIBILITY in Division 800 of these specifications and the following:

The Contractor shall check all controllers every two (2) weeks, which will include visually inspecting all timing intervals, relays, detectors, and pre-emption equipment to ensure that they are functioning properly. This item includes, as routine maintenance, all portions of emergency vehicle pre-emption equipment. The Contractor shall maintain in stock at all times a sufficient amount of materials and equipment to provide effective temporary and permanent repairs.

The Contractor shall provide immediate corrective action when any part or parts of the system fail to function properly. Two far side heads facing each approach shall be considered the minimum acceptable signal operation pending permanent repairs. When repairs at a signalized intersection require that the controller be disconnected or otherwise removed from normal operation, and power is available, the Contractor shall place the traffic signal installation on flashing operation. The signals shall flash RED for all directions unless a different indication has been specified by the Engineer. The Contractor shall be required to place stop signs (R1-1-36) at each approach of the intersection as a temporary means of regulating traffic. When the signals operate in flash, the Contractor shall furnish and equip all their vehicles assigned to the maintenance of traffic signal installations with a sufficient number of stop signs as specified herein. The Contractor shall maintain a sufficient number of spare stop signs in stock at all times to replace stop signs which may be damaged or stolen.

The Contractor shall provide the Engineer with a 24 hour telephone number for the maintenance of the traffic signal installation and for emergency calls by the Engineer.

Traffic signal equipment which is lost or not returned to the Department for any reason shall be replaced with new equipment meeting the requirements of the Standard Specifications and these special provisions.

The Contractor shall respond to all emergency calls from the Department or others within one hour after notification and provide immediate corrective action. When equipment has been damaged or becomes faulty beyond repair, the Contractor shall replace it with new and identical equipment. The cost of furnishing and installing the replaced equipment shall be borne by the Contractor at no additional charge to the contract. The Contractor may institute action to recover damages from a responsible third party. If at any time the Contractor fails to perform all work as specified herein to keep the traffic signal installation in proper operating condition or if the Engineer cannot contact the Contractor's designated personnel, the Engineer shall have the State's Electrical Maintenance Contractor perform the maintenance work required. The State's Electrical Maintenance Contractor shall bill the Contractor for the total cost of the work. The Contractor shall pay this bill within thirty (30) days of the date of receipt of the invoice or the cost of such work will be deducted from the amount due the Contractor. The Contractor shall allow the Electrical Maintenance Contractor to make reviews of the Existing Traffic Signal Installation

that has been transferred to the Contractor for Maintenance.

TRAFFIC ACTUATED CONTROLLER.

Add the following to Article 857.02 of the Standard Specifications:

Controllers shall be NTCIP compliant NEMA TS2 Type 1, Econolite ASC/3S-1000 or Eagle/Siemens M50 unless specified otherwise on the plans or elsewhere on these specifications. Only controllers supplied by one of the District One approved closed loop equipment manufacturers will be allowed. The controller shall be the most recent model and software version supplied by the manufacturer at the time of the approval and include the standard data key. The traffic signal controller shall provide features to inhibit simultaneous display of a circular yellow ball and a yellow arrow display. Individual load switches shall be provided for each vehicle, pedestrian, and right turn over lap phase. The controller shall prevent phases from being skipped during program changes and after all preemption events.

Add the following to Article 857.03 of the Standard Specifications:

The Contractor shall arrange to install a standard voice-grade dial-up telephone line to the RAILROAD, FULL-ACTUATED CONTROLLER AND CABINET as called for on the traffic signal installation plans. If the traffic signal installation is part of a traffic signal system, a telephone line is usually not required, unless a telephone line is called for on the traffic signal plans. The Contractor shall follow the requirements for the telephone service installation as contained in the current District One Traffic Signal Special Provisions under Master Controller.

MASTER CONTROLLER.

Revise Articles 860.02 - Materials and 860.03 - Installation of the Standard Specifications to read:

Only controllers supplied by one of the District approved closed loop equipment manufacturers will be allowed. Only NEMA TS 2 Type 1 Eagle/Siemens and Econolite closed loop systems shall be supplied. The latest model and software version of master controller shall be supplied.

Functional requirements in addition to those in Section 863 of the Standard Specifications include:

The system commands shall consist of, as a minimum, six (6) cycle lengths, five (5) offsets, three (3) splits, and four (4) special functions. The system commands shall also include commands for free or coordinated operation.

Traffic Responsive operation shall consist of the real time acquisition of system detector data, data validation, and the scaling of acquired volumes and occupancies in a deterministic fashion so as to cause the selection and implementation of the most suitable traffic plan.

Upon request by the Engineer, each master shall be delivered with up to three (3) complete sets

of the latest edition of registered remote monitoring software with full manufacture's support. Each set shall consist of software on CD, DVD, or other suitable media approved by the Engineer, and a bound set of manuals containing loading and operating instruction. One copy of the software and support data shall be delivered to the Agency in charge of system operation, if other than IDOT. One of these two sets will be provided to the Agency Signal Maintenance Contractor for use in monitoring the system.

The approved manufacturer of equipment shall loan the District one master controller and two intersection controllers of the most recent models and the newest software version to be used for instructional purposes in addition to the equipment to be supplied for the Contract.

The Contractor shall arrange to install a standard voice-grade dial-up telephone line to the master controller. This shall be accomplished through the following process utilizing District One staff. This telephone line may be coupled with a DSL line and a phone filter to isolate the dial-up line. An E911 address is required.

The cabinet shall be provided with an Outdoor Network Interface for termination of the telephone service. It shall be mounted to the inside of the cabinet in a location suitable to provide access for termination of the telephone service at a later date.

Full duplex communication between the master and its local controllers is recommended, but at this time not required. The data rate shall be 1200 baud minimum and shall be capable of speeds to 38,400 or above as technology allows. The controller, when installed in an Ethernet topology, may operate non-serial communications.

The cabinet shall be equipped with a 9600 baud, auto dial/auto answer modem. It shall be a US robotics 33.6K baud rate or equal.

As soon as practical or within one week after the contract has been awarded, the Contractor shall contact (via phone) the Administrative Support Manager in the District One Business Services Section at (847) 705-4011 to request a phone line installation.

A follow-up fax transmittal to the Administrative Support Manager (847-705-4712) with all required information pertaining to the phone installation is required from the Contractor as soon as possible or within one week after the initial request has been made. A copy of this fax transmittal must also be faxed by the Contractor to the Traffic Signal Systems Engineer at (847) 705-4089. The required information to be supplied on the fax shall include (but not limited to): A street address for the new traffic signal controller (or nearby address); a nearby existing telephone number; what type of telephone service is needed; the name and number of the Contractor's employee for the telephone company to contact regarding site work and questions.

The usual time frame for the activation of the phone line is 4-6 weeks after the Business Services Section has received the Contractor supplied fax. It is, therefore, imperative that the phone line conduit and pull-string be installed by the Contractor in anticipation of this time frame. On jobs which include roadway widening in which the conduit cannot be installed until this widening is completed, the Contractor will be allowed to delay the phone line installation request to the Business Services Section until a point in time that is 4-6 weeks prior to the anticipated completion of the traffic signal work. The contractor shall provide the Administrative

Support Manager with an expected installation date considering the 4-6 week processing time.

The telephone line shall be installed and activated one month before the system final inspection.

All costs associated with the telephone line installation and activation (not including the Contract specified conduit installation between the point of telephone service and the traffic signal controller cabinet) shall be paid for by the District One Business Services Section (i.e., this will be an IDOT phone number not a Contractor phone number).

UNINTERRUPTIBLE POWER SUPPLY.

Add the following to Article 862.01 of the Standard Specifications:

The UPS shall have the power capacity to provide normal operation of a signalized intersection that utilizes all LED type signal head optics, for a minimum of six hours.

Add the following to Article 862.02 of the Standard Specifications:

Materials shall be according to Article 1074.04 as modified in UNINTERRUPTIBLE POWER SUPPLY in Division 1000 of these specifications.

Add the following to Article 862.03 of the Standard Specifications:

The UPS shall additionally include, but not be limited to, a battery cabinet. The UPS shall provide reliable emergency power to the traffic signals in the event of a power failure or interruption.

Revise Article 862.04 of the Standard Specifications to read:

Installation.

When a UPS is installed at an existing traffic signal cabinet, the UPS cabinet shall partially rest on the lip of the existing controller cabinet foundation and be secured to the existing controller cabinet by means of at least four (4) stainless steel bolts. The UPS cabinet shall be completely enclosed with the bottom and back constructed of the same material as the cabinet.

When a UPS is installed at a new signal cabinet and foundation, it shall be mounted as shown on the plans.

At locations where UPS is installed and Emergency Vehicle Priority System is in use, any existing incandescent confirmation beacons shall be replaced with LED lamps in accordance with the District One Emergency Vehicle Priority System specification at no additional cost to the contract. A concrete apron 67 in. x 50 in. x 5 in. (1702mm x 1270mm x 130mm) shall be provided on the side of the existing Type D Foundation, where the UPS cabinet is located. The concrete apron shall follow the District 1 Standard Traffic Signal Design Detail, Type D for Ground Mounted Controller Cabinet and UPS Battery Cabinet. The concrete apron shall follow Articles 424 and 202 of the Standard Specifications.

This item shall include any required modifications to an existing traffic signal controller as a result of the addition of the UPS.

Revise Article 862.05 of the Standard Specifications to read:

Basis of Payment.

This work will be paid for at the contract unit price per each for UNINTERRUPTIBLE POWER SUPPLY SPECIAL. Replacement of Emergency Vehicle Priority System confirmation beacons and any required modifications to the traffic signal controller shall be included in the cost of the UNINTERRUPTIBLE POWER SUPPLY SPECIAL item. The concrete apron and earth excavation required shall be included in the cost of the UNINTERRUPTIBLE POWER SUPPLY SPECIAL item.

FIBER OPTIC CABLE.

Add the following to Article 871.01 of the Standard Specifications:

The Fiber Optic cable shall be installed in conduit or as specified on the plans.

Add the following to Article 872.02 of the Standard Specifications:

The control cabinet distribution enclosure shall be CSC FTWO12KST-W/O 12 Port Fiber Wall Enclosure or an approved equivalent. The fiber optic cable shall provide six fibers per tube for the amount of fibers called for in the Fiber Optic Cable pay item in the Contract. Fiber Optic cable may be gel filled or have an approved water blocking tape.

Add the following to Article 871.04 of the Standard Specifications:

A minimum of six multimode fibers from each cable shall be terminated with approved mechanical connectors at the distribution enclosure. Fibers not being used shall be labeled "spare." Fibers not attached to the distribution enclosure shall be capped and sealed. A minimum of 13.0 feet (4m) of extra cable length shall be provided for controller cabinets. The controller cabinet extra cable length shall be stored as directed by the Engineer.

Add the following to Article 871.06 of the Standard Specifications:

The distribution enclosure and all connectors will be included in the cost of the fiber optic cable.

MAST ARM ASSEMBLY AND POLE.

Revise Article 877.01 of the Standard Specifications to read:

Description.

This work shall consist of furnishing and installing a steel mast arm assembly and pole and a galvanized steel or extruded aluminum shroud for protection of the base plate.

Revise Article 877.03 of the Standard Specifications:

Mast arm assembly and pole shall be as follows.

(a) Steel Mast Arm Assembly and Pole and Steel Combination Mast Arm Assembly and Pole. The steel mast arm assembly and pole and steel combination mast arm assembly and pole shall consist of a traffic signal mast arm, a luminaire mast arm or davit (for combination pole only), a pole, and a base, together with anchor rods and other appurtenances. The configuration of the mast arm assembly, pole, and base shall be according to the details shown on the plans.

(1) Loading. The mast arm assembly and pole, and combination mast arm assembly and pole shall be designed for the loading shown on the Highway Standards or elsewhere on the plans, whichever is greater. The design shall be according to AASHTO "Standard Specification for Structural Supports for Highway Signs, Luminaries and Traffic Signals" 1994 Edition for 80 mph (130 km/hr) wind velocity. However, the arm-to-pole connection for tapered signal and luminaire arms shall be according to the "ring plate" detail as shown in Figure 11-1(f) of the 2002 Interim, to the AASHTO "Standard Specification for Structural Supports for Highway Signs, Luminaries and Traffic Signals" 2001 4th Edition.

(2) Structural Steel Grade. The mast arm and pole shall be fabricated according to ASTM A 595, Grade A or B, ASTM A 572 Grade 55, or ASTM A 1011 Grade 55 HSLAS Class 2. The base and flange plates shall be of structural steel according to AASHTO M 270 Grade 50 (M 270M Grade 345). Luminaire arms and trussed arms 15 ft (4.5 m) or less shall be fabricated from one steel pipe or tube size according to ASTM A 53 Grade B or ASTM A 500 Grade B or C. All mast arm assemblies, poles, and bases shall be galvanized according to AASHTO M 111.

(3) Fabrication. The design and fabrication of the mast arm assembly, pole, and base shall be according to the requirements of the Standard Specifications for Structural Supports for Highway Signs, Luminaires, and Traffic Signals published by AASHTO. The mast arm and pole may be of single length or sectional design. If section design is used, the overlap shall be at least 150 percent of the maximum diameter of the overlapping section and shall be assembled in the factory.

The manufacturer will be allowed to slot the base plate in which other bolt circles may fit, providing that these slots do not offset the integrity of the pole. Circumferential welds of tapered arms and poles to base plates shall be full penetration welds.

(4) Shop Drawing Approval. The Contractor shall submit detailed drawings showing design materials, thickness of sections, weld sizes, and anchor rods to the Engineer for approval prior to fabrication. These drawings shall be at least 11 x 17 in. (275 x 425 mm) in size and of adequate quality for microfilming. All product data and shop drawings shall be submitted in electronic form on CD-ROM

(b) Anchor Rods. The anchor rods shall be ASTM F 1554 Grade 105, coated by the hot-dip galvanizing process according to AASHTO M 232, and shall be threaded a minimum of 7 1/2 in.

(185 mm) at one end and have a bend at the other end. The first 12 in. (300 mm) at the threaded end shall be galvanized. Two nuts, one lock washer, and one flat washer shall be furnished with each anchor rod. All nuts and washers shall be galvanized.

(c) The galvanized steel or extruded aluminum shroud shall have dimensions similar to those detailed in the "District One Standard Traffic Signal Design Details." The shroud shall be installed such that it allow air to circulate throughout the mast arm but not allow infestation of insects or other animals, and such that it is not hazardous to probing fingers and feet.

Add the following to Article 877.04 of the Standard Specifications:

The shroud shall not be paid for separately but shall be included in the cost of the mast arm assembly and pole.

CONCRETE FOUNDATIONS.

Add the following to Article 878.03 of the Standard Specifications:

All anchor bolts shall be according to Article 1006.09, with all anchor bolts hot dipped galvanized a minimum of 12 in. (300 mm) from the threaded end.

Concrete Foundations, Type "A" for Traffic Signal Posts shall provide anchor bolts with the bolt pattern specified within the "District One Standard Traffic Signal Design Details." All Type "A" foundations shall be a minimum depth of 48 inches (1220 mm).

Concrete Foundations, Type "C" for Traffic Signal Cabinets with Uninterruptible Power Supply (UPS) cabinet installations shall be a minimum of 72 inches (1830 mm) long and 31 inches (790 mm) wide. All Type "C" foundations shall be a minimum depth of 48 inches (1220 mm). The concrete apron in front of the Type IV or V cabinet shall be 36 in. x 48 in. x 5 in. (915 mm X 1220 mm X 130 mm). The concrete apron in front of the UPS cabinet shall be 36 in. x 67 in. x 5 in. (915 mm X 1700 mm X 130 mm). Anchor bolts shall provide bolt spacing as required by the manufacturer.

Concrete Foundations, Type "D" for Traffic Signal Cabinets shall be a minimum of 48 inches (1220 mm) long and 31 inches (790 mm) wide. All Type "D" foundations shall be a minimum depth of 48 inches (1220 mm). The concrete apron shall be 36 in. x 48 in. x 5 in. (910 mm X 1220 mm X 130 mm). Anchor bolts shall provide bolt spacing as required by the manufacturer.

Concrete Foundations, Type "E" for Mast Arm and Combination Mast Arm Poles shall meet the current requirements listed in the Highway Standards.

Foundations used for Combination Mast Arm Poles shall provide an extra 2-1/2 inch (65 mm) raceway.

No foundation is to be poured until the Resident Engineer gives his/her approval as to the depth of the foundation.

LIGHT EMITTING DIODE (LED) SIGNAL HEAD AND OPTICALLY PROGRAMMED LED SIGNAL HEAD.

Add the following to the first paragraph of Article 880.04 of the Standard Specifications:

Basis of Payment.

The price shall include furnishing the equipment described above, all mounting hardware and installing them in satisfactory operating condition.

LIGHT EMITTING DIODE (LED), SIGNAL HEAD, RETROFIT

Description.

This work shall consist of retrofitting an existing polycarbonate traffic signal head with a traffic signal module, pedestrian signal module, and pedestrian countdown signal module, with light emitting diodes (LEDs) as specified in the plans.

Materials.

Materials shall be according to LIGHT EMITTING DIODE (LED) AND OPTICALLY PROGRAMMED LED SIGNAL HEAD, AND LIGHT EMITTING DIODE (LED) PEDESTRIAN SIGNAL HEAD in Divisions 880, 881 and 1000 of these specifications.

Add the following to Article 880.04 of the Standard Specifications:

Basis of Payment.

This item shall be paid for at the contract unit price each for SIGNAL HEAD, LED, RETROFIT, or PEDESTRIAN SIGNAL HEAD, LED, RETROFIT, for the type and number of polycarbonate signal heads, faces, and sections specified, which price shall be payment in full for furnishing the equipment described above including LED modules, all mounting hardware, and installing them in satisfactory operating condition. The type specified will indicate the number of faces and the method of mounting.

LIGHT EMITTING DIODE (LED) PEDESTRIAN SIGNAL HEAD

Add the following to the third paragraph of Article 881.03 of the Standard Specifications:

No mixing of different types of pedestrian traffic signals or displays will be permitted.

Add the following to Article 881.03 of the Standard Specifications:

(a) Pedestrian Countdown Signal Heads.

(1) Pedestrian Countdown Signal Heads shall not be installed at signalized intersections where traffic signals and railroad warning devices are interconnected.

(2) Pedestrian Countdown Signal Heads shall be 16 inch (406mm) x 18 inch (457mm), for single units with the housings glossy black polycarbonate. Connecting hardware and mounting brackets shall be polycarbonate (black). A corrosion resistant anti-seize lubricant shall be applied to all metallic mounting bracket joints, and shall be visible to the inspector at the signal turn-on.

(3) Each pedestrian signal LED module shall be fully MUTCD compliant and shall consist of double overlay message combining full LED symbols of an Upraised Hand and a Walking Person. "Egg Crate" type sun shields are not permitted. Numerals shall measure 9 inches (229mm) in height and easily identified from a distance of 120 feet (36.6m).

Add the following to Article 881.04 of the Standard Specifications:

Basis of Payment.

The price shall include furnishing the equipment described above, all mounting hardware and installing them in satisfactory operating condition.

DETECTOR LOOP.

Revise Section 886 of the Standard Specifications to read:

Description.

This work shall consist of furnishing and installing a detector loop in the pavement.

Procedure.

A minimum of seven (7) working days prior to the Contractor cutting loops, the Contractor shall have the proposed loop locations marked and contact the Area Traffic Signal Maintenance and Operations Engineer (847) 705-4424 to inspect and approve the layout. When preformed detector loops are installed, the Contractor shall have them inspected and approved prior to the pouring of the Portland cement concrete surface, using the same notification process as above.

Installation.

Loop detectors shall be installed according to the requirements of the "District One Standard Traffic Signal Design Details." Saw-cuts (homeruns on preformed detector loops) from the loop to the edge of pavement shall be made perpendicular to the edge of pavement when possible in order to minimize the length of the saw-cut (homerun on preformed detector loops) unless directed otherwise by the Engineer or as shown on the plan.

The detector loop cable insulation shall be labeled with the cable specifications.

Each loop detector lead-in wire shall be labeled in the handhole using a Panduit PLFIM water proof tag, or an approved equal, secured to each wire with nylon ties.

Resistance to ground shall be a minimum of 100 mega-ohms under any conditions of weather or moisture. Inductance shall be more than 50 and less than 700 microhenries. Quality readings shall be more than 5.

- (a) Type I. All loops installed in new asphalt pavement shall be installed in the binder course and not in the surface course. The edge of pavement, curb and handhole shall be cut with a 1/4 inch (6.3 mm) deep x 4 inches (100 mm) saw cut to mark location of each loop lead-in.
- (b) Loop sealant shall be a two-component thixotropic chemically cured polyurethane either Chemque Q-Seal 295, Percol Elastic Cement AC Grade or an approved equal. The sealant shall be installed 1/8 inch (3 mm) below the pavement surface, if installed above the surface the overlap shall be removed immediately.
- (c) Detector loop measurements shall include the saw cut and the length of the loop lead-in to the edge of pavement. The lead-in wire, including all necessary connections for proper operations, from the edge of pavement to the handhole, shall be included in the price of the detector loop. Unit duct, trench and backfill, and drilling of pavement or handholes shall be included in detector loop quantities.
- (d) Preformed. This work shall consist of furnishing and installing a rubberized or crosslinked polyethylene heat resistant preformed traffic signal loop in accordance with the Standard Specifications, except for the following:
 - (e) Preformed detector loops shall be installed in new pavement constructed of Portland cement concrete using mounting chairs or tied to re-bar or the preformed detector loops may be placed in the sub-base. Loop lead-ins shall be extended to a temporary protective enclosure near the proposed handhole location. The protective enclosure shall provide sufficient protection from other construction activities and may be buried for additional protection.
 - (f) Handholes shall be placed next to the shoulder or back of curb when preformed detector loops enter the handhole. Non-metallic coilable duct, included in this pay item, shall be used to protect the preformed lead-ins from back of curb to the handhole.
 - (g) Preformed detector loops shall be factory assembled with ends capped and sealed against moisture and other contaminants. Homeruns and interconnects shall be pre-wired and shall be an integral part of the loop assembly. The loop configurations and homerun lengths shall be assembled for the specific application. The loop and homerun shall be constructed using 11/16 inch (17.2 mm) outside diameter (minimum), 3/8 inch (9.5 mm) inside diameter (minimum) Class A oil resistant synthetic cord reinforced hydraulic hose with 250 psi (1,720 kPa) internal pressure rating or a similarly sized XLPE cable jacket. Hose for the loop and homerun assembly shall be one continuous piece. No joints or splices shall be allowed in the hose except where necessary to connect homeruns or interconnects to the loops. This will provide maximum wire protection and loop system strength. Hose tee connections shall be heavy duty high temperature synthetic rubber. The tee shall be of proper size to attach directly to the hose, minimizing glue joints. The tee shall have the same flexible properties as the hose to insure that the whole assembly can conform to pavement movement and shifting without cracking or breaking. For XLPE jacketed preformed loops, all splice connections shall be soldered, sealed, and tested before being sealed in a high impact glass impregnated plastic splice enclosure. The wire used shall be #16 THWN stranded copper. The number of turns in the loop shall be application specific. Homerun wire pairs shall be

twisted a minimum of four turns per foot. No wire splices will be allowed in the preformed loop assembly. The loop and homeruns shall be filled and sealed with a flexible sealant to insure complete moisture blockage and further protect the wire. The preformed loops shall be constructed to allow a minimum of 6.5 feet of extra cable in the handhole.

Method of Measurement.

This work will be measured for payment in feet (meters) in place. Type I detector loop will be measured along the sawed slot in the pavement containing the loop and lead-in, rather than the actual length of the wire. Preformed detector loops will be measured along the detector loop and lead-in embedded in the pavement, rather than the actual length of the wire.

Basis of Payment.

This shall be paid for at the contract unit price per foot (meter) for DETECTOR LOOP, TYPE I or PREFORMED DETECTOR LOOP as specified in the plans, which price shall be payment in full for furnishing and installing the detector loop and all related connections for proper operation.

EMERGENCY VEHICLE PRIORITY SYSTEM.

Revise Section 887 of the Standard Specifications to read:

It shall be the Contractor's responsibility to contact the municipality or fire district to verify the brand of emergency vehicle pre-emption equipment to be installed prior to the contract bidding. The equipment must be completely compatible with all components of the equipment currently in use by the Agency.

All new installations shall be equipped with Confirmation Beacons as shown on the "District One Standard Traffic Signal Design Details." The Confirmation Beacon shall consist of a 6 watt Par 38 LED flood lamp with a 30 degree light spread, maximum 6 watt energy consumption at 120V, and a 2,000 hour warranty for each direction of pre-emption. The lamp shall have an adjustable mount with a weatherproof enclosure for cable splicing. All hardware shall be cast aluminum or stainless steel. Holes drilled into signal poles, mast arms, or posts shall require rubber grommets. In order to maintain uniformity between communities, the confirmation beacons shall indicate when the control equipment receives the pre-emption signal. The pre-emption movement shall be signaled by a flashing indication at the rate specified by Section 4L.01 of the "Manual on Uniform Traffic Control Devices," and other applicable sections of future editions. The stopped pre-empted movements shall be signaled by a continuous indication.

All light operated systems shall include security and transit preemption software and operate at a uniform rate of 14.035 Hz \pm 0.002, or as otherwise required by the Engineer, and provide compatible operation with other light systems currently being operated in the District.

This item shall include any required modifications to an existing traffic signal controller as a result of the addition of the EMERGENCY VEHICLE PRIORITY SYSTEM.

Basis of Payment.

The work shall be paid for at the contract unit price each for furnishing and installing LIGHT DETECTOR and LIGHT DETECTOR AMPLIFIER. Furnishing and installing the confirmation beacon shall be included in the cost of the Light Detector. Any required modifications to the traffic signal controller shall be included in the cost of the LIGHT DETECTOR AMPLIFIER. The preemption detector amplifier shall be paid for on a basis of (1) one each per intersection controller and shall provide operation for all movements required in the pre-emption phase sequence.

TEMPORARY TRAFFIC SIGNAL INSTALLATION.

Revise Section 890 of the Standard Specifications to read:

Description.

This work shall consist of furnishing, installing, maintaining, and removing a temporary traffic signal installation as shown on the plans, including but not limited to temporary signal heads, emergency vehicle priority systems, interconnect, vehicle detectors, uninterruptible power supply, and signing. Temporary traffic signal controllers and cabinets interconnected to railroad traffic control devices shall be new. When temporary traffic signals will be operating within a county or local agency Traffic Management System, the equipment must be NTCIP compliant and compatible with the current operating requirements of the Traffic Management System.

General.

Only an approved equipment vendor will be allowed to assemble the temporary traffic signal cabinet. Also, an approved equipment vendor shall assemble and test a temporary railroad traffic signal cabinet. (Refer to the "Inspection of Controller and Cabinet" specification). A representative of the approved control equipment vendor shall be present at the temporary traffic signal turn-on inspection.

Construction Requirements.

(a) Controllers.

1. Only controllers supplied by one of the District approved closed loop equipment manufacturers will be approved for use at temporary signal locations. All controllers used for temporary traffic signals shall be fully actuated NEMA microprocessor based with RS232 data entry ports compatible with existing monitoring software approved by IDOT District 1, installed in NEMA TS2 cabinets with 8 phase back panels, capable of supplying 255 seconds of cycle length and individual phase length settings up to 99 seconds. On projects with one lane open and two way traffic flow, such as bridge deck repairs, the temporary signal controller shall be capable of providing an adjustable all red clearance setting of up to 30 seconds in length. All controllers used for temporary traffic signals shall meet or exceed the requirements of Section 857 of the Standard Specifications with regards to internal time base coordination and preemption. All railroad interconnected temporary controllers and cabinets shall be new and shall satisfy the requirements of Article 857.02 of the Standard Specifications as modified herein.

2. Only control equipment, including controller cabinet and peripheral equipment, supplied

by one of the District approved closed loop equipment manufacturers will be approved for use at temporary traffic signal locations. All control equipment for the temporary traffic signal(s) shall be furnished by the Contractor unless otherwise stated in the plans. On projects with multiple temporary traffic signal installations, all controllers shall be the same manufacturer brand and model number with current software installed.

(b) Cabinets. All temporary traffic signal cabinets shall have a closed bottom made of aluminum alloy. The bottom shall be sealed along the entire perimeter of the cabinet base to ensure a water, dust and insect-proof seal. The bottom shall provide a minimum of two (2) 4 inch (100 mm) diameter holes to run the electric cables through. The 4 inch (100 mm) diameter holes shall have a bushing installed to protect the electric cables and shall be sealed after the electric cables are installed.

(c) Grounding. Grounding shall be provided for the temporary traffic signal cabinet meeting or exceeding the applicable portions of the National Electrical Code, Section 806 of the Standard Specifications and shall meet the requirements of the District 1 Traffic Signal Specifications for "Grounding of Traffic Signal Systems."

(d) Traffic Signal Heads. All traffic signal sections and pedestrian signal sections shall be 12 inches (300 mm). Traffic signal sections shall be LED with expandable view, unless otherwise approved by the Engineer. Pedestrian signal heads shall be Light Emitting Diode (LED) Pedestrian Countdown Signal Heads except when a temporary traffic signal is installed at an intersection interconnected with a railroad grade crossing. When a temporary traffic signal is installed at an intersection interconnected with a railroad grade crossing, Light Emitting Diode (LED) Pedestrian Signal Heads shall be furnished. The temporary traffic signal heads shall be placed as indicated on the temporary traffic signal plan or as directed by the Engineer. The Contractor shall furnish enough extra cable length to relocate heads to any position on the span wire or at locations illustrated on the plans for construction staging. The temporary traffic signal shall remain in operation during all signal head relocations. Each temporary traffic signal head shall have its own cable from the controller cabinet to the signal head.

(e) Interconnect.

1. Temporary traffic signal interconnect shall be provided using fiber optic cable or wireless interconnect technology as specified in the plans. The Contractor may request, in writing, to substitute the fiber optic temporary interconnect indicated in the contract documents with a wireless interconnect. The Contractor must provide assurances that the radio device will operate properly at all times and during all construction staging. If approved for use by the Engineer, the Contractor shall submit marked-up traffic signal plans indicating locations of radios and antennas and installation details. If wireless interconnect is used, and in the opinion of the engineer, it is not viable, or if it fails during testing or operations, the Contractor shall be responsible for installing all necessary poles, fiber optic cable, and other infrastructure for providing temporary fiber optic interconnect at no cost to the contract.

2. The existing system interconnect and phone lines are to be maintained as part of the Temporary Traffic Signal Installation specified for on the plan. The interconnect shall be installed into the temporary controller cabinet as per the notes or details on the plans. All labor and equipment required to install and maintain the existing interconnect as part of the

Temporary Traffic Signal Installation shall be included in the item Temporary Traffic Signal Installation. When shown in the plans, temporary traffic signal interconnect equipment shall be furnished and installed. The temporary traffic signal interconnect shall maintain interconnect communications throughout the entire signal system for the duration of the project.

3. Temporary wireless interconnect, complete. The radio interconnect system shall be compatible with Eagle or Econolite controller closed loop systems. This item shall include all temporary wireless interconnect components, complete, at the adjacent existing traffic signal(s) to provide a completely operational closed loop system. This item shall include all materials, labor and testing to provide the completely operational closed loop system as shown on the plans. The radio interconnect system shall include the following components:

- a. Rack or Shelf Mounted RS-232 Frequency Hopping Spread Spectrum (FHSS) Radio
- b. Software for Radio Configuration (Configure Frequency and Hopping Patterns)
- c. Antennas (Omni Directional or Yagi Directional)
- d. Antenna Cables, LMR400, Low Loss. Max. 100-ft from controller cabinet to antenna
- e. Brackets, Mounting Hardware, and Accessories Required for Installation
- f. RS232 Data Cable for Connection from the radio to the local or master controller
- g. All other components required for a fully functional radio interconnect system

All controller cabinet modifications and other modifications to existing equipment that are required for the installation of the radio interconnect system components shall be included in this item.

The radio interconnect system may operate at 900Mhz (902-928) or 2.4 Ghz depending on the results of a site survey. The telemetry shall have an acceptable rate of transmission errors, time outs, etc. comparable to that of a hardwire system.

The proposed master controller and telemetry module shall be configured for use with the radio interconnect at a minimum rate of 9600 baud.

The radio interconnect system shall include all other components required for a complete and fully functional telemetry system and shall be installed in accordance to the manufacturers recommendations.

The following radio equipment is currently approved for use in Region One/District One: Encom Model 5100 and Intuicom Communicator II.

(f) Emergency Vehicle Pre-Emption. All emergency vehicle preemption equipment (light detectors, light detector amplifiers, confirmation beacons, etc.) as shown on the temporary traffic signal plans shall be provided by the Contractor. It shall be the Contractor's responsibility to contact the municipality or fire district to verify the brand of emergency vehicle preemption equipment to be installed prior to the contract bidding. The equipment must be completely compatible with all components of the equipment currently in use by the Agency. All light operated systems shall operate at a uniform rate of 14.035 hz \pm 0.002, or as otherwise required by the Engineer, and provide compatible operation with other light systems currently being operated in the District. All labor and material required to install and maintain the Emergency Vehicle Preemption installation shall be included in the item Temporary Traffic Signal

Installation.

(g) Vehicle Detection. All temporary traffic signal installations shall have vehicular detection installed as shown on the plans or as directed by the Engineer. Pedestrian push buttons shall be provided for all pedestrian signal heads/phases as shown on the plans or as directed by the Engineer. All approaches shall have vehicular detection provided by vehicle detection system as shown on the plans or as directed by the Engineer. Microwave vehicle sensors or video vehicle detection system shall be approved by IDOT prior to Contractor furnishing and installing. The Contractor shall install, wire, and adjust the alignment of the microwave vehicle sensor or video vehicle detection system in accordance to the manufacturer's recommendations and requirements. The Contractor shall be responsible for adjusting the alignment of the microwave vehicle sensor or video vehicle detection system for all construction staging changes and for maintaining proper alignment throughout the project. A representative of the approved control equipment vendor shall be present and assist the contractor in setting up and maintaining the microwave vehicle sensor or video vehicle detection system. An in-cabinet video monitor shall be provided with all video vehicle detection systems and shall be included in the item Temporary Traffic Signal Installation.

(h) Uninterruptible Power Supply. All temporary traffic signal installations shall have Uninterruptible Power Supply (UPS). The UPS cabinet shall be mounted to the temporary traffic signal cabinet and meet the requirements of Uninterruptible Power Supply in Divisions 800 and 1000 of these specifications.

(i) Signs. All existing street name and intersection regulatory signs shall be removed from existing poles and relocated to the temporary signal span wire. If new mast arm assembly and pole(s) and posts are specified for the permanent signals, the signs shall be relocated to the new equipment at no extra cost. Any intersection regulatory signs that are required for the temporary traffic signal shall be provided as shown on the plans or as directed by the Engineer. Relocation, removing, bagging and installing the regulatory signs for the various construction stages shall be provided as shown on the plans or as directed by the Engineer.

(j) Energy Charges. The electrical utility energy charges for the operation of the temporary traffic signal installation shall be paid for by others if the installation replaces an existing signal. Otherwise charges shall be paid for under 109.05 of the Standard Specifications.

(k) Maintenance. Maintenance shall meet the requirements of the Standard Specifications and MAINTENANCE OF EXISTING TRAFFIC SIGNAL INSTALLATION in Division 800 of these specifications. Maintenance of temporary signals and of the existing signals shall be included in the cost of the TEMPORARY TRAFFIC SIGNAL INSTALLATION pay item. When temporary traffic signals are to be installed at locations where existing signals are presently operating, the Contractor shall be fully responsible for the maintenance of the existing signal installation as soon as he begins any physical work on the Contract or any portion thereof. In addition, a minimum of seven (7) days prior to assuming maintenance of the existing traffic signal installation(s) under this Contract, the Contractor shall request that the Resident Engineer contact the Bureau of Traffic Operations (847) 705-4424 for an inspection of the installation(s).

(l) Temporary Traffic Signals for Bridge Projects. Temporary Traffic Signals for bridge projects shall follow the State Standards, Standard Specifications, District One Traffic Signal

Specifications and any plans for Bridge Temporary Traffic Signals included in the plans. The installation shall meet the Standard Specifications and all other requirements in this TEMPORARY TRAFFIC SIGNAL INSTALLATION specification. In addition all electric cable shall be aurally suspended, at a minimum height of 18 feet (5.5m) on temporary wood poles (Class 5 or better) of 45 feet (13.7 m) minimum height. The signal heads shall be span wire mounted or bracket mounted to the wood pole or as directed by the Engineer. The Controller cabinet shall be mounted to the wood pole as shown in the plans, or as directed by the Engineer. Microwave vehicle sensors or video vehicle detection system may be used in place of detector loops as approved by the Engineer.

(m) Temporary Portable Traffic Signal for Bridge Projects.

1. Unless otherwise directed by the Engineer, temporary portable traffic signals shall be restricted to use on roadways of less than 8000 ADT that have limited access to electric utility service, shall not be installed on projects where the estimated need exceeds ten (10) weeks, and shall not be in operation during the period of November through March. The Contractor shall replace the temporary portable traffic signals with temporary span wire traffic signals noted herein at no cost to the contract if the bridge project or Engineer requires temporary traffic signals to remain in operation into any part of period of November through March. If, in the opinion of the engineer, the reliability and safety of the temporary portable traffic signal is not similar to that of a temporary span wire traffic signal installation, the Contractor shall replace the temporary portable traffic signals with temporary span wire traffic signals noted herein at no cost to the contract.

2. The controller and LED signal displays shall meet the Standard Specifications and all other requirements in this TEMPORARY TRAFFIC SIGNAL INSTALLATION specification.

3. Work shall be according to Article 701.18(b) of the Standard Specifications except as noted herein.

4. General.

a. The temporary portable bridge traffic signals shall be trailer-mounted units. The trailer-mounted units shall be set up securely and level. Each unit shall be self-contained and consist of two signal heads. The left signal head shall be mounted on a mast arm capable of extending over the travel lane. Each unit shall contain a solar cell system to facilitate battery charging. There shall be a minimum of 12 days backup reserve battery supply and the units shall be capable of operating with a 120 V power supply from a generator or electrical service.

b. All signal heads located over the travel lane shall be mounted at a minimum height of 17 feet (5m) from the bottom of the signal back plate to the top of the road surface. All far right signal heads located outside the travel lane shall be mounted at a minimum height of 8 feet (2.5m) from the bottom of the signal back plate to the top of the adjacent travel lane surface.

c. The long all red intervals for the traffic signal controller shall be adjustable up to 250 seconds in one-second increments.

d. As an alternative to detector loops, temporary portable bridge traffic signals may be

equipped with microwave sensors or other approved methods of vehicle detection and traffic actuation.

e. All portable traffic signal units shall be interconnected using hardwire communication cable. Radio communication equipment may be used only with the approval of the Engineer. If radio communication is used, a site analysis shall be completed to ensure that there is no interference present that would affect the traffic signal operation. The radio equipment shall meet all applicable FCC requirements.

f. The temporary portable bridge traffic signal system shall meet the physical display and operational requirements of conventional traffic signals as specified in Part IV and other applicable portions of the currently adopted version of the Manual on Uniform Traffic Control Devices (MUTCD) and the Illinois MUTCD. The signal system shall be designed to continuously operate over an ambient temperature range between -30 °F (-34 °C) and 120 °F (48 °C). When not being utilized to inform and direct traffic, portable signals shall be treated as nonoperating equipment according to Article 701.11.

g. Basis of Payment. This work will be paid for according to Article 701.20(c).

Basis of Payment.

This work shall be paid for at the contract unit price each for TEMPORARY TRAFFIC SIGNAL INSTALLATION, TEMPORARY BRIDGE TRAFFIC SIGNAL INSTALLATION, or TEMPORARY PORTABLE BRIDGE TRAFFIC SIGNAL INSTALLATION, the price of which shall include all costs for the modifications required for traffic staging, changes in signal phasing as required in the Contract plans, microwave vehicle sensors, video vehicle detection system, any maintenance or adjustment to the microwave vehicle sensors/video vehicle detection system, the temporary wireless interconnect system complete, temporary fiber optic interconnect system complete, all material required, the installation and complete removal of the temporary traffic signal. Each intersection will be paid for separately.

REMOVE EXISTING TRAFFIC SIGNAL EQUIPMENT.

Add the following to Article 895.05 of the Standard Specifications:

The traffic signal equipment which is to be removed and is to become the property of the Contractor shall be disposed of outside the right-of-way at the Contractor's expense.

All equipment to be returned to the State shall be delivered by the Contractor to the State's Traffic Signal Maintenance Contractor's main facility. The Contractor shall contact the State's Electrical Maintenance Contractor to schedule an appointment to deliver the equipment. No equipment will be accepted without a prior appointment. All equipment shall be delivered within 30 days of removing it from the traffic signal installation. The Contractor shall provide 5 copies of a list of equipment that is to remain the property of the State, including model and serial numbers, where applicable. The Contractor shall also provide a copy of the Contract plan or special provision showing the quantities and type of equipment. Controllers and peripheral equipment from the same location shall be boxed together (equipment from different locations may not be mixed) and all boxes and controller cabinets shall be clearly marked or labeled with

the location from which they were removed. If equipment is not returned with these requirements, it will be rejected by the State's Electrical Maintenance Contractor. The Contractor shall be responsible for the condition of the traffic signal equipment from the time Contractor takes maintenance of the signal installation until the acceptance of a receipt drawn by the State's Electrical Maintenance Contractor indicating the items have been returned in good condition.

The Contractor shall safely store and arrange for pick up or delivery of all equipment to be returned to agencies other than the State. The Contractor shall package the equipment and provide all necessary documentation as stated above.

Traffic signal equipment which is lost or not returned to the Department for any reason shall be replaced with new equipment meeting the requirements of these Specifications at no cost to the contract.

TRAFFIC SIGNAL PAINTING.

Description.

This work shall include surface preparation, powder type painted finish application and packaging of new galvanized steel traffic signal mast arm poles and posts assemblies. All work associated with applying the painted finish shall be performed at the manufacturing facility for the pole assembly or post or at a painting facility approved by the Engineer. Traffic signal mast arm shrouds and post bases shall also be painted the same color as the pole assemblies and posts.

Surface Preparation.

All weld flux and other contaminates shall be mechanically removed. The traffic mast arms and post assemblies shall be degreased, cleaned, and air dried to assure all moisture is removed.

Painted Finish.

All galvanized exterior surfaces shall be coated with a urethane or triglycidyl isocyanurate (TGIC) polyester powder to a dry film thickness of 2.0 mils. Prior to application, the surface shall be mechanically etched by brush blasting (Ref. SSPC-SP7) and the zinc coated substrate preheated to 450 °F for a minimum one (1) hour. The coating shall be electrostatically applied and cured by elevating the zinc-coated substrate temperature to a minimum of 400 °F.

The finish paint color shall be one of the manufacturer's standard colors and shall be as selected by the local agency responsible for paint costs. The Contractor shall confirm, in writing, the color selection with the local responsible agency and provide a copy of the approval to the Engineer and a copy of the approval shall be included in the material catalog submittal.

Painting of traffic signal heads, pedestrian signal heads and controller cabinets is not included in this pay item.

Any damage to the finish after leaving the manufacturer's facility shall be repaired to the satisfaction of the Engineer using a method recommended by the manufacturer and approved by the Engineer. If while at the manufacturer's facility the finish is damaged, the finish shall be

re-applied at no cost to the contract.

Warranty.

The Contractor shall furnish in writing to the Engineer, the paint manufacturer's standard warranty and certification that the paint system has been properly applied.

Packaging.

Prior to shipping, the poles and posts shall be wrapped in ultraviolet-inhibiting plastic foam or rubberized foam.

Basis of Payment.

This work shall be paid for at the contract unit price each for PAINT NEW MAST ARM AND POLE, UNDER 40 FEET (12.19 METER), PAINT NEW MAST ARM AND POLE, 40 FEET (12.19 METER) AND OVER, PAINT NEW COMBINATION MAST ARM AND POLE, UNDER 40 FEET (12.19 METER), PAINT NEW COMBINATION MAST ARM AND POLE, 40 FEET (12.19 METER) AND OVER, or PAINT NEW TRAFFIC SIGNAL POST of the length specified, which shall be payment in full for painting and packaging the traffic signal mast arm poles and posts described above including all shrouds, bases and appurtenances.

ILLUMINATED STREET NAME SIGN

Description.

This work shall consist of furnishing and installing a LED internally illuminated street name sign.

Materials.

Materials shall be in accordance with ILLUMINATED STREET NAME SIGN in Division 1000 of these specifications.

Installation.

The sign can be mounted on most steel mast arm poles. Mounting on aluminum mast arm pole requires supporting structural calculations. Some older or special designed steel mast arm poles may require structural evaluation to assure that construction of the mast arm pole is adequate for the proposed additional loading. Structural calculations and other supporting documentation as determined by the Engineer shall be provided by the contractor for review by the Department.

The sign shall be located on a steel traffic signal mast arm no further than 8-feet from the center of the pole to the center of the sign at a height of between 16 to 18-feet above traveled pavement. Mounting hardware shall be Pelco model SE-5015, or approved equal, utilizing stainless steel components.

Signs shall be installed such that they are not energized when traffic signals are powered by an alternate energy source such as a generator or uninterruptible power supply (UPS). The signs shall be connected to the generator or UPS bypass circuitry.

Basis of Payment.

This work will be paid for at the contract unit price each for ILLUMINATED STREET NAME

SIGN, of the length specified which shall be payment in full for furnishing and installing the LED internally illuminated street sign, complete with circuitry and mounting hardware including photo cell, circuit breaker, fusing, relay, connections and cabling as shown on the plans for proper operation and installation.

RE-OPTIMIZE TRAFFIC SIGNAL SYSTEM.

Description.

This work shall consist of re-optimizing a closed loop traffic signal system according to the following Levels of work.

LEVEL I applies when improvements are made to an existing signalized intersection within an existing closed loop traffic signal system. The purpose of this work is to integrate the improvements to the subject intersection into the signal system while minimizing the impacts to the existing system operation. This type of work would be commonly associated with the addition of signal phases, pedestrian phases, or improvements that do not affect the capacity at an intersection.

LEVEL II applies when improvements are made to an existing signalized intersection within an existing closed loop traffic signal system and detailed analysis of the intersection operation is desired by the engineer, or when a new signalized or existing signalized intersection is being added to an existing system, but optimization of the entire system is not required. The purpose of this work is to optimize the subject intersection, while integrating it into the existing signal system with limited impact to the system operations. This item also includes an evaluation of the overall system operation, including the traffic responsive program.

For the purposes of re-optimization work, an intersection shall include all traffic movements operated by the subject controller and cabinet.

After the signal improvements are completed, the signal shall be re-optimized as specified by an approved Consultant who has previous experience in optimizing Closed Loop Traffic Signal Systems for District One of the Illinois Department of Transportation. The Contractor shall contact the Traffic Signal Engineer at (847) 705-4424 for a listing of approved Consultants. Traffic signal system optimization work, including fine-tuning adjustments of the optimized system, shall follow the requirements stated in the most recent IDOT District 1 SCAT Guidelines, except as note herein.

A listing of existing signal equipment, interconnect information, phasing data, and timing patterns may be obtained from the Department, if available and as appropriate. The existing SCAT Report is available for review at the District One office and if the Consultant provides blank computer disks, copies of computer simulation files for the existing optimized system and a timing database that includes intersection displays will be made for the Consultant. The Consultant shall confer with the Traffic Signal Engineer prior to optimizing the system to determine if any extraordinary conditions exist that would affect traffic flows in the vicinity of the system, in which case, the Consultant may be instructed to wait until the conditions return to normal or to follow specific instructions regarding the optimization.

(a) LEVEL I Re-Optimization

1. The following tasks are associated with LEVEL I Re-Optimization.
 - a. Appropriate signal timings shall be developed for the subject intersection and existing timings shall be utilized for the rest of the intersections in the system.
 - b. Proposed signal timing plan for the new or modified intersection(s) shall be forwarded to IDOT for review prior to implementation.
 - c. Consultant shall conduct on-site implementation of the timings at the turn-on and make fine-tuning adjustments to the timings of the subject intersection in the field to alleviate observed adverse operating conditions and to enhance operations.
2. The following deliverables shall be provided for LEVEL I Re-Optimization.
 - a. Consultant shall furnish to IDOT a cover letter describing the extent of the re-optimization work performed.
 - b. Consultant shall furnish an updated intersection graphic display for the subject intersection to IDOT and to IDOT's Traffic Signal Maintenance Contractor.

(b) LEVEL II Re-Optimization

1. In addition to the requirements described in the LEVEL I Re-Optimization above, the following tasks are associated with LEVEL II Re-Optimization.
 - a. Traffic counts shall be taken at the subject intersection after the traffic signals are approved for operation by the Area Traffic Signal Operations Engineer. Manual turning movement counts shall be conducted from 6:30 a.m. to 9:30 a.m., 11:00 a.m. to 1:00 p.m., and 3:30 p.m. to 6:30 p.m. on a typical weekday from midday Monday to midday Friday. The turning movement counts shall identify cars, and single-unit, multi-unit heavy vehicles, and transit buses.
 - b. As necessary, the intersections shall be re-addressed and all system detectors reassigned in the master controller according to the current standard of District One.
 - c. Traffic responsive program operation shall be evaluated to verify proper pattern selection and lack of oscillation and a report of the operation shall be provided to IDOT.
2. The following deliverables shall be provided for LEVEL II Re-Optimization.
 - a. Consultant shall furnish to IDOT one (1) copy of a technical memorandum for the optimized system. The technical memorandum shall include the following elements:
 - (1) Brief description of the project
 - (2) Printed copies of the analysis output from Synchro (or other appropriate, approved optimization software file)
 - (3) Printed copies of the traffic counts conducted at the subject intersection
 - b. Consultant shall furnish to IDOT two (2) CDs for the optimized system. The CDs shall include the following elements:
 - (1) Electronic copy of the technical memorandum in PDF format
 - (2) Revised Synchro files (or other appropriate, approved optimization software file) including the new signal and the rest of the signals in the closed loop system
 - (3) Traffic counts conducted at the subject intersection
 - (4) New or updated intersection graphic display file for the subject intersection
 - (5) The CD shall be labeled with the IDOT system number and master location, as well as the submittal date and the consultant logo. The CD case shall include a clearly readable label

displaying the same information securely affixed to the side and front.

Basis of Payment.

This work shall be paid for at the contract unit price each for RE-OPTIMIZE TRAFFIC SIGNAL SYSTEM – LEVEL I or RE-OPTIMIZE TRAFFIC SIGNAL SYSTEM – LEVEL II, which price shall be payment in full for performing all work described herein per intersection. Following completion of the timings and submittal of specified deliverables, 100 percent of the bid price will be paid. Each intersection will be paid for separately.

OPTIMIZE TRAFFIC SIGNAL SYSTEM.

Description.

This work shall consist of optimizing a closed loop traffic signal system.

OPTIMIZE TRAFFIC SIGNAL SYSTEM applies when a new or existing closed loop traffic signal system is to be optimized and a formal Signal Coordination and Timing (SCAT) Report is to be prepared. The purpose of this work is to improve system performance by optimizing traffic signal timings, developing a time of day program and a traffic responsive program.

After the signal improvements are completed, the signal system shall be optimized as specified by an approved Consultant who has previous experience in optimizing Closed Loop Traffic Signal Systems for District One of the Illinois Department of Transportation. The Contractor shall contact the Traffic Signal Engineer at (847) 705-4424 for a listing of approved Consultants. Traffic signal system optimization work, including fine-tuning adjustments of the optimized system, shall follow the requirements stated in the most recent IDOT District 1 SCAT Guidelines, except as note herein.

A listing of existing signal equipment, interconnect information, phasing data, and timing patterns may be obtained from the Department, if available and as appropriate. The existing SCAT Report is available for review at the District One office and if the Consultant provides blank computer disks, copies of computer simulation files for the existing optimized system and a timing database that includes intersection displays will be made for the Consultant. The Consultant shall confer with the Traffic Signal Engineer prior to optimizing the system to determine if any extraordinary conditions exist that would affect traffic flows in the vicinity of the system, in which case, the Consultant may be instructed to wait until the conditions return to normal or to follow specific instructions regarding the optimization.

(a) The following tasks are associated with OPTIMIZE TRAFFIC SIGNAL SYSTEM.

1. Appropriate signal timings and offsets shall be developed for each intersection and appropriate cycle lengths shall be developed for the closed loop signal system.

2. Traffic counts shall be taken at all intersections after the permanent traffic signals are approved for operation by the Area Traffic Signal Operations Engineer. Manual turning movement counts shall be conducted from 6:30 a.m. to 9:30 a.m., 11:00 a.m. to 1:00 p.m., and 3:30 p.m. to 6:30 p.m. on a typical weekday from midday Monday to midday Friday. The turning movement counts shall identify cars, and single-unit and multi-unit heavy vehicles.

3. As necessary, the intersections shall be re-addressed and all system detectors reassigned in the master controller according to the current standard of District One.
 4. A traffic responsive program shall be developed, which considers both volume and occupancy. A time-of-day program shall be developed for used as a back-up system.
 5. Proposed signal timing plan for the new or modified intersection shall be forwarded to IDOT for review prior to implementation.
 6. Consultant shall conduct on-site implementation of the timings and make fine-tuning adjustments to the timings in the field to alleviate observed adverse operating conditions and to enhance operations.
 7. Speed and delay studies shall be conducted during each of the count periods along the system corridor in the field before and after implementation of the proposed timing plans for comparative evaluations. These studies should utilize specialized electronic timing and measuring devices.
- (b) The following deliverables shall be provided for OPTIMIZE TRAFFIC SIGNAL SYSTEM.
1. Consultant shall furnish to IDOT one (1) copy of a SCAT Report for the optimized system. The SCAT Report shall include the following elements:

Cover Page in color showing a System Map
Figures <ol style="list-style-type: none"> 1. System overview map – showing system number, system schematic map with numbered system detectors, oversaturated movements, master location, system phone number, cycle lengths, and date of completion. 2. General location map in color – showing signal system location in the metropolitan area. 3. Detail system location map in color – showing cross street names and local controller addresses. 4. Controller sequence – showing controller phase sequence diagrams.
Table of Contents
Tab 1: Final Report <ol style="list-style-type: none"> 1. Project Overview 2. System and Location Description (Project specific) 3. Methodology 4. Data Collection 5. Data Analysis and Timing Plan Development 6. Implementation <ol style="list-style-type: none"> a. Traffic Responsive Programming (Table of TRP vs. TOD Operation) 7. Evaluation <ol style="list-style-type: none"> a. Speed and Delay runs
Tab 2. Turning Movement Counts <ol style="list-style-type: none"> 1. Turning Movement Counts (Showing turning movement counts in the intersection diagram for each period, including truck percentage)
Tab 3. Synchro Analysis

<ol style="list-style-type: none">1. AM: Time-Space diagram in color, followed by intersection Synchro report (Timing report) summarizing the implemented timings.2. Midday: same as AM3. PM: same as AM
Tab 4: Speed, Delay Studies <ol style="list-style-type: none">1. Summary of before and after runs results in two (2) tables showing travel time and delay time.2. Plot of the before and after runs diagram for each direction and time period.
Tab 5: Environmental Report <ol style="list-style-type: none">1. Environmental impact report including gas consumption, NO₂, HCCO, improvements.
Tab 6: Electronic Files <ol style="list-style-type: none">1. Two (2) CDs for the optimized system. The CDs shall include the following elements:<ol style="list-style-type: none">a. Electronic copy of the SCAT Report in PDF formatb. Copies of the Synchro files for the optimized systemc. Traffic counts for the optimized systemd. New or updated intersection graphic display files for each of the system intersections and the system graphic display file including system detector locations and addresses.

Basis of Payment.

The work shall be paid for at the contract unit each for OPTIMIZE TRAFFIC SIGNAL SYSTEM, which price shall be payment in full for performing all work described herein for the entire traffic signal system. Following the completion of traffic counts, 25 percent of the bid price will be paid. Following the completion of the Synchro analysis, 25 percent of the bid price will be paid. Following the setup and fine tuning of the timings, the speed-delay study, and the TRP programming, 25 percent of the bid price will be paid. The remaining 25 percent will be paid when the system is working to the satisfaction of the engineer and the report and CD have been submitted.

TEMPORARY TRAFFIC SIGNAL TIMINGS

Description.

This work shall consist of developing and maintaining appropriate traffic signal timings for the specified intersection for the duration of the temporary signalized condition, as well as impact to existing traffic signal timings caused by detours or other temporary conditions.

All timings and adjustments necessary for this work shall be performed by an approved Consultant who has previous experience in optimizing Closed Loop Traffic signal Systems for District One of the Illinois Department of Transportation. The Contractor shall contact the Traffic Signal Engineer at (847) 705-4424 for a listing of approved Consultants.

The following tasks are associated with TEMPORARY TRAFFIC SIGNAL TIMINGS.

- (a) Consultant shall attend temporary traffic signal inspection (turn-on) and/or detour meeting and conduct on-site implementation of the traffic signal timings. Make fine-tuning

adjustments to the timings in the field to alleviate observed adverse operating conditions and to enhance operations.

- (b) Consultant shall provide monthly observation of traffic signal operations in the field.
- (c) Consultant shall provide on-site consultation and adjust timings as necessary for construction stage changes, temporary traffic signal phase changes, and any other conditions affecting timing and phasing, including lane closures, detours, and other construction activities.
- (d) Consultant shall make timing adjustments and prepare comment responses as directed by the Area Traffic Signal Operations Engineer.

Basis of Payment.

The work shall be paid for at the contract unit price each for TEMPORARY TRAFFIC SIGNAL TIMINGS, which price shall be payment in full for performing all work described herein per intersection. When the temporary traffic signal installation is turned on and/or detour implemented, 50 percent of the bid price will be paid. The remaining 50 percent of the bid price will be paid following the removal of the temporary traffic signal installation and/or detour.

MODIFYING EXISTING CONTROLLER CABINET.

The work shall consist of modifying an existing controller cabinet as follows:

(a) Uninterruptible Power Supply (UPS). The addition of uninterruptible power supply (UPS) to an existing controller cabinet could require the relocation of the existing controller cabinet items to allow for the installation of the uninterruptible power supply (UPS) components inside the existing controller cabinet as outlined under Sections 862 and 1074.04 of the Standard Specifications.

(b) Light Emitting Diode (LED) Signal Heads, Light Emitting Diode (LED) Optically Programmed Signal Heads and Light Emitting Diode (LED) Pedestrian Signal Heads. The contractor shall verify that the existing load switches meet the requirements of Section 1074.03(5)(b)(2) of the Standard Specifications and the recommended load requirements of the light emitting diode (LED) signal heads that are being installed at the existing traffic signal. If any of the existing load switches do not meet these requirements, they shall be replaced, as directed by the Engineer.

(c) Light Emitting Diode (LED), Signal Head, Retrofit. The contractor shall verify that the existing load switches meet the requirements of Section 1074.03(2) of the Standard Specifications and the recommended load requirements of light emitting diode (LED) traffic signal modules, pedestrian signal modules, and pedestrian countdown signal modules as specified in the plans. If any of the existing load switches do not meet these requirements, they shall be replaced, as directed by the Engineer.

Basis of Payment.

Modifying an existing controller cabinet will be paid for at the contract unit price per each for Modify Existing Controller Cabinet. This shall include all material and labor required to complete the work as described above, the removal and disposal of all items removed from the controller cabinet, as directed by the Engineer. The equipment for the Uninterruptible Power Supply (UPS) and labor to install it in the existing controller cabinet shall be included in the pay item Uninterruptible Power Supply. Modifying an existing controller will be paid for at the contract unit price per each for Modify Existing Controller, per Sections 895.04 and 895.08 of the Standard Specifications.

DIVISION 1000 MATERIALS

PEDESTRIAN PUSH-BUTTON.

Revise Article 1074.02(a) of the Standard Specifications to read:

The pedestrian push-button housing shall be constructed of aluminum alloy according to ASTM B 308 6061-T6 and powder coated yellow, unless otherwise noted on the plans. The housing shall be furnished with suitable mounting hardware.

Revise Article 1074-02(e) of the Standard Specifications to read:

Stations shall be designed to be mounted directly to a post, mast arm pole or wood pole. The station shall be aluminum and shall accept a 3 inch (75mm) round push-button assembly and a regulatory pedestrian instruction sign according to MUTCD, sign series R10-3e 9 x 15 inch sign with arrow(s) for a count-down pedestrian signal. The pedestrian station size without count-down pedestrian signals shall accommodate a MUTCD sign series R10-3b or R10-3d 9 x 12 inch sign with arrow(s).

Add the following to Article 1074.02(a) of the Standard Specifications:

(f) Location. Pedestrian push-buttons and stations shall be mounted directly to a post, mast arm pole or wood pole as shown on the plans and shall be fully accessible from a paved or concrete surface. See the District's Detail sheets for orientation and mounting details.

CONTROLLER CABINET AND PERIPHERAL EQUIPMENT.

Add the following to Article 1074.03 of the Standard Specifications:

(a) (6) Cabinets shall be designed for NEMA TS2 Type 1 operation. All cabinets shall be pre-wired for a minimum of eight (8) phases of vehicular, four (4) phases of pedestrian and four (4) phases of overlap operation.

(b) (5) Cabinets – Provide 1/8" (3.2 mm) thick unpainted aluminum alloy 5052-H32. The surface shall be smooth, free of marks and scratches. All external hardware shall be stainless steel.

(b) (6) Controller Harness – Provide a TS2 Type 2 "A" wired harness in addition to the TS2 Type 1 harness.

(b) (7) Surge Protection – Plug-in type EDCO SHA-1250 or Atlantic/Pacific approved equal.

(b) (8) BIU – Containment screw required.

(b) (9) Transfer Relays – Solid state or mechanical flash relays are acceptable.

(b) (10) Switch Guards – All switches shall be guarded.

(b) (11) Heating – One (1) 200 watt, thermostatically-controlled, Hoffman electric heater, or approved equivalent.

(b) (12) Lighting – One (1) LED Panel shall be placed inside the cabinet top panel and one (1) LED Panel shall be placed on each side of the pull-out drawer/shelf assembly located beneath the controller support shelf. The LED Panels shall be controlled by a wall switch.

Relume Traffic Control Box LED Panels and power supply or approved equivalent.

(b) (13) The cabinet shall be equipped with a pull-out drawer/shelf assembly. A 1 ½ inch (38mm) deep drawer shall be provided in the cabinet, mounted directly beneath the controller support shelf. The drawer shall have a hinged top cover and shall be capable of accommodating one (1) complete set of cabinet prints and manuals. This drawer shall support 50 lbs. (23 kg) in weight when fully extended. The drawer shall open and close smoothly. Drawer dimensions shall make maximum use of available depth offered by the controller shelf and be a minimum of 24 inches (610mm) wide.

(b) (14) Plan & Wiring Diagrams – 12" x 16" (3.05mm x 4.06mm) moisture sealed container attached to door.

(b) (15) Detector Racks – Fully wired and labeled for four (4) channels of emergency vehicle pre-emption and sixteen channels (16) of vehicular operation.

(b) (16) Field Wiring Labels – All field wiring shall be labeled.

(b) (17) Field Wiring Termination – Approved channel lugs required.

(b) (18) Power Panel – Provide a nonconductive shield.

(b) (19) Circuit Breaker – The circuit breaker shall be sized for the proposed load but shall not be rated less than 30 amps.

(b) (20) Police Door – Provide wiring and termination for plug in manual phase advance switch.

(b) (21) Railroad Pre-Emption Test Switch – Eaton 8830K13 SHA 1250 or equivalent.

RAILROAD, FULL-ACTUATED CONTROLLER AND CABINET.

Controller shall comply with Article 1073.01 as amended in these Traffic Signal Special Provisions.

Controller Cabinet and Peripheral Equipment shall comply with Article 1074.03 as amended in these Traffic Signal Special Provisions.

Add the following to Articles 1073.01 (c) (2) and 1074.03 (a) (5) (e) of the Standard Specifications:

Controllers and cabinets shall be new and NEMA TS2 Type 1 design.

A method of monitoring and/or providing redundancy to the railroad preemtor input to the controller shall be included as a component of the Railroad, Full Actuated Controller and Cabinet installation and be verified by the traffic signal equipment supplier prior to installation.

Railroad interconnected controllers and cabinets shall be assembled only by an approved traffic signal equipment supplier. All railroad interconnected (including temporary railroad interconnect) controllers and cabinets shall be new, built, tested and approved by the controller equipment vendor, in the vendor's District One facility, prior to field installation. The vendor shall provide the technical equipment and assistance as required by the Engineer to fully test this equipment.

UNINTERRUPTIBLE POWER SUPPLY (UPS).

Revise Article 1074.04(a)(1) of the Standard Specifications to read:

The UPS shall be line interactive and provide voltage regulation and power conditioning when utilizing utility power. The UPS shall be sized appropriately for the intersection's normal traffic signal operating connected load, plus 20 percent (20%). The total connected traffic signal load shall not exceed the published ratings for the UPS. The UPS shall provide a minimum of six (6) hours of normal operation run-time for signalized intersections with LED type signal head optics at 77 °F (25 °C) (minimum 700 W/1000 VA active output capacity, with 90 percent minimum inverter efficiency).

Revise the first paragraph of Article 1074.04(a)(3) of the Standard Specifications to read:

The UPS shall have a minimum of four (4) sets of normally open (NO) and normally closed (NC) single-pole double-throw (SPDT) relay contact closures, available on a panel mounted terminal block or locking circular connectors, rated at a minimum 120 V/1 A, and labeled so as to identify each contact according to the plans.

Revise Article 1074.04(a)(10) of the Standard Specifications to read:

The UPS shall be compatible with the District's approved traffic controller assemblies utilizing NEMA TS 1 or NEMA TS 2 controllers and cabinet components for full time operation.

Revise Article 1074.04(a)(17) of the Standard Specifications to read:

When the intersection is in battery backup mode, the UPS shall bypass all internal cabinet lights, ventilation fans, cabinet heaters, service receptacles, any lighted street name signs, any automated enforcement equipment and any other devices directed by the Engineer.

Revise Article 1074.04(b)(2)b of the Standard Specifications to read:

Batteries, inverter/charger and power transfer relay shall be housed in a separate NEMA Type 3R cabinet. The cabinet shall be Aluminum alloy, 5052-H32, 0.125-inch thick and have a natural mill finish.

Revise Article 1074.04(b)(2)c of the Standard Specifications to read:

No more than three batteries shall be mounted on individual shelves for a cabinet housing six batteries and no more than four batteries per shelf for a cabinet housing eight batteries.

Revise Article 1074.04(b)(2)e of the Standard Specifications to read:

The battery cabinet housing shall have the following nominal outside dimensions: a width of 25 in. (785 mm), a depth of 16 in. (440 mm), and a height of 41 to 48 in. (1.1 to 1.3 m). Clearance between shelves shall be a minimum of 10 in. (250 mm).

UPS

End of paragraph 1074.04(b) (2)e

The door shall be equipped with a two position doorstop, one a 90° and one at 120°.

Revise Article 1074.04(b)(2)g of the Standard Specifications to read:

The door shall open to the entire cabinet, have a neoprene gasket, an Aluminum continuous piano hinge with stainless steel pin, and a three point locking system. The cabinet shall be provided with a main door lock which shall operate with a traffic industry conventional No. 2 key. Provisions for padlocking the door shall be provided.

Add the following to Article 1074.04(b)(2) of the Standard Specifications:

j. The battery cabinet shall have provisions for an external generator connection.

Add the following to Article 1074.04(c) of the Standard Specifications:

(8) The UPS shall include a tip or kill switch installed in the battery cabinet, which shall completely disconnect power from the UPS when the switch is manually activated.

(9) The UPS shall incorporate a flanged electric generator inlet for charging the batteries and operating the UPS. The generator connector shall be male type, twist-lock, rated as 15A, 125VAC with a NEMA L5-15P configuration and weatherproof lift cover plate (Hubbell model HBL4716C or approved equal). Access to the generator inlet shall be from a secured weatherproof lift cover plate or behind a locked battery cabinet police panel.

Battery System.

Revise Article 1074.04(d)(3) of the Standard Specifications to read:

All batteries supplied in the UPS shall be either gel cell or AGM type, deep cycle, completely sealed, prismatic leadcalcium based, silver alloy, valve regulated lead acid (VRLA) requiring no maintenance. All batteries in a UPS installation shall be the same type; mixing of gel cell and AGM types within a UPS installation is not permitted.

Revise Article 1074.04(d)(4) of the Standard Specifications to read:

Batteries shall be certified by the manufacturer to operate over a temperature range of -13 to 160 °F (-25 to + 71 °C) for gel cell batteries and -40 to 140 °F (-40 to + 60 °C) for AGM type batteries.

Add the following to Article 1074.04(d) of the Standard Specifications:

(9) The UPS shall consist of an even number of batteries that are capable of maintaining normal operation of the signalized intersection for a minimum of six hours. Calculations shall be provided showing the number of batteries of the type supplied that are needed to satisfy this requirement. A minimum of four batteries shall be provided.

Add the following to the Article 1074.04 of the Standard Specifications:

(e) Warranty. The warranty for an uninterruptible power supply (UPS) shall cover a minimum of two years from date the equipment is placed in operation; however, the batteries of the UPS shall be warranted for full replacement for a minimum of five years from the date the traffic signal and UPS are placed into service.

ELECTRIC CABLE.

Delete "or stranded, and No. 12 or" from the last sentence of Article 1076.04 (a) of the Standard Specifications.

Add the following to the Article 1076.04(d) of the Standard Specifications:

Service cable may be single or multiple conductor cable.

TRAFFIC SIGNAL POST.

Add the following to Article 1077.01 (d) of the Standard Specifications:

All posts and bases shall be steel and hot dipped galvanized. If the Department approves painting, powder coating by the manufacturer will be required over the galvanization in accordance with TRAFFIC SIGNAL PAINTING in Division 800 of these specifications.

PEDESTRIAN PUSH-BUTTON POST.

Add the following to Article 1077.02(b) of the Standard Specifications:

All posts and bases shall be steel and hot-dipped galvanized. If the Department approves painting, powder coating by the manufacturer will be required over the galvanization in accordance with Traffic Signal Painting in Division 800 of these specifications.

MAST ARM ASSEMBLY AND POLE.

Add the following to Article 1077.03 (a) of the Standard Specifications:

Traffic signal mast arms shall be one piece construction, unless otherwise approved by the Engineer. All poles shall be galvanized. If the Department approves painting, powder coating by the manufacturer will be required over the galvanization in accordance with TRAFFIC SIGNAL PAINTING in Division 800 of these specifications.

The shroud shall be of sufficient strength to deter pedestrian and vehicular damage. The shroud shall be constructed and designed to allow air to circulate throughout the mast arm but not allow infestation of insects or other animals, and such that it is not hazardous to probing

fingers and feet. All mounting hardware shall be stainless steel.

LIGHT EMITTING DIODE (LED) TRAFFIC SIGNAL HEAD.

Add the following to Section 1078 of the Standard Specifications:

General.

All signal and pedestrian heads shall provide 12" (300 mm) displays with glossy yellow or black polycarbonate housings. All head housings shall be the same color (yellow or black) at the intersection. For new signalized intersections and existing signalized intersections where all signal and/or pedestrian heads are being replaced, the proposed head housings shall be black. Where only selected heads are being replaced, the proposed head housing color (yellow or black) shall match existing head housings. Connecting hardware and mounting brackets shall be polycarbonate (black). A corrosion resistant anti-seize lubricant shall be applied to all metallic mounting bracket joints, and shall be visible to the inspector at the signal turn-on. Post top mounting collars are required on all posts, and shall be constructed of the same material as the brackets.

Pedestrian signal heads shall be furnished with the international symbolic "Walking Person" and "Upraised Palm" displays. Egg crate sun shields are not permitted.

Signal heads shall be positioned according to the "District One Standard Traffic Signal Design Details."

LED signal heads (All Face and Section Quantities), (All Mounting Types) shall conform fully to the requirements of Articles 1078.01 and 1078.02 of the Standard Specifications amended herein.

1. The LED signal modules shall be replaced or repaired if an LED signal module fails to function as intended due to workmanship or material defects within the first 60 months from the date of delivery. LED signal modules which exhibit luminous intensities less than the minimum values specified in Table 1 of the ITE Vehicle Traffic Control Signal Heads: Light Emitting Diode (LED) Circular Signal Supplement (June 27, 2005) [VTSCH], or applicable successor ITE specifications, or show signs of entrance of moisture or contaminants within the first 60 months of the date of delivery shall be replaced or repaired. The manufacturer's written warranty for the LED signal modules shall be dated, signed by an Officer of the company and included in the product submittal to the State.

(a) Physical and Mechanical Requirements

1. Modules can be manufactured under this specification for the following faces:
 - a. 12 inch (300 mm) circular, multi-section
 - b. 12 inch (300 mm) arrow, multi-section
 - c. 12 inch (300 mm) pedestrian, 2 sections
2. The maximum weight of a module shall be 4 lbs. (1.8 kg).

3. Each module shall be a sealed unit to include all parts necessary for operation (a printed circuit board, power supply, a lens and gasket, etc.), and shall be weather proof after installation and connection.
4. Material used for the lens and signal module construction shall conform to ASTM specifications for the materials.
5. The lens of the module shall be tinted with a wavelength-matched color to reduce sun phantom effect and enhance on/off contrast. The tinting shall be uniform across the lens face. Polymeric lens shall provide a surface coating or chemical surface treatment applied to provide abrasion resistance. The lens of the module shall be integral to the unit, convex with a smooth outer surface and made of plastic. The lens shall have a textured surface to reduce glare.
6. The use of tinting or other materials to enhance ON/OFF contrasts shall not affect chromaticity and shall be uniform across the face of the lens.
7. Each module shall have a symbol of the type of module (i.e. circle, arrow, etc.) in the color of the module. The symbol shall be 1 inch (25.4 mm) in diameter. Additionally, the color shall be written out in 1/2 inch (12.7mm) letters next to the symbol.

(b) Photometric Requirements

1. The minimum initial luminous intensity values for the modules shall conform to the values in Table 1 of the VTCSH (2005) for circular signal indications, and as stated in Table 3 of these specifications for arrow and pedestrian indications at 25 °C.
2. The modules shall meet or exceed the illumination values stated in Articles 1078.01 and 1078.02 the Standard Specifications for circular signal indications, and Table 3 of these specifications for arrow and pedestrian indications, throughout the useful life based on normal use in a traffic signal operation over the operating temperature range.
3. The measured chromaticity coordinates of the modules shall conform to the chromaticity requirements of Section 4.2 of the VTCSH (2005) or applicable successor ITE specifications.
4. The LEDs utilized in the modules shall be AlInGaP technology for red, yellow, Portland orange (pedestrian) and white (pedestrian) indications, and GaN for green indications, and shall be the ultra bright type rated for 100,000 hours of continuous operation from -40 °C to +74 °C.

(c) Electrical

1. Maximum power consumption for LED modules is per Table 2.
2. Operating voltage of the modules shall be 120 VAC. All parameters shall be measured at this voltage.
3. The modules shall be operationally compatible with currently used controller assemblies (solid state load switches, flashers, and conflict monitors).

4. When a current of 20 mA AC (or less) is applied to the unit, the voltage read across the two leads shall be 15 VAC or less.
5. The LED modules shall provide constant light output under power. Modules with dimming capabilities shall have the option disabled or set on a non-dimming operation.
6. The individual LEDs shall be wired such that a catastrophic loss or the failure of one or more LED will not result in the loss of the entire module.

(d) Retrofit Traffic Signal Module

1. The following specification requirements apply to the Retrofit module only. All general specifications apply unless specifically superseded in this section.
2. Retrofit modules can be manufactured under this specification for the following faces:
 - a. 12 inch (300 mm) circular, multi-section
 - b. 12 inch (300 mm) arrow, multi-section
 - c. 12 inch (300 mm) pedestrian, 2 sections
3. Each Retrofit module shall be designed to be installed in the doorframe of a standard traffic signal housing. The Retrofit module shall be sealed in the doorframe with a one-piece EPDM (ethylene propylene rubber) gasket.
4. The maximum weight of a Retrofit module shall be 4 lbs. (1.8 kg).
5. Each Retrofit module shall be a sealed unit to include all parts necessary for operation (a printed circuit board, power supply, a lens and gasket, etc.), and shall be weather proof after installation and connection.
6. Electrical conductors for modules, including Retrofit modules, shall be 39.4 inches (1m) in length, with quick disconnect terminals attached.
7. The lens of the Retrofit module shall be integral to the unit, shall be convex with a smooth outer surface and made of plastic or of glass.

(e) The following specification requirements apply to the 12 inch (300 mm) arrow module only. All general specifications apply unless specifically superseded in this section.

1. The arrow module shall meet specifications stated in Section 9.01 of the Equipment and Material Standards of the Institute of Transportation Engineers (November 1998) [ITE Standards], Chapter 2 (Vehicle Traffic Control Signal Heads) or applicable successor ITE specifications for arrow indications.
2. The LEDs arrow indication shall be a solid display with a minimum of three (3) outlining rows of LEDs and at least one (1) fill row of LEDs.

(f) The following specification requirement applies to the 12 inch (300 mm) programmed

visibility (PV) module only. All general specifications apply unless specifically superseded in this section.

1. The LED module shall be a module designed and constructed to be installed in a programmed visibility (PV) signal housing without modification to the housing.

(g) The following specification requirements apply to the 12 inch (300 mm) Pedestrian module only. All general specifications apply unless specifically superseded in this section.

1. Each pedestrian signal LED module shall provide the ability to actuate the solid upraised hand and the solid walking person on one 12 inch (300mm) section.

2. Two (2) pedestrian sections shall be installed. The top section shall be wired to illuminate only the upraised hand and the bottom section shall be the walking man.

3. "Egg Crate" type sun shields are not permitted. All figures must be a minimum of 9 inches (225mm) in height and easily identified from a distance of 120-feet (36.6m).

LIGHT EMITTING DIODE (LED) PEDESTRIAN COUNTDOWN SIGNAL HEAD.

Add the following to Article 1078.02 of the Standard Specifications:

General.

1. The module shall operate in one mode: Clearance Cycle Countdown Mode Only. The countdown module shall display actual controller programmed clearance cycle and shall start counting when the flashing clearance signal turns on and shall countdown to "0" and turn off when the steady Upraised Hand (symbolizing Don't Walk) signal turns on. Module shall not have user accessible switches or controls for modification of cycle.

2. At power on, the module shall enter a single automatic learning cycle. During the automatic learning cycle, the countdown display shall remain dark.

3. The module shall re-program itself if it detects any increase or decrease of Pedestrian Timing. The counting unit will go blank once a change is detected and then take one complete pedestrian cycle (with no counter during this cycle) to adjust its buffer timer.

4. The module shall allow for consecutive cycles without displaying the steady Upraised Hand.

5. The module shall recognize preemption events and temporarily modify the crossing cycle accordingly.

6. If the controller preempts during the Walking Person (symbolizing Walk), the countdown will follow the controller's directions and will adjust from Walking Person to flashing Upraised Hand. It will start to count down during the flashing Upraised Hand.

7. If the controller preempts during the flashing Upraised Hand, the countdown will continue to count down without interruption.
8. The next cycle, following the preemption event, shall use the correct, initially programmed values.
9. If the controller output displays Upraised Hand steady condition and the unit has not arrived to zero or if both the Upraised Hand and Walking Person are dark for some reason, the unit suspends any timing and the digits will go dark.
10. The digits will go dark for one pedestrian cycle after loss of power of more than 1.5 seconds.
11. The countdown numerals shall be two (2) "7 segment" digits forming the time display utilizing two rows of LEDs.
12. The LED module shall meet the requirements of the Institute of Transportation Engineers (ITE) LED purchase specification, "Pedestrian Traffic Control Signal Indications - Part 2: LED Pedestrian Traffic Signal Modules," or applicable successor ITE specifications, except as modified herein.
13. The LED modules shall provide constant light output under power. Modules with dimming capabilities shall have the option disabled or set on a non-dimming operation.
14. In the event of a power outage, light output from the LED modules shall cease instantaneously.
15. The LEDs utilized in the modules shall be AlInGaP technology for Portland Orange (Countdown Numerals and Upraised Hand) and GaN technology for Lunar White (Walking Person) indications.
16. The individual LEDs shall be wired such that a catastrophic loss or the failure of one or more LED will not result in the loss of the entire module.

Electrical.

1. Maximum power consumption for LED modules is 29 watts.
2. The measured chromaticity shall remain unchanged over the input line voltage range listed of 80 VAC to 135 VAC.

TRAFFIC SIGNAL BACKPLATE.

Delete 1st sentence of Article 1078.03 of the Standard Specifications and add "All backplates shall be aluminum and louvered".

Add the following to the third paragraph of Article 1078.03 of the Standard Specifications. The

reflective backplate shall not contain louvers.

Delete second sentence of the fourth paragraph of Article 1078.03 of the Standard Specifications.

Add the following to the fourth paragraph of Article 1078.03 of the Standard Specifications:

When retro reflective sheeting is specified, it shall be Type ZZ sheeting according to Article 1091.03 and applied in preferred orientation for the maximum angularity according to the manufacturer's recommendations. The retro reflective sheeting shall be installed under a controlled environment at the manufacturer/supplier before shipment to the contractor. The aluminum backplate shall be prepared and cleaned, following recommendations of the retro reflective sheeting manufacturer.

INDUCTIVE LOOP DETECTOR.

Add the following to Article 1079.01 of the Standard Specifications:

Contracts requiring new cabinets shall provide for rack mounted detector amplifier cards. Detector amplifiers shall provide LCD displays with loop frequency, inductance, and change of inductance readings.

ILLUMINATED SIGN, LIGHT EMITTING DIODE.

Delete last sentence of Article 1084.01(a) and add "Mounting hardware shall be black polycarbonate or galvanized steel and similar to mounting Signal Head hardware and bracket specified herein and shall provide tool free access to the interior."

Revise the second paragraph of Article 1084.01(a) to read:

The exterior surface of the housing shall be acid-etched and shop painted with one coat of zinc-chromate primer and two coats of exterior enamel. The housing shall be the same color (yellow or black) to match the existing or proposed signal heads. The painting shall be according to Section 851.

Add the following to Article 1084.01 (b) of the Standard Specifications:

The message shall be formed by rows of LEDs. The sign face shall be 24 inches (600 mm) by 24 inches (600 mm).

Add the following to Article 1084.01 of the Standard Specifications:

(e) The light emitting diode (LED) blank out signs shall be manufactured by National Sign & Signal Company, or an approved equal and consist of a weatherproof housing and door, LEDs and transformers.

ILLUMINATED STREET NAME SIGN

The illuminate street name sign shall be as follows.

(a) Description.

The LEDs shall be white in color and utilize InGaN or UV thermally efficient technology. The LED Light Engines shall be designed to fit inside a standard fluorescent illuminated street sign housing in lieu of fluorescent lamps and ballasts or a slim line type housing. The LED internally-illuminated street name sign shall display the designated street name clearly and legibly in the daylight hours without being energized and at night when energized. The sign assembly shall consist of a four-, six-, or eight-foot aluminum housing. White translucent 3M DG³ reflective sheeting sign faces with the street name applied in 3M/Scotchlite Series 1177 or current 3M equivalent transparent green shall be installed in hinged doors on the side of the sign for easy access to perform general cleaning and maintenance operations. Illumination shall occur with LED Light Engine as specified.

(b) Environmental Requirements.

The LED lamp shall be rated for use in the ambient operating temperature range of -40 to +50°C (-40 to +122°F) for storage in the ambient temperature range of -40 to +75°C (-40 to +167°F).

(c) General Construction.

1. The LED Light Engine shall be a single, self-contained device, for installation in an existing street sign housing. The power supply must be designed to fit and mounted on the inside wall at one end of the street sign housing. The LED Light Engine shall be mounted within the inner top portion of the housing and no components of the light source shall sit between the sign faces.
2. The assembly and manufacturing processes of the LED Light Engine shall be designed to ensure that all LED and electronic components are adequately supported to withstand mechanical shocks and vibrations in compliance with the specifications of the ANSI, C136.31-2001 standards.

(d) Mechanical Construction.

1. The sign shall be constructed using a weatherproof, aluminum housing consisting of an extruded aluminum top with a minimum thickness of .140" x 10 3/4" deep (including the drip edge). The extruded aluminum bottom is .094" thick x 5 7/8" deep. The ends of the housing shall be cast aluminum with a minimum thickness of .250". A six-foot sign shall be 72 5/8" long and 22 5/16" tall and not weigh more than 77 pounds. An eight-foot sign shall be 96 5/8" long and 22 5/16" tall and not weigh more than 92 pounds. All corners are continuous TIG (Tungsten Inert Gas) welded to provide a weatherproof seal around the entire housing.
2. The door shall be constructed of extruded aluminum. Two corners are continuous TIG welded with the other two screwed together to make one side of the door removable for installation of the sign face. The door is fastened to the housing on the bottom by a full length, .040" x 1 1/8" open stainless steel hinge. The door shall be held secure onto a 1" wide by 5/32" thick neoprene gasket by three (six total for two-way sign) quarter-turn fasteners to form a watertight seal between the door and the housing.

3. The sign face shall be constructed of .125" white translucent polycarbonate. The letters shall be 8" upper case and 6" lower case. The sign face legend background shall consist of 3M/Scotchlite Series 4090T or current equivalent 3M translucent DG³ white VIP (Visual Impact Performance) diamond grade sheeting (ATSM Type 9) and 3M/Scotchlite Series 1177 or current 3M equivalent transparent green acrylic EC (electronic cut-able) film applied to the front of the sign face. The legend shall be framed by a white polycarbonate border. A logo symbol and/or name of the community may be included with approval of the Engineer.
4. All surfaces of the sign shall be etched and primed in accordance to industry standards before receiving appropriate color coats of industrial enamel.
5. All fasteners and hardware shall be corrosion resistant stainless steel. No tools are required for routine maintenance.
6. All wiring shall be secured by insulated wire compression nuts.
7. A wire entrance junction box shall be supplied with the sign assembly. The box may be supplied mounted to the exterior or interior of the sign and provide a weather tight seal.
8. A photoelectric switch shall be mounted in the control cabinet to control lighting functions for day and night display. Each sign shall be individually fused.
9. Brackets and Mounting: LED internally-illuminated street name signs will be factory drilled to accommodate mast arm two-point support assembly mounting brackets.

(e) Electrical.

1. Photocell shall be rated 105-305V, turn on at 1.5 fcs. with a 3-5 second delay. A manufacturer's warranty of six (6) years shall be provided. Power consumption shall be no greater than 1 watt at 120V.
2. The LED Light Engine shall operate from a 60 +/- 3 cycle AC line power over a voltage range of 80 to 135 Vac rms. Fluctuations in line voltage over the range of 80 to 135 Vac shall not affect luminous intensity by more than +/- 10%.
3. Total harmonic distortion induced into the AC power line by the LED Light Engine, operated at a nominal operating voltage, and at a temperature of +25°C (+77°F), shall not exceed 20%.
4. The LED Light Engine shall cycled ON and OFF with a photocell as shown on the detail sheet and shall not exceed the following maximum power values:

4-Foot Sign	60 W
6-Foot Sign	90 W
8-Foot Sign	120 W

The signs shall not be energized when traffic signals are powered by an alternate energy source such as a generator or uninterruptable power source (UPS). The signs shall be connected to

the generator or UPS bypass circuitry.

(f) Photometric Requirements.

1. The entire surface of the sign panel shall be evenly illuminated. The average maintained luminous intensity measured across the letters, operating under the conditions defined in Environmental Requirements and Wattage Sections shall be of a minimum value of 100 cd/m².
2. The manufacturer shall make available independent laboratory test results to verify compliance to Voltage Range and Luminous Intensity Distribution Sections.
3. Twelve (12) 1.25 watt LED units shall be mounted on 1-inch x 22-inch metal cone printed circuit boards (MCPCB). The viewing angle shall be 120 degrees. LED shall have a color temperature of 5200k nominal, CRI of 80 with a life expectancy of 75,000 hrs.

(g) Quality Assurance.

The LED Light Engine shall be manufactured in accordance with a vendor quality assurance (QA) program. The production QA shall include statistically controlled routine tests to ensure minimum performance levels of the LED Light Engine build to meet this specification. QA process and test result documentations shall be kept on file for a minimum period of seven (7) years. The LED Light Engine that does not satisfy the production QA testing performance requirements shall not be labeled, advertised, or sold as conforming to these specifications. Each LED Light Engine shall be identified by a manufacturer's serial number for warranty purposes. LED Light Engines shall be replaced or repaired if they fail to function as intended due to workmanship or material defects within the first sixty (60) months from the date of acceptance. LED Light Engines that exhibit luminous intensities less than the minimum value specified in Photometric Section within the first thirty-six (36) months from the date of acceptance shall be replaced or repaired.

UTILITY HANGER

Description: This item shall include the furnishing of all materials and the necessary labor to construct and erect the utility hangers as specified on the plans and as specified herein.

Materials for the items shall be in accordance with the table below.

Item	Description
Top Support Channel	Type 304 Stainless steel 1 5/8" x 1 3/8" channel, 4' long with closure strip, end caps, and back plates. Maximum allowable point load of 2,000 lbs and maximum allowable uniform load of 2,000 lbs/ft.
Spring Nuts	Type 304 Stainless steel 5/8" spring nut, threaded to match threaded rod, with spring.
Threaded Rod	Type 304 Stainless steel threaded rod, 5/8" diameter. Specified minimum yield stress, Fy=36,000 psi min. Nominal tensile strength, Ft=58,000 psi min.

4" Dia. Conduit Pipe Clamp	Type 304 Stainless steel pipe clamp for conduit size 4", outside diameter of 4.5". Thickness gauge of 11 mm. Design load of 1,000 lbs.
5" Dia. Conduit Pipe Clamp	Type 304 Stainless steel pipe clamp for conduit size 5", outside diameter of 5.563". Thickness gauge of 11 mm. Design load of 1,000 lbs.
Conduit Support Channel	Type 304 Stainless steel 1 5/8" x 1 5/8" channel, 12 gauge nominal thickness (.105"). Allowable moment 5,070 in-lbs. Wt/100 ft. = 189 lbs.

Method of Measurement: Utility hangers will not be measured for payment.

Basis of Payment:

This work will not be paid separately. The assemblies on the north side of the bridges for eight (8) – 5" diameter ComEd ducts (ducts furnished and installed by ComEd) shall be included in the unit price for CONCRETE SUPERSTRUCTURE, which price shall be full compensation for all labor, equipment and materials required for performing the work as herein specified and detailed on the plans.

The assemblies on the south side of the bridges for five (5) – 4" diameter galvanized steel ducts shall be included in the unit price for CONDUIT ATTACHED TO SUPERSTRUCTURE, which price shall be full compensation for all labor, equipment and materials required for performing the work as herein specified and detailed on the plans.

REMOVAL OF ASBESTOS CEMENT CONDUIT

Description

This work shall be in accordance with the Standard Specifications and consist of removing and disposal of offsite in an approved landfill or disposal site the existing asbestos cement conduits from the two existing Indian Trail bridges over the Fox River. The Contractor shall furnish all materials, equipment, labor, traffic control, permitting, traffic and pedestrian protections and other essentials necessary to accomplish this work and all other work described herein and as directed by the Engineer.

General

Asbestos cement conduit shall be properly masked, encapsulated or otherwise protected during removal such that dust and debris containing asbestos cement are not discharged into the air. Vehicles transporting the debris shall be licensed for asbestos cement hauling and shall be properly covered to prevent escape of debris during transit. Disposal sites shall be licensed for asbestos disposal. The removal, transportation and disposal of the asbestos cement conduit shall be in accordance with the rules and regulations of the Illinois Environmental Protection Agency (IEPA) and all local codes and ordinances. The Contractor shall notify the IEPA of all activities in relation to demolition and removal. The Contractor shall submit, at least 30 working days in advance of performing the work, form "Notification of Demolition and Renovation, Attachment 3, IL 532 1296, APC 430 Rev. 03/00" to IL Environmental Protection Agency, Attn:

Asbestos Unit, P.O. Box 19276 Springfield, IL 62764-9276. Guidance on the asbestos notification requirements is available under the Air/Asbestos topic on the web site for USEPA Region 5 (<http://www.epa.gov/region5/>).

Method of Measurement

Removal of Asbestos Cement Conduit will be measured for payment in units of FEET, at the locations specified on the plans and as directed by the Engineer for the full length of the bridges and approaches.

Basis of Payment

This work will be paid for at the contract unit price per FOOT for REMOVAL OF ASBESTOS CEMENT CONDUIT.

TEMPORARY PAVEMENT

Effective: March 1, 2003

Revised: April 10, 2008

Description. This work shall consist of constructing a temporary pavement at the locations shown on the plans or as directed by the engineer.

The contractor shall use either Portland cement concrete according to Sections 353 and 354 of the Standard Specifications or HMA according to Sections 355, 356, 406 of the Standard Specifications, and other applicable HMA special provisions as contained herein. The HMA mixtures to be used shall be specified in the plans. The thickness of the Temporary Pavement shall be as described in the plans. The contractor shall have the option of constructing either material type if both Portland cement concrete and HMA are shown in the plans.

Articles 355.08 and 406.11 of the Standard Specifications shall not apply.

The removal of the Temporary Pavement, if required, shall conform to Section 440 of the Standard Specification.

Method of Measurement. Temporary pavement will be measured in place and the area computed in square yards (square meters).

Basis of Payment. This work will be paid for at the contract unit price per square yard (square meter) for TEMPORARY PAVEMENT and TEMPORARY PAVEMENT (INTERSTATE).

Removal of temporary pavement will be paid for at the contract unit price per square yard (square meter) for PAVEMENT REMOVAL.

TEMPORARY SIDEWALK

Description: This work shall consist of constructing Temporary Sidewalk as detailed in the plans and as specified herein. This item shall conform to the details in the plans, the applicable

portions of Section 424 of the Standard Specifications and Highway Standard 424001.

The thickness for temporary sidewalk shall be 5”.

Method of Measurement: This work shall be measured for payment in place and the area computed in square feet. Curb ramps will be measured for payment as temporary sidewalk. No deduction will be made for detectable warnings located within the ramp.

Basis of Payment: This work will be a paid for at the contract unit price per square foot for TEMPORARY SIDEWALK which price shall include all materials, labor, and equipment necessary to perform the work as detailed in the plans.

HEAVY DUTY EROSION CONTROL BLANKET (SPECIAL)

This Special Provision revises Section 251 of the Standard Specifications for Road and Bridge Construction to eliminate the use of Excelsior Blanket for Erosion Control Blanket. This work shall consist of furnishing, transporting, and placing 100 % biodegradable erosion control blanket over seeded areas with biodegradable anchors as detailed on the plans, according to Section 251 except as modified herein.

Delete Article 1081.10(a) Excelsior Blanket.

Delete Article 1081.10(c) (1) Excelsior Blanket.

Delete the first paragraph of Article 1081.10 (c) (2) Knitted Straw Mat and substitute the following:

Knitted Straw Mat. The blanket shall be machine-produced 100% biodegradable blanket of 70% agricultural straw and 30% coconut fiber with a functional longevity of up to 18 months. The blanket shall be of consistent thickness with the straw and coconut evenly distributed over the entire area of the mat. The blanket shall be covered on the top and bottom sides with 100% biodegradable woven natural organic fiber netting such as North American Green SC150BN or equal. The top netting shall consist of machine directional strands formed from two intertwined yarns with cross directional strands interwoven through the twisted machine strands to form an approximate 0.50 x 1.0 (1.27 x 2.54 cm) mesh. The blanket shall be sewn together on 1.50 inch (3.81 cm) centers with degradable thread. The blanket shall be manufactured with a colored thread stitched along both outer edges (approximately 2-5 inches (5-12.5cm) from the edge) as an overlap guide for adjacent mats.

Delete Article 1081.10(d) Wire Staples.

Delete Article 1081.10 (e) Wood Stakes and substitute the following:

Biodegradable plastic stakes will be required. The biodegradable plastic anchor shall be 6 inches (15.24 cm) in length. No metal wire stakes or hardwood blanket anchors will be allowed.

Add the following to Article 251.05 Method of Measurement:

Heavy Duty Erosion Control Blanket, Special will be measured for payment in place in square yards (square meters) of actual surface areas covered.

Add the following to Article 251.06 Basis of Payment:

This work will be paid for at the contract unit price per square yard (square meter) for HEAVY DUTY EROSION CONTROL BLANKET, SPECIAL.

WEED CONTROL, PRE-EMERGENT GRANULAR HERBICIDE

Created: July 29, 2002

Modified: December 3, 2010

Description: This work shall consist of spreading a pre-emergent granular herbicide in place of weed barrier fabric in areas as shown on the plans or as directed by the Engineer. This item will be used in mulched plant beds and mulch rings.

Delete Article 253.11 and substitute the following:

Within 48 hours after planting, mulch shall be placed around all plants in the entire mulched bed or saucer area specified to a depth of 4 inches (100 mm). No weed barrier fabric will be required for tree and shrub planting. Pre-emergent Herbicide will be used instead of weed barrier fabric. The Pre-emergent Herbicide shall be applied prior to mulching. Mulch shall not be in contact with the base of woody stems or trunks.

Materials: The pre-emergent granular herbicide (Snapshot 2.5 TG or equivalent) shall contain the chemicals Trifluralin 2% active ingredient and Isoxaben with 0.5% active ingredient. The herbicide label shall be submitted to the Engineer for approval at least seventy-two (72) hours prior to application.

Method: The pre-emergent granular herbicide shall be used in accordance with the manufacturer's directions on the package. The granules are to be applied prior to mulching.

Apply the granular herbicide using a drop or rotary-type designed to apply granular herbicide or insecticides. Calibrate application equipment to use according to manufacturer's directions. Check frequently to be sure equipment is working properly and distributing granules uniformly. Do not use spreaders that apply material in narrow concentrated bands. Avoid skips or overlaps as poor weed control or crop injury may occur. More uniform application may be achieved by spreading half of the required amount of product over the area and then applying

the remaining half in swaths at right angles to the first. Apply the granular herbicide at the rate of 100 lbs/acre (112 kg/ha) or 2.3 lbs/1000 sq. ft. (11.2 kg/1000 sq. meters).

Method of Measurement: Pre-emergent granular herbicide will be measured in place in Pounds (Kilograms) of Pre-emergent Granular Herbicide applied. Areas treated after mulch placement shall not be measured for payment.

Basis of Payment: This work will be paid for at the contract unit price per pound (kilogram) of WEED CONTROL, PRE-EMERGENT GRANULAR HERBICIDE which price shall include all materials, equipment, and labor necessary to complete the work as specified.

PUBLIC CONVENIENCE AND SAFETY (DIST 1)

Effective: May 1, 2012

Revised: July 15, 2012

Add the following to the end of the fourth paragraph of Article 107.09:

“If the holiday is on a Saturday or Sunday, and is legally observed on a Friday or Monday, the length of Holiday Period for Monday or Friday shall apply.”

Add the following sentence after the Holiday Period table in the fourth paragraph of Article 107.09:

“The Length of Holiday Period for Thanksgiving shall be from 5:00 AM the Wednesday prior to 11:59 PM the Sunday After”

Delete the fifth paragraph of Article 107.09 of the Standard Specifications:

“On weekends, excluding holidays, roadways with Average Daily Traffic of 25,000 or greater, all lanes shall be open to traffic from 3:00 P.M. Friday to midnight Sunday except where structure construction or major rehabilitation makes it impractical.”

TRAFFIC SIGNAL SPECIFICATIONS FOR DETECTOR REPLACEMENT AND/OR INSTALLATION ON ROADWAY GRINDING, RESURFACING, & PATCHING OPERATIONS

Effective: October 1, 1999

Revised: January 1, 2007

The following Traffic Signal Special Provisions and the “District 1 Standard Traffic Signal Design Details” supplement the requirements of the State of Illinois “Standard Specifications for Road and Bridge Construction.”.

The intent of this Special Provision is to prescribe the materials and construction methods commonly used to replace traffic signal detector loops and replace magnetic signal detectors with detector loops during roadway resurfacing, grinding and patching operations. Loop detector replacement will not require the transfer of traffic signal maintenance from the District Electrical Maintenance Contractor to this contract’s electrical contractor. Replacement of magnetic detector will require wiring revisions inside the control cabinet and therefore the

transfer of maintenance will be required. All material furnished shall be new. The locations and the details of all installations shall be as indicated on the Plans or as directed by the Engineer.

The work to be provided under this contract consists of furnishing and installing all traffic signal work as specified on the Plans and as specified herein in a manner acceptable and approved by the Engineer.

NOTIFICATION OF INTENT TO WORK. Contracts such as pavement grinding or patching which result in the destruction of traffic signal detection require a notification of intent to work and an inspection. A minimum of seven (7) working days prior to the detection removal, the Contractor shall notify the:

- Traffic Signal Maintenance and Operations Engineer at (847)705-4424
- IDOT Electrical Maintenance Contractor at (773) 287-7600

at which time arrangements will be made to adjust the traffic controller timing to compensate for the absence of detection.

Failure to provide proper notification may require the District's Electrical Maintenance Contractor to be called to investigate complaints of inadequate traffic signal timing. All costs associated with these expenses will be paid for by the Contractor at no additional expense to the Department according to Section 109 of the "Standard Specifications."

ACCEPTANCE OF MATERIAL.

The Contractor shall provide:

1. All material approval requests shall be submitted a minimum of seven (7) days prior to the delivery of equipment to the job site, or within 30 consecutive calendar days after the contract is awarded, or within 15 consecutive calendar days after the preconstruction meeting, whichever is first.
2. Seven (7) copies of a letter listing the manufacturer's name and model numbers of the proposed equipment shall be supplied. The letter will be reviewed by the Traffic Design Engineer to determine whether the equipment to be used is approved. The letters will be stamped as approved or not approved accordingly and returned to the Contractor.
3. One (1) copy of material catalog cuts.
4. The contract number, permit number or intersection location must be on each sheet of the letter and material catalog cuts as required in items 2 and 3.

INSPECTION OF CONSTRUCTION.

When the road is open to traffic, except as otherwise provided in Section 801 and 850 of the Standard Specifications, the Contractor may request a turn-on and inspection of the completed traffic signal installation at each separate location. This request must be made to the Traffic Signal Maintenance and Operations Engineer at (847)705-4424 a minimum of seven (7) working days prior to the time of the requested inspection.

Acceptance of the traffic signal equipment by the Department shall be based upon inspection results at the traffic signal "turn on." If approved, traffic signal acceptance shall be verbal at the "turn on" inspection followed by written correspondence from the Engineer. If this work is not completed in time, the Department reserves the right to have the work completed by others at the Contractor's expense.

All cost of work and materials required to comply with the above requirements shall be included in the pay item bid prices, under which the subject materials and signal equipment are paid, and no additional compensation will be allowed. Materials and signal equipment not complying with the above requirements will be subject to removal and disposal at the Contractor's expense.

RESTORATION OF WORK AREA. Restoration of the traffic signal work area shall be incidental to the related pay item such as foundation, conduit, handhole, trench and backfill, etc., and no extra compensation shall be allowed. All roadway surfaces such as shoulders, medians, sidewalks, pavement, etc. shall be replaced as shown in the plans or in kind. All damage to mowed lawns shall be replaced with an approved sod, and all damage to unmowed fields shall be seeded.

REMOVAL, DISPOSAL AND SALVAGE OF EXISTING TRAFFIC SIGNAL EQUIPMENT. This item shall be incidental to this contract. All material and equipment removed shall become the property of the Contractor and disposed of by the Contractor outside the State's right-of-way. No additional compensation shall be provided to the Contractor for removal, disposal or salvage expense for the work in this contract.

DETECTOR LOOP REPLACEMENT. This work shall consist of replacing existing detector loops which are destroyed during grinding, resurfacing, or patching operations.

If damage to the detector loop is unavoidable, replacement of the existing detection system will be necessary. This work shall be completed by an approved Electrical Contractor as directed by the Engineer.

Replacement of the loops shall be accomplished in the following manner: The Engineer shall mark the location of the replacement loops. The Traffic Signal Maintenance and Operations Engineer shall be called to approve loop locations prior to the cutting of the pavement. The Contractor may reuse the existing conduit (duct) located between the existing handhole and the pavement if it hasn't been damaged. All burrs shall be removed from the edges of the existing conduit which may cause damage to the new detector loop during installation. If the existing conduit is damaged beyond repair, or if it cannot be located, or if additional conduits are required to provide one lead-in duct for each proposed loop; the Contractor shall be required to drill through the existing pavement into the appropriate handhole, and install 25 mm (1") unit duct conduit. This work and the required materials shall not be paid for separately but shall be included in the pay item Detector Loop Replacement. Upon establishment of the duct, the loop may be cut, installed, sealed and spliced to the twisted-shielded controller cable in the handhole.

Detector loop measurements shall include the saw-cut and the length of the loop lead-in leading to the edge of pavement. Unit duct, splicing, trench and backfill, and drilling of pavement or handholes shall be incidental to detector loop quantities.

All loops installed in new asphalt pavement shall be installed in the binder course and not in the surface course. The edge of pavement or the curb shall be cut with a 6.3 mm (1/4") deep x 100 mm (4") saw-cut to mark location of each loop lead-in.

A minimum of seven (7) working days prior to the Contractor cutting loops, the Contractor shall have the proposed loop locations marked and contact the Traffic Signal Maintenance and Operations Engineer (847)705-4424 to inspect and approve the layout.

Loop detectors shall be installed according to the requirements of the "District 1 Standard Traffic Signal Design Details." Saw-cuts from the loop to the edge of pavement shall be made perpendicular to the edge of pavement when possible in order to minimize the length of the saw-cut unless directed otherwise by the Engineer or as shown on the plan.

The detector loop cable insulation shall be labeled with the cable specifications.

Each loop detector lead-in wire shall be labeled in the handhole using a Panduit 250W175C water proof tag or approved equal secured to each wire with nylon ties. The lead-in wire, including all necessary connections for proper operation, from the edge of pavement to the handhole, shall be incidental to the price of the detector loop.

Loop sealant shall be a two-component thixotropic chemically cured polyurethane either Chemque Q-Seal 295, Percol Elastic Cement A/C Grade or an approved equal. The sealant shall be installed 3 mm (1/8") below the pavement surface, if installed above the surface the overlap shall be removed immediately.

Round loop(s) 1.8 m (six foot) diameter may be substituted for 1.8 m (six foot) by 1.8 m (six foot) square loop(s) and shall be paid for as 7.2 m (24 feet) of detector loop.

Resistance to ground shall be a minimum of 100 megohms under any conditions of weather or moisture.

Heat shrink splices shall be used according to the "District 1 Standard Traffic Signal Design Details."

Drilling handholes, sawing the pavement, furnishing and installing unit-duct to the appropriate handhole, cable splicing to provide a fully operable detector loop, testing and all trench and backfill shall be included in this item.

Detector loop replacement shall be measured along the sawed slot in the pavement containing the loop and lead-in, rather than the actual length of the wire in the slot.

Basis of Payment. Detector Loop Replacement shall be paid for at the contract unit price per foot (meter) of DETECTOR LOOP REPLACEMENT.

MAGNETIC DETECTOR REMOVAL AND DETECTOR LOOP INSTALLATION. This work shall consist of the removal of existing magnetic detectors, magnetic detector lead-in cable and magnetic detection amplifiers and related control equipment wiring, installation of detector lead-in cable, detector loops, detector amplifiers and related equipment wiring. The detector loop, cable, and amplifier shall be installed according to the applicable portions of the "Standard

Specifications” and the applicable portions of the Special Provision for “Detector Loop Replacement.” All drilling of handholes, furnishing and installing unit duct, cable splicing, trench and backfill, removal of equipment, and pulling cable from conduit shall be included in this item.

Basis of Payment. Magnetic Detector Removal and Detector Loop Installation shall be paid for at the contract unit price per foot (meter) for DETECTOR LOOP, TYPE I, per each for INDUCTIVE LOOP DETECTOR, and foot (meter) for ELECTRIC CABLE IN CONDUIT, LEAD-IN, NO. 14 1 PAIR.

IDOT TRAINING PROGRAM GRADUATE ON-THE-JOB TRAINING SPECIAL PROVISION (TPG)

Effective: August 1, 2012

In addition to the Contractor's equal employment opportunity affirmative action efforts undertaken as elsewhere required by this Contract, the Contractor is encouraged to participate in the incentive program to provide additional on-the-job training to certified graduates of IDOT's community college pre-apprenticeship programs outlined by this Special Provision.

It is the policy of IDOT to fund IDOT pre-apprenticeship training programs based at Illinois Community Colleges throughout Illinois, by Intergovernmental Agreement with the Illinois Community College Board, to provide training and skill-improvement opportunities to assure the increased participation of minority groups, disadvantaged persons and women in all phases of the highway construction industry. The intent of this IDOT Training Program Graduate (TPG) Special Provision is to place certified graduates of these IDOT funded pre-apprentice training programs on IDOT project sites when feasible, and provide the graduates with meaningful on-the-job training intended to lead to journey-level employment. IDOT and its sub-recipients, in carrying out the responsibilities of a state contract, shall determine which state funded construction contracts shall include "Training Program Graduate (TPG) Special Provisions." To benefit from the incentives to encourage the participation in the additional on-the-job training under this Training Program Graduate (TPG) Special Provision, the Contractor shall make every reasonable effort to employ certified graduates of the IDOT funded Pre-apprenticeship Training Program to the extent such persons are available within a reasonable recruitment area.

Participation pursuant to IDOT's requirements by the Contractor or subcontractor in this Training Program Graduate (TPG) Special Provision entitles the Contractor or subcontractor to be reimbursed at \$10.00 per hour for training given a certified graduate trainee on this contract. As approved by the Department, reimbursement will be made for training persons as specified herein. This reimbursement will be made even though the Contractor or subcontractor may receive additional training program funds from other sources for other trainees, provided such other source does not specifically prohibit the Contractor or subcontractor from receiving other reimbursement. For purposes of this Special Provision the Contractor is not relieved of requirements under the Illinois Prevailing Wage Act and is not eligible for other training fund reimbursements in addition to the Training Program Graduate (TPG) Special Provision reimbursement.

No payment shall be made to the Contractor if the Contractor or subcontractor fails to provide the required training. It is normally expected that a TPG will begin training on the project as soon as feasible after start of work utilizing the skill involved and remain on the project through completion of the contract, so long as training opportunities exist in his work classification or until he has completed his training program. Should the TPG's employment end in advance of the completion of the contract, the Contractor shall promptly notify the designated IDOT staff member under this Special Provision that the TPG's involvement in the contract has ended and supply a written report of the reason for the end of the involvement, the hours completed by the TPG under the Contract and the number of hours for which the incentive payment provided under this Special Provision will be or has been claimed for the TPG.

The Contractor will provide for the maintenance of records and furnish periodic reports documenting its performance under this Special Provision.

METHOD OF MEASUREMENT: The unit of measurement is in hours.

BASIS OF PAYMENT: This work will be paid for at the contract unit price of \$10.00 per hour for TRAINEES TRAINING PROGRAM GRADUATE. The estimated total number of hours, unit price and total price have been included in the schedule of prices.

The Contractor shall provide training opportunities aimed at developing full journeyworker in the type of trade or job classification involved. The initial number of TPGs for which the incentive is available under this contract is 3. During the course of performance of the Contract the Contractor may seek approval from the Department for additional incentive eligible TPGs. In the event the Contractor subcontracts a portion of the contract work, it shall determine how many, if any, of the TPGs are to be trained by the subcontractor, provided however, that the Contractor shall retain the primary responsibility for meeting the training requirements imposed by this Special Provision. The Contractor shall also insure that this Training Program Graduate Special Provision is made applicable to such subcontract if the TPGs are to be trained by a subcontractor and that the incentive payment is passed on to each subcontractor.

For the Contractor to meet the obligations for participation in this TPG incentive program under this Special Provision, the Department has contracted by Intergovernmental Agreement with the Illinois Community College Board to provide screening, tutoring and pre-training to individuals interested in working in the applicable construction classification and has certified those students who have successfully completed the program and are eligible to be TPGs. A designated IDOT staff member, the Director of the Office of Business and Workforce Diversity (OBWD), will be responsible for providing assistance and referrals to the Contractor for the applicable TPGs. For this contract, the Director of OBWD is designated as the responsible IDOT staff member to provide the assistance and referral services related to the placement for this Special Provision. For purposes of this Contract, contacting the Director of OBWD and interviewing each candidate he/she recommends constitutes reasonable recruitment.

Prior to commencing construction, the Contractor shall submit to the Department for approval the TPGs to be trained in each selected classification. Furthermore, the Contractor shall specify the starting time for training in each of the classifications. No employee shall be employed as a TPG in any classification in which he/she has successfully completed a training course leading to journeyman status or in which he/she has been employed as a journeyman. Notwithstanding the on-the-job training purpose of this TPG Special Provision, some offsite training is permissible as long as the offsite training is an integral part of the work of the contract and does not comprise a significant part of the overall training.

Training and upgrading of TPGs of IDOT pre-apprentice training programs is intended to move said TPGs toward journeyman status and is the primary objective of this Training Program Graduate Special Provision. Accordingly, the Contractor shall make every effort to enroll TPGs by recruitment through the IDOT Illinois Community College Program to the extent such persons are available within a reasonable area of recruitment. The Contractor will be responsible for demonstrating the steps that it has taken in pursuance thereof, prior to a determination as to whether the Contractor is in compliance and entitled to the Training Program Graduate TPG Special Provision \$10.00 an hour incentive.

The Contractor or subcontractor shall provide each TPG with a certification showing the type and length of training satisfactorily completed.



Route F.A.U. 1503
Section 09-00286-00-BR
County Kane

Marked Rte. Indian Trail
Project No. BRM-9003(509)
Contract No. 63863

This plan has been prepared to comply with the provisions of the National Pollutant Discharge Elimination System (NPDES) Permit No. ILR10 (Permit ILR10), issued by the Illinois Environmental Protection Agency (IEPA) for storm water discharges from construction site activities.

I certify, under penalty of law that this document and all attachments were prepared under my direction or supervision in accordance with a system designed to assure that qualified personnel properly gathered and evaluated the information submitted. Based on my inquiry of the person or persons who manage the system, or those persons directly responsible for gathering the information, the information submitted is, to the best of my knowledge and belief, true, accurate and complete. I am aware that there are significant penalties for submitting false information, including the possibility of fine and imprisonment for knowing violations.

Christopher E. Lirot, P.E.
Print Name
Road and Bridge Coordinator
Title
City of Aurora
Agency

Chris E. Lirot
Signature
Aug. 12, 2013
Date

Site Description:

A. Provide a description of the project location (include latitude and longitude):

Indian Trail over the west and east branches of the Fox River in the City of Aurora, Kane County, Illinois 41 deg 46' 55.59", 88 deg 18' 47.23" from approximately 100' east of IL Rte. 31 to approximately 150' west of IL Rte. 25.

B. Provide a description of the construction activity which is the subject of this plan:

Rehabilitation of the bridges carrying Indian Trail over the Fox River. Scope of work includes, but is not limited to bridge deck removal, concrete structures, concrete superstructure, pcc pavement, HMA surface course, cofferdams, seal coat, combination concrete curb and gutter, pavement removal, pcc sidewalk, storm sewer, lighting, temporary and permanent restoration and all incidental and collateral work necessary to complete the project as described herein.

C. Provide the estimated duration of this project:

12 to 14 months

D. The total area of the construction site is estimated to be 6.8 acres.

The total area of the site estimated to be disturbed by excavation, grading or other activities is 5.8 acres.

E. The following is a weighted average of the runoff coefficient for this project after construction activities are completed:

0.45

F. List all soils found within project boundaries. Include map unit name, slope information, and erosivity:

739 B/739D Milton silt loam (2 to 12 percent slopes), 8082A Millington silt loam (0 to 2 percent slopes) 323D2 Casco loam (6 to 12 percent slopes) and 325B/325C2 Dresden silt loam (2 to 6 percent slopes). Map IL089.

G. Provide an aerial extent of wetland acreage at the site:

3.92 acres of open water (WOTUS)

H. Provide a description of potentially erosive areas associated with this project:

Embankment slopes adjacent to the west abutment of the west bridge includes slopes up to 2H:1V. The majority for these slopes will be stabilized with stone riprap at the bridges, and seeding, Class 4 at roadway sections.

I. The following is a description of soil disturbing activities by stages, their locations, and their erosive factors (e.g. steepness of slopes, length of slopes, etc):

Clearing and tree removal of the embankments adjacent to both bridge abutments that includes slopes up to 2H:1V, 40 to 50 feet long. Clearing and tree removal of mainly flat areas under or adjacent to the west half of the west bridge. Placement of cofferdams around three piers at the west bridge and two piers at the east bridge. River bottom is mainly silty gravel over fractured rock. Pavement removal within the existing pavement/roadway section. Shaping/grading embankment slopes adjacent to the bridge approaches/abutments that includes slopes up to 2H:1V, 40 to 50 feet long.

J. See the erosion control plans and/or drainage plans for this contract for information regarding drainage patterns, approximate slopes anticipated before and after major grading activities, locations where vehicles enter or exit the site and controls to prevent offsite sediment tracking (to be added after contractor identifies locations), areas of soil disturbance, the location of major structural and non-structural controls identified in the plan, the location of areas where stabilization practices are expected to occur, surface waters (including wetlands) and locations where storm water is discharged to surface water including wetlands.

K. Identify who owns the drainage system (municipality or agency) this project will drain into:

City of Aurora for Storm Sewer, IDNR for Waters of the U.S. (Fox River).

L. The following is a list of receiving water(s) and the ultimate receiving water(s) for this site. The location of the receiving waters can be found on the erosion and sediment control plans:

Ultimate receiving water is the Fox River. The storm sewer and roadside ditches are not listed on the 2012 IEPA 303(d) list as impaired. The potential that construction activities performed onsite will impact the Fox River is reduced by the construction BMP's (temporary erosion control seeding, heavy duty erosion control blanket, temporary ditch checks, perimeter erosion barrier, inlet filters, stone rip rap, etc.) in the contract documents. It is unlikely that quantities of phosphorus (total), mercury or polychlorinated biphenyls will be discharged from the project. Portable toilets will be placed away from inlets and water courses.

M. Describe areas of the site that are to be protected or remain undisturbed. These areas may include steep slopes, highly erodible soils, streams, stream buffers, specimen trees, natural vegetation, nature preserves, etc.

Areas outside of the ROW or Temporary Construction Easements as indicated in the plans. Trees to removed are indicated. The remainder trees are to be preserved. Quantities of erosion control items (temporary seeding, heavy duty erosion control blanket, etc.) are provided in sufficient amount to cover the areas to be disturbed, but grading will not be required at all areas shown to be stabilized on the plans.

N. The following sensitive environmental resources are associated with this project, and may have the potential to be impacted by the proposed development:

- Floodplain
- Wetland Riparian
- Threatened and Endangered Species
- Historic Preservation
- 303(d) Listed receiving waters for suspended solids, turbidity, or siltation
- Receiving waters with Total Maximum Daily Load (TMDL) for sediment, total suspended solids, turbidity or siltation
- Applicable Federal, Tribal, State or Local Programs
- Other

1. 303(d) Listed receiving waters (fill out this section if checked above):

Fox River

a. The name(s) of the listed water body, and identification of all pollutants causing impairment:

Fox River

- b. Provide a description of how erosion and sediment control practices will prevent a discharge of sediment resulting from a storm event equal to or greater than a twenty-five (25) year, twenty-four (24) hour rainfall event:

The main storm sewer discharges will utilize a baffle in the manholes ahead of the discharge point, along with rip rap beds to reduce sediment from entering the Fox River.

- c. Provide a description of the location(s) of direct discharge from the project site to the 303(d) water body:

One (1) 42" diameter storm outlet (FES) at the southwest corner of the west bridge (proposed outlet replacing an existing outlet) and one new (1) 18" diameter storm outlet (FES) at the southwest corner of the east bridge.

- d. Provide a description of the location(s) of any dewatering discharges to the MS4 and/or water body:

Dewatering areas are included at the shorelines for dewatering as part of cofferdam construction at pier widening locations indicated in the plans.

2. TMDL (fill out this section if checked above)

- a. The name(s) of the listed water body:

- b. Provide a description of the erosion and sediment control strategy that will be incorporated into the site design that is consistent with the assumptions and requirements of the TMDL:

- c. If a specific numeric waste load allocation has been established that would apply to the project's discharges, provide a description of the necessary steps to meet that allocation:

O. The following pollutants of concern will be associated with this construction project:

- | | |
|---|--|
| <input checked="" type="checkbox"/> Soil Sediment | <input checked="" type="checkbox"/> Petroleum (gas, diesel, oil, kerosene, hydraulic oil / fluids) |
| <input checked="" type="checkbox"/> Concrete | <input checked="" type="checkbox"/> Antifreeze / Coolants |
| <input checked="" type="checkbox"/> Concrete Truck Waste | <input checked="" type="checkbox"/> Waste water from cleaning construction equipment |
| <input checked="" type="checkbox"/> Concrete Curing Compounds | <input type="checkbox"/> Other (specify) |
| <input type="checkbox"/> Solid Waste Debris | <input type="checkbox"/> Other (specify) |
| <input checked="" type="checkbox"/> Paints | <input type="checkbox"/> Other (specify) |
| <input checked="" type="checkbox"/> Solvents | <input type="checkbox"/> Other (specify) |
| <input checked="" type="checkbox"/> Fertilizers / Pesticides | <input type="checkbox"/> Other (specify) |

II. Controls:

This section of the plan addresses the controls that will be implemented for each of the major construction activities described in I.C. above and for all use areas, borrow sites, and waste sites. For each measure discussed, the Contractor will be responsible for its implementation as indicated. The Contractor shall provide to the Resident Engineer a plan for the implementation of the measures indicated. The Contractor, and subcontractors, will notify the Resident Engineer of any proposed changes, maintenance, or modifications to keep construction activities compliant with the Permit 1LR10. Each such Contractor has signed the required certification on forms which are attached to, and are a part of, this plan:

A. Erosion and Sediment Controls

1. **Stabilized Practices:** Provided below is a description of interim and permanent stabilization practices, including site specific scheduling of the implementation of the practices. Site plans will ensure that existing vegetation is preserved where attainable and disturbed portions of the site will be stabilized. Stabilization practices may include but are not limited to: temporary seeding, permanent seeding, mulching, geotextiles, sodding, vegetative buffer strips, protection of trees, preservation of mature vegetation, and other appropriate measures. Except as provided below in II(A)(1)(a) and II(A)(3), stabilization measures shall be initiated as soon as practicable in portions of the site where construction activities have temporarily or permanently ceased, but in no case more than seven (7) days after the construction activity in that portion of the site has temporarily or permanently ceases on all disturbed portions of the site where construction will not occur for a period of fourteen (14) or more calendar days.

Where the initiation of stabilization measures by the seventh day after construction activity temporarily or

permanently ceases is precluded by snow cover, stabilization measures shall be initiated as soon as practicable thereafter.

The following stabilization practices will be used for this project:

- | | |
|---|--|
| <input checked="" type="checkbox"/> Preservation of Mature Vegetation | <input checked="" type="checkbox"/> Erosion Control Blanket / Mulching |
| <input type="checkbox"/> Vegetated Buffer Strips | <input type="checkbox"/> Sodding |
| <input checked="" type="checkbox"/> Protection of Trees | <input checked="" type="checkbox"/> Geotextiles |
| <input checked="" type="checkbox"/> Temporary Erosion Control Seeding | <input type="checkbox"/> Other (specify) |
| <input type="checkbox"/> Temporary Turf (Seeding, Class 7) | <input type="checkbox"/> Other (specify) |
| <input type="checkbox"/> Temporary Mulching | <input type="checkbox"/> Other (specify) |
| <input checked="" type="checkbox"/> Permanent Seeding | <input type="checkbox"/> Other (specify) |

Describe how the stabilization practices listed above will be utilized during construction:

Temporary erosion control seeding will be installed with clearing/grading activities, and as shown in the plans and described in the standard specifications to establish plant material to stabilize disturbed areas and prevent soil from being carried off-site by storm water runoff or wind. Permanent seeding will be installed at all disturbed areas prior to project completion. Erosion control blanket will be installed on finished grade surfaces with temporary seeding. Tree trunk protection will be utilized where construction activities are adjacent to landscaping/specimen trees. Geotextiles will be utilized under stone rip rap.

Describe how the stabilization practices listed above will be utilized after construction activities have been completed:

Permanent seeding will be installed after grading, roadway and bridge items are completed.

2. **Structural Practices:** Provided below is a description of structural practices that will be implemented, to the degree attainable, to divert flows from exposed soils, store flows or otherwise limit runoff and the discharge of pollutants from exposed areas of the site. Such practices may include but are not limited to: perimeter erosion barrier, earth dikes, drainage swales, sediment traps, ditch checks, subsurface drains, pipe slope drains, level spreaders, storm drain inlet protection, rock outlet protection, reinforced soil retaining systems, gabions, and temporary or permanent sediment basins. The installation of these devices may be subject to Section 404 of the Clean Water Act.

The following structural practices will be used for this project:

- | | |
|--|--|
| <input checked="" type="checkbox"/> Perimeter Erosion Barrier | <input type="checkbox"/> Rock Outlet Protection |
| <input checked="" type="checkbox"/> Temporary Ditch Check | <input checked="" type="checkbox"/> Riprap |
| <input checked="" type="checkbox"/> Storm Drain Inlet Protection | <input type="checkbox"/> Gabions |
| <input checked="" type="checkbox"/> Sediment Trap | <input type="checkbox"/> Slope Mattress |
| <input type="checkbox"/> Temporary Pipe Slope Drain | <input type="checkbox"/> Retaining Walls |
| <input type="checkbox"/> Temporary Sediment Basin | <input type="checkbox"/> Slope Walls |
| <input type="checkbox"/> Temporary Stream Crossing | <input type="checkbox"/> Concrete Revetment Mats |
| <input type="checkbox"/> Stabilized Construction Exits | <input type="checkbox"/> Level Spreaders |
| <input type="checkbox"/> Turf Reinforcement Mats | <input checked="" type="checkbox"/> Other (specify) Baffle in Storm Manholes |
| <input type="checkbox"/> Permanent Check Dams | <input type="checkbox"/> Other (specify) |
| <input type="checkbox"/> Permanent Sediment Basin | <input type="checkbox"/> Other (specify) |
| <input type="checkbox"/> Aggregate Ditch | <input type="checkbox"/> Other (specify) |
| <input type="checkbox"/> Paved Ditch | <input type="checkbox"/> Other (specify) |

Describe how the structural practices listed above will be utilized during construction:

Perimeter erosion barrier will be installed to keep sediment from leaving the site. Temporary ditch checks will be installed after rough ditch grading to prevent sediment from entering the storm sewer system and river. Storm drain inlets will be installed in existing inlets to remain, and the new storm structures with open lids to prevent sediment from entering the storm sewer system. Sediment traps/sump pits will be used as part of cofferdam dewatering activities to remove sediment from water removed from the cofferdam areas. Rip rap is being used at abutment slopes for slope protection and at the storm sewer outlets to capture sediment of the storm water prior to discharge into the Fox River. The new storm outlets have baffles in the manholes prior to discharge.

Describe how the structural practices listed above will be utilized after construction activities have been completed:

After the new storm sewer is installed, storm drain inlet protection will keep sediment from entering the new storm sewer. The rip rap is permanent, and will act as slope protection, and will help filter the storm water at the storm outlets.

3. **Storm Water Management:** Provided below is a description of measures that will be installed during the construction process to control pollutants in storm water discharges that will occur after construction operations have been completed. The installation of these devices may be subject to Section 404 of the Clean Water Act.

- a. Such practices may include but are not limited to: storm water detention structures (including wet ponds), storm water retention structures, flow attenuation by use of open vegetated swales and natural depressions, infiltration of runoff on site, and sequential systems (which combine several practices).

The practices selected for implementation were determined on the basis of the technical guidance in Chapter 41 (Construction Site Storm Water Pollution Control) of the IDOT Bureau of Design and Environment Manual. If practices other than those discussed in Chapter 41 are selected for implementation or if practices are applied to situations different from those covered in Chapter 41, the technical basis for such decisions will be explained below.

- b. Velocity dissipation devices will be placed at discharge locations and along the length of any outfall channel as necessary to provide a non-erosive velocity flow from the structure to a water course so that the natural physical and biological characteristics and functions are maintained and protected (e.g. maintenance of hydrologic conditions such as the hydroperiod and hydrodynamics present prior to the initiation of construction activities).

Description of storm water management controls:

The two storm sewer outlets include manholes with baffles to help trap and prevent sediment/solids from entering the Fox River from the roadway run-off. Permanent rip rap is also included at the storm sewer outlet locations to help filter storm water prior to entering the Fox River. Permanent seed, Class 4 is included to help filter storm runoff and reduce the potential for sediment and other contaminants to discharge into the Fox River.

4. **Approved State or Local Laws:** The management practices, controls and provisions contained in this plan will be in accordance with IDOT specifications, which are at least as protective as the requirements contained in the Illinois Environmental Protection Agency's Illinois Urban Manual. Procedures and requirements specified in applicable sediment and erosion site plans or storm water management plans approved by local officials shall be described or incorporated by reference in the space provided below. Requirements specified in sediment and erosion site plans, site permits, storm water management site plans or site permits approved by local officials that are applicable to protecting surface water resources are, upon submittal of an NOI, to be authorized to discharge under the Permit ILR10 incorporated by reference and are enforceable under this permit even if they are not specifically included in the plan.

Description of procedures and requirements specified in applicable sediment and erosion site plans or storm water management plans approved by local officials:

All management practices, control and other provisions provided in the bid documents are in accordance with IDOT Standard Specifications for Road and Bridge construction and the most recent version of the Illinois Urban Manual.

5. **Contractor Required Submittals:** Prior to conducting any professional services at the site covered by this plan, the Contractor and each subcontractor responsible for compliance with the permit shall submit to the Resident Engineer a Contractor Certification Statement, BDE 2342a.

- a. The Contractor shall provide a construction schedule containing an adequate level of detail to show major activities with implementation of pollution prevention BMPs, including the following items:

- Approximate duration of the project, including each stage of the project
- Rainy season, dry season, and winter shutdown dates
- Temporary stabilization measures to be employed by contract phases
- Mobilization timeframe
- Mass clearing and grubbing/roadside clearing dates
- Deployment of Erosion Control Practices
- Deployment of Sediment Control Practices (including stabilized construction entrances/exits)
- Deployment of Construction Site Management Practices (including concrete washout facilities, chemical storage, refueling locations, etc.)
- Paving, saw-cutting, and any other pavement related operations
- Major planned stockpiling operations

- Timeframe for other significant long-term operations or activities that may plan non-storm water discharges such as dewatering, grinding, etc.
 - Permanent stabilization activities for each area of the project
- b. The Contractor and each subcontractor shall provide, as an attachment to their signed Contractor Certification Statement, a discussion of how they will comply with the requirements of the permit in regard to the following items and provide a graphical representation showing location and type of BMPs to be used when applicable:
- Vehicle Entrances and Exits – Identify type and location of stabilized construction entrances and exits to be used and how they will be maintained.
 - Material Delivery, Storage and Use – Discuss where and how materials including chemicals, concrete curing compounds, petroleum products, etc. will be stored for this project.
 - Stockpile Management – Discuss what BMPs will be used to prevent pollution of storm water from stockpiles.
 - Waste Disposal – Discuss methods of waste disposal that will be used for this project.
 - Spill Prevention and Control – Discuss steps that will be taken in the event of a material spill (chemicals, concrete curing compounds, petroleum, etc.)
 - Concrete Residuals and Washout Wastes – Discuss the location and type of concrete washout facilities to be used on this project and how they will be signed and maintained.
 - Litter Management – Discuss how litter will be maintained for this project (education of employees, number of dumpsters, frequency of dumpster pick-up, etc.).
 - Vehicle and Equipment Fueling – Identify equipment fueling locations for this project and what BMPs will be used to ensure containment and spill prevention.
 - Vehicle and Equipment Cleaning and Maintenance – Identify where equipment cleaning and maintenance locations for this project and what BMPs will be used to ensure containment and spill prevention.
 - Additional measures indicated in the plan.

III. Maintenance:

When requested by the Contractor, the Resident Engineer will provide general maintenance guides to the Contractor for the practices associated with this project. The following additional procedures will be used to maintain, in good and effective operating conditions, the vegetation, erosion and sediment control measures and other protective measures identified in this plan. It will be the Contractor's responsibility to attain maintenance guidelines for any manufactured BMPs which are to be installed and maintained per manufacture's specifications.

N/A

IV Inspections:

Qualified personnel shall inspect disturbed areas of the construction site which have not yet been finally stabilized, structural control measures, and locations where vehicles and equipment enter and exit the site using IDOT Storm Water Pollution Prevention Plan Erosion Control Inspection Report (BC 2259). Such inspections shall be conducted at least once every seven (7) calendar days and within twenty-four (24) hours of the end of a storm that is 0.5 inch or greater or equivalent snowfall.

If any violation of the provisions of this plan is identified during the conduct of the construction work covered by this plan, the Resident Engineer shall notify the appropriate IEPA Field Operations Section office by email at: epa.swnoncomp@illinois.gov, telephone or fax within twenty-four (24) hours of the incident. The Resident Engineer shall then complete and submit an "Incidence of Non-Compliance" (ION) report for the identified violation within five (5) days of the incident. The Resident Engineer shall use forms provided by IEPA and shall include specific information on the cause of noncompliance, actions which were taken to prevent any further causes of noncompliance, and a statement detailing any environmental impact which may have resulted from the noncompliance. All reports of non-compliance shall be signed by a responsible authority in accordance with Part VI. G of the Permit ILR10.

The Incidence of Non-Compliance shall be mailed to the following address:

Illinois Environmental Protection Agency
 Division of Water Pollution Control
 Attn: Compliance Assurance Section
 1021 North Grand East
 Post Office Box 19276
 Springfield, Illinois 62794-9276

V. Failure to Comply:

Failure to comply with any provisions of this Storm Water Pollution Prevention Plan will result in the implementation of a

National Pollutant Discharge Elimination System/Erosion and Sediment Control Deficiency Deduction against the Contractor and/or penalties under the Permit ILR10 which could be passed on to the Contractor.



Prior to conducting any professional services at the site covered by this contract, the Contractor and every subcontractor must complete and return to the Resident Engineer the following certification. A separate certification must be submitted by each firm. Attach to this certification all items required by Section II.5 of the Storm Water Pollution Prevention Plan (SWPPP) which will be handled by the Contractor/subcontractor completing this form.

Route	<u>F.A.U. 1503</u>	Marked Rte.	<u>Indian Trail</u>
Section	<u>09-00286-00-BR</u>	Project No.	<u>BRM-9003(509)</u>
County	<u>Kane</u>	Contract No.	<u>63863</u>

This certification statement is a part of the SWPPP for the project described above, in accordance with the General NPDES Permit No. ILR10 issued by the Illinois Environmental Protection Agency.

I certify under penalty of law that I understand the terms of the Permit No. ILR 10 that authorizes the storm water discharges associated with industrial activity from the construction site identified as part of this certification.

In addition, I have read and understand all of the information and requirements stated in the SWPPP for the above mentioned project; I have received copies of all appropriate maintenance procedures; and, I have provided all documentation required to be in compliance with the Permit ILR10 and SWPPP and will provide timely updates to these documents as necessary.

Contractor

Sub-Contractor

Print Name

Signature

Title

Date

Name of Firm

Telephone

Street Address

City/State/ZIP

Items which this Contractor/subcontractor will be responsible for as required in Section II.5. of the SWPPP:



PERMIT NO. NE2012009
DATE: February 27, 2012

State of Illinois
Department of Natural Resources, Office of Water Resources

Permission is hereby granted to:

City of Aurora
44 East Downer Place
Aurora, Illinois 60507-2067

to modify the East and West Indian Trail Road Bridges and to construct cofferdams at the bridge piers on the East and West Channels of the Fox River in the Southwest Quarter of Section 10, Township 38 North, Range 8 East of the Third Principal Meridian in Kane County,

in accordance with an application dated December 17, 2010, and the plans and specifications entitled:

LOCATION MAP, ONE SHEET, UNDATED, RECEIVED DECEMBER 23, 2010,
INDIAN TRAIL ROAD OVER THE FOX RIVER, CITY OF AURORA, ILLINOIS,
BRIDGE PLAN AND ELEVATION, SHEETS 1 AND 2 OF 2,
DATED JANUARY 18, 2012, RECEIVED JANUARY 19, 2012.

Examined and Recommended:

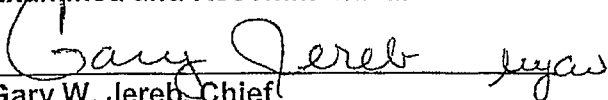
Gary W. Jereb, Chief
Northeastern IL Regulatory
Programs Section

Approval Recommended:

Arlan R. Juhl, Director
Office of Water Resources

Approved:

Marc Miller, Director
Department of Natural Resources

This PERMIT is subject to the terms and special conditions contained herein.

THIS PERMIT IS SUBJECT TO THE FOLLOWING CONDITIONS:

- 1) This permit is granted in accordance with the Rivers, Lakes and Streams Act "615 ILCS 5."
- 2) This permit does not convey title to the permittee or recognize title of the permittee to any submerged or other lands, and furthermore, does not convey, lease or provide any right or rights of occupancy or use of the public or private property on which the activity or any part thereof will be located, or otherwise grant to the permittee any right or interest in or to the property, whether the property is owned or possessed by the State of Illinois or by any private or public party or parties.
- 3) This permit does not release the permittee from liability for damage to persons or property resulting from the work covered by this permit, and does not authorize any injury to private property or invasion of private rights.
- 4) This permit does not relieve the permittee of the responsibility to obtain other federal, state or local authorizations required for the construction of the permitted activity; and if the permittee is required by law to obtain approvals from any federal or state agency to do the work, this permit is not effective until the federal and state approvals are obtained.
- 5) The permittee shall, at the permittee's own expense, remove all temporary piling, cofferdams, false work, and material incidental to the construction of the project. If the permittee fails to remove such structures or materials, the Department may have removal made at the expense of the permittee.
- 6) In public waters, if future need for public navigation or other public interest by the state or federal government necessitates changes in any part of the structure or structures, such changes shall be made by and at the expense of the permittee or the permittee's successors as required by the Department or other properly constituted agency, within sixty (60) days from receipt of written notice of the necessity from the Department or other agency, unless a longer period of time is specifically authorized.
- 7) The execution and details of the work authorized shall be subject to the review and approval of the Department. Department personnel shall have the right of access to accomplish this purpose.
- 8) Starting work on the activity authorized will be considered full acceptance by the permittee of the terms and conditions of the permit.
- 9) The Department in issuing this permit has relied upon the statements and representations made by the permittee; if any substantive statement or representation made by the permittee is found to be false, this permit will be revoked; and when revoked, all rights of the permittee under the permit are voided.
- 10) In public waters, the permittee and the permittee's successors shall make no claim whatsoever to any interest in any accretions caused by the activity.
- 11) In issuing this permit, the Department does not ensure the adequacy of the design or structural strength of the structure or improvement.
- 12) Noncompliance with the conditions of this permit will be considered grounds for revocation.
- 13) If the construction activity permitted is not completed on or before December 31, 2015 this permit shall cease and be null and void.

THIS PERMIT IS SUBJECT TO THE FOLLOWING SPECIAL CONDITIONS:

- a) The Permittee shall not engage in any in-stream construction activities in the East and West Channels of the Fox River between April 1 and June 15 of any year. This condition does not apply to work on the superstructure or work isolated from the wetted portion of the river channels by the cofferdams at the bridge piers if they are placed prior to the exclusionary period.
- b) This permit does not authorize any temporary in-stream work other than the placement of cofferdams at the bridge piers; however, this permit may be revised in the future to include additional temporary work.
- c) The Permittee shall remove all temporary work and all associated materials as soon as possible upon completion of the bridge modification work and stabilize the site from erosion.



DEPARTMENT OF THE ARMY
CHICAGO DISTRICT, CORPS OF ENGINEERS
231 SOUTH LA SALLE STREET
CHICAGO, ILLINOIS 60604-1437

REPLY TO
ATTENTION OF:

July 31, 2013

Technical Services Division
Regulatory Branch
LRC-2010-827

SUBJECT: Permit Authorization for Proposed Work at Indian Trail Road Bridge over the Fox River, Aurora and Aurora Township, Kane County, Illinois (SW ¼ of Section 10, T38N R8E)

Mr. Chris Lirot
City of Aurora
44 E. Downer Place
Aurora, IL 60507-2067

Dear Mr. Lirot:

This office has verified that your proposed activity complies with the terms and conditions of Regional Permit 3 (Transportation Projects) 7 (Temporary Construction Activities) and the overall RPP under Category II of the Regional Permit Program dated April 1, 2012.

This verification expires three (3) years from the date of this letter and covers only your activity as described in your notification and as shown on the plans titled, "State of Illinois, Department of Transportation, Division of Highways, Plans for Proposed Federal Aid Highway (F.A.U. 1503) Indian Trail over the Fox River, Bridge Widening & Deck Replacement, SN: 045-3088, 045-3089, Section: 09-00286-00-BR, Project: BRM-9003(509), City of Aurora, Kane County, C-91-130-10" dated March 4, 2013, prepared by HRGreen. Caution must be taken to prevent construction materials and activities from impacting waters of the United States beyond the scope of this authorization. If you anticipate changing the design or location of the activity, you should contact this office to determine the need for further authorization.

The activity may be completed without further authorization from this office provided the activity is conducted in compliance with the terms and conditions of the RPP, including conditions of water quality certification issued under Section 401 of the Clean Water Act by the Illinois Environmental Protection Agency (IEPA). If the design, location, or purpose of the project is changed, you should contact this office to determine the need for further authorization.

The following special conditions are a requirement of your authorization:

1. You shall undertake and complete the project as described in the plans titled, "State of Illinois, Department of Transportation, Division of Highways, Plans for Proposed Federal Aid Highway (F.A.U. 1503) Indian Trail over the Fox River, Bridge Widening & Deck

Replacement, SN: 045-3088, 045-3089, Section: 09-00286-00-BR, Project: BRM-9003(509), City of Aurora, Kane County, C-91-130-10" dated March 4, 2013, prepared by HRGreen, including all relevant documentation to the project plans as proposed.

2. This authorization is contingent upon implementing and maintaining soil erosion and sediment controls in a serviceable condition throughout the duration of the project. You shall comply with the Kane/DuPage Soil and Water Conservation District's (SWCD) written and verbal recommendations regarding the soil erosion and sediment control (SESC) plan and the installation and maintenance requirements of the SESC practices on-site.
 - a. You shall schedule a preconstruction meeting with the SWCD to discuss the SESC plan and the installation and maintenance requirements of the SESC practices on the site.
 - b. You shall notify the SWCD of any changes or modifications to the approved plan set. Field conditions during project construction may require the implementation of additional SESC measures. If you fail to implement corrective measures, this office may require more frequent site inspections to ensure the installed SESC measures are acceptable.
 - c. Prior to commencement of any in-stream work, you shall submit construction plans and a detailed narrative to the SWCD that disclose the contractor's preferred method of cofferdam and dewatering method. Work in the waterway shall NOT commence until the SWCD notifies you, in writing, that the plans have been approved.
3. From March 15 to June 1, all machinery shall be excluded from working within the river to protect spawning of adult fish. Working in the dry behind cofferdams or on dry work pads is acceptable, given that they are installed prior to this timeframe.
4. A mussel relocation effort must be conducted prior to initiation of in-stream work activities. You shall coordinate with the Illinois Department of Natural Resources for this effort, and notify this office of when the relocation is to occur.
5. You shall provide written notification to this office at least ten (10) days prior to the commencement of work indicating the start date and estimated end date of construction.
6. You are responsible for all work authorized herein and for ensuring that all contractors are aware of the terms and conditions of this authorization.
7. A copy of this authorization must be present at the project site during all phases of construction.
8. You shall notify this office of any proposed modifications to the project, including revisions to any of the plans or documents cited in this authorization. You must receive approval from this office before work affected by the proposed modification is performed.

9. You shall notify this office prior to the transfer of this authorization and liabilities associated with compliance with its terms and conditions. The transferee must sign the authorization in the space provided and forward a copy of the authorization to this office.
10. The permittee understands and agrees that, if future operations by the United States require removal, relocation, or other alteration of the structure or work authorized herein, or if, in the opinion of the Secretary of the Army or his authorized representative said structure or work shall cause unreasonable obstruction to the free navigation of the navigable water, the permittee will be required, upon due notice from the Corps of Engineers, to remove, relocate, or alter the structural work or obstructions caused thereby, without expense to the United States. No claim shall be made against the United States on account of any such removal or alteration.
11. Water shall be isolated from the in-stream work area using a cofferdam constructed of non-erodible materials (steel sheets, aqua barriers, rip rap and geotextile liner, etc.). Earthen cofferdams are not permissible.
12. The cofferdam must be constructed from the upland area and no equipment may enter flowing water at any time. If the installation of the cofferdam cannot be completed from shore and access is needed to reach the area to be coffered, other measures, such as the construction of a causeway, will be necessary to ensure that equipment does not enter the water. Once the cofferdam is in place and the isolated area is dewatered, equipment may enter the coffered area to perform the required work.
13. During dewatering of the coffered work area, all sediment-laden water must be filtered to remove sediment. Possible options for sediment removal include baffle systems, anionic polymers systems, dewatering bags, or other appropriate methods. Water shall have sediment removed prior to being re-introduced to the downstream waterway. A stabilized conveyance from the dewatering device to the waterway must be identified in the plan. Discharge water is considered clean if it does not result in a visually identifiable degradation of water clarity.
14. The portion of the side slope that is above the observed water elevation shall be stabilized as specified in the plans prior to accepting flows. The substrate and toe of slope that has been disturbed due to construction activities shall be restored to proposed or pre-construction conditions and fully stabilized prior to accepting flows.

The authorization is without force and effect until all other permits or authorizations from local, state, or other Federal agencies are secured. Please note that IEPA has issued Section 401 Water Quality Certification for this RP. These conditions are included in the enclosed fact sheet. If you have any questions regarding Section 401 certification, please contact Mr. Dan Heacock at IEPA's Division of Water Pollution Control, Permit Section #15, by telephone at (217) 782-3362.

Once you have completed the authorized activity, please sign and return the enclosed compliance certification. If you have any questions, please contact Ms. Kimberly Kubiak of my

staff by telephone at 312-846-5541, or email at kimberly.j.kubiak@usace.army.mil.

Sincerely,

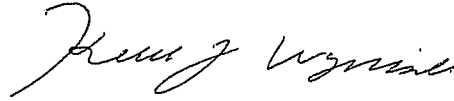

Keith L. Wozniak
Chief, West Section
Regulatory Branch

Enclosure

Copy Furnished:

Illinois Department of Natural Resources/OWR (Gary Jereb)
Illinois Department of Natural Resources (Bob Rung)
Kane/DuPage SWCD (Candice Jacobs)
Kane County Division of Environmental Management (Ken Anderson)
Kane County Development and Resource Management Department (Paul Schuch)
City of Aurora (Kenneth Schroth)
Kane/DuPage SWCD (Candice Jacobs)
HR Green (Steve Chu, Kevin Arft)

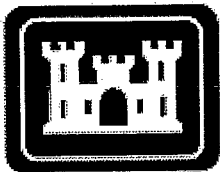

PERMIT COMPLIANCE

CERTIFICATION

Permit Number: LRC-2010-827
Permittee: Chris Lirot, City of Aurora
Date: July 31, 2013

I hereby certify that the work authorized by the above-referenced permit has been completed in accordance with the terms and conditions of said permit and if applicable, compensatory wetland mitigation was completed in accordance with the approved mitigation plan.¹

PERMITTEE

DATE

Upon completion of the activity authorized by this permit and any mitigation required by the permit, this certification must be signed and returned to the following address:

U.S. Army Corps of Engineers
Chicago District, Regulatory Branch
231 South LaSalle Street, Suite 1500
Chicago, Illinois 60604-1437

Please note that your permitted activity is subject to compliance inspections by Corps of Engineers representatives. If you fail to comply with this permit, you may be subject to permit suspension, modification, or revocation.

¹ If compensatory mitigation was required as part of your authorization, you are certifying that the mitigation area has been graded and planted in accordance with the approved plan. You are acknowledging that the maintenance and monitoring period will begin after a site inspection by a Corps of Engineers representative or after thirty days of the Corps' receipt of this certification. You agree to comply with all permit terms and conditions, including additional reporting requirements, for the duration of the maintenance and monitoring period.



US Army Corps of Engineers®
Chicago District

**GENERAL CONDITIONS
APPLICABLE TO THE 2012
REGIONAL PERMIT PROGRAM**

The permittee shall comply with the terms and conditions of the Regional Permits and the following general conditions for all activities authorized under the RPP:

1. State 401 Water Quality Certification - Water quality certification under Section 401 of the Clean Water Act may be required from the Illinois Environmental Protection Agency (IEPA). The District may consider water quality, among other factors, in determining whether to exercise discretionary authority and require an Individual Permit. Please note that Section 401 Water Quality Certification is a requirement for projects carried out in accordance with Section 404 of the Clean Water Act. Projects carried out in accordance with Section 10 of the Rivers and Harbors Act of 1899 do not require Section 401 Water Quality Certification

On March 2, 2012, the IEPA granted Section 401 certification, with conditions, for all Regional Permits, except for activities in certain waterways noted under RPs 4 and 8. The following conditions of the certification are hereby made conditions of the RPP:

1. The applicant shall not cause:
 - a) a violation of applicable water quality standards of the Illinois Pollution Control Board Title 35, Subtitle C: Water Pollution Rules and Regulations;
 - b) water pollution defined and prohibited by the Illinois Environmental Protection Act;
 - c) interference with water use practices near public recreation areas or water supply intakes;
 - d) a violation of applicable provisions of the Illinois Environmental Protection Act.
2. The applicant shall provide adequate planning and supervision during the project construction period for implementing construction methods, processes and cleanup procedures necessary to prevent water pollution and control erosion.
3. Except as allowed under condition 9, any spoil material excavated, dredged or otherwise produced must not be returned to the waterway but must be deposited in a self-contained area in compliance with all State statutes, regulations and permit requirements with no discharge to waters of the State unless a permit has been issued by the Illinois EPA. Any backfilling must be done with clean material placed in a manner to prevent violation of applicable water quality standards.
4. All areas affected by construction shall be mulched and seeded as soon after construction as possible. The applicant shall undertake necessary measures and procedures to reduce erosion during construction. Interim measures to prevent soil erosion during construction shall be taken and may include the installation of sedimentation basins and temporary mulching. All construction within the waterway shall be conducted during zero or low flow conditions. The applicant shall be responsible for obtaining a NPDES Stormwater Permit prior to initiating construction if the construction activity associated with the project will result in the disturbance of (1) one or more acres, total land area. A NPDES Stormwater Permit may be obtained by submitting a properly completed Notice of Intent (NOI) form by certified mail to the Illinois EPA's Division of Water Pollution Control, Permit Section.
5. The applicant shall implement erosion control measures consistent with the Illinois Urban Manual (IEPA/USDA, NRCS; 2011, <http://aiswcd.org/IUM/index.html>).
6. The applicant is advised that the following permits(s) must be obtained from the Illinois EPA: The applicant must obtain permits to construct sanitary sewers, water mains, and related facilities prior to construction.
7. Backfill used in the stream-crossing trench shall be predominantly sand or larger size material, with less than 20% passing a #230 U.S. sieve.
8. Any channel relocation shall be constructed under dry conditions and stabilized to prevent erosion prior to the diversion of flow.
9. Backfill used within trenches passing through surface waters of the State, except wetland areas, shall be clean course aggregate, gravel or other material which will not cause siltation, pipe damage during placement, or chemical corrosion in place. Excavated material may be used only if:
 - a) particle size analysis is conducted and demonstrates the material to be at least 80% sand or larger size material, using #230 U.S. sieve; or
 - b) excavation and backfilling are done under dry conditions.
10. Backfill used within trenches passing through wetland areas shall consist of clean material which will not cause siltation, pipe damage during placement, or chemical corrosion in place. Excavated material shall be used to the extent practicable, with the upper six (6) to twelve (12) inches backfilled with the topsoil obtained during trench excavation.
11. Any applicant proposing activities in a mined area or previously mined area shall provide to the IEPA a written determination regarding the sediment and materials used which are considered "acid-producing material" as defined in 35 Il. Adm. Code,

Subtitle D. If considered "acid-producing material," the applicant shall obtain a permit to construct pursuant to 35 Il. Adm. Code 404.101.

12. Asphalt, bituminous material and concrete with protruding material such as reinforcing bar or mesh shall not be 1) used for backfill, 2) placed on shorelines/stream banks, or 3) placed in waters of the State.
13. Applicants that use site dewatering techniques in order to perform work in waterways for construction activities approved under Regional Permits 1 (Residential, Commercial and Institutional Developments), 2 (Recreation Projects), 3 (Transportation Projects), 7 (Temporary Construction Activities), 9 (Maintenance) or 12 (Bridge Scour Protection) shall maintain flow in the stream during such construction activity by utilizing dam and pumping, fluming, culverts or other such techniques.
14. In addition to any action required of the Regional Permit 13 (Cleanup of Toxic and Hazardous Materials Projects) applicant with respect to the "Notification" General Condition 22, the applicant shall notify the Illinois EPA Bureau of Water, of the specific activity. This notification shall include information concerning the orders and approvals that have been or will be obtained from the Illinois EPA Bureau of Land (BOL) for all cleanup activities under BOL jurisdiction, or for which authorization or approval is sought from BOL for no further remediation. This Regional Permit is not valid for activities that do not require or will not receive authorization or approval from the BOL.

2. Threatened and Endangered Species - If the District determines that the activity may affect Federally listed species or critical habitat, the District will initiate section 7 consultation with the U.S. Fish and Wildlife Service (USFWS) in accordance with the Endangered Species Act of 1973, as amended (Act). Applicants shall provide additional information that would enable the District to conclude that the proposed action will have no effect on federally listed species.

The application packet shall indicate whether resources (species, their suitable habitats, or critical habitat) listed or designated under the Act, may be present within areas affected (directly or indirectly) by the proposed project. Applicants shall provide a section 7 species list for the action area using the on-line process at the USFWS website. You can access "U.S. Fish and Wildlife Service Endangered Species Program of the Upper Midwest" website at www.fws.gov/midwest/Endangered. Click on the section 7 Technical Assistance green shaded box in the lower right portion of the screen and follow the instructions to completion. Review all documentation pertaining to the species list, provide the rationale for your effects determination for each species, and send the information to this office for review.

If no species, their suitable habitats, or critical habitat are listed, then a "no effect" determination can be made, and section 7 consultation is not warranted. If species or critical habitat appear on the list or suitable habitat is present within the action area, then a biological assessment or biological evaluation will need to be completed to determine if the proposed action will have "no effect" or "may effect" the species or suitable habitat. The District will request initiation of section 7 consultation with the USFWS upon agreement with the applicant on the effect determinations in the biological assessment or biological evaluation. If the issues are not resolved, the analysis of the situation is complicated, or impacts to listed species or critical habitat are found to be greater than minimal, the District will consider reviewing the project under the Individual Permit process.

Projects in Will, DuPage, or Cook Counties that are located in the recharge zones for Hine's emerald dragonfly critical habitat units may be reviewed under the RPP, with careful consideration due to the potential impacts to the species. All projects reviewed that are located within 3.25 miles of a critical habitat unit will be reviewed under Category II of the RPP. Please visit the following website for the locations of the Hine's emerald dragonfly critical habitat units in Illinois.
<http://www.fws.gov/midwest/endangered/insects/hed/FRHinesFinalRevisedCH.html>

3. Historic Properties - In cases where the District determines that the activity may affect properties listed, or eligible for listing, in the National Register of Historic Places, the activity may require an Individual Permit. A determination of whether the activity may be authorized under the RPP instead of an Individual Permit will not be made until the requirements of Section 106 of the National Historic Preservation Act (NHPA) have been satisfied.

Federal permittees should follow their own procedures for complying with the requirements of Section 106 of the National Historic Preservation Act. Federal permittees must provide the District with the appropriate documentation to demonstrate compliance with those requirements.

Non-Federal permittees must include notification to the District if the authorized activity may have the potential to cause effects to any historic properties listed, determined to be eligible for listing on, or potentially eligible for listing on the National Register of Historic Places, including previously unidentified properties. For such activities, the permit application must state which historic properties may be affected by the proposed work or include a vicinity map indicating the location of the historic properties or the potential for the presence of historic properties. Assistance regarding information on the location of or potential for the presence of historic resources can be sought from the State Historic Preservation Officer or Tribal Historic Preservation Officer, as appropriate, and the National Register of Historic Places (see 33 CFR 330.4(g)). When reviewing permit submittals, the District will comply with the current procedures for addressing the requirements of Section 106 of the National Historic Preservation Act. Based on the information submitted and these efforts, the District shall determine whether the proposed activity has the potential to cause an effect on the historic properties. Where the non-Federal applicant has identified historic properties which the activity may have the potential to cause effects and so notified the District, the non-Federal applicant shall not begin the activity until notified by the District either that the activity has no potential to cause effects or that consultation under Section 106 of the NHPA has been completed.

The District will take into account the effects on such properties in accordance with 33 CFR Part 325, Appendix C, and 36 CFR 800. If all issues pertaining to historic properties have been resolved through the consultation process to the satisfaction of the District, Illinois Historic Preservation Agency (IHPA) and Advisory Council on Historic Preservation, the District may, at its discretion, authorize the activity under the RPP instead of an Individual Permit.

Applicants are encouraged to obtain information on historic properties from the IHPA and the National Register of Historic Places at the earliest stages of project planning. For information, contact:

Illinois Historic Preservation Agency
1 Old State Capitol Plaza
Springfield, IL 62701-1507
(217) 782-4836
www.illinoishistory.gov

If you discover any previously unknown historic, cultural or archeological remains and artifacts while accomplishing the activity, you must immediately notify this office of what you have found, and to the maximum extent practicable, stop activities that would adversely affect those remains and artifacts until the required coordination has been completed. We will initiate the Federal, Tribal and State coordination required to determine if the items or remains warrant a recovery effort or if the site is eligible for listing in the National Register of Historic Places.

4. Soil Erosion and Sediment Control - Measures shall be taken to control soil erosion and sedimentation at the project site to ensure that sediment is not transported to waters of the U.S. during construction. Soil erosion and sediment control measures shall be implemented before initiating any clearing, grading, excavating or filling activities. All temporary and permanent soil erosion and sediment control measures shall be maintained throughout the construction period and until the site is stabilized. All exposed soil and other fills, and any work below the ordinary high water mark shall be permanently stabilized at the earliest practicable date.

Applicants are required to prepare a soil erosion and sediment control (SESC) plan including temporary BMPs. The plan shall be designed in accordance with the Illinois Urban Manual, 2011 (<http://aiswcd.org/IUM/index.html>). Practice standards and specifications for measures outlined in the soil erosion and sediment control plans will follow the latest edition of the "Illinois Urban Manual: A Technical Manual Designed for Urban Ecosystem Protection and Enhancement." Additional Soil Erosion and Sediment Control (SESC) measures not identified in the Illinois Urban Manual may also be utilized upon District approval.

At the District's discretion, an applicant may be required to submit the SESC plan to the local Soil and Water Conservation District (SWCD), or the Lake County Stormwater Management Commission (SMC) for review. When the District requires submission of an SESC plan, the following applies: An activity may not commence until the SESC plan for the project site has been approved; The SWCD/SMC will review the plan and provide a written evaluation of its adequacy; A SESC plan is considered acceptable when the SWCD/SMC has found that it meets technical standards. Once a determination has been made, the authorized work may commence unless the SWCD/SMC has requested that they be notified prior to commencement of the approved plans. The SWCD/SMC may attend pre-construction meetings with the permittee and conduct inspections during construction to determine compliance with the plans. Applicants are encouraged to begin coordinating with the appropriate SWCD/SMC office at the earliest stages of project planning. For information, contact:

Kane-DuPage SWCD
2315 Dean Street, Suite 100
St. Charles, IL 60174
(630) 584-7961 ext.3
www.kanedupageswcd.org

McHenry-Lake County SWCD
1648 South Eastwood Dr.
Woodstock, IL 60098
(815) 338-0099 ext.3
www.mchenryswcd.org

North Cook SWCD
899 Jay Street
Elgin, IL 60120
(847) 468-0071
www.northcookswcd.org

Lake County SMC
500 W. Winchester Rd, Suite 201
Libertyville, IL 60048
(847) 377-7700
www.lakecountyil.gov/stormwater

5. Total Maximum Daily Load - For projects that include a discharge of pollutant(s) to waters for which there is an approved Total Maximum Daily Load (TMDL) allocation for any parameter, the applicant shall develop plans and BMPs that are consistent with the assumptions and requirements in the approved TMDL. The applicant must incorporate into their plans and BMPs any conditions applicable to their discharges necessary for consistency with the assumptions and requirements of the TMDL within any timeframes established in the TMDL. The applicant must carefully document the justifications for all BMPs and plans, and install, implement and maintain practices and BMPs that are consistent with all relevant TMDL allocations and with all relevant conditions in an implementation plan. Information regarding the TMDL program, including approved TMDL allocations, can be found at the following website: www.epa.state.il.us/water/tmdl/

6. Floodplain - Discharges of dredged or fill material into waters of the United States within the 100-year floodplain (as defined by the Federal Emergency Management Agency) resulting in permanent above-grade fills shall be avoided and minimized to the maximum extent practicable. When such an above-grade fill would occur, the applicant may need to obtain approval from the Illinois

Department of Natural Resources, Office of Water Resources, (IDNR-OWR) which regulates activities affecting the floodway and the local governing agency (e.g., Village or County) with jurisdiction over activities in the floodplain. Compensatory storage may be required for fill within the floodplain. Applicants are encouraged to obtain information from the IDNR-OWR and the local governing agency with jurisdiction at the earliest stages of project planning. For information on floodway construction, contact:

IDNR/OWR
2050 Stearns Road
Bartlett, IL 60103
(847) 608-3100
<http://dnr.state.il.us/owr/>

For information on floodplain construction, please contact the local government and/or the Federal Emergency Management Agency. Pursuant to 33 CFR 320.4(j), the District will consider the likelihood of the applicant obtaining approval for above-ground permanent fills in floodplains in determining whether to issue authorization under the RPP.

7. Navigation - No activity may cause more than a minimal adverse effect on navigation. Any safety lights and signals prescribed by the U.S. Coast Guard, through regulations or otherwise, must be installed and maintained at the permittee's expense on authorized facilities in navigable waters of the United States. The permittee understands and agrees that, if future operations by the United States require the removal, relocation, or other alteration, of the structure or work herein authorized, or if, in the opinion of the Secretary of the Army or his authorized representative, said structure or work shall cause unreasonable obstruction to the free navigation of the navigable waters, the permittee will be required, upon due notice from the Corps of Engineers, to remove, relocate, or alter the structural work or obstructions caused thereby, without expense to the United States. No claim shall be made against the United States on account of any such removal or alteration.
8. Proper Maintenance - Any authorized structure or fill shall be properly maintained, including that necessary to ensure public safety.
9. Aquatic Life Movements - No activity may substantially disrupt the movement of those species of aquatic life indigenous to the waterbody, including species that normally migrate through the area, unless the activity's primary purpose is to impound water.
10. Equipment - Soil disturbance and compaction shall be minimized through the use of matting for heavy equipment, low ground pressure equipment, or other measures as approved by the District.
11. Wild and Scenic Rivers - No activity may occur in a component of the National Wild and Scenic River System or in a river officially designated by Congress as a "study river" for possible inclusion in the system, while the river is in an official study status. Information on Wild and Scenic Rivers may be obtained from the appropriate land management agency in the area, such as the National Park Service and the U.S. Forest Service.
12. Tribal Rights - No activity or its operation may impair reserved tribal rights, such as reserved water rights, treaty fishing and hunting rights.
13. Water Supply Intakes - No discharge of dredged or fill material may occur in the proximity of a public water supply intake except where the discharge is for repair of the public water supply intake structures or adjacent bank stabilization.
14. Shellfish Production - No discharge of dredged or fill material may occur in areas of concentrated shellfish production.
15. Suitable Material - No discharge of dredged or fill material may consist of unsuitable material and material discharged shall be free from toxic pollutants in toxic amounts (see Section 307 of the Clean Water Act). Unsuitable material includes trash, debris, car bodies, asphalt, and creosote treated wood.
16. Spawning Areas - Discharges in spawning areas during spawning seasons shall be avoided to the maximum extent practicable.
17. Obstruction of High Flows - Discharges shall not permanently restrict or impede the passage of normal or expected high flows. All crossings shall be culverted, bridged or otherwise designed to prevent the restriction of expected high water flows, and shall be designed so as not to impede low water flows or the movement of aquatic organisms.
18. Impacts From Impoundments - If the discharge creates an impoundment of water, adverse impacts on aquatic resources caused by the accelerated passage of water and/or the restriction of its flow shall be avoided to the maximum extent practicable.
19. Waterfowl Breeding Areas - Discharges into breeding areas for migratory waterfowl shall be avoided to the maximum extent practicable.
20. Removal of Temporary Fills - Any temporary fill material shall be removed in its entirety and the affected area returned to its pre-existing condition.
21. Mitigation - All appropriate and practicable steps must first be taken to avoid and minimize impacts to aquatic resources. For unavoidable impacts, compensatory mitigation is required to replace the loss of wetland, stream, and/or other aquatic resource functions (33 CFR 332). The proposed compensatory mitigation shall utilize a watershed approach and fully consider the ecological needs of the watershed. Where an appropriate watershed plan is available, mitigation site selection should consider recommendations in the plan. The applicant shall describe in detail how the mitigation site was chosen and will be developed, based on the specific

resource need of the impacted watershed. Permit applicants are responsible for proposing an appropriate compensatory mitigation option to offset unavoidable impacts. However, the District is responsible for determining the appropriate form and amount of compensatory mitigation required when evaluating compensatory mitigation options, and determining the type of mitigation that would be environmentally preferable. In making this determination, the District will assess the likelihood for ecological success and sustainability, the location of the compensation site relative to the impact site and their significance within the watershed. Methods of providing compensatory mitigation include aquatic resource restoration, establishment, enhancement, and in certain circumstances, preservation. Compensatory mitigation will be accomplished by establishing a minimum ratio of 1.5 acres of mitigation for every 1.0 acre of impact to waters of the U.S. Furthermore, the District has the discretion to require additional mitigation to ensure that the impacts are no more than minimal. Further information is available at www.lrc.usace.army.mil/Missions/Regulatory/Illinois/Mitigation.aspx.

22. Notification - The applicant shall provide written notification (i.e., a complete application) for a proposed activity to be authorized under the RPP prior to commencing a proposed activity. The District's receipt of the complete application is the date when the District receives all required notification information from the applicant (see below). If the District informs the applicant within 60 calendar days that the notification is incomplete (i.e., not a complete application), the applicant shall submit to the District, in writing, the requested information to be considered for review under the Regional Permit Program. A new 60 day review period will commence when the District receives the requested information. Applications that involve unauthorized activities that are completed or partially completed by the applicant are not subject to the 60-day review period.

For all activities, notification shall include:

- a. A cover letter providing a detailed narrative of the proposed activity describing all work to be performed, a clear project purpose and need statement, the Regional Permit(s) to be used for the activity, the area (in acres) of waters of the U.S. to be impacted (be sure to specify if the impact is permanent or temporary, and identify which area it affects), and a statement that the terms and conditions of the RPP will be followed.
- b. A completed joint application form for Illinois signed by the applicant or agent. The application form is available at www.lrc.usace.army.mil/Portals/36/docs/regulatory/forms/appform.pdf. If the applicant does not sign the joint application form, notification shall include a signed, written statement from the applicant designating the agent as their representative.
- c. A delineation of waters of the U.S., including wetlands, for the project area, and for areas adjacent to the project site (off-site wetlands shall be identified through the use of reference materials including review of local wetland inventories, soil surveys and the most recent available aerial photography), shall be prepared in accordance with the current U.S. Army Corps of Engineers methodology (www.usace.army.mil/Missions/CivilWorks/RegulatoryProgramandPermits/reg_supp.aspx) and generally conducted during the growing season.* Our wetland delineation standards are available at www.lrc.usace.army.mil/Portals/36/docs/regulatory/pdf/Delineations.pdf. For sites supporting wetlands, the delineation shall include a Floristic Quality Assessment (Swink and Wilhelm. 1994, latest edition, Plants of the Chicago Region). The delineation shall also include information on the occurrence of any high-quality aquatic resources (see Appendix A), and a listing of waterfowl, reptile and amphibian species observed while at the project area. The District reserves the right to exercise judgment when reviewing submitted wetland delineations. Flexibility of the requirements may be determined by the District on a case-by-case basis only.
- d. A street map showing the location of the project area.
- e. Latitude and longitude for the project in decimal degrees format (i.e. 41.88377N, -87.63960W).
- f. Preliminary engineering drawings sized 11" by 17" (full-sized may be requested by the project manager and you may also submit plans in PDF format on a disc) showing all aspects of the proposed activity and the location of waters of the U.S. to be impacted and not impacted. The plans shall include grading contours, proposed and existing structures such as buildings footprints, roadways, road crossings, stormwater management facilities, utilities, construction access areas and details of water conveyance structures. The plans shall also depict buffer areas, outlots or open space designations, best management practices, deed restricted areas and restoration areas, if required under the specific RP.
- g. Submittal of soil erosion and sediment control (SESC) plans that identify all SESC measures to be utilized during construction of the project.
- h. The application packet shall indicate whether resources (species, their suitable habitats, or critical habitat) listed or designated under the Endangered Species Act of 1973, as amended, may be present within areas affected (directly or indirectly) by the proposed project. Applicants shall provide a section 7 species list for the action area using the on-line process at the USFWS website. You can access "U.S. Fish and Wildlife Service Endangered Species Program of the Upper Midwest" website at www.fws.gov/midwest/Endangered. Click on the section 7 Technical Assistance green shaded box in the lower right portion of the screen and follow the instructions to completion. Print all documentation pertaining to the species list, include the rationale for your effects determination for each species, and forward the information to this office for review.

* If a wetland delineation is conducted outside of the growing season, the District will determine on a case-by-case basis whether sufficient evidence is available to make an accurate determination. If the District finds that the delineation lacks sufficient evidence, the application will not be considered complete until the information is provided. This may involve re-delineating the project site during the growing season.

In the event there are no species, their suitable habitats, or critical habitat, then a "no effect" determination can be made and section 7 consultation is not warranted. If species or critical habitat appear on the list, or suitable habitat is present within the action area, then a biological assessment or biological evaluation will need to be completed to determine if the proposed action will have "no effect" or "may effect" on the species or suitable habitat. The District will request initiation of section 7 consultation with the USFWS upon agreement with the applicant on the effect determinations in the biological assessment or biological evaluation. If the issues are not resolved, the analysis of the situation is complicated, or impacts to listed species or critical habitat are found to be greater than minimal, the District will consider reviewing the project under the Individual Permit process.

- i. A determination of the presence or absence of any State threatened or endangered species. Please contact the Illinois Department of Natural Resources (IDNR) to determine if any State threatened and endangered species could be in the project area. You can access the IDNR's Ecological Compliance Assessment Tool (EcoCAT) at the following website: <http://dnrecoecat.state.il.us/ecopublic/>. Once you complete the EcoCAT and consultation process, forward all resulting information to this office for consideration. The report shall also include recommended methods as required by the IDNR for minimizing potential adverse effects of the project.
- j. A statement about the knowledge of the presence or absence of Historic Properties, which includes properties listed, or properties eligible to be listed in the National Register of Historic Places. A letter from the Illinois Historic Preservation Agency (IHPA) can be obtained indicating whether your project is in compliance with Section 106 of the National Historic Preservation Act of 1966, as amended. The permittee shall provide all pertinent correspondence with the IHPA documenting compliance. The IHPA has a checklist of documentation required for their review located here: www.illinoishistory.gov/PS/rcdocument.htm.
- k. Where an appropriate watershed plan is available, the applicant shall address in writing how the proposed activity is aligned with the relevant water quality, hydrologic, and aquatic resource protection recommendations in the watershed plan.
- l. A discussion of measures taken to avoid and/or minimize impacts to aquatic resources on the project site.
- m. A compensatory mitigation plan for all impacts to waters of the U.S. (if compensatory mitigation is required under the specific RP).
- n. A written narrative addressing all items listed under the specific RP.

For Category II activities, the District will provide an Agency Request for Comments (ARC) which describes the proposed activity. The ARC will be sent to the following agencies: United States Fish & Wildlife Service (USFWS), United States Environmental Protection Agency (USEPA), Illinois Department of Natural Resources (IDNR), Illinois Department of Natural Resources/Office of Water Resources (IDNR/OWR), Illinois Environmental Protection Agency (IEPA), Illinois Historic Preservation Agency (IHPA), Illinois Nature Preserves Commission (INPC) and U.S. Coast Guard (Section 10 activities only). Additional entities may also be notified as needed. These agencies have ten (10) calendar days from the date of the ARC to contact the District and either provide comments or request an extension not to exceed fifteen (15) calendar days. The District will fully consider agency comments received within the specified time frame. If the District determines the activity complies with the terms and conditions of the RPP and impacts on aquatic resources are minimal, the District will notify the applicant in writing and include special conditions if deemed necessary. If the District determines that the impacts of the proposed activity are more than minimal, the District will notify the applicant that the project does not qualify for authorization under the RPP and instruct the applicant on the procedures to seek authorization under an Individual Permit.

23. Compliance Certification - Any permittee who has received authorization under the RPP from the District shall submit a signed certification regarding the completed work and any required mitigation. The certification will be forwarded by the District with the authorization letter and will include: a) a statement that the authorized work was done in accordance with the District's authorization, including any general or specific conditions; b) a statement that any required mitigation was completed in accordance with the permit conditions and; c) the signature of the permittee certifying the completion of the work and mitigation.

24. Multiple use of Regional Permits - In any case where a Regional Permit is combined with any other Regional Permit to cover a single and complete project (except where prohibited under specific Regional Permits), the applicant shall notify the District in accordance with General Condition 22. If multiple Regional Permits are used, the total impact may not exceed the maximum allowed by the Regional Permit with the greatest impact threshold.

25. Other Restrictions - Authorization under the RPP does not obviate the need to obtain other Federal, State or local permits, approvals, or authorizations required by law nor does it grant any property rights or exclusive privileges, authorize any injury to the property or rights of others or authorize interference with any existing or proposed Federal project.

Approved by:

//ORIGINAL SIGNED//
Frederic A. Drummond, Jr.
Colonel, U.S. Army
District Commander

February 24, 2012
Date

Kane – DuPage Soil & Water Conservation District

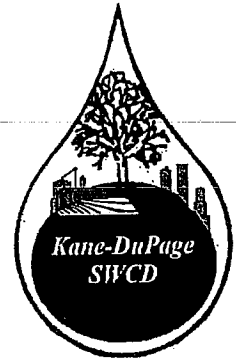

April 26, 2013

Stephen Chu, PWS
HR Green, Inc:
420 North Front Street, Suite 100
McHenry, IL 60050

RECEIVED

MAY - 1 2013

Corps Number: LRC 2010 00 827
KDSWCD File: 13e016
Approved Plan Set Dated: 4/26/2013

HR Green, Inc.
McHenry

Dear Mr. Chu:

I received your revised soil erosion and sedimentation control plan submittal for the Indian Trail over the Fox River Improvements project located in Aurora, Illinois. Thank you for incorporating our comments into the plan, it will improve the quality of protection for the natural resources, both on and off site. This letter and a set of stamped plans located at the construction office on site, will serve to certify that the erosion and sediment control plans meet Technical Standards.

I will visit the site several times during the course of construction to assess compliance with the specifications and will be glad to address specific issues that may arise during the course of construction.

Sincerely,

A handwritten signature in cursive script, appearing to read "Candice Jacobs".

Candice Jacobs, CPESC
Resource Conservationist
Kane-DuPage Soil and Water Conservation District

ECC: Kim Kubiak, USACE
Steve Andras, City of Aurora
Chris Lirot, City of Aurora

2315 Dean Street, Suite 100 St. Charles, Illinois 60175 (630) 584-7961x3 Fax: (630) 584-9534
www.kanedupageswcd.org

All programs and services of the Kane-DuPage SWCD are offered on a nondiscriminatory basis, without regard to race, color, national origin, religion, sex, marital status, or handicap.

155

**STRUCTURE GEOTECHNICAL REPORT
INDIAN TRAIL ROAD BRIDGES OVER FOX
RIVER**

**STRUCTURE NO. 045-3088 & 045-3089
SECTION NO. 09-00286-00-BR
AURORA, ILLINOIS
MSET FILE NO. 12316**



MSET

**Midland Standard Engineering & Testing, Inc.
558 Plate Drive, Unit 6 East Dundee, IL 60118**



MSET

WWW.MSETINC.COM

MIDLAND STANDARD ENGINEERING & TESTING, INC.

558 Plate Drive, Unit 6 East Dundee, Illinois 60118

(847) 844-1895 f(847) 844-3875

September 14, 2012

Mr. Robert Davies, S. E., P.E.

HR Green, Inc.

420 N. Front Street, Suite 100

McHenry, Illinois 60050

Re: Abbreviated Structure Geotechnical Report
Indian Trail Road Bridges over Fox River
Structure No. 045-3088 & 045-3089
Section No. 09-00286-00-BR
Aurora, Illinois
MSET File No. 12316

We have completed the exploration and analysis requested for the referenced structures. Our findings and recommendations are presented in the attached report. We are transmitting two (2) copies for your use and further distribution.

If you have any questions regarding this report, please feel free to call.

Sincerely,

MIDLAND STANDARD ENGINEERING & TESTING, INC.

William J. Wyzgala, P.E.

Principal Engineer

WJW

Enclosures



Original Report Date: 9/14/12 Proposed SN: _____ Route: Indian Trail Road over Fox Ri.
 Revised Date: _____ Existing SN: 045-3088 & 89 Section: 09-00286-00-BR
 Geotechnical Engineer: Midland Standard Engineering & Testing, Inc. County: Kane
 Structural Engineer: HR GReen, Inc. Contract: _____

Indicate the proposed structure type, substructure types, and foundation locations (attach plan and elevation drawing):
 see Section 1 (attached)

Discuss the existing boring data, existing plans foundation information, new subsurface exploration and need for any additional exploration to be provided with SGR Technical Memo (attach all data and subsurface profile plot):
 see Section 2 (attached)

Provide the location and maximum height of any new soil fill or magnitude of footing bearing pressure. Estimate the amount and time of the expected settlement. Indicate if further testing, analysis, and/or ground improvement/treatment is necessary:
 see Section 3 (attached)

Identify any new cuts or fill slope angles and heights. Estimate the factor of safety against slope failure. Indicate if further testing, analysis or ground improvement/treatment is necessary.
 see Section 4 (attached)

Indicate at each substructure, the 100-year and 500-year total scour depths in the Hydraulics report, the non-granular scour depth reduction, the proposed ground surface, and the recommended foundation design scour elevations.
 see Section 5 (attached)

Determining the seismic soil site class, the seismic performance zone, the 0.2 and 1.0 second design spectral accelerations and indicate if that the soils are liquefiable.
 see Section 6 (attached)

Confirm feasibility of the proposed foundation or wall type and provide design parameters. Attach a pile design table indicating feasible pile types, various nominal required bearings, factored resistances available and corresponding estimated lengths at locations where piles will be used. Provide factored bearing resistance and unit sliding resistance at various elevations and confirm no ground improvement/treatment is necessary where spread footings are proposed. Estimated top of rock elevations as well as preliminary skin friction and end bearing values shall be indicated when drilled shafts are proposed.
 see Section 7 (attached)

Calculate the estimated water surface elevation and determine the need for cofferdam(s) and seal coat:
 see Section 8 (attached)

Assess the need for sheeting/soil retention versus using a temporary construction slope and provide recommendation for the most feasible option.
 see Section 9 (attached)

Section 1

Project Description and Location

The project consists of the widening of two existing multi-span bridge structures serving Indian Rail Road over the Fox River in Aurora, Illinois. The west bridge is a seven span, four traffic lane structure with sidewalks on both sides that ends on the east side on an island in the river. The east bridge has three spans and is similar in design. The proposed improvements will widen both bridges on both sides, to accommodate additional traffic lanes. The foundation extensions are shown on the attached location plan. A total of eight soil borings were made to supplement historical borings from the original design.

Existing Bridge Structure Type

The west bridge is a seven span, steel girder bridge with a concrete deck and bituminous wearing surface. The total bridge length is 579 feet with the longest span at 115 feet. The bridge carries 4 traffic lanes over the Fox River and a bike path. The curb to curb width of 48 feet and a deck width of 60 feet. The east bridge is a three span structure of similar construction with a total length of 236 feet and a longest span of 90 feet.

Substructure Type

Old plans for the existing structure show that the bridge abutments for both structures are supported on piles, probable end bearing in the fractured rock. The piers, except the east pier of the east bridge, are shown to be supported by footings, somewhat embedded into the fractured rock. The east pier of the east bridge, because of scour concerns, is shown supported on piles. It is not known if the bridges were constructed exactly to the plan drawings.

Foundation Locations

The west bridge, SN# 045-3088 has six piers with the east two located in the river at normal water level. Of the six piers, the east three are constructed on a skew to the road centerline, the west three are not skewed. The east bridge, SN# 045-3089 has two piers, both are skewed and located in the river.

Reference the attached bridge plan and elevation by HR Green, Inc.

Section 2

Existing Boring Data

At the start of our work, MSET was provided with soil boring data made for the original design of the bridge. These borings, a total of nineteen (19) were located so that each foundation element was represented by one or two borings, excepting Pier 8, located on the east bridge, which had four borings along its foot print. The existing borings show alluvial deposits, overlying thin layers of very stiff Silty CLAY and coarse granular soils, overlying shallow depth weathered limestone bedrock.

New Soil Boring Locations

The field exploration for this report included eight (8) structure borings for the bridge abutment lengthening, labeled B-1 through B-8. The eight borings made to supplement the historical borings are located at the pier and abutment ends not covered in the original work.

A listing of the new boring locations is given below and is shown on the attached Boring Location Diagram:

<u>Boring Number</u>	<u>Foundation Location</u>
B-1	Pier 2 – North
B-2	Pier 3 – South
B-3	Pier 4 – North
B-4	Pier 5 – South
B-5	Pier 6 – North
B-6	Abutment 2 – South
B-7	Abutment 3 - North
B-8	Pier 7 South

Subsurface Conditions

Borings B-1 through B-5 were drilled on the ground below the bridge deck and 1.5 to 8.5 feet of soil was found overlying the weather bedrock. The soil consists mostly of Silty CLAY Topsoil like manmade Fill and alluvial FILL and clays mixed with sand & gravel and Sandy LOAM with gravel and cobbles, possible highly weathered rock. The underlying shallow depth dolomitic limestone bedrock is highly fractured at these locations with RQD values of 0% to 32% measured in the upper ten feet.

Borings B-6, B-7, and B-8 were drilled from the pavement level on Indian Trail Road with B-6 and B-7 encountering 13.5 to 18.0 feet of abutment/embankment FILL overlying natural deposits and then bedrock. The FILL at boring B-6 is uniform medium dense SAND & GRAVEL, A-1-a where as the fill at B-7 is layered Silty Clay LOAM, A-6 and crushed limestone materials. The natural soil beneath the Fill at these two locations consists of stiff to hard Silty CLAY, A-6 overlying SAND & GRAVEL, A-1-a. Weathered bedrock begins at a depth of 31.5 feet and 26 feet, respectively in this area and RQD readings of 37% and 73% were measured on the core samples.

Boring B-8 was drilled through the bridge deck and cased through the air to the river bed below. Slightly to medium dense Sandy LOAM, A-2-4, 5.5 feet thick, overlies the bedrock at this location. The bedrock is composed of weathered dolomitic limestone with an RQD of 44% in the first ten feet.

Details of the materials encountered, with field and laboratory test results are presented on the 'Log of Boring' B-1 through B-8 and the Soil Profile Drawings attached to this report.

Section 3

Location and Height of New Fill

The new fill on this project consists of widening of the existing road embankment at the bridge abutments and pavement on grade areas approaching the bridge structures. The largest amount of fill is expected at the west abutment of the west bridge where the new fill is 20 feet high added to the existing slope and graded to a 2h:1v final slope. Historical borings in this area, made before the embankment was constructed, show black cinder Fill over stiff to very stiff grey CLAY, and then highly weathered to fractured bedrock. Fill at the other three abutment locations is expected to be from 4 to 6 feet high.

Specific new borings for the embankment widening were not conducted, however the two borings made near the abutments, B-6 and B-7, generally encountered sufficiently compacted fill over stiff to hard CLAY and medium dense granular deposits above the bedrock at elevation 623 to 627.

Subgrade Preparation

Fill placement for embankment widening is roughly eight feet wide at the abutments on both sides of the alignment. The new fill will support pavements and sidewalks, not the bridge structure widening. The subgrade should be prepared by removing any surface vegetation and organic layers and leveling the footprint of the widening fill. This should be followed with a proof-roll and subgrade inspection with repair of any localized unstable zones. If previous fill exists, the base subgrade should be explored with a test pit to determine the integrity of the fill with depth to competent natural deposits. After these inspection steps are taken and weak soil areas are addressed, embankment can be placed and compacted in lifts per the Standard Specifications to design grade.

Embankment Fill Construction

Road embankment widening fill will be required for this project. Fill placed on existing slopes will require "stepping" procedures per IDOT guidelines to insure proper bonding of new fill to existing soil. All earthwork excavation, backfill, embankment and subgrade preparation should be conducted in accordance with the requirements of Sections 200 and 300 of the current IDOT "Standard Specifications for Road and Bridge Construction".

Moisture-density relationships should be developed from materials obtained from the site excavations and from off-site borrow sources. These relationships should be used to monitor FILL and backfill placement and compaction. A standard earthwork shrinkage factor of fifteen percent should be used for clayey borrow soils that are used for fill.

Considering proper installation and materials of the embankment widening fill as given herein, total settlement of the abutment approach pavement in the widening is expected to be 1" or less.

Section 4

New Slope Angles and Height

Current plans call for new fill placement to widening the existing embankment at the bridge abutments and on grade sections of the project. The largest section of fill occurs at the west abutment of the west bridge where new fill, about 10 feet wide, will be constructed on the existing slope. The existing slope is 20 feet high and the completed widening will be graded to a 2 horizontal to 1 vertical configuration. No new borings were located in this area and historical borings made prior to the embankment construction show a soil profile of 8 feet of miscellaneous FILL overlying 7 feet of stiff to very stiff natural CLAY and then bedrock. Other abutment fill areas are expected to be less in height, on the order of 4 to 6 feet.

Slope Stability Analysis

Using soil strength parameters and estimated geometrics of the high roadway embankment widening at the west abutment of the west bridge was checked for Slope Stability using a computer program called ReSSA by ADAMA Engineering, Inc. The program analyzes the slopes for the factor of safety against failure using the rotational or circular arc/Bishop Method, and using the Spencer Method for translational/direct sliding and three-part wedge stability calculation. The resulting factors of safety for a global slope failure at this location were found to be in excess of 1.3 (required) and are attached to this report. Ground improvement procedures to improve slope stability conditions are not required

Section 5

Scour Depth Considerations

The soil borings made for this investigation show good soil types to resist scour, consisting of fractured dolomitic limestone bedrock, RQD=0% to 44%, exist at anticipated footing subgrade elevations. RQD=0% means all pieces retrieved in the core sample were less than 4 inches long. Scour calculations should consider the river flow rate for the design storm event as well as the rock conditions/grain size. All footings should be constructed below the theoretical scour depth. If footing cannot be extended beneath the scour level, scour counter measures such as grouting of the rock or other procedures should be incorporated in the plans.

Section 6

Seismic Design Parameters

For the site seismic design calculations, the Spectral Response Accelerations from the 2003 NEHRP Seismic Design Provisions have been computed using the USGS website. The International Building Code (IBC) site classification definition is Class C, with very dense soil and rock located at proposed footing grade. The resulting AASHTO bridge seismic design parameters are $A_s=0.059$ g (0.0 sec), $S_Ds=0.123$ g (0.2 sec), and $SD1=0.064$ g (1.0 sec).

Conterminous 48 States
 2007 AASHTO Bridge Design Guidelines
 AASHTO Spectrum for 7% PE in 75 years
 Latitude = 41.782086
 Longitude = -088.312403
 Site Class B
 Data are based on a 0.05 deg grid spacing.

Period (sec)	Sa (g)	
0.0	0.049	PGA - Site Class B
0.2	0.102	Ss - Site Class B
1.0	0.038	S1 - Site Class B

Conterminous 48 States
 2007 AASHTO Bridge Design Guidelines
 Spectral Response Accelerations S_Ds and $SD1$
 Latitude = 41.782086
 Longitude = -088.312403
 $A_s = F_{pga}PGA$, $S_Ds = F_a S_s$, and $SD1 = F_v S_1$
 Site Class C - $F_{pga} = 1.20$, $F_a = 1.20$, $F_v = 1.70$
 Data are based on a 0.05 deg grid spacing.

Period (sec)	Sa (g)	
0.0	0.059	A_s - Site Class C
0.2	0.123	S_Ds - Site Class C
1.0	0.064	$SD1$ - Site Class C

Section 7

Recommended Foundation Type and Design Criteria

The plans for the existing structure indicate that most piers are founded on footings and one pier and the abutments are support by piles. It is recommended to widen these foundation elements in kind. The pier footings should be founded on the fractured bedrock and dimensioned using the allowable bearing pressure provided below. Based on the future scour depth calculations provided by the project hydraulic engineer, the footing depth should be adjusted or grouting of the rock may be required. The foundation widening for the abutments and the east pier of the east bridge should be supported on steel H-piles driven to refusal in the bedrock.

West Bridge SN 045-3088

Boring Number	Station	Offset	Structure Element	Existing Foundation Type	Existing Footing Elev./Plan	Top of Cored Rock	Core Elev./RQD/Allowable Bearing		
							1 st 5' Run	2 nd 5' Run	3 rd 5' Run
B-1	94+70	35' R	Pier 2L	Footing	629	628.9	628.9-623.9	623.9-618.9	618.9-613.9
							0%	0%	57%
							10 tsf	10tsf	65 tsf
B-2	95+66	24' R	Pier 3R	Footing	628	630.6	630.6-625.6	625.6-620.6	620.6-615.6
							13%	10%	38%
							10 tsf	10 tsf	30 tsf
B-3	95+90	36' L	Pier 4L	Footing	627	629.6	629.6-624.6	624.6-619.6	619.6-614.6
							0%	7%	43%
							10 tsf	10 tsf	30 tsf
B-4	97+18	36' R	Pier 5R	Footing	624	627.5	627.5-622.5	622.5-617.5	617.5-612.5
							25%	32%	35%
							30 tsf	30 tsf	30 tsf
B-5	98+28	37' L	Pier 6L	Footing	623	625.8	625.8-620.8	620.8-615.8	615.8-610.8
							12%	21%	17%
							10 tsf	10 tsf	10 tsf
B-6	99+35	18' R	AB 2R	Piles	Pile Cap	622.9	622.9-617.9	617.9-612.9	612.9-607.9
					643.6		22%	0%	37%
							9 ksi, Driven to Refusal		

East Bridge SN 045-3089

Boring Number	Station	Offset	Structure Element	Existing Foundation Type	Existing Footing Elev./Plan	Top of Cored Rock	Core Elev./RQD/Allowable Bearing		
							1 st 5' Run	2 nd 5' Run	3 rd 5' Run
B-7	100+54	56' L	AB 3L	Piles	Pile Cap	625.5	625.5-620.5	620.5-615.5	615.5-610.5
					642.6		24%	44%	73%
							9 ksi, Driven to Refusal		
B-8	101+66	20' R	Pier 7R	Footing	624	625.4	625.4-620.4	620.4-615.4	615.4-610.4
							10%	25%	88%
							10 tsf	30 tsf	65 tsf

From Construction Plans for Existing Bridges

Structure Settlement

A review of the structure settlement potential was performed. The pier footings and abutment piles will be supported by the shallow depth, fractured limestone bedrock. Allowable bearing pressures given for the footings are based on conservative long-term settlements of less than one inch. Piles driven to refusal in the bedrock are expected to settle less than one inch.

Sliding Resistance

Considering the fractured rock subgrade, a friction factor ($\tan \delta$) = 0.6 between clean fractured rock and the footing concrete should be used, and a minimum sliding stability factor of safety of 1.5, not including passive resistance should be provided.

Foundation Backfill

All foundation elements should be backfilled in accordance with Article 502.10 'Backfilling', in Excavation for Structures Section 502 of the Standard Specifications for Road and Bridge Construction.

Section 8

Groundwater Conditions

Ground water is consistent with the river level in this area, elevation 632+/- at the time of our field work.

Foundation Construction Considerations

To construct the pier foundation extensions, an excavation below the river level is expected. These excavations will require the use of a sealed cofferdam for excavation sidewall support and dewatering procedures. Excavations for the abutment pile caps in the existing fill materials will require sloping or bracing of the sidewalls.

All excavations will require shoring and bracing of the excavation sidewalls. Note that OSHA requirements dictate the use of sloping back or shoring and bracing of the excavation during installation. All work should be done in accordance with OSHA and local requirements.

Section 9

Boring B-6 was drilled through the existing pavement, close to the east abutment for the west bridge and sand and gravel backfill was encountered to a depth of 13.5 feet. Because of these conditions, it is recommended that temporary sheet piling be used to support the excavations to widen the abutment pile caps and maintain stability and support for adjacent traffic lanes. The existing pavement encountered in four pavement cores located 50 feet or more off the bridge decks consists of 0 to 1-1/2 inches of bituminous concrete over 10-1/2 to 11 inches of reinforced PCC pavement. Reference the attached Pavement Core Logs for details of the core locations and materials encountered.

Attachments: Project Vicinity Map
Bridge Plan & Elevation
Boring Location Diagram
Boring Logs
Rock Core Pictures
Subsurface Soil Profiles
Pavement Core Logs
Slope Stability Computations
General Notes

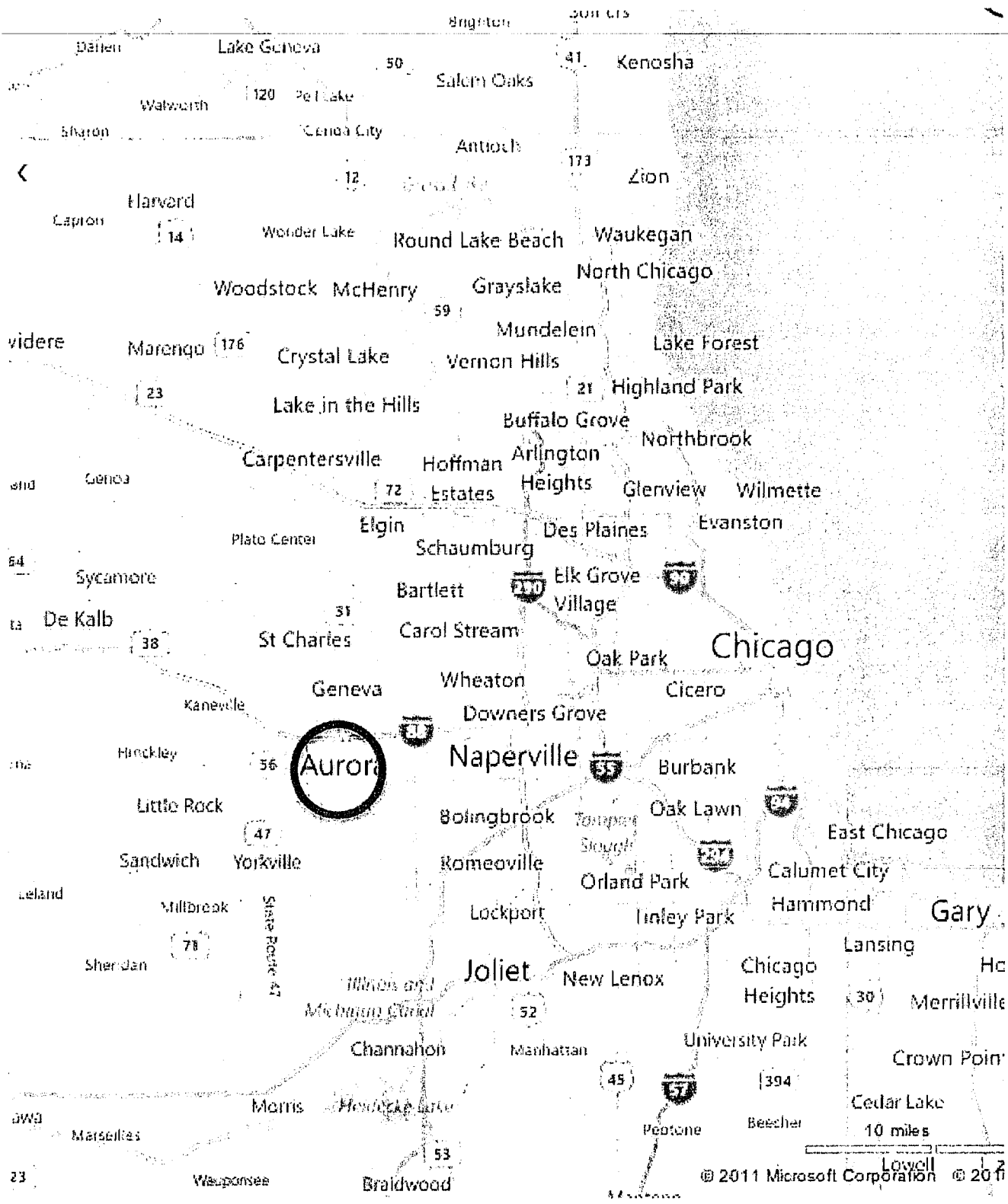

PROJECT VICINITY MAP
INDIAN TRAIL ROAD OVER FOX RIVER
AURORA, IL. MSET #12316

145

see span cast-in-place
Flange sections support
entire. The existing concrete
out-to-out deck width is
length of 240'-5 7/8"

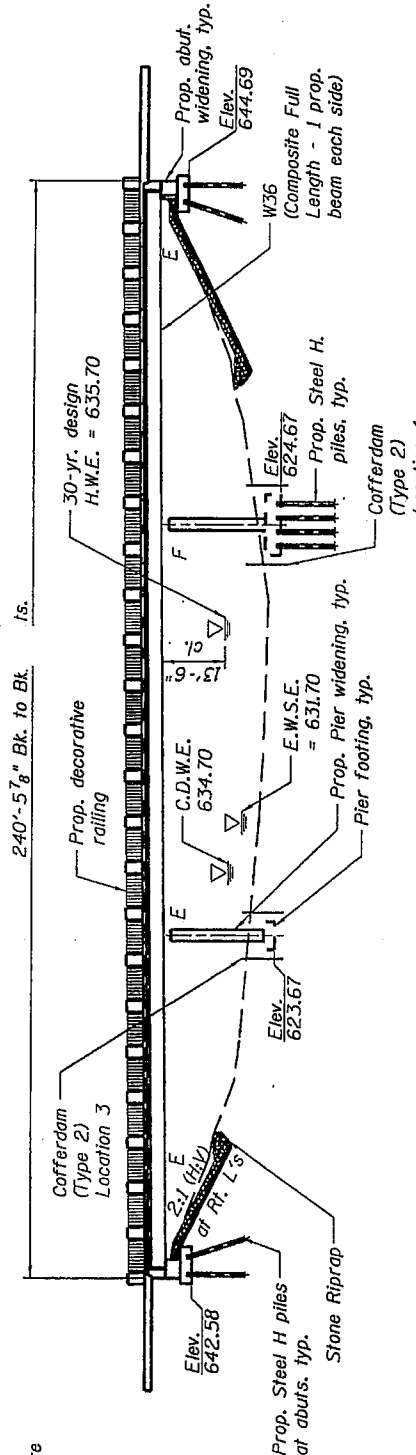

ELEVATION

PVT Sta. 91+83.00
Elev. 673.46
PVC Sta. 93+05.00
Elev. 672.44
PVI Sta. 93+85.00
0.84%

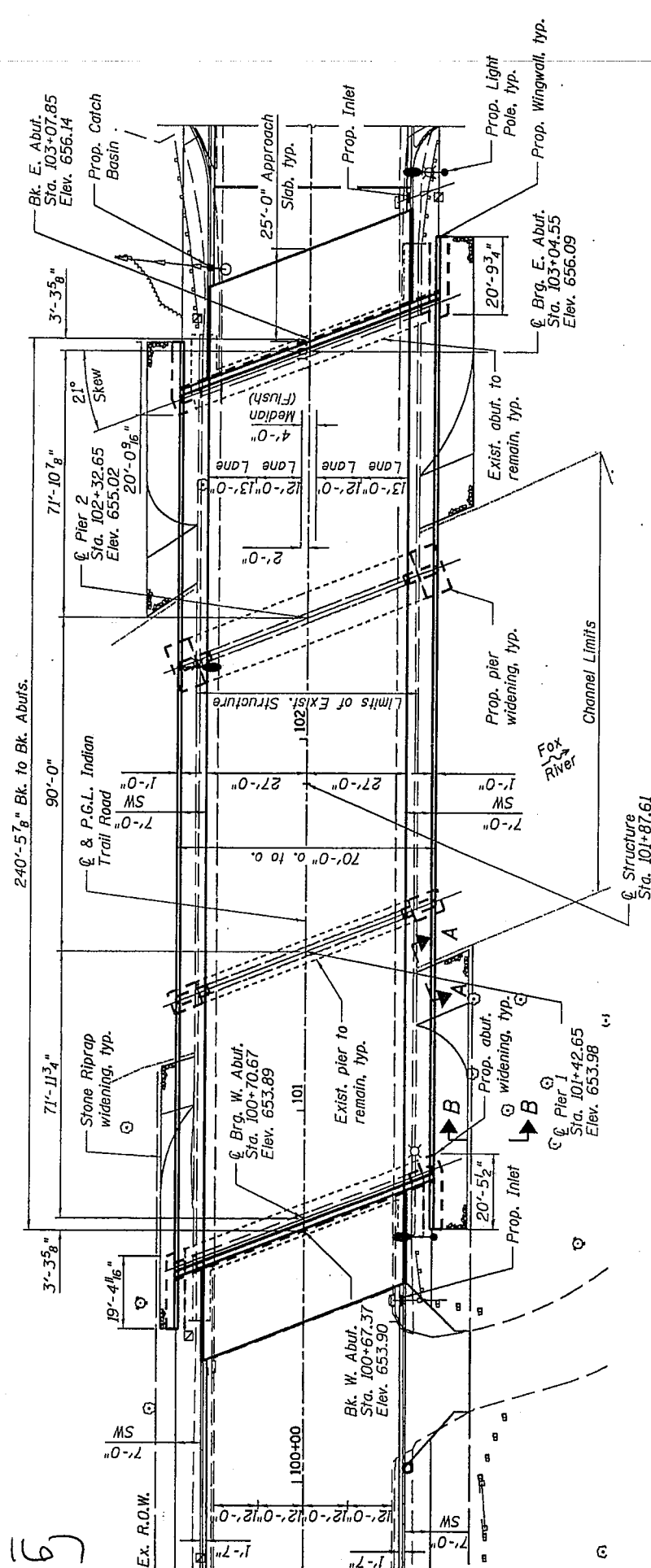

To the best of my knowledge, information and belief, this bridge design is structurally adequate for the design loading shown on the plans. The design is an economical one for the style of structure and complies with the requirements of the current "AASHTO Standard Specifications For Highway Bridges".

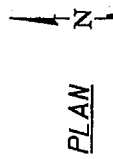

ERWAY INFORMATION

Low Grade Elev. 653.26 @ Sta. 101+04		Head - Ft.		Headwater E.I.	
Opening	Sq. Ft.	Exist.	Prop.	Exist.	Prop.
1.950	1.950	635.7	0.2	635.9	635.9
2.208	2.208	636.6	0.2	636.8	636.8

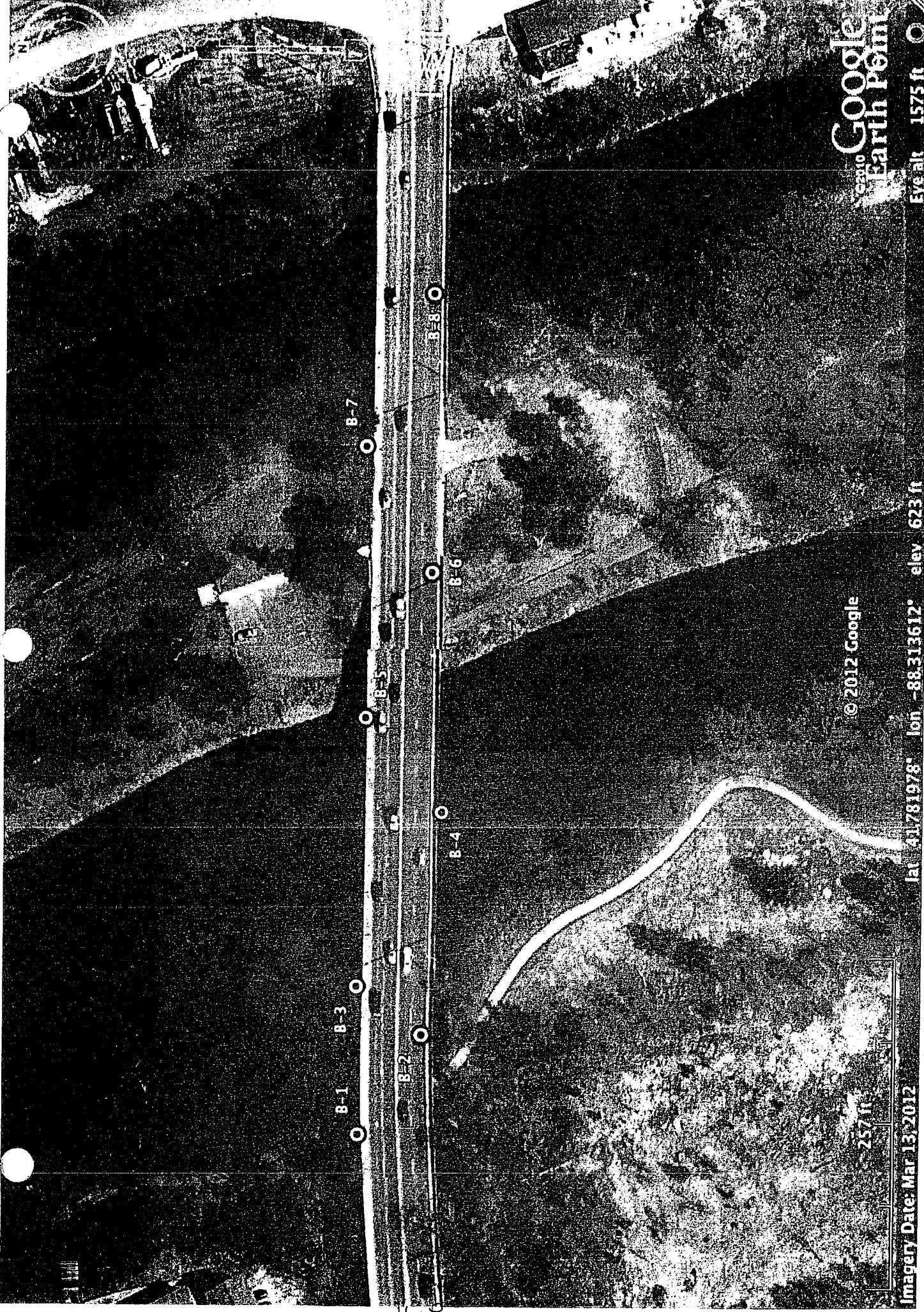

©2012 Google
Earth Point

Eye alt 1575 ft

© 2012 Google

lat 41.781978° lon -88.313612° elev 623 ft

257 ft

Imagery Date: Mar 13, 2012



PROJECT: Indian Trail Road over the Fox River

SITE LOCATION: Aurora, Illinois

BORING LOCATION: Pier 2 - North

CLIENT: HR Green, Inc.

DEPTH (feet)	SOIL TYPE	Material Description	Elevation	SAMPLE			TESTS		REMARKS
				TYPE/ INTERVAL	NO.	N-VALUE Blows per ft.	Wc%	Dry Unit Weight, pcf	
0		Dark Brown Silty CLAY, Topsoil	640.4	AU			14		
		Brown, Dark Brown, & Black Sandy Clay LOAM, A-6, mixed FILL	639.4	SS	1	17	17		
4			SS	2	4	17			
		Grey to Brown & grey Silty Clay LOAM, A-6, stiff	634.9	SS	3	7	24	93	1.71
8			SS	4	76	6			
		Light Brown, Weathered, Dolomitic Limestone Bedrock	631.9	SS	5	100/4"	7		
12			RC						
		RQD=0% from 11.5' to 21.5'		RC					
16				RC					
		RQD=57% from 21.5' to 26.5'		RC					
20				RC					
24				RC					
		End of Boring at 26.5 Feet	613.9						

WATER LEVEL OBSERVATIONS, ft.
 DURING DRILLING:  9.0'
 IMMEDIATELY AFTER DRILLING: 
 DELAYED READING AFTER 



MSET







BORING STARTED: 7/23/12
 BORING COMPLETED: 7/23/12
 LOGGED BY: MP
 BORING METHOD: HSA



PROJECT: Indian Trail Road over the Fox River

SITE LOCATION: Aurora, Illinois

BORING LOCATION: P3-R (South)

CLIENT: HR Green, Inc.

DEPTH (feet)	SOIL TYPE	Material Description	Elevation	SAMPLE			TESTS			REMARKS
				TYPE/INTERVAL	NO.	N-VALUE Blows per ft.	Wc%	Dry Unit Weight, pcf	Unconfined Compressive Strength, tsf	
0		Dark Brown Silty CLAY Topsoil	635.6	AU						
		Brown SAND & GRAVEL, A-1-a with some weathered limestone	634.6	SS	1	10	8			
4		Light Brown, weathered, Dolomitic Limestone with trace clay	632.1	SS	2	65/9"	12			
8		RQD=13% from 5' to 10'		RC						
12		RQD=10% from 10' to 15'		RC						
16		RQD=38% from 15' to 20'		RC						
20		End of Boring at 20.0 Feet	615.6							

WATER LEVEL OBSERVATIONS, ft.
 DURING DRILLING: 
 IMMEDIATELY AFTER DRILLING: 
 DELAYED READING AFTER 



BORING STARTED: 7/26/12
 BORING COMPLETED: 7/26/12
 LOGGED BY: MHP
 BORING METHOD: CFA



PROJECT: Indian Trail Road over the Fox River

SITE LOCATION: Aurora, Illinois

BORING LOCATION: P4-L(North)

CLIENT: HR Green, Inc.

DEPTH (feet)	SOIL TYPE	Material Description	Elevation	SAMPLE			TESTS			REMARKS
				TYPE/ INTERVAL	NO.	N-VALUE Blows per ft.	Wc%	Dry Unit Weight, pcf	Unconfined Compressive Strength, tsf	
0		Dark Brown Silty CLAY Topsoil	634.6	AU			14			
		Brown, Grey, & Black Sandy Clay LOAM, A-6, FILL	633.6	SS	1	16	14			
4		Light Brown and Grey Weathered Dolomitic Limestone	631.6	SS	2	55/6"	14			
8		RQD=0% from 5' to 10'		RC						
12		RQD=7% from 10' to 15'		RC						
16		RQD=43% from 15' to 20'		RC						
20		End of Boring at 20.0 Feet	614.6							

WATER LEVEL OBSERVATIONS, ft.
 DURING DRILLING: 
 IMMEDIATELY AFTER DRILLING: 
 DELAYED READING AFTER 



MSET

BORING STARTED: 7/23/12
 BORING COMPLETED: 7/23/12
 LOGGED BY: MHP
 BORING METHOD: HSA



PROJECT: Indian Trail Road over the Fox River

SITE LOCATION: Aurora, Illinois

BORING LOCATION: P5-R (South)

CLIENT: HR Green, Inc.

DEPTH (feet)	SOIL TYPE	Material Description	Elevation	SAMPLE			TESTS			REMARKS
				TYPE/ INTERVAL	NO.	N-VALUE Blows per ft.	Wc%	Dry Unit Weight, pcf	Unconfined Compressive Strength, tsf	
0		Dark Grey Sandy LOAM, A-4 with Gravel and Cobbles	629.5							
		Grey Weathered Dolomitic Limestone	628.1	SS	1	50/5"	12			
4		RQD=25% from 2' to 7'		RC						
8		RQD=32% from 7' to 12'		RC						
12		RQD=35% from 12' to 17'		RC						
16		End of Boring at 17.0 Feet	612.5							

WATER LEVEL OBSERVATIONS, ft.
 DURING DRILLING: 
 IMMEDIATELY AFTER DRILLING: 
 DELAYED READING AFTER 



BORING STARTED: 7/24/12
 BORING COMPLETED: 7/24/12
 LOGGED BY: MHP
 BORING METHOD: HSA



PROJECT: Indian Trail Road over the Fox River

SITE LOCATION: Aurora, Illinois

BORING LOCATION: P6-L (North)

CLIENT: HR Green, Inc.

DEPTH (feet)	SOIL TYPE	Material Description	Elevation	SAMPLE			TESTS			REMARKS
				TYPE/ INTERVAL	NO.	N-VALUE Blows per ft.	Wc%	Dry Unit Weight, pcf	Unconfined Compressive Strength, tsf	
0		Dark Grey Sandy LOAM, with Gravel, A-2 4	631.3	AU			20			
				SS	1	9	20			
4		Grey Weathered Dolomitic Limestone	629.3							
				SS	2	40	4			
8		RQD=12% from 5.5' to 10.5'		RC						
12		RQD=21% from 10.5' to 15.5'		RC						
16		RQD=17% from 15.5' to 20.5'		RC						
20		End of Boring at 20.5 Feet	610.8							

WATER LEVEL OBSERVATIONS, ft.
 DURING DRILLING: 
 IMMEDIATELY AFTER DRILLING: 
 DELAYED READING AFTER 



MSET

BORING STARTED: 7/24/12
 BORING COMPLETED: 7/24/12
 LOGGED BY: MHP
 BORING METHOD: CFA



PROJECT: **Indian Trail Road over the Fox River**

SITE LOCATION: **Aurora, Illinois**

BORING LOCATION: **Abutment 2 (South)**

CLIENT: **HR Green, Inc.**

DEPTH (feet)	SOIL TYPE	Material Description	Elevation	SAMPLE			TESTS			REMARKS
				TYPE/INTERVAL	NO.	N-VALUE Blows per ft.	Wc%	Dry Unit Weight, pcf	Unconfined Compressive Strength, tsf	
0		Pavement Materials, 2" Bit. Concrete over 14" reinforced PCC	654.9							
		Brown SAND & GRAVEL, A-1-a FILL	653.5	SS	1	21	4			
4				SS	2	26	5			
				SS	3	22	5			
8				SS	4	18	12			
				SS	5	19	9			
12				SS	6	17	20	107	4.19	
		Brown and Grey Silty CLAY, A-6 Hard to Stiff	641.4	SS	7	10	23	100	1.86	
16				SS	8	12	20		3.0 Qp	
				SS	9	17	18	112	3.10	
24				SS	10	33	9			
		Grey SAND and GRAVEL, A-1-a dense to slightly dense	630.9	SS	11	13	10			
28				SS	12	9	12			
		continued								

WATER LEVEL OBSERVATIONS, ft.
 DURING DRILLING: 
 IMMEDIATELY AFTER DRILLING: 
 DELAYED READING AFTER 



BORING STARTED: 7/27/12
 BORING COMPLETED: 7/27/12
 LOGGED BY: MHP
 BORING METHOD: HSA

PROJECT: Indian Trail Road over the Fox River

SITE LOCATION: Aurora, Illinois

BORING LOCATION: Abutment 2 (South)

CLIENT: HR Green, Inc.

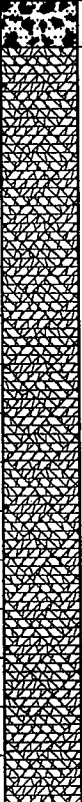
DEPTH (feet)	SOIL TYPE	Material Description	Elevation	SAMPLE			TESTS		REMARKS
				TYPE/INTERVAL	NO.	N-VALUE Blows per ft.	Wc%	Dry Unit Weight, pcf	
32		Grey Dolomitic Limestone Bedrock, Weathered	623.4						
		RQD=22% from 32' to 37'		RC					
36									
40		RQD=0% from 37' to 42'		RC					
44		RQD=37% from 42' to 47'		RC					
		End of Boring at 47.0 Feet	607.9						

WATER LEVEL OBSERVATIONS, ft.

DURING DRILLING:

IMMEDIATELY AFTER DRILLING:

DELAYED READING AFTER



MSET

BORING STARTED: 7/27/12

BORING COMPLETED: 7/27/12

LOGGED BY: MHP

BORING METHOD: HSA



PROJECT: Indian Trail Road over the Fox River

SITE LOCATION: Aurora, Illinois

BORING LOCATION: AB-1L (North)

CLIENT: HR Green, Inc.

DEPTH (feet)	SOIL TYPE	Material Description	Elevation	SAMPLE			TESTS			REMARKS
				TYPE/INTERVAL	NO.	N-VALUE Blows per ft.	Wc%	Dry Unit Weight, pcf	Unconfined Compressive Strength, tsf	
0		Dark Brown to Black Silty CLAY, A-6 Topsoil	653.0	AU			21			
		Brown and Black Silty Clay LOAM, A-6 FILL stiff	651.5	SS	1	5	18			
4				SS	2	4	11		1.0 Qp	
		Light Brown and Grey Fractured Limestone, A-1-a mixed with brown Sandy LOAM, A-2-4 Probable FILL	646.5	SS	3	11	6			
				SS	4	22	11			
		Brown Silty Clay LOAM, A-6 FILL stiff	642.5	SS	5	9	18	105	0.97	
		Light Brown and Grey Fractured Limestone, A-1-a possible FILL	640.0	SS	6	14	5			
				SS	7	10	7			
		Grey and Brown CLAY, A-6 stiff to very stiff	635.0	SS	8	17	16	111	1.73	
				SS	9	12	23	100	2.52	
		Grey SAND and GRAVEL, A-1-a some weathered limestone fragments, medium dense	630.0	SS	10	19	17			
		Grey Dolomitic Limestone Bedrock, Weathered	627.0	SS	11	80/2"	10			
28		RQD=24% from 27' to 32' continued		RC						

WATER LEVEL OBSERVATIONS, ft.
 DURING DRILLING: 
 IMMEDIATELY AFTER DRILLING: 
 DELAYED READING AFTER 



BORING STARTED: 7/25/12
 BORING COMPLETED: 7/25/12
 LOGGED BY: MHP
 BORING METHOD: CFA



PROJECT: Indian Trail Road over the Fox River

SITE LOCATION: Aurora, Illinois

BORING LOCATION: AB-1L (North)

CLIENT: HR Green, Inc.

DEPTH (feet)	SOIL TYPE	Material Description	Elevation	SAMPLE			TESTS			REMARKS
				TYPE/ INTERVAL	NO.	N-VALUE Blows per ft.	Wc%	Dry Unit Weight, pcf	Unconfined Compressive Strength, tsf	
32		Grey Dolomitic Limestone Bedrock, Weathered RQD=44% from 32' to 37'		RC						
36				RC						
40		RQD=73% from 37' to 42'		RC						
		End of Boring at 42.0 Feet	611.0							

WATER LEVEL OBSERVATIONS, ft.
 DURING DRILLING: 
 IMMEDIATELY AFTER DRILLING: 
 DELAYED READING AFTER 



BORING STARTED: 7/25/12
 BORING COMPLETED: 7/25/12
 LOGGED BY: MHP
 BORING METHOD: CFA



PROJECT: **Indian Trail Road over the Fox River**

SITE LOCATION: **Aurora, Illinois**

BORING LOCATION: **P7-R (South)**

CLIENT: **HR Green, Inc.**

DEPTH (feet)	SOIL TYPE	Material Description	Elevation	SAMPLE			TESTS			REMARKS
				TYPE/ INTERVAL	NO.	N-VALUE Blows per ft.	Wc%	Dry Unit Weight, pcf	Unconfined Compressive Strength, tsf	
0		Bridge Deck, Bit. Concrete over Reinforced Concrete	653.9							
		Air Space	652.9							
4										
8										
12										
16										
20										
24		Brown Sandy LOAM, A-2-4 with Limestone Fragments, slughtly dense	631.9	SS	1	6	7			
28		Dark Grey Sandy LOAM, A-2-4 with Gravel, medium dense	628.4	SS	2	22	11			
		Grey Dolomitic Limestone Bedrock, Weathered	626.4		3	80/1"	6			
		continued								

WATER LEVEL OBSERVATIONS, ft.
 DURING DRILLING: 
 IMMEDIATELY AFTER DRILLING: 
 DELAYED READING AFTER 



BORING STARTED: 7/26/12
 BORING COMPLETED: 7/26/12
 LOGGED BY: MHP
 BORING METHOD: HSA



PROJECT: **Indian Trail Road over the Fox River**

SITE LOCATION: **Aurora, Illinois**

BORING LOCATION: **P7-R (South)**

CLIENT: **HR Green, Inc.**

DEPTH (feet)	SOIL TYPE	Material Description	Elevation	SAMPLE			TESTS			REMARKS
				TYPE/ INTERVAL	NO.	N-VALUE Blows per ft.	Wc%	Dry Unit Weight, pcf	Unconfined Compressive Strength, tsf	
32		Grey Dolomitic Limestone Bedrock, Weathered RQD=10% from 28.5' to 33'		RC						
36		RQD=25% from 33' to 38'		RC						
40		RQD=88% from 38' to 43'		RC						
		End of Boring at 43.0 Feet	610.9							

WATER LEVEL OBSERVATIONS, ft.
 DURING DRILLING: 
 IMMEDIATELY AFTER DRILLING: 
 DELAYED READING AFTER 



BORING STARTED: 7/26/12
 BORING COMPLETED: 7/26/12
 LOGGED BY: MHP
 BORING METHOD: HSA

MIDLAND STANDARD ENGINEERING & TESTING, INC.
INDIAN TRAIL ROAD OVER THE FOX RIVER
AURORA, IL
MSET FILE NO: 12316

11.5'

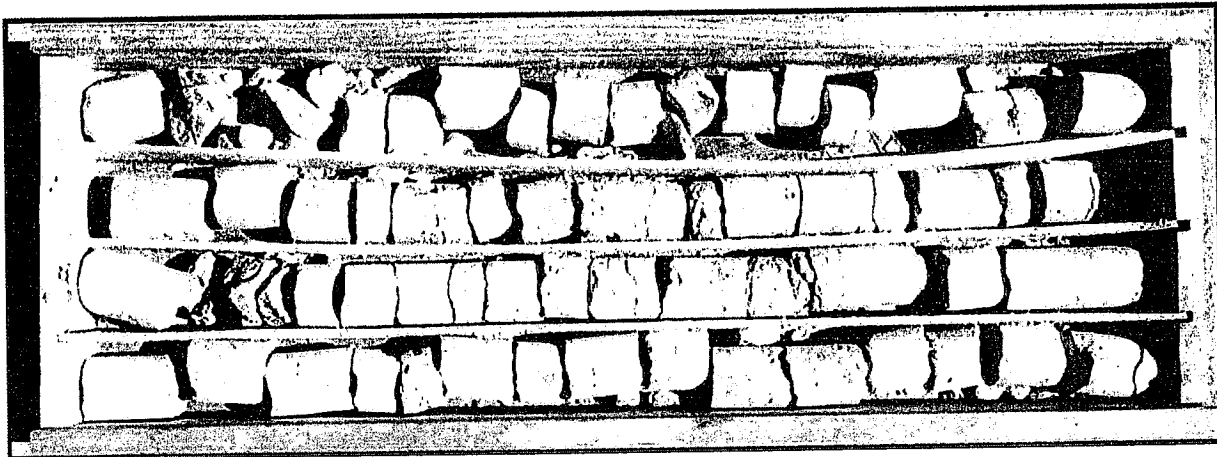

21.5'

B-1 (11.5' to 21.5')

21.5'

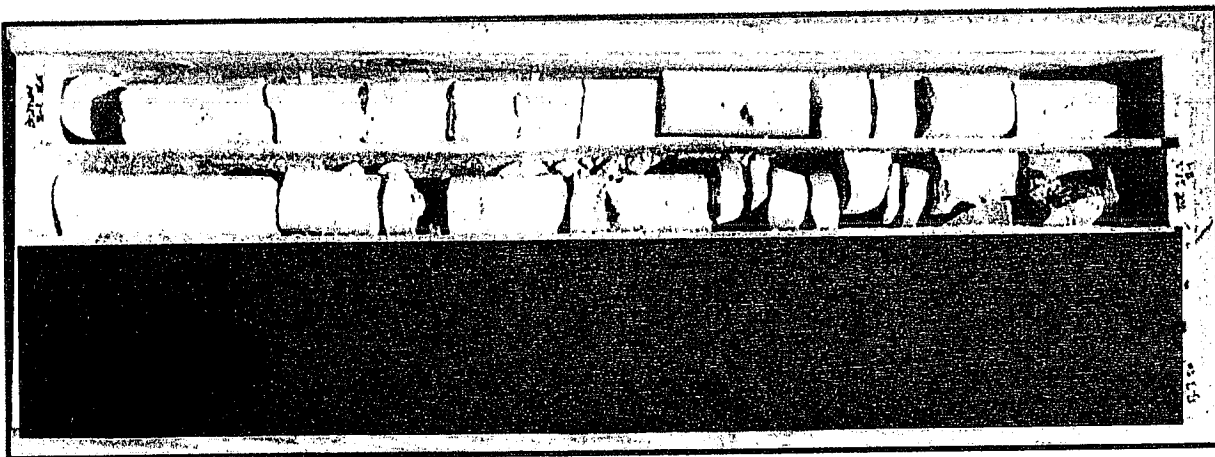

26.5'

B-1 (21.5' to 26.5')

MIDLAND STANDARD ENGINEERING & TESTING, INC.
INDIAN TRAIL ROAD OVER THE FOX RIVER
AURORA, IL
MSET FILE NO: 12316

5'

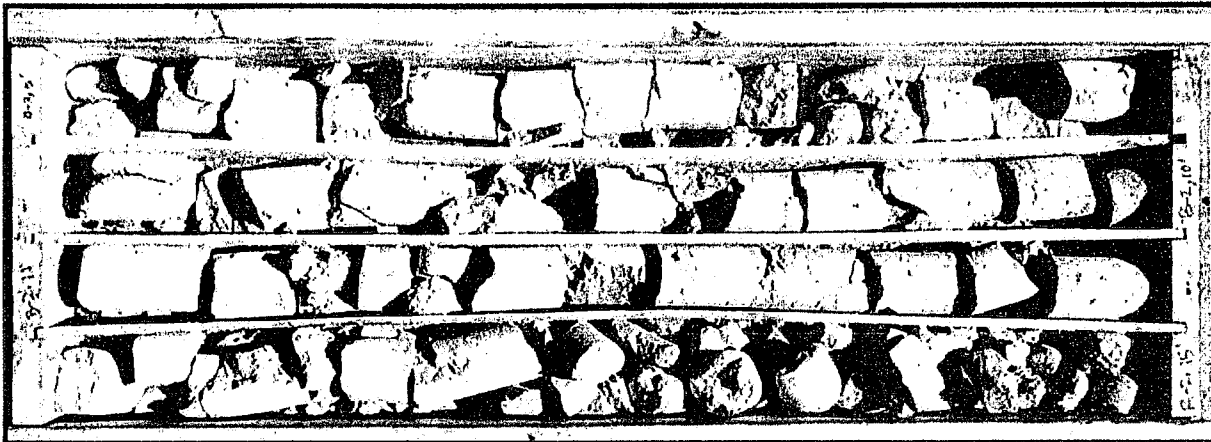

15'

B-2 (5' to 15')

15'

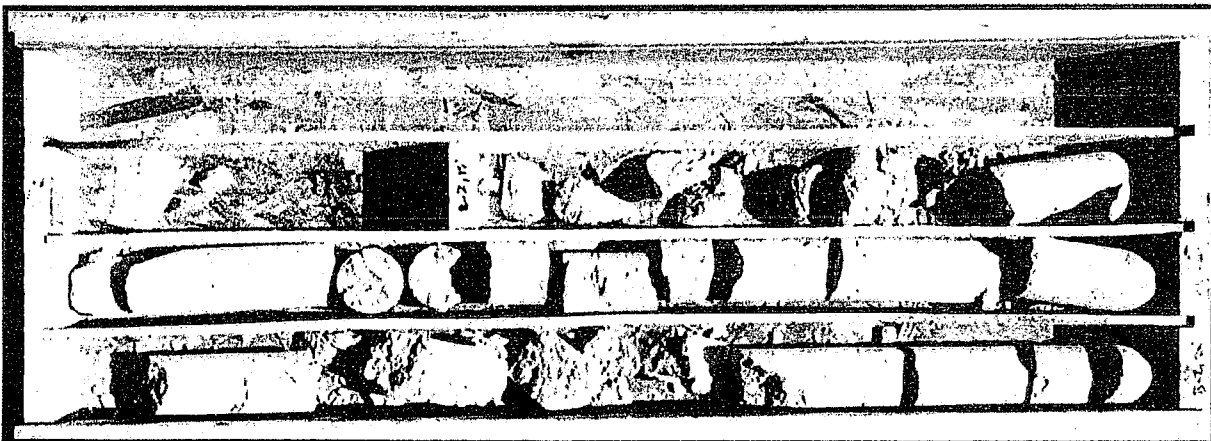

20'

B-2 (15' to 20')

MIDLAND STANDARD ENGINEERING & TESTING, INC.
INDIAN TRAIL ROAD OVER THE FOX RIVER
AURORA, IL
MSET FILE NO: 12316

5'

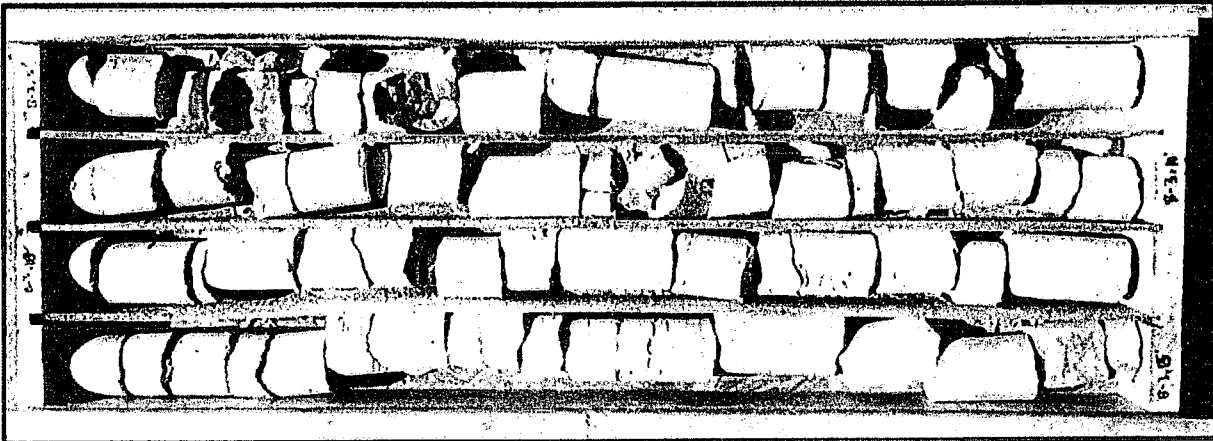

15'

B-3 (5' to 15')

15'

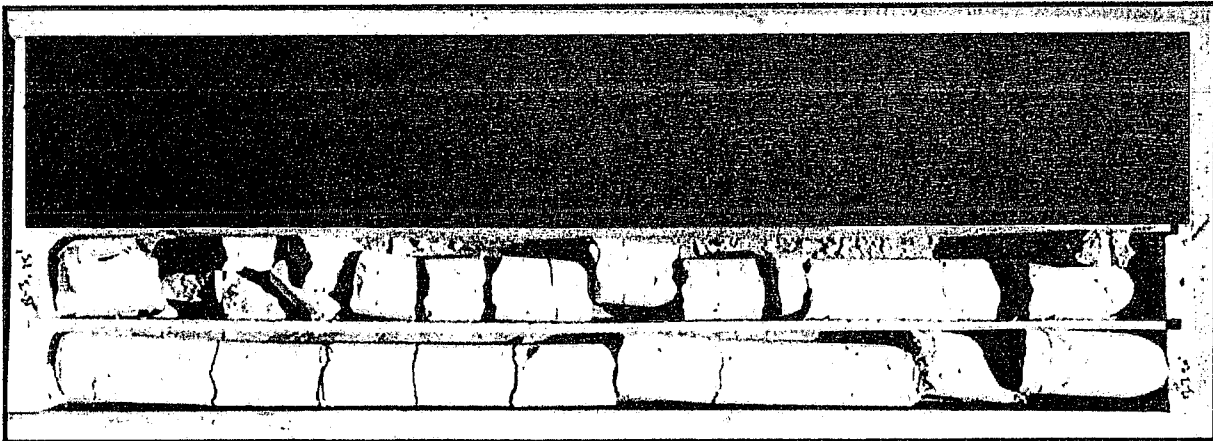

20'

B-3 (15' to 20')

MIDLAND STANDARD ENGINEERING & TESTING, INC.
INDIAN TRAIL ROAD OVER THE FOX RIVER
AURORA, IL
MSET FILE NO: 12316

2'

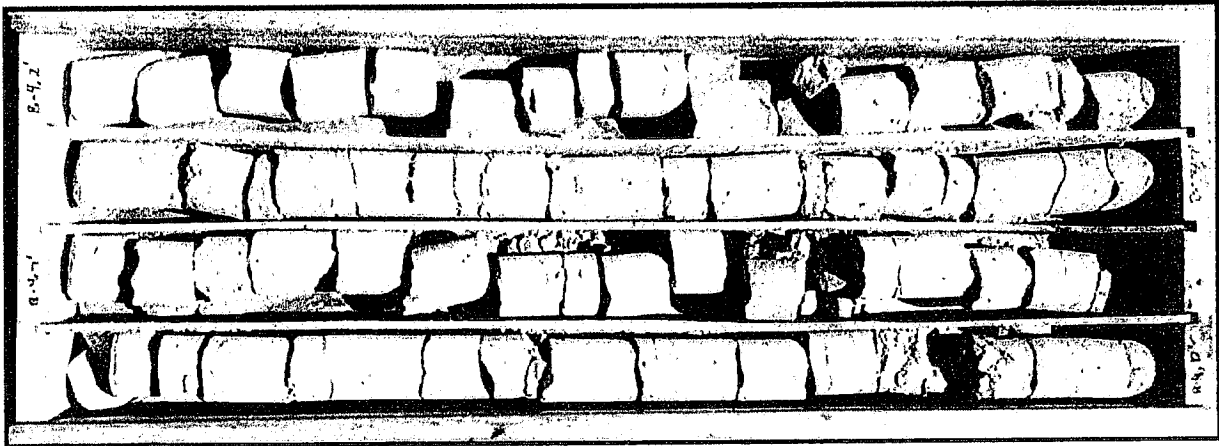

12'

B-4 (2' to 12')

12'



17'

B-4 (12' to 17')

MIDLAND STANDARD ENGINEERING & TESTING, INC.
INDIAN TRAIL ROAD OVER THE FOX RIVER
AURORA, IL
MSET FILE NO: 12316

5.5'



15.5'

B-5 (5.5' to 15.5')

15.5'



20.5'

B-5 (15.5' to 20.5')

MIDLAND STANDARD ENGINEERING & TESTING, INC.
INDIAN TRAIL ROAD OVER THE FOX RIVER
AURORA, IL
MSET FILE NO: 12316

32'



42'

B-6 (32' to 42')

42'

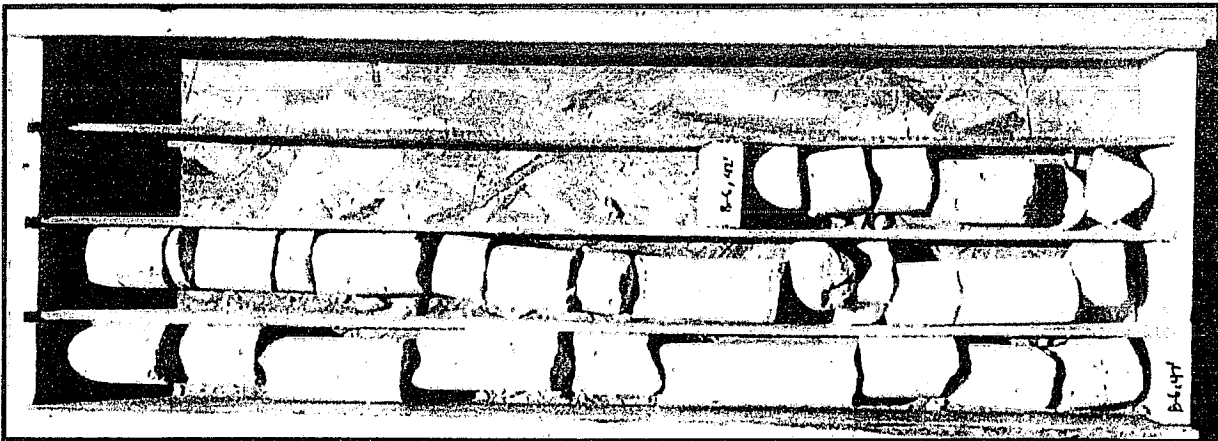

47'

B-6 (42' to 47')

MIDLAND STANDARD ENGINEERING & TESTING, INC.
INDIAN TRAIL ROAD OVER THE FOX RIVER
AURORA, IL
MSET FILE NO: 12316

27'

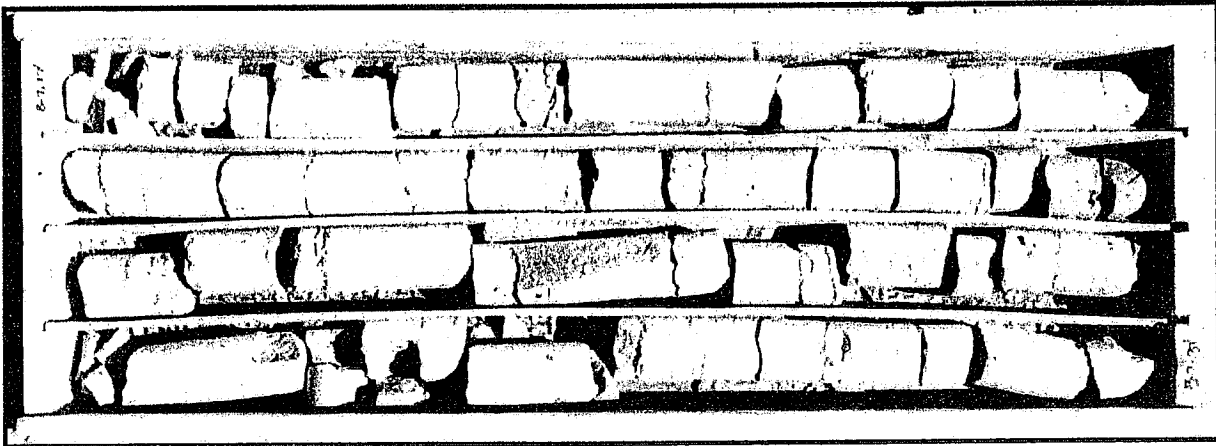

37'

B-7 (27' to 37')

37'

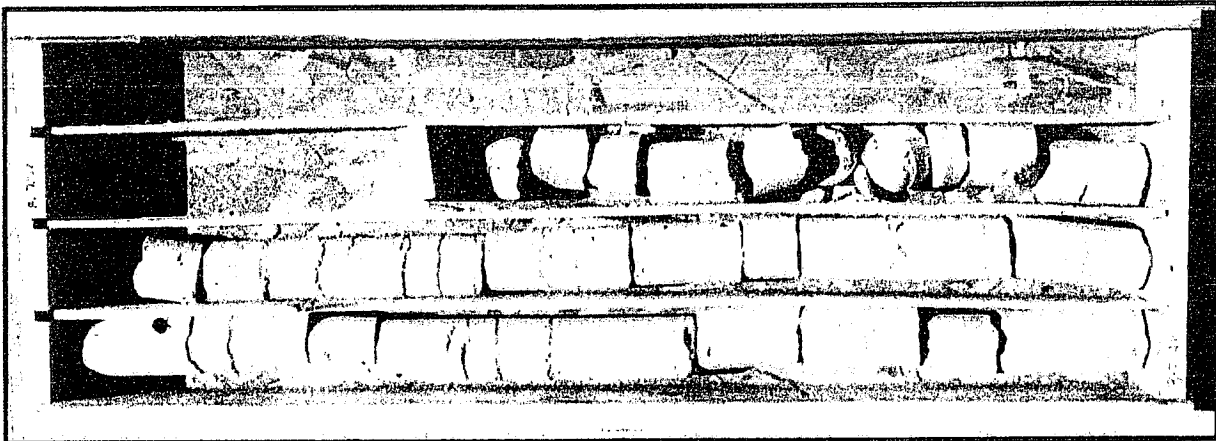

42'

B-7 (37' to 42')

MIDLAND STANDARD ENGINEERING & TESTING, INC.
INDIAN TRAIL ROAD OVER THE FOX RIVER
AURORA, IL
MSET FILE NO: 12316

28'

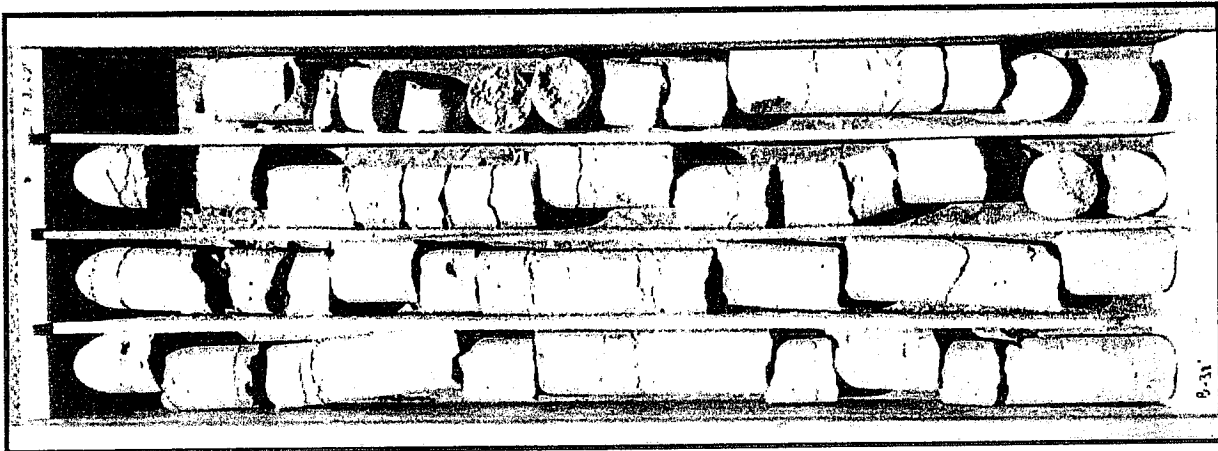

38'

B-8 (28' to 38')

38'

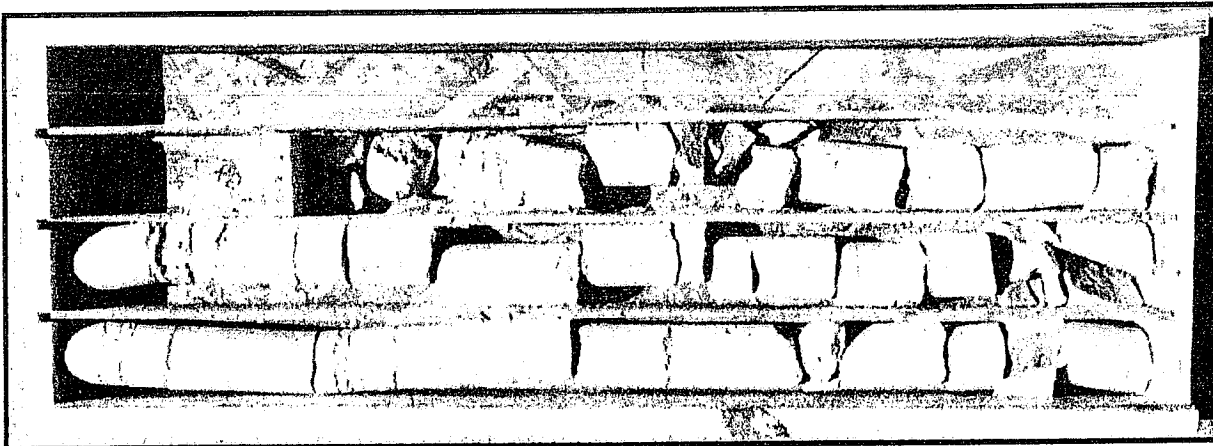

43'

B-8 (38' to 43')

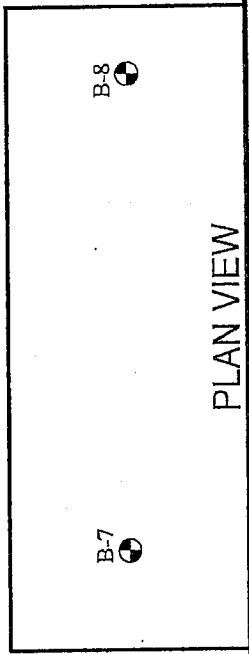
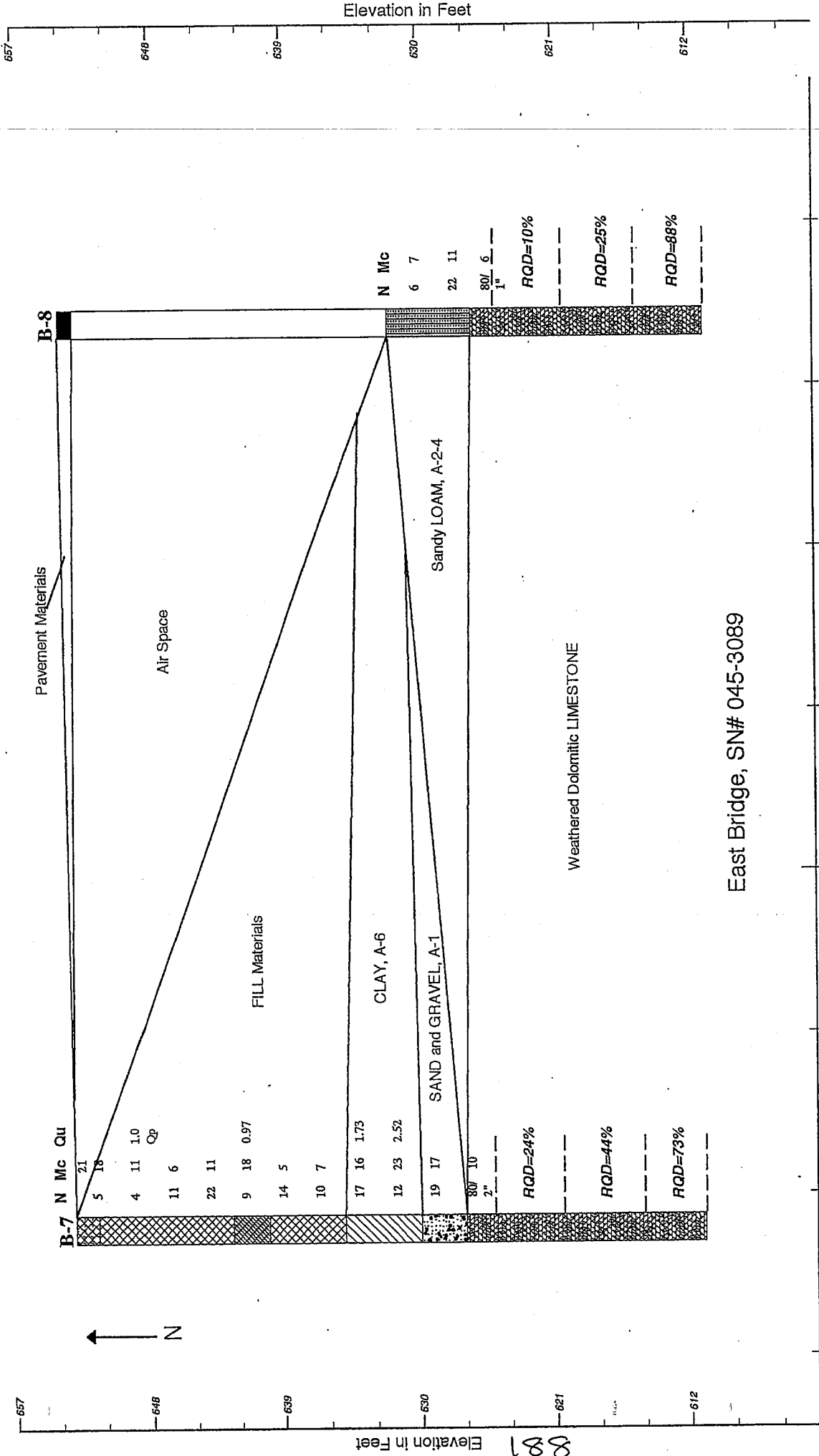

Midland Standard Engineering & Testing

SOIL BORING PROFILE

Indian Trail Road over the Fox River

PROJECT NO. 12316

DATE DRAWN
9/5/2012

881

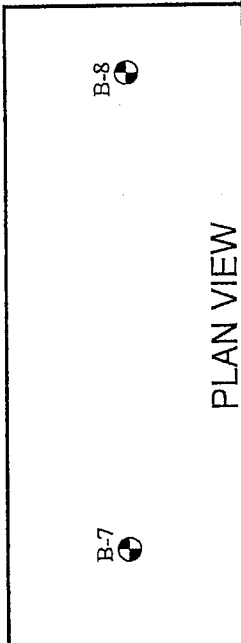
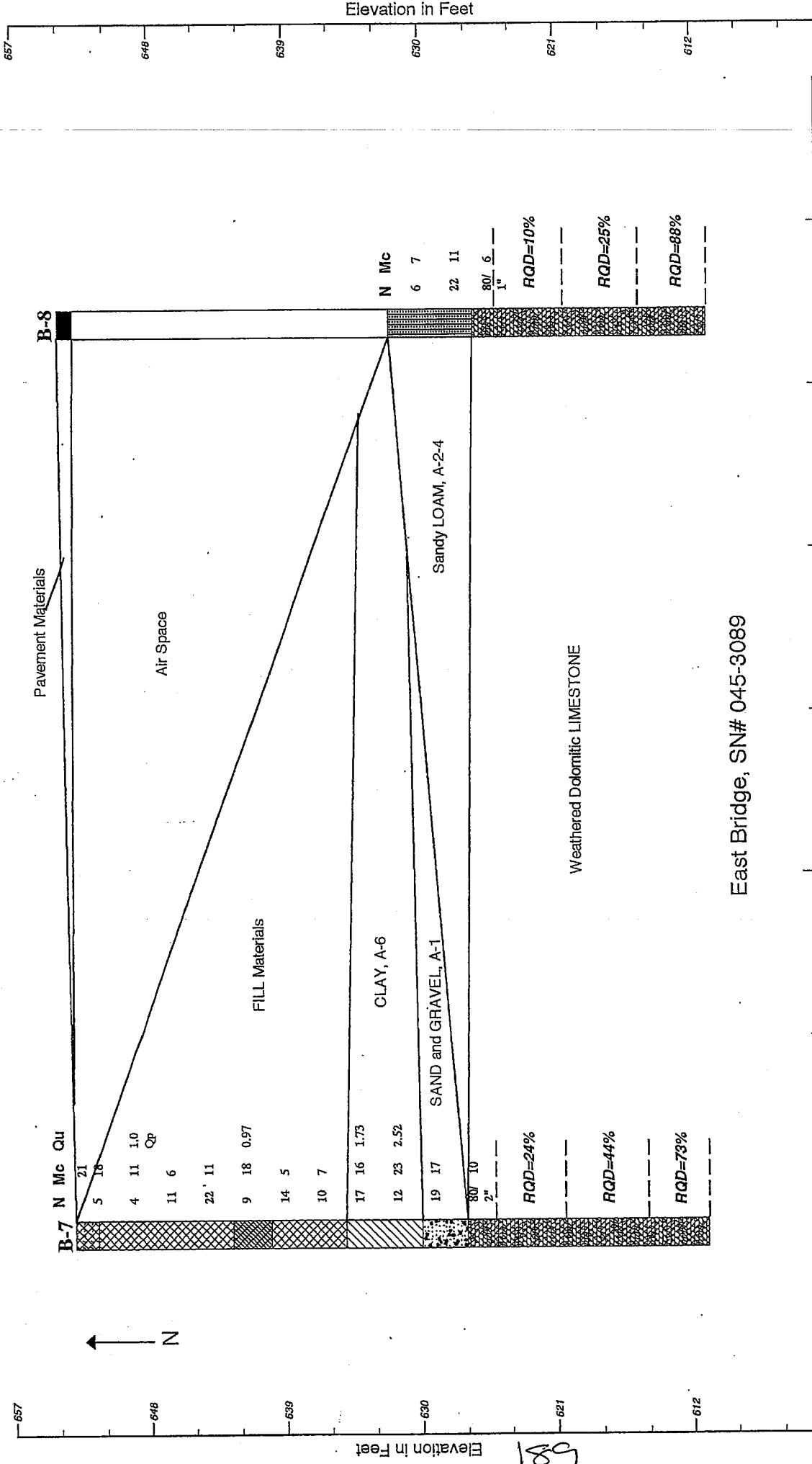

Midland Standard Engineering & Testing

SOIL BORING PROFILE

Indian Trail Road over the Fox River

PROJECT NO. 12316

DATE DRAWN 9/5/2012

681

**INDIAN TRAIL ROAD BRIDGE
AURORA, ILLINOIS**

Core No. C-1

Location		Depth (in.)		Thickness (in.)	Remarks/Condition
Sta. 90+85, 18' R of CL					
Material		Depth (in.)		Thickness (in.)	Remarks/Condition
Portland Cement Concrete	0	to 10- 3/4		10- 3/4	Fair to Good / Steel Rebar at 6-1/2"
Granular Base	10- 3/4	to 17		6- 1/4	Light Brown Crushed Limestone, CA-6
Subgrade	17	to 24			Brown CLAY, A-6

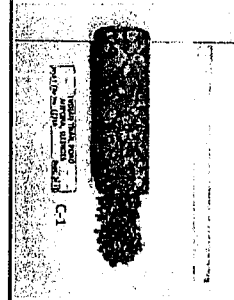

coeff	sn
0.50	5.38
0.11	<u>0.69</u>
	6.06

Core No. C-2

Location		Depth (in.)		Thickness (in.)	Remarks/Condition
Sta. 92+85, 18' R of CL					
Material		Depth (in.)		Thickness (in.)	Remarks/Condition
Portland Cement Concrete	0	to 11		11	Fair to Good / Steel Rebar at 5"
Granular Base	11	to 16		5	Light Brown Crushed Limestone, CA-6
Subgrade	16	to 24			Brown CLAY, A-6

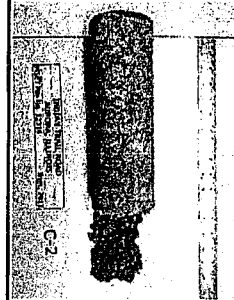

coeff	sn
0.50	5.50
0.11	<u>0.55</u>
	6.05

Core No. C-3

Location		Depth (in.)		Thickness (in.)	Remarks/Condition
Sta. 99+50, 18' R of CL					
Material		Depth (in.)		Thickness (in.)	Remarks/Condition
Bituminous Surface	0	to 1- 1/2		1- 1/2	Fair
Portland Cement Concrete	1- 1/2	to 12		10- 1/2	Fair to Good / Steel Rebar at 6"
Granular Base	12	to 19		7	Light Brown Crushed Limestone, CA-6
Subgrade	19	to 24			Brown CLAY, A-6

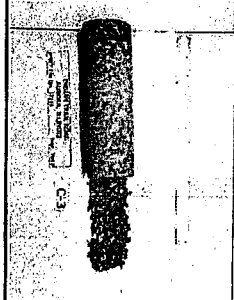

coeff	sn
0.30	0.45
0.50	5.25
0.11	<u>0.77</u>
	6.47

Core No. C-4

Location		Depth (in.)		Thickness (in.)	Remarks/Condition
Sta. 103+50, 18' R of CL					
Material		Depth (in.)		Thickness (in.)	Remarks/Condition
Bituminous Surface	0	to 1- 1/2		1- 1/2	Fair
Portland Cement Concrete	1- 1/2	to 12- 1/2		11	Fair to Good / Steel Rebar at 7-1/2"
Granular Base	12- 1/2	to 21- 1/2		9	Light Brown Crushed Limestone, CA-6
Subgrade	21- 1/2	to 24			Brown CLAY, A-6

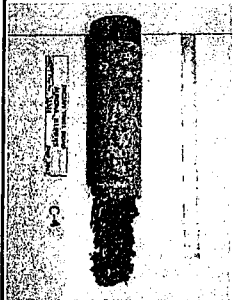

coeff	sn
0.30	0.45
0.50	5.50
0.11	<u>0.99</u>
	6.94

Indian Trail Road over the Fox River

Report created by ReSSA(2.0): Copyright (c) 2001-2007, ADAMA Engineering, Inc.

PROJECT IDENTIFICATION

Title: Indian Trail Road over the Fox River
 Project Number: 12316 -
 Client: HR Green, Inc.
 Designer: wjw
 Station Number: 93+31

Description:

Proposed Embankment Widening, Assumed Soil Strengths

Company's information:

Name: Midland Standard Engineering & Testing, Inc.
 Street: 558 Plate Drive, Unit 6
 East Dundee, IL 60118
 Telephone #: 847-844-1895
 Fax #:
 E-Mail: dundee@msetinc.com

Original file path and name: P:\ReSSA\Slope Stability Analysis\12316 IndianTrailoverFox.MSE
 Original date and time of creating this file: Thu Sep 13 13:07:46 2012

PROGRAM MODE: ANALYSIS of a Complex Slope using NO reinforcement material.

191

INPUT DATA (EXCLUDING REINFORCEMENT LAYOUT)

SOIL DATA

Soil Layer #:	Unit weight, γ [lb/ft ³]	Internal angle of friction, ϕ [deg.]	Cohesion, c [lb/ft ²]
.....1.....New Embankment Widening.....	130.0	24.0	250.0
.....2.....Existing Embankment.....	130.0	24.0	250.0
.....3.....Black CLAY with cinders and trash.....	120.0	18.0	200.0
.....4.....stiff to very stiff Grey CLAY, natural...	125.0	28.0	300.0
.....5.....Limestone Bedrock.....	140.0	50.0	1000.0

REINFORCEMENT

Analysis of slope WITHOUT reinforcement.

WATER

Water is not present

SEISMICITY

Not Applicable

DRAWING OF SPECIFIED GEOMETRY - COMPLEX - Quick Input

- Problem geometry is defined along sections selected by user at x,y coordinates.

-- X1,Y1 represents the coordinates of soil surface. X2,Y2 represent the coordinates of the end of soil layer 1 and start of soil layer 2, and so on.

GEOMETRY

Soil profile contains 5 layers (see details in next page)

UNIFORM SURCHARGE

Load Q1 = 250.00 [lb/ft²] inclined from vertical at 0.00 degrees, starts at X1s = 110.00 and ends at X1e = 160.00 [ft].

Surcharge load, Q2.....None

Surcharge load, Q3.....None

STRIP LOAD

.....None.....

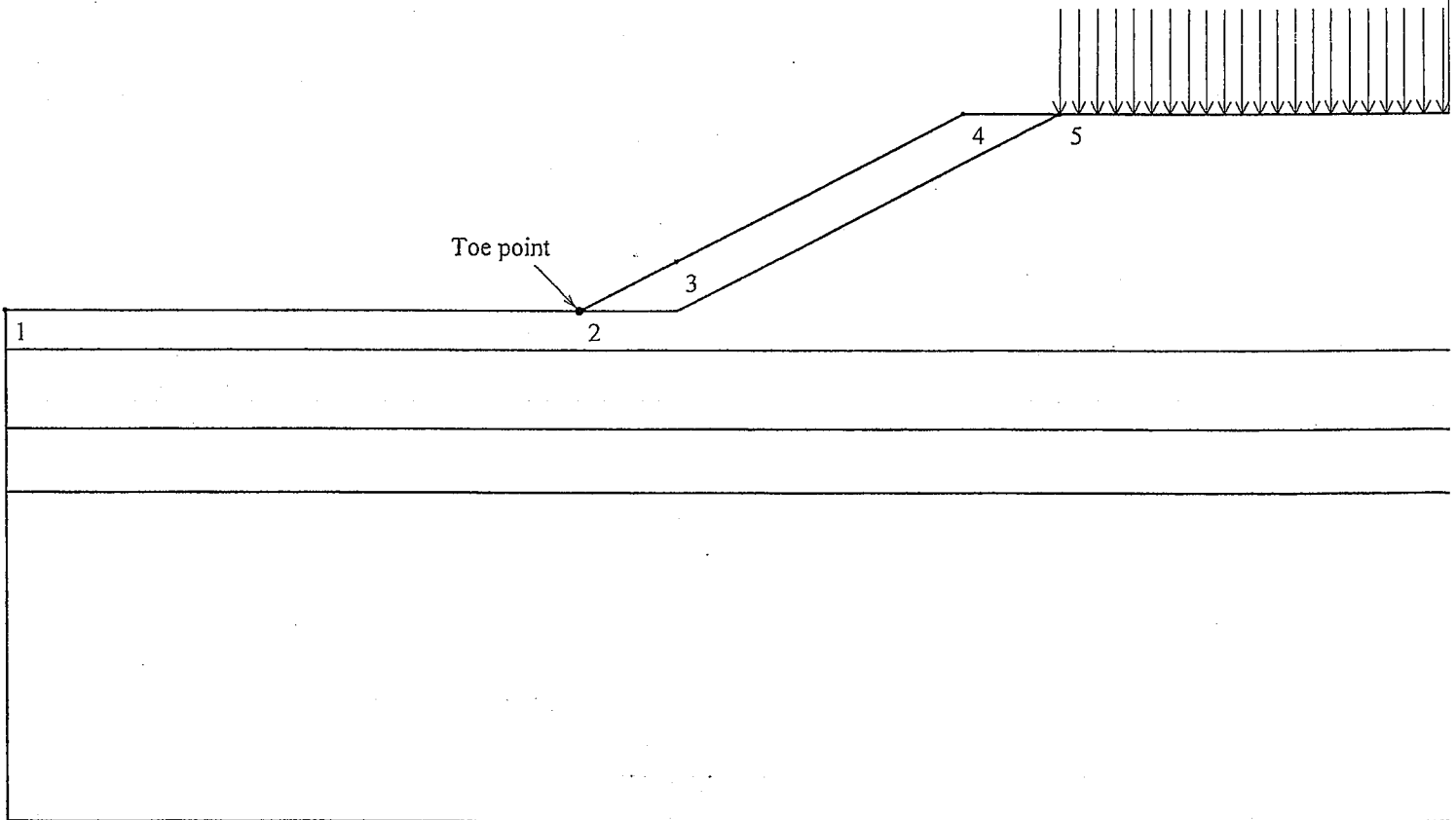

SCALE:

0 2 4 6 8 10 [ft]

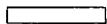

TABULATED DETAILS OF QUICK SPECIFIED GEOMETRY

oil profile contains 5 layers. Coordinates in [ft.]

	#	Xi	Yi
Top of Layer 1	1	0.00	652.00
	2	60.00	652.00
	3	100.00	672.00
	4	170.00	672.00
Top of Layer 2	5	0.00	652.00
	6	70.00	652.00
	7	110.00	672.00
	8	170.00	672.00
Top of Layer 3	9	0.00	648.00
	10	170.00	648.00
Top of Layer 4	11	0.00	640.00
	12	170.00	640.00
Top of Layer 5	13	0.00	633.50
	14	170.00	633.50

RESULTS OF ROTATIONAL STABILITY ANALYSIS

Results in the tables below represent critical circles identified between specified points on entry and exit. (Theta-exit set to 50.00 deg.)
 The most critical circle is obtained from a search considering all the combinations of input entry and exit points.

Critical circles for each entry point (considering all specified exit points)									
Entry Point #	Entry Point (X, Y) [ft]		Exit Point (X, Y) [ft]		Critical Circle (Xc, Yc, R) [ft]			Fs	STATUS
1	99.50	671.75	54.55	652.34	71.76	674.24	27.85	2.03	
2	104.65	672.00	48.75	652.37	70.17	680.79	35.59	1.93	
3	109.80	672.00	48.75	652.35	71.79	685.42	40.31	1.90	
4	114.95	672.00	48.88	652.24	73.69	689.63	44.87	1.88	OK
5	120.10	672.00	49.01	652.15	75.60	694.16	49.72	1.90	
6	125.25	672.00	43.19	652.20	74.97	700.46	57.78	1.94	
7	130.40	672.00	43.26	652.15	76.94	705.51	63.10	1.99	
8	135.55	672.00	43.47	652.02	79.26	709.23	67.49	2.06	
9	140.70	672.00	37.17	652.36	78.50	717.21	76.90	2.12	
10	145.85	672.00	37.19	652.34	80.49	723.13	82.98	2.20	
11	151.00	672.00	37.20	652.32	82.46	729.45	89.43	2.28	

Note: In the 'Status' column, OK means the critical circle was identified within the specified search domain. 'On extreme X-entry' means that the critical result is on the edge of the search domain; a lower Fs may result if the search domain is expanded.

Results in the tables below represent critical circles identified between specified points on entry and exit. (Theta-exit set to 50.00 deg.)
 The most critical circle is obtained from a search considering all the combinations of input entry and exit points.

Critical circles for each exit point (considering all specified entry points)									
Exit Point #	Exit Point (X, Y) [ft]		Entry Point (X, Y) [ft]		Critical Circle (Xc, Yc, R) [ft]			Fs	STATUS
1	8.38	652.33	130.40	672.00	56.60	741.52	101.39	2.33	
2	14.12	652.37	125.25	672.00	58.19	727.24	86.88	2.23	
3	19.98	652.33	125.25	672.00	62.08	718.54	78.47	2.14	
4	25.68	652.37	125.25	672.00	65.55	712.51	72.15	2.06	
5	31.22	652.53	120.10	672.00	66.66	703.38	61.98	1.99	
6	37.59	652.11	120.10	672.00	69.81	699.53	57.33	1.94	
7	42.89	652.42	114.95	672.00	70.73	692.37	48.69	1.90	
8	48.88	652.24	114.95	672.00	73.69	689.63	44.87	1.88	OK
9	54.43	652.37	114.95	672.00	76.72	686.76	40.98	1.91	
10	60.35	652.47	104.65	672.00	69.72	691.23	39.88	2.00	
11	66.07	655.37	104.65	672.00	75.12	687.43	33.32	2.14	

Note: In the 'Status' column, OK means the critical circle was identified within the specified search domain. 'On extreme X-exit' means that the critical result is on the edge of the search domain; a lower Fs may result if the search domain is expanded.

RESULTS OF 3-PART WEDGE ANALYSIS

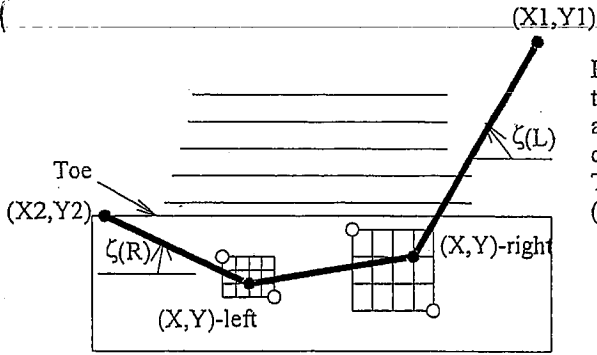

Results in the table below represent the critical slip surface composed of a three-part wedge and identified by the specified points (X-left, Y-left) and (X-right, Y-right) and angles Zeta(L) and Zeta(R). ReSSA finds the (X,Y) coordinates, as well as the angles Zeta, based on user-specified search domain. The trace of the critical three-part wedge is fully defined by four points: (X1, Y1), (X-left, Y-left), (X-right, Y-right), (X2, Y2).

Critical 3-part wedge (Automatic search):						
(X2, Y2) [ft]	Zeta(L) [degrees]	(X-left, Y-left) [ft]	(X-right, Y-right) [ft]	Zeta(R) [degrees]	(X1, Y1) [ft]	Fs
(47.45, 652.00)	25.00	(66.75, 643.00)	(94.00, 649.17)	40.00	(121.21, 672.00)	1.946

CRITICAL RESULTS OF ROTATIONAL AND TRANSLATIONAL STABILITY ANALYSES

Rotational (Circular Arc; Bishop) Stability Analysis

Minimum Factor of Safety = 1.88

Critical Circle: Xc = 73.69[ft], Yc = 689.63[ft], R = 44.87[ft]. (Number of slices used = 55)

Translational (2-Part Wedge; Spencer), Direct Sliding, Stability Analysis

NOT CONDUCTED

Three-Part Wedge Stability Analysis

Minimum Factor of Safety = 1.95

Critical Three-Part Wedge: (X2 = 47.45, Y2 = 652.00) [ft]
(X-left = 66.75, Y-left = 643.00) [ft]
(X-right = 94.00, Y-right = 649.17) [ft]
(X1 = 121.21, Y1 = 672.00) [ft]
(Number of slices used = 45)
Interslice resultant force inclination = 13.64 [degrees]

REINFORCEMENT LAYOUT: DRAWING

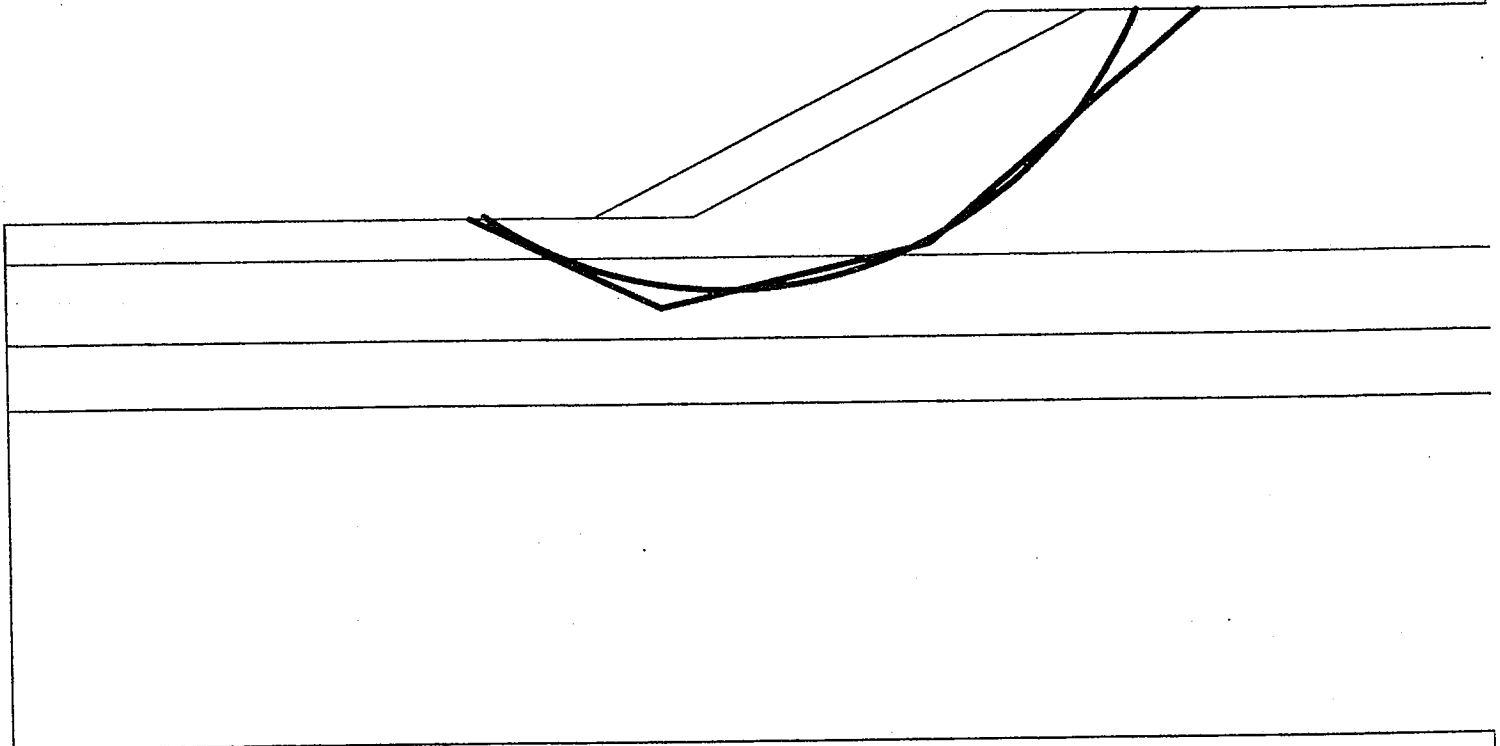

SCALE:

0 2 4 6 8 10[ft]

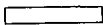

GENERAL NOTES

PARTICLE SIZE DESCRIPTION & TERMINOLOGY

Coarse Grained or Granular Soils have more than 50% of their dry weight retained on a #200 sieve; they are described as: boulders, cobbles, gravel or sand. Fine Grained soils have less than 50% of their dry weight retained on a #200 sieve; they are described as: clays or clayey silts if they are cohesive and silts if they are non-cohesive. In addition to gradation, granular soils are defined on the basis of their relative in-place density and the fine grained soils on the basis of their strength or consistency and their plasticity.

Major Component of Sample	Size Range	Descriptive Term of Components Also Present in Sample	Approximate Quantity (Percent)
Boulders	Over 8 in. (200 mm)		
Cobbles	8 inches to 3 inches (200 mm to 75mm)	Trace	1 - 9
Gravel	3 inches to #4 sieve (75mm to 4.75mm)	Little	10 - 19
Sand	#4 to #200 sieve (4.75mm to 75mm)	Some	20 - 34
Silt	Passing #200 sieve (75mm to 2mm)	And	35 - 50
Clay	Smaller than 2mm		

RELATIVE DENSITY AND CONSISTENCY CLASSIFICATION

GRANULAR SOILS

DENSITY CLASSIFICATION	APPROXIMATE RANGE OF N *
Very Loose	0 - 3
Slightly Dense	4 - 9
Medium Dense	10 - 29
Dense	30 - 49
Very Dense	50 - 80
Extremely Dense	80 +

COHESIVE SOILS

CONSISTENCY	UNCONFINED COMPRESSIVE STRENGTH, Qu - TSF	APPROXIMATE RANGE OF N *
Very Soft	0.25	0 - 2
Soft	0.25 - 0.49	3 - 4
Firm	0.50 - 0.99	5 - 8
Stiff	1.00 - 1.99	9 - 15
Very Stiff	2.00 - 3.99	16 - 30
Hard	4.00 - 8.00	31 - 50
Very Hard	8.00 +	Over 50

* STANDARD PENETRATION TEST (ASTM D1586) - A 2.0" outside-diameter, split barrel sampler is driven into undisturbed soil by means of a 140 pound weight falling freely through a vertical distance of 30 inches. The sampler is normally driven 3 successive 6 inch increments. The total number of blows required for the final 12 inches of penetration is the Standard Penetration Resistance (N).

AURORA TOWNSHIP ROAD DISTRICT KANE COUNTY ILLINOIS

PLANS FOR PROPOSED INDIAN TRAIL STRUCTURES

PLAN 1 INCH = 50 FEET (ROADWAY)
 PROFILE HORIZ. 1 INCH = 50 FEET
 PROFILE VERT. 1 INCH = 5 FEET
 CROSS SECTIONS 1 INCH = 5 FEET (ROADWAY)
 STRUCTURE PLANS AS NOTED

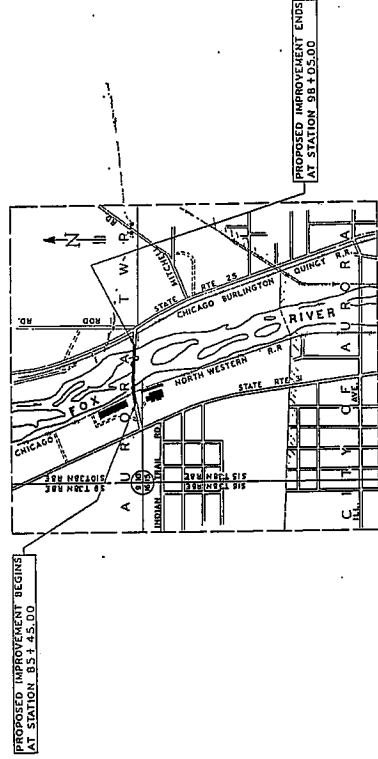

SCALE: 1" = 1000'
 INDIAN TRAIL
 GROSS LENGTH 1,260 LIN. FT.
 NET LENGTH 1,260 LIN. FT. - 0.239 MILE

VOGT, IVERS & ASSOCIATES
 ENGINEERS - ARCHITECTS
 CHICAGO, ILL. - CINCINNATI, OHIO

SUBMITTED	AURORA TOWNSHIP ROAD DISTRICT	DECEMBER 1, 1961
EXAMINED	VOGT, IVERS & ASSOCIATES	DECEMBER 1, 1961
APPROVED	AURORA TOWNSHIP HIGHWAY COMMISSIONER	DECEMBER 1, 1961

INDEX OF SHEETS

SHEET NO.	TITLE SHEET
1	SUMMARY OF QUANTITIES
2	GENERAL NOTES
3	TYPICAL CROSS SECTIONS
4	ROADWAY PLAN & PROFILE
5-12	DETAILS
13	CROSS SECTIONS, INDIAN TRAIL ROAD
14	GENERAL PLAN, ELEVATION & PROFILE
15	BORINGS
16	ABUTMENT 1
17	ABUTMENT 2
18	ABUTMENT 3
19	ABUTMENT 4
20	PIERS 1 & 3
21	PIER 2
22	PIER 4
23	PIERS 5 & 6
24	PIER 7
25	PIER 8
26	FRAMING PLAN - SPANS 1, 2, 3, & 4
27	STEEL DETAILS - SPANS 1, 2, 3, & 4
28	FRAMING PLAN - SPANS 5, 6 & 7
29	FRAMING PLAN - SPANS 8, 9, & 10
30	EXPANSION DEVICES - ABUTMENT 1 & PIER 4
31	EXPANSION DEVICES - ABUTMENTS 2, 3, & 4
32	BEARING DEVICES & MISCELLANEOUS DETAILS
33	FLOOR SLAB - SPANS 1, 2, 3, & 4
34	FLOOR SLAB - SPANS 5, 6, & 7
35	FLOOR SLAB ELEVATIONS - SPANS 1, 2, 3, & 4
36	FLOOR SLAB ELEVATIONS - SPANS 8, 9, & 10
37	FLOOR SLAB ELEVATIONS - SPANS 5, 6, & 7 - 8, 9, & 10
38	APPROACH SLABS
39	REINFORCEMENT BAR LIST
40	LIGHTING DETAILS
	DETAILS OF REINFORCED CONCRETE HEADWALLS FOR 42" DIA. PIPE
	STANDARD SYMBOLS

— SUMMARY OF QUANTITIES —

STRUCTURES	PAY ITEM	UNIT	QUANTITY
1. CLASS A EXCAVATION FOR STRUCTURES		C.Y.	350
2. CLASS B EXCAVATION FOR STRUCTURES		C.Y.	59550
3. ROCK EXCAVATION FOR STRUCTURES		C.Y.	11000
4. PILOT HOLES		C.Y.	350
5. SETTING PILES IN ROCK		TON	150
6. FURNISHING STEEL PILES		S.V.	533
7. DRIVING STEEL PILES		C.Y.	6.9
8. TEST PILES		LBS	471
9. CLASS A CONCRETE		C.Y.	70
10. CLASS X CONCRETE		L.F.	140
11. HANDRAIL CONCRETE		L.F.	142
12. REINFORCEMENT BARS		LBS	200
13. FURNISHING & ERECTING STRUCTURAL STEEL		S.V.	230
14. ALUMINUM AGGREGATE SLOPE PROTECTION		L.S.	2
15. PROVISIONS FOR FUTURE LIGHTING			
17. NAME PLATE			
18. INSTALLATION OF BELL TELEPHONE CO. CONDUITS			

ROADWAY

1. CLEARING & GRUBBING		L.S.	350
2. EARTH EXCAVATION		C.Y.	59550
3. BORROW EXCAVATION		C.Y.	11000
4. SPECIAL EXCAVATION		C.Y.	350
5. POROUS GRANULAR EMBANKMENT		TON	150
6. SUB-BASE GRANULAR MATERIAL, TYPE A		S.V.	533
7. PORTLAND CEMENT CONCRETE PAVEMENT, 12"		C.Y.	6.9
8. CLASS X CONCRETE		LBS	471
9. REINFORCEMENT BARS		C.Y.	70
10. GRANULAR BACKFILL AT PIPE CULVERTS		L.F.	140
11. BITUMINOUS COATED CORRUGATED METAL PIPE, 12"		L.F.	142
12. BITUMINOUS COATED CORRUGATED METAL PIPE, 42" 12 GA.			
13. CONCRETE CURB			
14. PAVED BERGTH TRACKS			
15. CONSTRUCTION SIGNS			

— GENERAL NOTES —

1. THE UTILITIES & EXISTING DRAINAGE FACILITIES DEPICTED ON THE PLANS ARE SHOWN FOR INFORMATIONAL PURPOSES ONLY & THEIR EXACT SIZE, LOCATION AND DEPTH ARE TO BE DETERMINED BY THE CONTRACTOR. THE CONTRACTOR SHALL EXERCISE DUE CARE IN THE CONSTRUCTION TO PROTECT THE EXISTING INSTALLATIONS AS SHOWN & ANY OTHER WHICH MAY BE ENCOUNTERED. ANY DAMAGE DONE THERE TO SHALL BE REPAIRED AT HIS OWN EXPENSE.
2. WHEN EXISTING DRAINAGE INSTALLATIONS ARE DISTURBED, THE CONTRACTOR, AT HIS OWN EXPENSE, SHALL PROVIDE & MAINTAIN TEMPORARY OUTLETS & CONNECTIONS FOR ALL SUCH FACILITIES.
3. THE CONTRACTOR WILL BE REQUIRED TO MAINTAIN ACCESS TO THE JOBSITE & AREA THEREABOUTS THROUGH THE USE OF THE EXISTING DRIVEWAYS OR TEMPORARY CONNECTION THERE TO.

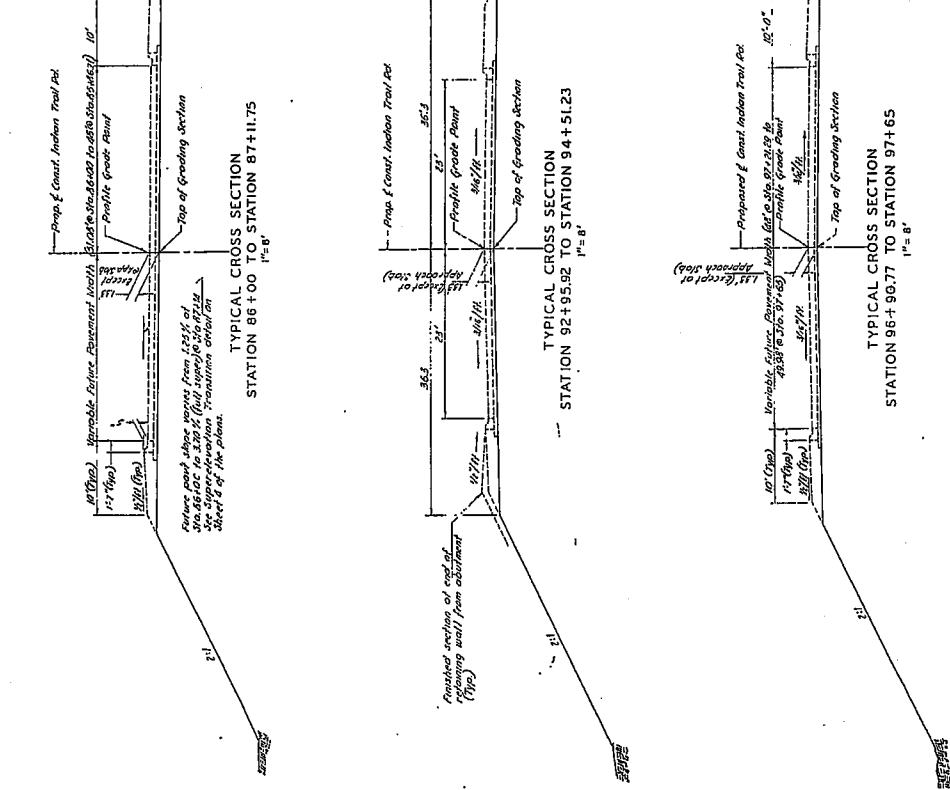

Branch Mark = 1. Top of existing property marker east side Illinois Avenue, Sta. 65+00
 Elevation 668.23
 Branch Mark = 2. Top of concrete B.M. marker east side Illinois Avenue, Sta. 65+00
 Elevation 670.82
 Branch Mark = 3. Top of concrete B.M. marker east side Illinois Avenue, Sta. 65+00
 Elevation 670.82

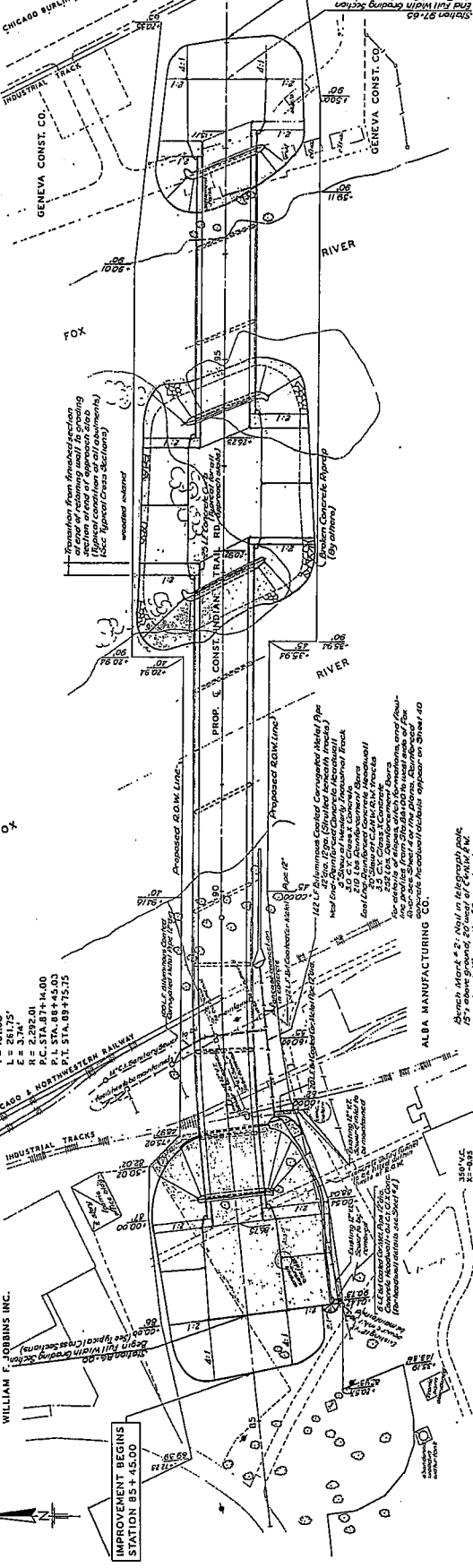

CURVE DATA
 Δ = 6° 32' 38"
 T = 81.00
 L = 261.75
 E = 261.75
 R = 261.75
 P.L. STA. 68+45.00
 P.T. STA. 69+75.75

LEGEND
 SPECIAL EXCAVATION
 ESTIMATED LIMITS

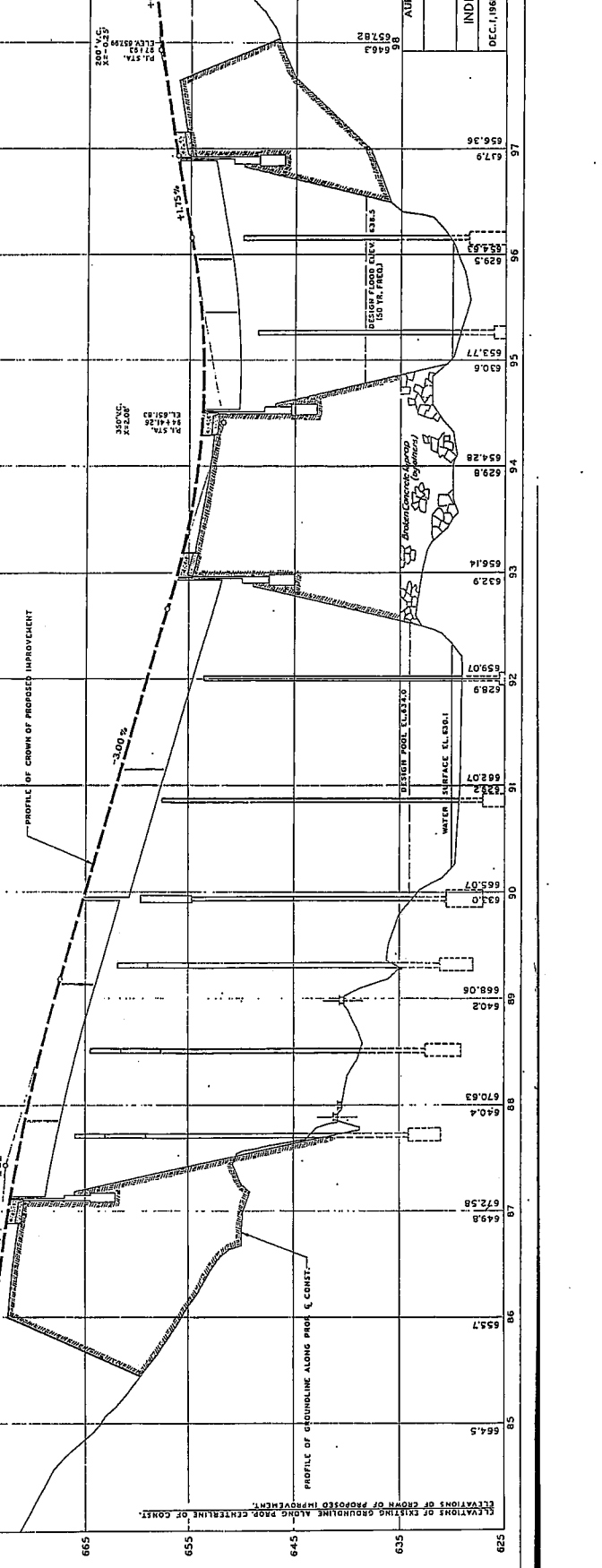

ELEVATIONS OF EXISTING GROUND SURFACE ALONG PROPOSED CENTERLINE OF CONST.
 ELEVATIONS OF CROWN OF PROPOSED IMPROVEMENT
 PROFILE OF GROUND SURFACE
 PROFILE OF CROWN OF PROPOSED IMPROVEMENT

AURORA TOWNSHIP ROAD DISTRICT
 RANK COUNTY, ILLINOIS
 INDIAN TRAIL BRIDGES
 FOX RIVER
 INDIAN TRAIL PLAN & PROFILE
 VOGT, IVERS & ASSOC.
 ENGINEERS - ARCHITECTS
 DEC. 1, 1966
 CHICAGO

202

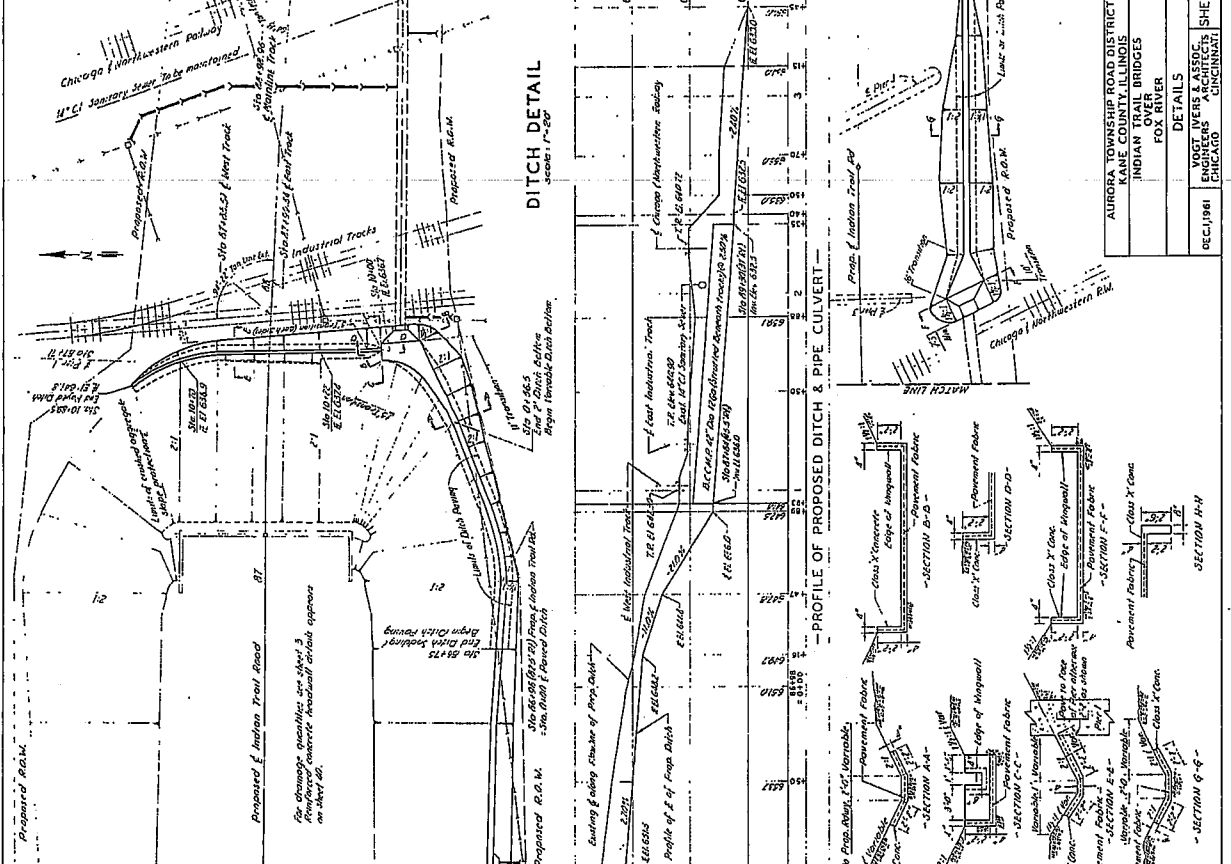

INDIAN TRAIL STRUCTURES
 AURORA TWP. ROAD DIST.
 CARL M. SCHWARTZ
 HIGHWAY COMMISSIONER
 VOGT, IVERS & ASSOC.
 CONSULTING ENGRS.
 1962

Material: Best quality steel or bridge
 steel reinforcement. Top surface painted
 with zinc chromate primer.
 NOTE: Name plate to be installed at location as directed by
 Engineer's plan. To be bolted to aluminum horizontal with
 1/2" diameter bolts. Name plate to be installed in place
 with walls of horizontal and security lighted in place.

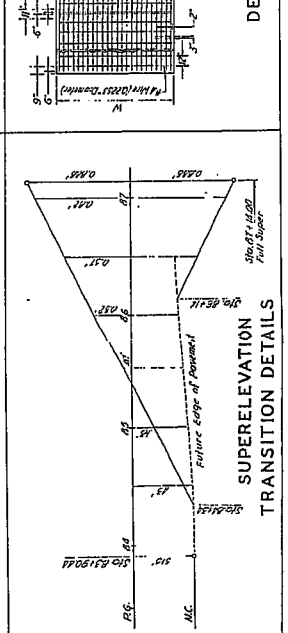
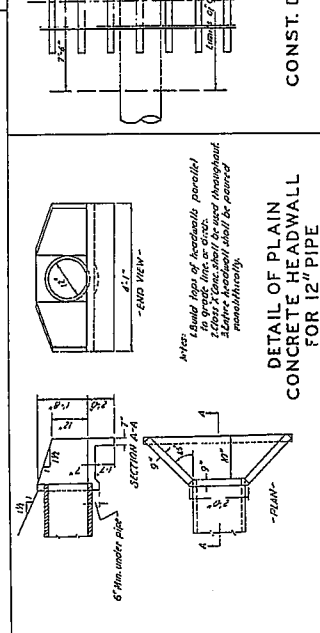
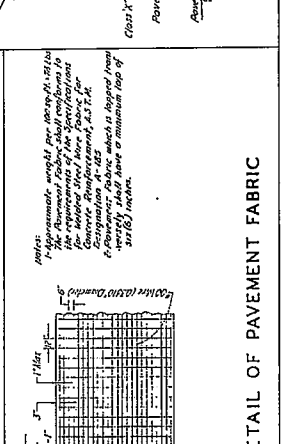
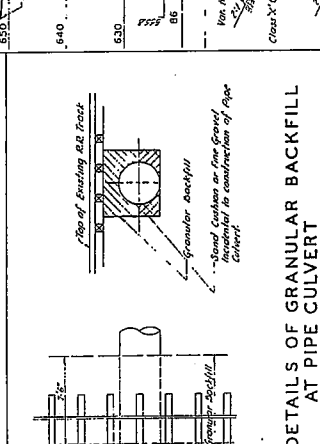
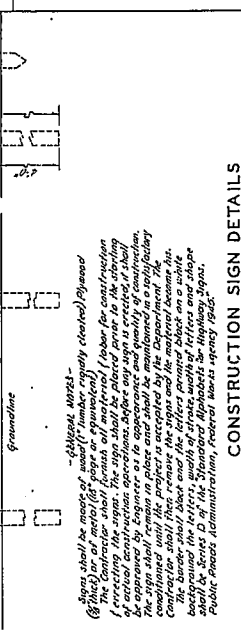
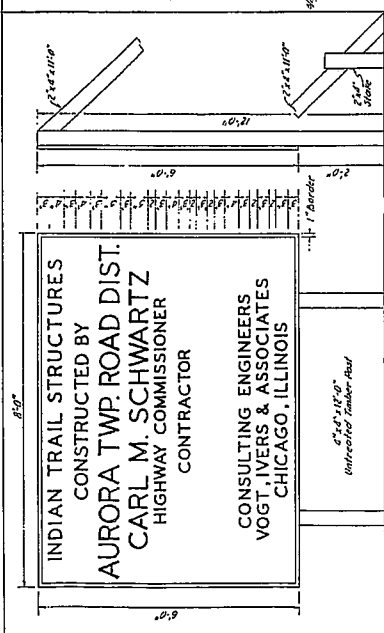
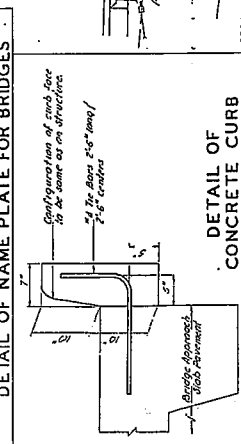

INDIAN TRAIL STRUCTURES
 AURORA TWP. ROAD DIST.
 CARL M. SCHWARTZ
 HIGHWAY COMMISSIONER
 VOGT, IVERS & ASSOC.
 CONSULTING ENGRS.
 1962

CONSULTING ENGINEERS
 VOGT, IVERS & ASSOCIATES
 CHICAGO, ILLINOIS

DETAILS
 DETAILS
 VOGT, IVERS & ASSOC.
 ENGINEERS - ARCHITECTS
 INDIAN TRAIL BRIDGES
 FOX RIVER
 CHICAGO
 DEC. 1961

AURORA TOWNSHIP ROAD DISTRICT
 KANE COUNTY, ILLINOIS
 INDIAN TRAIL BRIDGES
 FOX RIVER

SHEET
 SHEET
 SHEET

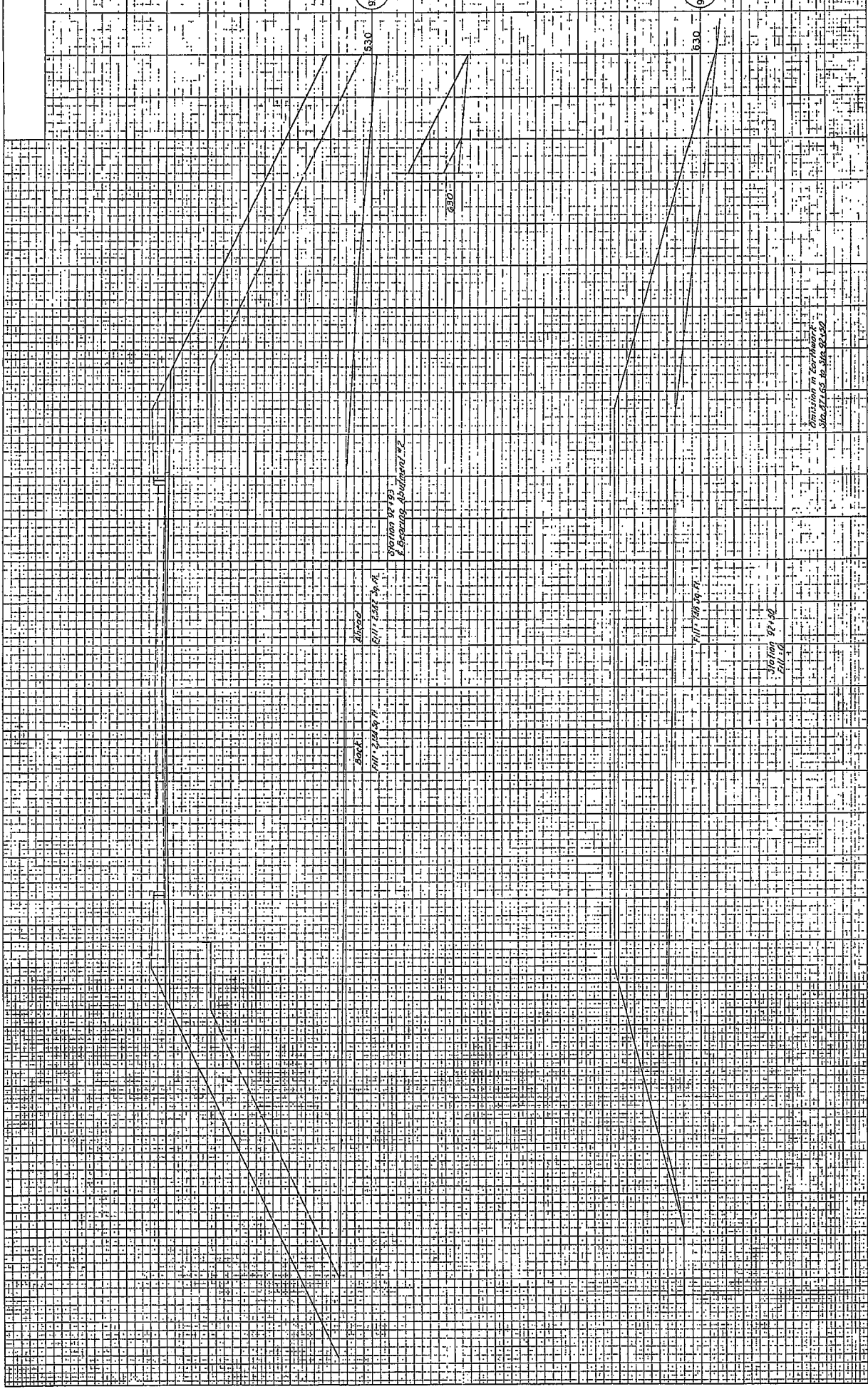

NO.	DATE
BY	SCALE
CHECKED	PROJECT
APPROVED	DATE
REVISIONS	
BY	DATE
BY	DATE
BY	DATE

202

NO.	DATE
BY	SCALE
CHECKED	PROJECT
APPROVED	DATE
REVISIONS	
BY	DATE
BY	DATE
BY	DATE

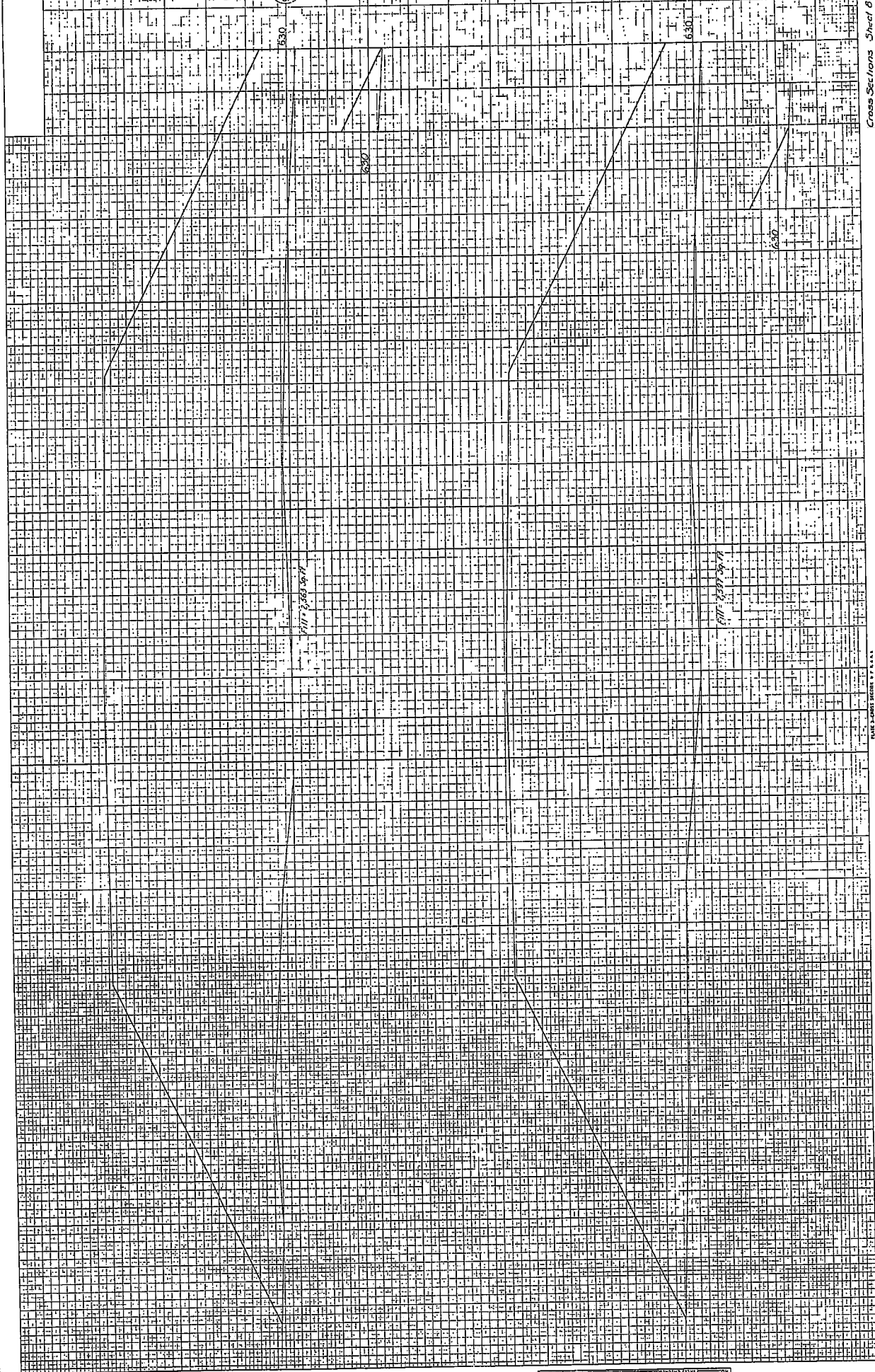

MADE IN THE U.S.A. BY

NO.	DATE
PROJECT	
DATE	
BY	
CHECKED	
SCALE	
DATE	
BY	
CHECKED	
SCALE	
DATE	
BY	
CHECKED	
SCALE	
DATE	
BY	

S02

NO.	DATE
PROJECT	
DATE	
BY	
CHECKED	
SCALE	
DATE	
BY	
CHECKED	
SCALE	
DATE	
BY	
CHECKED	
SCALE	
DATE	
BY	

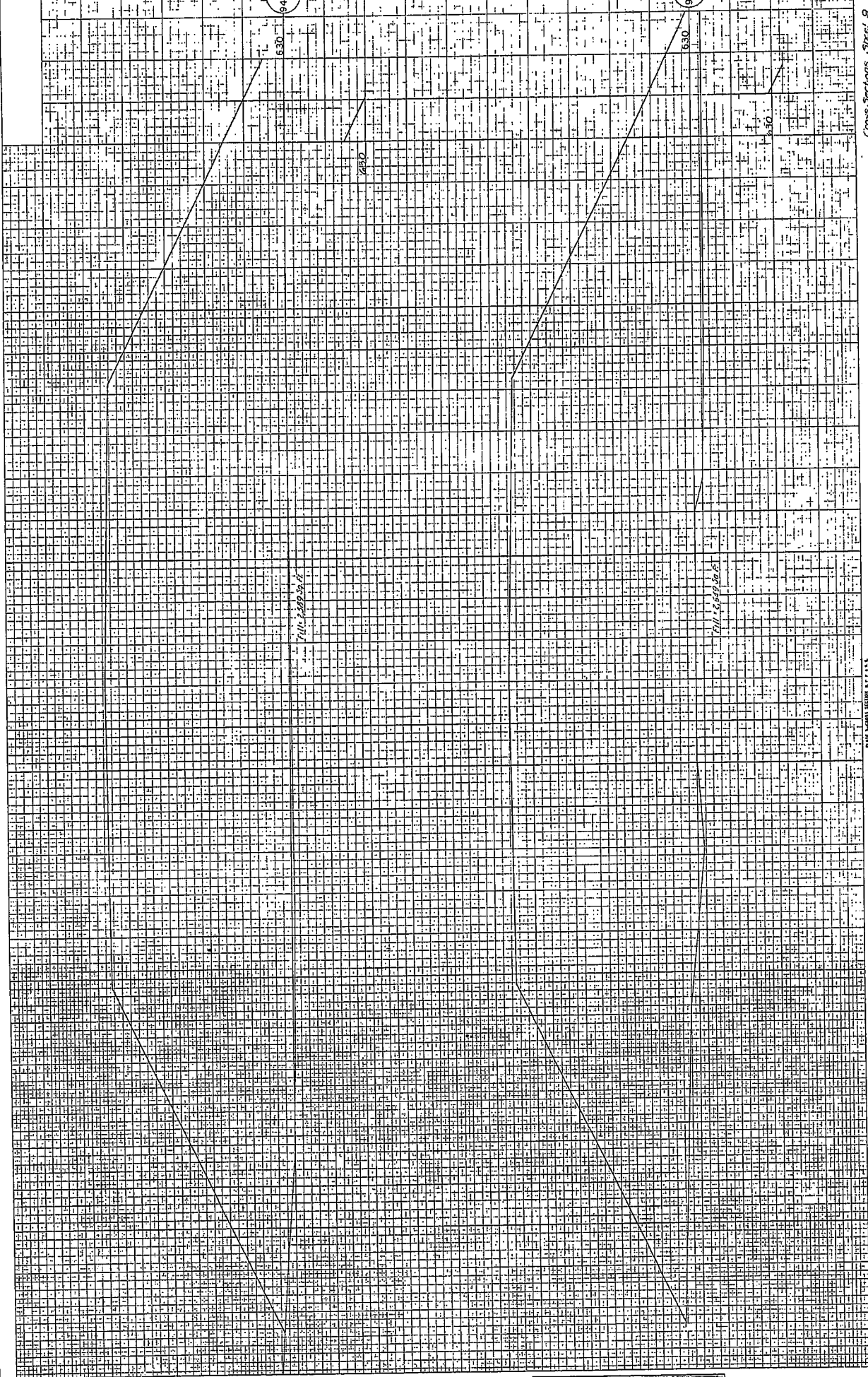

NO.	DATE
BY	DATE
CHECKED	DATE
APPROVED	DATE
DESIGNED	DATE
DRAWN	DATE
SCALE	

204

NO.	DATE
BY	DATE
CHECKED	DATE
APPROVED	DATE
DESIGNED	DATE
DRAWN	DATE
SCALE	

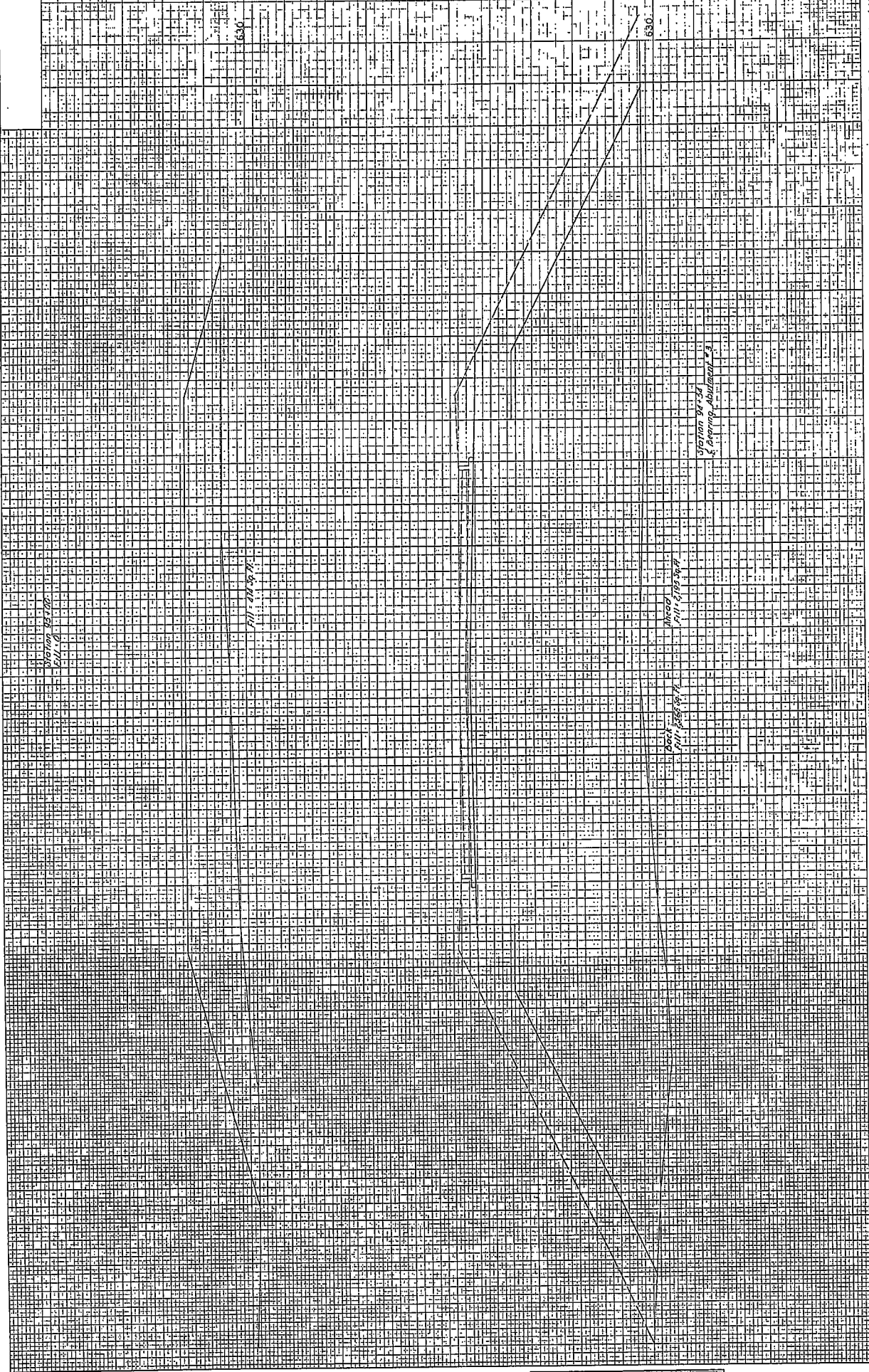

NO.	DATE
1	
2	
3	
4	
5	
6	
7	
8	
9	
10	
11	
12	
13	
14	
15	
16	
17	
18	
19	
20	
21	
22	
23	
24	
25	
26	
27	
28	
29	
30	
31	
32	
33	
34	
35	
36	
37	
38	
39	
40	
41	
42	
43	
44	
45	
46	
47	
48	
49	
50	
51	
52	
53	
54	
55	
56	
57	
58	
59	
60	
61	
62	
63	
64	
65	
66	
67	
68	
69	
70	
71	
72	
73	
74	
75	
76	
77	
78	
79	
80	
81	
82	
83	
84	
85	
86	
87	
88	
89	
90	
91	
92	
93	
94	
95	
96	
97	
98	
99	
100	

202

NO.	DATE
1	
2	
3	
4	
5	
6	
7	
8	
9	
10	
11	
12	
13	
14	
15	
16	
17	
18	
19	
20	
21	
22	
23	
24	
25	
26	
27	
28	
29	
30	
31	
32	
33	
34	
35	
36	
37	
38	
39	
40	
41	
42	
43	
44	
45	
46	
47	
48	
49	
50	
51	
52	
53	
54	
55	
56	
57	
58	
59	
60	
61	
62	
63	
64	
65	
66	
67	
68	
69	
70	
71	
72	
73	
74	
75	
76	
77	
78	
79	
80	
81	
82	
83	
84	
85	
86	
87	
88	
89	
90	
91	
92	
93	
94	
95	
96	
97	
98	
99	
100	

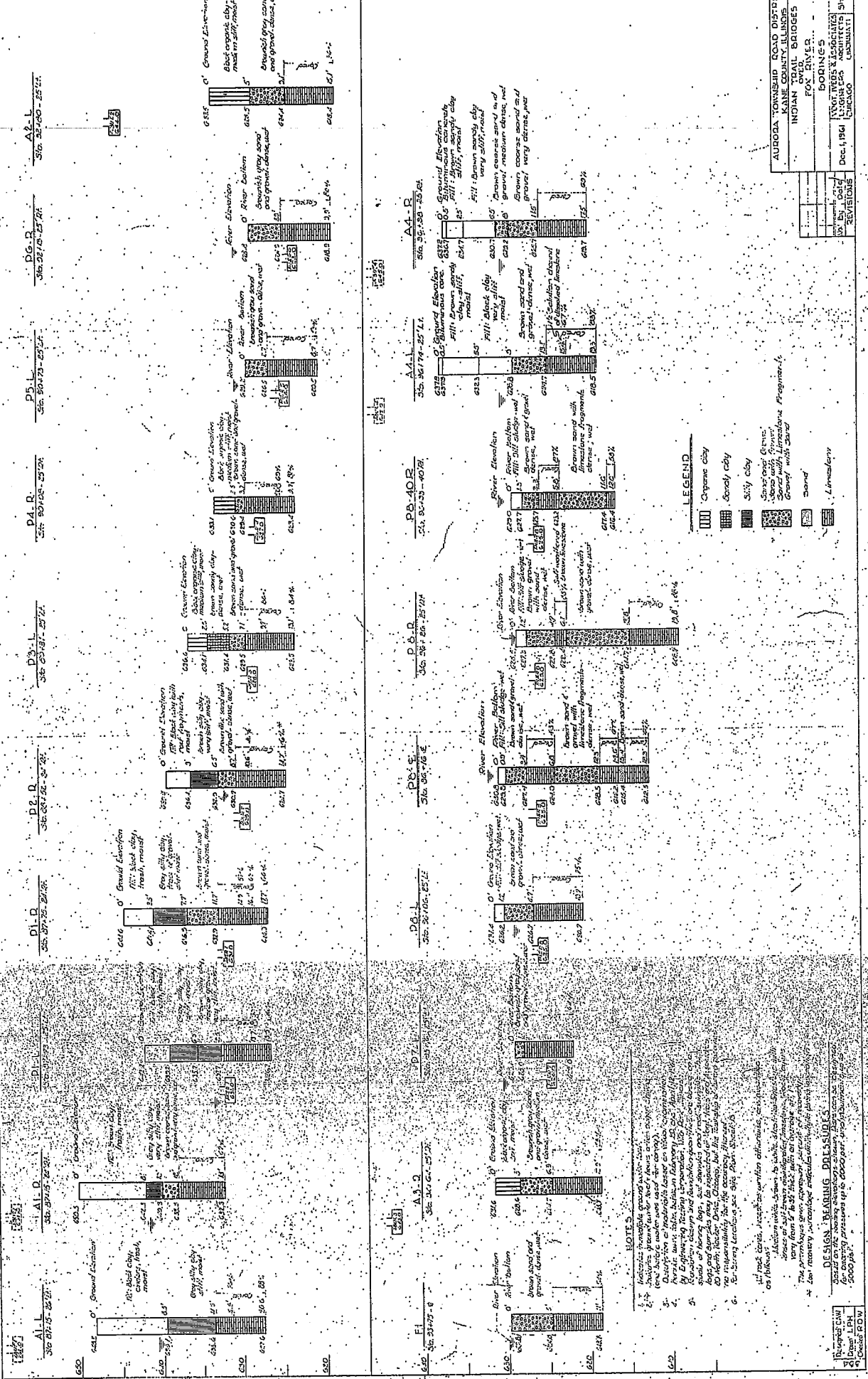

LEGEND

[Pattern]	Organic clay
[Pattern]	Stoney clay
[Pattern]	Silty clay
[Pattern]	Stagnant organic silt with gravel
[Pattern]	Gravel with sand
[Pattern]	Sand
[Pattern]	Limstony

AURORA TOWNSHIP ROAD DISTRICT
 KANE COUNTY, ILLINOIS
 INDIAN TRAIL BRIDGES
 FOX DRIVERS
 BUILDINGS
 KANE COUNTY ARCHITECTS
 1100 N. LAUREL ST.
 CHICAGO, ILL. 60642
 Dec. 1, 1964
 REVISIONS

NOTES

1. Soil samples were taken from the various soil profiles shown on this plan.
2. The soil samples were analyzed by the Illinois State Laboratory at Urbana, Illinois.
3. The soil samples were analyzed by the Illinois State Laboratory at Urbana, Illinois.
4. The soil samples were analyzed by the Illinois State Laboratory at Urbana, Illinois.
5. The soil samples were analyzed by the Illinois State Laboratory at Urbana, Illinois.
6. The soil samples were analyzed by the Illinois State Laboratory at Urbana, Illinois.

DESIGN BEARING CAPACITIES

For bearing capacities see page 10 of 2000 (part of 11/10/64) and page 10 of 2000 (part of 11/10/64).

208

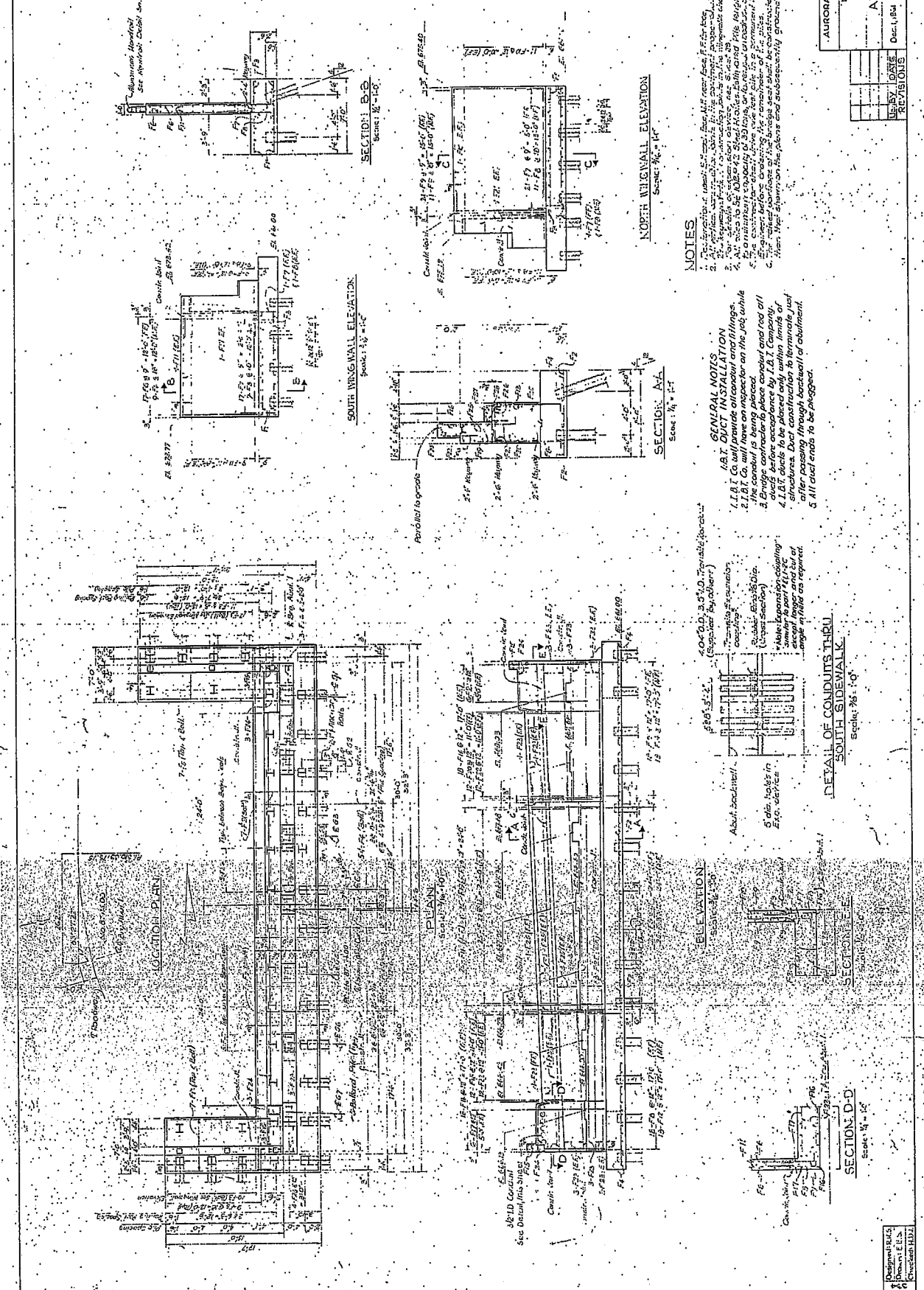

NOTES

1. Contractor to install... [unclear]... [unclear]...
2. [unclear]... [unclear]... [unclear]...
3. [unclear]... [unclear]... [unclear]...
4. [unclear]... [unclear]... [unclear]...
5. [unclear]... [unclear]... [unclear]...
6. [unclear]... [unclear]... [unclear]...
7. [unclear]... [unclear]... [unclear]...
8. [unclear]... [unclear]... [unclear]...
9. [unclear]... [unclear]... [unclear]...
10. [unclear]... [unclear]... [unclear]...
11. [unclear]... [unclear]... [unclear]...
12. [unclear]... [unclear]... [unclear]...
13. [unclear]... [unclear]... [unclear]...
14. [unclear]... [unclear]... [unclear]...
15. [unclear]... [unclear]... [unclear]...
16. [unclear]... [unclear]... [unclear]...
17. [unclear]... [unclear]... [unclear]...
18. [unclear]... [unclear]... [unclear]...
19. [unclear]... [unclear]... [unclear]...
20. [unclear]... [unclear]... [unclear]...
21. [unclear]... [unclear]... [unclear]...
22. [unclear]... [unclear]... [unclear]...
23. [unclear]... [unclear]... [unclear]...
24. [unclear]... [unclear]... [unclear]...
25. [unclear]... [unclear]... [unclear]...
26. [unclear]... [unclear]... [unclear]...
27. [unclear]... [unclear]... [unclear]...
28. [unclear]... [unclear]... [unclear]...
29. [unclear]... [unclear]... [unclear]...
30. [unclear]... [unclear]... [unclear]...
31. [unclear]... [unclear]... [unclear]...
32. [unclear]... [unclear]... [unclear]...
33. [unclear]... [unclear]... [unclear]...
34. [unclear]... [unclear]... [unclear]...
35. [unclear]... [unclear]... [unclear]...
36. [unclear]... [unclear]... [unclear]...
37. [unclear]... [unclear]... [unclear]...
38. [unclear]... [unclear]... [unclear]...
39. [unclear]... [unclear]... [unclear]...
40. [unclear]... [unclear]... [unclear]...
41. [unclear]... [unclear]... [unclear]...
42. [unclear]... [unclear]... [unclear]...
43. [unclear]... [unclear]... [unclear]...
44. [unclear]... [unclear]... [unclear]...
45. [unclear]... [unclear]... [unclear]...
46. [unclear]... [unclear]... [unclear]...
47. [unclear]... [unclear]... [unclear]...
48. [unclear]... [unclear]... [unclear]...
49. [unclear]... [unclear]... [unclear]...
50. [unclear]... [unclear]... [unclear]...
51. [unclear]... [unclear]... [unclear]...
52. [unclear]... [unclear]... [unclear]...
53. [unclear]... [unclear]... [unclear]...
54. [unclear]... [unclear]... [unclear]...
55. [unclear]... [unclear]... [unclear]...
56. [unclear]... [unclear]... [unclear]...
57. [unclear]... [unclear]... [unclear]...
58. [unclear]... [unclear]... [unclear]...
59. [unclear]... [unclear]... [unclear]...
60. [unclear]... [unclear]... [unclear]...
61. [unclear]... [unclear]... [unclear]...
62. [unclear]... [unclear]... [unclear]...
63. [unclear]... [unclear]... [unclear]...
64. [unclear]... [unclear]... [unclear]...
65. [unclear]... [unclear]... [unclear]...
66. [unclear]... [unclear]... [unclear]...
67. [unclear]... [unclear]... [unclear]...
68. [unclear]... [unclear]... [unclear]...
69. [unclear]... [unclear]... [unclear]...
70. [unclear]... [unclear]... [unclear]...
71. [unclear]... [unclear]... [unclear]...
72. [unclear]... [unclear]... [unclear]...
73. [unclear]... [unclear]... [unclear]...
74. [unclear]... [unclear]... [unclear]...
75. [unclear]... [unclear]... [unclear]...
76. [unclear]... [unclear]... [unclear]...
77. [unclear]... [unclear]... [unclear]...
78. [unclear]... [unclear]... [unclear]...
79. [unclear]... [unclear]... [unclear]...
80. [unclear]... [unclear]... [unclear]...
81. [unclear]... [unclear]... [unclear]...
82. [unclear]... [unclear]... [unclear]...
83. [unclear]... [unclear]... [unclear]...
84. [unclear]... [unclear]... [unclear]...
85. [unclear]... [unclear]... [unclear]...
86. [unclear]... [unclear]... [unclear]...
87. [unclear]... [unclear]... [unclear]...
88. [unclear]... [unclear]... [unclear]...
89. [unclear]... [unclear]... [unclear]...
90. [unclear]... [unclear]... [unclear]...
91. [unclear]... [unclear]... [unclear]...
92. [unclear]... [unclear]... [unclear]...
93. [unclear]... [unclear]... [unclear]...
94. [unclear]... [unclear]... [unclear]...
95. [unclear]... [unclear]... [unclear]...
96. [unclear]... [unclear]... [unclear]...
97. [unclear]... [unclear]... [unclear]...
98. [unclear]... [unclear]... [unclear]...
99. [unclear]... [unclear]... [unclear]...
100. [unclear]... [unclear]... [unclear]...

AURORA TOWNSHIP ROAD DISTRICT
 KANE COUNTY, ILLINOIS
 INDIAN TRAIL BRIDGES
 FOX RIVER
 AELTME...
 ILL. STATE ASSOCIATION OF ENGINEERS
 Dec. 1, 1911
 REVISIONS
 SHEET 15

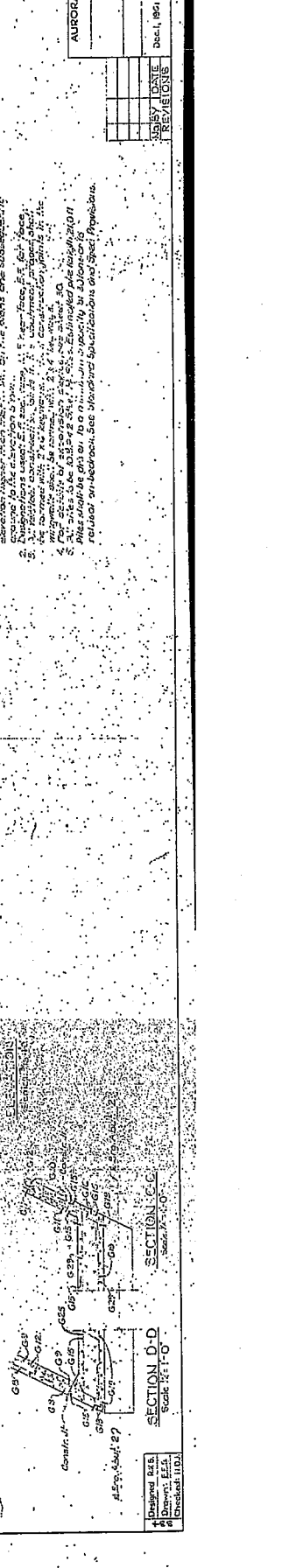
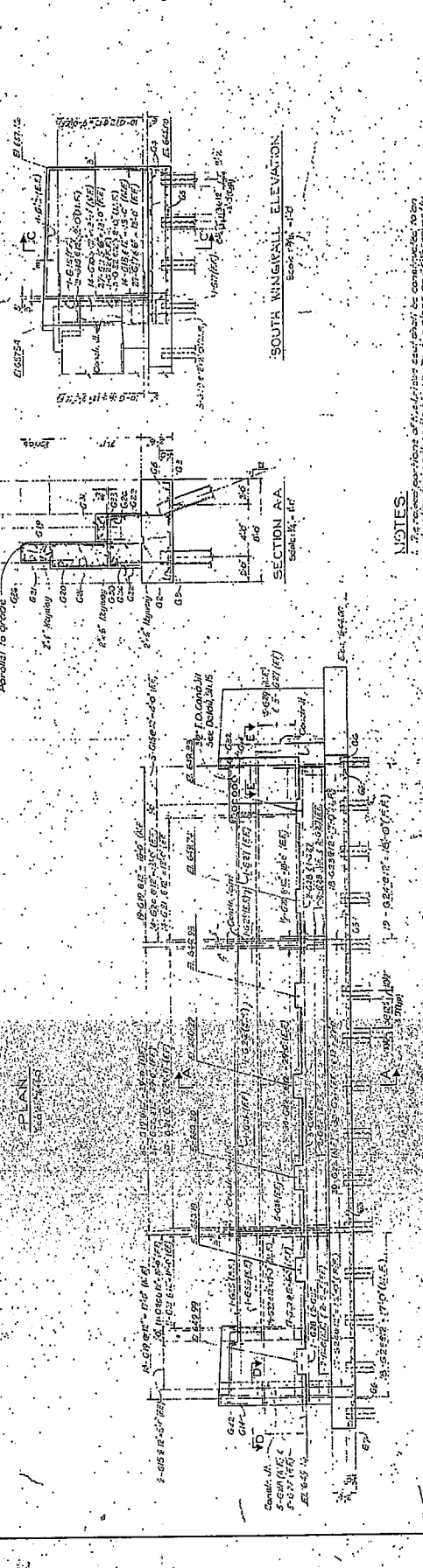
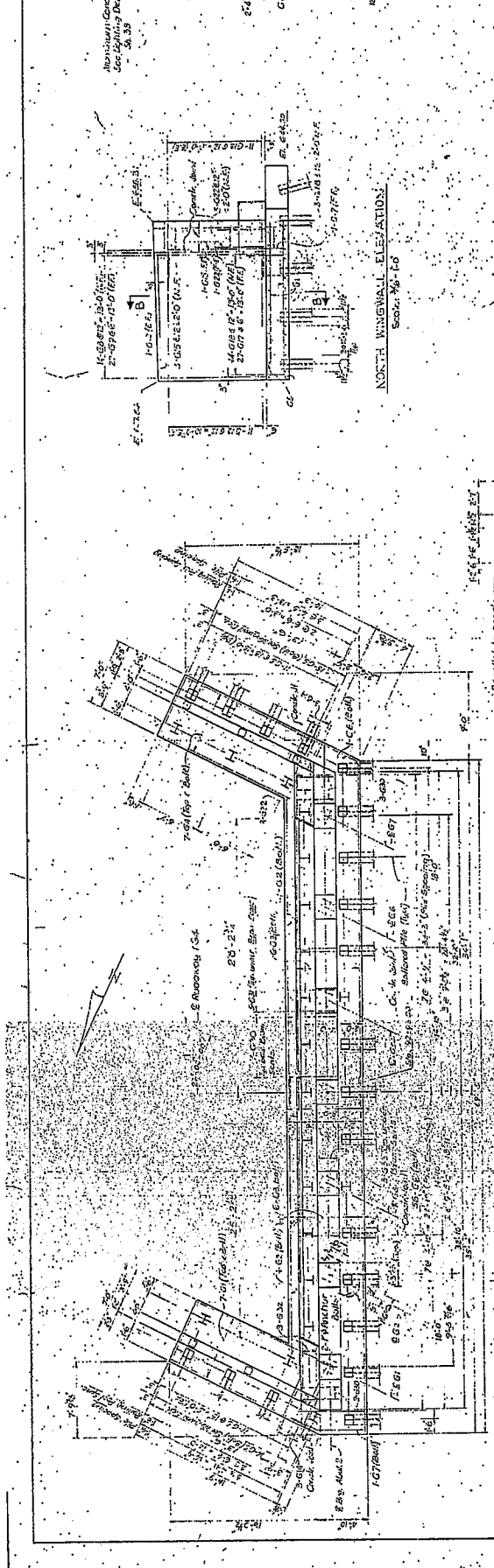

NOTES:

- The main span of this bridge shall be constructed as a continuous span over the two piers. The approach spans shall be constructed as simple spans over the abutments.
- The main span shall be constructed with a steel deck and steel girders. The approach spans shall be constructed with a concrete deck and steel girders.
- The main span shall be constructed with a steel deck and steel girders. The approach spans shall be constructed with a concrete deck and steel girders.
- The main span shall be constructed with a steel deck and steel girders. The approach spans shall be constructed with a concrete deck and steel girders.
- The main span shall be constructed with a steel deck and steel girders. The approach spans shall be constructed with a concrete deck and steel girders.

AURORA TOWNSHIP ROAD DISTRICT	
INDIAN TRAIL BRIDGES	
FOX RIVER	OVER
A.B. J. J. J.	DESIGNED BY
W.C. W. W. W.	DRAWN BY
CHICAGO	CHECKED BY
Dec. 11, 1961	DATE
REVISIONS	DATE

210

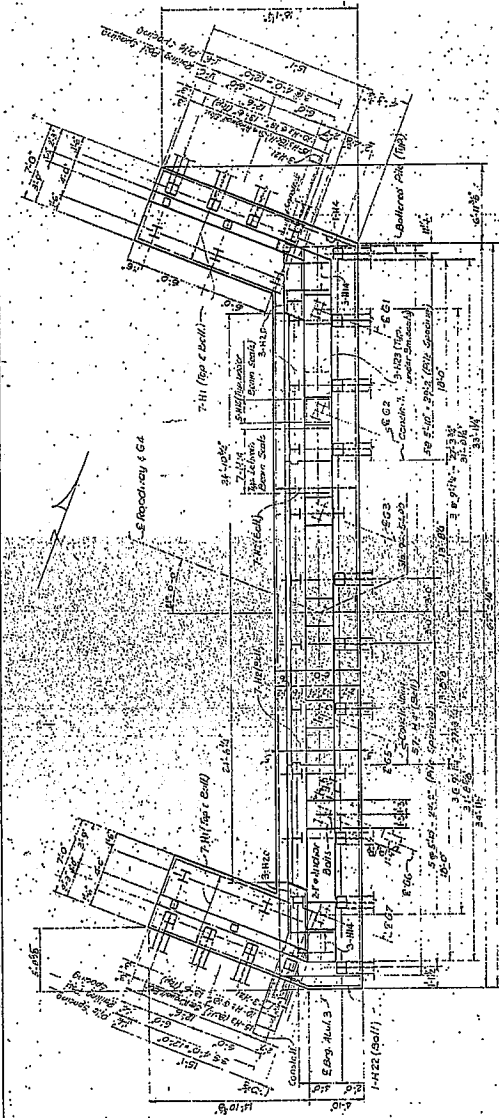

See Section E-E

SOUTH VINGWALL ELEVATION
Scale: 1/2" = 1'-0"

SECTION A-A
Scale: 1/2" = 1'-0"

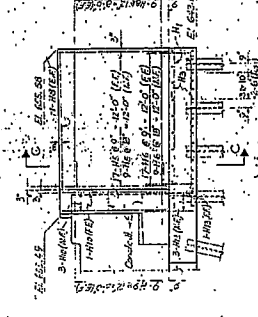

NORTH VINGWALL ELEVATION
Scale: 1/2" = 1'-0"

SECTION B-B
Scale: 1/2" = 1'-0"



SECTION C-C
Scale: 1/2" = 1'-0"

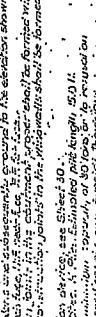

NOTES
1. Use standard specifications for bridge steel and reinforcement as shown on drawings unless otherwise noted.
2. Reinforcement shall be in accordance with the specifications shown on drawings unless otherwise noted.
3. All bridge structures shall be constructed in accordance with the specifications shown on drawings unless otherwise noted.
4. The designer is not responsible for the accuracy of the field measurements shown on drawings.
5. All work shall be in accordance with the specifications shown on drawings unless otherwise noted.

SECTION D-D
Scale: 1/2" = 1'-0"

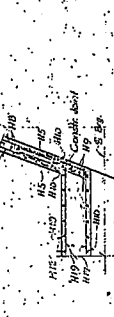

SECTION E-E
Scale: 1/2" = 1'-0"

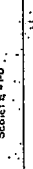

DESIGNED BY: [Name]
CHECKED BY: [Name]
DATE: [Date]

AURORA TOWNSHIP ROAD DISTRICT
KANE COUNTY, ILLINOIS
INDIAN TRAIL BRIDGES
FOK RIVER
APPROVED BY:
[Signature]
[Name]
[Title]
[Date]

0.11

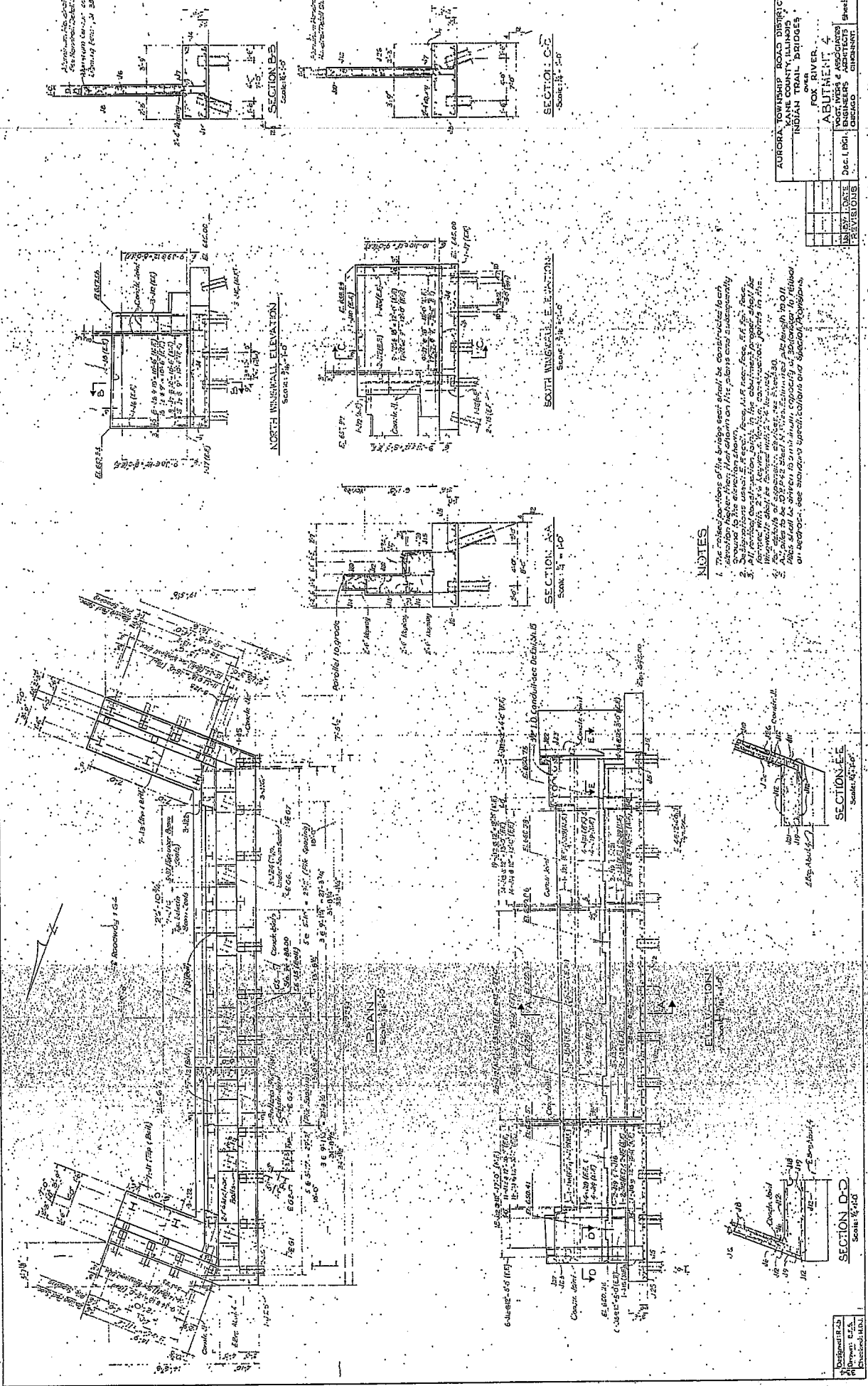

NOTES

1. The notes and details of the bridge shall be constructed to conform to the latest provisions on the subject and to the latest provisions on the subject.
2. All material shall be of the best quality obtainable.
3. All work shall be done in accordance with the specifications and details.
4. The contractor shall be responsible for the construction of the bridge.
5. The contractor shall be responsible for the construction of the bridge.
6. The contractor shall be responsible for the construction of the bridge.

AURORA TOWNSHIP ROAD DISTRICT
 KANE COUNTY, ILLINOIS
 INDIAN TRAIL BRIDGES
 FOX RIVER
 ABUTMENT
 ENGINEERS ARCHITECTS
 CHICAGO
 Dec. 1, 1901
 REVISIONS

NO.	DATE	REVISIONS

SECTION A-A
 Scale: 1/4" = 1'-0"

SECTION B-B
 Scale: 1/4" = 1'-0"

SECTION C-C
 Scale: 1/4" = 1'-0"

SECTION D-D
 Scale: 1/4" = 1'-0"

SECTION E-E
 Scale: 1/4" = 1'-0"

SECTION F-F
 Scale: 1/4" = 1'-0"

SECTION G-G
 Scale: 1/4" = 1'-0"

SECTION H-H
 Scale: 1/4" = 1'-0"

SECTION I-I
 Scale: 1/4" = 1'-0"

SECTION J-J
 Scale: 1/4" = 1'-0"

SECTION K-K
 Scale: 1/4" = 1'-0"

SECTION L-L
 Scale: 1/4" = 1'-0"

SECTION M-M
 Scale: 1/4" = 1'-0"

SECTION N-N
 Scale: 1/4" = 1'-0"

SECTION O-O
 Scale: 1/4" = 1'-0"

SECTION P-P
 Scale: 1/4" = 1'-0"

SECTION Q-Q
 Scale: 1/4" = 1'-0"

SECTION R-R
 Scale: 1/4" = 1'-0"

SECTION S-S
 Scale: 1/4" = 1'-0"

SECTION T-T
 Scale: 1/4" = 1'-0"

SECTION U-U
 Scale: 1/4" = 1'-0"

SECTION V-V
 Scale: 1/4" = 1'-0"

SECTION W-W
 Scale: 1/4" = 1'-0"

SECTION X-X
 Scale: 1/4" = 1'-0"

SECTION Y-Y
 Scale: 1/4" = 1'-0"

SECTION Z-Z
 Scale: 1/4" = 1'-0"

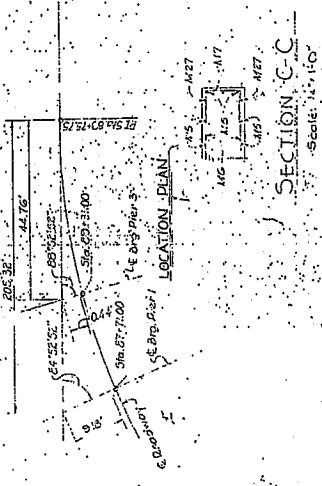

SECTION C-C
Scale: 1" = 10'

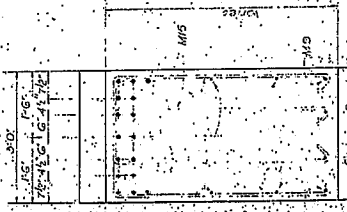

SECTION B-B
Scale: 3/4" = 10'

NOTES
1. Place P-series reinforcing bars in Pier 2 as shown for
M-series bars of same bar size in Pier 1, except as noted.
2. P-series portion of the bridge deck shall be constructed to an
elevation higher than that shown on the plans and subsequently
ground to this elevation shown.
E. F. Demore, design force

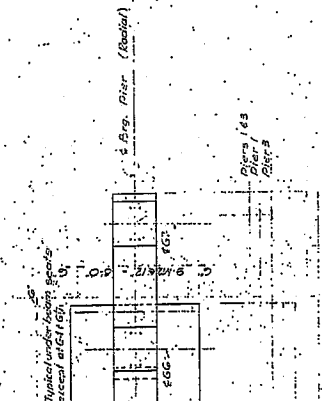

SECTION A-A
Scale: 1/2" = 10'

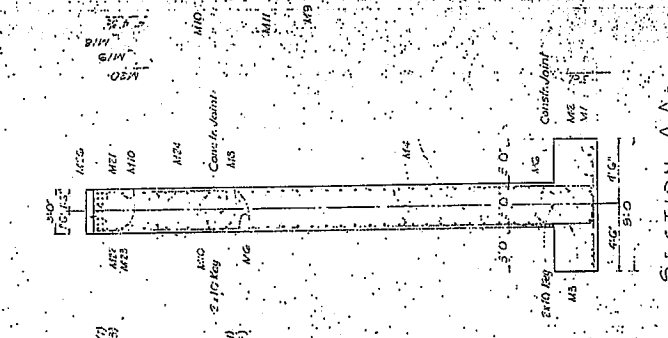

PLAN - PIERS 1 & 3
Scale: 1/4" = 10'

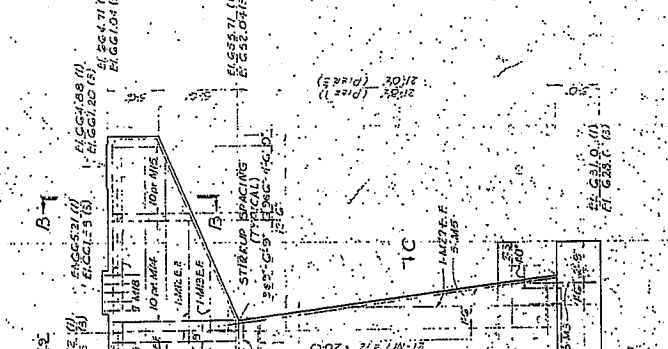

ELEVATION - PIERS 1 & 3
Scale: 1/4" = 10'

AURORA TOWNSHIP ROAD DISTRICT	
INDIAN TRAIL BRIDGES	
OVER FOX RIVER	
PIERS 1 & 3	
Dec. 1, 1961	Sheet 11
DESIGNED BY	ENGINEER
DRAWN BY	CHECKED BY
E. F. DEMORE & ASSOCIATES CHICAGO	

Designed by
Drawn by
Checked by

213

NOTES

- The raised portions of the bridge deck shall be finished with a smooth surface.
- A 3/8" dia. 6 gauge bent copper wire electrical bonding system shall be used and shall be installed in a 25 ft. radius from the footing and shall be continuous above and below the concrete to provide adequate bonding and reinforcement for the concrete structure.
- Reinforcing steel shall be installed in the bridge deck and shall be finished with a smooth surface.
- Reinforcing steel shall be installed in the bridge deck and shall be finished with a smooth surface.

LOCATION PLAN

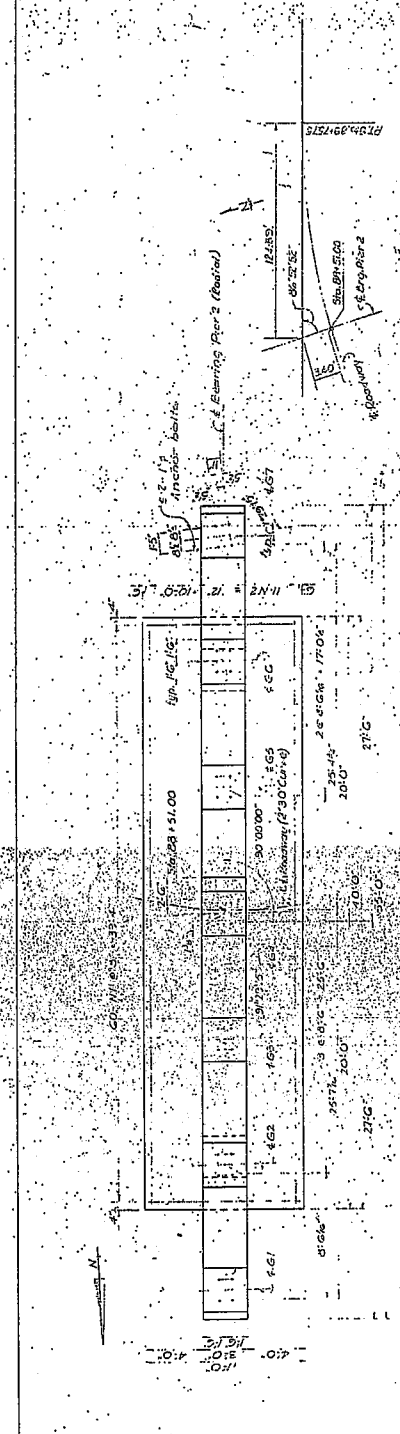

SECTION A-A

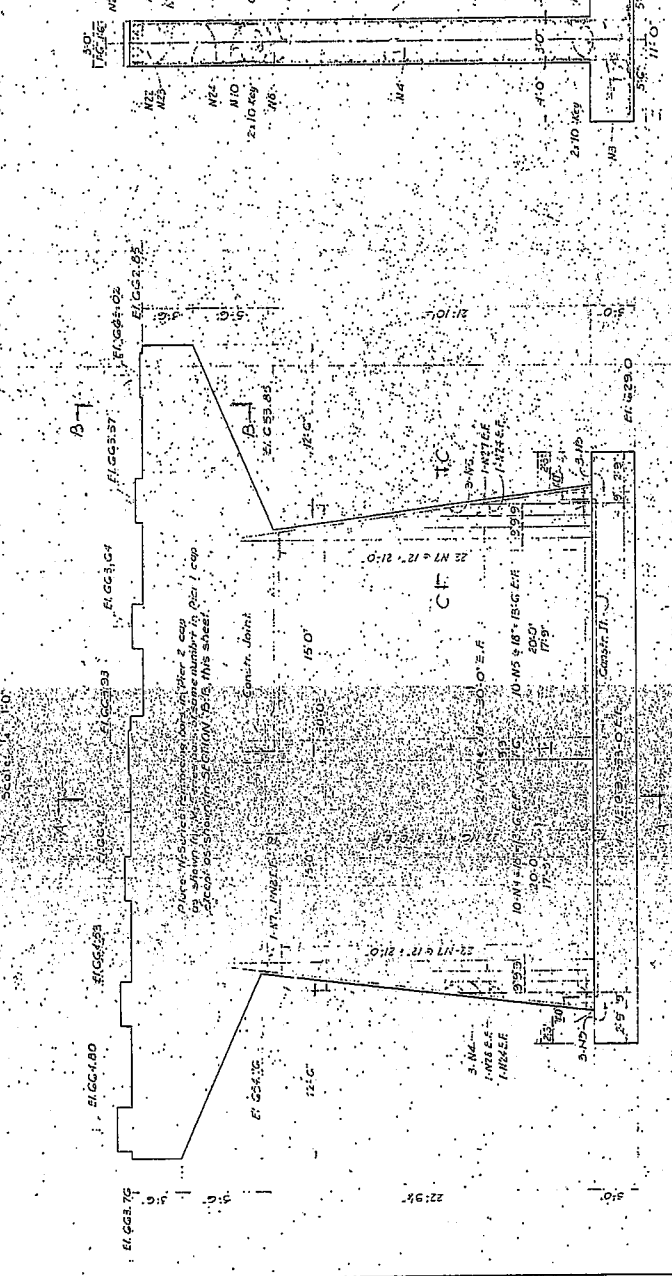

SECTION B-B

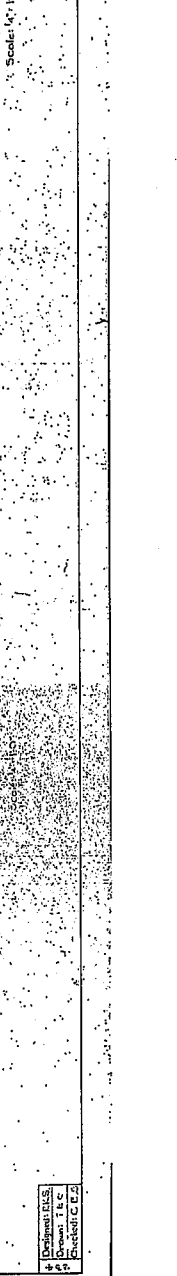

SECTION C-C



4. Drawn by T.E.C.
 4. Checked by C.C.
 4. Described by S.S.

AURORA TOWNSHIP ROAD DISTRICT
 KANE COUNTY, ILLINOIS
 INDIAN TRAIL BRIDGES
 FOX RIVER
 P.I.E.P. 2
 Dec. 1, 1921
 ENGINEERS
 ASSOCIATES
 CHICAGO
 SHEET 20

214

512



PLAN
Scale: 1" = 10'

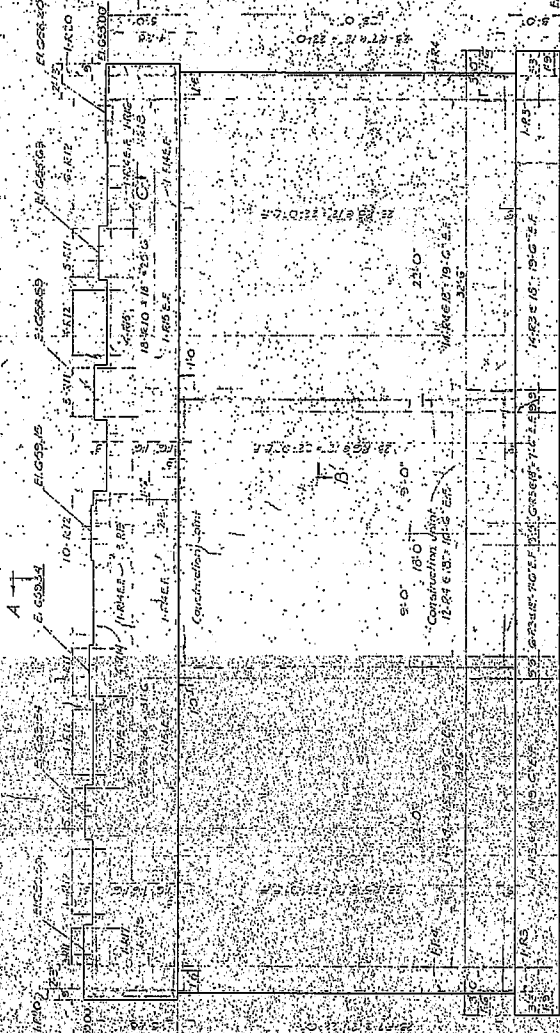

ELEVATION
Scale: 1" = 10'

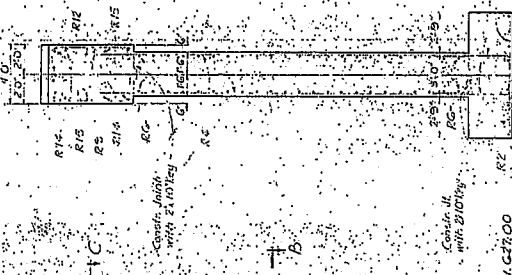

SECTION A-A
Scale: 1" = 10'

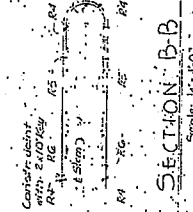

SECTION B-B
Scale: 1" = 10'

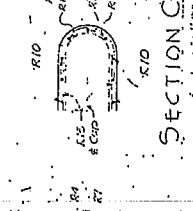

SECTION C-C
Scale: 1" = 10'

NOTES:
 1. The vertical portions of the bridge seat shall be cast in place concrete and shall be cast on a prepared ground to the elevation shown.
 2. S.S. denotes east face.

ADRIANA TOWNSHIP ROAD DISTRICT	
INDIAN TRAIL BRIDGES	
FOR RIVER	
PROJECT NO.	15-2
DATE	Dec. 1, 1961
DESIGNED BY	POST MERS & ASSOCIATES
DRAWN BY	CHAS. H. B.
CHECKED BY	CHAS. H. B.
REVISIONS	

Designed by
 Drawn by
 Checked by

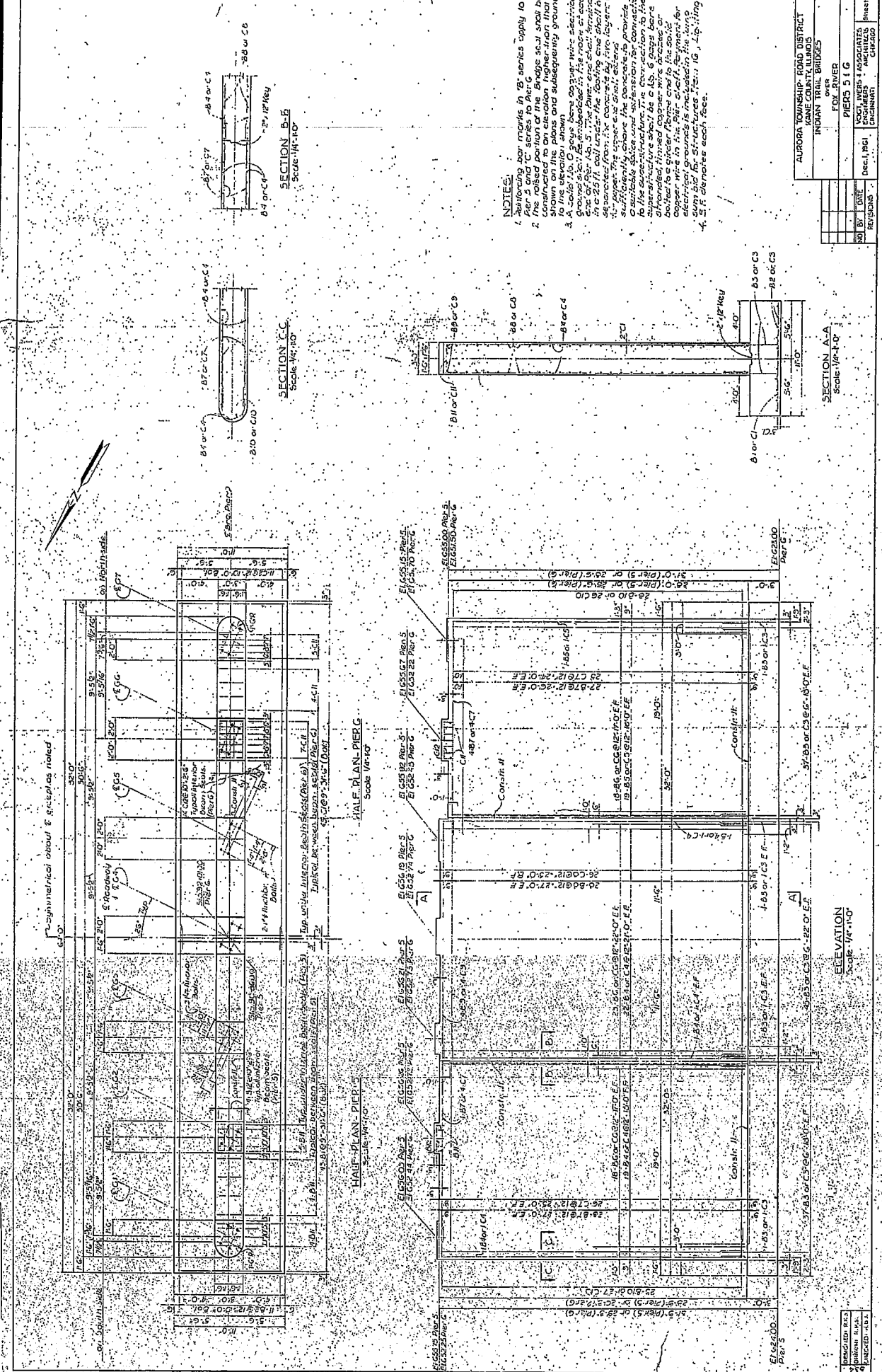

NOTES:

1. Reinforcing bar marks in "B" series apply to Pier S and "C" series to Pier C.
2. The raised portion of the bridge seat shall be shown to an elevation higher than that shown in the plan and subsequently ground to the elevation shown.
3. A 2" x 2" x 1/4" angle iron shall be attached to the top of the pier to support the following cast steel floor beams.
4. The concrete shall be placed in a continuous manner to the top of the pier.
5. The concrete shall be placed in a continuous manner to the top of the pier.
6. The concrete shall be placed in a continuous manner to the top of the pier.
7. The concrete shall be placed in a continuous manner to the top of the pier.
8. The concrete shall be placed in a continuous manner to the top of the pier.
9. The concrete shall be placed in a continuous manner to the top of the pier.
10. The concrete shall be placed in a continuous manner to the top of the pier.

ALURORA TOWNSHIP ROAD DISTRICT
KANE COUNTY, ILLINOIS

INDIAN TRAIL BRIDGES

FOX & BAMES

PIERS 5 & 6

DESIGNED BY: [Name]
CHECKED BY: [Name]
DATE: [Date]

PIERS 5 & 6
ENGINEER: [Name]
CHECKED: [Name]
DATE: [Date]

216

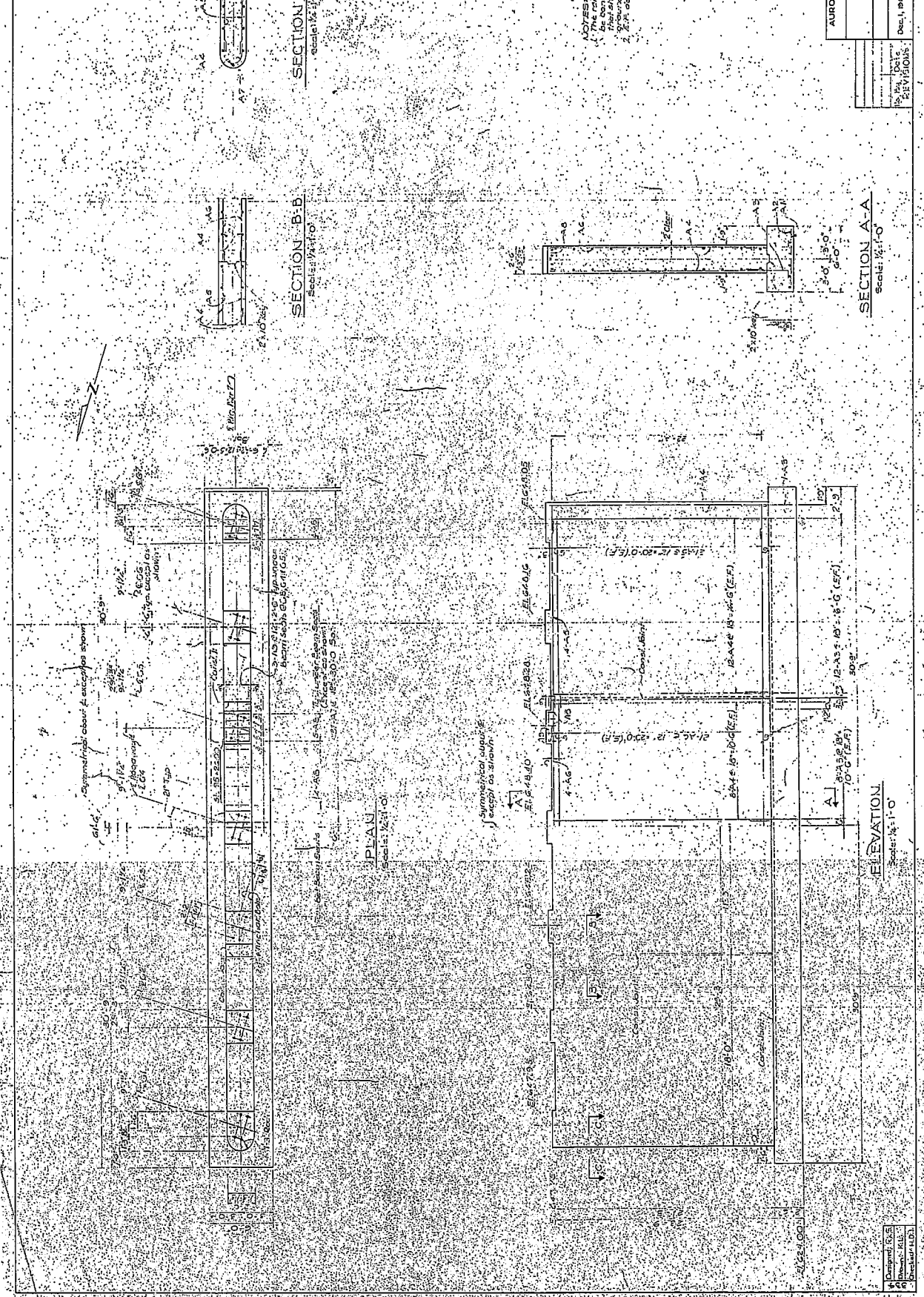

NOTES:
 1. The center line of the bridge pier is shown in the center line of the pier.
 2. The center line of the pier is shown in the center line of the pier.
 3. The center line of the pier is shown in the center line of the pier.

AURORA TOWNSHIP ROAD DISTRICT
 INDIAN TRAIL BRIDGES
 OVER
 FOX RIVER
PIER 7
 WEST, METERS & ASSOCIATES
 CHICAGO, ILLINOIS
 Dec. 1, 1911

SECTION C-C
 Scale: 1/2"=1'-0"

SECTION B-B
 Scale: 1/2"=1'-0"

SECTION A-A
 Scale: 1/2"=1'-0"

PLAN
 Scale: 1/2"=1'-0"

ELEVATION
 Scale: 1/2"=1'-0"

Checked by
 Drawn by
 Approved by

12

SPECIAL NOTES PER B

1. Pile holes shall be drilled at locations indicated on this drawing as in the order of excavation for the footing is complete and prior to installing any piles.
2. The pile holes shall extend to an elevation of less than 2.00' below the elevation of the pile cap.
3. Where a pile hole encounters discontinuity in the bearing pile soil, the pile hole shall be extended to an elevation such that there is at least 2.00' of bearing pile soil below the pile hole.
4. In the case of pile holes where discontinuity is encountered, the sequence of drilling shall be revised to include alternate locations, (e.g., 1, 2, 3, 4, 5, 6, 7, 8, 9, 10, 11, 12, 13, 14, 15, 16, 17, 18, 19, 20, 21, 22, 23, 24, 25, 26, 27, 28, 29, 30, 31, 32, 33, 34, 35, 36, 37, 38, 39, 40, 41, 42, 43, 44, 45, 46, 47, 48, 49, 50, 51, 52, 53, 54, 55, 56, 57, 58, 59, 60, 61, 62, 63, 64, 65, 66, 67, 68, 69, 70, 71, 72, 73, 74, 75, 76, 77, 78, 79, 80, 81, 82, 83, 84, 85, 86, 87, 88, 89, 90, 91, 92, 93, 94, 95, 96, 97, 98, 99, 100).
5. Pile holes shall be drilled to a minimum pile length below the bearing pile soil of 10.00'.
6. The bearing pile holes shall be drilled in the order of 1, 2, 3, 4, 5, 6, 7, 8, 9, 10, 11, 12, 13, 14, 15, 16, 17, 18, 19, 20, 21, 22, 23, 24, 25, 26, 27, 28, 29, 30, 31, 32, 33, 34, 35, 36, 37, 38, 39, 40, 41, 42, 43, 44, 45, 46, 47, 48, 49, 50, 51, 52, 53, 54, 55, 56, 57, 58, 59, 60, 61, 62, 63, 64, 65, 66, 67, 68, 69, 70, 71, 72, 73, 74, 75, 76, 77, 78, 79, 80, 81, 82, 83, 84, 85, 86, 87, 88, 89, 90, 91, 92, 93, 94, 95, 96, 97, 98, 99, 100.
7. The bearing pile holes shall be drilled in the order of 1, 2, 3, 4, 5, 6, 7, 8, 9, 10, 11, 12, 13, 14, 15, 16, 17, 18, 19, 20, 21, 22, 23, 24, 25, 26, 27, 28, 29, 30, 31, 32, 33, 34, 35, 36, 37, 38, 39, 40, 41, 42, 43, 44, 45, 46, 47, 48, 49, 50, 51, 52, 53, 54, 55, 56, 57, 58, 59, 60, 61, 62, 63, 64, 65, 66, 67, 68, 69, 70, 71, 72, 73, 74, 75, 76, 77, 78, 79, 80, 81, 82, 83, 84, 85, 86, 87, 88, 89, 90, 91, 92, 93, 94, 95, 96, 97, 98, 99, 100.
8. The pile holes shall be drilled in the order of 1, 2, 3, 4, 5, 6, 7, 8, 9, 10, 11, 12, 13, 14, 15, 16, 17, 18, 19, 20, 21, 22, 23, 24, 25, 26, 27, 28, 29, 30, 31, 32, 33, 34, 35, 36, 37, 38, 39, 40, 41, 42, 43, 44, 45, 46, 47, 48, 49, 50, 51, 52, 53, 54, 55, 56, 57, 58, 59, 60, 61, 62, 63, 64, 65, 66, 67, 68, 69, 70, 71, 72, 73, 74, 75, 76, 77, 78, 79, 80, 81, 82, 83, 84, 85, 86, 87, 88, 89, 90, 91, 92, 93, 94, 95, 96, 97, 98, 99, 100.

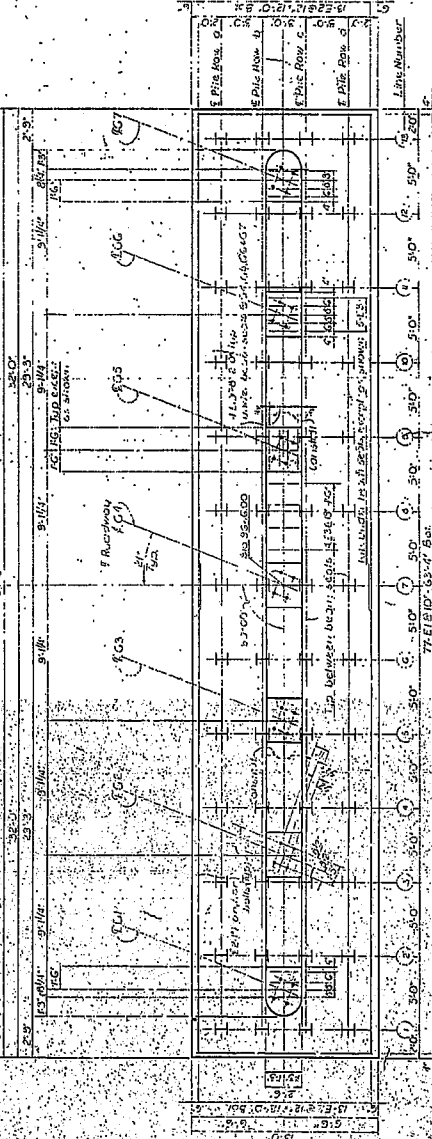

SECTION B-B
Scale: 1/4" = 1'-0"

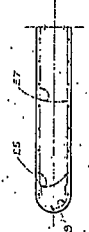

SECTION C-C
Scale: 1/4" = 1'-0"

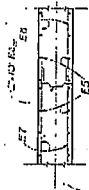

NOTES:

1. The minimum length of the pile shall be such that the pile is embedded in the bearing pile soil to a minimum depth of 10.00' below the bearing pile soil.
2. The pile shall be drilled to a minimum pile length below the bearing pile soil of 10.00'.
3. The pile shall be drilled in the order of 1, 2, 3, 4, 5, 6, 7, 8, 9, 10, 11, 12, 13, 14, 15, 16, 17, 18, 19, 20, 21, 22, 23, 24, 25, 26, 27, 28, 29, 30, 31, 32, 33, 34, 35, 36, 37, 38, 39, 40, 41, 42, 43, 44, 45, 46, 47, 48, 49, 50, 51, 52, 53, 54, 55, 56, 57, 58, 59, 60, 61, 62, 63, 64, 65, 66, 67, 68, 69, 70, 71, 72, 73, 74, 75, 76, 77, 78, 79, 80, 81, 82, 83, 84, 85, 86, 87, 88, 89, 90, 91, 92, 93, 94, 95, 96, 97, 98, 99, 100.
4. The pile shall be drilled in the order of 1, 2, 3, 4, 5, 6, 7, 8, 9, 10, 11, 12, 13, 14, 15, 16, 17, 18, 19, 20, 21, 22, 23, 24, 25, 26, 27, 28, 29, 30, 31, 32, 33, 34, 35, 36, 37, 38, 39, 40, 41, 42, 43, 44, 45, 46, 47, 48, 49, 50, 51, 52, 53, 54, 55, 56, 57, 58, 59, 60, 61, 62, 63, 64, 65, 66, 67, 68, 69, 70, 71, 72, 73, 74, 75, 76, 77, 78, 79, 80, 81, 82, 83, 84, 85, 86, 87, 88, 89, 90, 91, 92, 93, 94, 95, 96, 97, 98, 99, 100.
5. The pile shall be drilled in the order of 1, 2, 3, 4, 5, 6, 7, 8, 9, 10, 11, 12, 13, 14, 15, 16, 17, 18, 19, 20, 21, 22, 23, 24, 25, 26, 27, 28, 29, 30, 31, 32, 33, 34, 35, 36, 37, 38, 39, 40, 41, 42, 43, 44, 45, 46, 47, 48, 49, 50, 51, 52, 53, 54, 55, 56, 57, 58, 59, 60, 61, 62, 63, 64, 65, 66, 67, 68, 69, 70, 71, 72, 73, 74, 75, 76, 77, 78, 79, 80, 81, 82, 83, 84, 85, 86, 87, 88, 89, 90, 91, 92, 93, 94, 95, 96, 97, 98, 99, 100.
6. The pile shall be drilled in the order of 1, 2, 3, 4, 5, 6, 7, 8, 9, 10, 11, 12, 13, 14, 15, 16, 17, 18, 19, 20, 21, 22, 23, 24, 25, 26, 27, 28, 29, 30, 31, 32, 33, 34, 35, 36, 37, 38, 39, 40, 41, 42, 43, 44, 45, 46, 47, 48, 49, 50, 51, 52, 53, 54, 55, 56, 57, 58, 59, 60, 61, 62, 63, 64, 65, 66, 67, 68, 69, 70, 71, 72, 73, 74, 75, 76, 77, 78, 79, 80, 81, 82, 83, 84, 85, 86, 87, 88, 89, 90, 91, 92, 93, 94, 95, 96, 97, 98, 99, 100.
7. The pile shall be drilled in the order of 1, 2, 3, 4, 5, 6, 7, 8, 9, 10, 11, 12, 13, 14, 15, 16, 17, 18, 19, 20, 21, 22, 23, 24, 25, 26, 27, 28, 29, 30, 31, 32, 33, 34, 35, 36, 37, 38, 39, 40, 41, 42, 43, 44, 45, 46, 47, 48, 49, 50, 51, 52, 53, 54, 55, 56, 57, 58, 59, 60, 61, 62, 63, 64, 65, 66, 67, 68, 69, 70, 71, 72, 73, 74, 75, 76, 77, 78, 79, 80, 81, 82, 83, 84, 85, 86, 87, 88, 89, 90, 91, 92, 93, 94, 95, 96, 97, 98, 99, 100.
8. The pile shall be drilled in the order of 1, 2, 3, 4, 5, 6, 7, 8, 9, 10, 11, 12, 13, 14, 15, 16, 17, 18, 19, 20, 21, 22, 23, 24, 25, 26, 27, 28, 29, 30, 31, 32, 33, 34, 35, 36, 37, 38, 39, 40, 41, 42, 43, 44, 45, 46, 47, 48, 49, 50, 51, 52, 53, 54, 55, 56, 57, 58, 59, 60, 61, 62, 63, 64, 65, 66, 67, 68, 69, 70, 71, 72, 73, 74, 75, 76, 77, 78, 79, 80, 81, 82, 83, 84, 85, 86, 87, 88, 89, 90, 91, 92, 93, 94, 95, 96, 97, 98, 99, 100.

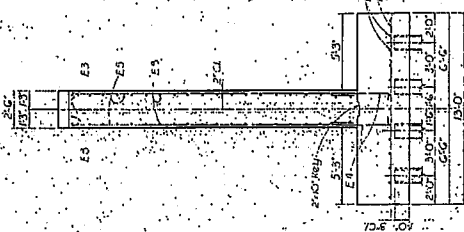

ELEVATION
Scale: 1/4" = 1'-0"

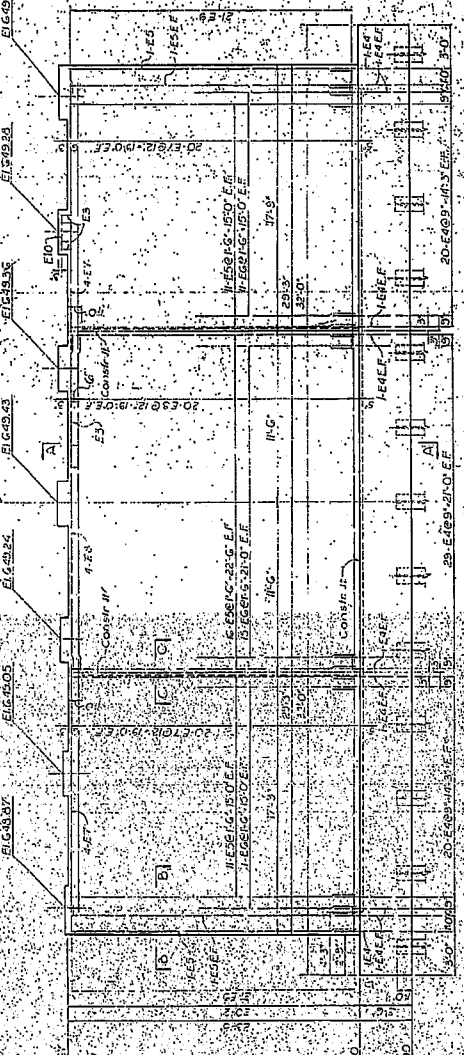

DESIGNED BY	FOOT PIER
CHECKED BY	PIER 0
DATE	Dec 1, 1981
REVISIONS	

ARADRA TRUCKING ROAD DISTRICT	SHEET
HANK COUNTY, MISSOURI	
INDIAN TRAIL BRIDGES	
FOOT PIER	
PIER 0	
DATE	Dec 1, 1981
BY	
REVISIONS	

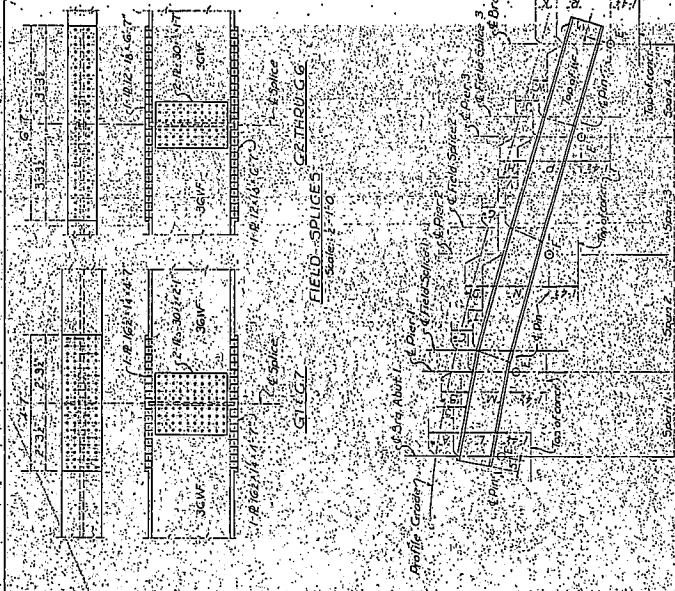

SECTION	CG	CG	CG	CG	CG	CG
A	116	116	116	116	116	116
B	116	116	116	116	116	116
C	116	116	116	116	116	116
D	116	116	116	116	116	116
E	116	116	116	116	116	116
F	116	116	116	116	116	116
G	116	116	116	116	116	116
H	116	116	116	116	116	116
I	116	116	116	116	116	116
J	116	116	116	116	116	116
K	116	116	116	116	116	116
L	116	116	116	116	116	116
M	116	116	116	116	116	116
N	116	116	116	116	116	116
O	116	116	116	116	116	116
P	116	116	116	116	116	116
Q	116	116	116	116	116	116
R	116	116	116	116	116	116
S	116	116	116	116	116	116
T	116	116	116	116	116	116
U	116	116	116	116	116	116
V	116	116	116	116	116	116
W	116	116	116	116	116	116
X	116	116	116	116	116	116
Y	116	116	116	116	116	116
Z	116	116	116	116	116	116

ELEVATION LAYOUT

GIRDER	MOMENTS												REACTIONS												SHEARS											
	B	C	D	E	F	G	H	I	J	K	L	M	A	B	C	D	E	F	G	H	I	J	K	L	CA	CB	CC	CD	CE	CF	CG	CH	CI	CJ	CK	CL
D	440	102	264	420	576	732	888	1044	1200	1356	1512	1668	46	75	104	133	162	191	220	249	278	307	336	365	86	89	92	95	98	101	104	107	110	113	116	119
G1	123	114	117	119	121	123	125	127	129	131	133	135	105	105	105	105	105	105	105	105	105	105	105	105	13	13	13	13	13	13	13	13	13	13	13	13
G7	410	112	262	418	576	734	892	1050	1208	1366	1524	1682	44	73	102	131	160	189	218	247	276	305	334	363	84	87	90	93	96	99	102	105	108	111	114	117
HT	220	351	482	613	744	875	1006	1137	1268	1399	1530	1661	25	43	61	79	97	115	133	151	169	187	205	223	43	43	43	43	43	43	43	43	43	43	43	43
CONCRETE	495	491	530	571	612	653	694	735	776	817	858	899	51	51	51	51	51	51	51	51	51	51	51	51	54	56	58	60	62	64	66	68	70	72	74	76
(MAX)	200	168	313	458	603	748	893	1038	1183	1328	1473	1618	120	170	220	270	320	370	420	470	520	570	620	670	112	113	114	115	116	117	118	119	120	121	122	123

MAXIMUM MOMENTS, REACTIONS & SHEARS

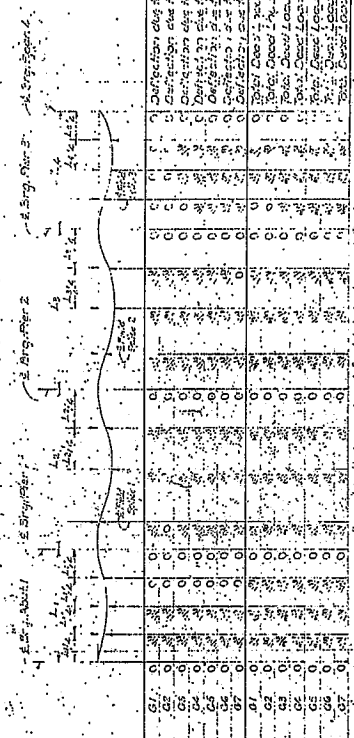

DEFLECTION CURVES FOR VARIOUS LOADS AND DEFLECTIONS ONLY

AURORA TOWNSHIP BOULDER DISTRICT
 INDIAN TRAIL BRIDGES
 FOR RIVER
 STEEL DETAILS
 DESIGNER: [Name]
 CHECKED: [Name]
 DATE: [Date]

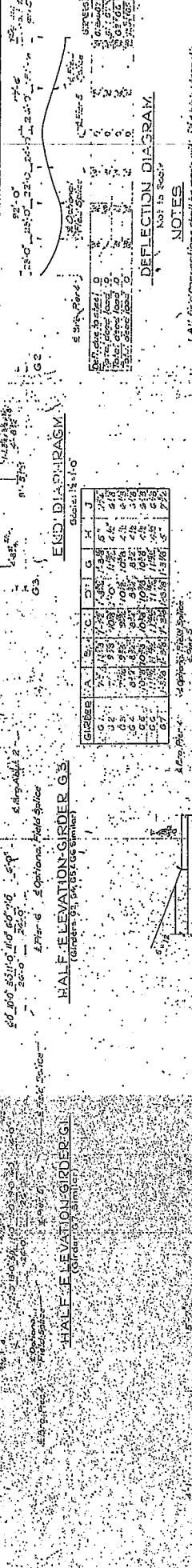
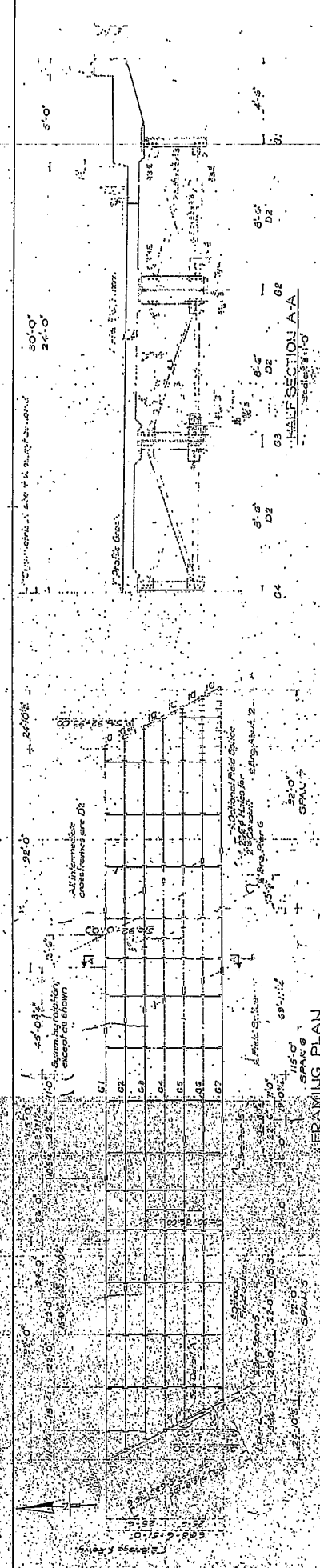

CROSSING	SPANS	NO. OF SPANS	NO. OF GIRDERS	NO. OF PILES	NO. OF BRACINGS
G1	30'-0"	1	2	4	2
G2	24'-0"	1	2	4	2
G3	32'-0"	1	2	4	2
G4	32'-0"	1	2	4	2
G5	32'-0"	1	2	4	2
G6	32'-0"	1	2	4	2
G7	32'-0"	1	2	4	2

CROSSING	SPANS	NO. OF SPANS	NO. OF GIRDERS	NO. OF PILES	NO. OF BRACINGS
G1	30'-0"	1	2	4	2
G2	24'-0"	1	2	4	2
G3	32'-0"	1	2	4	2
G4	32'-0"	1	2	4	2
G5	32'-0"	1	2	4	2
G6	32'-0"	1	2	4	2
G7	32'-0"	1	2	4	2

CROSSING	SPANS	NO. OF SPANS	NO. OF GIRDERS	NO. OF PILES	NO. OF BRACINGS
G1	30'-0"	1	2	4	2
G2	24'-0"	1	2	4	2
G3	32'-0"	1	2	4	2
G4	32'-0"	1	2	4	2
G5	32'-0"	1	2	4	2
G6	32'-0"	1	2	4	2
G7	32'-0"	1	2	4	2

CROSSING	SPANS	NO. OF SPANS	NO. OF GIRDERS	NO. OF PILES	NO. OF BRACINGS
G1	30'-0"	1	2	4	2
G2	24'-0"	1	2	4	2
G3	32'-0"	1	2	4	2
G4	32'-0"	1	2	4	2
G5	32'-0"	1	2	4	2
G6	32'-0"	1	2	4	2
G7	32'-0"	1	2	4	2

CROSSING	SPANS	NO. OF SPANS	NO. OF GIRDERS	NO. OF PILES	NO. OF BRACINGS
G1	30'-0"	1	2	4	2
G2	24'-0"	1	2	4	2
G3	32'-0"	1	2	4	2
G4	32'-0"	1	2	4	2
G5	32'-0"	1	2	4	2
G6	32'-0"	1	2	4	2
G7	32'-0"	1	2	4	2

CROSSING	SPANS	NO. OF SPANS	NO. OF GIRDERS	NO. OF PILES	NO. OF BRACINGS
G1	30'-0"	1	2	4	2
G2	24'-0"	1	2	4	2
G3	32'-0"	1	2	4	2
G4	32'-0"	1	2	4	2
G5	32'-0"	1	2	4	2
G6	32'-0"	1	2	4	2
G7	32'-0"	1	2	4	2

CROSSING	SPANS	NO. OF SPANS	NO. OF GIRDERS	NO. OF PILES	NO. OF BRACINGS
G1	30'-0"	1	2	4	2
G2	24'-0"	1	2	4	2
G3	32'-0"	1	2	4	2
G4	32'-0"	1	2	4	2
G5	32'-0"	1	2	4	2
G6	32'-0"	1	2	4	2
G7	32'-0"	1	2	4	2

CROSSING	SPANS	NO. OF SPANS	NO. OF GIRDERS	NO. OF PILES	NO. OF BRACINGS
G1	30'-0"	1	2	4	2
G2	24'-0"	1	2	4	2
G3	32'-0"	1	2	4	2
G4	32'-0"	1	2	4	2
G5	32'-0"	1	2	4	2
G6	32'-0"	1	2	4	2
G7	32'-0"	1	2	4	2

CROSSING	SPANS	NO. OF SPANS	NO. OF GIRDERS	NO. OF PILES	NO. OF BRACINGS
G1	30'-0"	1	2	4	2
G2	24'-0"	1	2	4	2
G3	32'-0"	1	2	4	2
G4	32'-0"	1	2	4	2
G5	32'-0"	1	2	4	2
G6	32'-0"	1	2	4	2
G7	32'-0"	1	2	4	2

CROSSING	SPANS	NO. OF SPANS	NO. OF GIRDERS	NO. OF PILES	NO. OF BRACINGS
G1	30'-0"	1	2	4	2
G2	24'-0"	1	2	4	2
G3	32'-0"	1	2	4	2
G4	32'-0"	1	2	4	2
G5	32'-0"	1	2	4	2
G6	32'-0"	1	2	4	2
G7	32'-0"	1	2	4	2

CROSSING	SPANS	NO. OF SPANS	NO. OF GIRDERS	NO. OF PILES	NO. OF BRACINGS
G1	30'-0"	1	2	4	2
G2	24'-0"	1	2	4	2
G3	32'-0"	1	2	4	2
G4	32'-0"	1	2	4	2
G5	32'-0"	1	2	4	2
G6	32'-0"	1	2	4	2
G7	32'-0"	1	2	4	2

CROSSING	SPANS	NO. OF SPANS	NO. OF GIRDERS	NO. OF PILES	NO. OF BRACINGS
G1	30'-0"	1	2	4	2
G2	24'-0"	1	2	4	2
G3	32'-0"	1	2	4	2
G4	32'-0"	1	2	4	2
G5	32'-0"	1	2	4	2
G6	32'-0"	1	2	4	2
G7	32'-0"	1	2	4	2

CROSSING	SPANS	NO. OF SPANS	NO. OF GIRDERS	NO. OF PILES	NO. OF BRACINGS
G1	30'-0"	1	2	4	2
G2	24'-0"	1	2	4	2
G3	32'-0"	1	2	4	2
G4	32'-0"	1	2	4	2
G5	32'-0"	1	2	4	2
G6	32'-0"	1	2	4	2
G7	32'-0"	1	2	4	2

CROSSING	SPANS	NO. OF SPANS	NO. OF GIRDERS	NO. OF PILES	NO. OF BRACINGS
G1	30'-0"	1	2	4	2
G2	24'-0"	1	2	4	2
G3	32'-0"	1	2	4	2
G4	32'-0"	1	2	4	2
G5	32'-0"	1	2	4	2
G6	32'-0"	1	2	4	2
G7	32'-0"	1	2	4	2

221

SECTION A-A
SECTION B-B
SECTION C-C
SECTION D-D
SECTION E-E
SECTION F-F
SECTION G-G
SECTION H-H
SECTION I-I
SECTION J-J
SECTION K-K
SECTION L-L
SECTION M-M
SECTION N-N
SECTION O-O
SECTION P-P
SECTION Q-Q
SECTION R-R
SECTION S-S
SECTION T-T
SECTION U-U
SECTION V-V
SECTION W-W
SECTION X-X
SECTION Y-Y
SECTION Z-Z

NOTES:
1. All dimensions are in feet and inches.
2. All dimensions are to the center of the member unless otherwise noted.
3. All dimensions are to the center of the member unless otherwise noted.
4. All dimensions are to the center of the member unless otherwise noted.
5. All dimensions are to the center of the member unless otherwise noted.
6. All dimensions are to the center of the member unless otherwise noted.
7. All dimensions are to the center of the member unless otherwise noted.
8. All dimensions are to the center of the member unless otherwise noted.
9. All dimensions are to the center of the member unless otherwise noted.
10. All dimensions are to the center of the member unless otherwise noted.

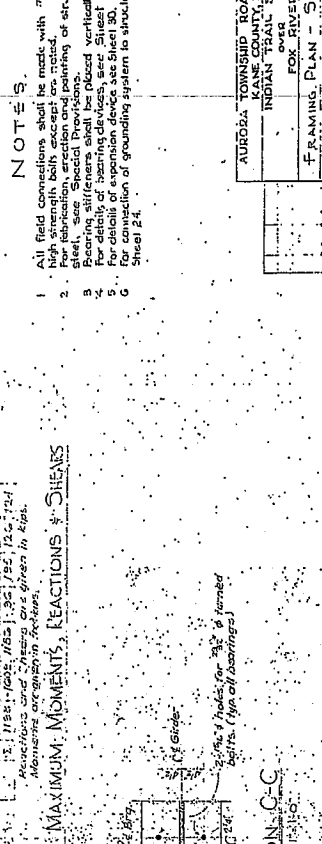
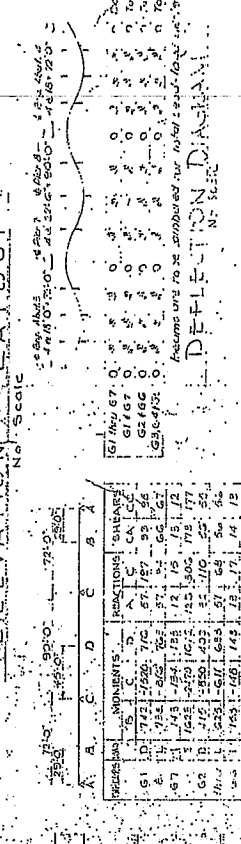
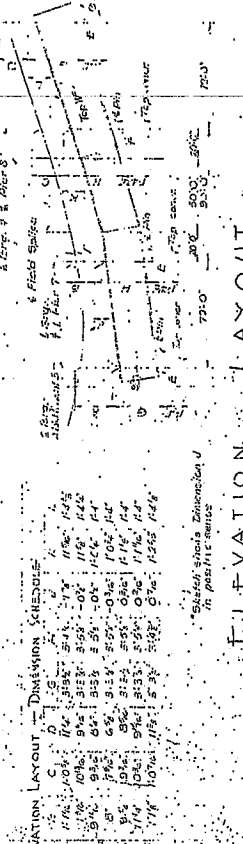
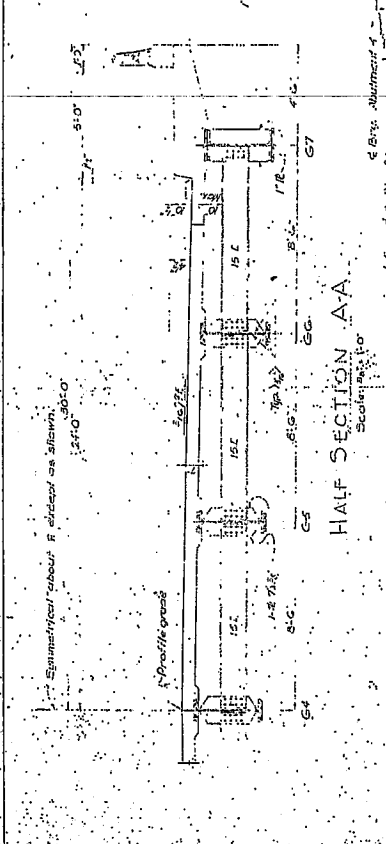

NOTES

- All field connections shall be made with 7/8" dia high strength bolts except as noted.
- Special provisions for framing of structural steel, see Special Provisions.
- Reinforcing steel shall be placed vertically.
- For details of framing details, see Sheet 27.
- For connection of grounding system to structural steel, see Sheet 24.

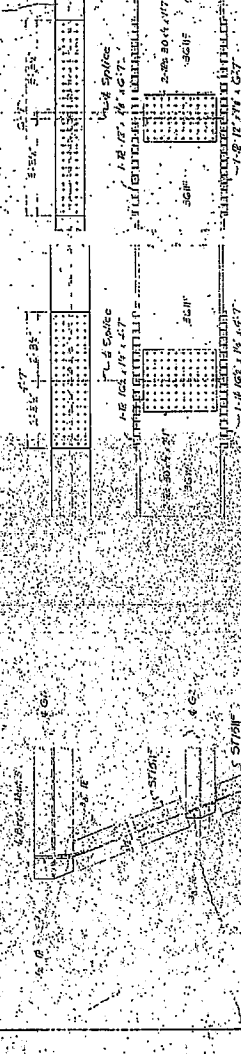
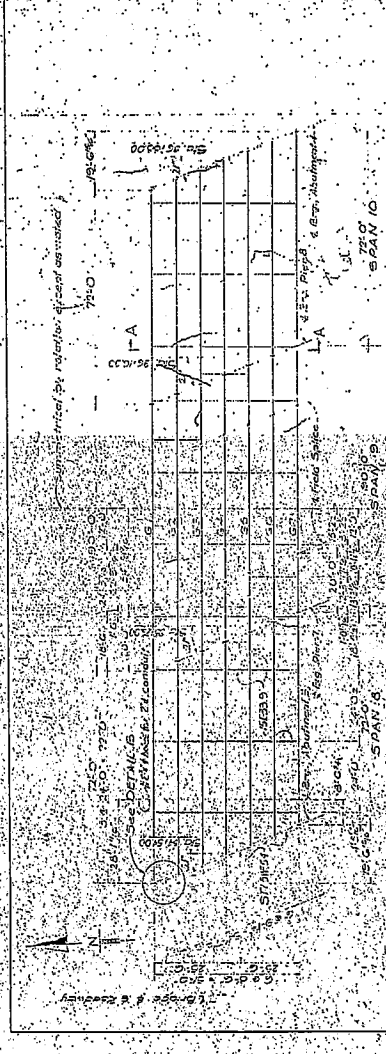

ELEVATION LAYOUT - DIMENSIONS (FEET)

SECTION	SPAN	LENGTH	WIDTH	HEIGHT
A	G1	100.0	20.0	15.0
B	G2	100.0	20.0	15.0
C	G3	100.0	20.0	15.0
D	G4	100.0	20.0	15.0
E	G5	100.0	20.0	15.0
F	G6	100.0	20.0	15.0

MAXIMUM MOMENTS, REACTIONS & SHEARS

SECTION	MOMENT (KIP-FT)	REACTION (KIP)	SHEAR (KIP)
A	1000	100	50
B	1000	100	50
C	1000	100	50
D	1000	100	50
E	1000	100	50
F	1000	100	50



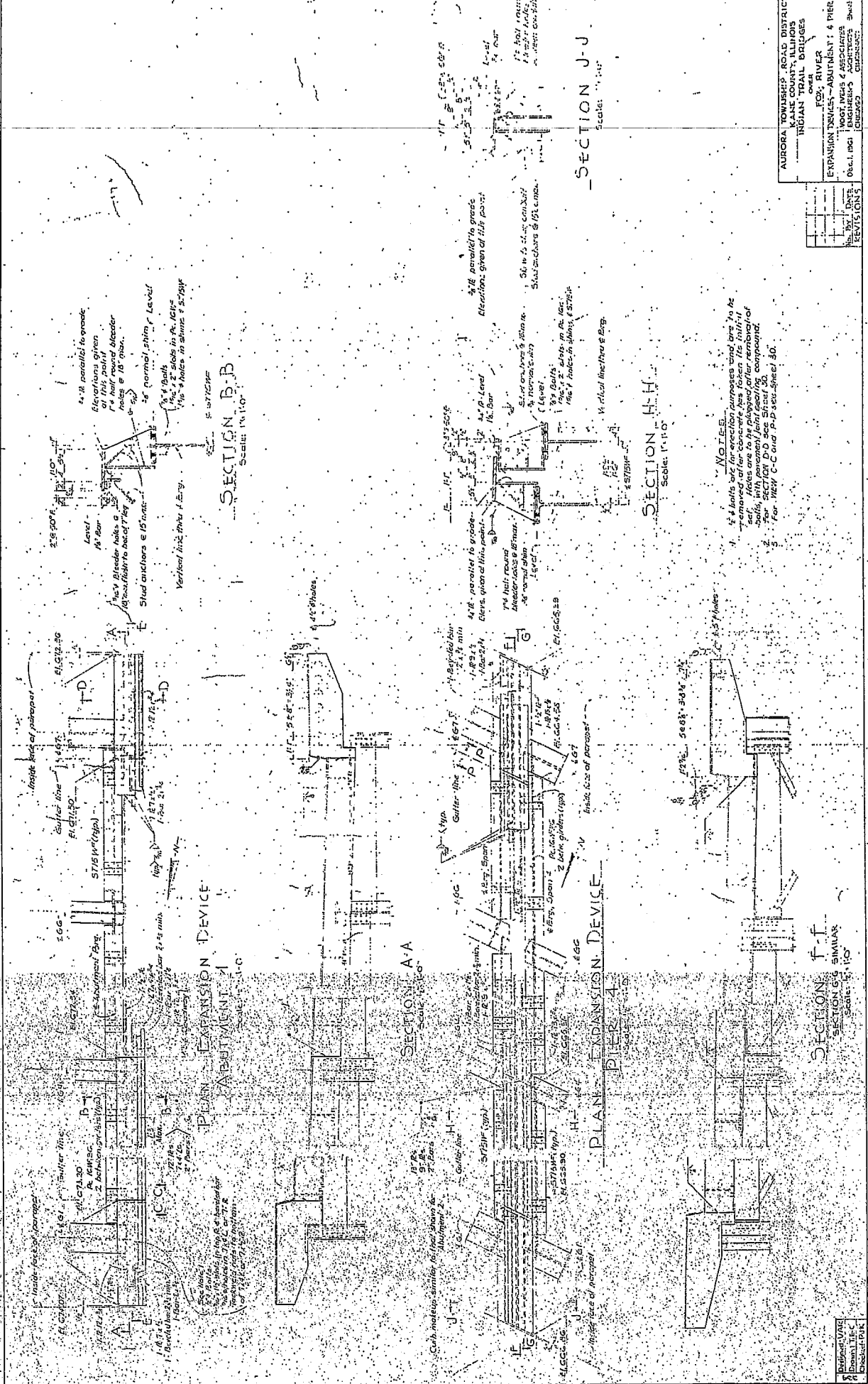

AURORA TOWNSHIP - ROAD DISTRICT
KANE COUNTY, ILLINOIS
INDIAN TRAIL BRIDGES
FOX RIVER
EXPANSION DEVICES - ABUTMENT : 4 PIER :
WOOD, MEAS & ASSOCIATES
06.1.1961
ENGINEERS ARCHITECTS SURVEYORS
CHICAGO, ILL.

1. 4 bolts per WOTER
2. removed all for concrete and are to be
3. ties are to be plugged after removal of
4. bolts with nonmetal joint sealant compound
5. For NEW C-C and P-D see Sheet 30.

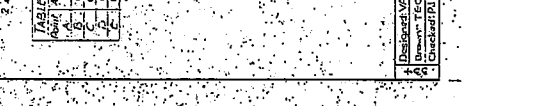
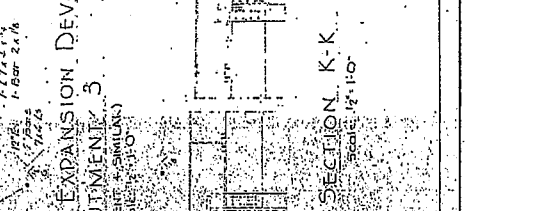
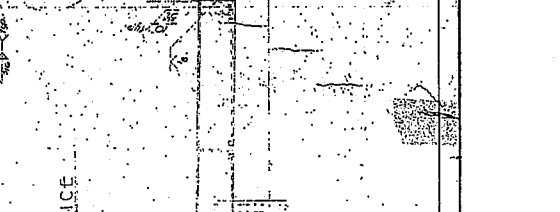
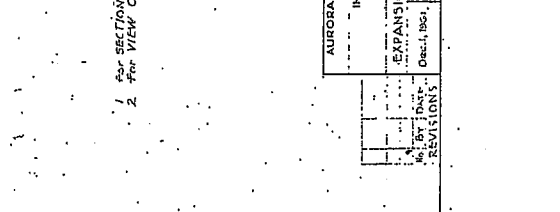
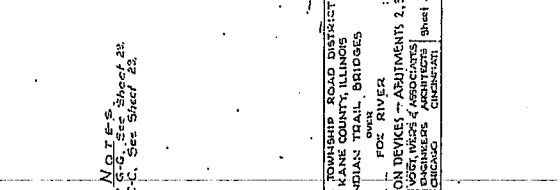
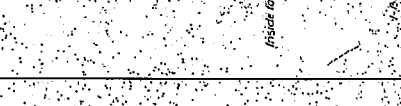
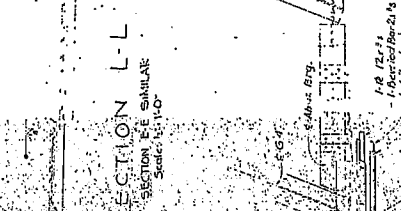
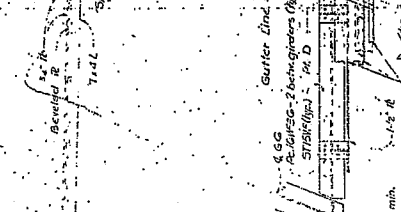
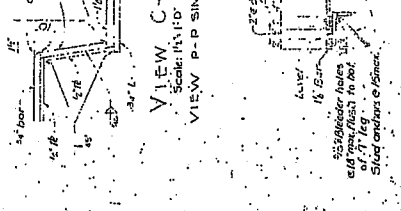
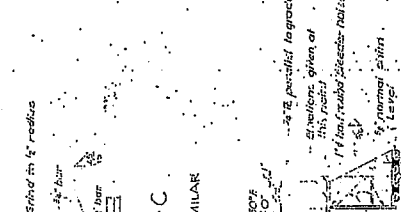
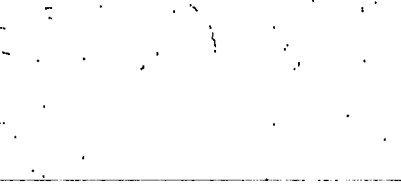
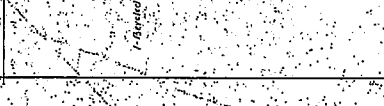
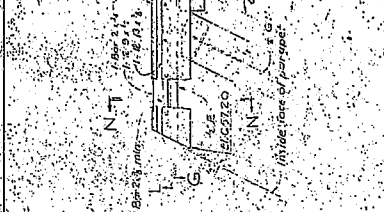
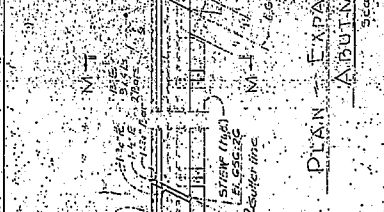
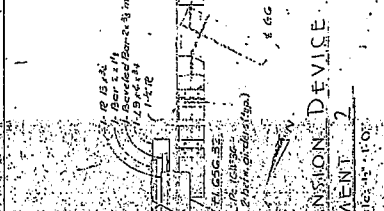
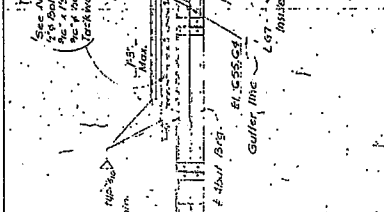
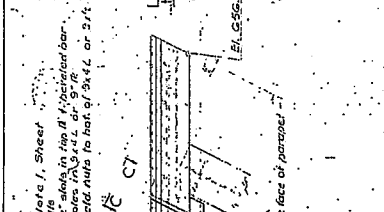
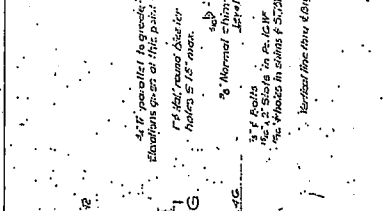
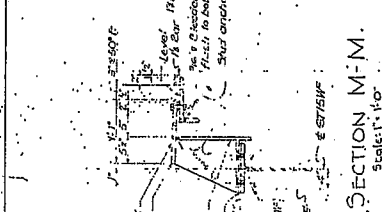
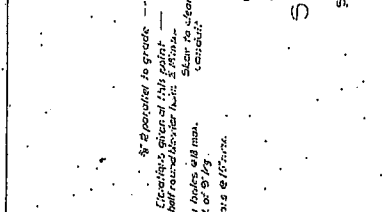
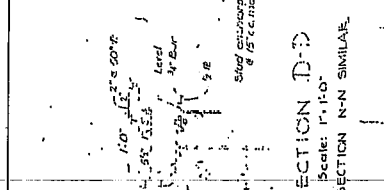
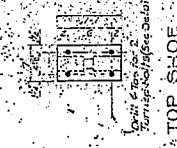

TABLE OF ELEVATIONS:

Point	Elevation
A	100.00
B	100.00
C	100.00
D	100.00
E	100.00
F	100.00
G	100.00
H	100.00
I	100.00
J	100.00
K	100.00
L	100.00
M	100.00
N	100.00
O	100.00
P	100.00
Q	100.00
R	100.00
S	100.00
T	100.00
U	100.00
V	100.00
W	100.00
X	100.00
Y	100.00
Z	100.00

AURORA TOWNSHIP ROAD DISTRICT
KANE COUNTY, ILLINOIS
INDIAN TRAIL BRIDGES
FOX RIVER
EXPANSION DEVICE - ABUTMENT 2, 3 & 4
W. W. HARRIS & ASSOCIATES
ENGINEERS ARCHITECTS
Dec. 1, 1951
CHICAGO, ILL.
REVISED
Sheet 30

224



SECTION A-A
TOP SHOE

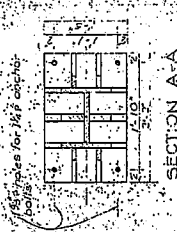

SECTION B-B
TOP SHOE

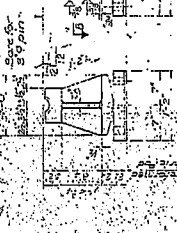

SECTION C-C
TOP SHOE

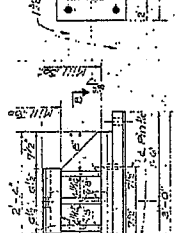

SECTION D-D
TOP SHOE

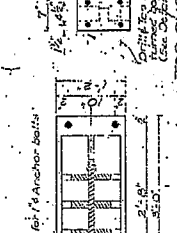

SECTION E-E
TOP SHOE

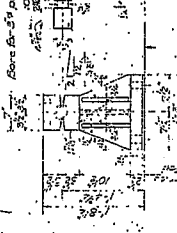

SECTION F-F
TOP SHOE

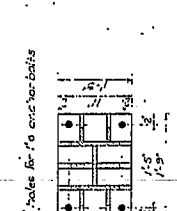

SECTION G-G
TOP SHOE

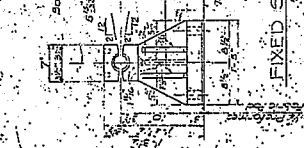

EXPANSION SHOES AT PIER 6 (7 REAR)
Scale: 1" = 1'-0"

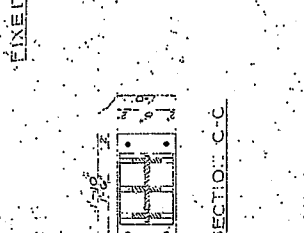

EXPANSION SHOES AT PIER 4 SPANS
AND ABUT. 2 (14 REAR)
Scale: 1" = 1'-0"

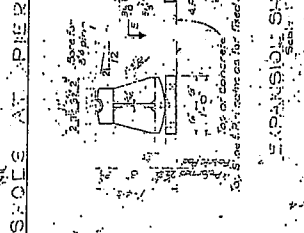

EXPANSION SHOES AT PIER 5 (7 REAR)
Scale: 1" = 1'-0"

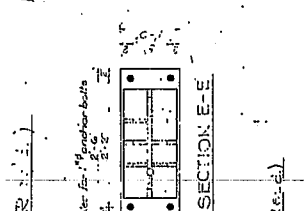

EXPANSION SHOES AT PIERS 1, 2, 3, 4, 8 (4 REAR)
Scale: 1" = 1'-0"



EXPANSION SHOES AT ABUT. 1, PIER 4, ABUT. 3 (4 REAR)
Scale: 1" = 1'-0"

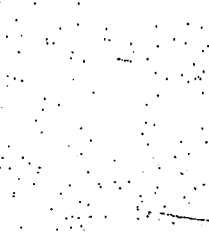

EXPANSION SHOES AT ABUT. 1, PIER 4, ABUT. 3 (4 REAR)
Scale: 1" = 1'-0"

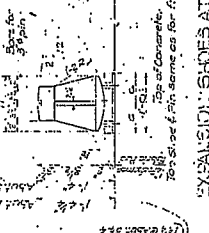

EXPANSION SHOES AT ABUT. 1, PIER 4, ABUT. 3 (4 REAR)
Scale: 1" = 1'-0"

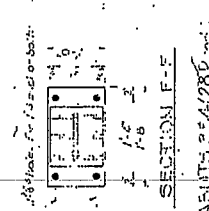

EXPANSION SHOES AT ABUT. 1, PIER 4, ABUT. 3 (4 REAR)
Scale: 1" = 1'-0"

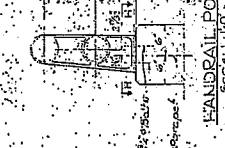

HANDRAIL POST
Scale: 1" = 1'-0"

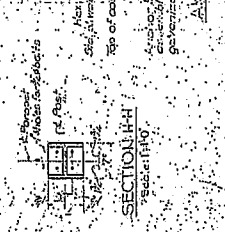

ANCHOR BOLT
Scale: 1" = 1'-0"

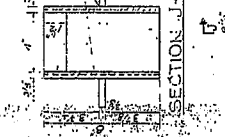

PINTLE

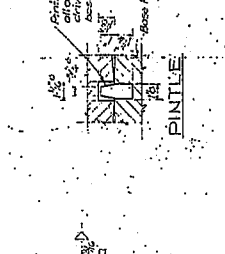

SECTION J-J

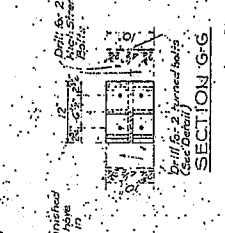

SECTION K-K

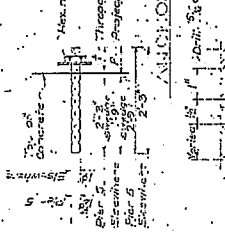

SECTION L-L

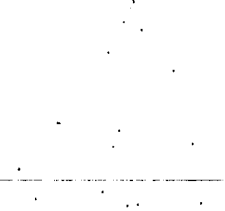

SECTION M-M

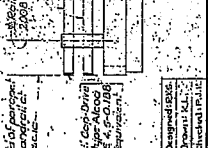

ELEVATION
HANDRAIL DETAILS
Scale: 3/8" = 1'-0"

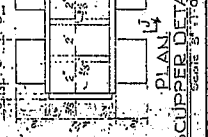

PLAN
SCUPPER DETAILS
Scale: 1" = 1'-0"

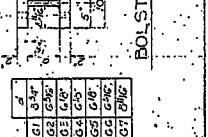

SECTION G-G

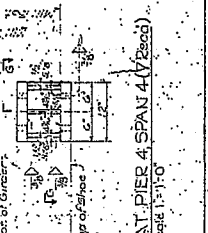

SECTION H-H

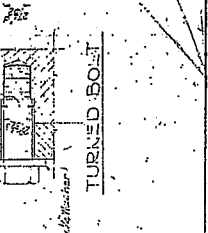

SECTION I-I

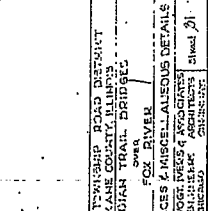

SECTION J-J

61	3/4"	10
62	3/4"	10
63	3/4"	10
64	3/4"	10
65	3/4"	10
66	3/4"	10
67	3/4"	10

POSTER AT PIER 4 SPAN 4 (7 REAR)
Scale: 1" = 1'-0"

APPROX. TRAVELING ROAD DISTANCE	
FROM: PIER 4 APPROXIMATE	11.1
TO: INDIAN TRAIL BRIDGE	11.1
OVER FOX RIVER	
BEARING DETAILS & MISCELLANEOUS DETAILS	
DATE: 1908	Sheet 31
DESIGNED BY: [Name]	CHECKED BY: [Name]

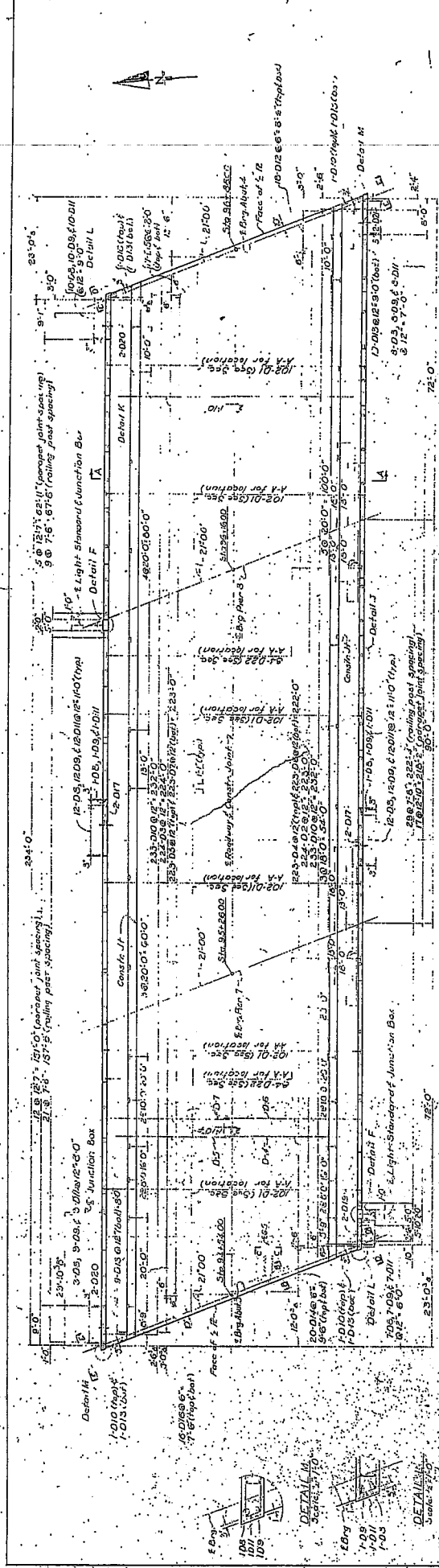

- NOTES**
1. For Top of Slab Elevations see Sh. 3.
 2. For Vertical Curvature see Sh. 3.
 3. For Horizontal Curvature see Sh. 3.
 4. For Light Standard and Junction Bar Details see Sh. 3.
 5. For Reinforcement Details see Sh. 3.
 6. For Support Details see Sh. 3.
 7. For Transverse Reinforcement see Sh. 3.
 8. Transverse reinforcement steel which intersects with scuppers shall be full in length.

SLAB PLAN
Scale: 1/4" = 1'-0"

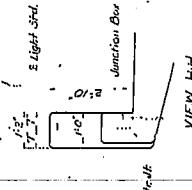

VIEW A-H
Scale: 1/4" = 1'-0"

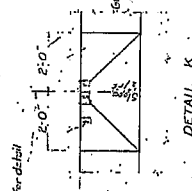

DETAIL L
Scale: 1/4" = 1'-0"

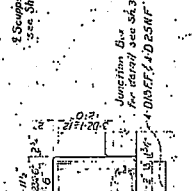

VIEW G-G
Scale: 1/4" = 1'-0"

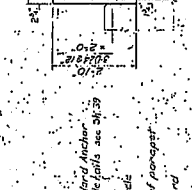

DETAIL F
Scale: 1/4" = 1'-0"

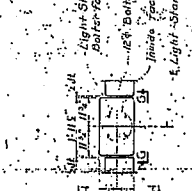

VIEW D-D
Scale: 1/4" = 1'-0"

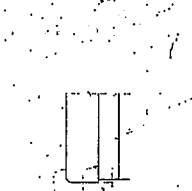

VIEW E-E
Scale: 1/4" = 1'-0"

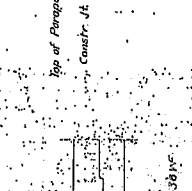

SECTION C-C
Scale: 1/4" = 1'-0"

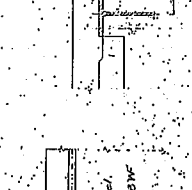

SECTION B-B
Scale: 1/4" = 1'-0"

AURORA TOWNSHIP ROAD DISTRICT
MANK COUNTY, ILLINOIS
INDIAN BRIDGES
FOX, PETER
FLOOR SLAB - SPANS 0.9 1.0
DESIGNED BY ARCHITECTS
CHECKED BY ARCHITECTS
SHEET 31

NO.	DATE	REVISIONS

DESIGNED BY
CHECKED BY

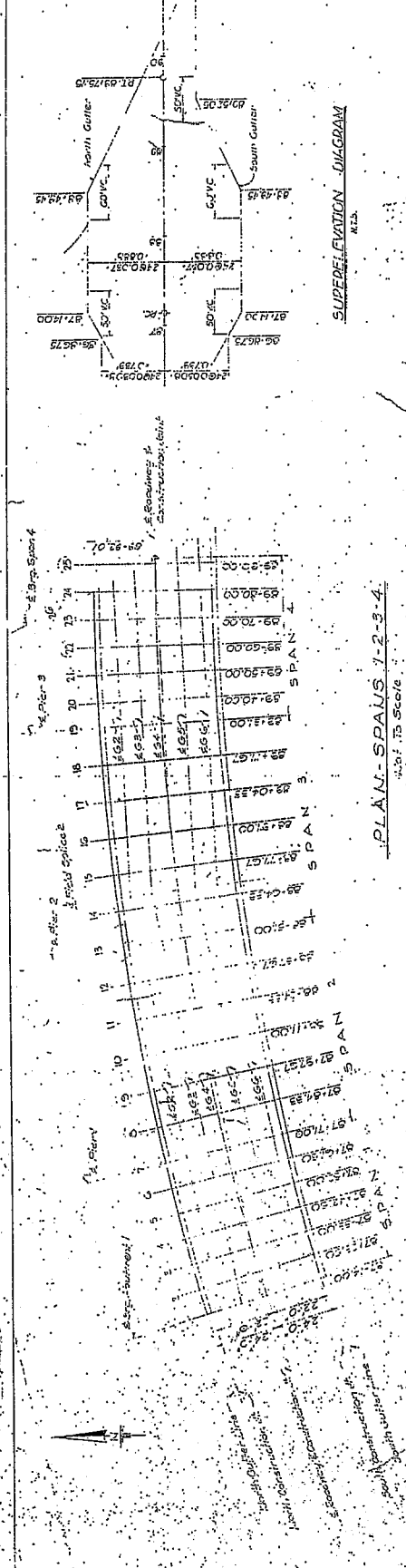

PLAN - SPANS 1-2-3-4
Scale 1/8" = 1'-0"

FLOOR SLAB ELEVATIONS

Station	North Construction Joint		Gutter Line		South Construction Joint		South Gutter Line	
	Fin. Elev.	Form Elev.	Fin. Elev.	Form Elev.	Fin. Elev.	Form Elev.	Fin. Elev.	Form Elev.
57+14.00	672.67	672.67	672.67	672.67	672.67	672.67	672.67	672.67
57+16.00	672.67	672.67	672.67	672.67	672.67	672.67	672.67	672.67
57+18.00	672.67	672.67	672.67	672.67	672.67	672.67	672.67	672.67
57+20.00	672.67	672.67	672.67	672.67	672.67	672.67	672.67	672.67
57+22.00	672.67	672.67	672.67	672.67	672.67	672.67	672.67	672.67
57+24.00	672.67	672.67	672.67	672.67	672.67	672.67	672.67	672.67
57+26.00	672.67	672.67	672.67	672.67	672.67	672.67	672.67	672.67
57+28.00	672.67	672.67	672.67	672.67	672.67	672.67	672.67	672.67
57+30.00	672.67	672.67	672.67	672.67	672.67	672.67	672.67	672.67
57+32.00	672.67	672.67	672.67	672.67	672.67	672.67	672.67	672.67
57+34.00	672.67	672.67	672.67	672.67	672.67	672.67	672.67	672.67
57+36.00	672.67	672.67	672.67	672.67	672.67	672.67	672.67	672.67
57+38.00	672.67	672.67	672.67	672.67	672.67	672.67	672.67	672.67
57+40.00	672.67	672.67	672.67	672.67	672.67	672.67	672.67	672.67
57+42.00	672.67	672.67	672.67	672.67	672.67	672.67	672.67	672.67
57+44.00	672.67	672.67	672.67	672.67	672.67	672.67	672.67	672.67
57+46.00	672.67	672.67	672.67	672.67	672.67	672.67	672.67	672.67
57+48.00	672.67	672.67	672.67	672.67	672.67	672.67	672.67	672.67
57+50.00	672.67	672.67	672.67	672.67	672.67	672.67	672.67	672.67
57+52.00	672.67	672.67	672.67	672.67	672.67	672.67	672.67	672.67
57+54.00	672.67	672.67	672.67	672.67	672.67	672.67	672.67	672.67
57+56.00	672.67	672.67	672.67	672.67	672.67	672.67	672.67	672.67
57+58.00	672.67	672.67	672.67	672.67	672.67	672.67	672.67	672.67
57+60.00	672.67	672.67	672.67	672.67	672.67	672.67	672.67	672.67
57+62.00	672.67	672.67	672.67	672.67	672.67	672.67	672.67	672.67
57+64.00	672.67	672.67	672.67	672.67	672.67	672.67	672.67	672.67
57+66.00	672.67	672.67	672.67	672.67	672.67	672.67	672.67	672.67
57+68.00	672.67	672.67	672.67	672.67	672.67	672.67	672.67	672.67
57+70.00	672.67	672.67	672.67	672.67	672.67	672.67	672.67	672.67
57+72.00	672.67	672.67	672.67	672.67	672.67	672.67	672.67	672.67
57+74.00	672.67	672.67	672.67	672.67	672.67	672.67	672.67	672.67
57+76.00	672.67	672.67	672.67	672.67	672.67	672.67	672.67	672.67
57+78.00	672.67	672.67	672.67	672.67	672.67	672.67	672.67	672.67
57+80.00	672.67	672.67	672.67	672.67	672.67	672.67	672.67	672.67
57+82.00	672.67	672.67	672.67	672.67	672.67	672.67	672.67	672.67
57+84.00	672.67	672.67	672.67	672.67	672.67	672.67	672.67	672.67
57+86.00	672.67	672.67	672.67	672.67	672.67	672.67	672.67	672.67
57+88.00	672.67	672.67	672.67	672.67	672.67	672.67	672.67	672.67
57+90.00	672.67	672.67	672.67	672.67	672.67	672.67	672.67	672.67
57+92.00	672.67	672.67	672.67	672.67	672.67	672.67	672.67	672.67
57+94.00	672.67	672.67	672.67	672.67	672.67	672.67	672.67	672.67
57+96.00	672.67	672.67	672.67	672.67	672.67	672.67	672.67	672.67
57+98.00	672.67	672.67	672.67	672.67	672.67	672.67	672.67	672.67
58+00.00	672.67	672.67	672.67	672.67	672.67	672.67	672.67	672.67

NOTES:
 1. The lowest finished ground elevations shown in the table have been computed for the design area only. All other elevations are shown for the purpose of construction of any concrete structure.
 2. Consideration shall be given to the definition of the term "finished ground" as shown on the floor plan in order to obtain the floor thickness shown on the plans.
 3. (Adjusted for Deck Load Deflection)

AURORA TOWNSHIP ROAD DISTRICT
 KANE COUNTY, ILLINOIS
 LOCAL TRAIL BRIDGES
 FOX RIVER
 PROJECT NO. 1008
 DRAWN BY: [Name]
 CHECKED BY: [Name]
 DATE: [Date]
 SHEET NO. 1008-1-100

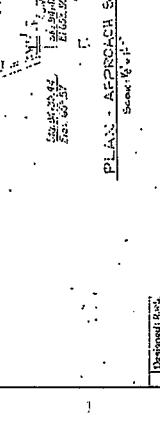
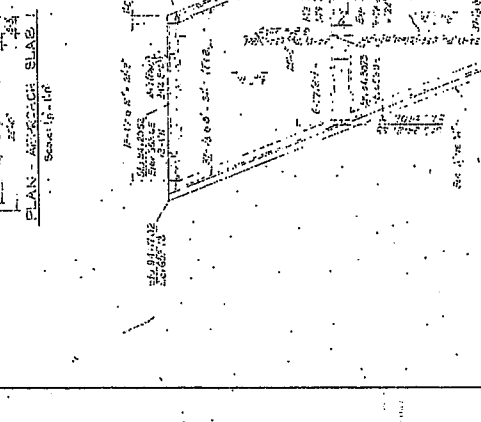
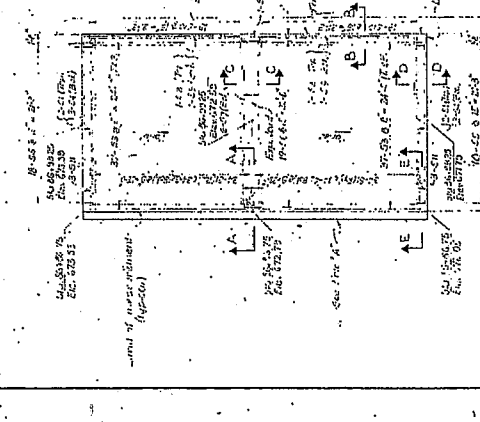
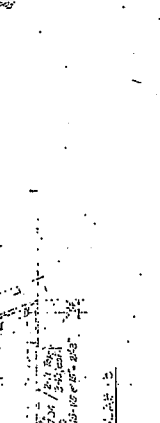
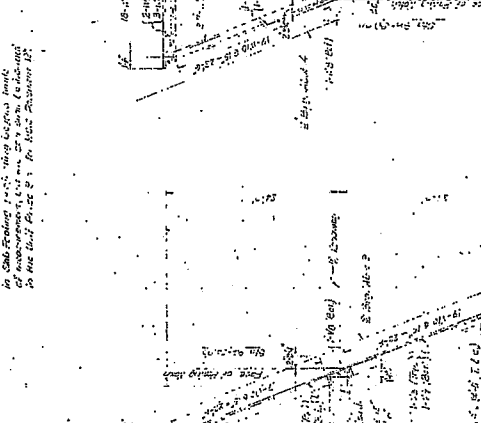
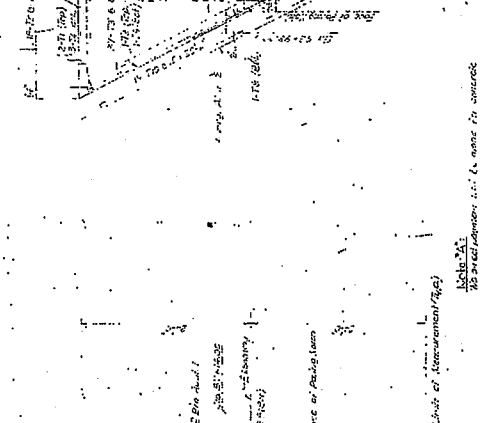
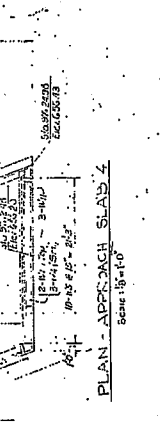
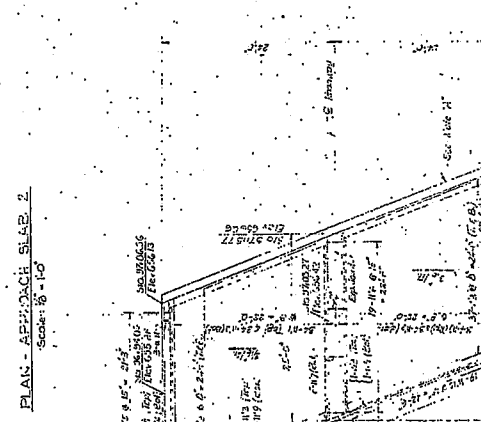
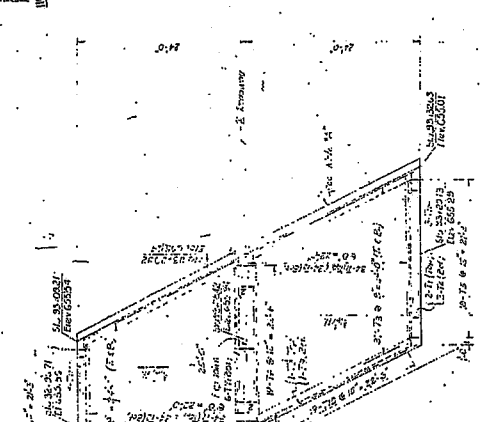
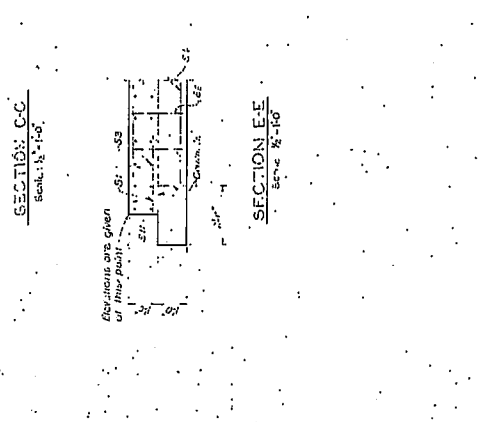
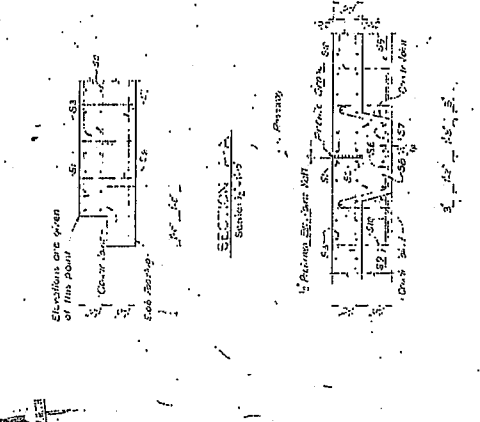
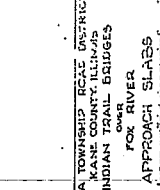
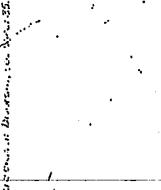
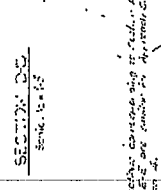
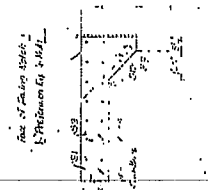

AURORA TOWNSHIP DISTRICT
 KANE COUNTY ILLINOIS
 INDIAN TRAIL BRIDGES
 FOX RIVER
 APPROACH SLABS
 DRAWN BY: [Name]
 CHECKED BY: [Name]
 DATE: 1-30-01
 SHEET NO. 5
 OF 5
 CHICAGO
 INDEPENDENT

231

Span No.	Span Length (ft)	Dimensions for Bending	Span No.	Span Length (ft)	Dimensions for Bending	Span No.	Span Length (ft)	Dimensions for Bending
1	10.0	10.0 x 10.0	11	10.0	10.0 x 10.0	21	10.0	10.0 x 10.0
2	10.0	10.0 x 10.0	12	10.0	10.0 x 10.0	22	10.0	10.0 x 10.0
3	10.0	10.0 x 10.0	13	10.0	10.0 x 10.0	23	10.0	10.0 x 10.0
4	10.0	10.0 x 10.0	14	10.0	10.0 x 10.0	24	10.0	10.0 x 10.0
5	10.0	10.0 x 10.0	15	10.0	10.0 x 10.0	25	10.0	10.0 x 10.0
6	10.0	10.0 x 10.0	16	10.0	10.0 x 10.0	26	10.0	10.0 x 10.0
7	10.0	10.0 x 10.0	17	10.0	10.0 x 10.0	27	10.0	10.0 x 10.0
8	10.0	10.0 x 10.0	18	10.0	10.0 x 10.0	28	10.0	10.0 x 10.0
9	10.0	10.0 x 10.0	19	10.0	10.0 x 10.0	29	10.0	10.0 x 10.0
10	10.0	10.0 x 10.0	20	10.0	10.0 x 10.0	30	10.0	10.0 x 10.0

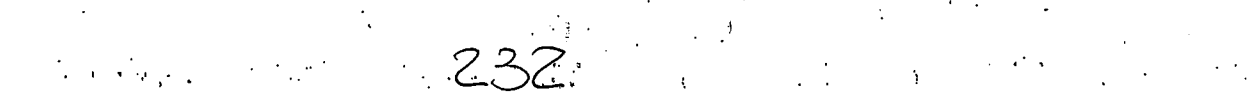

NOTES:
 1. All beams to be in A.C.I. recommendations.
 2. All dimensions are out to center of bar.
 3. One story - finished on bearing wall.
 4. Reduce distribution F. to out side of bar.

AURORA TOWNSHIP ROAD DISTRICT LAKE COUNTY, ILLINOIS
INDIAN TRAIL BRIDGES
FOX RIVER
REINFORCEMENT BAR LIST
FOOTNOTES & ASSOCIATED ENGINEERS & ARCHITECTS INCORPORATED CHICAGO, ILLINOIS
DESIGNED BY
CHECKED BY
DATE
PROJECT NO.

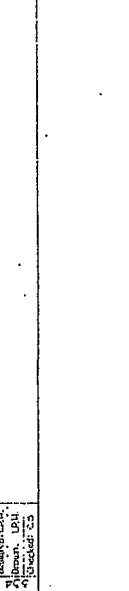
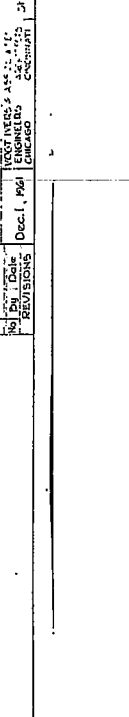
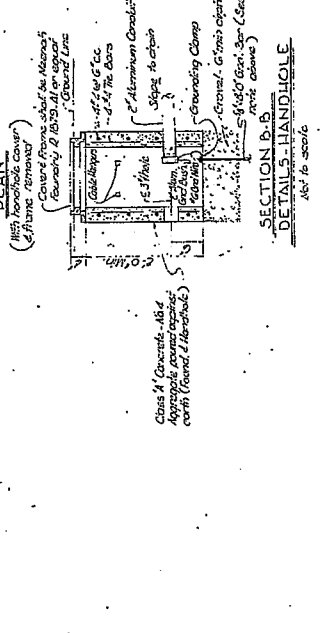
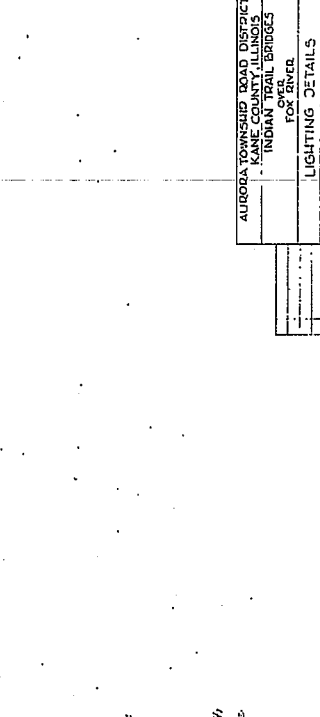
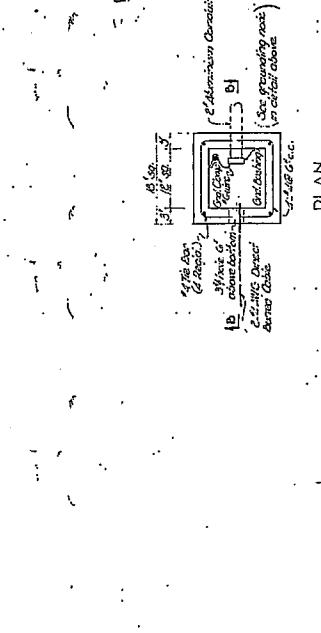
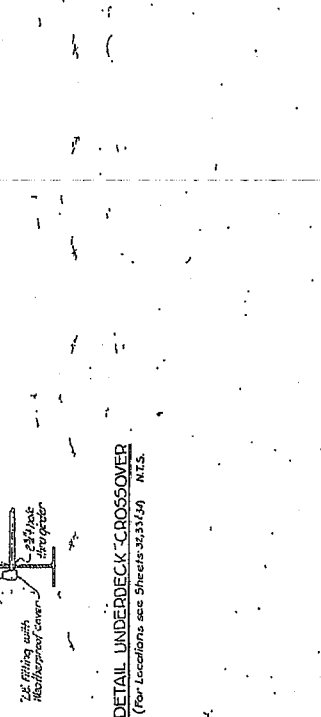
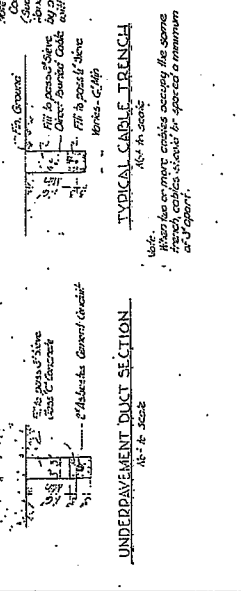
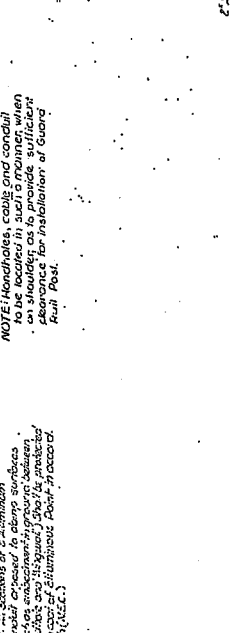
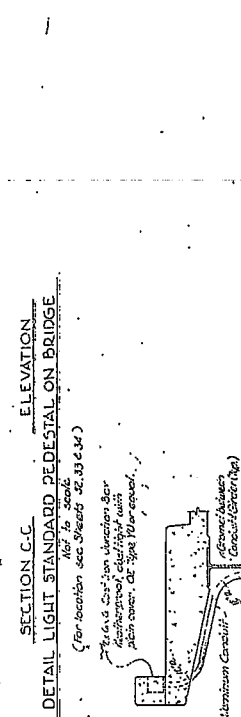
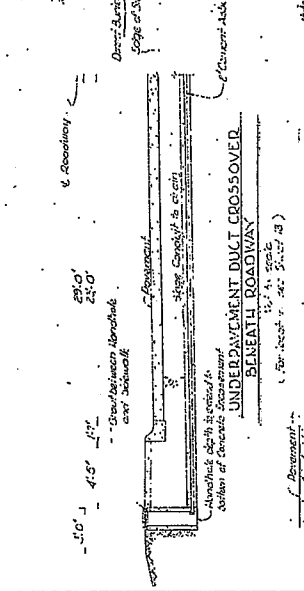
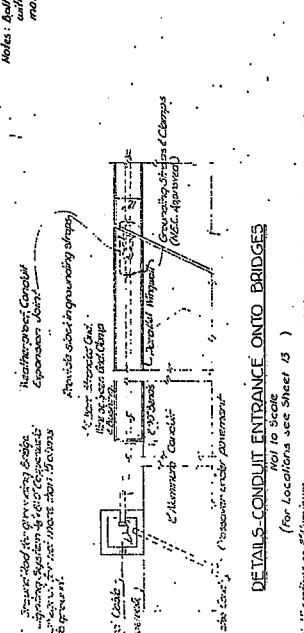
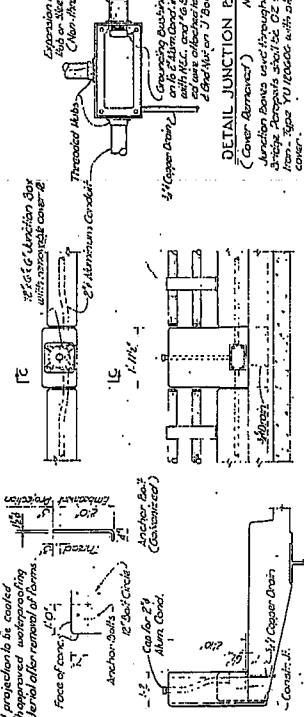

AURORA TOWNSHIP ROAD DISTRICT
 KANE COUNTY, ILLINOIS
 INDIAN TRAIL BRIDGES
 OVER FOX RIVER
 LIGHTING DETAILS
 DRAWING NO. 22-117
 DATE 11/11/11
 CHECKED BY [Signature]
 DESIGNED BY [Signature]

REVISIONS

No.	Date	Description

233

STANDARD SYMBOLS

THESE SYMBOLS AND ABBREVIATIONS ARE USED THROUGHOUT THESE PLANS UNLESS OTHERWISE NOTED

- State Line
- County Line
- City, Village or Town Limits
- Section or Grant Line
- Unenclosed Property Line
- Fence Line
- Expansion Joint
- Retaining Wall
- Base or Survey Line
- Conduit to be Constructed
- Conduit with Drop Inlet
- Manhole
- Trunk
- Stream
- Tracked Way
- Storm Sewer (Direction of Flow & Invert Elevation Indicated)
- The Direction of Flow & Invert Elevation Indicated
- Grade Rail
- Stream or Electric Railroad, or Utility Tracks
- Hedge
- Longitudinal Construction Joint
- Existing Pavement, Curb & Gutter, Driveway Pavement & Sidewalk to be Replaced
- Elevation of Surface of Filled-in Pavement at Point Indicated
- Elevation, Top of Curb at Point Indicated
- Elevation of Flow Line of Gutter at Point Indicated
- Existing hole, inlet to be Adjusted, or inlet to be Reconstructed
- Inlet to be Constructed
- Existing Catch Basin, Catch Basin to be Adjusted, or Catch Basin to be Reconstructed
- Catch Basin to be filled with Sand & Connection Blocked with Brick & Mortar
- Existing Manhole, Manhole to be Adjusted, or Manhole to be Reconstructed
- Manhole to be Constructed
- Manhole to be filled with Sand & Connection Blocked with Brick and Mortar
- Existing Valve Vault, Valve Vault to be Adjusted, or Valve Vault to be Reconstructed
- Valve Vault to be Constructed
- Valve Vault to be filled with Sand & Connection Blocked with Brick and Mortar
- Existing Fire Hydrant, or Fire Hydrant to be Adjusted
- Fire Hydrant & Auxiliary Valve to be Moved (Symbol with Letter indicates New Location)
- Existing Light Standard, or Light Standard to be Adjusted
- Light Standard to be Moved (Symbol with Letter indicates New Location)
- Existing Stop & Go Light, or Stop & Go Light to be Adjusted
- Stop & Go Light to be Moved (Symbol with Letter indicates New Location)
- Existing Traffic Sign, or Traffic Sign to be Adjusted
- Traffic Sign to be Moved (Symbol with Letter indicates New Location)
- Existing House Service Box or House Meter Vault, or House Service Box or House Meter Vault to be Adjusted
- House Service Box or House Meter Vault to be Moved (Symbol with Letter indicates New Location)
- Existing Main Service Box or Main Meter Vault, or Main Service Box or Main Meter Vault to be Adjusted
- Main Service Box or Main Meter Vault to be Moved (Symbol with Letter indicates New Location)
- Right of Way Markers

● If it is definitely known that adjustment or reconstruction is required, place A or R inside the symbol.
 If a new casting is required, show the casting number. Use P for open, C for closed lid. Example -
 Catch Basin to be reconstructed with new type 5 frame, open lid (P) 5P.
 ● First character denotes type of structure. Use S for special design. Second character denotes number of frame or grate. Example - Type A manhole with type 1 frame & closed lid (A)-1C

PLAN ABBREVIATIONS

- Trolley Pole
- Telephone or Telegraph Pole
- Power Line Pole
- File beam
- Storm Sewer (Existing)
- Storm Sewer (Size, Length, Type and Material)
- Conduited Metal Pipe
- Catch Basin (Existing)
- Pipe Culvert (Existing)
- Pipe Culvert (Size, Length, Type and Material)
- Pipe Culvert (Size, Length, Type and Material)
- Back to Face of Curb
- Face to Back of Curb
- Center Line to Face of Curb
- Center Line to Back of Curb
- Central Angle
- Radius of Curve
- Tangent Length
- Curve Length
- External Distance
- Superelevation (ft. per ft. of width)
- Point of Curvature
- Point of Intersection
- Point of Tangency
- Point of Compound Curvature
- Point of Reverse Curvature
- Vertical Curve
- External Distance of Vertical Curve
- State Road Issue
- State-aid
- Route
- Station
- Station
- Railroad Point Stake
- Iron Pipe
- Mail & Washer
- Telephone Pole
- Power Pole
- Fence Post
- Fire Hydrant
- Rail Road Spike
- Right of Way
- Invert
- Flow Line
- Summit
- Elevation
- Portland Cement Concrete
- US Geodetic Survey or US Coast & Geodetic Survey
- Federal-aid Secondary
- Motor Fuel Tax
- City Streets
- Project

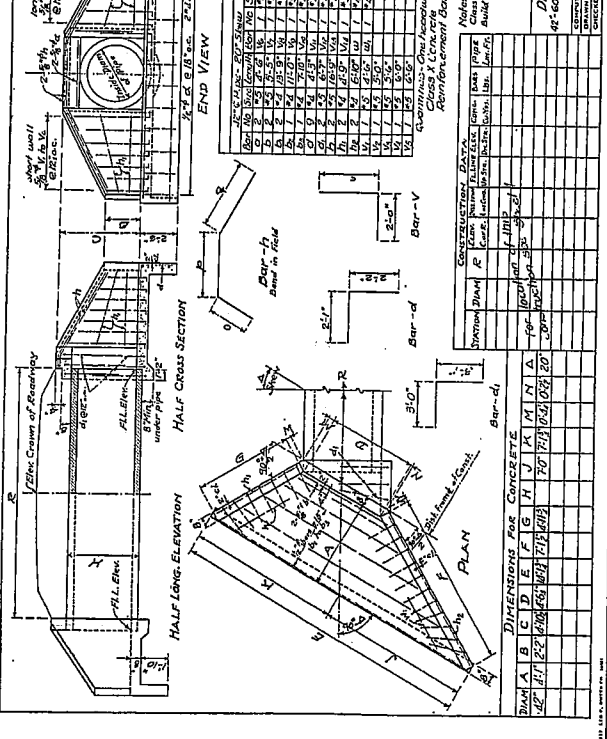
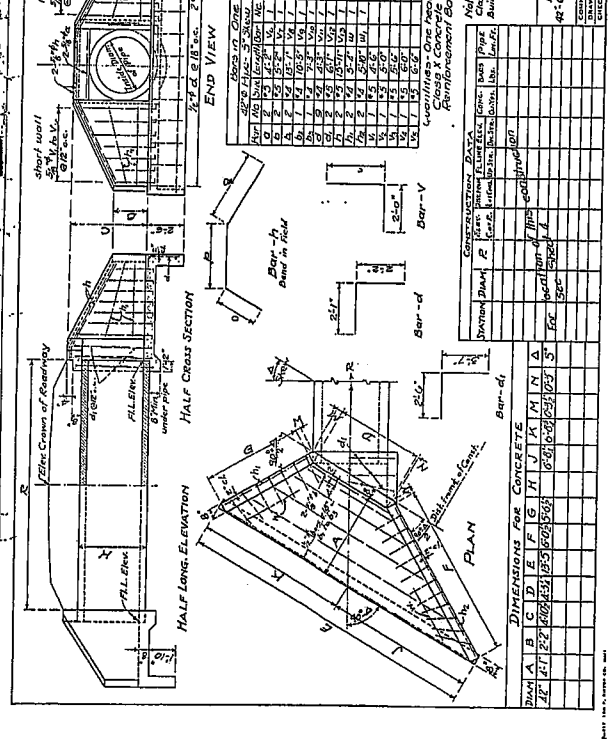

234

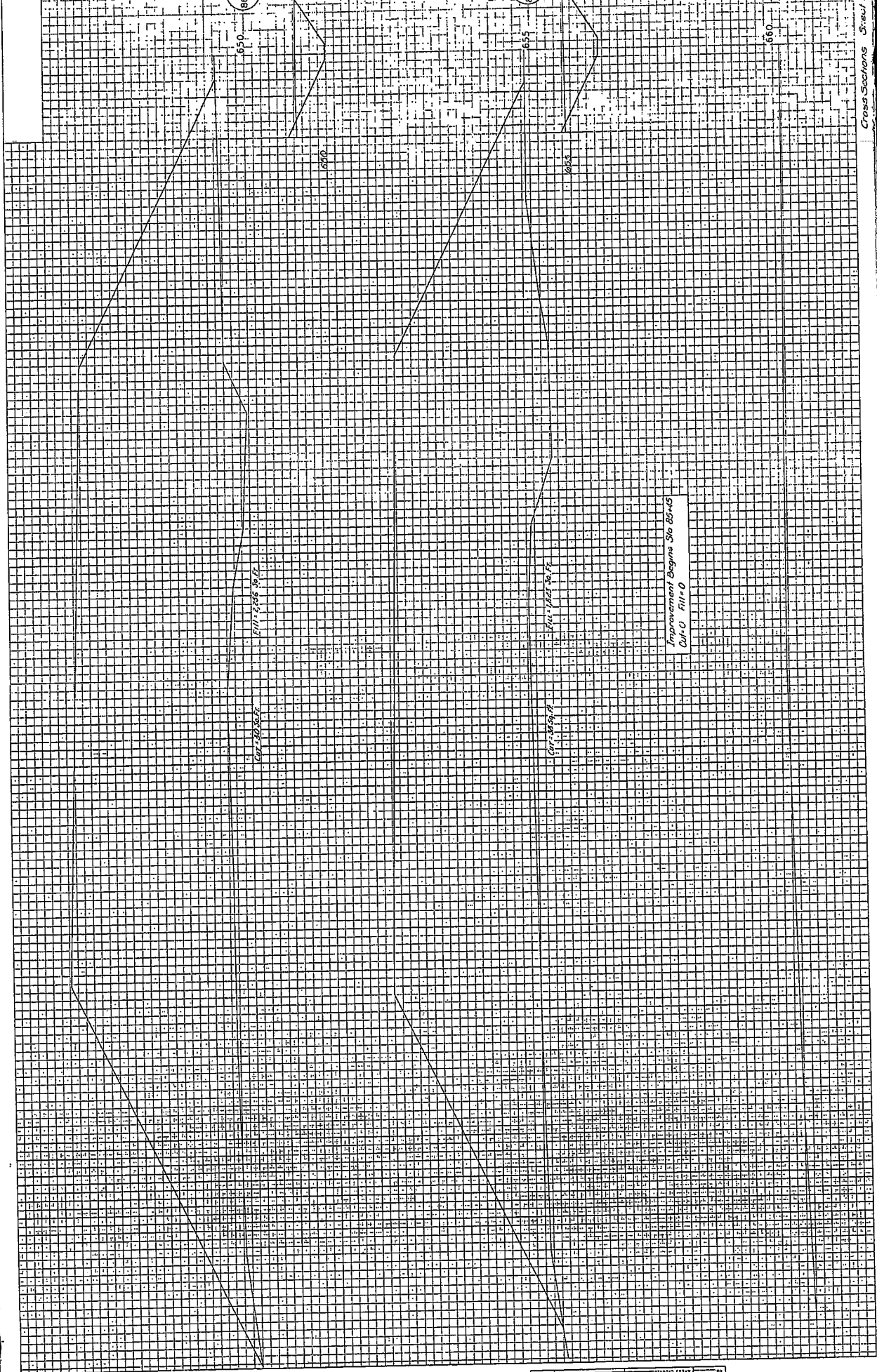

Cross Sections Sheet

NO.	DATE	BY	REVISION

235

NO.	DATE	BY	REVISION

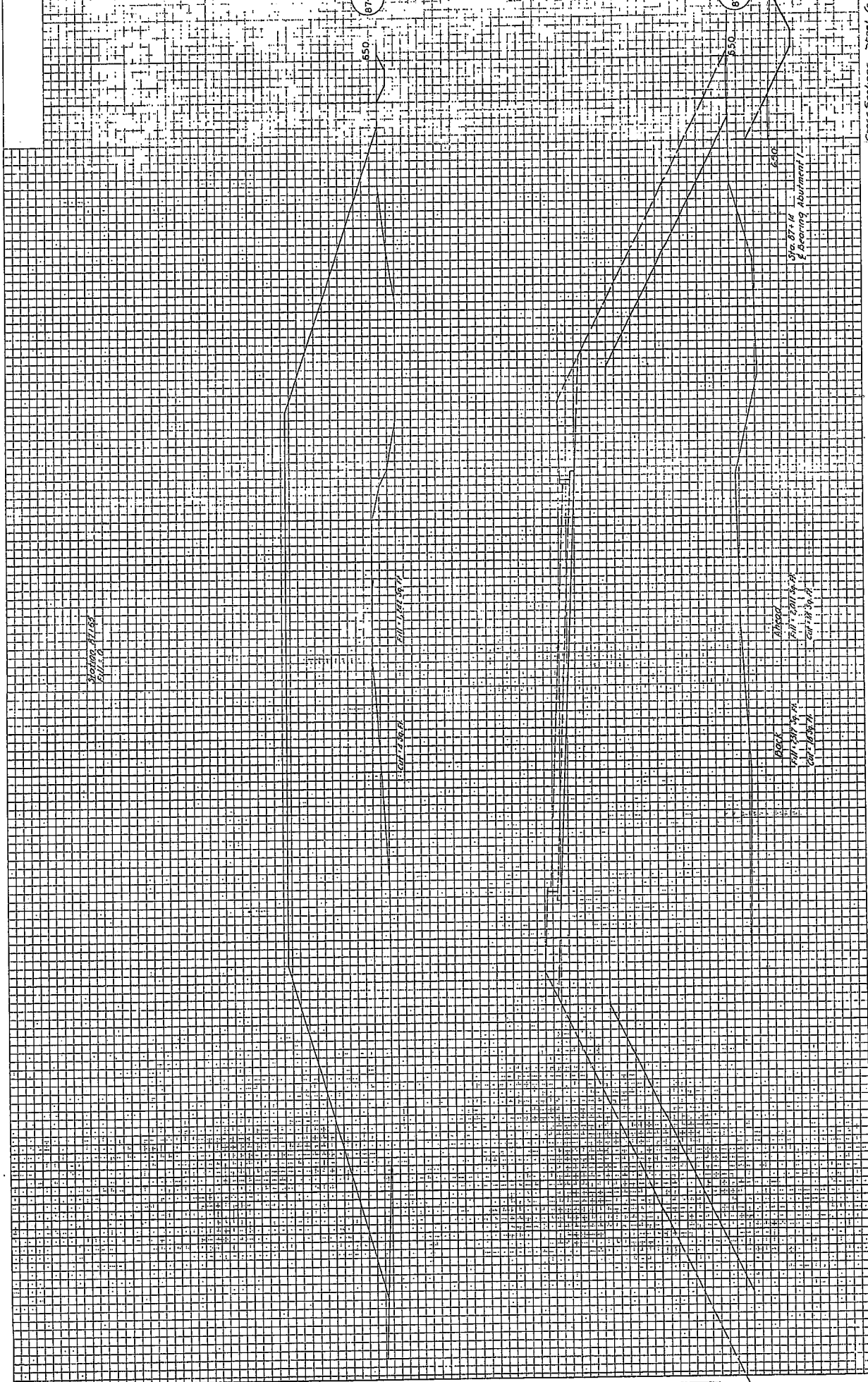

Spec. 871-H

Spec. 871-H

Spec. 871-H

Spec. 871-H

650

650

640

DATE	
BY	
CHECKED	
DESIGNED	
DRAWN	
IN CHARGE	
APPROVED	
DATE	

236

DATE	
BY	
CHECKED	
DESIGNED	
DRAWN	
IN CHARGE	
APPROVED	
DATE	

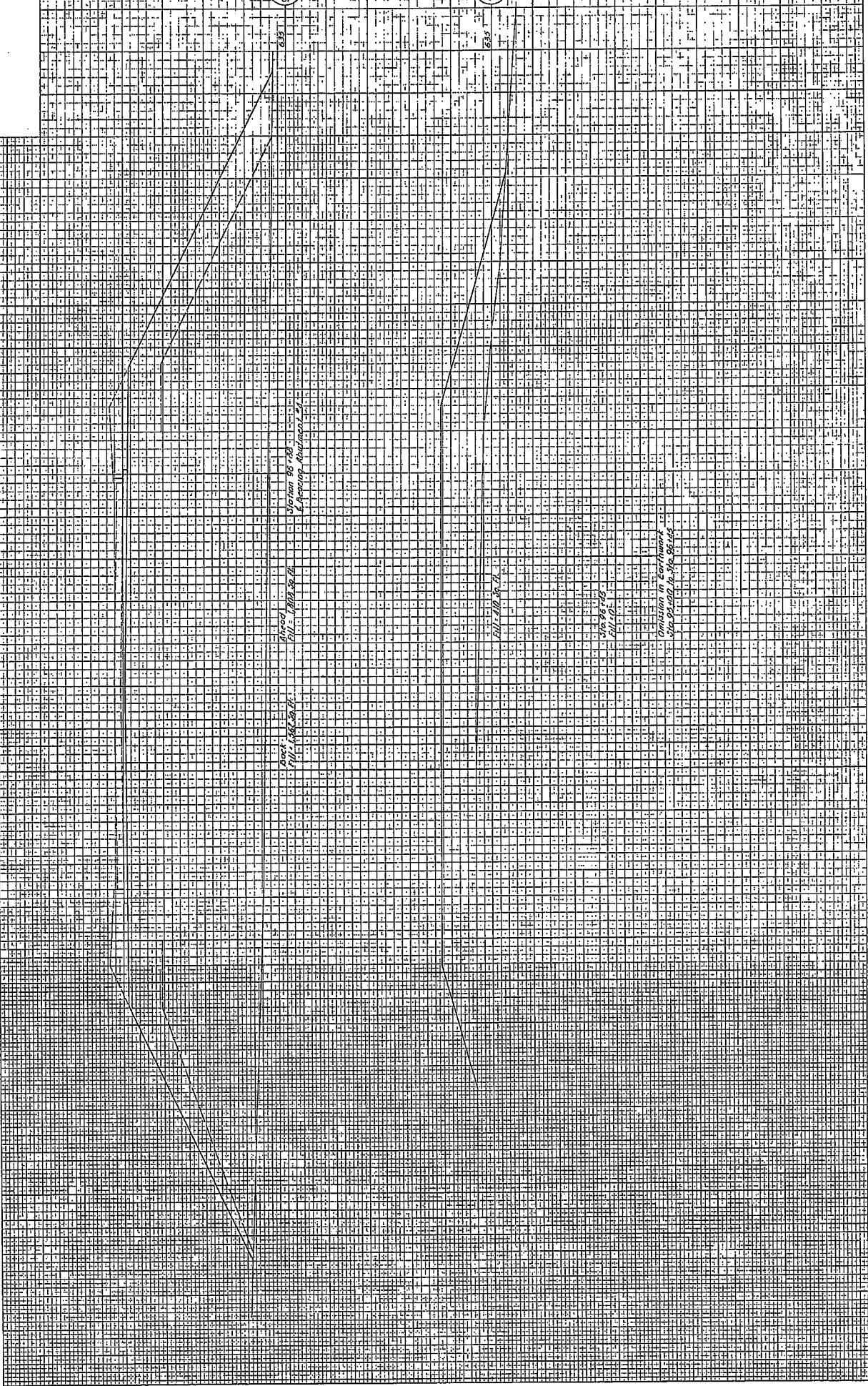

DATE	
DRAWN BY	
CHECKED BY	
DATE	
SCALE	
PROJECT NO.	
DESCRIPTION	
DESIGNED BY	
APPROVED BY	

237

DATE	
DRAWN BY	
CHECKED BY	
DATE	
SCALE	
PROJECT NO.	
DESCRIPTION	
DESIGNED BY	
APPROVED BY	

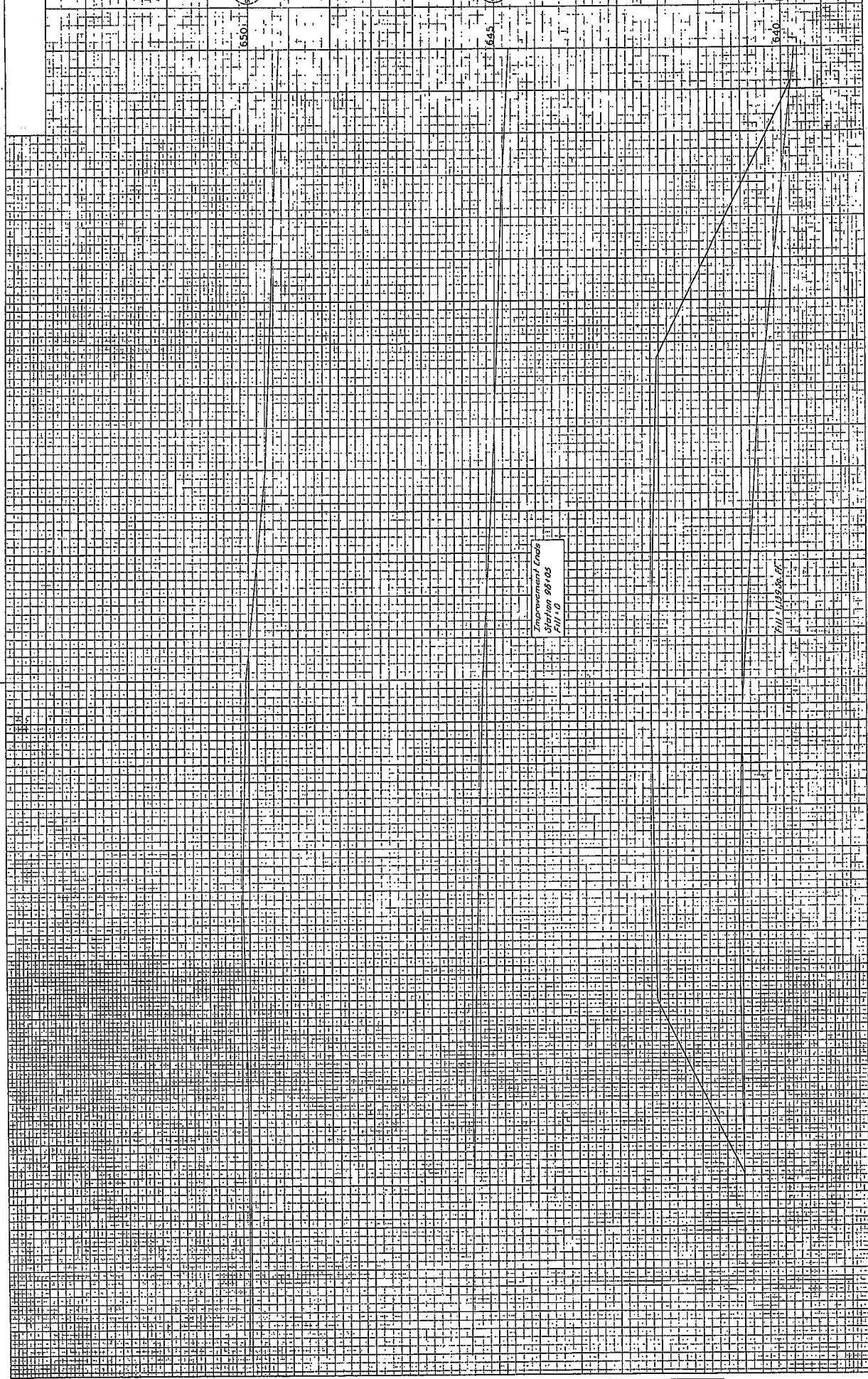

NO.	DATE
1	
2	
3	
4	
5	
6	
7	
8	
9	
10	
11	
12	
13	
14	
15	
16	
17	
18	
19	
20	
21	
22	
23	
24	
25	
26	
27	
28	
29	
30	
31	
32	
33	
34	
35	
36	
37	
38	
39	
40	
41	
42	
43	
44	
45	
46	
47	
48	
49	
50	
51	
52	
53	
54	
55	
56	
57	
58	
59	
60	
61	
62	
63	
64	
65	
66	
67	
68	
69	
70	
71	
72	
73	
74	
75	
76	
77	
78	
79	
80	
81	
82	
83	
84	
85	
86	
87	
88	
89	
90	
91	
92	
93	
94	
95	
96	
97	
98	
99	
100	

238

NO.	DATE
1	
2	
3	
4	
5	
6	
7	
8	
9	
10	
11	
12	
13	
14	
15	
16	
17	
18	
19	
20	
21	
22	
23	
24	
25	
26	
27	
28	
29	
30	
31	
32	
33	
34	
35	
36	
37	
38	
39	
40	
41	
42	
43	
44	
45	
46	
47	
48	
49	
50	
51	
52	
53	
54	
55	
56	
57	
58	
59	
60	
61	
62	
63	
64	
65	
66	
67	
68	
69	
70	
71	
72	
73	
74	
75	
76	
77	
78	
79	
80	
81	
82	
83	
84	
85	
86	
87	
88	
89	
90	
91	
92	
93	
94	
95	
96	
97	
98	
99	
100	

LIGHTING SYMBOLS

- Wiring in Conduit
- Light Standard Location
- Manhole
- Junction Box

LIGHTING NOTES

For Lighting Details see Sh. 39
 For Conduits thru Grades see Framing Plans, Sheets 25, 27 and 28.
 For Location see Slope Plans, Sheets 22, 23 and 24.

GENERAL NOTES

SPECIFICATIONS

Standard Specifications for Road and Bridge Construction, State of Illinois, 1950 Edition and Special Provisions for Highway Bridges, The American Association of State Highway Engineers, Inc., 1950 Edition. The Standard Specifications for Highway Bridges, American Institute of Steel Construction, Inc., 1950 Edition. The Standard Specifications for Highway Bridges, American Institute of Steel Construction, Inc., 1950 Edition. The Standard Specifications for Highway Bridges, American Institute of Steel Construction, Inc., 1950 Edition.

LOADINGS

Live Load - HS 20 (16 kips) except four feet wide loads - HS 20 (16 kips) in contact with a single wheel, in addition to the dead load. The live load shall be applied to the bridge in such a manner as to produce the most unfavorable stresses.

CONSTRUCTION

When connections for structural steel are shown as shown on the plans, they shall be made with bolts as shown on the plans. All connections shall be made with bolts and nuts of the same grade as the steel to which they are attached. All bolts and nuts shall be galvanized.

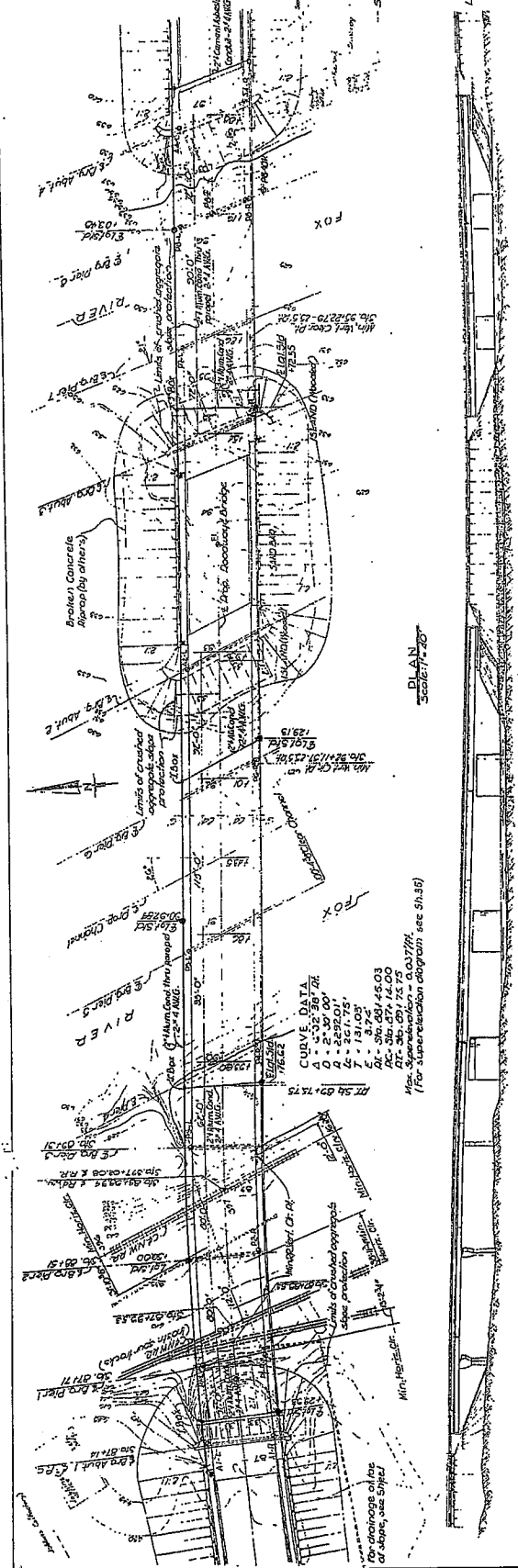

CURVE DATA

A = 532.89' R.
 Δ = 242.01'
 L = 267.75'
 T = 131.02'
 P = 56.681' ΔS.03
 AC = 56.677' ΔS.00
 Max. Superelevation = 0.03771
 (For super-elevation diagram see Sh. 35)

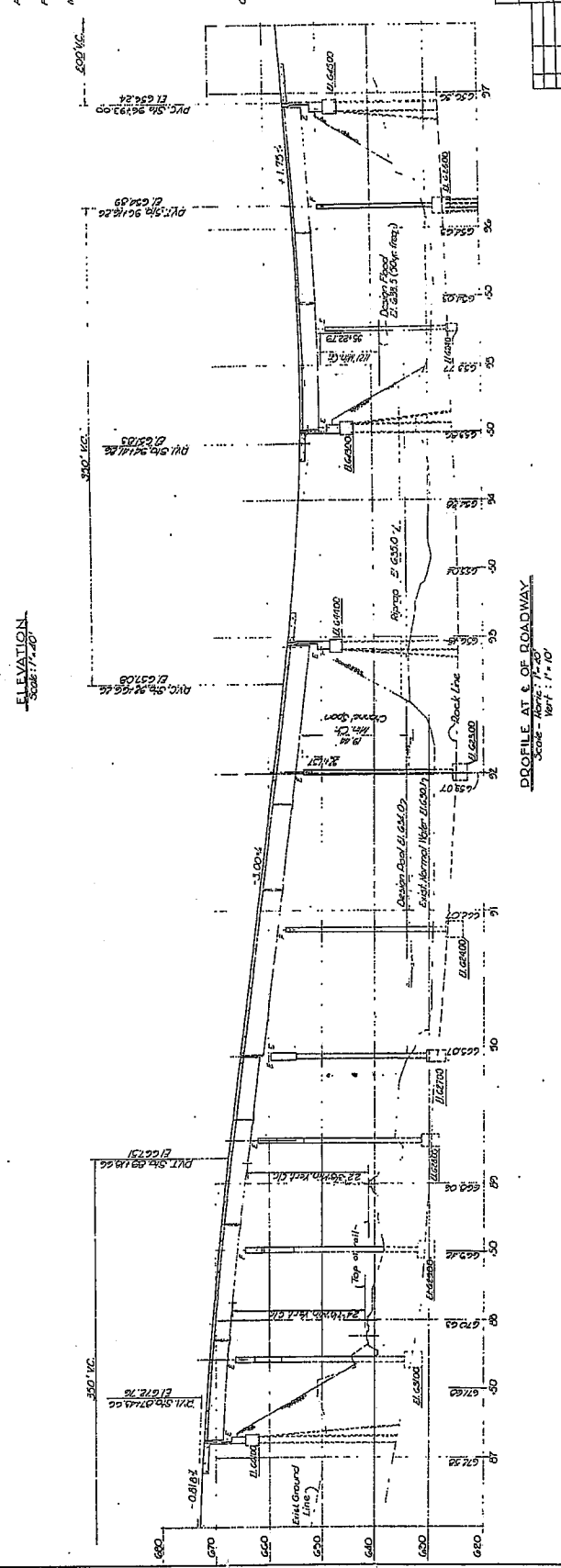

PROFILE AT & OF ROADWAY
 Scale: 1/4" = 1'-0"

GENERAL PLAN, ELEVATION & PROFILE

DESIGNED BY: [Name]
 DRAWN BY: [Name]
 CHECKED BY: [Name]
 DATE: [Date]

NO.	BY	DATE	REVISIONS

REVISIONS

DESIGNED BY: [Name]
DRAWN BY: [Name]
CHECKED BY: [Name]
DATE: [Date]

PROJECT: [Name]
LOCATION: [Name]

SCALE: [Name]

DATE: [Name]

BY: [Name]

CHECKED BY: [Name]

DATE: [Name]

PROJECT: [Name]

LOCATION: [Name]

SCALE: [Name]

BY: [Name]

JACK AND REMOVE EXISTING BEARINGS

Effective: April 20, 1994

Revised: January 1, 2007

Description: This work consists of furnishing all labor, tools and equipment for jacking and supporting the existing beams/slab while removing the bearing assembly. The Contractor is responsible for the complete design of the bridge lifting procedures and the materials used. The Contractor shall furnish and place all bracing, shoring, blocking, cribbing, temporary structural steel, timber, shims, wedges, hydraulic jacks, and any other materials and equipment necessary for safe and proper execution of the work. The Contractor shall remove and dispose of the bearings according to Article 501.05 of the Standard Specifications.

Construction Requirements: The Contractor shall submit details and calculations of his/her proposed jacking systems and temporary support procedures for approval by the Engineer before commencing work. At any time during the bridge raising operations, the Engineer may require the Contractor to provide additional supports or measures in order to furnish an added degree of safety. The Contractor shall provide such additional supports or measures at no additional cost to the Department. Neither added precautions nor the failure of the Engineer to order additional protection will in any way relieve the Contractor of sole responsibility for the safety of lives, equipment and structure.

- (a) Jack and Remove Existing Bearings with bridge deck in place. Jacking and cribbing under and against the existing diaphragms, if applicable, will not be allowed. The Contractor's jacking plans and procedures shall be designed and sealed by an Illinois Licensed Structural Engineer.

In all cases, traffic shall be removed from the portion of the structure to be jacked prior to and during the entire time the load is being supported by the hydraulic pressure of the jack(s). The minimum jack capacity per beam shall be as noted in the plans. Whenever possible, traffic shall be kept off that portion of the structure during the entire bearing replacement operation. The shoring or cribbing supporting the beam(s) during bearing replacement shall be designed to support the dead load plus one half of the live load and impact shown in the plans. If traffic cannot be kept off that portion of the structure during the bearing replacement then the shoring or cribbing supporting the beam(s) shall be designed to support the dead load and full live load and impact shown in the plans.

No jacking shall be allowed during the period of placement and cure time required for any concrete placed in the span(s) contributing loads to the bearings to be jacked and removed.

Jacking shall be limited to 1/8 in. (4 mm) maximum when jacking one bearing at a time. Simultaneous jacking of all beams at one support may be performed provided the maximum lift is 1/4 in. (7 mm) and the maximum differential displacement between adjacent beams is 1/8 in. (4 mm). Suitable gauges for the measurement of superstructure movement shall be furnished and installed by the Contractor.

- (b) Jack and Remove Existing Bearings when entire bridge deck is removed. Jacking and bearing removal shall be done after the removal of the existing bridge deck is complete. The Contractor's plans and procedures for the proposed jacking and cribbing system shall be designed and sealed by an Illinois Licensed Structural Engineer, unless jacking can be accomplished directly from the bearing seat under the beams or girders.

Jacking shall be limited to 1/4 in. (7 mm) maximum when jacking one beam at a time. Simultaneous jacking of all beams at one support may be performed provided the maximum lift is 3/4 in. (19 mm) and the maximum differential displacement between adjacent beams is 1/4 in. (7 mm). When staged construction is utilized, simultaneous jacking of all beams shall be limited to 1/4 in. (7 mm) unless the diaphragms at the stage line are disconnected, in which case the maximum lift is 3/4 in. (19 mm). Suitable gauges for the measurement of superstructure movement shall be furnished and installed by the Contractor.

The Contractor shall be responsible for restoring to their original condition, prior to jacking, the drainage ditches, pavement, or slopewall disturbed by the cribbing footings.

Basis of Payment: This work will be paid for at the contract unit price each for JACK AND REMOVE EXISTING BEARINGS.

CLEANING AND PAINTING EXISTING STEEL STRUCTURES

Effective: October 2, 2001

Revised: April 19, 2012

Description. This work shall consist of the preparation of all designated metal surfaces by the method(s) specified on the plans. This work also includes the painting of those designated surfaces with the paint system(s) specified on the plans. The Contractor shall furnish all materials, equipment, labor, and other essentials necessary to accomplish this work and all other work described herein and as directed by the Engineer.

Materials. All materials to be used on an individual structure shall be produced by the same manufacturer.

The Bureau of Materials and Physical Research has established a list of all products that have met preliminary requirements. Each batch of material, except for the penetrating sealer, must be tested and approved before use. The specified colors shall be produced in the coating manufacturer's facility. Tinting of the coating after it leaves the manufacturer's facility is not allowed.

The paint materials shall meet the following requirements of the Standard Specification and as noted below:

<u>Item</u>	<u>Article</u>
(a) Waterborne Acrylic	1008.04
(b) Aluminum Epoxy Mastic	1008.03
(c) Organic Zinc Rich Primer	1008.05
(d) Epoxy/ Aliphatic Urethane	1008.05
(e) Penetrating Sealer (Note 1)	
(f) Moisture Cured Zinc Rich Urethane Primer (Note 2)	
(g) Moisture Cured Aromatic/Aliphatic Urethane (Note 2)	
(h) Moisture Cured Penetrating Sealer (Note 3)	

Note 1: The Epoxy Penetrating Sealer shall be a cross-linked multi component sealer. The sealer shall have the following properties:

- (a). The volume solids shall be 98 percent (plus or minus 2 percent).
- (b). Shall be clear or slightly tinted color.

Note 2: These material requirements shall be according to the Special Provision for the Moisture Cured Urethane Paint System.

Note 3: The Moisture Cured Penetrating Sealer manufacturer's certification will be required.

Submittals. The Contractor shall submit for Engineer review and acceptance, the following plans and information for completing the work. The submittals shall be provided within 30 days

of execution of the contract unless given written permission by the Engineer to submit them at a later date. Work cannot proceed until the submittals are accepted by the Engineer. Details for each of the plans are presented within the body of this specification.

- a) Contractor/Personnel Qualifications. Evidence of Contractor qualifications and the names and qualifications/experience/training of the personnel managing and implementing the Quality Control program and conducting the quality control tests.
- b) Quality Control (QC) Program. The QC Program shall identify the following; the instrumentation that will be used, a schedule of required measurements and observations, procedures for correcting unacceptable work, and procedures for improving surface preparation and painting quality as a result of quality control findings. The program shall incorporate at a minimum, the IDOT Quality Control Daily Report form as supplied by the Engineer.
- c) Inspection Access Plan. The inspection access plan for use by Contractor QC personnel for ongoing inspections and by the Engineer during Quality Assurance (QA) observations.
- d) Surface Preparation/Painting Plan. The surface preparation/painting plan shall include the methods of surface preparation and type of equipment to be utilized for washing, hand/power tool cleaning, removal of rust, mill scale, paint or foreign matter, abrasive blast or water jetting, and remediation of chloride. If detergents, additives, or inhibitors are incorporated into the water, the Contractor shall include the names of the materials and Material Safety Data Sheets (MSDS). The Contractor shall identify the solvents proposed for solvent cleaning together with MSDS.

The plan shall also include the methods of coating application and equipment to be utilized.

If the Contractor proposes to heat or dehumidify the containment, the methods and equipment proposed for use shall be included in the Plan for the Engineer's consideration.

- e) Paint Manufacturer Certifications and Letters. When a sealer is used, the Contractor shall provide the manufacturer's certification of compliance with IDOT testing requirements listed under "Materials" above. A certification regarding the compatibility of the sealer with the specified paint system shall also be included.

When rust inhibitors are used, the Contractor shall provide a letter from the coating manufacturer indicating that the inhibitor is compatible with, and will not adversely affect the performance of the coating system.

If the use of a chemical soluble salt remover is proposed by the Contractor, provide a letter from the coating manufacturer indicating that the material will not adversely effect the performance of the coating system.

The paint manufacturer's application and thinning instructions, MSDS and product data sheets shall be provided, with specific attention drawn to storage temperatures, and the temperatures of the material, surface and ambient air at the time of application.

A letter or written instructions from the coating manufacturer shall be provided indicating the length of time that each coat must be protected from cold or inclement weather (e.g., exposure to rain) during its drying period.

- f) Abrasives. Abrasives to be used for abrasive blast cleaning, including MSDS. For expendable abrasives, the Contractor shall provide certification from the abrasive supplier that the abrasive meets the requirements of SSPC-AB1. For steel grit abrasives, the certification shall indicate that the abrasive meets the requirements of SSPC-AB3.
- g) Protective Coverings. Plan for containing or controlling paint debris (droplets, spills, overspray, etc.). Any tarpaulins or protective coverings proposed for use shall be fire retardant. For submittal requirements involving the containment used to remove lead paint, the Contractor shall refer to Special Provision for Containment and Disposal of Lead Paint Cleaning Residues.
- h) Progress Schedule. Progress schedule shall be submitted per Article 108.02 and shall identify all major work items (e.g., installation of rigging/containment, surface preparation, and coating application).

When the Engineer accepts the submittals, the Contractor will receive written notification. The Contractor shall not begin any paint removal work until the Engineer has accepted the submittals. The Contractor shall not construe Engineer acceptance of the submittals to imply approval of any particular method or sequence for conducting the work, or for addressing health and safety concerns. Acceptance of the programs does not relieve the Contractor from the responsibility to conduct the work according to the requirements of Federal, State, or Local regulations and this specification, or to adequately protect the health and safety of all workers involved in the project and any members of the public who may be affected by the project. The Contractor remains solely responsible for the adequacy and completeness of the programs and work practices, and adherence to them.

Contractor Qualifications. Unless indicated otherwise on the contract plans, for non lead abatement projects, the painting Contractor shall possess current SSPC-QP1 certification. Unless indicated otherwise on the plans, for lead abatement projects the Contractor shall also possess current SSPC-QP2 certification. The Contractor shall maintain certified status throughout the duration of the painting work under the contract. The Department reserves the right to accept Contractors documented to be currently enrolled in the SSPC-QP7, Painting Contractor Introductory Program, Category 2; in lieu of the QP certifications noted above.

Quality Control (QC) Inspections. The Contractor shall perform first line, in process QC inspections. The Contractor shall implement the submitted and accepted QC Program to insure that the work accomplished complies with these specifications. The designated Quality Control inspector shall be onsite full time during any operations that affect the quality of the coating

system (e.g., surface preparation and chloride remediation, coating mixing and application, and evaluations between coats and upon project completion). The Contractor shall use the IDOT Quality Control Daily Report form supplied by the Engineer to record the results of quality control tests. The completed reports shall be turned into the Engineer before work resumes the following day. The Engineer or designated representative will sign the report. The signature is an acknowledgment that the report has been received, but should not be construed as an agreement that any of the information documented therein is accurate.

Contractor QC inspections shall include, but not be limited to the following:

- Suitability of protective coverings and the means employed to control project debris and paint spills, overspray, etc.
- Ambient conditions
- Surface preparation (solvent cleaning, pressure washing including chalk tests, hand/power tool or abrasive blast cleaning, etc.)
- Chloride remediation
- Coating application (specified materials, mixing, thinning, and wet/dry film thickness)
- Recoat times and cleanliness between coats
- Coating continuity and coverage (freedom from runs, sags, overspray, dryspray, pinholes, shadow-through, skips, misses, etc.)

The personnel managing the Contractor's QC Program shall possess a minimum classification of Society of Protective Coatings (SSPC) BCI certified, National Association of Corrosion Engineers (NACE) Coating Inspector Level 2 - Certified, or shall provide evidence of successful inspection of 3 projects of similar or greater complexity and scope that have been completed in the last 2 years. Copies of the certification and/or experience shall be provided. References for experience shall be provided and shall include the name, address, and telephone number of a contact person employed by the bridge owner.

The personnel performing the QC tests shall be trained in coatings inspection and the use of the testing instruments. Documentation of training shall be provided. The QC personnel shall not perform hands on surface preparation or painting activities. Painters shall perform wet film thickness measurements, with QC personnel conducting random spot checks of the wet film. The Contractor shall not replace the QC personnel assigned to the project without advance notice to the Engineer, and acceptance of the replacement(s), by the Engineer.

The Contractor shall supply all necessary equipment to perform the QC inspections. Equipment shall include the following at a minimum:

- Psychrometer or comparable equipment for the measurement of dew point and relative humidity, together with all necessary weather bureau tables or psychrometric charts.
- Surface temperature thermometer
- SSPC Visual Standards VIS 1, Guide and Reference Photographs for Steel Surfaces Prepared by Dry Abrasive Blast Cleaning; SSPC-VIS 3, Visual Standard for Power and Hand-Tool Cleaned Steel; SSPC-VIS 4, Guide and Reference Photographs for Steel

Prepared by Water Jetting, and/or SSPC-VIS 5, Guide and Reference Photographs for Steel Prepared by Wet Abrasive Blast Cleaning, as applicable.

- Commercially available putty knife of a minimum thickness of 40 mils (1mm) and a width between 1 and 3 in. (25 and 75 mm). Note that the putty knife is only required for projects in which the existing coating is being feathered and must be tested with a dull putty knife.
- Testex Press-O-Film Replica Tape and Spring Micrometer
- Bresle Cell Kits or CHLOR*TEST kits for chloride determinations, or equivalent
- Wet Film Thickness Gage
- Blotter paper for compressed air cleanliness checks
- Type 2 Electronic Dry Film Thickness Gage per SSPC - PA2, Measurement of Dry Coating Thickness with magnetic Gages
- Calibration standards for dry film thickness gage
- Light meter for measuring light intensity during paint removal, painting, and inspection activities
- All applicable ASTM and SSPC Standards used for the work (reference list attached)

The instruments shall be calibrated by the Contractor's personnel according to the equipment manufacturer's recommendations and the Contractor's QC Program. All inspection equipment shall be made available to the Engineer for QA observations on an as needed basis.

Hold Point Notification. Specific inspection items throughout this specification are designated as Hold Points. Unless other arrangements are made at the project site, the Contractor shall provide the Engineer with a minimum 4-hour notification before a Hold Point inspection will be reached. If the 4-hour notification is provided and the Work is ready for inspection at that time, the Engineer will conduct the necessary observations. If the Work is not ready at the appointed time, unless other arrangements are made, an additional 4-hour notification is required. Permission to proceed beyond a Hold Point without a QA inspection will be granted solely at the discretion of the Engineer, and only on a case by case basis.

Quality Assurance (QA) Observations. The Engineer will conduct QA observations of any or all phases of the work. The presence or activity of Engineer observations in no way relieves the Contractor of the responsibility to provide all necessary daily QC inspections of his/her own and to comply with all requirements of this Specification.

The Engineer has the right to reject any work that was performed without adequate provision for QA observations.

Inspection Access and Lighting. The Contractor shall facilitate the Engineer's observations as required, including allowing ample time to view the work. The Contractor shall furnish, erect and move scaffolding or other mechanical equipment to permit close observation of all surfaces to be cleaned and painted. This equipment shall be provided during all phases of the work. Examples of acceptable access structures include:

- Mechanical lifting equipment, such as, scissor trucks, hydraulic booms, etc.

- Platforms suspended from the structure comprised of trusses or other stiff supporting members and including rails and kick boards.
- Simple catenary supports are permitted only if independent life lines for attaching a fall arrest system according to Occupational Safety and Health Administration (OSHA) regulations are provided.

When the surface to be inspected is more than 6 ft. (1.8 m) above the ground or water surface, and fall prevention is not provided (e.g., guardrails are not provided), the Contractor shall provide the Engineer with a safety harness and a lifeline according to OSHA regulations. The lifeline and attachment shall not direct the fall into oncoming traffic. The Contractor shall provide a method of attaching the lifeline to the structure independent of the inspection facility or any support of the platform. When the inspection facility (e.g., platform) is more than 2 1/2 ft. (800 mm) above the ground, the Contractor shall provide an approved means of access onto the platform.

The Contractor shall provide artificial lighting in areas both inside and outside the containment where natural light is inadequate, as determined by the Engineer, to allow proper cleaning, inspection, and painting. Illumination for inspection shall be at least 30 foot candles (325 LUX). Illumination for cleaning and painting, including the working platforms, access and entryways shall be at least 20 foot candles (215 LUX). General work area illumination outside the containment shall be employed at the discretion of the Engineer and shall be at least 5 foot candles. The exterior lighting system shall be designed and operated so as to avoid glare that interferes with traffic, workers, and inspection personnel.

Surface Preparation and Painting Equipment. All cleaning and painting equipment shall include gages capable of accurately measuring fluid and air pressures and shall have valves capable of regulating the flow of air, water or paint as recommended by the equipment manufacturer. The equipment shall be maintained in proper working order.

Diesel or gasoline powered equipment shall be positioned or vented in a manner to prevent deposition of combustion contaminants on any part of the structure.

Hand tools, power tools, pressure washing, water jetting, abrasive blast cleaning equipment, brushes, rollers, and spray equipment shall be of suitable size and capacity to perform the work required by this specification. All power tools shall be equipped with vacuums and High Efficiency Particulate Air (HEPA) filtration. Appropriate filters, traps and dryers shall be provided for the compressed air used for abrasive blast cleaning and conventional spray application. Paint pots shall be equipped with air operated continuous mixing devices unless prohibited by the coating manufacturer.

Test Sections. Prior to surface preparation, the Contractor shall prepare a test section(s) on each structure to be painted in a location(s) which the Engineer considers to be representative of the existing surface condition and steel type for the structure as a whole. More than one test section may be needed to represent the various design configurations of the structure. The purpose of the test section(s) is to demonstrate the use of the tools and degree of cleaning required (cleanliness and profile) for each method of surface preparation that will be used on the

project. Each test section shall be approximately 10 sq. ft. (0.93 sq m). The test section(s) shall be prepared using the same equipment, materials and procedures as the production operations. The Contractor shall prepare the test section(s) to the specified level of cleaning according to the appropriate SSPC visual standards, modified as necessary to comply with the requirements of this specification. The written requirements of the specification prevail in the event of a conflict with the SSPC visual standards. Only after the test section(s) have been approved shall the Contractor proceed with surface preparation operations. Additional compensation will not be allowed the Contractor for preparation of the test section(s).

For the production cleaning operations, the specifications and written definitions, the test section(s), and the SSPC visual standards shall be used in that order for determining compliance with the contractual requirements.

Protective Coverings and Damage. All portions of the structure that could be damaged by the surface preparation and painting operations (e.g., utilities), including any sound paint that is allowed to remain according to the contract documents, shall be protected by covering or shielding. Tarpaulins drop cloths, or other approved materials shall be employed. The Contractor shall comply with the provisions of the Illinois Environmental Protection Act. Paint drips, spills, and overspray are not permitted to escape into the air or onto any other surfaces or surrounding property not intended to be painted. Containment shall be used to control paint drips, spills, and overspray, and shall be dropped and all equipment secured when sustained wind speeds of 40 mph (64 kph) or greater occur, unless the containment design necessitates action at lower wind speeds. The contractor shall evaluate project-specific conditions to determine the specific type and extent of containment needed to control the paint emissions and shall submit a plan for containing or controlling paint debris (droplets, spills, overspray, etc.) to the Engineer for acceptance prior to starting the work. Acceptance by the Engineer shall not relieve the Contractor of their ultimate responsibility for controlling paint debris from escaping the work zone.

When the protective coverings need to be attached to the structure, they shall be attached by bolting, clamping, or similar means. Welding or drilling into the structure is prohibited unless approved by the Engineer in writing. When removing coatings containing lead the containment and disposal of the residues shall be as specified in the Special Provision for Containment and Disposal of Lead Paint Cleaning Residues contained elsewhere in this Contract. When removing coatings not containing lead the containment and disposal of the residues shall be as specified in the Special Provision for Containment and Disposal of Non-Lead Paint Cleaning Residues contained elsewhere in this Contract.

The Contractor shall be responsible for any damage caused to persons, vehicles, or property, except as indemnified by the Response Action Contractor Indemnification Act. Whenever the intended purposes of the controls or protective devices used by the Contractor are not being accomplished, as determined by the Engineer, work shall be immediately suspended until corrections are made. Damage to vehicles or property shall be repaired by the Contractor at the Contractor's expense. Painted surfaces damaged by any Contractor's operation shall be repaired, removed and/or repainted, as directed by the Engineer, at the Contractor's expense.

Weather Conditions. Surfaces to be painted after cleaning shall remain free of moisture and other contaminants. The Contractor shall control his/her operations to insure that dust, dirt, or moisture do not come in contact with surfaces cleaned or painted that day.

- a) The surface temperature shall be at least 5°F (3°C) above the dew point during final surface preparation operations. The manufacturers' published literature shall be followed for specific temperature, dew point, and humidity restrictions during the application of each coat.
- b) If the Contractor proposes to control the weather conditions inside containment, proposed methods and equipment for heating and/or dehumidification shall be included in the work plans for the Engineer's consideration. Any heating/dehumidification proposals accepted by the Engineer shall be implemented at no additional cost to the department.
- c) Cleaning and painting shall be done between April 15 and October 31 unless authorized otherwise by the Engineer in writing.

The Contractor shall monitor temperature, dew point, and relative humidity every 4 hours during surface preparation and coating application in the specific areas where the work is being performed. The frequency of monitoring shall increase if weather conditions are changing. If the weather conditions after application and during drying are forecast to be outside the acceptable limits established by the coating manufacturer, coating application shall not proceed. If the weather conditions are forecast to be borderline relative to the limits established by the manufacturer, monitoring shall continue at a minimum of 4-hour intervals throughout the drying period. The Engineer has the right to reject any work that was performed, or drying that took place, under unfavorable weather conditions. Rejected work shall be removed, recleaned, and repainted at the Contractor's expense.

Compressed Air Cleanliness. Prior to using compressed air for abrasive blast cleaning, blowing down the surfaces, and painting with conventional spray, the Contractor shall verify that the compressed air is free of moisture and oil contamination according to the requirements of ASTM D 4285. The tests shall be conducted at least one time each shift for each compressor system in operation. If air contamination is evident, the Contractor shall change filters, clean traps, add moisture separators or filters, or make other adjustments as necessary to achieve clean, dry air. The Contractor shall also examine the work performed since the last acceptable test for evidence of defects or contamination caused by the compressed air. Effectuated work shall be repaired at the Contractor's expense.

Low Pressure Water Cleaning and Solvent Cleaning (HOLD POINT). The Contractor shall notify the Engineer 24 hours in advance of beginning surface preparation operations.

- a) Water Cleaning of Lead Containing Coatings Prior to Overcoating. Prior to initiating any mechanical cleaning such as hand/power tool cleaning on surfaces that are painted with lead, all surfaces to be prepared and painted, and the tops of pier and abutment caps

shall be washed. Washing is not required if the surfaces will be prepared by water jetting.

Washing shall involve the use of potable water at a minimum of 1000 psi (7 MPa) and less than 5000 psi (34 MPa) according to "Low Pressure Water Cleaning" of SSPC-SP12. Paint spray equipment shall not be used to perform the water cleaning. The cleaning shall be performed in such a manner as to remove dust, dirt, chalk, insect and animal nests, bird droppings, loose paint and other foreign matter prior to solvent cleaning. The water, debris, and any loose paint removed by water cleaning shall be collected for proper disposal. The washing shall be completed no more than 2 weeks prior to surface preparation.

If detergents or other additives are added to the water, the detergents/additives shall be included in the submittals and not used until accepted by the Engineer. When detergents or additives are used, the surface shall be rinsed with potable water before the detergent water dries.

After washing has been accepted by the Engineer, all traces of asphaltic cement, oil, grease, diesel fuel deposits, and other soluble contaminants which remain on the steel surfaces to be painted shall be removed by solvent cleaning according to SSPC – SP1, supplemented with scraping (e.g., to remove large deposits of asphaltic cement) as required. The solvent(s) used for cleaning shall be compatible with the existing coating system. The Contractor shall identify the proposed solvent(s) in the submittals. If the existing coating is softened, wrinkled, or shows other signs of attack from the solvents, the Contractor shall immediately discontinue their use. The name and composition of replacement solvents, together with MSDS, shall be submitted for Engineer acceptance prior to use.

Under no circumstances shall subsequent hand/power tool cleaning be performed in areas containing surface contaminants or in areas where the Engineer has not accepted the washing and solvent cleaning. Surfaces prepared by hand/power tool cleaning without approval of the washing and solvent cleaning may be rejected by the Engineer. Rejected surfaces shall be recleaned with both solvent and the specified mechanical means at the Contractor's expense.

After all washing and mechanical cleaning are completed, representative areas of the existing coating shall be tested to verify that the surface is free of chalk and other loose surface debris or foreign matter. The testing shall be performed according to ASTM D4214. Cleaning shall continue until a chalk rating of 6 or better is achieved in every case.

- b) Water Cleaning of Non-Lead Coatings Prior to Overcoating. Thoroughly clean the surfaces according to the steps defined above for "Water Cleaning of Lead Containing Coatings Prior to Overcoating," except that the wash water does not need to be collected, and if the shop primer is inorganic zinc, the chalk rating does not apply. All other provisions are applicable.

- c) Water Cleaning/Debris Removal Prior to Total Coating Removal. When total coating removal is specified, water cleaning of the surface prior to coating removal is not required by this specification and is at the option of the Contractor. If the Contractor chooses to use water cleaning, and the existing coating contains lead, all water and debris shall be collected for proper disposal.

Whether or not the surfaces are pre-cleaned using water, the tops of the pier caps and abutments shall be cleaned free of dirt, paint chips, insect and animal nests, bird droppings and other foreign matter and the debris collected for proper disposal.

Prior to mechanical cleaning, oil, grease, and other soluble contaminants on bare steel or rusted surfaces shall be removed by solvent cleaning according to SSPC-SP1.

- d) Water Cleaning Between Coats. When foreign matter has accumulated on a newly applied coat, washing shall be performed prior to the application of subsequent coats. The water does not need to be collected unless it contacts existing lead containing coatings.

Laminar and Stratified Rust. All laminar and stratified rust that has formed on the existing steel surfaces shall be removed. Pack rust formed along the perimeter of mating surfaces of connected plates or shapes of structural steel shall be removed to the extent feasible without mechanically detaching the mating surface. Any pack rust remaining after cleaning the mating surfaces shall be tight and intact when examined using a dull putty knife. The tools used to remove these corrosion products shall be identified in the submittals and accepted by the Engineer. If the surface preparation or removal of rust results in nicks or gouges, the work shall be suspended, and the damaged areas repaired to the satisfaction of the Engineer, at the Contractor's expense. The Contractor shall also demonstrate that he/she has made the necessary adjustments to prevent a reoccurrence of the damage prior to resuming work.

Surface Preparation (HOLD POINT). One or more of the following methods of surface preparation shall be used as specified on the plans. When a method of surface preparation is specified, it applies to the entire surface, including areas that may be concealed by the containment connection points. In each case, as part of the surface preparation process, soluble salts shall be remediated as specified under "Soluble Salt Remediation". The Contractor shall also note that the surface of the steel beneath the existing coating system may contain corrosion and/or mill scale. Removal of said corrosion and/or mill scale, when specified, shall be considered included in this work and no extra compensation will be allowed.

When a particular cleaning method is specified for use in distinct zones on the bridge, the cleaning shall extend into the existing surrounding paint until a sound border is achieved. The edge of the existing paint is considered to be sound and intact if it can not be lifted by probing the edge with a dull putty knife. The sound paint shall be feathered for a minimum of 1 1/2 in. (40 mm) to achieve a smooth transition between the prepared steel and the existing coatings. Sanders with vacuum attachments, which have been approved by the Engineer, shall be used as necessary to accomplish the feathering.

- a) Limited Access Areas: A best effort with the specified methods of cleaning shall be performed in limited access areas such as the backsides of rivets inside built up box members. The equipment being used for the majority of the cleaning may need to be supplemented with other commercially available equipment, such as angle nozzles, to properly clean the limited access areas. The acceptability of the best effort cleaning in these areas is at the sole discretion of the Engineer.
- b) Near White Metal Blast Cleaning: This surface preparation shall be accomplished according to the requirements of Near White Metal Blast Cleaning SSPC-SP 10. Unless otherwise specified in the contract, the designated surfaces shall be prepared by dry abrasive blast cleaning, wet abrasive blast cleaning, or water jetting with abrasive injection. A Near White Metal Blast Cleaned surface, when viewed without magnification, shall be free of all visible oil, grease, dirt, dust, mill scale, rust, paint, oxides, corrosion products, and other foreign matter, except for staining.

Random staining shall be limited to no more than 5 percent of each 9 sq. in. (58 sq. cm) of surface area and may consist of light shadows, slight streaks, or minor discoloration caused by stains of rust, stains of mill scale, or stains of previously applied paint. With the exception of crevices as defined below, surface discoloration is considered to be a residue that must be removed, rather than a stain, if it possesses enough mass or thickness that it can be removed as a powder or in chips when scraped with a pocketknife.

A surface profile shall be created on the steel as defined later under "Surface Profile."

At the discretion of the Engineer, after a best effort cleaning, slight traces of existing coating may be permitted to remain within crevices such as those created between rivets, bolts, and plates, and the underlying steel. When traces of coating are permitted to remain, the coating shall be tightly bonded when examined by probing with a dull putty knife. The traces of coating shall be confined to the bottom portion of the crevices only, and shall not extend onto the surrounding steel or plate or onto the outer surface of the rivets or bolts. Pitted steel is excluded from exemption considerations and shall be cleaned according to SSPC-SP10.

If hackles or slivers are visible on the steel surface after cleaning, the Contractor shall remove them by grinding followed by reblast cleaning. At the discretion of the Engineer, the use of power tools to clean the localized areas after grinding, and to establish a surface profile acceptable to the coating manufacturer, can be used in lieu of blast cleaning.

If the surfaces are prepared using wet abrasive methods, attention shall be paid to tightly configured areas to assure that the preparation is thorough. After surface preparation is completed, the surfaces, surrounding steel, and containment materials/scaffolding shall be rinsed to remove abrasive dust and debris. Potable water shall be used for all operations. An inhibitor may be added to the supply water and/or rinse water to prevent flash rusting. If a rust inhibitor is proposed, the Contractor shall provide a sample of the

proposed inhibitor together with a letter from the coating manufacturer indicating that the inhibitor is suitable for use with their products. The surfaces shall be allowed to completely dry before the application of any coating.

- c) Commercial Grade Power Tool Cleaning: This surface preparation shall be accomplished according to the requirements of Commercial Grade Power Tool Cleaning, SSPC-SP15. The designated surfaces shall be completely cleaned with power tools. A Commercial Grade Power Tool Cleaned surface, when viewed without magnification, is free of all visible oil, grease, dirt, rust, coating, oxides, mill scale, corrosion products, and other foreign matter, except for staining. In previously pitted areas, slight residues of rust and paint may also be left in the bottoms of pits.

Random staining shall be limited to no more than 33 percent of each 9 sq. in. (58 sq. cm) of surface area. Allowable staining may consist of light shadows, slight streaks, or minor discoloration caused by stains of rust, stains of mill scale, or stains of previously applied paint. Surface discoloration is considered to be a residue that must be removed, rather than a stain, if it possesses enough mass or thickness that it can be removed as a powder or in chips when scraped with a pocketknife.

A surface profile shall be created on the steel as defined later under "Surface Profile."

At the Contractor's option, Near White Metal Blast Cleaning may be substituted for Power Tool Cleaning – Commercial Grade, as long as containment systems appropriate for abrasive blast cleaning are utilized and there is no additional cost to the Department.

- d) Power Tool Cleaning – Modified SP3: This surface preparation shall be accomplished according to the requirements of SSPC-SP3, Power Tool Cleaning except as modified as follows. The designated surfaces shall be cleaned with power tools. A power tool cleaned surface shall be free of all loose rust, loose mill scale, loose and peeling paint, and loose rust that is bleeding through and/or penetrating the coating. All locations of visible corrosion and rust bleed, exposed or lifting mill scale, and lifting or loose paint shall be prepared using the power tools.

Upon completion of the cleaning, rust, rust bleed, mill scale and surrounding paint are permitted to remain if they can not be lifted using a dull putty knife.

Power Tool Cleaning of Shop Primed Steel. When steel coated with only a prime coat of inorganic or organic zinc is specified to be cleaned, this work shall be accomplished as follows. After cleaning the surface as specified under "Water Cleaning of Non-Lead Coatings Prior to Overcoating," damaged and rusted areas shall be spot cleaned according Power Tool Cleaning -Modified SSPC-SP3. The edges of the coating surrounding the spot repairs shall be feathered.

Abrasives. Unless otherwise specified in the contract, when abrasive blast cleaning is specified, it shall be performed using either expendable abrasives (other than silica sand) or recyclable steel grit abrasives. Expendable abrasives shall be used one time and disposed of. Abrasive suppliers shall certify that the expendable abrasives meet the requirements of SSPC-AB1 and

that recyclable steel grit abrasives meet AB3. On a daily basis, the Contractor shall verify that recycled abrasives are free of oil contamination by conducting oil content tests according to SSPC-AB2.

All surfaces prepared with abrasives not meeting the SSPC-AB1, AB2, or AB3 requirements, as applicable, shall be solvent cleaned or low pressure water cleaned as directed by the Engineer, and reblast cleaned at the Contractor's expense.

Surface Profile (HOLD POINT). The abrasives used for blast cleaning shall have a gradation such that the abrasive will produce a uniform surface profile of 1.5 to 4.5 mils (38 to 114 microns). If the profile requirements of the coating manufacturer are more restrictive, advise the Engineer and comply with the more restrictive requirements. For recycled abrasives, an appropriate operating mix shall be maintained in order to control the profile within these limits.

The surface profile for the Power Tool Cleaning - Commercial Grade shall be within the range specified by the coating manufacturer, but not less than 2.0 mils (50 microns).

The surface profile produced by the Contractor's surface preparation procedures shall be determined by replica tape and spring micrometer at the beginning of the work, and each day that surface preparation is performed. Areas having unacceptable measurements shall be further tested to determine the limits of the deficient area. The replica tape shall be attached to the daily report.

When unacceptable profiles are produced, work shall be suspended. The Contractor shall submit a plan for the necessary adjustments to insure that the correct surface profile is achieved on all surfaces. The Contractor shall not resume work until the new profile is verified by the QA observations, and the Engineer confirms, in writing, that the profile is acceptable.

Soluble Salt Remediation (HOLD POINT). The Contractor shall implement surface preparation procedures and processes that will remove chloride from the surfaces. Surfaces that may be contaminated with chloride include, but are not limited to, expansion joints and all areas that are subject to roadway splash or run off such as fascia beams and stringers.

Methods of chloride removal may include, but are not limited to, steam cleaning or pressure washing with or without the addition of a chemical soluble salt remover as approved by the coating manufacturer, and scrubbing before or after initial paint removal. The Contractor may also elect to clean the steel and allow it to rust overnight followed by recleaning, or by utilizing blends of fine and coarse abrasives during blast cleaning, wet abrasive/water jetting methods of preparation, or combinations of the above. If steam or water cleaning methods of chloride removal are utilized over surfaces where the coating has been completely removed, and the water does not contact any lead containing coatings, the water does not have to be collected. The Contractor shall provide the proposed procedures for chloride remediation in the Surface Preparation/Painting Plan.

Upon completion of the chloride remediation steps, the Contractor shall use cell methods of field chloride extraction and test procedures (e.g., silver dichromate) accepted by the Engineer, to test representative surfaces that were previously rusted (e.g., pitted steel) for the presence of

remaining chlorides. Remaining chloride levels shall be no greater than $7\mu\text{g}/\text{sq cm}$ as read directly from the surface without any multiplier applied to the results. The testing must be performed, and the results must be acceptable, prior to painting each day.

A minimum of 5 tests per 1000 sq. ft. (93 sq m) or fraction thereof completed in a given day, shall be conducted at project start up. If results greater than $7\mu\text{g}/\text{sq cm}$ are detected, the surfaces shall be recleaned and retested at the same frequency. If acceptable results are achieved on three consecutive days in which testing is conducted, the test frequency may be reduced to 1 test per 1000 sq. ft. (93 sq. m) prepared each day provided the chloride remediation process remains unchanged. If unacceptable results are encountered, or the methods of chloride remediation are changed, the Contractor shall resume testing at a frequency of 5 tests per 1000 sq. ft. (93 sq. m).

Following successful chloride testing the chloride test areas shall be cleaned. Commercial Grade Power Tool Cleaning can be used to clean the test locations when the specified degree of cleaning is SSPC-SP10.

Surface Condition Prior to Painting (HOLD POINT). Prepared surfaces, shall meet the requirements of the respective degrees of cleaning immediately prior to painting, and shall be painted before rusting appears on the surface. If rust appears or bare steel remains unpainted for more than 12 hours, the affected area shall be prepared again at the expense of the Contractor.

All loose paint and surface preparation cleaning residue on bridge steel surfaces, scaffolding and platforms, containment materials, and tops of abutments and pier caps shall be removed prior to painting. When lead paint is being disturbed, cleaning shall be accomplished by HEPA vacuuming unless it is conducted within a containment that is designed with a ventilation system capable of collecting the airborne dust and debris created by sweeping and blowing with compressed air.

The quality of surface preparation and cleaning of surface dust and debris must be accepted by the Engineer prior to painting. The Engineer has the right to reject any work that was performed without adequate provision for QA observations to accept the degree of cleaning. Rejected coating work shall be removed and replaced at the Contractor's expense.

General Paint Requirements. Paint storage, mixing, and application shall be accomplished according to these specifications and as specified in the paint manufacturer's written instructions and product data sheets for the paint system used. In the event of a conflict between these specifications and the coating manufacturers' instructions and data sheets, the Contractor shall advise the Engineer and comply with the Engineer's written resolution. Until a resolution is provided, the most restrictive conditions shall apply.

Unless noted otherwise, if a new concrete deck or repair to an existing deck is required, painting shall be done after the deck is placed and the forms have been removed.

- a) Paint Storage and Mixing. All Paint shall be stored according to the manufacturer's published instructions, including handling, temperatures, and warming as required prior to mixing. All coatings shall be supplied in sealed containers bearing the manufacturer's name, product designation, batch number and mixing/thinning instructions. Leaking containers shall not be used.

Mixing shall be according to the manufacturer's instructions. Thinning shall be performed using thinner provided by the manufacturer, and only to the extent allowed by the manufacturer's written instructions. In no case shall thinning be permitted that would cause the coating to exceed the local Volatile Organic Compound (VOC) emission restrictions. For multiple component paints, only complete kits shall be mixed and used. Partial mixing is not allowed.

The ingredients in the containers of paint shall be thoroughly mixed by mechanical power mixers according to the manufacturer's instructions, in the original containers before use or mixing with other containers of paint. The paint shall be mixed in a manner that will break up all lumps, completely disperse pigment and result in a uniform composition. Paint shall be carefully examined after mixing for uniformity and to verify that no unmixed pigment remains on the bottom of the container. Excessive skinning or partial hardening due to improper or prolonged storage will be cause for rejection of the paint, even though it may have been previously inspected and accepted.

Multiple component coatings shall be discarded after the expiration of the pot life. Single component paint shall not remain in spray pots, painters buckets, etc. overnight. It shall be stored in a covered container and remixed before use.

The Engineer reserves the right to sample field paint (individual components and/or the mixed material) and have it analyzed. If the paint does not meet the product requirements due to excessive thinning or because of other field problems, the coating shall be removed from that section of the structure and replaced as directed by the Engineer.

- b) Application Methods. Unless prohibited by the coating manufacturer's written instructions, paint may be applied by spray methods, rollers, or brushes. If applied with conventional or airless spray methods, paint shall be applied in a uniform layer with overlapping at the edges of the spray pattern.

The painters shall monitor the wet film thickness of each coat during application. The wet film thickness shall be calculated based on the solids by volume of the material and the amount of thinner added. When the new coating is applied over an existing system, routine QC inspections of the wet film thickness shall be performed in addition to the painter's checks in order to establish that a proper film build is being applied.

When brushes or rollers are used to apply the coating, additional applications may be required to achieve the specified thickness per layer.

- c) Painting Shop Primed Steel. After cleaning, rusted and damaged areas shall be touched up using the same primer specified for painting the existing structure. The intermediate and finish coats specified for painting the existing structure shall be applied to the steel. When inorganic zinc has been used as the shop primer, a mist coat of the intermediate coat shall be applied first in order to prevent pinholing and bubbling.
- d) Recoating and Film Continuity (HOLD POINT for each coat). Paint shall be considered dry for recoating according to the time/temperature/humidity criteria provided in the manufacturer's instructions and when an additional coat can be applied without the development of film irregularities; such as lifting, wrinkling, or loss of adhesion of the under coat. If surfaces are contaminated, washing shall be accomplished prior to intermediate and final coats. Wash water does not have to be collected unless the water contacts existing lead containing coatings.

Painting shall be done in a neat and workmanlike manner. Each coat of paint shall be applied as a continuous film of uniform thickness free of defects including, but not limited to, runs, sags, overspray, dryspray, pinholes, voids, skips, misses, and shadow-through. Defects such as runs and sags shall be brushed out immediately during application.

Paint Systems. The paint system(s) from the list below shall be applied as specified.

The paint manufacturer's relative humidity, dew point, and material, surface, and ambient temperature restrictions shall be provided with the submittals and shall be strictly followed. Written recommendations from the paint manufacturer for the length of time each coat must be protected from cold or inclement weather (e.g., exposure to rain), during the drying period shall be included in the submittals. Upon acceptance by the Engineer, these times shall be used to govern the duration that protection must be maintained during drying.

Where stripe coats are indicated, the Contractor shall apply an additional coat to edges, rivets, bolts, crevices, welds, and similar surface irregularities. The stripe coat shall be applied by brush and/or spray to thoroughly work the coating into or on the irregular surfaces, and shall extend onto the surrounding steel a minimum of 1 in. (25 mm) in all directions. The purpose of the stripe coat is to build additional thickness and to assure complete coverage of these areas.

The stripe coat may be applied as part of the application of the full coat unless prohibited by the coating manufacturer. If applied as part of the application process of the full coat, the stripe coat shall be allowed to dry for a minimum of 10 minutes in order to allow Contractor QC personnel to verify that the coat was applied. If a wet-on-wet stripe coat is prohibited by the coating manufacturer or brush or roller application of the full coat pulls the underlying stripe coat, the stripe coat shall dry according to the manufacturers' recommended drying times prior to the application of the full coat. In the case of the prime coat, the full coat can also be applied first to protect the steel, followed by the stripe coat after the full coat has dried.

- a) System 1 – OZ/E/U – for Bare Steel: System 1 shall consist of the application of a full coat of organic (epoxy) zinc-rich primer, a full intermediate coat of epoxy, and a full finish coat

of aliphatic urethane. Stripe coats of the prime and finish coats shall be applied. The film thicknesses of the full coats shall be as follows, measured according to SSPC-PA2:

- One full coat of organic zinc-rich primer between 3.5 and 5.0 mils (90 and 125 microns) dry film thickness. The prime coat shall be tinted to a color that contrasts with the steel surface.
- One full intermediate coat of epoxy between 3.0 and 6.0 mils (75 and 150 microns) dry film thickness. The intermediate coat shall be a contrasting color to both the first coat and finish coat.
- One full finish coat of aliphatic urethane between 2.5 and 4.0 mils (65 and 100 microns) dry film thickness. Finish coat color shall be according to contract plans.

The total dry film thickness for this system, exclusive of areas receiving the stripe coats, shall be between 9.0 and 15.0 mils (225 and 375 microns).

- b) System 2 – PS/EM/U – for Overcoating an Existing System: System 2 shall consist of the application of a full coat of epoxy penetrating sealer, a spot intermediate coat of aluminum epoxy mastic and a stripe and full finish coat of aliphatic urethane.

A full coat of epoxy penetrating sealer shall be applied to all surfaces following surface preparation. A spot intermediate coat shall consist of the application of one coat of the aluminum epoxy mastic on all areas where rust is evident and areas where the old paint has been removed, feathered and/or damaged prior to, during or after the cleaning and surface preparation operations. After the spot intermediate, a stripe coat and full finish coat of aliphatic urethane shall be applied. The film thicknesses shall be as follows, measured according to SSPC-PA2:

- One full coat of epoxy penetrating sealer between 1.0 and 2.0 mils (25 and 50 microns) dry film thickness.
- One spot coat of aluminum epoxy mastic between 5.0 and 7.0 mils (125 and 175 microns) dry film thickness. The color shall contrast with the finish coat.
- One full finish coat of aliphatic urethane between 2.5 and 4.0 mils (65 and 100 microns) dry film thickness. Finish coat color shall be according to contract plans.

The total dry film thickness for this system, exclusive of the stripe coat, shall be between 8.5 and 13.0 mils (215 and 325 microns). The existing coating thickness to remain under the overcoat must be verified in order to obtain accurate total dry film thickness measurements.

- c) System 3 – EM/EM/AC – for Bare Steel: System 3 shall consist of the application of two full coats of aluminum epoxy mastic and a full finish coat of waterborne acrylic. Stripe

coats for first coat of epoxy mastic and the finish coat shall be applied. The film thicknesses of the full coats shall be as follows, measured according to SSPC-PA2:

- One full coat of aluminum epoxy mastic between 5.0 and 7.0 mils (125 and 175 microns) dry film thickness. The first coat of aluminum epoxy mastic shall be tinted a contrasting color with the blast cleaned surface and the second coat.
- One full intermediate coat of aluminum epoxy mastic between 5.0 and 7.0 mils (125 and 175 microns) dry film thickness. The intermediate coat shall be a contrasting color to the first coat and the finish coat.
- A full finish coat of waterborne acrylic between 2.0 and 4.0 mils (50 and 100 microns) dry film thickness. Finish coat color shall be according to contract plans.

The total dry film thickness for this system, exclusive of areas receiving the stripe coats, shall be between 12.0 and 18.0 mils (360 and 450 microns).

- d) System 4 – PS/EM/AC – for Overcoating an Existing System: System 4 shall consist of the application of a full coat of epoxy penetrating sealer, a spot intermediate coat of aluminum epoxy mastic and a stripe and full finish coat of waterborne acrylic.

A full coat of epoxy penetrating sealer shall be applied to all surfaces following surface preparation. A spot intermediate coat shall consist of the application of one coat of the aluminum epoxy mastic on all areas where rust is evident and areas where the old paint has been removed, feathered and/or damaged prior to, during or after the cleaning and surface preparation operations. After the spot intermediate, a stripe coat and full finish coat of waterborne acrylic shall be applied. The film thicknesses shall be as follows, measured according to SSPC-PA2:

- One full coat of epoxy penetrating sealer between 1.0 and 2.0 mils (25 and 50 microns) dry film thickness.
- One spot coat of aluminum epoxy mastic between 5.0 and 7.0 mils (125 and 175 microns) dry film thickness. The color shall contrast with the finish coat.
- One full finish coat of waterborne acrylic between 2.0 and 4.0 mils (50 and 100 microns) dry film thickness. Finish coat color shall be according to contract plans.

The total dry film thickness for this system, exclusive of the stripe coat, shall be between 8.0 and 13.0 mils (200 and 325 microns). The existing coating thickness to remain under the overcoat must be verified in order to obtain accurate total dry film thickness measurements.

- e) System 5 – MCU – for Bare Steel: System 5 shall consist of the application of a full coat of moisture cure urethane (MCU) zinc primer, a full coat of MCU intermediate, and a full coat of MCU finish. Stripe coats of the prime and finish coats shall be applied. The contractor

shall comply with the manufacturer's requirements for drying times between the application of the stripe coats and the full coats. The film thicknesses of the full coats shall be as follows, measured according to SSPC-PA2:

- One full coat of MCU zinc primer between 3.0 and 5.0 mils (75 and 125 microns) dry film thickness. The prime coat shall be tinted to a color that contrasts with the steel surface.
- One full MCU intermediate coat between 3.0 and 4.0 mils (75 and 100 microns) dry film thickness. The intermediate coat shall be a contrasting color to both the first coat and finish coat.
- One full MCU finish coat between 2.0 and 4.0 mils (50 and 100 microns) dry film thickness. Finish coat color shall be according to contract plans.

The total dry film thickness for this system, exclusive of areas receiving the stripe coats, shall be between 8.0 and 13.0 mils (200 and 325 microns).

- f) System 6 – MCU – for Overcoating an Existing System: System 6 shall consist of the application of a full coat of moisture cure urethane (MCU) penetrating sealer, a spot coat of MCU intermediate, and a stripe and full coat of MCU finish.

A full coat of MCU penetrating sealer shall be applied to all surfaces following surface preparation. A spot intermediate coat shall consist of the application of one coat of MCU intermediate on all areas where rust is evident and areas where the old paint has been removed, feathered and/or damaged prior to, during or after the cleaning and surface preparation operations. After the spot intermediate, a stripe coat and full coat of MCU finish shall be applied. The contractor shall comply with the manufacturer's requirements for drying time between the application of the stripe coat and the full finish coat. The film thicknesses shall be as follows, measured according to SSPC-PA2:

- One full coat of MCU sealer between 1.0 and 2.0 mils (25 and 50 microns) dry film thickness.
- One full MCU intermediate coat between 3.0 and 4.0 mils (75 and 100 microns) dry film thickness. The color shall contrast with the finish coat.
- One full MCU finish coat 2.0 and 4.0 mils (50 and 100 microns) dry film thickness. Finish coat color shall be according to contract plans.

The total dry film thickness for this system, exclusive of areas receiving the stripe coats, shall be between 6.0 and 10.0 mils (150 and 250 microns). The existing coating thickness to remain under the overcoat must be verified in order to obtain accurate total dry film thickness measurements.

Repair of Damage to New Coating System and Areas Concealed by Containment. The Contractor shall repair all damage to the newly installed coating system and areas concealed by the containment/protective covering attachment points, at no cost to the Department. If the damage extends to the substrate and the original preparation involved abrasive blast cleaning, the damaged areas shall be prepared to Power Tool Cleaning - Commercial Grade. If the original preparation was other than blast cleaning or the damage does not extend to the substrate, the loose, fractured paint shall be cleaned to Power Tool Cleaning – Modified SP3.

The surrounding coating at each repair location shall be feathered for a minimum distance of 1 1/2 in. (40 mm) to achieve a smooth transition between the prepared areas and the existing coating.

If the bare steel is exposed, all coats shall be applied to the prepared area. If only the intermediate and finish coats are damaged, the intermediate and finish shall be applied. If only the finish coat is damaged, the finish shall be applied.

Special Instructions.

- a) At the completion of the work, the Contractor shall stencil the painting date and the paint code on the bridge. The letters shall be capitals, not less than 2 in. (50 mm) and not more than 3 in. (75 mm) in height.

The stencil shall contain the following wording "PAINTED BY (insert the name of the Contractor)" and shall show the month and year in which the painting was completed, followed by the appropriate code for the coating material applied, all stenciled on successive lines:

CODE U (for field applied System 3 or System 4).

CODE Z (for field applied System 1 or System 2).

CODE AA (for field applied System 5 or System 6).

This information shall be stenciled on the cover plate of a truss end post near the top of the railing, or on the outside face of an outside stringer near one end of the bridge, or at some equally visible surface near the end of the bridge, as designated by the Engineer.

- b) All surfaces painted inadvertently shall be cleaned immediately.

It is understood and agreed that the cost of all work outlined above, unless otherwise specified, has been included in the bid, and no extra compensation will be allowed.

Basis of Payment. This work shall be paid for at the contract Lump Sum price for CLEANING AND PAINTING STEEL BRIDGE, at the designated location, or for CLEANING AND PAINTING the structure or portions thereof described. Payment will not be authorized until all requirements for surface preparation and painting have been fulfilled as described in this specification,

including the preparation and submittal of all QC documentation. Payment will also not be authorized for non-conforming work until the discrepancy is resolved in writing.

Appendix 1 – Reference List

The Contractor shall maintain the following regulations and references on site for the duration of the project:

- Illinois Environmental Protection Act
- ASTM D 4214, Standard Test Method for Evaluating Degree of Chalking of Exterior Paint Films
- ASTM D 4285, Standard Test Method for Indicating Oil or Water in Compressed Air
- SSPC-AB 1, Mineral and Slag Abrasives
- SSPC-AB 2, Specification for Cleanliness of Recycled Ferrous Metallic Abrasives
- SSPC-AB 3, Newly Manufactured or Re-Manufactured Steel Abrasives
- SSPC-PA 2, Measurement of Dry Coating Thickness with Magnetic Gages
- SSPC-QP 1, Standard Procedure for Evaluating Painting Contractors (Field Application to Complex Structures)
- SSPC-QP 2, Standard Procedure for Evaluating the Qualifications of Painting Contractors to Remove Hazardous Paint
- SSPC-SP 1, Solvent Cleaning
- SSPC-SP 3, Power Tool Cleaning
- SSPC-SP 10/NACE No. 2, Near White Metal Blast Cleaning
- SSPC-SP 12/NACE No. 5, Surface Preparation and Cleaning of Metals by Waterjetting Prior to Recoating
- SSPC-SP15, Commercial Grade Power Tool Cleaning
- SSPC-VIS 1, Guide and Reference Photographs for Steel Surfaces Prepared by Dry Abrasive Blast Cleaning
- SSPC-VIS 3, Visual Standard for Power- and Hand-Tool Cleaned Steel
- SSPC-VIS 4, Guide and Reference Photographs for Steel Cleaned by Water Jetting
- SSPC-VIS 5, Guide and Reference Photographs for Steel Prepared by Wet Abrasive Blast Cleaning
- The paint manufacturer's application instructions, MSDS and product data sheets

CONTAINMENT AND DISPOSAL OF LEAD PAINT CLEANING RESIDUES

Effective: October 2, 2001

Revised: April 30, 2010

Description. This work shall consist of the containment, collection, temporary storage, transportation and disposal of waste from lead paint removal projects. Waste requiring containment and control includes, but is not limited to, old paint, spent abrasives, corrosion products, mill scale, dirt, dust, grease, oil, salts, and water used for cleaning the surface of existing lead coatings prior to overcoating.

General. The existing coatings contain lead and may also contain other toxic metals. This specification provides the requirements for containment and for the protection of the public, and the environment from exposure to harmful levels of toxic metals that may be present in the paint being removed or repaired. The Contractor shall take reasonable and appropriate precautions to protect the public from the inhalation or ingestion of dust or debris from the operations, and is responsible for the clean-up of all spills of waste at no additional cost to the Department.

The Contractor shall comply with the requirements of this Specification and all applicable Federal, State, and Local laws, codes, and regulations, including, but not limited to the regulations of the United States Environmental Protection Agency (USEPA), Occupational Safety and Health Administration (OSHA), and Illinois Environmental Protection Agency (IEPA). The Contractor shall comply with all applicable regulations even if the regulation is not specifically referenced herein. If a Federal, State, or Local regulation is more restrictive than the requirements of this Specification, the more restrictive requirements shall prevail.

Submittals. The Contractor shall submit for Engineer review and acceptance, the following drawings and plans for accomplishing the work. The submittals shall be provided within 30 days of execution of the contract unless given written permission by the Engineer to submit them at a later date. Work cannot proceed until the submittals are accepted by the Engineer. Details for each of the plans are presented within the body of this specification. The Contractor shall also maintain on site, copies of the standards and regulations referenced herein (list provided in appendix 1).

- a) Containment Plans. The containment plans shall include drawings, equipment specifications, and calculations (wind load, air flow and ventilation when negative pressure is specified). The plans shall include copies of the manufacturer's specifications for the containment materials and equipment that will be used to accomplish containment and ventilation.

When required by the contract plans, the submittal shall provide calculations that assure the structural integrity of the bridge when it supports the containment and the calculations and drawings shall be signed and sealed by a Structural Engineer licensed in the state of Illinois.

When working over the railroad or navigable waterways, the Department will notify the respective agencies that work is being planned. Unless otherwise directed by the Engineer, the Contractor is responsible for follow up contact, and shall provide evidence that the

railroad, Coast Guard, Corps of Engineers, and other applicable agencies are satisfied with the clearance provided and other safety measures that are proposed.

- b) Environmental Monitoring Plan. The Environmental Monitoring Plan shall address the visual inspections and clean up of the soil and water that the Contractor will perform, including final project inspection and cleanup. The plan shall address the daily visible emissions observations that will be performed and the corrective action that will be implemented in the event emissions or releases occur. When high volume ambient air monitoring is required, an Ambient Air Monitoring Plan shall be developed. The plan shall include:
- Proposed monitor locations and power sources in writing. A site sketch shall be included, indicating sensitive receptors, monitor locations, and distances and directions from work area.
 - Equipment specification sheet for monitors to be used, and a written commitment to calibrate and maintain the monitors.
 - Include a procedure for operation of monitors per 40 CFR 50, Appendix B, including use of field data chain-of-custody form. Include a sample chain of custody form.
 - Describe qualifications/training of monitor operator.
 - The name, contact information (person's name and number), and certification of the laboratory performing the filter analysis. Laboratory shall be accredited by one of the following: 1) the American Industrial Hygiene Association (AIHA) for lead (metals) analysis, 2) Environmental Lead Laboratory Accreditation Program (ELLAP) for metals analysis, 3) State or federal accreditation program for ambient air analysis or, 4) the EPA National Lead Laboratory Accreditation Program (NLLAP) for lead analysis. The laboratory shall provide evidence of certification, a sample laboratory chain-of-custody form, and sample laboratory report that provides the information required by this specification. The laboratory shall also provide a letter committing to do the analysis per 40 CFR 50, Appendix G. If the analysis will not be performed per 40 CFR Appendix G, a proposed alternate method shall be described, together with the rationale for using it. The alternate method can not be used unless specifically accepted by the Engineer in writing.
- c) Waste Management Plan. The Waste Management Plan shall address all aspects of waste handling, storage, testing, hauling and disposal. Include the names, addresses, and a contact person for the proposed licensed waste haulers and disposal facilities. Submit the name and qualifications of the laboratory proposed for Toxicity Characteristic Leaching Procedure (TCLP) analysis. If the use of abrasive additives is proposed, provide the name of the additive, the premixed ratio of additive to abrasive being provided by the supplier, and a letter from the supplier of the additive indicating IEPA acceptance of the material. Note that the use of any steel or iron based material, such as but not limited to grit, shot, fines, or fillings as an abrasive additive is prohibited.
- d) Contingency Plan. The Contractor shall prepare a contingency plan for emergencies including fire, accident, failure of power, failure of dust collection system, failure of supplied air system or any other event that may require modification of standard operating procedures during lead removal. The plan shall include specific procedures to ensure safe egress and proper medical attention in the event of an emergency.

When the Engineer accepts the submittals, the Contractor will receive written notification. The Contractor shall not begin any work until the Engineer has accepted the submittals. The Contractor shall not construe Engineer acceptance of the submittals to imply approval of any particular method or sequence for conducting the work, or for addressing health and safety concerns. Acceptance of the plans does not relieve the Contractor from the responsibility to conduct the work according to the requirements of Federal, State, or Local regulations, this specification, or to adequately protect the health and safety of all workers involved in the project and any members of the public who may be affected by the project. The Contractor remains solely responsible for the adequacy and completeness of the programs and work practices, and adherence to them.

Quality Control (QC) Inspections. The Contractor shall perform first line, in process QC inspections of all environmental control and waste handling aspects of the project to verify compliance with these specification requirements and the accepted drawings and plans. The Contractor shall use the IDOT Environmental Daily Report form supplied by the Engineer to record the results of the inspections. The completed reports shall be turned into the Engineer before work resumes the following day. Contractor QC inspections shall include, but not be limited to the following:

- Proper installation and continued performance of the containment system(s) in accordance with the approved drawings.
- Visual inspections of emissions into the air and verification that the cause(s) for any unacceptable emissions is corrected.
- Set up, calibration, operation, and maintenance of the regulated area and high volume ambient air monitoring equipment, including proper shipment of cassettes/filters to the laboratory for analysis. Included is verification that the Engineer receives the results within the time frames specified and that appropriate steps are taken to correct work practices or containment in the event of unacceptable results.
- Visual inspections of spills or deposits of contaminated materials into the water or onto the ground, pavement, soil, or slope protection. Included is verification that proper cleanup is undertaken and that the cause(s) of unacceptable releases is corrected.
- Proper implementation of the waste management plan including laboratory analysis and providing the results to the Engineer within the time frames specified herein.
- Proper implementation of the contingency plans for emergencies.

The personnel providing the QC inspections shall possess current SSPC-C3 certification or equal, including the annual training necessary to maintain that certification (SSPC-C5 or equal), and shall provide evidence of successful completion of 2 projects of similar or greater complexity and scope that have been completed in the last 2 years. References shall include the name, address, and telephone number of a contact person employed by the bridge owner. Proof of initial certification and the current annual training shall also be provided.

Quality Assurance (QA) Observations. The Engineer will conduct QA observations of any or all of the QC monitoring inspections that are undertaken. The presence or activity of Engineer

observations in no way relieves the Contractor of the responsibility to provide all necessary daily QC inspections of its own and to comply with all requirements of this Specification.

Containment Requirements. The Contractor shall install and maintain containment systems surrounding the work for the purpose of controlling emissions of dust and debris according to the requirements of this specification. Working platforms and containment materials that are used shall be firm and stable and platforms shall be designed to support the workers, inspectors, spent surface preparation media (e.g., abrasives), and equipment during all phases of surface preparation and painting. Platforms, cables, and other supporting structures shall be designed according to OSHA regulations. If the containment needs to be attached to the structure, the containment shall be attached by bolting, clamping, or similar means. Welding or drilling into the structure is prohibited unless approved by the Engineer in writing.

The containment shall be dropped in the event of sustained winds of 40 mph (64 kph) or greater and all materials and equipment secured.

The Contractor shall provide drawings showing the containment system and indicating the method(s) of supporting the working platforms and containment materials to each other and to the bridge. When the use of negative pressure and airflow inside containment is specified, the Contractor shall provide all ventilation calculations and details on the equipment that will be used for achieving the specified airflow and dust collection.

When directed in the contract plans, the Contractor shall submit calculations and drawings, signed and sealed by a Structural Engineer licensed in the state of Illinois, that assure the structural integrity of the bridge under the live and dead loads imposed, including the design wind loading.

When working over railroads, the Contractor shall provide evidence that the proposed clearance and the safety provisions that will be in place (e.g., flagman) are acceptable to the railroad. In the case of work over navigable waters, the Contractor shall provide evidence that the proposed clearance and provisions for installing or moving the containment out of navigation lanes is acceptable to authorities such as the Coast Guard and Army Corps of Engineers. The Contractor shall include plans for assuring that navigation lighting is not obscured, or if it is obscured, that temporary lighting is acceptable to the appropriate authorities (e.g., Coast Guard) and will be utilized.

Engineer review and acceptance of the drawings and calculations shall not relieve the Contractor from the responsibility for the safety of the working platforms and containment, and for providing ample ventilation to control worker and environmental exposures. After the work platforms and containment materials are erected additional measures may be needed to ensure worker safety according to OSHA regulations. The Contractor shall institute such measures at no additional cost to the Department.

Containment for the cleaning operation of this contract is defined as follows:

- The containment system shall maintain the work area free of visible emissions of dust and debris according to all provisions of this Specification, with no debris permitted outside of

the regulated area at any time. All debris within the regulated area and within the containment shall be collected at the end of the last shift each day, and properly stored in sealed containers. Cleaning shall be accomplished by HEPA vacuuming unless it is conducted within a containment that is designed with a ventilation system capable of collecting the airborne dust and debris created by sweeping and blowing with compressed air. The ventilation system shall be in operation during the cleaning.

- The containment systems shall comply with the specified SSPC Guide 6 classifications as presented in Table 1 for the method of paint removal utilized.
- TSP-lead in the air at monitoring locations selected by the Contractor shall comply with the requirements specified herein.

The Contractor shall take appropriate action to avoid personnel injury or damage to the structure from the installation and use of the containment system. If the Engineer determines that there is the potential for structural damage caused by the installed containment system, the Contractor shall take appropriate action to correct the situation.

In addition to complying with the specific containment requirements in Table 1 for each method of removal, the Contractor shall provide and maintain coverage over the ground in the areas to be cleaned. This coverage shall be capable of catching and containing surface preparation media, paint chips, and paint dust in the event of an accidental escape from the primary containment. The containment materials shall be cleaned of loose material prior to relocation or dismantling. Acceptable methods of cleaning include blowing down the surfaces with compressed air while the ventilation system is in operation, HEPA vacuuming, and/or wet wiping. If paint chips or dust is observed escaping from the containment materials during moving, all associated operations shall be halted and the materials and components recleaned.

The containment systems shall also meet the following requirements:

- a) Dry Abrasive Blast Cleaning - Full Containment with Negative Pressure (SSPC Class 1A)

The enclosure shall be designed, installed, and maintained to sustain maximum anticipated wind forces, including negative pressure. Flapping edges of containment materials are prohibited and the integrity of all containment materials, seams, and seals shall be maintained for the duration of the project. Airflow inside containment shall be designed to provide visibility and reduce worker exposures to toxic metals according to OSHA regulations and as specified in Table 1 and its accompanying text. When the location of the work on the bridge, or over lane closures permit, the blast enclosure shall extend a minimum of 3 ft. (1 m) beyond the limits of surface preparation to allow the workers to blast away from, rather than into the seam between the containment and the structure. The blast enclosure shall have an airlock or resealable door entryway to allow entrance and exit from the enclosure without allowing the escape of blasting residue.

If recyclable metallic abrasives are used, the Contractor shall operate the equipment in a manner that minimizes waste generation. Steps shall also be taken to minimize dust generation during the transfer of all abrasive/paint debris (expendable or recyclable

abrasives) for recycling or disposal. Acceptable methods include, but are not limited to vacuuming, screw or belt conveyance systems, or manual conveyance. However manual conveyance is only permitted if the work is performed inside a containment that is equipped with an operating ventilation system capable of controlling the dust that is generated.

Appropriate filtration shall be used on the exhaust air of dust collection and abrasive recycling equipment as required to comply with IEPA regulations. The equipment shall be enclosed if visible dust and debris are being emitted and/or the regulated area or high volume monitor lead levels are not in compliance.

Areas beneath containment connection points that were shielded from abrasive blast cleaning shall be prepared by vacuum blast cleaning or vacuum-shrouded power tool cleaning after the containment is removed.

b) Vacuum Blast Cleaning within Containment (SSPC-Class 4A)

Vacuum blasting equipment shall be fully automatic and capable of cleaning and recycling the abrasive. The system shall be designed to deliver cleaned, recycled blasting abrasives and provide a closed system containment during blasting. The removed coating, mill scale, and corrosion shall be separated from the abrasive, and stored for disposal.

The Contractor shall attach containment materials around and under the work area to catch and contain abrasive and waste materials in the event of an accidental escape from the vacuum shroud. This containment is in addition to the ground covers specified earlier.

It is possible that the close proximity of some structural steel members, such as the end diaphragms or end cross-frames underneath transverse deck expansion joints, preclude the use of the vacuum blasting equipment for the removal of the old paint. For surfaces that are inaccessible for the nozzles of the vacuum blasting equipment, the Contractor shall remove the paint by means of full containment inside a complete enclosure as directed by the Engineer.

c) Vacuum-Shrouded Power Tool Cleaning within Containment (SSPC-Class 3P)

The Contractor shall utilize power tools equipped with vacuums and High Efficiency Particulate Air (HEPA) filters. The Contractor shall attach containment walls around the work area, and install containment materials beneath the work area to catch and contain waste materials in the event of an accidental escape from the vacuum shroud. This containment is in addition to the ground covers specified earlier and shall be installed within 10 ft. (3m) of the areas being cleaned.

d) Power Tool Cleaning without Vacuum, within Containment (SSPC-Class 2P)

When the use of power tools without vacuum attachments is authorized by the Engineer, the Contractor shall securely install containment walls and flooring around the work area to capture and collect all debris that is generated. The containment material requirements for this Class 2P are similar to Class 3P used for vacuum-shrouded tools, but the supporting

structure will be more substantial in Class 2P to better secure the containment materials from excessive movement that could lead to the loss of waste paint chips and debris. Containment beneath the work shall be within 10 ft. (3m) of the areas being cleaned, and is in addition to the ground covers specified earlier.

e) Water Washing, Water Jetting or Wet Abrasive Blast Cleaning within Containment (SSPC Class 2W-3W)

Water washing of the bridge for the purpose of removing chalk, dirt, grease, oil, bird nests, and other surface debris, and water jetting or wet abrasive blast cleaning for the purpose of removing paint and surface debris shall be conducted within a containment designed, installed, and maintained in order to capture and contain all water and waste materials. The containment shall consist of impermeable floors and lower walls to prevent the water and debris from escaping. Permeable upper walls and ceilings are acceptable provided the paint chips, debris, and water, other than mists, are collected. A fine mist passing through the permeable upper walls is acceptable, provided the environmental controls specified below are met. If paint chips, debris, or water, other than mists, escape the containment system, impermeable walls and ceilings shall be installed.

When water is used for surface cleaning, the collected water shall be filtered to separate the particulate from the water. Recycling of the water is preferred in order to reduce the volume of waste that is generated. The water after filtration shall be collected and disposed of according to the waste handling portions of this specification.

When a slurry is created by injecting water into the abrasive blast stream, the slurry need not be filtered to separate water from the particulate.

Environmental Controls and Monitoring. The Contractor shall prepare and submit to the Engineer for review and acceptance, an Environmental Monitoring Plan. The purpose of the plan is to address the observations and equipment monitoring undertaken by the Contractor to confirm that project dust and debris are not escaping the containment into the surrounding air, soil, and water.

a) Soil and Water. Containment systems shall be maintained to prevent the escape of paint chips, abrasives, and other debris into the water, and onto the ground, soil, slope protection, and pavements. Releases or spills of, paint chips, abrasives, dust and debris that have become deposited on surrounding property, structures, equipment or vehicles, and bodies of water are unacceptable. If there are inadvertent spills or releases, the Contractor shall immediately shut down the emissions-producing operations, clean up the debris, and change work practices, modify the containment, or take other appropriate corrective action as needed to prevent similar releases from occurring in the future.

Water booms, boats with skimmers, or other means as necessary shall be used to capture and remove paint chips or project debris that falls or escapes into the water.

At the end of each workday at a minimum, the work area inside and outside of containment, including ground tarpaulins, shall be inspected to verify that paint debris is not present. If

debris is observed, it shall be removed by hand and HEPA-vacuuuming. If wet methods of preparation are used, the damp debris can remain overnight provided it is protected from accidental release by securely covering the waste, folding the waste into the ground tarps, or by other acceptable methods. Prior to commencing work the next day, the debris from the folded ground tarps shall be removed.

Upon project completion, the ground and water in and around the project site are considered to have been properly cleaned if paint chips, paint removal media (e.g., spent abrasives), fuel, materials of construction, litter, or other project debris have been removed.

NOTE: All project debris must be removed even if the debris (e.g., spent abrasive and paint chips) was a pre-existing condition.

- b) Visible Emissions. The Contractor shall conduct observations of visible emissions and releases on an ongoing daily basis when dust-producing activities are underway, such as paint removal, clean up, waste handling, and containment dismantling or relocation. Note that visible emissions observations do not apply to the fine mist that may escape through permeable containment materials when wet methods of preparation are used.

Visible emissions in excess of SSPC Guide 6, Level 1 (1% of the workday) are unacceptable. In an 8-hour workday, this equates to emissions of a cumulative duration no greater than 4.8 minutes (288 seconds). This criterion applies to scattered, random emissions of short duration. Sustained emissions from a given location (e.g., 1 minute or longer), regardless of the total length of emissions for the workday, are unacceptable and action shall be initiated to halt the emission.

If unacceptable visible emissions or releases are observed, the Contractor shall immediately shut down the emission-producing operations, clean up the debris, and change work practices, modify the containment, or take other appropriate corrective action as needed to prevent similar releases from occurring in the future.

- c) Ambient Air Monitoring. The Contractor shall perform ambient air monitoring according to the following:

- Monitor Siting. The Contractor shall collect and analyze air samples to evaluate levels of TSP-lead if there are sensitive receptors within 5 times the height of the structure or within 1000 ft. (305 m) of the structure, whichever is greater. If sensitive receptors are not located within these limits, monitoring is not required. Sensitive receptors are areas of public presence or access including, but not limited to, homes, schools, parks, playgrounds, shopping areas, livestock areas, and businesses. The motoring public is not considered to be a sensitive receptor for the purpose of ambient air monitoring.

The Contractor shall locate the monitors according to SSPC-TU-7, in areas of public exposure and in areas that will capture the maximum pollutant emissions resulting from the work. The Contractor shall identify the recommended monitoring sites in the Ambient Air Monitoring Plan, including a sketch identifying the above. The monitors shall not be sited until the Engineer accepts the proposed locations.

- Equipment Provided by Contractor. The Contractor shall provide up to 4 monitors per work site and all necessary calibration and support equipment, power to operate them, security (or arrangements to remove and replace the monitors daily), filters, flow chart recorders and overnight envelopes for shipping the filters to the laboratory. The number of monitors required will be indicated in the Plan Notes. Each monitor shall be tagged with the calibration date.
- Duration of Monitoring. Monitoring shall be performed for the duration of dust-producing operations (e.g., paint removal, waste handling, containment clean-up and movement, etc.) or a minimum of 8 hours each day (when work is performed).

The monitoring schedule shall be as follows:

1. For dry abrasive blast cleaning monitoring shall be conducted full time during all days of dust-producing operations (e.g., paint removal, waste handling, containment movement, etc.).
 2. For wet abrasive blast cleaning, water jetting, or power tool cleaning, monitoring shall be conducted for the first 5 days of dust producing operations. If the results after 5 days are acceptable, monitoring may be discontinued. If the results are unacceptable, corrective action shall be initiated to correct the cause of the emissions, and monitoring shall continue for an additional 5 days. If the results are still unacceptable, the Engineer may direct that the monitoring continue full time.
 3. When monitoring is discontinued, if visible emissions are observed and/or the Contractor's containment system changes during the course of the project, then air monitoring will again be required for a minimum of two consecutive days until compliance is shown.
- Background Monitoring. Background samples shall be collected for two days prior to the start of work while no dust producing operations are underway to provide a baseline. The background monitoring shall include one weekday and one weekend day. The background monitoring shall coincide with the anticipated working hours for the paint removal operations, but shall last for a minimum of 8 hours each day.
 - Monitor Operation and Laboratory Analysis.

The Contractor shall calibrate the monitors according to the manufacturer's written instructions upon mobilization to the site and quarterly. Each monitor shall be tagged with the calibration date, and calibration information shall be provided to the Engineer upon request.

All ambient air monitoring shall be performed by the Contractor according to the accepted Ambient Air Monitoring Plan and according to EPA regulations 40 CFR Part 50 Appendix B, Reference Method for the Determination of Suspended Particulate Matter in the Atmosphere (High-Volume Method), and 40 CFR Part 50 Appendix G, Reference Method for the Determination of Lead in Suspended Particulate Matter Collected from Ambient Air.

Filters shall be placed in monitors and monitors operated each day prior to start of dust-producing operations and the filters removed upon completion each day. The Contractor shall advise the Engineer in advance when the filters will be removed and replaced. The monitor operator shall record the following information, at a minimum, on field data and laboratory chain-of-custody forms (or equivalent):

1. Monitor location and serial number
2. Flow rate, supported by flow charts
3. Start, stop times and duration of monitoring
4. Work activities and location of work during the monitoring period
5. Wind direction/speed

For the first 5 days of monitoring, the Contractor shall submit the filters, field data and laboratory chain-of-custody forms together with the flow chart recorders (i.e. monitor flow rate and the duration of monitoring) on a daily basis in an overnight envelope to the laboratory for analysis. The laboratory must provide the Engineer with written results no later than 72 hours after the completion of each day's monitoring. At the discretion of the Engineer, if the initial 5 days of monitoring on full time monitoring projects is acceptable, the filters may be sent to the laboratory every 3 days rather than every day. Written results must be provided to the Engineer no later than 5 days after the completion of monitoring for the latest of the 3 days.

- Ambient Air Monitoring Results. The laboratory shall provide the report directly to the Engineer with a copy to the contractor. The report shall include:
 1. Monitor identification and location
 2. Work location and activities performed during monitoring period
 3. Monitor flow rate, duration, and volume of air sampled
 4. Laboratory methods used for filter digestion / analysis
 5. Sample results for the actual duration of monitoring
 6. Sample results expressed in terms of a 24 hour time weighted average. Assume zero for period not monitored.
 7. Comparison of the results with the acceptance criteria indicating whether the emissions are compliant.
 8. Field data and chain-of-custody records used to derive results.

Should revised reports or any information regarding the analysis be issued by the laboratory directly to the Contractor at any time, the contractor shall immediately provide a copy to the Engineer and advise the laboratory that the Engineer is to receive all information directly from the laboratory.

- Acceptance Criteria. TSP-lead results at each monitor location shall be less than 1.5 $\mu\text{g}/\text{cu m}$ per calendar quarter converted to a daily allowance using the formulas from

SSPC Guide 6 as follows, except that the maximum 24-hour daily allowance shall be no greater than 6 µg/cu m.

The formula for determining a 24-hour daily value based on the actual number of paint disturbance days expected to occur during the 90-day quarter is:

$$DA = (90 \div PD) \times 1.5 \mu\text{g}/\text{cu m}, \text{ where}$$

DA is the daily allowance, and

PD is the number of preparation days anticipated in the 90-day period

If the DA calculation is > 6.0 µg/cu m, use 6.0 µg/cu m.

Regulated Areas. Physically demarcated regulated area(s) shall be established around exposure producing operations at the OSHA Action Level for the toxic metal(s) present in the coating. The Contractor shall provide all required protective clothing and equipment for personnel entering into a regulated area. Unprotected street clothing is not permitted within the regulated areas.

Hygiene Facilities/Protective Clothing/Blood Tests. The Contractor shall provide clean lavatory and hand washing facilities according to OSHA regulations and confirm that employees wash hands, forearms, and face before breaks. The facilities shall be located at the perimeter of the regulated area in close proximity to the paint removal operation. Shower facilities shall be provided when workers' exposures exceed the Permissible Exposure Limit. Showers shall be located at each bridge site, or if allowed by OSHA regulations, at a central location to service multiple bridges. The shower and wash facilities shall be cleaned at least daily during use.

All wash and shower water shall be filtered and containerized. The Contractor is responsible for filtration, testing, and disposal of the water.

The Contractor shall make available to all IDOT project personnel a base line and post project blood level screening determined by the whole blood lead method, utilizing the Vena-Puncture technique. This screening shall be made available every 2 months for the first 6 months, and every 6 months thereafter.

The Contractor shall provide IDOT project personnel with all required protective clothing and equipment, including disposal or cleaning. Clothing and equipment includes but is not limited to disposable coveralls with hood, booties, disposable surgical gloves, hearing protection, and safety glasses. The protective clothing and equipment shall be provided and maintained on the job site for the exclusive, continuous and simultaneous use by the IDOT personnel. This equipment shall be suitable to allow inspection access to any area in which work is being performed.

All handwash and shower facilities shall be fully available for use by IDOT project personnel.

Site Emergencies.

a) Stop Work. The Contractor shall stop work at any time the conditions are not within specifications and take the appropriate corrective action. The stoppage will continue until conditions have been corrected. Standby time and cost required for corrective action is at the Contractor's expense. The occurrence of the following events shall be reported in writing to IDOT and shall require the Contractor to automatically stop lead paint removal and initiate clean up activities.

- Airborne lead levels at any of the high volume ambient air monitoring locations that exceed the limits in this specification, or airborne lead in excess of the OSHA Action Level at the boundary of the regulated area.
- Break in containment barriers.
- Visible emissions in excess of the specification tolerances.
- Loss of negative air pressure when negative air pressure is specified (e.g., for dry abrasive blast cleaning).
- Serious injury within the containment area.
- Fire or safety emergency
- Respiratory system failure
- Power failure

b) Contingency Plans and Arrangements. The Engineer will refer to the contingency plan for site specific instructions in the case of emergencies.

The Contractor shall prepare a contingency plan for emergencies including fire, accident, failure of power, failure of dust collection system, failure of supplied air system or any other event that may require modification of standard operating procedures during lead removal. The plan shall include specific procedures to ensure safe egress and proper medical attention in the event of an emergency. The Contractor shall post the telephone numbers and locations of emergency services including fire, ambulance, doctor, hospital, police, power company and telephone company on clean side of personnel decontamination area.

A two-way radio, or equal, as approved by the Engineer, capable of summoning emergency assistance shall be available at each bridge during the time the Contractor's personnel are at the bridge site under this contract. The following emergency response equipment described in the contingency plan (generic form attached) shall be available during this time as well: an appropriate portable fire extinguisher, a 55 gal (208 L) drum, a 5 gal (19 L) pail, a long handled shovel, absorbent material (one bag).

A copy of the contingency plan shall be maintained at each bridge during cleaning operations and during the time the Contractor's personnel are at the bridge site under this contract. The Contractor shall designate the emergency coordinator(s) required who shall be responsible for the activities described.

An example of a contingency plan is included at the end of this Special Provision.

Collection, Temporary Storage, Transportation and Disposal of Waste. The Contractor and the Department are considered to be co-generators of the waste.

The Contractor is responsible for all aspects of waste collection, testing and identification, handling, storage, transportation, and disposal according to these specifications and all applicable Federal, State, and Local regulations. The Contractor shall provide for Engineer review and acceptance a Waste Management Plan that addresses all aspects of waste handling, storage, and testing, and provides the names, addresses, and a contact person for the proposed licensed waste haulers and disposal facilities. The Department will not perform any functions relating to the waste other than provide EPA identification numbers, provide the Contractor with the emergency response information, the emergency response telephone number required to be provided on the manifest, and to sign the waste manifest. The Engineer will obtain the identification numbers from the state and federal environmental protection agencies for the bridge(s) to be painted and furnish those to the Contractor.

All surface preparation/paint residues shall be collected daily and deposited in all-weather containers supplied by the Contractor as temporary storage. The storage area shall be secure to prevent unauthorized entry or tampering with the containers. Acceptable measures include storage within a fully enclosed (e.g., fenced in) and locked area, within a temporary building, or implementing other reasonable means to reduce the possibility of vandalism or exposure of the waste to the public or the environment (e.g., securing the lids or covers of waste containers and roll-off boxes). Waste shall not be stored outside of the containers. Waste shall be collected and transferred to bulk containers taking extra precautions as necessary to prevent the suspension of residues in air or contamination of surrounding surfaces. Precautions may include the transfer of the material within a tarpaulin enclosure. Transfer into roll-off boxes shall be planned to minimize the need for workers to enter the roll-off box.

No residues shall remain on surfaces overnight, either inside or outside of containment. Waste materials shall not be removed through floor drains or by throwing them over the side of the bridge. Flammable materials shall not be stored around or under any bridge structures.

The all-weather containers shall meet the requirements for the transportation of hazardous materials and as approved by the Department. Acceptable containers include covered roll-off boxes and 55-gallon drums (17H). The Contractor shall insure that no breaks and no deterioration of these containers occurs and shall maintain a written log of weekly inspections of the condition of the containers. A copy of the log shall be furnished to the Engineer upon request. The containers shall be kept closed and sealed from moisture except during the addition of waste. Each container shall be permanently identified with the date that waste was placed into the container, contract number, hazardous waste name and ID number, and other information required by the IEPA.

The Contractor shall have each waste stream sampled for each project and tested by TCLP and according to EPA and disposal company requirements. The Engineer shall be notified in advance when the samples will be collected. The samples shall be collected and shipped for testing within the first week of the project, with the results due back to the Engineer within 10 days. Testing shall be considered included in the pay item for "Containment and Disposal of

Lead Paint Cleaning Residues." Copies of the test results shall be provided to the Engineer prior to shipping the waste.

Waste water generated from bridge washing, hygiene purposes, and cleaning of equipment shall be filtered on site to remove particulate and disposed of at a Publicly Owned Treatment Works (POTW) according to State regulations. The Contractor shall provide the Engineer with a letter from the POTW indicating that they will accept the waste water. If the POTW allows the filtered water to be placed into the sanitary sewer system, the Contractor shall provide a letter from the POTW indicating that based on the test results of the water, disposal in the sanitary sewer is acceptable to them. Water shall not be disposed of until the above letter(s) are provided to, and accepted by, the Engineer.

If approved abrasive additives are used that render the waste non-hazardous as determined by TCLP testing, the waste shall be classified as a non-hazardous special waste, transported by a licensed waste transporter, and disposed of at an IEPA permitted disposal facility in Illinois.

When paint is removed from the bridge without the use of abrasive additives, the paint, together with the surface preparation media (e.g. abrasive) shall be handled as a hazardous waste, regardless of the TCLP results. The waste shall be transported by a licensed hazardous waste transporter, treated by an IEPA permitted treatment facility to a non-hazardous special waste and disposed of at an IEPA permitted disposal facility in Illinois.

The treatment/disposal facilities shall be approved by the Engineer, and shall hold an IEPA permit for waste disposal and waste stream authorization for this cleaning residue. The IEPA permit and waste stream authorization must be obtained prior to beginning cleaning, except that if necessary, limited paint removal will be permitted in order to obtain samples of the waste for the disposal facilities. The waste shall be shipped to the facility within 90 days of the first accumulation of the waste in the containers. When permitted by the Engineer, waste from multiple bridges in the same contract may be transported by the Contractor to a central waste storage location(s) approved by the Engineer in order to consolidate the material for pick up, and to minimize the storage of waste containers at multiple remote sites after demobilization. Arrangements for the final waste pickup shall be made with the waste hauler by the time blast cleaning operations are completed or as required to meet the 90 day limit stated above.

The Contractor shall submit a waste accumulation inventory table to the Engineer no later than the 5th day of the month. The table shall show the number and size of waste containers filled each day in the preceding month and the amount of waste shipped that month, including the dates of shipments.

The Contractor shall prepare a manifest supplied by the IEPA for off-site treatment and disposal before transporting the hazardous waste off-site. The Contractor shall prepare a land ban notification for the waste to be furnished to the disposal facility. The Contractor shall obtain the handwritten signature of the initial transporter and date of the acceptance of the manifest. The Contractor shall send one copy of the manifest to the IEPA within two working days of transporting the waste off-site. The Contractor shall furnish the generator copy of the manifest and a copy of the land ban notification to the Engineer. The Contractor shall give the transporter the remaining copies of the manifest.

All other project waste shall be removed from the site according to Federal, State and Local regulations, with all waste removed from the site prior to final Contractor demobilization.

The Contractor shall make arrangements to have other hazardous waste, which he/she generates, such as used paint solvent, transported to the Contractor's facility at the end of each day that this waste is generated. These hazardous wastes shall be manifested using the Contractor's own generator number to a treatment or disposal facility from the Contractor's facility. The Contractor shall not combine solvents or other wastes with cleaning residue wastes. All waste streams shall be stored in separate containers.

The Contractor is responsible for the payment of any fines and undertaking any clean up activities mandated by State or federal environmental agencies for improper waste handling, storage, transportation, or disposal.

Contractor personnel shall be trained in the proper handling of hazardous waste, and the necessary notification and clean up requirements in the event of a spill. The Contractor shall maintain a copy of the personnel training records at each bridge site.

Basis of Payment. The soil, water, and air monitoring, containment, collection, temporary storage, transportation, testing and disposal of all project waste, and all other work described herein will be paid for at the contract lump sum price for CONTAINMENT AND DISPOSAL OF LEAD PAINT CLEANING RESIDUES at the designated location. Payment will not be authorized until all requirements have been fulfilled as described in this specification, including the preparation and submittal of all QC documentation, submittal of environmental monitoring and waste test results, and disposal of all waste.

Appendix 1 – Reference List

The Contractor shall maintain the following reference standards and regulations on site for the duration of the project:

- Illinois Environmental Protection Agency – Information Statement on the Removal of Lead-Based Paint from Exterior Surfaces, latest revision
- Illinois Environmental Protection Act
- SSPC Guide 6, Guide for Containing Debris Generated During Paint Removal Operations
- 29 CFR 1926.62, Lead in Construction
- 40 CFR Part 50, Appendix B, Reference Method for the Determination of Suspended Particulate Matter in the Atmosphere (High-Volume Method)
- 40 CFR Part 50, Appendix G, Reference Method for the Determination of Lead in Suspended Particulate Matter Collected from Ambient Air
- SSPC Guide 16, Guide to Specifying and Selecting Dust Collectors
- SSPC TU-7, Conducting Ambient Air, Soil, and Water Sampling Activities During Surface Preparation and Paint Disturbance Activities.

Table 1					
Containment Criteria for Removal of Paint Containing Lead and Other Toxic Metals¹					
Removal Method	SSPC Class²	Containment Material Flexibility	Containment Material Permeability³	Containment Support Structure	Containment Material Joints⁴
Hand Tool Cleaning	3P ⁶	Rigid or Flexible	Permeable or Impermeable	Minimal	Partially Sealed
Power Tool Cleaning w/ Vacuum	3P ⁶	Rigid or Flexible	Permeable or Impermeable	Minimal	Partially Sealed
Power Tool Cleaning w/o Vacuum	2P	Rigid or Flexible	Permeable or Impermeable	Rigid or Flexible	Fully or Partially Sealed
Water Jetting Wet Ab Blast Water Cleaning ⁷	2W-3W	Rigid or Flexible	Permeable and Impermeable ⁷	Rigid, Flexible, or Minimal	Fully and Partially Sealed
Abrasive Blast Cleaning	1A	Rigid or Flexible	Impermeable	Rigid or Flexible	Fully Sealed
Vacuum Blast Cleaning	4A ⁶	Rigid or Flexible	Permeable	Minimal	Partially Sealed

Table 1 (Continued)					
Containment Criteria for Removal of Paint Containing Lead and Other Toxic Metals¹					
Removal Method	SSPC Class²	Containment Entryway	Ventilation System Required⁵	Negative Pressure Required	Exhaust Filtration Required
Hand Tool Cleaning	3P ⁶	Overlapping or Open Seam	Natural	No	No
Power Tool Cleaning w/ Vacuum	3P ⁶	Overlapping or Open Seam	Natural	No	No
Power Tool Cleaning w/o Vacuum	2P	Overlapping or Open Seam	Natural	No	No
Water Jetting Wet Ab Blast Water Cleaning ⁷	2W-3W	Overlapping or Open Seam	Natural	No	No
Abrasive Blast Cleaning	1A	Airlock or Resealable	Mechanical	Yes	Yes
Vacuum Blast Cleaning	4A ⁶	Open Seam	Natural	No	No

Notes:

¹This table provides general design criteria only. It does not guarantee that specific controls over emissions will occur because unique site conditions must be considered in the design. Other combinations of materials may provide controls over emissions equivalent to or greater than those combinations shown above.

²The SSPC Classification is based on SSPC Guide 6. Note that for work over water, water booms or boats with skimmers must be employed, where feasible, to contain spills or releases. Debris must be removed daily at a minimum.

³Permeability addresses both air and water as appropriate. In the case of water removal methods, the containment materials must be resistant to water. Ground covers should always be impermeable, and of sufficient strength to withstand the impact and weight of the debris and the equipment used for collection and clean-up. Ground covers must also extend beyond the containment boundary to capture escaping debris.

⁴ If debris escapes through the seams, then additional sealing of the seams and joints is required.

⁵When "Natural" is listed, ventilation is not required provided the emissions are controlled as specified in this Special Provision, and provided worker exposures are properly controlled. If unacceptable emissions or worker exposures to lead or other toxic metals occur, incorporate a ventilation system into the containment.

⁶Ground covers and wall tarpaulins may provide suitable controls over emissions without the need to completely enclose the work area.

⁷This method applies to water cleaning to remove surface contaminants, and water jetting (with and without abrasive) and wet abrasive blast cleaning where the goal is to remove paint. Although both permeable and impermeable containment materials are included, ground covers and the lower portions of the containment must be water impermeable with fully sealed joints, and of sufficient strength and integrity to facilitate the collection and holding of the water and debris for proper disposal. If water or debris, other than mist, escape through upper sidewalls or ceiling areas constructed of permeable materials, they shall be replaced with impermeable materials. Permeable materials for the purpose of this specification are defined as materials with openings measuring 25 mils (1 micron) or less in greatest dimension.

- A. Containment Components - The basic components that make up containment systems are defined below. The components are combined in Table 1 to establish the minimum containment system requirements for the method(s) of paint removal specified for the Contract.
1. Rigidity of Containment Materials - Rigid containment materials consist of solid panels of plywood, aluminum, rigid metal, plastic, fiberglass, composites, or similar materials. Flexible materials consist of screens, tarps, drapes, plastic sheeting, or similar materials. When directed by the Engineer, do not use flexible materials for horizontal surfaces directly over traffic lanes or vertical surfaces in close proximity to traffic lanes. If the Engineer allows the use of flexible materials, The Contractor shall take special precautions to completely secure the materials to prevent any interference with traffic.
 2. Permeability of Containment Materials - The containment materials are identified as air impenetrable if they are impervious to dust or wind such as provided by rigid panels, coated solid tarps, or plastic sheeting. Air penetrable materials are those that are formed or woven to allow air flow. Water impermeable materials are those that are capable of containing and controlling water when wet methods of preparation are used. Water permeable materials allow the water to pass through. Chemical resistant materials are those resistant to chemical and solvent stripping solutions. Use fire retardant materials in all cases.
 3. Support Structure - Rigid support structures consist of scaffolding and framing to which the containment materials are affixed to minimize movement of the containment cocoon. Flexible support structures are comprised of cables, chains, or similar systems to which the containment materials are affixed. Use fire retardant materials in all cases.
 4. Containment Joints - Fully sealed joints require that mating surfaces between the containment materials and to the structure being prepared are completely sealed. Sealing measures include tape, caulk, Velcro, clamps, or other similar material capable of forming a continuous, impenetrable or impermeable seal. When materials are overlapped, a minimum overlap of 8 in. (200 mm) is required.
 5. Entryway - An airlock entryway involves a minimum of one stage that is fully sealed to the containment and which is maintained under negative pressure using the ventilation system of the containment. Resealable door entryways involve the use of flexible or rigid doors capable of being repeatedly opened and resealed. Sealing methods include the use of zippers, Velcro, clamps, or similar fasteners. Overlapping door tarpaulin entryways consist of two or three overlapping door tarpaulins.

6. Mechanical Ventilation - The requirement for mechanical ventilation is to ensure that adequate air movement is achieved to reduce worker exposure to toxic metals to as low as feasible according to OSHA regulations (e.g., 29 CFR 1926.62), and to enhance visibility. Design the system with proper exhaust ports or plenums, adequately sized ductwork, adequately sized discharge fans and air cleaning devices (dust collectors) and properly sized and distributed make-up air points to achieve a uniform air flow inside containment for visibility. The design target for airflow shall be a minimum of 100 ft. (30.5m) per minute cross-draft or 60 ft. (18.3 m) per minute downdraft. Increase these minimum airflow requirements if necessary to address worker lead exposures. Natural ventilation does not require the use of mechanical equipment for moving dust and debris through the work area.
7. Negative Pressure - When specified, achieve a minimum of 0.03 in. (7.5 mm) water column (W.C.) relative to ambient conditions, or confirm through visual assessments for the concave appearance of the containment enclosure.
8. Exhaust Ventilation - When mechanical ventilation systems are used, provide filtration of the exhaust air, to achieve a filtration efficiency of 99.9 percent at 0.02 mils (0.5 microns).

HAZARDOUS WASTE
CONTINGENCY PLAN
FOR
LEAD BASED PAINT REMOVAL PROJECTS

Bridge No.: _____
Location: _____
USEPA Generator No.: _____
IEPA Generator No.: _____

Note:

1. A copy of this plan must be kept at the bridge while the Contractor's employees are at the site.
2. A copy of the plan must be mailed to the police and fire departments and hospital identified herein.

Primary Emergency Coordinator

Name: _____
Address: _____
City: _____
Phone: (Work) _____
(Home) _____

Alternate Emergency Coordinator

Name: _____
Address: _____
City: _____
Phone: (Work) _____
(Home) _____

Emergency Response Agencies

POLICE:

1. State Police (if bridge not in city) Phone: _____
District No. _____
Address: _____
2. County Sheriff _____ Phone: _____
County: _____
Address: _____
3. City Police _____ Phone: _____
District No. _____
Address: _____

Arrangements made with police: (Describe arrangements or refusal by police to make arrangements):

FIRE:

1. City _____ Phone: _____
Name: _____
Address: _____
2. Fire District _____ Phone: _____
Name: _____
Address: _____

3. Other _____ Phone: _____

Name: _____

Address: _____

Arrangements made with fire departments: (Describe arrangements or refusal by fire departments to make arrangements):

HOSPITAL:

Name: _____ Phone: _____

Address: _____

Arrangements made with hospital: (Describe arrangements or refusal by hospital to make arrangements):

Properties of waste and hazard to health:

Places where employees working:

Location of Bridge:

Types of injuries or illness which could result:

Appropriate response to release of waste to the soil:

Appropriate response to release of waste to surface water:

Emergency Equipment at Bridge

Emergency Equipment List	Location of Equipment	Description of Equipment	Capability of Equipment
1. Two-way radio	Truck		Communication
2. Portable Fire Extinguisher	Truck		Extinguishes Fire
3. Absorbent Material	Truck		Absorbs Paint or Solvent Spills
4. Hand Shovel	Truck		Scooping Material
5. 55 Gallon (208 L) Drum	Truck		Storing Spilled Material
6. 5 Gallon (19 L) Pail	Truck		Storing Spilled Material

Emergency Procedure

1. Notify personnel at the bridge of the emergency and implement emergency procedure.
2. Identify the character, source, amount and extent of released materials.
3. Assess possible hazards to health or environment.
4. Contain the released waste or extinguish fire. Contact the fire department if appropriate.
5. If human health or the environment is threatened, contact appropriate police and fire department. In addition, the Emergency Services and Disaster Agency needs to be called using their 24-hour toll free number (800-782-7860) and the National Response Center using their 24-hour toll free number (800-824-8802).
6. Notify the Engineer that an emergency has occurred.
7. Store spilled material and soil contaminated by spill, if any, in a drum or pail. Mark and label the drum or pail for disposal.
8. Write a full account of the spill or fire incident including date, time, volume, material, and response taken.
9. Replenish stock of absorbent material or other equipment used in response.

DECK SLAB REPAIR

Effective: May 15, 1995

Revised: October 15, 2011

This work shall consist of hot-mix asphalt surface removal, when required, the removal and disposal of all loose and deteriorated concrete from bridge deck and the replacement with new concrete to the original top of deck. The work shall be done according to the applicable requirements of Sections 501, 503 and 1020 of the Standard Specifications and this Special Provision.

Deck slab repairs will be classified as follows:

- (a) Partial-Depth. Partial-depth repairs shall consist of removing the loose and unsound deck concrete, disposing of the concrete removed and replacing with new concrete. The removal may be performed by chipping with power driven hand tools or by hydro-scarification equipment. The depth shall be measured from the top of the concrete deck surface, at least 3/4 in. (20 mm) but not more than 1/2 the concrete deck thickness.
- (b) Full-Depth. Full-depth repairs shall consist of removing concrete full-depth of the deck, disposing of the concrete removed, and replacing with new concrete to the original concrete deck surface. The removal may be performed with power driven hand tools, hydraulic impact equipment, or by hydro-scarification equipment. Full-depth repairs shall be classified for payment as Full-Depth, Type I and Full-Depth, Type II according to the following:

Type I Full-depth patches less than or equal to 5 sq. ft. (0.5 sq m) in area. The minimum dimensions for a patch shall be 1 ft. x 1 ft. (300 mm x 300 mm).

Type II Full-depth patches greater than 5 sq. ft. (0.5 sq. m) in area.

Materials.

Materials shall be according to Article 1020.02.

Portland cement concrete for partial and full-depth repairs shall be according to Section 1020. Class PP-1, PP-2, PP-3, PP-4, PP-5 or BS concrete shall be used at the Contractor's option unless noted otherwise on the contract plans. For Class BS concrete, a CA 13, 14, or 16 shall be used. If the BS concrete mixture is used only for full depth repairs, a CA-11 may be used.

Equipment:

The equipment used shall be subject to the approval of the Engineer and shall meet the following requirements:

(a) Surface Preparation Equipment. Surface preparation and concrete removal equipment shall be according to the applicable portions of Section 1100 and the following:

- (1) Sawing Equipment. Sawing equipment shall be a concrete saw capable of sawing concrete to the specified depth.
- (2) Blast Cleaning Equipment. The blast cleaning may be performed by wet sandblasting, high-pressure waterblasting, shotblasting or abrasive blasting. Blast cleaning equipment shall be capable of removing rust and old concrete from exposed reinforcement bars, and shall have oil traps.
- (3) Power-Driven Hand Tools. Power-driven hand tools will be permitted including jackhammers lighter than the nominal 45 lb. (20 kg) class. Chipping hammers heavier than a nominal 15 lb. (6.8 kg) class shall not be used for removing concrete from below any reinforcing bar for partial depth repairs, or for removal within 1 ft (300 mm) of existing beams, girders or other supporting structural members that are to remain in service or within 1 ft (300 mm) of the boundaries of full-depth repairs. Jackhammers or chipping hammers shall not be operated at an angle in excess of 45 degrees measured from the surface of the slab.
- (4) Hydraulic Impact Equipment. Hydraulic impact equipment with a maximum rated striking energy of 360 ft-lbs (270 J) may be permitted only in areas of full depth removal more than 1 ft (300 mm) away from existing beams, girders or other supporting structural members that are to remain in service or more than 1 ft (300 mm) from the boundaries of full-depth repairs.
- (5) Hydro-Demolition Equipment. The hydro-demolition equipment shall consist of filtering and pumping units operating with a remote-controlled robotic device. The equipment shall use water according to Section 1002. The equipment shall be capable of being controlled to remove only unsound concrete.

(b) Concrete Equipment: Equipment for proportioning and mixing the concrete shall be according to Article 1020.03.

(c) Finishing Equipment: Finishing equipment shall be according to Article 1103.17. Adequate hand tools will be permitted for placing and consolidating concrete in the patch areas and for finishing small patches.

Construction Requirements: Sidewalks, curbs, drains, reinforcement and/or existing transverse and longitudinal joints which are to remain in place shall be protected from damage during removal and cleaning operations.

The Contractor shall control the runoff water generated by the various construction activities in such a manner as to minimize, to the maximum extent practicable, the discharge of untreated effluent into adjacent waters, and shall properly dispose of the solids generated according to Article 202.03. The Contractor shall submit a water management plan to the Engineer

specifying the control measures to be used. The control measures shall be in place prior to the start of runoff water generating activities. Runoff water shall not be allowed to constitute a hazard to adjacent or underlying roadways, waterways, drainage areas or railroads nor be allowed to erode existing slopes.

(a) Hot-Mix Asphalt Surface Removal.

The hot-mix asphalt surface course and all waterproofing membrane shall be removed and disposed of according to applicable portions of Articles 440.04 and 440.06, except milling equipment will not be allowed if the deck is to receive a waterproofing membrane system. If the overlay or waterproofing membrane contains asbestos fibers, removal shall be in accordance with the Special Provision for "Asbestos Waterproofing Membrane or Asbestos Hot-mix Asphalt Surface Removal". Removal of the hot-mix asphalt surface by the use of radiant or direct heat will not be permitted.

(b) Surface Preparation:

All loose, disintegrated and unsound concrete shall be removed from portions of the deck slab shown on the plans or as designated by the Engineer. The Engineer will determine the limits of removal as the work progresses.

The Contractor shall take care not to damage reinforcement bars or expansion joints which are to remain in place. Any damage to reinforcement bars or expansion joints shall be corrected at the Contractor's expense. All loose reinforcement bars, as determined by the Engineer, shall be retied at the Contractor's expense.

(1) Partial-Depth. Areas to be repaired will be determined and marked by the Engineer. A concrete saw shall be used to provide vertical edges approximately 3/4 in. (20 mm) deep around the perimeter of the area to be patched when a concrete overlay is not specified. Where high steel is present, the depth may be reduced as directed by the Engineer. A saw cut will not be required on those boundaries along the face of the curb, parapet or joint or when sharp vertical edges are provided by hydro-demolition.

The loose and unsound concrete shall be removed by chipping, with power driven hand tools or by hydro-demolition equipment. All exposed reinforcing bars and newly exposed concrete shall be thoroughly blast cleaned. Where, in the judgment of the Engineer, the bond between existing concrete and reinforcement steel within the patch area has been destroyed, the concrete adjacent to the bar shall be removed to a depth that will permit new concrete to bond to the entire periphery of the exposed bar. A minimum of 1 in. (25 mm) clearance will be required. The Engineer may require enlarging a designated removal area should inspection indicate deterioration beyond the limits previously designated. In this event, a new saw cut shall be made around the extended area before additional removal is begun. The removal area shall not be enlarged solely to correct debonded reinforcement or deficient lap lengths.

- (2) Full-Depth. Concrete shall be removed as determined by the Engineer within all areas designated for full-depth repair and in all designated areas of partial depth repair in which unsound concrete is found to extend below half the concrete deck thickness. Full depth removal shall be performed according to Article 501.05 except that hydraulic impact equipment may be permitted in areas of full depth removal more than 1 ft (300 mm) away from the edges of existing beams, girders or other supporting structural members or more than 1 ft (300 mm) from the boundaries of full-depth repairs. Saw cuts shall be made on the top of the deck, except those boundaries along the face of curbs, parapets and joints or where hydro-demolition provided sharp vertical edges. The top saw cut may be omitted if the deck is to receive an overlay.

Forms for full-depth repair may be supported by hangers with adjustable bolts or by blocking from the beams below. When approved by the Engineer, forms for Type 1 patches may be supported by No. 9 wires or other devices attached to the reinforcement bars.

All form work shall be removed after the curing sequence is complete and prior to opening to traffic.

- (3) Reinforcement Treatment. Care shall be exercised during concrete removal to protect the reinforcement bars and structural steel from damage. Any damage to the reinforcement bars or structural steel to remain in place shall be repaired or replaced. All existing reinforcement bars shall remain in place except as herein provided for corroded bars. Tying of loose bars will be required. Reinforcing bars which have been cut or have lost 25 percent or more of their original cross sectional area shall be supplemented by new in kind reinforcement bars. New bars shall be lapped a minimum of 32 bar diameters to existing bars. An approved mechanical bar splice capable of developing in tension at least 125 percent of the yield strength of the existing bar shall be used when it is not feasible to provide the minimum bar lap. No welding of bars will be permitted.
- (4) Cleaning. Immediately after completion of the concrete removal and reinforcement repairs, the repair areas shall be cleaned of dust and debris. Once the initial cleaning is completed, the repair areas shall be thoroughly blast cleaned to a roughened appearance free from all foreign matter. Particular attention shall be given to removal of concrete fines. Any method of cleaning which does not consistently produce satisfactory results shall be discontinued and replaced by an acceptable method. All debris, including water, resulting from the blast cleaning shall be confined and shall be immediately and thoroughly removed from all areas of accumulation. If concrete placement does not follow immediately after the final cleaning, the area shall be carefully protected with well-anchored polyethylene sheeting.

Exposed reinforcement bars shall be free of dirt, detrimental scale, paint, oil, or other foreign substances which may reduce bond with the concrete. A tight non-scaling

coating of rust is not considered objectionable. Loose, scaling rust shall be removed by rubbing with burlap, wire brushing, blast cleaning or other methods approved by the Engineer.

(c) Placement & Finishing of Concrete Repair:

(1) Bonding Method. The patch area shall be cleaned to the satisfaction of the Engineer and shall be thoroughly wetted and maintained in a dampened condition with water for at least 12 hours before placement of the concrete. Any excess water shall be removed by compressed air or by vacuuming prior to the beginning of concrete placement. Water shall not be applied to the patch surface within one hour before or at any time during placement of the concrete.

(2) Concrete Placement.

The concrete shall be placed and consolidated according to Article 503.07 and as herein specified. Article 1020.14 shall apply.

When an overlay system is not specified, the patches shall be finished according to Article 503.16 (a), followed by a light brooming.

(d) Curing and Protection.

Concrete patches shall be cured by the Wetted Burlap or Wetted Cotton Mat Method according to Article 1020.13 (a)(3) or Article 1020.13 (a)(5). The curing period shall be 3 days for Class PP-1, PP-2, PP-3, PP-4, and PP-5 concrete. The curing period shall be 7 days for Class BS concrete. In addition to Article 1020.13, when the air temperature is less than 55° F (13° C), the Contractor shall cover the patch according to Article 1020.13 (d)(1) with minimum R12 insulation. Insulation is optional when the air temperature is 55° F. - 90° F (13° C - 32° C). Insulation shall not be placed when the air temperature is greater than 90° F (32° C). A 72-hour minimum drying period shall be required before placing waterproofing or hot-mix asphalt surfacing.

(e) Opening to Traffic.

No traffic will be permitted on a patch until after the specified cure period, and the concrete has obtained a minimum compressive strength of 4000 psi (27.6 MPa) or flexural strength of 675 psi (4.65 MPa).

Construction equipment will be permitted on a patch during the cure period if the concrete has obtained the minimum required strength. In this instance, the strength specimens shall be cured with the patch.

Method of Measurement.

When specified, hot-mix asphalt surface removal and full or partial depth repairs will be measured for payment and computed in square yards (square meters).

Basis of Payment.

The hot-mix asphalt surface removal will be paid for at the contract unit price per square yard (square meter) for HOT-MIX ASPHALT SURFACE REMOVAL (DECK). Areas removed and replaced up to and including a depth of half the concrete deck thickness will be paid for at the contract unit price per square yard (square meter) for DECK SLAB REPAIR (PARTIAL). Areas requiring removal greater than a depth of half the concrete deck thickness shall be removed and replaced full depth and will be paid for at the contract unit price per square yard (square meter) for DECK SLAB REPAIR (FULL DEPTH, TYPE I) and/or DECK SLAB REPAIR (FULL DEPTH, TYPE II).

When corroded reinforcement bars are encountered in the performance of this work and replacement is required, the Contractor will be paid according to Article 109.04.

No payment will be allowed for removal and replacement of reinforcement bars damaged by the Contractor in the performance of his/her work or for any increases in dimensions needed to provide splices for these replacement bars.

Removal and disposal of asbestos waterproofing and/or asbestos bituminous concrete will be paid for as specified in the Special Provision for "Asbestos Waterproofing Membrane or Asbestos Hot-Mix Asphalt Surface Removal".

STRUCTURAL REPAIR OF CONCRETE

Effective: March 15, 2006

Revised: July 26, 2013

Description. This work shall consist of structurally repairing concrete.

Materials. Materials shall be according to the following.

Item	Article/Section
(a) Portland Cement Concrete (Note 1)	1020
(b) R1 or R2 Concrete (Note 2)	
(c) Normal Weight Concrete (Notes 3 and 4)	
(d) Shotcrete (High Performance) (Note 5)	
(e) Reinforcement Bars	1006.10
(f) Anchor Bolts	1006.09
(g) Water	1002
(h) Curing Compound (Type I)	1022.01
(i) Cotton Mats	1022.02
(j) Protective Coat	1023.01
(k) Epoxy (Note 6)	1025
(l) Mechanical Bar Splicers	508.06(c)

Note 1. The concrete shall be Class SI, except the cement factor shall be a minimum 6.65 cwt/cu yd (395 kg/cu m), the coarse aggregate shall be a CA 16, and the strength shall be a minimum 4000 psi (27,500 kPa) compressive or 675 psi (4650 kPa) flexural at 14 days. A high range water-reducing admixture shall be used to obtain a 5-7 in. (125-175 mm) slump, but a cement factor reduction according to Article 1020.05(b)(8) is prohibited. A self-consolidating concrete mixture is also acceptable per Article 1020.04, except the mix design requirements of this note regarding the cement factor, coarse aggregate, strength, and cement factor reduction shall apply.

Note 2. The R1 or R2 concrete shall be from the Department's approved list of Packaged, Dry, Rapid Hardening, Cementitious Materials for Concrete Repairs. The R1 or R2 concrete shall comply with the air content and strength requirements for Class SI concrete as indicated in Note 1. Mixing shall be per the manufacturer's recommendations, except the water/cement ratio shall not exceed the value specified for Class SI concrete as indicated in Note 1. A high range water-reducing admixture shall be used to obtain a 5-7 in. (125-175 mm) slump, and a retarder may be required to allow time to perform the required field tests. The admixtures shall be per the manufacturer's recommendation, and the Department's approved list of Concrete Admixtures shall not apply.

Note 3. The "high slump" packaged concrete mixture shall be from the Department's approved list of Packaged, Dry, Formed, Concrete Repair Mixtures. The materials and preparation of aggregate shall be according to ASTM C 387. The cement

factor shall be 6.65 cwt/cu yd (395 kg/cu m) minimum to 7.05 cwt/cu yd (418 kg/cu m) maximum. Cement replacement with fly ash or ground granulated blast-furnace slag shall be according to Section 1020. The "high slump" packaged concrete mixture shall have a water soluble chloride ion content of less than 0.40 lb/cu yd (0.24 kg/cu m). The test shall be performed according to ASTM C 1218, and the "high slump" packaged concrete mixture shall have an age of 28 to 42 days at the time of test. The ASTM C 1218 test shall be performed by an independent lab a minimum of once every two years, and the test results shall be provided to the Department. The coarse aggregate shall be a maximum size of 1/2 in. (12.5 mm). The packaged concrete mixture shall comply with the air content and strength requirements for Class SI concrete as indicated in Note 1. Mixing shall be per the manufacturer's recommendations, except the water/cement ratio shall not exceed the value specified for Class SI concrete as indicated in Note 1. A high range water-reducing admixture shall be used to obtain a 5-7 in. (125-175 mm) slump. The admixture shall be per the manufacturer's recommendation, and the Department's approved list of Concrete Admixtures shall not apply. A maximum slump of 10 in. (250 mm) may be permitted if no segregation is observed by the Engineer in a laboratory or field evaluation.

Note 4 The "self-consolidating concrete" packaged concrete mixture shall be from the Department's approved list of Packaged, Dry, Formed, Concrete Repair Mixtures. The materials and preparation of aggregate shall be according to ASTM C 387. The cement factor shall be 6.65 cwt/cu yd (395 kg/cu m) minimum to 7.05 cwt/cu yd (418 kg/cu m) maximum. Cement replacement with fly ash or ground granulated blast-furnace slag shall be according to Section 1020. The "self-consolidating concrete" packaged concrete mixture shall have a water soluble chloride ion content of less than 0.40 lb/cu yd (0.24 kg/cu m). The test shall be performed according to ASTM C 1218, and the "self-consolidating concrete" packaged concrete mixture shall have an age of 28 to 42 days at the time of test. The ASTM C 1218 test shall be performed by an independent lab a minimum of once every two years, and the test results shall be provided to the Department. The concrete mixture should be uniformly graded, and the coarse aggregate shall be a maximum size of 1/2 in. (12.5 mm). The fine aggregate proportion shall be a maximum 50 percent by weight (mass) of the total aggregate used. The packaged concrete mixture shall comply with the air content and strength requirements for Class SI concrete as indicated in Note 1. Mixing shall be per the manufacturer's recommendations, except the water/cement ratio shall not exceed the value specified for Class SI concrete as indicated in Note 1. The admixtures used to produce self-consolidating concrete shall be per the manufacturer's recommendation, and the Department's approved list of Concrete Admixtures shall not apply. The packaged concrete mixture shall meet the following self-consolidating requirements:

- The slump flow range shall be 22 in. (560 mm) minimum to 28 in. (710 mm) maximum and tested according to Illinois Test Procedure SCC-2.

- The visual stability index shall be a maximum of 1 and tested according to Illinois Test Procedure SCC-2.
- The J-Ring value shall be a maximum of 2 in. (50 mm) and tested according to Illinois Test Procedure SCC-3. The L-Box blocking ratio shall be a minimum of 80 percent and tested according to Illinois Test Procedure SCC-4. The Manufacturer has the option to select either the J-Ring or L-Box test.
- The hardened visual stability index shall be a maximum of 1 and tested according to Illinois Test Procedure SCC-6.

Note 5. The packaged shotcrete mixture shall be from the Department's approved list of Packaged High Performance Shotcrete, and independent laboratory test results showing the product meets Department specifications will be required. The product shall be a packaged, pre-blended, and dry combination of materials, for the wet-mix shotcrete method according to ASTM C 1480. An accelerator is prohibited, except the shotcrete may be modified at the nozzle with a non-chloride accelerator for overhead applications. The shotcrete shall be Type FA or CA, Grade FR, and Class I. The fibers shall be Type III synthetic according to ASTM C 1116.

The packaged shotcrete shall have a water soluble chloride ion content of less than 0.40 lb/cu yd (0.24 kg/cu m). The test shall be performed according to ASTM C 1218, and the hardened shotcrete shall have an age of 28 to 42 days at the time of test. The ASTM C 1218 test shall be performed by an independent lab a minimum of once every two years, and the test results shall be provided to the Department.

Each individual aggregate used in the packaged shotcrete shall have either a maximum ASTM C 1260 expansion of 0.16 percent or a maximum ASTM C 1293 expansion of 0.040 percent. However, the ASTM C 1260 value may be increased to 0.27 percent for each individual aggregate if the cement total equivalent alkali content ($\text{Na}_2\text{O} + 0.658\text{K}_2\text{O}$) does not exceed 0.60 percent. As an alternative to these requirements, ASTM C 1567 testing which shows the packaged shotcrete has a maximum expansion of 0.16 percent may be submitted. The ASTM C 1260, C 1293, or C 1567 test shall be performed a minimum of once every two years.

The 7 and 28 day compressive strength requirements in ASTM C 1480 shall not apply. Instead the shotcrete shall obtain a minimum compressive strength of 4000 psi (27,500 kPa) at 14 days.

The packaged shotcrete shall be limited to the following proportions:

The portland cement and finely divided minerals shall be 6.05 cwt/cu yd (360 kg/cu m) to 8.50 cwt/cu yd (505 kg/cu m) for Type FA and 6.05 cwt/cu yd (360 kg/cu. m)

to 7.50 cwt/cu yd (445 kg/cu m) for Type CA. The portland cement shall not be below 4.70 cwt/cu yd (279 kg/cu m) for Type FA or CA.

The finely divided mineral(s) shall constitute a maximum of 35 percent of the total cement plus finely divided mineral(s).

Class F fly ash is optional and the maximum shall be 20 percent by weight (mass) of cement.

Class C fly ash is optional and the maximum shall be 25 percent by weight (mass) of cement.

Ground granulated blast-furnace slag is optional and the maximum shall be 30 percent by weight (mass) of cement.

Microsilica is required and shall be a minimum of 5 percent by weight (mass) of cement, and a maximum of 10 percent. As an alternative to microsilica, high-reactivity metakaolin may be used at a minimum of 5 percent by weight (mass) of cement, and a maximum of 10 percent.

Fly ash shall not be used in combination with ground granulated blast-furnace slag. Class F fly ash shall not be used in combination with Class C fly ash. Microsilica shall not be used in combination with high-reactivity metakaolin. A finely divided mineral shall not be used in combination with a blended hydraulic cement, except for microsilica or high-reactivity metakaolin.

The water/cement ratio as defined in Article 1020.06 shall be a maximum of 0.42.

The air content as shot shall be 4.0 – 8.0 percent.

Note 6. In addition ASTM C 881, Type IV, Grade 2 or 3, Class A, B, or C may be used.

Equipment. Equipment shall be according to Article 503.03 and the following.

Chipping Hammer – The chipping hammer for removing concrete shall be a light-duty pneumatic or electric tool with a 15 lb. (7 kg) maximum class or less.

Blast Cleaning Equipment – Blast cleaning equipment for concrete surface preparation shall be the abrasive type, and the equipment shall have oil traps.

Hydrodemolition Equipment – Hydrodemolition equipment for removing concrete shall be calibrated, and shall use water according to Section 1002.

High Performance Shotcrete Equipment – The batching, mixing, pumping, hose, nozzle, and auxiliary equipment shall be for the wet-mix shotcrete method, and shall meet the requirements of ACI 506R.

Construction Requirements

General. The repair methods shall be either formed concrete repair or shotcrete. The repair method shall be selected by the Contractor with the following rules.

- (a) Rule 1. For formed concrete repair, a subsequent patch to repair the placement point after initial concrete placement will not be allowed. As an example, this may occur in a vertical location located at the top of the repair.
- (b) Rule 2. Formed concrete repair shall not be used for overhead applications.
- (c) Rule 3. Shotcrete shall not be used for column repairs greater than 4 in. (100 mm) in depth, or any repair location greater than 8 in. (205 mm) in depth. The only exception to this rule would be for a horizontal application, where the shotcrete may be placed from above in one lift.
- (d) Rule 4. If formed concrete repair is used for locations that have reinforcement with less than 0.75 in. (19 mm) of concrete cover, the concrete mixture shall contain fly ash or ground granulated blast-furnace slag at the maximum cement replacement allowed.

Temporary Shoring or Cribbing. When a temporary shoring or cribbing support system is required, the Contractor shall provide details and computations, prepared and sealed by an Illinois licensed Structural Engineer, to the Department for review and approval. When ever possible the support system shall be installed prior to starting the associated concrete removal. If no system is specified, but during the course of removal the need for temporary shoring or cribbing becomes apparent or is directed by the Engineer due to a structural concern, the Contractor shall not proceed with any further removal work until an appropriate and approved support system is installed.

Concrete Removal. The Contractor shall provide ladders or other appropriate equipment for the Engineer to mark the removal areas. Repair configurations will be kept simple, and squared corners will be preferred. The repair perimeter shall be sawed a depth of 1/2 in. (13 mm) or less, as required to avoid cutting the reinforcement. Any cut reinforcement shall be repaired or replaced at the expense of the Contractor. If the concrete is broken or removed beyond the limits of the initial saw cut, the new repair perimeter shall be recut. The areas to be repaired shall have all loose, unsound concrete removed completely by the use of chipping hammers, hydrodemolition equipment, or other methods approved by the Engineer. The concrete removal shall extend along the reinforcement bar until the reinforcement is free of bond inhibiting corrosion. The outermost layer of reinforcement bar within the repair area shall be undercut to a depth of 3/4 in. (19 mm) or the diameter of the reinforcement bar, whichever value is larger. The underlying transverse reinforcement bar shall also be undercut as previously described,

unless the reinforcement is not corroded, and the reinforcement bar is encased and well bonded to the surrounding concrete.

If sound concrete is encountered before existing reinforcement bars are exposed, further removal of concrete shall not be performed unless the minimum repair depth is not met.

The repair depth shall be a minimum of 1 in. (25 mm). The substrate profile shall be $\pm 1/16$ in. (± 1.5 mm). The perimeter of the repair area shall have a vertical face.

If a repair is located at the ground line, any excavation required below the ground line to complete the repair shall be included in this work.

The Contractor shall have a maximum of 14 calendar days to complete each repair location with concrete or shotcrete, once concrete removal has started for the repair.

The Engineer shall be notified of concrete removal that exceeds 6 in. (150 mm) in depth, one fourth the cross section of a structural member, more than half the vertical column reinforcement is exposed in a cross section, more than 6 consecutive reinforcement bars are exposed in any direction, within 1.5 in. (38 mm) of a bearing area, or other structural concern. Excessive deterioration or removal may require further evaluation of the structure or installation of temporary shoring and cribbing support system.

Surface Preparation. Prior to placing the concrete or shotcrete, the Contractor shall prepare the repair area and exposed reinforcement by blast cleaning. The blast cleaning shall provide a surface that is free of oil, dirt, and loose material.

If a succeeding layer of shotcrete is to be applied, the initial shotcrete surface and remaining exposed reinforcement shall be free of curing compound, oil, dirt, loose material, rebound (i.e. shotcrete material leaner than the original mixture which ricochets off the receiving surface), and overspray. Preparation may be by lightly brushing or blast cleaning if the previous shotcrete surface is less than 36 hours old. If more than 36 hours old, the surface shall be prepared by blast cleaning.

The repair area and perimeter vertical face shall have a rough surface. Care shall be taken to ensure the perimeter sawcut is roughened. Just prior to concrete or shotcrete placement, saturate the repair area with water to a saturated surface-dry condition. Any standing water shall be removed.

Concrete or shotcrete placement shall be done within 3 calendar days of the surface preparation or the repair area shall be prepared again.

Reinforcement. Exposed reinforcement bars shall be cleaned of concrete and corrosion by blast cleaning. After cleaning, all exposed reinforcement shall be carefully evaluated to determine if replacement or additional reinforcement bars are required.

Reinforcing bars that have been cut or have lost 25 percent or more of their original cross sectional area shall be supplemented by new in kind reinforcement bars. New bars shall be lapped a minimum of 32 bar diameters to existing bars. A mechanical bar splicer shall be used when it is not feasible to provide the minimum bar lap. No welding of bars shall be performed.

Intersecting reinforcement bars shall be tightly secured to each other using 0.006 in. (1.6 mm) or heavier gauge tie wire, and shall be adequately supported to minimize movement during concrete placement or application of shotcrete.

For reinforcement bar locations with less than 0.75 in. (19 mm) of cover, protective coat shall be applied to the completed repair. The application of the protective coat shall be according to Article 503.19, 2nd paragraph, except blast cleaning shall be performed to remove curing compound.

The Contractor shall anchor the new concrete to the existing concrete with 3/4 in. (19 mm) diameter hook bolts for all repair areas where the depth of concrete removal is greater than 8 in. (205 mm) and there is no existing reinforcement extending into the repair area. The hook bolts shall be spaced at 15 in. (380 mm) maximum centers both vertically and horizontally, and shall be a minimum of 12 in. (305 mm) away from the perimeter of the repair. The hook bolts shall be installed according to Section 584.

Repair Methods. All repair areas shall be inspected and approved by the Engineer prior to placement of the concrete or application of the shotcrete.

- (a) Formed Concrete Repair. Falsework shall be according to Article 503.05. Forms shall be according to Article 503.06. Formwork shall provide a smooth and uniform concrete finish, and shall approximately match the existing concrete structure. Formwork shall be mortar tight and closely fitted where they adjoin the existing concrete surface to prevent leakage. Air vents may be provided to reduce voids and improve surface appearance. The Contractor may use exterior mechanical vibration, as approved by the Engineer, to release air pockets that may be entrapped.

The concrete for formed concrete repair shall be a Class SI Concrete, or a packaged R1 or R2 Concrete with coarse aggregate added, or a packaged Normal Weight Concrete at

the Contractor's option. The concrete shall be placed and consolidated according to Article 503.07. The concrete shall not be placed when frost is present on the surface of the repair area, or the surface temperature of the repair area is less than 40 °F (4 °C). All repaired members shall be restored as close as practicable to their original dimensions.

Curing shall be done according to Article 1020.13.

If temperatures below 45°F (7°C) are forecast during the curing period, protection methods shall be used. Protection Method I according to Article 1020.13(d)(1), or Protection Method II according to Article 1020.13(d)(2) shall be used during the curing period.

The surfaces of the completed repair shall be finished according to Article 503.15.

- (b) Shotcrete. Shotcrete shall be tested by the Engineer for air content according to Illinois Modified AASHTO T 152. Obtain the sample in a damp, non-absorbent container from the discharge end of the nozzle.

For compressive strength of shotcrete, a 18 x 18 x 3.5 in. (457 x 457 x 89 mm) test panel shall be shot by the Contractor for testing by the Engineer. A steel form test panel shall have a minimum thickness of 3/16 in. (5 mm) for the bottom and sides. A wood form test panel shall have a minimum 3/4 in. (19 mm) thick bottom, and a minimum 1.5 in. (38 mm) thickness for the sides. The test panel shall be cured according to Article 1020.13 (a) (3) or (5) while stored at the jobsite and during delivery to the laboratory. After delivery to the laboratory for testing, curing and testing shall be according to ASTM C 1140.

The method of alignment control (i.e. ground wires, guide strips, depth gages, depth probes, and formwork) to ensure the specified shotcrete thickness and reinforcing bar cover is obtained shall be according to ACI 506R. Ground wires shall be removed after completion of cutting operations. Guide strips and formwork shall be of dimensions and a configuration that do not prevent proper application of shotcrete. Metal depth gauges shall be cut 1/4 in. (6 mm) below the finished surface. All repaired members shall be restored as close as practicable to their original dimensions.

For air temperature limits when applying shotcrete in cold weather, the first paragraph of Article 1020.14(b) shall apply. For hot weather, shotcrete shall not be applied when the air temperature is greater than 90°F (32°C). The applied shotcrete shall have a minimum temperature of 50°F (10°C) and a maximum temperature of 90°F (32°C). The shotcrete shall not be applied during periods of rain unless protective covers or enclosures are installed. The shotcrete shall not be applied when frost is present on the surface of the repair area, or the surface temperature of the repair area is less than 40°F (4°C). If necessary, lighting shall be provided to provide a clear view of the shooting area.

The shotcrete shall be applied according to ACI 506R, and shall be done in a manner that does not result in cold joints, laminations, sandy areas, voids, sags, or separations. In addition, the shotcrete shall be applied in a manner that results in maximum densification of the shotcrete. Shotcrete which is identified as being unacceptable while still plastic shall be removed and re-applied.

The nozzle shall normally be at a distance of 2 to 5 ft. (0.6 to 1.5 m) from the receiving surface, and shall be oriented at right angles to the receiving surface. Exceptions to this requirement will be permitted to fill corners, encase large diameter reinforcing bars, or as approved by the Engineer. For any exception, the nozzle shall never be oriented more than 45 degrees from the surface. Care shall be taken to keep the front face of the reinforcement bar clean during shooting operations. Shotcrete shall be built up from behind the reinforcement bar. Accumulations of rebound and overspray shall be continuously removed prior to application of new shotcrete. Rebound material shall not be incorporated in the work.

Whenever possible, shotcrete shall be applied to the full thickness in a single layer. The maximum thickness shall be 4 in. (100 mm) unless the shotcrete is applied from above on a horizontal surface, or a thicker application is approved by the Engineer. When two or more layers are required, the minimum number shall be used and shall be done in a manner without sagging or separation. A flash coat (i.e. a thin layer of up to 1/4 in. (6 mm) applied shotcrete) may be used as the final lift for overhead applications.

Prior to application of a succeeding layer of shotcrete, the initial layer of shotcrete shall be prepared according to the surface preparation and reinforcement bar cleaning requirements. Upon completion of the surface preparation and reinforcement bar treatment, water shall be applied according to the surface preparation requirements unless the surface is moist. The second layer of shotcrete shall then be applied within 30 minutes.

Shotcrete shall be cut back to line and grade using trowels, cutting rods, screeds or other suitable devices. The shotcrete shall be allowed to stiffen sufficiently before cutting. Cutting shall not cause cracks or delaminations in the shotcrete. For depressions, cut material may be used for small areas. Rebound material shall not be incorporated in the work. For the final finish, a wood float shall be used to approximately match the existing concrete texture. All repaired members shall be restored as close as practicable to their original dimensions.

Contractor operations for curing shall be continuous with shotcrete placement and finishing operations. The Engineer may require modification of operations to ensure satisfactory results are obtained. Cotton mats shall be applied according to Article 1020.13(a)(5) except the exposed layer of shotcrete shall be covered within 10 minutes after finishing, and wet curing shall begin immediately. As an alternative to this method, Type I curing compound shall be applied according to Article 1020.13(a)(4) and moist curing with cotton mats shall begin within 3 hours. For overhead applications where the final shotcrete layer has been applied, the Contractor has the option to use Type I curing

compound in lieu of the cotton mats. Note 5 of the Index Table in Article 1020.13 shall apply to the membrane curing method. The curing compound shall be applied according to Article 1020.13(a)(4).

When a shotcrete layer is to be covered by a succeeding shotcrete layer within 36 hours, the repair area shall be protected with intermittent hand fogging, or wet curing with either burlap or cotton mats shall begin within 10 minutes. Intermittent hand fogging may be used only for the first hour. Thereafter, wet curing with burlap or cotton mats shall be used until the succeeding shotcrete layer is applied. Intermittent hand fogging may be extended to the first hour and a half if the succeeding shotcrete layer is applied by the end of this time.

The curing period shall be for 7 days, except when there is a succeeding layer of shotcrete. In this instance, the initial shotcrete layer shall be cured until the surface preparation and reinforcement bar treatment is started.

If temperatures below 45°F (7°C) are forecast during the curing period, protection methods shall be used. Protection Method I according to Article 1020.13(d)(1), or Protection Method II according to Article 1020.13(d)(2) shall be used during the curing period.

Inspection of Completed Work. The Contractor shall provide ladders or other appropriate equipment for the Engineer to inspect the repaired areas. After curing but no sooner than 28 days after placement of concrete or shooting of shotcrete, the repair shall be examined for conformance with original dimensions, cracks, voids, and delaminations. Sounding for delaminations will be done with a hammer or by other methods determined by the Engineer.

The repaired area shall be removed and replaced, as determined by the Engineer, for nonconformance with original dimensions, surface cracks greater than 0.01 in. (0.25 mm) in width, map cracking with a crack spacing in any direction of 18 in. (0.45 m) or less, voids, or delaminations.

If a nonconforming repair is allowed to remain in place, cracks 0.01 in. (0.25 mm) or less shall be repaired with epoxy according to Section 590. For cracks less than 0.007 in. (2 mm), the epoxy may be applied to the surface of the crack. Voids shall be repaired according to Article 503.15.

Publications and Personnel Requirements. The Contractor shall provide a current copy of ACI 506R to the Engineer a minimum of one week prior to start of construction.

The shotcrete personnel who perform the work shall have current American Concrete Institute (ACI) nozzle men certification for vertical wet and overhead wet applications, except one individual may be in training. This individual shall be adequately supervised by a certified ACI nozzle men as determined by the Engineer. A copy of the nozzle men certificate(s) shall be given to the Engineer.

Method of Measurement. This work will be measured for payment in place and the area computed in square feet (square meters). For a repair at a corner, both sides will be measured.

Basis of Payment. This work will be paid for at the contract unit price per square foot (square meter) for STRUCTURAL REPAIR OF CONCRETE (DEPTH GREATER THAN 5 IN. (125 MM), STRUCTURAL REPAIR OF CONCRETE (DEPTH EQUAL TO OR LESS THAN 5 IN. (125 MM).

When not specified to be paid for elsewhere, the work to design, install, and remove the temporary shoring and cribbing will be paid for according to Article 109.04.

With the exception of reinforcement damaged by the Contractor during removal, the furnishing and installation of supplemental reinforcement bars, mechanical bar splicers, hook bolts, and protective coat will be paid according to Article 109.04.

COFFERDAMS

Effective: October 15, 2011

Replace Article 502.06 with the following.

502.06 Cofferdams. A Cofferdam shall be defined as a temporary structure, consisting of engineered components, designed to isolate the work area from water to enable construction under dry conditions based on either the Estimated Water Surface Elevation (EWSE) or Cofferdam Design Water Elevation (CDWE) shown on the contract plans as specified below. When cofferdams are not specified in the contract documents and conditions are encountered where the excavation for the structure cannot be kept free of water for prosecuting the work by pumping and/or diverting water, the Contractor, with the written permission of the Engineer, will be permitted to construct a cofferdam.

The Contractor shall submit a cofferdam plan for each cofferdam to the Engineer for approval prior to the start of construction. Cofferdams shall not be installed or removed without the Engineer's approval. Work shall not be performed in flowing water except for the installation and removal of the cofferdam. The cofferdam plan shall address the following:

- (a) Cofferdam (Type 1). The Contractor shall submit a cofferdam plan which addresses the proposed methods of construction and removal; the construction sequence including staging; dewatering methods; erosion and sediment control measures; disposal of excavated material; effluent water control measures; backfilling; and the best management practices to prevent reintroduction of excavated material into the aquatic environment. The design and method of construction shall provide, within the measurement limits specified in Article 502.12, necessary clearance for forms, inspection of exterior of the forms, pumping, and protection of fresh concrete from water. For Type 1 cofferdams, it is anticipated the design will be based on the EWSE shown on the contract plans. The Contractor shall assume all liability, financial or otherwise for a Type 1 cofferdam designed for an elevation lower than the EWSE.
- (b) Cofferdam (Type 2). In addition to the requirements of Article 502.06(a), the Contractor's submittal shall include detailed drawings and design calculations, prepared and sealed by an Illinois Licensed Structural Engineer. For Type 2 cofferdams it is anticipated the design will be based on the CDWE shown on the contract plans. The Contractor shall assume all liability, financial or otherwise for a Type 2 cofferdam designed for an elevation lower than the CDWE.
- (c) Seal Coat. The seal coat concrete, when shown on the plans, is based on design assumptions in order to establish an estimated quantity. When seal coat is indeed utilized, it shall be considered an integral part of the overall cofferdam system and, therefore, its design shall be included in the overall cofferdam design submittal. If a seal coat was not specified but determined to be necessary, it shall be added to the contract by written permission of the Engineer. The seal coat concrete shall be constructed according to Article

503.14. After the excavation within the cofferdam has been completed and the piles have been driven (if applicable), and prior to placing the seal coat, the elevation of the bottom of the proposed seal coat shall be verified by soundings. The equipment and methods used to conduct the soundings shall meet the approval of the Engineer. Any material within the cofferdam above the approved bottom of the seal coat elevation shall be removed.

No component of the cofferdam shall extend into the substructure concrete or remain in place without written permission of the Engineer. Removal shall be according to the previously approved procedure. Unless otherwise approved in writing by the Engineer, all components of the cofferdam shall be removed.

Revise the first paragraph of 502.12(b) to read as follows.

(b) Measured Quantities. Structure excavation, when specified, will be measured for payment in its original position and the volume computed in cubic yards (cubic meters). Horizontal dimensions will not extend beyond vertical planes 2 ft (600 mm) outside of the edges of footings of bridges, walls, and corrugated steel plate arches. The vertical dimension for structure excavation will be the average depth from the surface of the material to be excavated to the bottom of the footing as shown on the plans or ordered in writing by the Engineer. The volume of any unstable and/or unsuitable material removed within the structure excavation will be measured for payment in cubic yards (cubic meters).

Revise the last paragraph of 502.12(b) to read as follows.

Cofferdam excavation will be measured for payment in cubic yards (cubic meters) in its original position within the cofferdam. Unless otherwise shown on the plans, the horizontal dimensions used in computing the volume will not extend beyond vertical planes 2 ft (600 mm) outside of the edges of the substructure footings or 4 ft (1.2 m) outside of the faces of the substructure stem wall, whichever is greater. The vertical dimensions will be the average depth from the surface of the material to be excavated to the elevation shown on the plans for bottom of the footing, stem wall, or seal coat, or as otherwise determined by the Engineer as the bottom of the excavation.

Revise the first sentence of the sixth paragraph of 502.13 to read as follows.

Cofferdams, when specified, will be paid for at the contract unit price per each for COFFERDAM (TYPE 1) or COFFERDAM (TYPE 2), at the locations specified.

GRANULAR BACKFILL FOR STRUCTURES

Effective: April 19, 2012

Revised: October 30, 2012

Revise Section 586 of the Standard Specifications to read:

SECTION 586. GRANULAR BACKFILL FOR STRUCTURES

586.01 Description. This work shall consist of furnishing, transporting and placing granular backfill for abutment structures.

586.02 Materials. Materials shall be according to the following.

Item	Article/Section
(a) Fine Aggregate.....	1003.04
(b) Coarse Aggregates	1004.05

CONSTRUCTION REQUIREMENTS

586.03 General. This work shall be done according to Article 502.10 except as modified below. The backfill volume shall be backfilled, with granular material as specified in Article 586.02, to the required elevation as shown in the contract plans. The backfill volume shall be placed in convenient lifts for the full width to be backfilled. Unless otherwise specified in the contract plans, mechanical compaction will not be required. A deposit of gravel or crushed stone placed behind drain holes shall not be required. All drains not covered by geocomposite wall drains or other devices to prevent loss of backfill material shall be covered by sufficient filter fabric material meeting the requirements of Section 1080 and Section 282 with either 6 or 8 oz/sq yd (200 or 270 g/sq m) material allowed, with free edges overlapping the drain hole by at least 12 in. (300 mm) in all directions.

The granular backfill shall be brought to the finished grade as shown in the contract plans. When concrete is to be cast on top of the granular backfill, the Contractor, subject to approval of the Engineer, may prepare the top surface of the fill to receive the concrete as he/she deems necessary for satisfactory placement at no additional cost to the Department.

586.04 Method of Measurement. This work will be measured for payment as follows.

(a) Contract Quantities. The requirements for the use of contract quantities shall conform to Article 202.07(a).

(b) Measured Quantities. This work will be measured for payment in place and the volume computed in cubic yards (cubic meters). The volume will be determined by the method of average end areas behind the abutment.

586.05 Basis of Payment. This work will be paid for at the contract unit price per cubic yard (cubic meter) for GRANULAR BACKFILL FOR STRUCTURES.

**WEEP HOLE DRAINS FOR ABUTMENTS, WINGWALLS, RETAINING WALLS AND
CULVERTS**

Effective: April 19, 2012

Delete the last paragraphs of 205.05 and 502.10 and replace with the following.

If a geocomposite wall drain according to Section 591 is not specified, a prefabricated geocomposite strip drain according to Section 1040.07 shall be placed at the back of each drain hole. The strip drain shall be 24 inches (600 mm) wide and 48 inches (1.220 m) tall. The strip drain shall be centered over the drain hole with the bottom located 12 inches (300 mm) below the bottom of the drain hole. All form boards or other obstructions shall be removed from the drain holes before placing any geocomposite strip drain.

Revise the title of 1040.07 to Geocomposite Wall Drains and Strip Drains.

State of Illinois
Department of Transportation
Bureau of Local Roads and Streets

SPECIAL PROVISION
FOR
COOPERATION WITH UTILITIES

Effective: January 1, 1999
Revised: January 1, 2007

All references to Sections or Articles in this specification shall be construed to mean specific Section or Article of the Standard Specifications for Road and Bridge Construction, adopted by the Department of Transportation.

Replace Article 105.07 of the Standard Specifications with the following:

"105.07 Cooperation with Utilities. The adjustment of utilities consists of the relocation, removal, replacement, rearrangements, reconstruction, improvement, disconnection, connection, shifting, new installation or altering of an existing utility facility in any manner.

When the plans or special provisions include information pertaining to the location of underground utility facilities, such information represents only the opinion of the Department as to the location of such utilities and is only included for the convenience of the bidder. The Department assumes no responsibility in respect to the sufficiency or the accuracy of the information shown on the plans relative to the location of the underground utility facilities.

Utilities which are to be adjusted shall be adjusted by the utility owner or the owner's representative or by the Contractor as a contract item. Generally, arrangements for adjusting existing utilities will be made by the Department prior to project construction; however, utilities will not necessarily be adjusted in advance of project construction and, in some cases, utilities will not be removed from the proposed construction limits. When utility adjustments must be performed in conjunction with construction, the utility adjustment work will be shown on the plans and/or covered by Special Provisions.

When the Contractor discovers a utility has not been adjusted by the owner or the owner's representative as indicated in the contract documents, or the utility is not shown on the plans or described in the Special Provisions as to be adjusted in conjunction with construction, the Contractor shall not interfere with said utility, and shall take proper precautions to prevent damage or interruption of the utility and shall promptly notify the Engineer of the nature and location of said utility.

All necessary adjustments, as determined by the Engineer, of utilities not shown on the plans or not identified by markers, will be made at no cost to the Contractor except traffic structures, light poles, etc., that are normally located within the proposed construction limits as hereinafter defined will not be adjusted unless required by the proposed improvement.

(a) Limits of Proposed Construction for Utilities Paralleling the Roadway. For the purpose of this Article, limits of proposed construction for utilities extending in the same longitudinal direction as the roadway, shall be defined as follows:

- (1) The horizontal limits shall be a vertical plane, outside of, parallel to, and 600 mm (2 ft) distant at right angles from the plan or revised slope limits.

In cases where the limits of excavation for structures are not shown on the plans, the horizontal limits shall be a vertical plane 1.2 m (4 ft) outside the edges of structure footings or the structure where no footings are required.

- (2) The upper vertical limits shall be the regulations governing the roadbed clearance for the specific utility involved.
- (3) The lower vertical limits shall be the top of the utility at the depth below the proposed grade as prescribed by the governing agency or the limits of excavation, whichever is less.

(b) Limits of Proposed Construction for Utilities Crossing the Roadway. For the purpose of this Article, limits of proposed construction for utilities crossing the roadway in a generally transverse direction shall be defined as follows:

- (1) Utilities crossing excavations for structures that are normally made by trenching such as sewers, underdrains, etc. and all minor structures such as manholes, inlets, foundations for signs, foundations for traffic signals, etc., the limits shall be the space to be occupied by the proposed permanent construction unless otherwise required by the regulations governing the specific utility involved.
- (2) For utilities crossing the proposed site of major structures such as bridges, sign trusses, etc., the limits shall be as defined above for utilities extending in the same general direction as the roadway.

The Contractor may make arrangements for adjustment of utilities outside of the limits of proposed construction provided the Contractor furnishes the Department with a signed agreement with the utility owner covering the adjustments to be made. The cost of any adjustments made outside the limits of proposed construction shall be the responsibility of the Contractor unless otherwise provided.

The Contractor shall request all utility owners to field locate their facilities according to Article 107.31. The Engineer may make the request for location from the utility after receipt of notice from the Contractor. On request, the Engineer will make an inspection to verify that the utility company has field located its facilities, but will not assume responsibility for the accuracy of such work. The Contractor shall be responsible for maintaining the excavations or markers provided by the utility owners. This field location procedure may be waived if the utility owner has stated in writing to the Department it is satisfied the construction plans are sufficiently accurate. If the utility owner does not submit such statement to the Department, and they do not field locate their facilities in both horizontal and vertical alignment, the Engineer will authorize the Contractor in writing to proceed to locate the facilities in the most economical and reasonable manner, subject to the approval of the Engineer, and be paid according to Article 109.04.

The Contractor shall coordinate with any planned utility adjustment or new installation and the Contractor shall take all precautions to prevent disturbance or damage to utility facilities. Any failure on the part of the utility owner, or their representative, to proceed with any planned utility adjustment or new installation shall be reported promptly by the Contractor to the Engineer orally and in writing.

The Contractor shall take all necessary precautions for the protection of the utility facilities. The Contractor shall be responsible for any damage or destruction of utility facilities resulting from neglect, misconduct, or omission in the Contractor's manner or method of execution or nonexecution of the work, or caused by defective work or the use of unsatisfactory materials. Whenever any damage or destruction of a utility facility occurs as a result of work performed by the Contractor, the utility company will be immediately notified. The utility company will make arrangements to restore such facility to a condition equal to that existing before any such damage or destruction was done.

It is understood and agreed that the Contractor has considered in the bid all of the permanent and temporary utilities in their present and/or adjusted positions.

No additional compensation will be allowed for any delays, inconvenience, or damage sustained by the Contractor due to any interference from the said utility facilities or the operation of relocating the said utility facilities.

State of Illinois
Department of Transportation
Bureau of Local Roads and Streets

SPECIAL PROVISION
FOR
INSURANCE

Effective: February 1, 2007
Revised: August 1, 2007

All references to Sections or Articles in this specification shall be construed to mean specific Section or Article of the Standard Specifications for Road and Bridge Construction, adopted by the Department of Transportation.

The Contractor shall name the following entities as additional insured under the Contractor's general liability insurance policy in accordance with Article 107.27:

City of Aurora

The entities listed above and their officers, employees, and agents shall be indemnified and held harmless in accordance with Article 107.26.

ANCHOR BOLTS (BDE)

Effective: January 1, 2013

Revise the fourth sentence of the first paragraph of Article 1006.09 of the Standard Specifications to read:

“Stud bolts or fully threaded rods shall be according to either ASTM A 354 Grade BC, ASTM A 193 Grade B7, or ASTM F 1554 Grade 105.”

Revise the second paragraph of Article 1006.09 of the Standard Specifications to read:

“Washers and nuts shall match with the hardness of the anchor bolt, stud, or rod. For ASTM F 1554 Grade 36 (Grade 250) or Grade 55 (Grade 380) anchor rods or bolts, washers shall be according to ASTM F 844 or ASTM F 436, and nuts shall be according to AASHTO M 291 Grade A. For ASTM F 1554 Grade 105 (Grade 725) bolts, ASTM A 354, or ASTM A 193 stud bolts, washers shall be according to AASHTO M 293 Type 1 or Type 3, and nuts shall be according to AASHTO M 291 Grade DH or DH3.”

Revise the seventh paragraph of Article 1006.09 of the Standard Specifications to read:

“Anchor bolts, rods, studs, nuts, and washers requiring galvanizing shall be hot dipped, with zinc coatings conforming to the requirements of ASTM F 2329.”

Revise the fourth paragraph of Article 1070.01 of the Standard Specifications to read:

“Fully threaded and galvanized anchor rods or stud bolts with washers and nuts shall be furnished with the foundations and shall be according to Article 1006.09. Anchors furnished according to ASTM F 1554 shall be Grade 105 (Grade 725).”

Revise the second paragraph of Article 1070.03 of the Standard Specifications to read:

“Top anchor rod nuts for all towers shall be the self-locking type with nylon or steel inserts.”

80309

COATED GALVANIZED STEEL CONDUIT (BDE)

Effective: January 1, 2013

Revise Article 1088.01(a)(3) of the Standard Specifications to read:

“(3) Coated Galvanized Steel Conduit. The conduit prior to coating shall meet the requirements for rigid metal conduit and be manufactured according to NEMA Standard No. RN1.

The coating shall have the following characteristics.

Hardness	85+ Shore A Durometer
Dielectric Strength	400 V/mil @ 60 Hz
Aging	1,000 Hours Atlas Weatherometer
Brittleness Temperature	0 °F (-18 °C) when tested according to ASTM D 746
Elongation	200 percent

The exterior galvanized surfaces shall be coated with a primer before the coating to ensure a bond between the zinc substrate and the coating. The bond strength created shall be greater than the tensile strength of the plastic coating. The nominal thickness of the coating shall be 40 mils (1 mm). The coating shall pass the following bonding test.

Two parallel cuts 1/2 in. (13 mm) apart and 1 1/2 in. (38 mm) in length shall be made with a sharp knife along the longitudinal axis. A third cut shall be made perpendicular to and crossing the longitudinal cuts at one end. The knife shall then be worked under the coating for 1/2 in. (13 mm) to free the coating from the metal.

Using pliers, the freed tab shall be pulled with a force applied vertically and away from the conduit. The tab shall tear rather than cause any additional coating to separate from the substrate.

A two part urethane coating shall be applied to the interior of the conduit. The internal coating shall have a nominal thickness of 2 mils (50 µm). The interior coating shall be applied in a manner so there are no runs, drips, or pinholes at any point. The coating shall not peel, flake, or chip off after a cut is made in the conduit or a scratch is made in the coating. The urethane interior coating applied shall afford sufficient flexibility to permit field bending without cracking or flaking of the interior coating.

All conduit fittings and couplings shall be as specified and recommended by the conduit manufacturer. All conduit fitting covers shall be furnished with stainless steel screws which have been encapsulated with a polyester material on the head to ensure maximum corrosion protection.”

CONSTRUCTION AIR QUALITY – DIESEL RETROFIT (BDE)

Effective: June 1, 2010

The reduction of emissions of particulate matter (PM) for off-road equipment shall be accomplished by installing retrofit emission control devices. The term "equipment" refers to diesel fuel powered devices rated at 50 hp and above, to be used on the jobsite in excess of seven calendar days over the course of the construction period on the jobsite (including rental equipment).

Contractor and subcontractor diesel powered off-road equipment assigned to the contract shall be retrofitted using the phased in approach shown below. Equipment that is of a model year older than the year given for that equipment's respective horsepower range shall be retrofitted:

Effective Dates	Horsepower Range	Model Year
June 1, 2010 ^{1/}	600-749	2002
	750 and up	2006
June 1, 2011 ^{2/}	100-299	2003
	300-599	2001
	600-749	2002
	750 and up	2006
June 1, 2012 ^{2/}	50-99	2004
	100-299	2003
	300-599	2001
	600-749	2002
	750 and up	2006

1/ Effective dates apply to Contractor diesel powered off-road equipment assigned to the contract.

2/ Effective dates apply to Contractor and subcontractor diesel powered off-road equipment assigned to the contract.

The retrofit emission control devices shall achieve a minimum PM emission reduction of 50 percent and shall be:

- a) Included on the U.S. Environmental Protection Agency (USEPA) *Verified Retrofit Technology List* (<http://www.epa.gov/otaq/retrofit/verif-list.htm>), or verified by the California Air Resources Board (CARB) (<http://www.arb.ca.gov/diesel/verde/verdev.htm>); or
- b) Retrofitted with a non-verified diesel retrofit emission control device if verified retrofit emission control devices are not available for equipment proposed to be used on the project, and if the Contractor has obtained a performance certification from the retrofit

device manufacturer that the emission control device provides a minimum PM emission reduction of 50 percent.

Note: Large cranes (Crawler mounted cranes) which are responsible for critical lift operations are exempt from installing retrofit emission control devices if such devices adversely affect equipment operation.

Diesel powered off-road equipment with engine ratings of 50 hp and above, which are unable to be retrofitted with verified emission control devices or if performance certifications are not available which will achieve a minimum 50 percent PM reduction, may be granted a waiver by the Department if documentation is provided showing good faith efforts were made by the Contractor to retrofit the equipment.

Construction shall not proceed until the Contractor submits a certified list of the diesel powered off-road equipment that will be used, and as necessary, retrofitted with emission control devices. The list(s) shall include (1) the equipment number, type, make, Contractor/rental company name; and (2) the emission control devices make, model, USEPA or CARB verification number, or performance certification from the retrofit device manufacturer. Equipment reported as fitted with emissions control devices shall be made available to the Engineer for visual inspection of the device installation, prior to being used on the jobsite.

The Contractor shall submit an updated list of retrofitted off-road construction equipment as retrofitted equipment changes or comes on to the jobsite. The addition or deletion of any diesel powered equipment shall be included on the updated list.

If any diesel powered off-road equipment is found to be in non-compliance with any portion of this special provision, the Engineer will issue the Contractor a diesel retrofit deficiency deduction.

Any costs associated with retrofitting any diesel powered off-road equipment with emission control devices shall be considered as included in the contract unit prices bid for the various items of work involved and no additional compensation will be allowed. The Contractor's compliance with this notice and any associated regulations shall not be grounds for a claim.

Diesel Retrofit Deficiency Deduction

When the Engineer determines that a diesel retrofit deficiency exists, a daily monetary deduction will be imposed for each calendar day or fraction thereof the deficiency continues to exist. The calendar day(s) will begin when the time period for correction is exceeded and end with the Engineer's written acceptance of the correction. The daily monetary deduction will be \$1,000.00 for each deficiency identified.

The deficiency will be based on lack of diesel retrofit emissions control.

If a Contractor accumulates three diesel retrofit deficiency deductions for the same piece of equipment in a contract period, the Contractor will be shutdown until the deficiency is corrected.

Such a shutdown will not be grounds for any extension of the contract time, waiver of penalties, or be grounds for any claim.

80261

DISADVANTAGED BUSINESS ENTERPRISE PARTICIPATION (DBE)

Effective: September 1, 2000

Revised: August 2, 2011

FEDERAL OBLIGATION. The Department of Transportation, as a recipient of federal financial assistance, is required to take all necessary and reasonable steps to ensure nondiscrimination in the award and administration of contracts. Consequently, the federal regulatory provisions of 49 CFR Part 26 apply to this contract concerning the utilization of disadvantaged business enterprises. For the purposes of this Special Provision, a disadvantaged business enterprise (DBE) means a business certified by the Department in accordance with the requirements of 49 CFR Part 26 and listed in the Illinois Unified Certification Program (IL UCP) DBE Directory.

STATE OBLIGATION. This Special Provision will also be used by the Department to satisfy the requirements of the Business Enterprise for Minorities, Females, and Persons with Disabilities Act, 30 ILCS 575. When this Special Provision is used to satisfy state law requirements on 100 percent state-funded contracts, the federal government has no involvement in such contracts (not a federal-aid contract) and no responsibility to oversee the implementation of this Special Provision by the Department on those contracts. DBE participation on 100 percent state-funded contracts will not be credited toward fulfilling the Department's annual overall DBE goal required by the US Department of Transportation to comply with the federal DBE program requirements.

CONTRACTOR ASSURANCE. The Contractor makes the following assurance and agrees to include the assurance in each subcontract that the Contractor signs with a subcontractor.

The Contractor, subrecipient, or subcontractor shall not discriminate on the basis of race, color, national origin, or sex in the performance of this contract. The Contractor shall carry out applicable requirements of 49 CFR Part 26 in the award and administration of contracts funded in whole or in part with federal or state funds. Failure by the Contractor to carry out these requirements is a material breach of this contract, which may result in the termination of this contract or such other remedy as the recipient deems appropriate.

OVERALL GOAL SET FOR THE DEPARTMENT. As a requirement of compliance with 49 CFR Part 26, the Department has set an overall goal for DBE participation in its federally assisted contracts. That goal applies to all federal-aid funds the Department will expend in its federally assisted contracts for the subject reporting fiscal year. The Department is required to make a good faith effort to achieve the overall goal. The dollar amount paid to all approved DBE companies performing work called for in this contract is eligible to be credited toward fulfillment of the Department's overall goal.

CONTRACT GOAL TO BE ACHIEVED BY THE CONTRACTOR. This contract includes a specific DBE utilization goal established by the Department. The goal has been included because the Department has determined that the work of this contract has subcontracting opportunities that may be suitable for performance by DBE companies. The determination is

based on an assessment of the type of work, the location of the work, and the availability of DBE companies to do a part of the work. The assessment indicates that, in the absence of unlawful discrimination, and in an arena of fair and open competition, DBE companies can be expected to perform 18.00% of the work. This percentage is set as the DBE participation goal for this contract. Consequently, in addition to the other award criteria established for this contract, the Department will only award this contract to a bidder who makes a good faith effort to meet this goal of DBE participation in the performance of the work. A bidder makes a good faith effort for award consideration if either of the following is done in accordance with the procedures set for in this Special Provision:

- (a) The bidder documents that enough DBE participation has been obtained to meet the goal: or
- (b) The bidder documents that a good faith effort has been made to meet the goal, even though the effort did not succeed in obtaining enough DBE participation to meet the goal.

DBE LOCATOR REFERENCES. Bidders shall consult the IL UCP DBE Directory as a reference source for DBE-certified companies. In addition, the Department maintains a letting and item specific DBE locator information system whereby DBE companies can register their interest in providing quotes on particular bid items advertised for letting. Information concerning DBE companies willing to quote work for particular contracts may be obtained by contacting the Department's Bureau of Small Business Enterprises at telephone number (217)785-4611, or by visiting the Department's website at www.dot.il.gov.

BIDDING PROCEDURES. Compliance with this Special Provision is a material bidding requirement. The failure of the bidder to comply will render the bid not responsive.

- (a) The bidder shall submit a Disadvantaged Business Utilization Plan on Department forms SBE 2025 and 2026 with the bid.
- (b) The Utilization Plan shall indicate that the bidder either has obtained sufficient DBE participation commitments to meet the contract goal or has not obtained enough DBE participation commitments in spite of a good faith effort to meet the goal. The Utilization Plan shall further provide the name, telephone number, and telefax number of a responsible official of the bidder designated for purposes of notification of plan approval or disapproval under the procedures of this Special Provision.
- (c) The Utilization Plan shall include a DBE Participation Commitment Statement, Department form SBE 2025, for each DBE proposed for the performance of work to achieve the contract goal. For bidding purposes, submission of the completed SBE 2025 forms, signed by the DBEs and faxed to the bidder will be acceptable as long as the original is available and provided upon request. All elements of information indicated on the said form shall be provided, including but not limited to the following:
 - (1) The names and addresses of DBE firms that will participate in the contract;

- (2) A description, including pay item numbers, of the work each DBE will perform;
- (3) The dollar amount of the participation of each DBE firm participating. The dollar amount of participation for identified work shall specifically state the quantity, unit price, and total subcontract price for the work to be completed by the DBE. If partial pay items are to be performed by the DBE, indicate the portion of each item, a unit price where appropriate and the subcontract price amount;
- (4) DBE Participation Commitment Statements, form SBE 2025, signed by the bidder and each participating DBE firm documenting the commitment to use the DBE subcontractors whose participation is submitted to meet the contract goal;
- (5) if the bidder is a joint venture comprised of DBE companies and non-DBE companies, the plan must also include a clear identification of the portion of the work to be performed by the DBE partner(s); and,
- (6) If the contract goal is not met, evidence of good faith efforts.

GOOD FAITH EFFORT PROCEDURES. The contract will not be awarded until the Utilization Plan submitted by the apparent successful bidder is approved. All information submitted by the bidder must be complete, accurate and adequately document that enough DBE participation has been obtained or document that good faith efforts of the bidder, in the event enough DBE participation has not been obtained, before the Department will commit to the performance of the contract by the bidder. The Utilization Plan will be approved by the Department if the Utilization Plan documents sufficient commercially useful DBE work performance to meet the contract goal or the bidder submits sufficient documentation of a good faith effort to meet the contract goal pursuant to 49 CFR Part 26, Appendix A. The Utilization Plan will not be approved by the Department if the Utilization Plan does not document sufficient DBE participation to meet the contract goal unless the apparent successful bidder documented in the Utilization Plan that it made a good faith effort to meet the goal. This means that the bidder must show that all necessary and reasonable steps were taken to achieve the contract goal. Necessary and reasonable steps are those which, by their scope, intensity and appropriateness to the objective, could reasonably be expected to obtain sufficient DBE participation, even if they were not successful. The Department will consider the quality, quantity, and intensity of the kinds of efforts that the bidder has made. Mere *pro forma* efforts, in other words, efforts done as a matter of form, are not good faith efforts; rather, the bidder is expected to have taken genuine efforts that would be reasonably expected of a bidder actively and aggressively trying to obtain DBE participation sufficient to meet the contract goal.

- (a) The following is a list of types of action that the Department will consider as part of the evaluation of the bidder's good faith efforts to obtain participation. These listed factors are not intended to be a mandatory checklist and are not intended to be exhaustive. Other factors or efforts brought to the attention of the Department may be relevant in appropriate cases, and will be considered by the Department.

- (1) Soliciting through all reasonable and available means (e.g. attendance at pre-bid meetings, advertising and/or written notices) the interest of all certified DBE companies that have the capability to perform the work of the contract. The bidder must solicit this interest within sufficient time to allow the DBE companies to respond to the solicitation. The bidder must determine with certainty if the DBE companies are interested by taking appropriate steps to follow up initial solicitations.
- (2) Selecting portions of the work to be performed by DBE companies in order to increase the likelihood that the DBE goals will be achieved. This includes, where appropriate, breaking out contract work items into economically feasible units to facilitate DBE participation, even when the prime Contractor might otherwise prefer to perform these work items with its own forces.
- (3) Providing interested DBE companies with adequate information about the plans, specifications, and requirements of the contract in a timely manner to assist them in responding to a solicitation.
- (4) a. Negotiating in good faith with interested DBE companies. It is the bidder's responsibility to make a portion of the work available to DBE subcontractors and suppliers and to select those portions of the work or material needs consistent with the available DBE subcontractors and suppliers, so as to facilitate DBE participation. Evidence of such negotiation includes the names, addresses, and telephone numbers of DBE companies that were considered; a description of the information provided regarding the plans and specifications for the work selected for subcontracting; and evidence as to why additional agreements could not be reached for DBE companies to perform the work.

b. A bidder using good business judgment would consider a number of factors in negotiating with subcontractors, including DBE subcontractors, and would take a firm's price and capabilities as well as contract goals into consideration. However, the fact that there may be some additional costs involved in finding and using DBE companies is not in itself sufficient reason for a bidder's failure to meet the contract DBE goal, as long as such costs are reasonable. Also the ability or desire of a bidder to perform the work of a contract with its own organization does not relieve the bidder of the responsibility to make good faith efforts. Bidders are not, however, required to accept higher quotes from DBE companies if the price difference is excessive or unreasonable.
- (5) Not rejecting DBE companies as being unqualified without sound reasons based on a thorough investigation of their capabilities. The bidder's standing within its industry, membership in specific groups, organizations, or associations and political or social affiliations (for example union vs. non-union employee status) are not legitimate causes for the rejection or non-solicitation of bids in the bidder's efforts to meet the project goal.

- (6) Making efforts to assist interested DBE companies in obtaining bonding, lines of credit, or insurance as required by the recipient or Contractor.
 - (7) Making efforts to assist interested DBE companies in obtaining necessary equipment, supplies, materials, or related assistance or services.
 - (8) Effectively using the services of available minority/women community organizations; minority/women contractors' groups; local, state, and federal minority/women business assistance offices; and other organizations as allowed on a case-by-case basis to provide assistance in the recruitment and placement of DBE companies.
- (b) If the Department determines that the apparent successful bidder has made a good faith effort to secure the work commitment of DBE companies to meet the contract goal, the Department will award the contract provided that it is otherwise eligible for award. If the Department determines that the bidder has failed to meet the requirements of this Special Provision or that a good faith effort has not been made, the Department will notify the responsible company official designated in the Utilization Plan that the bid is not responsive. The notification shall include a statement of reasons for the determination.
- (c) The bidder may request administrative reconsideration of a determination adverse to the bidder within the five working days after the receipt of the notification date of the determination by delivering the request to the Department of Transportation, Bureau of Small Business Enterprises, Contract Compliance Section, 2300 South Dirksen Parkway, Room 319, Springfield, Illinois 62764 (Telefax: (217)785-1524). Deposit of the request in the United States mail on or before the fifth business day shall not be deemed delivery. The determination shall become final if a request is not made and delivered. A request may provide additional written documentation and/or argument concerning the issues raised in the determination statement of reasons, provided the documentation and arguments address efforts made prior to submitting the bid. The request will be forwarded to the Department's Reconsideration Officer. The Reconsideration Officer will extend an opportunity to the bidder to meet in person in order to consider all issues of documentation and whether the bidder made a good faith effort to meet the goal. After the review by the Reconsideration Officer, the bidder will be sent a written decision within ten working days after receipt of the request for consideration, explaining the basis for finding that the bidder did or did not meet the goal or make adequate good faith efforts to do so. A final decision by the Reconsideration Officer that a good faith effort was made shall approve the Utilization Plan submitted by the bidder and shall clear the contract for award. A final decision that a good faith effort was not made shall render the bid not responsive.

CALCULATING DBE PARTICIPATION. The Utilization Plan values represent work anticipated to be performed and paid for upon satisfactory completion. The Department is only able to count toward the achievement of the overall goal and the contract goal the value of payments made for the work actually performed by DBE companies. In addition, a DBE must perform a commercially useful function on the contract to be counted. A commercially useful function is

generally performed when the DBE is responsible for the work and is carrying out its responsibilities by actually performing, managing, and supervising the work involved. The Department and Contractor are governed by the provisions of 49 CFR Part 26.55(c) on questions of commercially useful functions as it affects the work. Specific counting guidelines are provided in 49 CFR Part 26.55, the provisions of which govern over the summary contained herein.

- (a) DBE as the Contractor: 100 percent goal credit for that portion of the work performed by the DBE's own forces, including the cost of materials and supplies. Work that a DBE subcontracts to a non-DBE does not count toward the DBE goals.
- (b) DBE as a joint venture Contractor: 100 percent goal credit for that portion of the total dollar value of the contract equal to the distinct, clearly defined portion of the work performed by the DBE's own forces.
- (c) DBE as a subcontractor: 100 percent goal credit for the work of the subcontract performed by the DBE's own forces, including the cost of materials and supplies, excluding the purchase of materials and supplies or the lease of equipment by the DBE subcontractor from the prime Contractor or its affiliates. Work that a DBE subcontractor in turn subcontracts to a non-DBE does not count toward the DBE goal.
- (d) DBE as a trucker: 100 percent goal credit for trucking participation provided the DBE is responsible for the management and supervision of the entire trucking operation for which it is responsible. At least one truck owned, operated, licensed, and insured by the DBE must be used on the contract. Credit will be given for the following:
 - (1) The DBE may lease trucks from another DBE firm, including an owner-operator who is certified as a DBE. The DBE who leases trucks from another DBE receives credit for the total value of the transportation services the lessee DBE provides on the contract.
 - (2) The DBE may also lease trucks from a non-DBE firm, including from an owner-operator. The DBE who leases trucks from a non-DBE is entitled to credit only for the fee or commission it receives as a result of the lease arrangement.
- (e) DBE as a material supplier:
 - (1) 60 percent goal credit for the cost of the materials or supplies purchased from a DBE regular dealer.
 - (2) 100 percent goal credit for the cost of materials or supplies obtained from a DBE manufacturer.
 - (3) 100 percent credit for the value of reasonable fees and commissions for the procurement of materials and supplies if not a regular dealer or manufacturer.

CONTRACT COMPLIANCE. Compliance with this Special Provision is an essential part of the contract. The Department is prohibited by federal regulations from crediting the participation of a DBE included in the Utilization Plan toward either the contract goal or the Department's overall goal until the amount to be applied toward the goals has been paid to the DBE. The following administrative procedures and remedies govern the compliance by the Contractor with the contractual obligations established by the Utilization Plan. After approval of the Utilization Plan and award of the contract, the Utilization Plan and individual DBE Participation Statements become part of the contract. If the Contractor did not succeed in obtaining enough DBE participation to achieve the advertised contract goal, and the Utilization Plan was approved and contract awarded based upon a determination of good faith, the total dollar value of DBE work calculated in the approved Utilization Plan as a percentage of the awarded contract value shall become the amended contract goal. All work indicated for performance by an approved DBE shall be performed, managed, and supervised by the DBE executing the Participation Statement.

- (a) NO AMENDMENT. No amendment to the Utilization Plan may be made without prior written approval from the Department's Bureau of Small Business Enterprises. All requests for amendment to the Utilization Plan shall be submitted to the Department of Transportation, Bureau of Small Business Enterprises, Contract Compliance Section, 2300 South Dirksen Parkway, Room 319, Springfield, Illinois 62764. Telephone number (217)785-4611. Telefax number (217)785-1524.
- (b) TERMINATION OR REPLACEMENT. The Contractor shall not terminate or replace a DBE listed on the approved Utilization Plan, or perform with other forces work designated for a listed DBE except as provided in the Special Provision.
- (c) CHANGES TO WORK. Any deviation from the DBE condition-of-award or contract plans, specifications, or special provisions must be approved, in writing, by the Department as provided elsewhere in the Contract. The Contractor shall notify affected DBEs in writing of any changes in the scope of work which result in a reduction in the dollar amount condition-of-award to the contract. Where the revision includes work committed to a new DBE subcontractor, not previously involved in the project, then a Request for Approval of Subcontractor, Department form BC 260A, must be signed and submitted. If the commitment of work is in the form of additional tasks assigned to an existing subcontract, then a new Request for Approval of Subcontractor shall not be required. However, the Contractor must document efforts to assure that the existing DBE subcontractor is capable of performing the additional work and has agreed in writing to the change.
- (d) ALTERNATIVE WORK METHODS. In addition to the above requirements for reductions in the condition of award, additional requirements apply to the two cases of Contractor-initiated work substitution proposals. Where the contract allows alternate work methods which serve to delete or create underruns in condition of award DBE work, and the Contractor selects that alternate method or, where the Contractor proposes a substitute work method or material that serves to diminish or delete work committed to a DBE and replace it with other work, then the Contractor must demonstrate one of the following:

(1) That the replacement work will be performed by the same DBE (as long as the DBE is certified in the respective item of work) in a modification of the condition of award; or

(2) That the DBE is aware that its work will be deleted or will experience underruns and has agreed in writing to the change. If this occurs, the Contractor shall substitute other work of equivalent value to a certified DBE or provide documentation of good faith efforts to do so; or

(3) That the DBE is not capable of performing the replacement work or has declined to perform the work at a reasonable competitive price. If this occurs, the Contractor shall substitute other work of equivalent value to a certified DBE or provide documentation of good faith efforts to do so.

(e) TERMINATION AND REPLACEMENT PROCEDURES. The Contractor shall not terminate or replace a DBE subcontractor listed in the approved Utilization Plan without prior written consent. This includes, but is not limited to, instances in which the Contractor seeks to perform work originally designated for a DBE subcontractor with its own forces or those of an affiliate, a non-DBE firm, or with another DBE firm. Written consent will be granted only if the Bureau of Small Business Enterprises agrees, for reasons stated in its concurrence document, that the Contractor has good cause to terminate or replace the DBE firm. Before transmitting to the Bureau of Small Business Enterprises any request to terminate and/or substitute a DBE subcontractor, the Contractor shall give notice in writing to the DBE subcontractor, with a copy to the Bureau, of its intent to request to terminate and/or substitute, and the reason for the request. The Contractor shall give the DBE five days to respond to the Contractor's notice. The DBE so notified shall advise the Bureau and the Contractor of the reasons, if any, why it objects to the proposed termination of its subcontract and why the Bureau should not approve the Contractor's action. If required in a particular case as a matter of public necessity, the Bureau may provide a response period shorter than five days.

For purposes of this paragraph, good cause includes the following circumstances:

(1) The listed DBE subcontractor fails or refuses to execute a written contract;

(2) The listed DBE subcontractor fails or refuses to perform the work of its subcontract in a way consistent with normal industry standards. Provided, however, that good cause does not exist if the failure or refusal of the DBE subcontractor to perform its work on the subcontract results from the bad faith or discriminatory action of the prime contractor;

(3) The listed DBE subcontractor fails or refuses to meet the prime Contractor's reasonable, nondiscriminatory bond requirements;

- (4) The listed DBE subcontractor becomes bankrupt, insolvent, or exhibits credit unworthiness;
- (5) The listed DBE subcontractor is ineligible to work on public works projects because of suspension and debarment proceedings pursuant 2 CFR Parts 180, 215 and 1,200 or applicable state law.
- (6) You have determined that the listed DBE subcontractor is not a responsible contractor;
- (7) The listed DBE subcontractor voluntarily withdraws from the projects and provides to you written notice of its withdrawal;
- (8) The listed DBE is ineligible to receive DBE credit for the type of work required;
- (9) A DBE owner dies or becomes disabled with the result that the listed DBE contractor is unable to complete its work on the contract;
- (10) Other documented good cause that compels the termination of the DBE subcontractor. Provided, that good cause does not exist if the prime Contractor seeks to terminate a DBE it relied upon to obtain the contract so that the prime Contractor can self-perform the work for which the DBE contractor was engaged or so that the prime Contractor can substitute another DBE or non-DBE contractor after contract award.

When a DBE is terminated, or fails to complete its work on the Contract for any reason the Contractor shall make a good faith effort to find another DBE to substitute for the original DBE to perform at least the same amount of work under the contract as the terminated DBE to the extent needed to meet the established Contract goal.

- (f) PAYMENT RECORDS. The Contractor shall maintain a record of payments for work performed to the DBE participants. The records shall be made available to the Department for inspection upon request. After the performance of the final item of work or delivery of material by a DBE and final payment therefore to the DBE by the Contractor, but not later than thirty calendar days after payment has been made by the Department to the Contractor for such work or material, the Contractor shall submit a DBE Payment Agreement on Department form SBE 2115 to the Regional Engineer. If full and final payment has not been made to the DBE, the DBE Payment Agreement shall indicate whether a disagreement as to the payment required exists between the Contractor and the DBE or if the Contractor believes that the work has not been satisfactorily completed. If the Contractor does not have the full amount of work indicated in the Utilization Plan performed by the BDE companies indicated in the Utilization Plan and after good faith efforts are reviewed, the Department may deduct from contract payments to the Contractor the amount of the goal not achieved as liquidated and ascertained damages. The Contractor may request an administrative

reconsideration of any amount deducted as damages pursuant to subsection (h) of this part.

(g) ENFORCEMENT. The Department reserves the right to withhold payment to the Contractor to enforce the provisions of this Special Provision. Final payment shall not be made on the contract until such time as the Contractor submits sufficient documentation demonstrating achievement of the goal in accordance with this Special Provision or after liquidated damages have been determined and collected.

(h) RECONSIDERATION. Notwithstanding any other provision of the contract, including but not limited to Article 109.09 of the Standard Specifications, the Contractor may request administrative reconsideration of a decision to deduct the amount of the goal not achieved as liquidated damages. A request to reconsider shall be delivered to the Contract Compliance Section and shall be handled and considered in the same manner as set forth in paragraph (c) of "Good Faith Effort Procedures" of this Special Provision, except a final decision that a good faith effort was not made during contract performance to achieve the goal agreed to in the Utilization Plan shall be the final administrative decision of the Department.

80029

DRAIN PIPE, TILE, DRAINAGE MAT, AND WALL DRAIN (BDE)

Effective: January 1, 2013

Add the following to Article 101.01 of the Standard Specifications.

“NTPEP National Transportation Product Evaluation Program”

Revise Article 1040.03(f) of the Standard Specifications to read:

“(f) Profile Wall Pipe-304. The manufacturer shall be listed as compliant through the NTPEP program and the pipe shall be according to AASHTO M 304.”

Revise the first sentence of the first paragraph of Article 1040.04(a) of the Standard Specifications to read:

“The manufacturer shall be listed as compliant through the NTPEP program and the pipe shall be according to AASHTO M 252 (nominal size – 3 to 10 in. (75 to 250 mm)).”

Revise Article 1040.04(b) of the Standard Specifications to read:

“(b) Corrugated PE Pipe with a Smooth Interior. The manufacturer shall be listed as compliant through the NTPEP program and the pipe shall be according to AASHTO M 294 (nominal size – 12 to 48 in. (300 to 1200 mm)). The pipe shall be Type S or D.”

80312

FUEL COST ADJUSTMENT (BDE) (RETURN FORM WITH BID)

Effective: April 1, 2009

Revised: July 1, 2009

Description. Fuel cost adjustments will be made to provide additional compensation to the Contractor, or a credit to the Department, for fluctuations in fuel prices when optioned by the Contractor. The bidder shall indicate on the attached form whether or not this special provision will be part of the contract and submit the completed form with his/her bid. Failure to submit the form or failure to indicate contract number, company name and sign and date the form shall make this contract exempt of fuel cost adjustments for all categories of work. Failure to indicate "Yes" for any category of work will make that category of work exempt from fuel cost adjustment.

General. The fuel cost adjustment shall apply to contract pay items as grouped by category. The adjustment shall only apply to those categories of work checked "Yes", and only when the cumulative plan quantities for a category exceed the required threshold. Adjustments to work items in a category, either up or down, and work added by adjusted unit price will be subject to fuel cost adjustment only when the category representing the added work was subject to the fuel cost adjustment. Added work paid for by time and materials will not be subject to fuel cost adjustment. Category descriptions and thresholds for application and the fuel usage factors which are applicable to each are as follows:

(a) Categories of Work.

- (1) Category A: Earthwork. Contract pay items performed under Sections 202, 204, and 206 including any modified standard or nonstandard items where the character of the work to be performed is considered earthwork. The cumulative total of all applicable item plan quantities shall exceed 25,000 cu yd (20,000 cu m). Included in the fuel usage factor is a weighted average 0.10 gal/cu yd (0.50 liters/cu m) factor for trucking.
- (2) Category B: Subbases and Aggregate Base Courses. Contract pay items constructed under Sections 311, 312 and 351 including any modified standard or nonstandard items where the character of the work to be performed is considered construction of a subbase or aggregate, stabilized or modified base course. The cumulative total of all applicable item plan quantities shall exceed 5000 tons (4500 metric tons). Included in the fuel usage factor is a 0.60 gal/ton (2.50 liters/metric ton) factor for trucking.
- (3) Category C: Hot-Mix Asphalt (HMA) Bases, Pavements and Shoulders. Contract pay items constructed under Sections 355, 406, 407 and 482 including any modified standard or nonstandard items where the character of the work to be performed is considered HMA bases, pavements and shoulders. The cumulative total of all applicable item plan quantities shall exceed 5000 tons (4500 metric tons). Included in the fuel usage factor is 0.60 gal/ton (2.50 liters/metric ton) factor for trucking.

(4) Category D: Portland Cement Concrete (PCC) Bases, Pavements and Shoulders. Contract pay items constructed under Sections 353, 420, 421 and 483 including any modified standard or nonstandard items where the character of the work to be performed is considered PCC base, pavement or shoulder. The cumulative total of all applicable item plan quantities shall exceed 7500 sq yd (6000 sq m). Included in the fuel usage factor is 1.20 gal/cu yd (5.94 liters/cu m) factor for trucking.

(5) Category E: Structures. Structure items having a cumulative bid price that exceeds \$250,000 for pay items constructed under Sections 502, 503, 504, 505, 512, 516 and 540 including any modified standard or nonstandard items where the character of the work to be performed is considered structure work when similar to that performed under these sections and not included in categories A through D.

(b) Fuel Usage Factors.

English Units Category	Factor	Units
A - Earthwork	0.34	gal / cu yd
B - Subbase and Aggregate Base courses	0.62	gal / ton
C - HMA Bases, Pavements and Shoulders	1.05	gal / ton
D - PCC Bases, Pavements and Shoulders	2.53	gal / cu yd
E - Structures	8.00	gal / \$1000

Metric Units Category	Factor	Units
A - Earthwork	1.68	liters / cu m
B - Subbase and Aggregate Base courses	2.58	liters / metric ton
C - HMA Bases, Pavements and Shoulders	4.37	liters / metric ton
D - PCC Bases, Pavements and Shoulders	12.52	liters / cu m
E - Structures	30.28	liters / \$1000

(c) Quantity Conversion Factors.

Category	Conversion	Factor
B	sq yd to ton	0.057 ton / sq yd / in depth
	sq m to metric ton	0.00243 metric ton / sq m / mm depth
C	sq yd to ton	0.056 ton / sq yd / in depth
	sq m to metric ton	0.00239 m ton / sq m / mm depth
D	sq yd to cu yd	0.028 cu yd / sq yd / in depth
	sq m to cu m	0.001 cu m / sq m / mm depth

Method of Adjustment. Fuel cost adjustments will be computed as follows.

$$| CA = (FPI_P - FPI_L) \times FUF \times Q$$

Where: CA = Cost Adjustment, \$
FPI_P = Fuel Price Index, as published by the Department for the month the work is performed, \$/gal (\$/liter)
FPI_L = Fuel Price Index, as published by the Department for the month prior to the letting, \$/gal (\$/liter)
FUF = Fuel Usage Factor in the pay item(s) being adjusted
Q = Authorized construction Quantity, tons (metric tons) or cu yd (cu m)

The entire FUF indicated in paragraph (b) will be used regardless of use of trucking to perform the work.

Progress Payments. Fuel cost adjustments will be calculated for each calendar month in which applicable work is performed; and will be paid or deducted when all other contract requirements for the items of work are satisfied. The adjustments shall not apply during contract time subject to liquidated damages for completion of the entire contract.

Final Quantities. Upon completion of the work and determination of final pay quantities, an adjustment will be prepared to reconcile any differences between estimated quantities previously paid and the final quantities. The value for the balancing adjustment will be based on a weighted average of FPI_P and Q only for those months requiring the cost adjustment. The cost adjustment will be applicable to the final measured quantities of all applicable pay items.

Basis of Payment. Fuel cost adjustments may be positive or negative but will only be made when there is a difference between the FPI_L and FPI_P in excess of five percent, as calculated by:

$$\text{Percent Difference} = \{(FPI_L - FPI_P) \div FPI_L\} \times 100$$

Return With Bid

**ILLINOIS DEPARTMENT
OF TRANSPORTATION**

**OPTION FOR
FUEL COST ADJUSTMENT**

The bidder shall submit this completed form with his/her bid. Failure to submit the form or properly complete contract number, company name, and sign and date the form shall make this contract exempt of fuel cost adjustments in all categories. Failure to indicate "Yes" for any category of work at the time of bid will make that category of work exempt from fuel cost adjustment. After award, this form, when submitted shall become part of the contract.

Contract No.: _____

Company Name: _____

Contractor's Option:

Is your company opting to include this special provision as part of the contract plans for the following categories of work?

- | | | |
|--|-----|--------------------------|
| Category A Earthwork. | Yes | <input type="checkbox"/> |
| Category B Subbases and Aggregate Base Courses | Yes | <input type="checkbox"/> |
| Category C HMA Bases, Pavements and Shoulders | Yes | <input type="checkbox"/> |
| Category D PCC Bases, Pavements and Shoulders | Yes | <input type="checkbox"/> |
| Category E Structures | Yes | <input type="checkbox"/> |

Signature: _____ **Date:** _____

80229

333

GRANULAR MATERIALS (BDE)

Effective: November 1, 2012

Revise the title of Article 1003.04 of the Standard Specifications to read:

"1003.04 Fine Aggregate for Bedding, Trench Backfill, Embankment, Porous Granular Backfill, Sand Backfill for Underdrains, and French Drains."

Revise Article 1003.04(c) of the Standard Specifications to read:

"(c) Gradation. The fine aggregate gradations for granular embankment, granular backfill, bedding, and trench backfill for pipe culverts and storm sewers shall be FA 1, FA 2, or FA 6 through FA 21.

The fine aggregate gradation for porous granular embankment, porous granular backfill, french drains, and sand backfill for underdrains shall be FA 1, FA 2, or FA 20, except the percent passing the No. 200 (75 µm) sieve shall be 2±2."

Revise Article 1004.05(c) of the Standard Specifications to read:

"(c) Gradation. The coarse aggregate gradations shall be as follows.

Application	Gradation
Blotter	CA 15
Granular Embankment, Granular Backfill, Bedding, and Trench Backfill for Pipe Culverts and Storm Sewers	CA 6, CA 9, CA 10, CA 12, CA17, CA18, and CA 19
Porous Granular Embankment, Porous Granular Backfill, and French Drains	CA 7, CA 8, CA 11, CA 15, CA 16 and CA 18"

80303

HOT-MIX ASPHALT - DENSITY TESTING OF LONGITUDINAL JOINTS (BDE)

Effective: January 1, 2010

Revised: April 1, 2012

Description. This work shall consist of testing the density of longitudinal joints as part of the quality control/quality assurance (QC/QA) of hot-mix asphalt (HMA). Work shall be according to Section 1030 of the Standard Specifications except as follows.

Quality Control/Quality Assurance (QC/QA). Delete the second and third sentence of the third paragraph of Article 1030.05(d)(3) of the Standard Specifications.

Add the following paragraphs to the end of Article 1030.05(d)(3) of the Standard Specifications:

“Longitudinal joint density testing shall be performed at each random density test location. Longitudinal joint testing shall be located at a distance equal to the lift thickness or a minimum of 4 in. (100 mm), from each pavement edge. (i.e. for a 5 in. (125 mm) lift the near edge of the density gauge or core barrel shall be within 5 in. (125 mm) from the edge of pavement.) Longitudinal joint density testing shall be performed using either a correlated nuclear gauge or cores.

- a. Confined Edge. Each confined edge density shall be represented by a one-minute nuclear density reading or a core density and shall be included in the average of density readings or core densities taken across the mat which represents the Individual Test.
- b. Unconfined Edge. Each unconfined edge joint density shall be represented by an average of three one-minute density readings or a single core density at the given density test location and shall meet the density requirements specified herein. The three one-minute readings shall be spaced ten feet apart longitudinally along the unconfined pavement edge and centered at the random density test location.”

Revise the Density Control Limits table in Article 1030.05(d)(4) of the Standard Specifications to read:

"Mixture Composition	Parameter	Individual Test (includes confined edges)	Unconfined Edge Joint Density Minimum
IL-4.75	Ndesign = 50	93.0 – 97.4%	91.0%
IL-9.5, IL-12.5	Ndesign ≥ 90	92.0 – 96.0%	90.0%
IL-9.5, IL-9.5L, IL-12.5	Ndesign < 90	92.5 – 97.4%	90.0%
IL-19.0, IL-25.0	Ndesign ≥ 90	93.0 – 96.0%	90.0%
IL-19.0, IL-19.0L, IL-25.0	Ndesign < 90	93.0 – 97.4%	90.0%

SMA	Ndesign = 50 & 80	93.5 - 97.4%	91.0%
All Other	Ndesign = 30	93.0 - 97.4%	90.0%"

80246

LIQUIDATED DAMAGES (BDE)

Effective: April 1, 2013

Revise the table in Article 108.09 of the Standard Specifications to read:

"Schedule of Deductions for Each Day of Overrun in Contract Time"			
Original Contract Amount		Daily Charges	
From More Than	To and Including	Calendar Day	Work Day
\$ 0	\$ 100,000	\$ 475	\$ 675
100,000	500,000	750	1,050
500,000	1,000,000	1,025	1,425
1,000,000	3,000,000	1,275	1,725
3,000,000	6,000,000	1,425	2,000
6,000,000	12,000,000	2,300	3,450
12,000,000	And over	6,775	9,525"

80320

LRFD STORM SEWER BURIAL TABLES (BDE)

Effective: November 1, 2013

Revise Article 550.02 of the Standard Specifications to read as follows:

"Item	Article Section
(a) Clay Sewer Pipe	1040.02
(b) Extra Strength Clay Pipe	1040.02
(c) Concrete Sewer, Storm Drain, and Culvert Pipe	1042
(d) Reinforced Concrete Culvert, Storm Drain, and Sewer Pipe	1042
(e) Reinforced Concrete Elliptical Culvert, Storm Drain, and Sewer Pipe (Note 1)	1042
(f) Reinforced Concrete Arch Culvert, Storm Drain, and Sewer Pipe (Note 1)	1042
(g) Polyvinyl Chloride (PVC) Pipe	1040.03
(h) Corrugated Polyvinyl Chloride (PVC) Pipe with a Smooth Interior	1040.03
(i) Corrugated Polypropylene (CPP) Pipe with Smooth Interior	1040.07
(j) Rubber Gaskets and Preformed Flexible Joint Sealants for Concrete Pipe	1056
(k) Mastic Joint Sealer for Pipe	1055
(l) External Sealing Band	1057
(m) Fine Aggregate (Note 2)	1003.04
(n) Coarse Aggregate (Note 3)	1004.05
(o) Reinforcement Bars and Welded Wire Fabric	1006.10
(p) Handling Hole Plugs	1042.16
(q) Polyethylene (PE) Pipe with a Smooth Interior	1040.04
(r) Corrugated Polyethylene (PE) Pipe with a Smooth Interior	1040.04

Note 1. The class of elliptical and arch pipe used for various storm sewer sizes and heights of fill shall conform to the requirements for circular pipe.

Note 2. The fine aggregate shall be moist.

Note 3. The coarse aggregate shall be wet."

Revise the table for permitted materials in Article 550.03 of the Standard Specifications as follows:

"Class	Materials
A	Rigid Pipes: Clay Sewer Pipe Extra Strength Clay Pipe Concrete Sewer, Storm Drain, and Culvert Pipe Reinforced Concrete Culvert, Storm Drain, and Sewer Pipe Reinforced Concrete Elliptical Culvert, Storm Drain, and Sewer Pipe Reinforced Concrete Arch Culvert, Storm Drain, and Sewer Pipe
B	Rigid Pipes: Clay Sewer Pipe Extra Strength Clay Pipe Concrete Sewer, Storm Drain, and Culvert Pipe Reinforced Concrete Culvert, Storm Drain, and Sewer Pipe Reinforced Concrete Elliptical Culvert, Storm Drain, and Sewer Pipe Reinforced Concrete Arch Culvert, Storm Drain, and Sewer Pipe Flexible Pipes: Polyvinyl Chloride (PVC) Pipe Corrugated Polyvinyl Chloride Pipe (PVC) with a Smooth Interior Polyethylene (PE) Pipe with a Smooth Interior Corrugated Polyethylene (PE) Pipe with a Smooth Interior Corrugated Polypropylene (CPP) Pipe with a Smooth Interior"

Replace the storm sewers tables in Article 550.03 of the Standard Specifications with the following:

STORM SEWERS
KIND OF MATERIAL PERMITTED AND STRENGTH REQUIRED
FOR A GIVEN PIPE DIAMETERS AND FILL HEIGHTS OVER THE TOP OF THE PIPE

Nominal Diameter in.	Type 1										Type 2					
	Fill Height: 3' and less With 1' minimum cover										Fill Height: Greater than 3' not exceeding 10'					
	RCCP	CSP	ESCP	PVC	CPVC	PE	CPE	CPP	RCCP	CSP	ESCP	PVC	CPVC	PE	CPE	CPP
10	NA	3	X	X	X	X	X	NA	1	*X	X	X	X	X	NA	
12	IV	NA	X	X	X	X	X	II	1	*X	X	X	X	X	X	
15	IV	NA	X	X	NA	X	X	II	1	*X	X	X	X	X	X	
18	IV	NA	X	X	X	X	X	II	2	X	X	X	X	X	X	
21	III	NA	X	X	NA	NA	NA	II	2	X	X	X	NA	NA	NA	
24	III	NA	X	X	X	X	X	II	2	X	X	X	X	X	X	
27	III	NA	NA	NA	NA	NA	NA	II	3	X	NA	NA	NA	NA	NA	
30	IV	NA	X	X	X	X	X	II	3	X	X	X	X	X	X	
33	III	NA	NA	NA	NA	NA	NA	II	NA	X	NA	NA	NA	NA	NA	
36	III	NA	NA	NA	X	X	X	II	NA	X	X	X	X	X	X	
42	II	NA	X	X	X	X	X	II	NA	X	X	X	X	X	X	
48	II	NA	X	X	X	X	X	II	NA	X	X	X	X	X	X	
54	II	NA	NA	NA	NA	NA	NA	II	NA	NA	NA	NA	NA	NA	NA	
60	II	NA	NA	NA	NA	NA	NA	II	NA	NA	NA	NA	NA	NA	NA	
66	II	NA	NA	NA	NA	NA	NA	II	NA	NA	NA	NA	NA	NA	NA	
72	II	NA	NA	NA	NA	NA	NA	II	NA	NA	NA	NA	NA	NA	NA	
78	II	NA	NA	NA	NA	NA	NA	II	NA	NA	NA	NA	NA	NA	NA	
84	II	NA	NA	NA	NA	NA	NA	II	NA	NA	NA	NA	NA	NA	NA	
90	II	NA	NA	NA	NA	NA	NA	III	NA	NA	NA	NA	NA	NA	NA	
96	II	NA	NA	NA	NA	NA	NA	III	NA	NA	NA	NA	NA	NA	NA	
102	II	NA	NA	NA	NA	NA	NA	III	NA	NA	NA	NA	NA	NA	NA	
108	II	NA	NA	NA	NA	NA	NA	III	NA	NA	NA	NA	NA	NA	NA	

RCCP Reinforced Concrete Culvert, Storm Drain, and Sewer Pipe
 CSP Concrete Sewer, Storm drain, and Culvert Pipe
 PVC Polyvinyl Chloride Pipe
 CPVC Corrugated Polyvinyl Chloride Pipe
 ESCP Extra Strength Clay Pipe
 PE Polyethylene Pipe with a Smooth Interior
 CPE Corrugated Polyethylene Pipe with a Smooth Interior
 CPP Corrugated Polypropylene pipe with a Smooth Interior
 X This material may be used for the given pipe diameter and fill height.
 NA This material is Not Acceptable for the given pipe diameter and fill height.
 * May also use Standard Strength Clay Pipe

STORM SEWERS (Metric)
KIND OF MATERIAL PERMITTED AND STRENGTH REQUIRED
FOR A GIVEN PIPE DIAMETERS AND FILL HEIGHTS OVER THE TOP OF THE PIPE

Nominal Diameter in.	Type 1											Type 2					
	Fill Height: 1 m' and less With 300 mm minimum cover											Fill Height: Greater than 1 m not exceeding 3 m					
	RCCP	CSP	ESCP	PVC	CPVC	PE	CPE	CPP	RCCP	CSP	ESCP	PVC	CPVC	PE	CPE	CPP	
250	NA	3	X	X	X	X	X	NA	1	*X	X	X	X	X	NA		
300	IV	NA	X	X	X	X	X	II	1	*X	X	X	X	X	X		
375	IV	NA	NA	X	NA	X	X	II	1	*X	X	X	NA	X	X		
450	IV	NA	NA	X	X	X	X	II	2	X	X	X	X	X	X		
525	III	NA	NA	X	X	NA	NA	II	2	X	X	X	NA	NA	NA		
600	III	NA	NA	X	X	X	X	II	2	X	X	X	X	X	X		
675	III	NA	NA	NA	NA	NA	NA	II	3	X	NA	NA	NA	NA	NA		
750	IV	NA	NA	NA	X	X	X	II	3	X	X	X	X	X	X		
825	III	NA	NA	NA	NA	NA	NA	II	NA	X	NA	NA	NA	NA	NA		
900	III	NA	NA	NA	X	X	X	II	NA	X	X	X	X	NA	X		
1050	II	NA	X	X	X	X	X	II	NA	X	X	X	X	NA	NA		
1200	II	NA	X	X	X	X	X	II	NA	X	X	X	X	NA	NA		
1350	II	NA	NA	NA	NA	NA	NA	II	NA	NA	NA	NA	NA	NA	NA		
1500	II	NA	NA	NA	NA	NA	NA	II	NA	NA	NA	NA	NA	NA	NA		
1650	II	NA	NA	NA	NA	NA	NA	II	NA	NA	NA	NA	NA	NA	NA		
1800	II	NA	NA	NA	NA	NA	NA	II	NA	NA	NA	NA	NA	NA	NA		
1950	II	NA	NA	NA	NA	NA	NA	II	NA	NA	NA	NA	NA	NA	X		
2100	II	NA	NA	NA	NA	NA	NA	II	NA	NA	NA	NA	NA	NA	NA		
2250	II	NA	NA	NA	NA	NA	NA	II	NA	NA	NA	NA	NA	NA	NA		
2400	II	NA	NA	NA	NA	NA	NA	II	NA	NA	NA	NA	NA	NA	NA		
2550	II	NA	NA	NA	NA	NA	NA	II	NA	NA	NA	NA	NA	NA	NA		
2700	II	NA	NA	NA	NA	NA	NA	II	NA	NA	NA	NA	NA	NA	NA		

RCCP Reinforced Concrete Culvert, Storm Drain, and Sewer Pipe
CSP Concrete Sewer, Storm drain, and Culvert Pipe
PVC Polyvinyl Chloride Pipe
CPVC Corrugated Polyvinyl Chloride Pipe
ESCP Extra Strength Clay Pipe
PE Polyethylene Pipe with a Smooth Interior
CPE Corrugated Polyethylene Pipe with a Smooth Interior
CPP Corrugated Polypropylene pipe with a Smooth Interior
X This material may be used for the given pipe diameter and fill height.
NA This material is Not Acceptable for the given pipe diameter and fill height.
* May also use Standard Strength Clay Pipe

STORM SEWERS
KIND OF MATERIAL PERMITTED AND STRENGTH REQUIRED
FOR A GIVEN PIPE DIAMETERS AND FILL HEIGHTS OVER THE TOP OF THE PIPE

Nominal Diameter in.	Type 3											Type 4					
	Fill Height: Greater than 10' not exceeding 15'											Fill Height: Greater than 15' not exceeding 20'					
	RCCP	CSP	ESCP	PVC	CPVC	PE	CPE	CPP	RCCP	CSP	ESCP	PVC	CPVC	PE	CPP		
10	NA	2	X	X	X	X	NA	NA	3	X	X	X	X	NA	NA		
12	III	2	X	X	X	NA	X	IV	NA	NA	X	X	X	X	NA		
15	III	3	X	X	NA	NA	X	IV	NA	NA	X	X	X	NA	X		
18	III	NA	X	X	X	NA	X	IV	NA	NA	X	X	X	NA	NA		
21	III	NA	NA	X	X	NA	NA	IV	NA	NA	X	X	X	NA	NA		
24	III	NA	NA	NA	X	NA	NA	IV	NA	NA	X	X	X	NA	NA		
27	III	NA	NA	NA	NA	NA	NA	IV	NA	NA	NA	NA	NA	NA	NA		
30	III	NA	NA	NA	X	NA	X	IV	NA	NA	X	X	X	NA	NA		
33	III	NA	NA	NA	NA	NA	NA	IV	NA	NA	NA	NA	NA	NA	NA		
36	III	NA	NA	NA	X	X	X	IV	NA	NA	X	X	X	NA	NA		
42	III	NA	NA	NA	X	X	X	IV	NA	NA	X	X	X	NA	NA		
48	III	NA	NA	NA	X	X	X	IV	NA	NA	X	X	X	NA	NA		
54	III	NA	NA	NA	NA	NA	NA	IV	NA	NA	NA	NA	NA	NA	NA		
60	III	NA	NA	NA	NA	NA	NA	IV	NA	NA	NA	NA	NA	NA	NA		
66	III	NA	NA	NA	NA	NA	NA	IV	NA	NA	NA	NA	NA	NA	NA		
72	III	NA	NA	NA	NA	NA	NA	IV	NA	NA	NA	NA	NA	NA	NA		
78	III	NA	NA	NA	NA	NA	NA	IV	NA	NA	NA	NA	NA	NA	NA		
84	III	NA	NA	NA	NA	NA	NA	IV	NA	NA	NA	NA	NA	NA	NA		
90	III	NA	NA	NA	NA	NA	NA	IV	NA	NA	NA	NA	NA	NA	NA		
96	III	NA	NA	NA	NA	NA	NA	IV	NA	NA	NA	NA	NA	NA	NA		
102	IV	NA	NA	NA	NA	NA	NA	IV	NA	NA	NA	NA	NA	NA	NA		
108	1360	NA	NA	NA	NA	NA	NA	1710	NA	NA	NA	NA	NA	NA	NA		

RCCP Reinforced Concrete Culvert, Storm Drain, and Sewer Pipe
 CSP Concrete Sewer, Storm drain, and Culvert Pipe
 PVC Polyvinyl Chloride Pipe
 CPVC Corrugated Polyvinyl Chloride Pipe
 ESCP Extra Strength Clay Pipe
 PE Polyethylene Pipe with a Smooth Interior
 CPE Corrugated Polyethylene Pipe with a Smooth Interior
 CPP Corrugated Polypropylene pipe with a Smooth Interior
 X This material is Not Acceptable for the given pipe diameter and fill height.
 * This material may be used for the given pipe diameter and fill height.
 Note May also use Standard Strength Clay Pipe
 RCCP with a number instead of a Roman numeral shall be furnished according to AASHTO M170 Section 6. This number represents the D-load to produce a 0.01 in crack.

STORM SEWERS (metric)
KIND OF MATERIAL PERMITTED AND STRENGTH REQUIRED
FOR A GIVEN PIPE DIAMETERS AND FILL HEIGHTS OVER THE TOP OF THE PIPE

Nominal Diameter in.	Type 3										Type 4					
	Fill Height: Greater than 3 m not exceeding 4.5 m										Fill Height: Greater than 4.5 m not exceeding 6 m					
	RCCP	CSP	ESCP	PVC	CPVC	PE	CPE	CPP	RCCP	CSP	ESCP	PVC	CPVC	PE	CPP	
250	NA	2	X	X	X	X	NA	NA	3	X	X	X	X	NA	NA	
300	III	2	X	X	X	NA	NA	X	NA	NA	X	X	X	X	NA	
375	III	3	X	X	X	X	NA	X	NA	NA	X	X	X	NA	X	
450	III	NA	X	X	X	X	NA	X	NA	NA	X	X	X	NA	NA	
525	III	NA	NA	X	X	NA	NA	NA	NA	NA	X	X	X	NA	NA	
600	III	NA	NA	X	X	X	NA	NA	NA	NA	X	X	X	NA	NA	
675	III	NA	NA	NA	NA	NA	NA	IV	NA	NA	NA	NA	NA	NA	NA	
750	III	NA	NA	NA	X	X	NA	IV	NA	NA	X	NA	X	NA	NA	
825	III	NA	NA	NA	NA	NA	NA	IV	NA	NA	NA	NA	NA	NA	NA	
900	III	NA	NA	NA	X	X	NA	IV	NA	NA	X	X	X	NA	NA	
1050	III	NA	NA	NA	X	X	NA	IV	NA	NA	X	NA	X	NA	NA	
1200	III	NA	NA	NA	NA	X	NA	IV	NA	NA	X	NA	X	NA	NA	
1350	III	NA	NA	NA	NA	NA	NA	IV	NA	NA	NA	NA	NA	NA	NA	
1500	III	NA	NA	NA	NA	NA	NA	IV	NA	NA	NA	NA	NA	NA	NA	
1650	III	NA	NA	NA	NA	NA	NA	IV	NA	NA	NA	NA	NA	NA	NA	
1800	III	NA	NA	NA	NA	NA	NA	IV	NA	NA	NA	NA	NA	NA	NA	
1950	III	NA	NA	NA	NA	NA	NA	IV	NA	NA	NA	NA	NA	NA	NA	
2100	III	NA	NA	NA	NA	NA	NA	IV	NA	NA	NA	NA	NA	NA	NA	
2250	III	NA	NA	NA	NA	NA	NA	80	NA	NA	NA	NA	NA	NA	NA	
2400	III	NA	NA	NA	NA	NA	NA	80	NA	NA	NA	NA	NA	NA	NA	
2550	IV	NA	NA	NA	NA	NA	NA	80	NA	NA	NA	NA	NA	NA	NA	
2700	70	NA	NA	NA	NA	NA	NA	80	NA	NA	NA	NA	NA	NA	NA	

RCCP Reinforced Concrete Culvert, Storm Drain, and Sewer Pipe
 CSP Concrete Sewer, Storm drain, and Culvert Pipe
 PVC Polyvinyl Chloride Pipe
 CPVC Corrugated Polyvinyl Chloride Pipe
 ESCP Extra Strength Clay Pipe
 PE Polyethylene Pipe with a Smooth Interior
 CPE Corrugated Polyethylene Pipe with a Smooth Interior
 CPP Corrugated Polypropylene pipe with a Smooth Interior
 X This material may be used for the given pipe diameter and fill height.
 NA This material is Not Acceptable for the given pipe diameter and fill height.
 * May also use Standard Strength Clay Pipe
 Note RCCP with a number instead of a Roman numeral shall be furnished according to AASHTO M170 Section 6. This number represents the metric D-load to produce a 25.4 micro-meter crack.

243

STORM SEWERS									
KIND OF MATERIAL PERMITTED AND STRENGTH REQUIRED FOR A GIVEN PIPE DIAMETERS AND FILL HEIGHTS OVER THE TOP OF THE PIPE									
Nominal Diameter in.	Type 5 Fill Height: Greater than 20' not exceeding 25'			Type 6 Fill Height: Greater than 25' not exceeding 30'			Type 7 Fill Height: Greater than 30' not exceeding 35'		
	RCCP	PVC	CPVC	RCCP	PVC	CPVC	RCCP	CPVC	CPVC
	10	NA	X	X	NA	X	X	NA	X
12	IV	X	X	V	X	X	V	X	X
15	IV	X	X	V	X	X	V	X	X
18	IV	X	X	V	X	X	V	X	X
21	IV	X	X	V	X	X	V	X	X
24	IV	X	X	V	X	X	V	X	X
27	IV	NA	NA	V	NA	NA	V	NA	NA
30	IV	X	X	V	X	X	V	X	X
33	IV	NA	NA	V	NA	NA	V	NA	NA
36	IV	X	X	V	X	X	V	X	X
42	IV	X	NA	V	X	NA	V	NA	NA
48	IV	X	NA	V	X	NA	V	NA	NA
54	IV	NA	NA	V	NA	NA	V	NA	NA
60	IV	NA	NA	V	NA	NA	V	NA	NA
66	IV	NA	NA	V	NA	NA	V	NA	NA
72	V	NA	NA	V	NA	NA	V	NA	NA
78	2020	NA	NA	2370	NA	NA	2730	NA	NA
84	2020	NA	NA	2380	NA	NA	2740	NA	NA
90	2030	NA	NA	2390	NA	NA	2750	NA	NA
96	2040	NA	NA	2400	NA	NA	2750	NA	NA
102	2050	NA	NA	2410	NA	NA	2760	NA	NA
108	2060	NA	NA	2410	NA	NA	2770	NA	NA

RCCP Reinforced Concrete Culvert, Storm Drain, and Sewer Pipe

PVC Polyvinyl Chloride Pipe

CPVC Corrugated Polyvinyl Chloride Pipe

ESCP Extra Strength Clay Pipe

X This material may be used for the given pipe diameter and fill height.

NA This material is Not Acceptable for the given pipe diameter and fill height.

Note RCCP with a number instead of a Roman numeral shall be furnished according to AASHTO M170 Section 6. This number represents the D-load to produce a 0.01 in crack.

355

STORM SEWERS (metric)									
KIND OF MATERIAL PERMITTED AND STRENGTH REQUIRED FOR A GIVEN PIPE DIAMETERS AND FILL HEIGHTS OVER THE TOP OF THE PIPE									
Nominal Diameter in.	Type 5			Type 6			Type 7		
	Fill Height: Greater than 20' not exceeding 25'			Fill Height: Greater than 25' not exceeding 30'			Fill Height: Greater than 30' not exceeding 35'		
	RCCP	PVC	CPVC	RCCP	PVC	CPVC	RCCP	RCCP	CPVC
250	NA	X	X	NA	X	X	NA	NA	X
300	IV	X	X	V	X	X	V	V	X
375	IV	X	X	V	X	X	V	V	X
450	IV	X	X	V	X	X	V	V	X
525	IV	X	X	V	X	X	V	V	X
600	IV	X	X	V	X	X	V	V	X
675	IV	NA	NA	V	NA	NA	V	V	NA
750	IV	X	X	V	X	X	V	V	X
825	IV	NA	NA	V	NA	NA	V	V	NA
900	IV	X	X	V	X	X	V	V	X
1050	IV	X	NA	V	X	NA	V	V	NA
1200	IV	X	NA	V	X	NA	V	V	NA
1350	IV	NA	NA	V	NA	NA	V	V	NA
1500	IV	NA	NA	V	NA	NA	V	V	NA
1650	IV	NA	NA	V	NA	NA	V	V	NA
1800	V	NA	NA	V	NA	NA	V	V	NA
1950	100	NA	NA	110	NA	NA	130	130	NA
2100	100	NA	NA	110	NA	NA	130	130	NA
2250	100	NA	NA	110	NA	NA	130	130	NA
2400	100	NA	NA	120	NA	NA	130	130	NA
2550	100	NA	NA	120	NA	NA	130	130	NA
2700	100	NA	NA	120	NA	NA	130	130	NA

RCCP Reinforced Concrete Culvert, Storm Drain, and Sewer Pipe

PVC Polyvinyl Chloride Pipe

CPVC Corrugated Polyvinyl Chloride Pipe

ESCP Extra Strength Clay Pipe

X This material may be used for the given pipe diameter and fill height.

NA This material is Not Acceptable for the given pipe diameter and fill height.

Note RCCP with a number instead of a Roman numeral shall be furnished according to AASHTO M170 Section 6. This number represents the metric D-load to produce a 25.4 micro-meter crack.

Revise the sixth paragraph of Article 550.06 of the Standard Specifications to read:

“PVC, PE and CPP pipes shall be joined according to the manufacturer’s specifications.”

Revise the first and second paragraphs of Article 550.08 of the Standard Specifications to read:

“**550.08 Deflection Testing for Storm Sewers.** All PVC, PE, and CPP storm sewers shall be tested for deflection not less than 30 days after the pipe is installed and the backfill compacted. The testing shall be performed in the presence of the Engineer.

For PVC, PE, and CPP storm sewers with diameters 24 in. (600 mm) or smaller, a mandrel drag shall be used for deflection testing. For PVC, PE, and CPP storm sewers with diameters over 24 in. (600 mm), deflection measurements other than by a mandrel shall be used.”

Revise the fifth paragraph of Article 550.08 to read as follows.

“The outside diameter of the mandrel shall be 95 percent of the base inside diameter. For all PVC pipe the base inside diameter shall be defined using ASTM D 3034 methodology. For all PE and CPP pipe, the base inside diameter shall be defined as the average inside diameter based on the minimum and maximum tolerances specified in the corresponding ASTM or AASHTO material specifications.”

Revise the first paragraph of Article 1040.03 of the Standard Specifications to read:

“**1040.03 Polyvinyl Chloride (PVC) Pipe.** Acceptance testing of PVC pipe and fittings shall be accomplished during the same construction season in which they are installed. The section properties shall be according to the manufacturer pre-submitted geometric properties on file with the Department. The manufacturer shall submit written certification that the material meets those properties. The pipe shall meet the following additional requirements.”

Delete Articles 1040.03(e) and (f) of the Standard Specifications.

Revise Articles 1040.04(c) and (d) of the Standard Specifications to read:

“(c) PE Profile Wall Pipe for Insertion Lining. The pipe shall be according to ASTM F 894. When used for insertion lining of pipe culverts, the pipe liner shall have a minimum pipe stiffness of 46 psi (317 kPa) at five percent deflection for nominal inside diameters of 42 in. (1050 mm) or less. For nominal inside diameters of greater than 42 in. (1050 mm), the pipe liner shall have a minimum pipe stiffness of 32.5 psi (225 kPa) at five percent deflection. All sizes shall have wall construction that presents essentially smooth internal and external surfaces.

(d) PE Pipe with a Smooth Interior. The pipe shall be according to ASTM F 714 (DR 32.5) with a minimum cell classification of PE 335434 as defined in ASTM D 3350. The section properties shall be according to the manufacturer pre-submitted geometric properties on file with the Department. The manufacturer shall submit written

certification that the material meets those properties and the resin used to manufacture the pipe meets or exceeds the minimum cell classification requirements.”

Add the following to Section 1040 of the Standard Specifications:

“1040.08 Polypropylene (PP) Pipe. Storage and handling shall be according to the manufacturer's recommendations, except in no case shall the pipe be exposed to direct sunlight for more than six months. Acceptance testing of the pipe shall be accomplished during the same construction season in which it is installed. The section properties shall be according to the manufacturer pre-submitted geometric properties on file with the Department. The manufacturer shall submit written certification that the material meets those properties. The pipe shall meet the following additional requirements.

- (a) Corrugated PP Pipe with a Smooth Interior. The pipe shall be according to AAHSTO M 330 (nominal size – 12 to 60 in. (300 to 1500 mm)). The pipe shall be Type S or D.
- (b) Perforated Corrugated PP Pipe with A Smooth Interior. The pipe shall be according to AASHTO M 330 (nominal size – 12 to 60 in. (300 to 1500 mm)). The pipe shall be Type SP. In addition, the top centerline of the pipe shall be marked so that it is readily visible from the top of the trench before backfilling, and the upper ends of the slot perforations shall be a minimum of ten degrees below the horizontal.”

80325

PAVEMENT REMOVAL (BDE)

Effective: April 1, 2013

Revise Article 440.07(c) of the Standard Specifications to read:

“(c) Adjustment of Quantities. The quantity of pavement removal will be adjusted if the thickness of the existing pavement varies more than 15 percent from that shown on the plans. The quantity will be either increased or decreased according to the following table.

% change of thickness	% change of quantity
0 to less than 15	0
15 to less than 20	10
20 to less than 30	15
30 to less than 50	20

If the thickness of the existing pavement varies by 50 percent or more from that shown on the plans, the character of the work will be considered significantly changed and an adjustment to the contract will be made according to Article 104.02.

When an adjustment is made for variations in pavement thickness a resulting adjustment will also be made in the earthwork quantities when applicable.

No adjustment will be made for variations in the amount of reinforcement.”

80321

PAYMENTS TO SUBCONTRACTORS (BDE)

Effective: June 1, 2000

Revised: January 1, 2006

Federal regulations found at 49 CFR §26.29 mandate the Department to establish a contract clause to require Contractors to pay subcontractors for satisfactory performance of their subcontracts and to set the time for such payments.

State law also addresses the timing of payments to be made to subcontractors and material suppliers. Section 7 of the Prompt Payment Act, 30 ILCS 540/7, requires that when a Contractor receives any payment from the Department, the Contractor shall make corresponding, proportional payments to each subcontractor and material supplier performing work or supplying material within 15 calendar days after receipt of the Department payment. Section 7 of the Act further provides that interest in the amount of two percent per month, in addition to the payment due, shall be paid to any subcontractor or material supplier by the Contractor if the payment required by the Act is withheld or delayed without reasonable cause. The Act also provides that the time for payment required and the calculation of any interest due applies to transactions between subcontractors and lower-tier subcontractors and material suppliers throughout the contracting chain.

This Special Provision establishes the required federal contract clause, and adopts the 15 calendar day requirement of the State Prompt Payment Act for purposes of compliance with the federal regulation regarding payments to subcontractors. This contract is subject to the following payment obligations.

When progress payments are made to the Contractor according to Article 109.07 of the Standard Specifications, the Contractor shall make a corresponding payment to each subcontractor and material supplier in proportion to the work satisfactorily completed by each subcontractor and for the material supplied to perform any work of the contract. The proportionate amount of partial payment due to each subcontractor and material supplier throughout the contracting chain shall be determined by the quantities measured or otherwise determined as eligible for payment by the Department and included in the progress payment to the Contractor. Subcontractors and material suppliers shall be paid by the Contractor within 15 calendar days after the receipt of payment from the Department. The Contractor shall not hold retainage from the subcontractors. These obligations shall also apply to any payments made by subcontractors and material suppliers to their subcontractors and material suppliers; and to all payments made to lower tier subcontractors and material suppliers throughout the contracting chain. Any payment or portion of a payment subject to this provision may only be withheld from the subcontractor or material supplier to whom it is due for reasonable cause.

This Special Provision does not create any rights in favor of any subcontractor or material supplier against the State or authorize any cause of action against the State on account of any payment, nonpayment, delayed payment, or interest claimed by application of the State Prompt Payment Act. The Department will not approve any delay or postponement of the 15 day requirement except for reasonable cause shown after notice and hearing pursuant to Section

| 7(b) of the State Prompt Payment Act. State law creates other and additional remedies available to any subcontractor or material supplier, regardless of tier, who has not been paid for work properly performed or material furnished. These remedies are a lien against public funds set forth in Section 23(c) of the Mechanics Lien Act, 770 ILCS 60/23(c), and a recovery on the Contractor's payment bond according to the Public Construction Bond Act, 30 ILCS 550.

80022

PLACING AND CONSOLIDATING CONCRETE (BDE)

Effective: January 1, 2013

Revise the first paragraph of Article 503.06 of the Standard Specifications to read:

“503.06 Forms. Forms shall be set and maintained to the lines and grades shown on the plans, and shall be tight to prevent concrete leakage.”

Revise Article 503.07 of the Standard Specifications to read:

“503.07 Placing and Consolidating. No concrete shall be placed on ice, snow, or frozen foundation material.

The method and manner of placing concrete shall be such as to avoid segregation or separation of the aggregates or the displacement of the reinforcement. The external surface of all concrete shall be thoroughly worked during the operations of placing in such a manner as to work the mortar against the forms to produce a smooth finish free of honeycomb and with a minimum of water and air pockets.

Open troughs and chutes shall extend as nearly as practicable to the point of deposit. Dropping the concrete a distance of more than 5 ft (1.5 m) or depositing a large quantity at any point and running or working it along the forms will not be permitted. The concrete for walls with an average thickness of 12 in. (300 mm) or less shall be placed with tubes so that the drop is not greater than 5 ft (1.5 m).

For self-consolidating concrete, the maximum distance of horizontal flow from the point of deposit shall be 15 ft (4.6 m). The distance may be increased if the dynamic segregation index (DSI) at the maximum flow distance is 10.0 percent or less according to Illinois Test Procedure SCC-8 (Option C). The maximum distance using the DSI shall be 25 ft (7.6 m). In addition, this specified horizontal flow distance shall apply to precast products. In the case of precast prestressed concrete products, refer to the Department's "Manual of Fabrication for Precast Prestressed Concrete Products" for the specified horizontal flow distance requirements.

When the form height for placing the self-consolidating concrete is greater than 10 ft (3.0 m), direct monitoring of form pressure shall be performed by the Contractor according to Illinois Test Procedure SCC-10. The monitoring requirement is a minimum, and the Contractor shall remain responsible for adequate design of the falsework and forms. The Contractor shall record the formwork pressure during concrete placement. This information shall be used by the Contractor to prevent the placement rate from exceeding the maximum formwork pressure allowed, to monitor the thixotropic change in the concrete during the pour, and to make appropriate adjustments to the mix design. This information shall be provided to the Engineer during the pour.

When concrete is pumped, the equipment shall be suitable in kind and adequate in capacity for the work and arranged so that vibrations will not damage freshly placed concrete. Aluminum

pipe or conduit will not be permitted in pumping or placing concrete. Mixed concrete shall be supplied to maintain continuous operation of the pumping equipment.

When air entrained concrete is pumped, an accessory or accessories shall be incorporated in the discharge components to minimize air loss. The maximum allowable air loss caused by the pumping operation shall be 3.0 percent with the minimum air content at the point of discharge meeting the requirements of Article 1020.04.

Placing of concrete shall be regulated so that the pressures caused by the wet concrete will not exceed those used in the design of the forms. Special care shall be taken to fill each part of the forms by depositing the concrete as near its final position as possible, to work the coarser aggregates back from the face, and to force the concrete under and around the reinforcement bars without displacing them. Leakage through forms onto beams or girders shall not be allowed to harden and shall be removed while in a plastic state.

The concrete shall be consolidated by internal vibration unless self-consolidating concrete is used. Self-consolidating concrete may be used for inaccessible locations where consolidation by internal vibration is not practicable. The self consolidating concrete shall be rodded with a piece of lumber, conduit, or vibrator if the material has lost its fluidity prior to placement of additional concrete. The vibrator may only be permitted if it can be used in a manner that does not cause segregation as determined by the Engineer. Any other method for restoring the fluidity of the concrete shall be approved by the Engineer.

The Contractor shall provide and use a sufficient number of vibrators to ensure that consolidation can be started immediately after the concrete has been deposited in the forms.

The vibrators shall be inserted into the concrete immediately after it is deposited and shall be moved throughout the mass so as to thoroughly work the concrete around the reinforcement, embedded fixtures, and into the corners and angles of the forms. Vibrators shall not be attached to the forms, reinforcement bars, or the surface of the concrete.

Application of vibrators shall be at points uniformly spaced and not farther apart than twice the radius over which the vibration is visibly effective. The duration of the vibration at the points of insertion shall be sufficient to thoroughly consolidate the concrete into place but shall not be continued so as to cause segregation. When consolidating concrete in bridge decks, the vibrator shall be vertically inserted into the concrete for 3 - 5 seconds or for a period of time determined by the Engineer. Vibration shall be supplemented by spading when required by the Engineer. In addition to the internal vibration required herein, formed surfaces which will be exposed to view after completion of the work shall be spaded with a spading tool approved by the Engineer.

Concrete shall be placed in continuous horizontal layers. When it is necessary by reason of an emergency to place less than a complete horizontal layer in one operation, such layer shall terminate in a vertical bulkhead. Separate batches shall follow each other closely and in no case shall the interval of time between the placing of successive batches be greater than 20 minutes.

If mix foaming or detrimental material is observed during placement or at the completion of a pour, the material shall be removed while the concrete is still plastic

After the concrete has taken its initial set, care shall be exercised to avoid jarring the forms or placing any strain on the ends of projecting reinforcement.”

Revise Article 516.12(a) of the Standard Specifications to read:

“(a) Free Fall Placement. The free fall placement shall only be permitted in shafts that can be dewatered to ensure less than 3 in. (75 mm) of standing water exist at the time of placement without causing side wall instability. The height of free fall placement shall be a maximum of 60 ft (18.3 m) as measured from the discharge end, but it shall be reduced to a maximum of 30 ft (9.1 m) when self-consolidating concrete is used. The Contractor shall obtain approval from the Engineer to place self-consolidating concrete by free fall.

Concrete placed by free fall shall fall directly to the base without contacting either the rebar cage or shaft sidewall. Drop chutes may be used to direct concrete to the base during free fall placement.

Drop chutes used to direct placement of free fall concrete shall consist of a smooth tube of either one continuous section or multiple pieces that can be added and removed. Concrete may be placed through either a hopper at the top of the tube or side openings as the drop chute is retrieved during concrete placement. The drop chute shall be supported so that free fall does not exceed the specified maximum 60 ft (18.3 m) or 30 ft (9.1 m) at all times from the discharge end, and to ensure the concrete does not strike the rebar cage. If placement cannot be satisfactorily accomplished by free fall in the opinion of the Engineer, either a tremie or pump shall be used to accomplish the pour.”

80316

PLANTING WOODY PLANTS (BDE)

Effective: January 1, 2012
Revised: August 1, 2012

Revise the second sentence of Article 253.01 of the Standard Specifications to read:

“This work shall consist of furnishing, transporting, and planting woody plants such as trees, shrubs, evergreens, vines, and seedlings.”

Revise Article 253.02(a) of the Standard Specifications to read:

“(a) Trees, Shrubs, Evergreens, Vines and Seedlings1081.01”

Revise the first sentence of Article 253.08(a) of the Standard Specifications to read:

“(a) Excavation for Deciduous Trees and Evergreen Trees.”

Revise the first sentence of Article 253.08(b) of the Standard Specifications to read:

“(b) Excavation for Deciduous Shrubs, Evergreen Shrubs, Vines, and Seedlings.”

Revise the first sentence of Article 253.13 of the Standard Specifications to read:

“All deciduous and evergreen trees, with the exception of multi-stem or clump form specimens, over 8 ft (2.5 m) in height shall require three 6 ft (2 m) long steel posts so placed that they are equidistant from each other and adjacent to the outside of the ball.”

Revise the first sentence of the second paragraph of Article 253.14 of the Standard Specifications to read:

“This period of establishment for the plants shall not delay acceptance of the entire project and final payment due if the contractor requires and receives from the subcontractor a third party performance bond naming the Department as obligee in the full amount of the planting quantities subject to this period of establishment, multiplied by their contract unit prices.”

Revise the third sentence of Article 253.16 of the Standard Specifications to read:

“Trees, shrubs, evergreens, and vines will be measured as each individual plant.”

Revise Article 253.17 of the Standard Specifications to read:

“**253.17 Basis of Payment.** This work will be paid for at the contract unit price per each for TREES, SHRUBS, EVERGREENS, or VINES, of the species, root type, and plant size specified; and per unit for SEEDLINGS. Payment will be made according to the following schedule.

(a) Initial Payment. Upon completion of planting, mulch covering, wrapping, and bracing, 90 percent of the pay item(s) will be paid.

(b) Final Payment. Upon inspection and acceptance of the plant material, or upon execution of a third party bond, the remaining ten percent of the pay item(s) will be paid.”

Revise the first paragraph of Article 1081.01 of the Standard Specifications to read:

“1081.01 Trees, Shrubs, Evergreens, Vines, and Seedlings. Trees, shrubs, evergreens, vines, and seedlings shall be according to the current standards adopted by the ANLA.”

80278

PORTLAND CEMENT CONCRETE (BDE)

Effective: January 1, 2012

Revised: November 1, 2013

Revise Notes 1 and 2 of Article 312.24 of the Standard Specifications to read:

"Note 1. Coarse aggregate shall be gradation CA 6, CA 7, CA 9, CA 10, or CA 11, Class D quality or better. Article 1020.05(d) shall apply.

Note 2. Fine aggregate shall be FA 1 or FA 2. Article 1020.05(d) shall apply."

Revise the first paragraph of Article 312.26 of the Standard Specifications to read:

312.26 Proportioning and Mix Design. At least 60 days prior to start of placing CAM II, the Contractor shall submit samples of materials for proportioning and testing. The mixture shall contain a minimum of 200 lb (90 kg) of cement per cubic yard (cubic meter). Portland cement may be replaced with fly ash according to Article 1020.05(c)(1), however the minimum portland cement content in the mixture shall be 170 lbs/cu yd (101 kg/cu m). Blends of coarse and fine aggregates will be permitted, provided the volume of fine aggregate does not exceed the volume of coarse aggregate. The Engineer will determine the proportions of materials for the mixture. However, the Contractor may substitute their own mix design. Article 1020.05(a) shall apply and a Level III PCC Technician shall develop the mix design."

Revise the second paragraph of Article 503.22 of the Standard Specifications to read:

Other cast-in-place concrete for structures will be paid for at the contract unit price per cubic yard (cubic meter) for CONCRETE HANDRAIL, CONCRETE ENCASEMENT, and SEAL COAT CONCRETE."

Add the following to Article 1003.02 of the Standard Specifications:

(e) Alkali Reaction.

- (1) ASTM C 1260. Each fine aggregate will be tested by the Department for alkali reaction according to ASTM C 1260. The test will be performed with Type I or II portland cement having a total equivalent alkali content ($\text{Na}_2\text{O} + 0.658\text{K}_2\text{O}$) of 0.90 percent or greater. The Engineer will determine the assigned expansion value for each aggregate, and these values will be made available on the Department's Alkali-Silica Potential Reactivity Rating List. The Engineer may differentiate aggregate based on ledge, production method, gradation number, or other factors. An expansion value of 0.03 percent will be assigned to limestone or dolomite fine

aggregates (manufactured stone sand). However, the Department reserves the right to perform the ASTM C 1260 test.

- (2) ASTM C 1293 by Department. In some instances, such as chert natural sand or other fine aggregates, testing according to ASTM C 1260 may not provide accurate test results. In this case, the Department may only test according to ASTM C 1293.
- (3) ASTM C 1293 by Contractor. If an individual aggregate has an ASTM C 1260 expansion value that is unacceptable to the Contractor, an ASTM C 1293 test may be performed by the Contractor to evaluate the Department's ASTM C 1260 test result. The laboratory performing the ASTM C 1293 test shall be approved by the Department according to the current Bureau of Materials and Physical Research Policy Memorandum "Minimum Laboratory Requirements for Alkali-Silica Reactivity (ASR) Testing".

The ASTM C 1293 test shall be performed with Type I or II portland cement having a total equivalent alkali content ($\text{Na}_2\text{O} + 0.658\text{K}_2\text{O}$) of 0.80 percent or greater. The interior vertical wall of the ASTM C 1293 recommended container (pail) shall be half covered with a wick of absorbent material consisting of blotting paper. If the testing laboratory desires to use an alternate container, wick of absorbent material, or amount of coverage inside the container with blotting paper, ASTM C 1293 test results with an alkali-reactive aggregate of known expansion characteristics shall be provided to the Engineer for review and approval. If the expansion is less than 0.040 percent after one year, the aggregate will be assigned an ASTM C 1260 expansion value of 0.08 percent that will be valid for two years, unless the Engineer determines the aggregate has changed significantly. If the aggregate is manufactured into multiple gradation numbers, and the other gradation numbers have the same or lower ASTM C 1260 value, the ASTM C 1293 test result may apply to multiple gradation numbers.

The Engineer reserves the right to verify a Contractor's ASTM C 1293 test result. When the Contractor performs the test, a split sample shall be provided to the Engineer. The Engineer may also independently obtain a sample at any time. The aggregate will be considered reactive if the Contractor or Engineer obtains an expansion value of 0.040 percent or greater.

Revise the first paragraph of Article 1004.01(e)(5) of the Standard Specifications to read:

"Crushed concrete, crushed slag, or lightweight aggregate for portland cement concrete shall be stockpiled in a moist condition (saturated surface dry or greater) and the moisture content shall be maintained uniformly throughout the stockpile by periodic sprinkling."

Revise Article 1004.02(d) of the Standard Specifications to read:

"(d) Combining Sizes. Each size shall be stored separately and care shall be taken to prevent them from being mixed until they are ready to be proportioned. Separate compartments shall be provided to proportion each size.

- (1) When Class BS concrete is to be pumped, the coarse aggregate gradation shall have a minimum of 45 percent passing the 1/2 in. (12.5 mm) sieve. The Contractor may combine two or more coarse aggregate sizes, consisting of CA 7, CA 11, CA 13, CA 14, and CA 16, provided a CA 7 or CA 11 is included in the blend.
- (2) If the coarse aggregate is furnished in separate sizes, they shall be combined in proportions to provide a uniformly graded coarse aggregate grading within the following limits.

Class of Concrete ^{1/}	Combined Sizes	Sieve Size and Percent Passing						
		2 1/2 in.	2 in.	1 3/4 in.	1 1/2 in.	1 in.	1/2 in.	No. 4
PV ^{2/}	CA 5 & CA 7	---	---	100	98±2	72±22	22±12	3±3
	CA 5 & CA 11	---	---	100	98±2	72±22	22±12	3±3
SI and SC ^{2/}	CA 3 & CA 7	100	95±5	---	---	55±25	20±10	3±3
	CA 3 & CA 11	100	95±5	---	---	55±25	20±10	3±3
	CA 5 & CA 7	---	---	100	98±2	72±22	22±12	3±3
	CA 5 & CA 11	---	---	100	98±2	72±22	22±12	3±3

Class of Concrete ^{1/}	Combined Sizes	Sieve Size (metric) and Percent Passing						
		63 mm	50 mm	45 mm	37.5 mm	25 mm	12.5 mm	4.75 mm
PV ^{2/}	CA 5 & CA 7	---	---	100	98±2	72±22	22±12	3±3
	CA 5 & CA 11	---	---	100	98±2	72±22	22±12	3±3
SI and SC ^{2/}	CA 3 & CA 7	100	95±5	---	---	55±25	20±10	3±3
	CA 3 & CA 11	100	95±5	---	---	55±25	20±10	3±3
	CA 5 & CA 7	---	---	100	98±2	72±22	22±12	3±3
	CA 5 & CA 11	---	---	100	98±2	72±22	22±12	3±3

1/ See Table 1 of Article 1020.04.

2/ Any of the listed combination of sizes may be used."

Add the following to Article 1004.02 of the Standard Specifications:

(g) Alkali Reaction.

- (1) ASTM C 1260. Each coarse aggregate will be tested by the Department for alkali reaction according to ASTM C 1260. The test will be performed with Type I or II portland cement having a total equivalent alkali content ($\text{Na}_2\text{O} + 0.658\text{K}_2\text{O}$) of 0.90 percent or greater. The Engineer will determine the assigned expansion value for each aggregate, and these values will be made available on the Department's Alkali-Silica Potential Reactivity Rating List. The Engineer may differentiate aggregate based on ledge, production method, gradation number, or other factors. An expansion value of 0.05 percent will be assigned to limestone or dolomite coarse aggregates. However, the Department reserves the right to perform the ASTM C 1260 test.
- (2) ASTM C 1293 by Department. In some instances testing a coarse aggregate according to ASTM C 1260 may not provide accurate test results. In this case, the Department may only test according to ASTM C 1293.
- (3) ASTM C 1293 by Contractor. If an individual aggregate has an ASTM C 1260 expansion value that is unacceptable to the Contractor, an ASTM C 1293 test may be performed by the Contractor according to Article 1003.02(e)(3).

Revise the first paragraph of Article 1019.06 of the Standard Specifications to read:

"1019.06 Contractor Mix Design. A Contractor may submit their own mix design and may propose alternate fine aggregate materials, fine aggregate gradations, or material proportions. Article 1020.05(a) shall apply and a Level III PCC Technician shall develop the mix design."

Revise Section 1020 of the Standard Specifications to read:

"SECTION 1020. PORTLAND CEMENT CONCRETE

1020.01 Description. This item shall consist of the materials, mix design, production, testing, curing, low air temperature protection, and temperature control of concrete.

1020.02 Materials. Materials shall be according to the following.

Item	Article/Section
(a) Cement	1001
(b) Water	1002
(c) Fine Aggregate	1003
(d) Coarse Aggregate	1004

(e) Concrete Admixtures	1021
(f) Finely Divided Minerals	1010
(g) Concrete Curing Materials	1022
(h) Straw	1081.06(a)(1)
(i) Calcium Chloride	1013.01

1020.03 Equipment. Equipment shall be according to the following.

Item	Article/Section
(a) Concrete Mixers and Trucks	1103.01
(b) Batching and Weighing Equipment	1103.02
(c) Automatic and Semi-Automatic Batching Equipment	1103.03
(d) Water Supply Equipment	1103.11
(e) Membrane Curing Equipment	1101.09
(f) Mobile Portland Cement Concrete Plants	1103.04

1020.04 Concrete Classes and General Mix Design Criteria. The classes of concrete shown in Table 1 identify the various mixtures by the general uses and mix design criteria. If the class of concrete for a specific item of construction is not specified, Class SI concrete shall be used.

For the minimum cement factor in Table 1, it shall apply to portland cement, portland-pozzolan cement, and portland blast-furnace slag except when a particular cement is specified in the Table.

The Contractor shall not assume that the minimum cement factor indicated in Table 1 will produce a mixture that will meet the specified strength. In addition, the Contractor shall not assume that the maximum finely divided mineral allowed in a mix design according to Article 1020.05(c) will produce a mixture that will meet the specified strength. The Contractor shall select a cement factor within the allowable range that will obtain the specified strength. The Contractor shall take into consideration materials selected, seasonal temperatures, and other factors which may require the Contractor to submit multiple mix designs.

For a portland-pozzolan cement, portland blast-furnace slag cement, or when replacing portland cement with finely divided minerals per Articles 1020.05(c) and 1020.05(d), the portland cement content in the mixture shall be a minimum of 375 lbs/cu yd (222 kg/cu m). When the total of organic processing additions, inorganic processing additions, and limestone exceed 5.0 percent in the cement, the minimum portland cement content in the mixture shall be 400 lbs/cu yd (237 kg/cu m). When calculating the portland cement portion in the portland-pozzolan or portland blast-furnace slag cement, the AASHTO M 240 tolerance may be ignored.

Special classifications may be made for the purpose of including the concrete for a particular use or location as a separate pay item in the contract. The concrete used in such cases shall conform to this section.

TABLE 1. CLASSES OF CONCRETE AND MIX DESIGN CRITERIA											
Class of Conc.	Use	Specification Section Reference	Cement Factor cw/cu yd (3)		Water / Cement Ratio lb/lb	Sump in. (4)	Mix Design Compressive Strength (Flexural Strength)			Air Content %	Coarse Aggregate Gradations (14)
			Min.	Max.			psi, minimum	Days	psi, minimum		
PV	Pavement Base Course Base Course Widening Driveway Pavement Shoulders Shoulder Curb	420 or 421									
		353									
		354	5.65 (1)	7.05	0.32 - 0.42	2 - 4	Ty III 3500 (650)	3500 (650)	3500 (650)	5.0 - 8.0 (5)	CA 5 & CA 7, CA 5 & CA 11, CA 7, CA 11, or CA 14
		423	6.05 (2)			(5)					
		483									
PP	Pavement Patching Bridge Deck Patching (10)	442									
			6.50	7.50	0.32 - 0.44	2 - 4		3200 (600)	Article 701.17(e)(3)b.		
			6.20 (TY III)	7.20 (TY III)	0.32 - 0.38	2 - 6			at 48 hours	4.0 - 7.0	CA 7, CA 11, CA 13, CA 14, or CA 16
			7.35 (TY III) (8)	8.20	0.32 - 0.35	2 - 4			at 24 hours	4.0 - 6.0	
RR	Railroad Crossing		7.35 (TY III) (8)	7.35 (TY III) (8)	0.32 - 0.50	2 - 4		at 16 hours	4.0 - 6.0		
			6.00 (9)	6.25 (9)	0.32 - 0.40	2 - 6		at 8 hours	4.0 - 6.0		
			6.75 (9)	6.75 (9)	0.32 - 0.40	2 - 8			at 4 hours	4.0 - 6.0	
			6.50	7.50	0.32 - 0.44	2 - 4		3500 (650)	at 48 hours	4.0 - 7.0	CA 7, CA 11, or CA 14
			6.20 (TY III)	7.20 (TY III)	0.32 - 0.44	2 - 4			at 48 hours	5.0 - 8.0 (5)	CA 7, CA 11, or CA 14 (7)
BS	Bridge Superstructure Bridge Approach Slab	422	6.05	7.05	0.32 - 0.44	2 - 4 (5)					
		503									
PC	Various Precast Concrete Items Wet Cast Dry Cast	1042	5.65	7.05	0.32 - 0.44	1 - 4					
			5.65 (TY III)	7.05 (TY III)	0.25 - 0.40	0 - 1		See Section 1042		5.0 - 8.0	CA 7, CA 11, CA 13, CA 14, CA 16, or CA 7 & CA 16
PS	Precast Prestressed Members Precast Prestressed Piles and Extensions Precast Prestressed Sight Screen	504	5.65	7.05	0.32 - 0.44	1 - 4					
		512	5.65 (TY III)	7.05 (TY III)					Plans 5000	5.0 - 8.0	CA 11 (11), CA 13, CA 14 (11), or CA 16
		639							3500		

TABLE 1. CLASSES OF CONCRETE AND MIX DESIGN CRITERIA

Class of Conc.	Use	Specification Section Reference	Cement Factor cw/cu yd (3)		Water / Cement Ratio lb/lb	Sump in. (4)	Mix Design Compressive Strength (Flexural Strength) psi, minimum			Air Content %	Coarse Aggregate Gradations (14)
			Min.	Max			Days				
							3	14	28		
DS	Drilled Shaft (12) Metal Shell Piles (12) Sign Structures Drilled Shaft (12) Light Tower Foundation (12)	516	6.65	7.05	0.32 - 0.44	6 - 8 (6)	4000 (675)		5.0 - 8.0	CA 13, CA 14, CA 16, or a blend of these gradations.	
		512									
		734									
		837									
SC	Seal Coat	503	5.65 (1) 6.05 (2)	7.05	0.32 - 0.44	3 - 5	3500 (650)		Optional 6.0 max.	CA 3 & CA 7, CA 3 & CA 11, CA 5 & CA 7, CA 5 & CA 11, CA 7, or CA 11	
SI	Structures (except Superstructure) Sidewalk Slope Wall Encasement Box Culverts End Section and Collar Curb, Gutter, Curb & Gutter, Median, and Paved Ditch Concrete Barrier Sign Structures Spread Footing Concrete Foundation Pole Foundation (12) Traffic Signal Foundation Drilled Shaft (12) Square or Rectangular	503	5.65 (1) 6.05 (2)	7.05	0.32 - 0.44	2 - 4 (5)	3500 (650)		5.0 - 8.0 (5)	CA 3 & CA 7, CA 3 & CA 11, CA 5 & CA 7, CA 5 & CA 11, CA 7, CA 11, CA 13, CA 14, or CA 16 (13)	
		424									
		511									
		512									
		540									
		542									
		606									
		637									
		734									
		836									
		878									

363

Notes:

- (1) Central-mixed.
- (2) Truck-mixed or shrink-mixed.
- (3) For Class SC concrete and for any other class of concrete that is to be placed underwater, except Class DS concrete, the cement factor shall be increased by ten percent.
- (4) The maximum slump may be increased to 7 in. when a high range water-reducing admixture is used for all classes of concrete, except Class PV, SC, and PP. For Class SC, the maximum slump may be increased to 8 in. For Class PP-1, the maximum slump may be increased to 6 in. For Class PS, the 7 in. maximum slump may be increased to 8 1/2 in. if the high range water-reducing admixture is the polycarboxylate type.
- (5) The slump range for slipform construction shall be 1/2 to 2 1/2 in. and the air content range shall be 5.5 to 8.0 percent.
- (6) If concrete is placed to displace drilling fluid, or against temporary casing, the slump shall be 8 - 10 in. at the point of placement. If a water-reducing admixture is used in lieu of a high range water-reducing admixture according to Article 1020.05(b)(7), the slump shall be 2 - 4 in.
- (7) For Class BS concrete used in bridge deck patching, the coarse aggregate gradation shall be CA 13, CA 14, or CA 16, except CA 11 may be used for full-depth patching.
- (8) In addition to the Type III portland cement, 100 lb/cu yd of ground granulated blast-furnace slag and 50 lb/cu yd of microsilica (silica fume) shall be used. For an air temperature greater than 85 °F, the Type III portland cement may be replaced with Type I or II portland cement.
- (9) The cement shall be a rapid hardening cement from the Department's "Approved List of Packaged, Dry, Rapid Hardening Cementitious Materials for Concrete Repairs" for PP-4 and calcium aluminate cement for PP-5.
- (10) For Class PP concrete used in bridge deck patching, the coarse aggregate gradation shall be CA 13, CA 14, or CA 16, except CA 11 may be used for full-depth patching. In addition, the mix design shall have 72 hours to obtain a 4,000 psi compressive or 675 psi flexural strength for all PP mix designs.
- (11) The nominal maximum size permitted is 3/4 in. Nominal maximum size is defined as the largest sieve which retains any of the aggregate sample particles.
- (12) The concrete mix shall be designed to remain fluid throughout the anticipated duration of the pour plus one hour. At the Engineer's discretion, the Contractor may be required to conduct a minimum 2 cu yd trial batch to verify the mix design.
- (13) CA 3 or CA 5 may be used when the nominal maximum size does not exceed two-thirds the clear distance between parallel reinforcement bars, or between the reinforcement bar and the form. Nominal maximum size is defined in Note 11.
- (14) Alternate combinations of gradation sizes may be used with the approval of the Engineer. Refer also to Article 1004.02(d) for additional information on combining sizes.

TABLE 1. CLASSES OF CONCRETE AND MIX DESIGN CRITERIA (metric)

Class of Conc.	Use	Specification Section Reference	Cement Factor kg/cu m (3)		Water / Cement Ratio kg/kg	Sump mm (4)	Mix Design Compressive Strength (Flexural Strength) kPa, minimum			Air Content %	Coarse Aggregate Gradations (14)
			Min.	Max			3	14	28		
PV	Pavement	420 or 421			0.32 - 0.42	50 - 100 (5)	24,000 (4500)	24,000 (4500)	5.0 - 8.0 (5)	CA 5 & CA 7, CA 5 & CA 11, CA 7, CA 11, or CA 14	
	Base Course	353	335 (1)	418							
	Base Course Widening	354	360 (2)								
	Driveway Pavement	423									
	Shoulders	483									
PP	Shoulder Curb	662									
	Pavement Patching										
	Bridge Deck Patching (10)	442									
	PP-1		385 (TY III)	445 (TY III)							
	PP-2		365 (TY III)	425 (TY III)							
	PP-3		435 (TY III) (8)	485 (TY III) (8)							
	PP-4		355 (9)	435 (TY III) (8)							
	PP-5		400 (9)	370 (9)							
				400 (9)							
				385 (TY III)	445 (TY III)						
RR	Railroad Crossing	422	365 (TY III)	425 (TY III)						CA 7, CA 11, or CA 14	
BS	Bridge Superstructure										
	Bridge Approach Slab	503	360	418						CA 7, CA 11, or CA 14 (7)	
PC	Various Precast Concrete Items	1042	335 (TY III)	418 (TY III)						CA 7, CA 11, CA 13, CA 14, CA 16, or CA 7 & CA 16	
	Wet Cast Dry Cast										
PS	Precast Prestressed Members	504	335 (TY III)	418 (TY III)						CA 11 (11), CA 13, CA 14 (11), or CA 16	
	Precast Prestressed Piles and Extensions	512	335 (TY III)	418 (TY III)							
	Precast Prestressed Sight Screen	639									

365

TABLE 1. CLASSES OF CONCRETE AND MIX DESIGN CRITERIA (metric)

Class of Conc.	Use	Specification Section Reference	Cement Factor kg/cu m (3)		Water / Cement Ratio kg/kg	Slump mm (4)	Mix Design Compressive Strength (Flexural Strength) kPa, minimum Days			Air Content %	Coarse Aggregate Gradations (14)
			Min.	Max.			3	14	28		
DS	Drilled Shaft (12)	516	395	418	0.32 - 0.44	150 - 200 (6)	27,500 (4650)		5.0 - 8.0	CA 13, CA 14, CA 16, or a blend of these gradations.	
	Metal Shell Piles (12)	512									
	Sign Structures	734									
	Drilled Shaft (12)	837									
	Light Tower Foundation (12)										
SC	Seal Coat	503	335 (1) 360 (2)	418	0.32 - 0.44	75 - 125	24,000 (4500)		Optional 6.0 max.	CA 3 & CA 7, CA 3 & CA 11, CA 5 & CA 7, CA 5 & CA 11, CA 7, or CA 11	
SI	Structures (except Superstructure)	503									
	Sidewalk	424									
	Slope Wall	511									
	Encasement	512									
	Box Culverts	540									
	End Section and Collar	542									
	Curb, Gutter, Curb & Gutter, Median, and Paved Ditch	606									
	Concrete Barrier	637									
	Sign Structures	734									
	Spread Footing										
Concrete Foundation											
Pole Foundation (12)	836										
Traffic Signal Foundation	878										
Drilled Shaft (12)											
Square or Rectangular											
			335 (1) 360 (2)	418	0.32 - 0.44	50 - 100 (5)	24,000 (4500)		5.0 - 8.0 (5)	CA 3 & CA 7, CA 3 & CA 11, CA 5 & CA 7, CA 5 & CA 11, CA 7, CA 11, CA 13, CA 14, or CA 16 (13)	

366

- 367
- Notes:
- (1) Central-mixed.
 - (2) Truck-mixed or shrink-mixed.
 - (3) For Class SC concrete and for any other class of concrete that is to be placed underwater, except Class DS concrete, the cement factor shall be increased by ten percent.
 - (4) The maximum slump may be increased to 175 mm when a high range water-reducing admixture is used for all classes of concrete except Class PV, SC, and PP. For Class SC, the maximum slump may be increased to 200 mm. For Class PP-1, the maximum slump may be increased to 150 mm. For Class PS, the 175 mm maximum slump may be increased to 215 mm if the high range water-reducing admixture is the polycarboxylate type.
 - (5) The slump range for slipform construction shall be 13 to 64 mm and the air content range shall be 5.5 to 8.0 percent.
 - (6) If concrete is placed to displace drilling fluid, or against temporary casing, the slump shall be 200 - 250 mm at the point of placement. If a water-reducing admixture is used in lieu of a high range water-reducing admixture according to Article 1020.05(b)(7), the slump shall be 50 - 100 mm.
 - (7) For Class BS concrete used in bridge deck patching, the coarse aggregate gradation shall be CA 13, CA 14, or CA 16, except CA 11 may be used for full-depth patching.
 - (8) In addition to the Type III portland cement, 60 kg/cu m of ground granulated blast-furnace slag and 30 kg/cu m of microsilica (silica fume) shall be used. For an air temperature greater than 30 °C, the Type III portland cement may be replaced with Type I or II portland cement.
 - (9) The cement shall be a rapid hardening cement from the Department's "Approved List of Packaged, Dry, Rapid Hardening Cementitious Materials for Concrete Repairs" for PP-4 and calcium aluminate cement for PP-5.
 - (10) For Class PP concrete used in bridge deck patching, the coarse aggregate gradation shall be CA 13, CA 14, or CA 16, except CA 11 may be used for full-depth patching. In addition, the mix design shall have 72 hours to obtain a 27,500 kPa compressive or 4,650 kPa flexural.
 - (11) The nominal maximum size permitted is 19 mm. Nominal maximum size is defined as the largest sieve which retains any of the aggregate sample particles.
 - (12) The concrete mix shall be designed to remain fluid throughout the anticipated duration of the pour plus one hour. At the Engineer's discretion, the Contractor may be required to conduct a minimum 1.5 cu m trial batch to verify the mix design.
 - (13) CA 3 or CA 5 may be used when the nominal maximum size does not exceed two-thirds the clear distance between parallel reinforcement bars, or between the reinforcement bar and the form. Nominal maximum size is defined in Note 11.
 - (14) Alternate combinations of gradation sizes may be used with the approval of the Engineer. Refer also to Article 1004.02(d) for additional information on combining sizes.

Self-consolidating concrete is a flowable mixture that does not require mechanical vibration for consolidation. Self-consolidating concrete mix designs may be developed for Class BS, PC, PS, DS, and SI concrete. Self-consolidating concrete mix designs may also be developed for precast concrete products that are not subjected to Class PC concrete requirements according to Section 1042. The mix design criteria for the concrete mixture shall be according to Article 1020.04 with the following exceptions.

- (a) The slump requirements shall not apply.
- (b) The concrete mixture should be uniformly graded, and information in the "Portland Cement Concrete Level III Technician Course – Manual of Instructions for Design of Concrete Mixtures" may be used to develop the uniformly graded mix design. The coarse aggregate gradations shall be CA 11, CA 13, CA 14, CA 16, or a blend of these gradations. However, the final gradation when using a single coarse aggregate or combination of coarse aggregates shall have 100 percent pass the 1 in. (25 mm) sieve, and minimum 95 percent pass the 3/4 in. (19 mm) sieve. The fine aggregate proportion shall be a maximum 50 percent by weight (mass) of the total aggregate used.
- (c) The slump flow range shall be 22 in. (560 mm) minimum to 28 in. (710 mm) maximum and tested according to Illinois Test Procedure SCC-2.
- (d) The visual stability index shall be a maximum of 1 and tested according to Illinois Test Procedure SCC-2.
- (e) The J-Ring value shall be a maximum of 2 in. (50 mm) and tested according to Illinois Test Procedure SCC-3. The L-Box blocking ratio shall be a minimum of 80 percent and tested according to Illinois Test Procedure SCC-3. The Contractor has the option to select either test.
- (f) The hardened visual stability index shall be a maximum of 1 and tested according to Illinois Test Procedure SCC-6.
- (g) If Class PC concrete requirements do not apply to the precast concrete product according to Section 1042, the maximum cement factor shall be 7.05 cwt/cu yd (418 kg/cu m) and the maximum allowable water/cement ratio shall be 0.44.
- (h) If the measured slump flow, visual stability index, J-Ring value, or L-Box blocking ratio fall outside the limits specified, a check test will be made. In the event of a second failure, the Engineer may refuse to permit the use of the batch of concrete represented.

The Contractor may use water or self-consolidating admixtures at the jobsite to obtain the specified slump flow, visual stability index, J-ring value, or L-box blocking ratio. The maximum design water/cement ratio shall not be exceeded.

1020.05 Other Concrete Criteria. The concrete shall be according to the following.

- (a) Proportioning and Mix Design. For all Classes of concrete, it shall be the Contractor's responsibility to determine mix design material proportions and to proportion each batch of concrete. A Level III PCC Technician shall develop the mix design for all Classes of concrete, except Classes PC and PS. The mix design, submittal information, trial batch, and Engineer verification shall be according to the "Portland Cement Concrete Level III Technician" course material.

The Contractor shall provide the mix designs a minimum of 45 calendar days prior to production. More than one mix design may be submitted for each class of concrete.

The Engineer will verify the mix design submitted by the Contractor. Verification of a mix design shall in no manner be construed as acceptance of any mixture produced. Once a mix design has been verified, the Engineer shall be notified of any proposed changes.

Tests performed at the jobsite will determine if a mix design can meet specifications. If the tests indicate it cannot, the Contractor shall make adjustments to a mix design, or submit a new mix design if necessary, to comply with the specifications.

- (b) Admixtures. The Contractor shall be responsible for using admixtures and determining dosages for all Classes of concrete, cement aggregate mixture II, and controlled low-strength material that will produce a mixture with suitable workability, consistency, and plasticity. In addition, admixture dosages shall result in the mixture meeting the specified plastic and hardened properties. The Contractor shall obtain approval from the Engineer to use an accelerator when the concrete temperature is greater than 60 °F (16 °C). However, this accelerator approval by the Engineer will not be required for Class PP, RR, PC, and PS concrete. The accelerator shall be the non-chloride type unless otherwise specified in the contract plans.

The Department will maintain an Approved List of Corrosion Inhibitors. Corrosion inhibitor dosage rates shall be according to Article 1020.05(b)(10). For information on approved controlled low-strength material air-entraining admixtures, refer to Article 1019.02. The Department will also maintain an Approved List of Concrete Admixtures, and an admixture technical representative shall be consulted by the Contractor prior to the pour when determining an admixture dosage from this list or when making minor admixture dosage adjustments at the jobsite. The dosage shall be within the range indicated on the approved list unless the influence by other admixtures, jobsite conditions (such as a very short haul time), or other circumstances warrant a dosage outside the range. The Engineer shall be notified when a dosage is proposed outside the range. To determine an admixture dosage, air temperature, concrete temperature, cement source and quantity, finely divided mineral sources and quantity, influence of other admixtures, haul time, placement conditions, and other factors as appropriate shall be considered. The Engineer may request the Contractor to have a batch of concrete mixed in the lab or field to verify the admixture dosage is correct. An admixture dosage or combination of admixture dosages shall not delay the initial set of concrete by more than one hour. When a retarding admixture is required or appropriate for a bridge deck or bridge deck overlay pour, the initial set time shall be delayed until the deflections due

to the concrete dead load are no longer a concern for inducing cracks in the completed work. However, a retarding admixture shall not be used to further extend the pour time and justify the alteration of a bridge deck pour sequence.

When determining water in admixtures for water/cement ratio, the Contractor shall calculate 70 percent of the admixture dosage as water, except a value of 50 percent shall be used for a latex admixture used in bridge deck latex concrete overlays.

The sequence, method, and equipment for adding the admixtures shall be approved by the Engineer. Admixtures shall be added to the concrete separately. An accelerator shall always be added prior to a high range water-reducing admixture, if both are used.

Admixture use shall be according to the following.

- (1) When the atmosphere or concrete temperature is 65 °F (18 °C) or higher, a retarding admixture shall be used in the Class BS concrete and concrete bridge deck overlays. The proportions of the ingredients of the concrete shall be the same as without the retarding admixture, except that the amount of mixing water shall be reduced, as may be necessary, in order to maintain the consistency of the concrete as required. In addition, a high range water-reducing admixture shall be used in bridge deck concrete. At the option of the Contractor, a water-reducing admixture may be used with the high range water-reducing admixture in Class BS concrete.
- (2) At the Contractor's option, admixtures in addition to an air-entraining admixture may be used for Class PP-1 or RR concrete. When the air temperature is less than 55 °F (13 °C) and an accelerator is used, the non-chloride accelerator shall be calcium nitrite.
- (3) When Class C fly ash or ground granulated blast-furnace slag is used in Class PP-1 or RR concrete, a water-reducing or high range water-reducing admixture shall be used.
- (4) For Class PP-2 or PP-3 concrete, a non-chloride accelerator followed by a high range water-reducing admixture shall be used, in addition to the air-entraining admixture. The Contractor has the option to use a water-reducing admixture with the high range water-reducing admixture. For Class PP-3 concrete, the non-chloride accelerator shall be calcium nitrite. For Class PP-2 concrete, the non-chloride accelerator shall be calcium nitrite when the air temperature is less than 55 °F (13 °C).
- (5) For Class PP-4 concrete, a high range water-reducing admixture shall be used in addition to the air-entraining admixture. The Contractor has the option to use a water-reducing admixture with the high range water-reducing admixture. An accelerator shall not be used. For stationary or truck-mixed concrete, a retarding admixture shall be used to allow for haul time. The Contractor has the option to use

a mobile portland cement concrete plant, but a retarding admixture shall not be used unless approved by the Engineer.

For PP-5 concrete, a non-chloride accelerator, high range water-reducing admixture, and air-entraining admixture shall be used. The accelerator, high range water-reducing admixture, and air-entraining admixture shall be per the Contractor's recommendation and dosage. The approved list of concrete admixtures shall not apply. A mobile portland cement concrete plant shall be used to produce the patching mixture.

- (6) When a calcium chloride accelerator is specified in the contract, the maximum chloride dosage shall be 1.0 quart (1.0 L) of solution per 100 lb (45 kg) of cement. The dosage may be increased to a maximum 2.0 quarts (2.0 L) per 100 lb (45 kg) of cement if approved by the Engineer. When a calcium chloride accelerator for Class PP-2 concrete is specified in the contract, the maximum chloride dosage shall be 1.3 quarts (1.3 L) of solution per 100 lb (45 kg) of cement. The dosage may be increased to a maximum 2.6 quarts (2.6 L) per 100 lb (45 kg) of cement if approved by the Engineer.
- (7) For Class DS concrete a retarding admixture and a high range water-reducing admixture shall be used. For dry excavations that are 10 ft (3 m) or less, the high range water-reducing admixture may be replaced with a water-reducing admixture if the concrete is vibrated. The use of admixtures shall take into consideration the slump loss limits specified in Article 516.12 and the fluidity requirement in Article 1020.04 (Note 12).
- (8) At the Contractor's option, when a water-reducing admixture or a high range water-reducing admixture is used for Class PV, PP-1, RR, SC, and SI concrete, the cement factor may be reduced a maximum 0.30 hundredweight/cu yd (18 kg/cu m). However, a cement factor reduction will not be allowed for concrete placed underwater.
- (9) When Type F or Type G high range water-reducing admixtures are used, the initial slump shall be a minimum of 1 1/2 in. (40 mm) prior to addition of the Type F or Type G admixture, except as approved by the Engineer.
- (10) When specified, a corrosion inhibitor shall be added to the concrete mixture utilized in the manufacture of precast, prestressed concrete members and/or other applications. It shall be added, at the same rate, to all grout around post-tensioning steel when specified.

When calcium nitrite is used, it shall be added at the rate of 4 gal/cu yd (20 L/cu m), and shall be added to the mix immediately after all compatible admixtures have been introduced to the batch.

When Rheocrete 222+ is used, it shall be added at the rate of 1.0 gal/cu yd (5.0 L/cu m), and the batching sequence shall be according to the manufacturer's instructions.

(c) Finely Divided Minerals. Use of finely divided minerals shall be according to the following.

(1) Fly Ash. At the Contractor's option, fly ash from approved sources may partially replace portland cement in cement aggregate mixture II, Class PV, PP-1, PP-2, RR, BS, PC, PS, DS, SC, and SI concrete.

The use of fly ash shall be according to the following.

- a. Measurements of fly ash and portland cement shall be rounded up to the nearest 5 lb (2.5 kg).
- b. When Class F fly ash is used in cement aggregate mixture II, Class PV, BS, PC, PS, DS, SC, and SI concrete, the amount of portland cement replaced shall not exceed 25 percent by weight (mass).
- c. When Class C fly ash is used in cement aggregate mixture II, Class PV, PP-1, PP-2, RR, BS, PC, PS, DS, SC, and SI concrete, the amount of portland cement replaced shall not exceed 30 percent by weight (mass).
- d. Fly ash may be used in concrete mixtures when the air temperature is below 40 °F (4 °C), but the Engineer may request a trial batch of the concrete mixture to show the mix design strength requirement will be met.

(2) Ground Granulated Blast-Furnace (GGBF) Slag. At the Contractor's option, GGBF slag may partially replace portland cement in Class PV, PP-1, PP-2, RR, BS, PC, PS, DS, SC, and SI concrete. For Class PP-3 concrete, GGBF slag shall be used according to Article 1020.04.

The use of GGBF slag shall be according to the following.

- a. Measurements of GGBF slag and portland cement shall be rounded up to the nearest 5 lb (2.5 kg).
- b. When GGBF slag is used in Class PV, PP-1, PP-2, RR, BS, PC, PS, DS, SC and SI concrete, the amount of portland cement replaced shall not exceed 35 percent by weight (mass).
- c. GGBF slag may be used in concrete mixtures when the air temperature is below 40 °F (4 °C), but the Engineer may request a trial batch of the concrete mixture to show the mix design strength requirement will be met.

- (3) Microsilica. At the Contractor's option, microsilica may be added at a maximum of 5.0 percent by weight (mass) of the cement and finely divided minerals summed together.

Microsilica shall be used in Class PP-3 concrete according to Article 1020.04.

- (4) High Reactivity Metakaolin (HRM). At the Contractor's option, HRM may be added at a maximum of 5.0 percent by weight (mass) of the cement and finely divided minerals summed together.
- (5) Mixtures with Multiple Finely Divided Minerals. Except as specified for Class PP-3 concrete, the Contractor has the option to use more than one finely divided mineral in Class PV, PP-1, PP-2, RR, BS, PC, PS, DS, SC, and SI concrete as follows.
- a. The mixture shall contain a maximum of two finely divided minerals. The finely divided mineral in portland-pozzolan cement or portland blast-furnace slag cement shall count toward the total number of finely divided minerals allowed. The finely divided minerals shall constitute a maximum of 35.0 percent of the total cement plus finely divided minerals. The fly ash portion shall not exceed 30.0 percent for Class C fly ash or 25.0 percent for Class F fly ash. The Class C and F fly ash combination shall not exceed 30.0 percent. The ground granulated blast-furnace slag portion shall not exceed 35.0 percent. The microsilica or high-reactivity metakaolin portion used together or separately shall not exceed ten percent. The finely divided mineral in the portland-pozzolan cement or portland blast-furnace slag blended cement shall apply to the maximum 35.0 percent.
 - b. Central Mixed. For Class PV, SC, and SI concrete, the mixture shall contain a minimum of 565 lbs/cu yd (335 kg/cu m) of cement and finely divided minerals summed together. If a water-reducing or high-range water-reducing admixture is used, the Contractor has the option to use a minimum of 535 lbs/cu yd (320 kg/cu m).
 - c. Truck-Mixed or Shrink-Mixed. For Class PV, SC, and SI concrete, the mixture shall contain a minimum of 605 lbs/cu yd (360 kg/cu m) of cement and finely divided minerals summed together. If a water-reducing or high-range water-reducing admixture is used, the Contractor has the option to use a minimum of 575 lbs/cu yd (345 kg/cu m).
 - d. Central-Mixed, Truck-Mixed or Shrink-Mixed. For Class PP-1 and RR concrete, the mixture shall contain a minimum of 650 lbs/cu yd (385 kg/cu m) of cement and finely divided minerals summed together. For Class PP-1 and RR concrete using Type III portland cement, the mixture shall contain a minimum of 620 lbs/cu yd (365 kg/cu m).

For Class PP-2 concrete, the mixture shall contain a minimum of 735 lbs/cu yd (435 kg/cu m) of cement and finely divided minerals summed together. For Class BS concrete, the mixture shall contain a minimum of 605 lbs/cu yd (360 kg/cu m). For Class DS concrete, the mixture shall contain a minimum of 665 lbs/cu yd (395 kg/cu m).

If a water-reducing or high range water-reducing admixture is used in Class PP-1 and RR concrete, the Contractor has the option to use a minimum of 620 lbs/cu yd (365 kg/cu m) of cement and finely divided minerals summed together. If a water-reducing or high-range water-reducing admixture is used with Type III portland cement in Class PP-1 and RR concrete, the Contractor has the option to use a minimum of 590 lbs/cu yd (350 kg/cu m).

- e. Central-Mixed or Truck-Mixed. For Class PC and PS concrete, the mixture shall contain a minimum of 565 lbs/cu yd (335 kg/cu m) of cement and finely divided minerals summed together.
 - f. The mixture shall contain a maximum of 705 lbs/cu yd (418 kg/cu m) of cement and finely divided mineral(s) summed together for Class PV, BS, PC, PS, DS, SC, and SI concrete. For Class PP-1 and RR concrete, the mixture shall contain a maximum of 750 lbs/cu yd (445 kg/cu m). For Class PP-1 and RR concrete using Type III portland cement, the mixture shall contain a maximum of 720 lbs/cu yd (425 kg/cu m). For Class PP-2 concrete, the mixture shall contain a maximum of 820 lbs/cu yd (485 kg/cu m).
 - g. For Class SC concrete and for any other class of concrete that is to be placed underwater, except Class DS concrete, the allowable cement and finely divided minerals summed together shall be increased by ten percent.
 - h. The combination of cement and finely divided minerals shall comply with Article 1020.05(d).
- (d) Alkali-Silica Reaction. For cast-in-place (includes cement aggregate mixture II and latex mixtures), precast, and precast prestressed concrete, one of the mixture options provided in Article 1020.05(d)(2) shall be used to reduce the risk of a deleterious alkali-silica reaction in concrete exposed to humid or wet conditions. The mixture options are not intended or adequate for concrete exposed to potassium acetate, potassium formate, sodium acetate, or sodium formate. The mixture options will not be required for the dry environment (humidity less than 60 percent) found inside buildings for residential or commercial occupancy.

The mixture options shall not apply to concrete revetment mats, insertion lining of pipe culverts, portland cement mortar fairing course, controlled low-strength material, miscellaneous grouts that are not prepackaged, Class PP-3 concrete, Class PP-4 concrete, and Class PP-5 concrete.

- (1) Aggregate Groups. Each combination of aggregates used in a mixture will be assigned to an aggregate group. The point at which the coarse aggregate and fine aggregate expansion values intersect in the following table will determine the group.

Aggregate Groups			
Coarse Aggregate or Coarse Aggregate Blend ASTM C 1260 Expansion	Fine Aggregate Or Fine Aggregate Blend ASTM C 1260 Expansion		
	≤0.16%	>0.16% - 0.27%	>0.27%
≤0.16%	Group I	Group II	Group III
>0.16% - 0.27%	Group II	Group II	Group III
>0.27%	Group III	Group III	Group IV

- (2) Mixture Options. Based upon the aggregate group, the following mixture options shall be used. However, the Department may prohibit a mixture option if field performance shows a deleterious alkali-silica reaction or Department testing indicates the mixture may experience a deleterious alkali-silica reaction.

Reduction of Risk for Deleterious Alkali-Silica Reaction					
Aggregate Groups	Mixture Options				
	Option 1	Option 2	Option 3	Option 4	Option 5
Group I	Mixture options are not applicable. Use any cement or finely divided mineral.				
Group II	X	X	X	X	X
Group III	X	Combine Option 2 with Option 3	Combine Option 2 with Option 3	X	X
Group IV	X	Combine Option 2 with Option 4	Invalid Option	Combine Option 2 with Option 4	X

"X" denotes valid mixture option for aggregate group.

- a. Mixture Option 1. The coarse or fine aggregates shall be blended to place the material in a group that will allow the selected cement or finely divided mineral to be used. Coarse aggregate may only be blended with another coarse aggregate. Fine aggregate may only be blended with another fine aggregate. Blending of

coarse with fine aggregate to place the material in another group will not be permitted.

When a coarse or fine aggregate is blended, the weighted expansion value shall be calculated separately for the coarse and fine aggregate as follows:

$$\text{Weighted Expansion Value} = (a/100 \times A) + (b/100 \times B) + (c/100 \times C) + \dots$$

Where: a, b, c... = percentage of aggregate in the blend;
A, B, C... = expansion value for that aggregate.

b. Mixture Option 2. A finely divided mineral shall be used as described in 1), 2), 3), or 4) that follow. In addition, a blended cement with a finely divided mineral may be added to a separate finely divided mineral to meet the following requirements, provided the finely divided minerals are the same material. However, adding together two different finely divided minerals to obtain the specified minimum percentage of one material will not be permitted for 1), 2), 3), and 4). Refer to Mixture Option 5 to address this situation.

1. Class F Fly Ash. For cement aggregate mixture II, Class PV, BS, PC, PS, MS, DS, SC and SI concrete, the Class F fly ash shall be a minimum 25.0 percent by weight (mass) of the cement and finely divided minerals summed together.

If the maximum total equivalent available alkali content ($\text{Na}_2\text{O} + 0.658\text{K}_2\text{O}$) exceeds 4.50 percent for the Class F fly ash, it may be used only if it complies with Mixture Option 5.

2. Class C Fly Ash. For cement aggregate mixture II, Class PV, PP-1, PP-2, RR, BS, PC, PS, DS, SC, and SI concrete, Class C fly ash shall be a minimum of 25.0 percent by weight (mass) of the cement and finely divided minerals summed together.

If the maximum total equivalent available alkali content ($\text{Na}_2\text{O} + 0.658\text{K}_2\text{O}$) exceeds 4.50 percent or the calcium oxide exceeds 26.50 percent for the Class C fly ash, it may be used only per Mixture Option 5.

3. Ground Granulated Blast-Furnace Slag. For Class PV, PP-1, PP-2, RR, BS, PC, PS, DS, SC, and SI concrete, ground granulated blast-furnace slag shall be a minimum of 25.0 percent by weight (mass) of the cement and finely divided minerals summed together.

If the maximum total equivalent available alkali content ($\text{Na}_2\text{O} + 0.658\text{K}_2\text{O}$) exceeds 1.00 percent for the ground granulated blast-furnace slag, it may be used only per Mixture Option 5.

4. Microsilica or High Reactivity Metakaolin, Microsilica solids or high reactivity metakaolin shall be a minimum 5.0 percent by weight (mass) of the cement and finely divided minerals summed together.

If the maximum total equivalent available alkali content ($\text{Na}_2\text{O} + 0.658\text{K}_2\text{O}$) exceeds 1.00 percent for the Microsilica or High Reactivity Metakaolin, it may be used only if it complies with Mixture Option 5.

- c. Mixture Option 3. The cement used shall have a maximum total equivalent alkali content ($\text{Na}_2\text{O} + 0.658\text{K}_2\text{O}$) of 0.60 percent. When aggregate in Group II is involved and the Contractor desires to use a finely divided mineral, any finely divided mineral may be used with the cement unless the maximum total equivalent available alkali content ($\text{Na}_2\text{O} + 0.658\text{K}_2\text{O}$) exceeds 4.50 percent for the fly ash; or 1.00 percent for the ground granulated blast-furnace slag, microsilica or high reactivity metakaolin. If the alkali content is exceeded, the finely divided mineral may be used only per Mixture Option 5.
- d. Mixture Option 4. The cement used shall have a maximum total equivalent alkali content ($\text{Na}_2\text{O} + 0.658\text{K}_2\text{O}$) of 0.45 percent. When aggregate in Group II or III is involved and the Contractor desires to use a finely divided mineral, any finely divided mineral may be used with the cement unless the maximum total equivalent available alkali content ($\text{Na}_2\text{O} + 0.658\text{K}_2\text{O}$) exceeds 4.50 percent for the fly ash; or 1.00 percent for the ground granulated blast-furnace slag, microsilica, or high reactivity metakaolin. If the alkali content is exceeded, the finely divided mineral may be used only per Mixture Option 5.
- e. Mixture Option 5. The proposed cement or finely divided mineral may be used if the ASTM C 1567 expansion value is ≤ 0.16 percent when performed on the aggregate in the concrete mixture with the highest ASTM C 1260 test result. The laboratory performing the ASTM C 1567 test shall be approved by the Department according to the current Bureau of Materials and Physical Research Policy Memorandum "Minimum Laboratory Requirements for Alkali-Silica Reactivity (ASR) Testing". The ASTM C 1567 test will be valid for two years, unless the Engineer determines the materials have changed significantly.

For latex concrete, the ASTM C 1567 test shall be performed without the latex.

The 0.20 percent autoclave expansion limit in ASTM C 1567 shall not apply.

If during the two year time period the Contractor needs to replace the cement, and the replacement cement has an equal or lower total equivalent alkali content ($\text{Na}_2\text{O} + 0.658\text{K}_2\text{O}$), a new ASTM C 1567 test will not be required.

The Engineer reserved the right to verify a Contractor's ASTM C 1567 test result. When the Contractor performs the test, a split sample may be requested by the Engineer. The Engineer may also independently obtain a sample at any time.

The proposed cement or finely divided mineral will not be allowed for use if the Contractor or Engineer obtains an expansion value greater than 0.16 percent.

1020.06 Water/Cement Ratio. The water/cement ratio shall be determined on a weight (mass) basis. When a maximum water/cement ratio is specified, the water shall include mixing water, water in admixtures, free moisture on the aggregates, and water added at the jobsite. The quantity of water may be adjusted within the limit specified to meet slump requirements.

When fly ash, ground granulated blast-furnace slag, high-reactivity metakaolin, or microsilica (silica fume) are used in a concrete mix, the water/cement ratio will be based on the total cement and finely divided minerals contained in the mixture.

1020.07 Slump. The slump shall be determined according to Illinois Modified AASHTO T 119.

If the measured slump falls outside the limits specified, a check test will be made. In the event of a second failure, the Engineer may refuse to permit the use of the batch of concrete represented.

If the Contractor is unable to add water to prepare concrete of the specified slump without exceeding the maximum design water/cement ratio, a water-reducing admixture shall be added.

1020.08 Air Content. The air content shall be determined according to Illinois Modified AASHTO T 152 or Illinois Modified AASHTO T 196. The air-entrainment shall be obtained by the use of cement with an approved air-entraining admixture added during the mixing of the concrete or the use of air-entraining cement.

If the air-entraining cement furnished is found to produce concrete having air content outside the limits specified, its use shall be discontinued immediately and the Contractor shall provide other air-entraining cement which will produce air contents within the specified limits.

If the air content obtained is above the specified maximum limit at the jobsite, the Contractor may have the concrete further mixed, within the limits of time and revolutions specified, to reduce the air content. If the air content obtained is below the specified minimum limit, the Contractor may add to the concrete a sufficient quantity of an approved air-entraining admixture at the jobsite to bring the air content within the specified limits.

1020.09 Strength Tests. The specimens shall be molded and cured according to Illinois Modified AASHTO T 23. Specimens shall be field cured with the construction item as specified in Illinois Modified AASHTO T 23. The compressive strength shall be determined according to Illinois Modified AASHTO T 22. The flexural strength shall be determined according to Illinois Modified AASHTO T 177.

Except for Class PC and PS concrete, the Contractor shall transport the strength specimens from the site of the work to the field laboratory or other location as instructed by the Engineer. During transportation in a suitable light truck, the specimens shall be embedded in straw,

burlap, or other acceptable material in a manner meeting with the approval of the Engineer to protect them from damage; care shall be taken to avoid impacts during hauling and handling. For strength specimens, the Contractor shall provide a field curing box for initial curing and a water storage tank for final curing. The field curing box will be required when an air temperature below 60 °F (16 °C) is expected during the initial curing period. The device shall maintain the initial curing temperature range specified in Illinois Modified AASHTO T 23, and may be insulated or power operated as appropriate.

1020.10 Handling, Measuring, and Batching Materials. Aggregates shall be handled in a manner to prevent mixing with soil and other foreign material.

Aggregates shall be handled in a manner which produces a uniform gradation, before placement in the plant bins. Aggregates delivered to the plant in a nonuniform gradation condition shall be stockpiled. The stockpiled aggregate shall be mixed uniformly before placement in the plant bins.

Aggregates shall have a uniform moisture content before placement in the plant bins. This may require aggregates to be stockpiled for 12 hours or more to allow drainage, or water added to the stockpile, or other methods approved by the Engineer. Moisture content requirements for crushed concrete, crushed slag or lightweight aggregate shall be according to Article 1004.01(e)(5).

Aggregates, cement, and finely divided minerals shall be measured by weight (mass). Water and admixtures shall be measured by volume or weight (mass).

The Engineer may permit aggregates, cement, and finely divided minerals to be measured by volume for small isolated structures and for miscellaneous items. Aggregates, cement, and finely divided minerals shall be measured individually. The volume shall be based upon dry, loose materials.

1020.11 Mixing Portland Cement Concrete. The mixing of concrete shall be according to the following.

- (a) Ready-Mixed Concrete. Ready-mixed concrete is central-mixed, truck-mixed, or shrink-mixed concrete transported and delivered in a plastic state ready for placement in the work and shall be according to the following.

(1) Central-Mixed Concrete. Central-mixed concrete is concrete which has been completely mixed in a stationary mixer and delivered in a truck agitator, a truck mixer operating at agitating speed, or a nonagitator truck.

The stationary mixer shall operate at the drum speed for which it was designed. The batch shall be charged into the drum so that some of the water shall enter in advance of the cement, finely divided minerals, and aggregates. The flow of the water shall be uniform and all water shall be in the drum by the end of the first 15 seconds of the mixing period. Water shall begin to enter the drum from zero to

two seconds in advance of solid material and shall stop flowing within two seconds of the beginning of mixing time.

Some coarse aggregate shall enter in advance of other solid materials. For the balance of the charging time for solid materials, the aggregates, finely divided minerals, and cement (to assure thorough blending) shall each flow at acceptably uniform rates, as determined by visual observation. Coarse aggregate shall enter two seconds in advance of other solid materials and a uniform rate of flow shall continue to within two seconds of the completion of charging time.

The entire contents of the drum, or of each single compartment of a multiple-drum mixer, shall be discharged before the succeeding batch is introduced.

The volume of concrete mixed per batch shall not exceed the mixer's rated capacity as shown on the standard rating plate on the mixer by more than ten percent.

The minimum mixing time shall be 75 seconds for a stationary mixer having a capacity greater than 2 cu yd (1.5 cu m). For a mixer with a capacity equal to or less than 2 cu yd (1.5 cu m) the mixing time shall be 60 seconds. Transfer time in multiple drum mixers is included in the mixing time. Mixing time shall begin when all materials are in the mixing compartment and shall end when the discharge of any part of the batch is started. The required mixing times will be established by the Engineer for all types of stationary mixers.

When central-mixed concrete is to be transported in a truck agitator or a truck mixer, the stationary-mixed batch shall be transferred to the agitating unit without delay and without loss of any portion of the batch. Agitating shall start immediately thereafter and shall continue without interruption until the batch is discharged from the agitator. The ingredients of the batch shall be completely discharged from the agitator before the succeeding batch is introduced. Drums and auxiliary parts of the equipment shall be kept free from accumulations of materials.

The vehicles used for transporting the mixed concrete shall be of such capacity, or the batches shall be so proportioned, that the entire contents of the mixer drum can be discharged into each vehicle load.

- (2) Truck-Mixed Concrete. Truck-mixed concrete is completely mixed and delivered in a truck mixer. When the mixer is charged with fine and coarse aggregates simultaneously, not less than 60 nor more than 100 revolutions of the drum or blades at mixing speed shall be required, after all of the ingredients including water are in the drum. When fine and coarse aggregates are charged separately, not less than 70 revolutions will be required. For self-consolidating concrete, a minimum of 100 revolutions is required in all cases. Additional mixing beyond 100 revolutions shall be at agitating speed unless additions of water, admixtures, or other materials are made at the jobsite. The mixing operation shall begin immediately after the cement and water, or the cement and wet aggregates, come in contact. The

ingredients of the batch shall be completely discharged from the drum before the succeeding batch is introduced. The drum and auxiliary parts of the equipment shall be kept free from accumulations of materials. If additional water or an admixture is added at the jobsite, the concrete batch shall be mixed a minimum of 40 additional revolutions after each addition.

- (3) Shrink-Mixed Concrete. Shrink-mixed concrete is mixed partially in a stationary mixer and completed in a truck mixer for delivery. The mixing time of the stationary mixer may be reduced to a minimum of 30 seconds to intermingle the ingredients, before transferring to the truck mixer. All ingredients for the batch shall be in the stationary mixer and partially mixed before any of the mixture is discharged into the truck mixer. The partially mixed batch shall be transferred to the truck mixer without delay and without loss of any portion of the batch, and mixing in the truck mixer shall start immediately. The mixing time in the truck mixer shall be not less than 50 nor more than 100 revolutions of the drum or blades at mixing speed. For self-consolidating concrete, a minimum of 100 revolutions is required in the truck mixer. Additional mixing beyond 100 revolutions shall be at agitating speed, unless additions of water, admixtures, or other materials are made at the jobsite. Units designed as agitators shall not be used for shrink mixing. The ingredients of the batch shall be completely discharged from the drum before the succeeding batch is introduced. The drum and auxiliary parts of the equipment shall be kept free from accumulations of materials. If additional water or an admixture is added at the jobsite, the concrete batch shall be mixed a minimum of 40 additional revolutions after each addition.
- (4) Mixing Water. Wash water shall be completely discharged from the drum or container before a batch is introduced. All mixing water shall be added at the plant and any adjustment of water at the jobsite by the Contractor shall not exceed the specified maximum water/cement ratio or slump. If strength specimens have been made for a batch of concrete, and subsequently during discharge there is more water added, additional strength specimens shall be made for the batch of concrete. No additional water may be added at the jobsite to central-mixed concrete if the mix design has less than 565 lbs/cu yd (335 kg/cu m) of cement and finely divided minerals summed together.
- (5) Mixing and Agitating Speeds. The mixing or agitating speeds used for truck mixers or truck agitators shall be per the manufacturer's rating plate.
- (6) Capacities. The volume of plastic concrete in a given batch will be determined according to AASHTO T 121, based on the total weight (mass) of the batch, determined either from the weight (masses) of all materials, including water, entering the batch or directly from the net weight (mass) of the concrete in the batch as delivered.

The volume of mixed concrete in truck mixers or truck agitators shall in no case be greater than the rated capacity determined according to the Truck Mixer, Agitator,

and Front Discharge Concrete Carrier Standards of the Truck Mixer Manufacturer's Bureau, as shown by the rating plate attached to the truck. If the truck mixer does not have a rating plate, the volume of mixed concrete shall not exceed 63 percent of the gross volume of the drum or container, disregarding the blades. For truck agitators, the value is 80 percent.

- (7) Time of Haul. Haul time shall begin when the delivery ticket is stamped. The delivery ticket shall be stamped no later than five minutes after the addition of the mixing water to the cement, or after the addition of the cement to the aggregate when the combined aggregates contain free moisture in excess of two percent by weight (mass). If more than one batch is required for charging a truck using a stationary mixer, the time of haul shall start with mixing of the first batch. Haul time shall end when the truck is emptied for incorporation of the concrete into the work.

The time elapsing from when water is added to the mix until it is deposited in place at the site of the work shall not exceed 30 minutes when the concrete is transported in nonagitating trucks.

The maximum haul time for concrete transported in truck mixers or truck agitators shall be according to the following.

Concrete Temperature at Point of Discharge °F (°C)	Haul Time	
	Hours	Minutes
50-64 (10-17.5)	1	30
>64 (>17.5) - without retarder	1	0
>64 (>17.5) - with retarder	1	30

To encourage start-up testing for mix adjustments at the plant, the first two trucks will be allowed an additional 15 minutes haul time whenever such testing is performed.

For a mixture which is not mixed on the jobsite, a delivery ticket shall be required for each load. The following information shall be recorded on each delivery ticket: (1) ticket number; (2) name of producer and plant location; (3) contract number; (4) name of Contractor; (5) stamped date and time batched; (6) truck number; (7) quantity batched; (8) amount of admixture(s) in the batch; (9) amount of water in the batch; and (10) Department mix design number.

For concrete mixed in jobsite stationary mixers, the above delivery ticket may be waived, but a method of verifying the haul time shall be established to the satisfaction of the Engineer.

- (8) Production and Delivery. The production of ready-mixed concrete shall be such that the operations of placing and finishing will be continuous insofar as the job operations require. The Contractor shall be responsible for producing concrete that will have the required workability, consistency, and plasticity when delivered to the work. Concrete which is unsuitable for placement as delivered will be rejected. The

Contractor shall minimize the need to adjust the mixture at the jobsite, such as adding water and admixtures prior to discharging.

- (9) Use of Multiple Plants in the Same Construction Item. The Contractor may simultaneously use central-mixed, truck-mixed, and shrink-mixed concrete from more than one plant, for the same construction item, on the same day, and in the same pour. However, the following criteria shall be met.
- a. Each plant shall use the same cement, finely divided minerals, aggregates, admixtures, and fibers.
 - b. Each plant shall use the same mix design. However, material proportions may be altered slightly in the field to meet slump and air content criteria. Field water adjustments shall not result in a difference that exceeds 0.02 between plants for water/cement ratio. The required cement factor for central-mixed concrete shall be increased to match truck-mixed or shrink-mixed concrete, if the latter two types of mixed concrete are used in the same pour.
 - c. The maximum slump difference between deliveries of concrete shall be 3/4 in. (19 mm) when tested at the jobsite. If the difference is exceeded, but test results are within specification limits, the concrete may be used. The Contractor shall take immediate corrective action and shall test subsequent deliveries of concrete until the slump difference is corrected. For each day, the first three truck loads of delivered concrete from each plant shall be tested for slump by the Contractor. Thereafter, when a specified test frequency for slump is to be performed, it shall be conducted for each plant at the same time.
 - d. The maximum air content difference between deliveries of concrete shall be 1.5 percent when tested at the jobsite. If the difference is exceeded, but test results are within specification limits, the concrete may be used. The Contractor shall take immediate corrective action and shall test subsequent deliveries of concrete until the air content difference is corrected. For each day, the first three truck loads of delivered concrete from each plant shall be tested for air content by the Contractor. Thereafter, when a specified test frequency for air content is to be performed, it shall be conducted for each plant at the same time.
 - e. Strength tests shall be performed and taken at the jobsite for each plant. When a specified strength test is to be performed, it shall be conducted for each plant at the same time. The difference between plants for strength shall not exceed 900 psi (6200 kPa) compressive and 90 psi (620 kPa) flexural. If the strength difference requirements are exceeded, the Contractor shall take corrective action.
 - f. The maximum haul time difference between deliveries of concrete shall be 15 minutes. If the difference is exceeded, but haul time is within specification

limits, the concrete may be used. The Contractor shall take immediate corrective action and check subsequent deliveries of concrete.

- (b) Class PC Concrete. The concrete shall be central-mixed or truck-mixed. Variations in plastic concrete properties shall be minimized between batches.
- (c) Class PV Concrete. The concrete shall be central-mixed, truck-mixed, or shrink-mixed.

The required mixing time for stationary mixers with a capacity greater than 2 cu yd (1.5 cu m) may be less than 75 seconds upon satisfactory completion of a mixer performance test. Mixer performance tests may be requested by the Contractor when the quantity of concrete to be placed exceeds 50,000 sq yd (42,000 sq m). The testing shall be conducted according to the current Bureau of Materials and Physical Research's Policy Memorandum, "Field Test Procedures for Mixer Performance and Concrete Uniformity Tests".

The Contractor will be allowed to test two mixing times within a range of 50 to 75 seconds. If satisfactory results are not obtained from the required tests, the mixing time shall continue to be 75 seconds for the remainder of the contract. If satisfactory results are obtained, the mixing time may be reduced. In no event will mixing time be less than 50 seconds.

The Contractor shall furnish the labor, equipment, and material required to perform the testing according to the current Bureau of Materials and Physical Research's Policy Memorandum, "Field Test Procedures for Mixer Performance and Concrete Uniformity Tests".

A contract which has 12 ft (3.6 m) wide pavement or base course, and a continuous length of 1/2 mile (0.8 km) or more, shall have the following additional requirements.

- (1) The plant and truck delivery operation shall be able to provide a minimum of 50 cu yd (38 cu m) of concrete per hour.
- (2) The plant shall have automatic or semi-automatic batching equipment.

- (d) All Other Classes of Concrete. The concrete shall be central-mixed, truck-mixed, or shrink-mixed concrete.

1020.12 Mobile Portland Cement Concrete Plants. The use of a mobile portland cement concrete plant may be approved under the provisions of Article 1020.10 for volumetric proportioning in small isolated structures, thin overlays, and for miscellaneous and incidental concrete items.

The first 1 cu ft (0.03 cu m) of concrete produced may not contain sufficient mortar and shall not be incorporated in the work. The side plate on the cement feeder shall be removed

periodically (normally the first time the mixer is used each day) to see if cement is building up on the feed drum.

Sufficient mixing capacity of mixers shall be provided to enable continuous placing and finishing insofar as the job operations and the specifications require.

Slump and air tests made immediately after discharge of the mix may be misleading, since the aggregates may absorb a significant amount of water for four or five minutes after mixing.

1020.13 Curing and Protection. The method of curing, curing period, and method of protection for each type of concrete construction is included in the following Index Table.

INDEX TABLE OF CURING AND PROTECTION OF CONCRETE CONSTRUCTION			
TYPE OF CONSTRUCTION	CURING METHODS	CURING PERIOD DAYS	LOW AIR TEMPERATURE PROTECTION METHODS
Cast-in-Place Concrete ^{11/}			
Pavement			
Shoulder	1020.13(a)(1)(2)(3)(4)(5) ^{3/5/}	3	1020.13(c)
Base Course			
Base Course Widening	1020.13(a)(1)(2)(3)(4)(5) ^{2/}	3	1020.13(c)
Driveway			
Median			
Barrier			
Curb			
Gutter	1020.13(a)(1)(2)(3)(4)(5) ^{4/5/}	3	1020.13(c) ^{16/}
Curb & Gutter			
Sidewalk			
Slope Wall			
Paved Ditch			
Catch Basin			
Manhole	1020.13(a)(1)(2)(3)(4)(5) ^{4/}	3	1020.13(c)
Inlet			
Valve Vault			
Pavement Patching	1020.13(a)(1)(2)(3)(4)(5) ^{2/}	3 ^{12/}	1020.13(c)
Bridge Deck Patching	1020.13(a)(3)(5)	3 or 7 ^{12/}	1020.13(c)
Railroad Crossing	1020.13(a)(3)(5)	1	1020.13(c)
Piles and Drilled Shafts	1020.13(a)(3)(5)	7	1020.13(d)(1)(2)(3)
Foundations & Footings			
Seal Coat	1020.13(a)(1)(2)(3)(4)(5) ^{4/6/}	7	1020.13(d)(1)(2)(3)
Substructure	1020.13(a)(1)(2)(3)(4)(5) ^{11/7/}	7	1020.13(d)(1)(2)(3)
Superstructure (except deck)	1020.13(a)(1)(2)(3)(5) ^{8/}	7	1020.13(d)(1)(2)
Deck			
Bridge Approach Slab	1020.13(a)(5)	7	1020.13(d)(1)(2) ^{17/}
Retaining Walls	1020.13(a)(1)(2)(3)(4)(5) ^{11/7/}	7	1020.13(d)(1)(2)
Pump Houses	1020.13(a)(1)(2)(3)(4)(5) ^{11/}	7	1020.13(d)(1)(2)
Culverts	1020.13(a)(1)(2)(3)(4)(5) ^{4/6/}	7	1020.13(d)(1)(2) ^{18/}
Other Incidental Concrete	1020.13(a)(1)(2)(3)(5)	3	1020.13(c)
Precast Concrete ^{11/}			
Bridge Slabs			
Piles and Pile Caps	1020.13(a)(3)(5) ^{9/10/}	As ^{13/}	9/
Other Structural Members		Required	
All Other Precast Items	1020.13(a)(3)(4)(5) ^{2/9/10/}	As ^{14/}	9/
		Required	
Precast, Prestressed Concrete ^{11/}			
All Items	1020(a)(3)(5) ^{9/10/}	Until Strand Tensioning is Released ^{15/}	9/

Notes-General:

- 1/ Type I, membrane curing only
- 2/ Type II, membrane curing only
- 3/ Type III, membrane curing only

- 4/ Type I, II and III membrane curing
- 5/ Membrane Curing will not be permitted between November 1 and April 15.
- 6/ The use of water to inundate foundations and footings, seal coats or the bottom slab of culverts is permissible when approved by the Engineer, provided the water temperature can be maintained at 45 °F (7 °C) or higher.
- 7/ Asphalt emulsion for waterproofing may be used in lieu of other curing methods when specified and permitted according to Article 503.18. The top surfaces of abutments and piers shall be cured according to Article 1020.13(a)(3) or (5).
- 8/ On non-traffic surfaces which receive protective coat according to Article 503.19, a linseed oil emulsion curing compound may be used as a substitute for protective coat and other curing methods. The linseed oil emulsion curing compound will be permitted between April 16 and October 31 of the same year, provided it is applied with a mechanical sprayer according to Article 1101.09(b).
- 9/ Steam, supplemental heat, or insulated blankets (with or without steam/supplemental heat) are acceptable and shall be according to the Bureau of Materials and Physical Research's Policy Memorandum "Quality Control/Quality Assurance Program for Precast Concrete Products" and the "Manual for Fabrication of Precast, Prestressed Concrete Products".
- 10/ A moist room according to AASHTO M 201 is acceptable for curing.
- 11/ If curing is required and interrupted because of form removal for cast-in-place concrete items, precast concrete products, or precast prestressed concrete products, the curing shall be resumed within two hours from the start of the form removal.
- 12/ Curing maintained only until opening strength is attained for pavement patching, with a maximum curing period of three days. For bridge deck patching the curing period shall be three days if Class PP concrete is used and 7 days if Class BS concrete is used.
- 13/ The curing period shall end when the concrete has attained the mix design strength. The producer has the option to discontinue curing when the concrete has attained 80 percent of the mix design strength or after seven days. All strength test specimens shall remain with the units and shall be subjected to the same curing method and environmental condition as the units, until the time of testing.
- 14/ The producer shall determine the curing period or may elect to not cure the product. All strength test specimens shall remain with the units and shall be subjected to the same curing method and environmental condition as the units, until the time of testing.

15/ The producer has the option to continue curing after strand release.

16/ When structural steel or structural concrete is in place above slope wall, Article 1020.13(c) shall not apply. The protection method shall be according to Article 1020.13(d)(1).

17/ When Article 1020.13(d)(2) is used to protect the deck, the housing may enclose only the bottom and sides. The top surface shall be protected according to Article 1020.13(d)(1).

18/ For culverts having a waterway opening of 10 sq ft (1 sq m) or less, the culverts may be protected according to Article 1020.13(d)(3).

(a) Methods of Curing. Except as provided for in the Index Table of Curing and Protection of Concrete Construction, curing shall be accomplished by one of the following described methods. When water is required to wet the surface, it shall be applied as a fine spray so that it will not mar or pond on the surface. Except where otherwise specified, the curing period shall be at least 72 hours.

(1) Waterproof Paper Method. The surface of the concrete shall be covered with waterproof paper as soon as the concrete has hardened sufficiently to prevent marring the surface. The surface of the concrete shall be wetted immediately before the paper is placed. The blankets shall be lapped at least 12 in. (300 mm) end to end, and these laps shall be securely weighted with a windrow of earth, or other approved method, to form a closed joint. The same requirements shall apply to the longitudinal laps where separate strips are used for curing edges, except the lap shall be at least 9 in. (225 mm). The edges of the blanket shall be weighted securely with a continuous windrow of earth or any other means satisfactory to the Engineer to provide an air-tight cover. Any torn places or holes in the paper shall be repaired immediately by patches cemented over the openings, using a bituminous cement having a melting point of not less than 180 °F (82 °C). The blankets may be reused, provided they are air-tight and kept serviceable by proper repairs.

A longitudinal pleat shall be provided in the blanket to permit shrinkage where the width of the blanket is sufficient to cover the entire surface. The pleat will not be required where separate strips are used for the edges. Joints in the blanket shall be sewn or cemented together in such a manner that they will not separate during use.

(2) Polyethylene Sheeting Method. The surface of the concrete shall be covered with white polyethylene sheeting as soon as the concrete has hardened sufficiently to prevent marring the surface. The surface of the concrete shall be wetted immediately before the sheeting is placed. The edges of the sheeting shall be weighted securely with a continuous windrow of earth or any other means satisfactory to the Engineer to provide an air-tight cover. Adjoining sheets shall overlap not less than 12 in. (300 mm) and the laps shall be securely weighted with

earth, or any other means satisfactory to the Engineer, to provide an air tight cover. For surface and base course concrete, the polyethylene sheets shall be not less than 100 ft (30 m) in length nor longer than can be conveniently handled, and shall be of such width that, when in place, they will cover the full width of the surface, including the edges, except that separate strips may be used to cover the edges. Any tears or holes in the sheeting shall be repaired. When sheets are no longer serviceable as a single unit, the Contractor may select from such sheets and reuse those which will serve for further applications, provided two sheets are used as a single unit; however, the double sheet units will be rejected when the Engineer deems that they no longer provide an air tight cover.

- (3) Wetted Burlap Method. The surface of the concrete shall be covered with wetted burlap blankets as soon as the concrete has hardened sufficiently to prevent marring the surface. The blankets shall overlap 6 in. (150 mm). At least two layers of wetted burlap shall be placed on the finished surface. The burlap shall be kept saturated by means of a mechanically operated sprinkling system. In place of the sprinkling system, at the Contractor's option, two layers of burlap covered with impermeable covering shall be used. The burlap shall be kept saturated with water. Plastic coated burlap may be substituted for one layer of burlap and impermeable covering.

The blankets shall be placed so that they are in contact with the edges of the concrete, and that portion of the material in contact with the edges shall be kept saturated with water.

- (4) Membrane Curing Method. Membrane curing will not be permitted where a protective coat, concrete sealer, or waterproofing is to be applied, or at areas where rubbing or a normal finish is required, or at construction joints other than those necessary in pavement or base course. Concrete at these locations shall be cured by another method specified in Article 1020.13(a).

After all finishing work to the concrete surface has been completed, it shall be sealed with membrane curing compound of the type specified within ten minutes. The seal shall be maintained for the specified curing period. The edges of the concrete shall, likewise, be sealed within ten minutes after the forms are removed. Two separate applications, applied at least one minute apart, each at the rate of not less than 1 gal/250 sq ft (0.16 L/sq m) will be required upon the surfaces and edges of the concrete. These applications shall be made with the mechanical equipment specified. Type III compound shall be agitated immediately before and during the application.

At locations where the coating is discontinuous or where pin holes show or where the coating is damaged due to any cause and on areas adjacent to sawed joints, immediately after sawing is completed, an additional coating of membrane curing compound shall be applied at the above specified rate. The equipment used may be of the same type as that used for coating variable widths of pavement. Before the additional coating is applied adjacent to sawed joints, the cut faces of the joint shall

be protected by inserting a suitable flexible material in the joint, or placing an adhesive width of impermeable material over the joint, or by placing the permanent sealing compound in the joint. Material, other than the permanent sealing compound, used to protect cut faces of the joint, shall remain in place for the duration of the curing period. In lieu of applying the additional coating, the area of the sawed joint may be cured according to any other method permitted.

When rain occurs before an application of membrane curing compound has dried, and the coating is damaged, the Engineer may require another application be made in the same manner and at the same rate as the original coat. The Engineer may order curing by another method specified, if unsatisfactory results are obtained with membrane curing compound.

- (5) **Wetted Cotton Mat Method.** After the surface of concrete has been textured or finished, it shall be covered immediately with dry or damp cotton mats. The cotton mats shall be placed in a manner which will not mar the concrete surface. A texture resulting from the cotton mat material is acceptable. The cotton mats shall then be wetted immediately and thoroughly soaked with a gentle spray of water. For bridge decks, a foot bridge shall be used to place and wet the cotton mats.

The cotton mats shall be maintained in a wetted condition until the concrete has hardened sufficiently to place soaker hoses without marring the concrete surface. The soaker hoses shall be placed on top of the cotton mats at a maximum 4 ft (1.2 m) spacing. The cotton mats shall be kept wet with a continuous supply of water for the remainder of the curing period. Other continuous wetting systems may be used if approved by the Engineer.

After placement of the soaker hoses, the cotton mats shall be covered with white polyethylene sheeting or burlap-polyethylene blankets.

For construction items other than bridge decks, soaker hoses or a continuous wetting system will not be required if the alternative method keeps the cotton mats wet. Periodic wetting of the cotton mats is acceptable.

For areas inaccessible to the cotton mats on bridge decks, curing shall be according to Article 1020.13(a)(3).

- (b) **Removing and Replacing Curing Covering.** When curing methods specified above in Article 1020.13(a); (1), (2), or (3) are used for concrete pavement, the curing covering for each day's paving shall be removed to permit testing of the pavement surface with a profilograph or straightedge, as directed by the Engineer.

Immediately after testing, the surface of the pavement shall be wetted thoroughly and the curing coverings replaced. The top surface and the edges of the concrete shall not be left unprotected for a period of more than 1/2 hour.

- (c) Protection of Concrete, Other Than Structures, From Low Air Temperatures. When the official National Weather Service forecast for the construction area predicts a low of 32 °F (0 °C), or lower, or if the actual temperature drops to 32 °F (0 °C), or lower, concrete less than 72 hours old shall be provided at least the following protection.

Minimum Temperature	Protection
25 – 32 °F (-4 – 0 °C)	Two layers of polyethylene sheeting, one layer of polyethylene and one layer of burlap, or two layers of waterproof paper.
Below 25 °F (-4 °C)	6 in. (150 mm) of straw covered with one layer of polyethylene sheeting or waterproof paper.

These protective covers shall remain in place until the concrete is at least 96 hours old. When straw is required on pavement cured with membrane curing compound, the compound shall be covered with a layer of burlap, polyethylene sheeting or waterproof paper before the straw is applied.

After September 15, there shall be available to the work within four hours, sufficient clean, dry straw to cover at least two days production. Additional straw shall be provided as needed to afford the protection required. Regardless of the precautions taken, the Contractor shall be responsible for protection of the concrete placed and any concrete damaged by cold temperatures shall be removed and replaced.

- (d) Protection of Concrete Structures From Low Air Temperatures. When the official National Weather Service forecast for the construction area predicts a low below 45 °F (7 °C), or if the actual temperature drops below 45 °F (7 °C), concrete less than 72 hours old shall be provided protection. Concrete shall also be provided protection when placed during the winter period of December 1 through March 15. Concrete shall not be placed until the materials, facilities, and equipment for protection are approved by the Engineer.

When directed by the Engineer, the Contractor may be required to place concrete during the winter period. When winter construction is specified, the Contractor shall proceed with the construction, including excavation, pile driving, concrete, steel erection, and all appurtenant work required for the complete construction of the item, except at times when weather conditions make such operations impracticable.

Regardless of the precautions taken, the Contractor shall be responsible for protection of the concrete placed and any concrete damaged by cold temperatures shall be removed and replaced.

- (1) Protection Method I. The concrete shall be completely covered with insulating material such as fiberglass, rock wool, or other approved commercial insulating material having the minimum thermal resistance R, as defined in ASTM C 168, for

the corresponding minimum dimension of the concrete unit being protected as shown in the following table.

Minimum Pour Dimension		Thermal Resistance R
in.	(mm)	
6 or less	(150 or less)	R=16
> 6 to 12	(> 150 to 300)	R=10
> 12 to 18	(> 300 to 450)	R=6
> 18	(> 450)	R=4

The insulating material manufacturer shall clearly mark the insulating material with the thermal resistance R value.

The insulating material shall be completely enclosed on sides and edges with an approved waterproof liner and shall be maintained in a serviceable condition. Any tears in the liner shall be repaired in a manner approved by the Engineer. The Contractor shall provide means for checking the temperature of the surface of the concrete during the protection period.

On formed surfaces, the insulating material shall be attached to the outside of the forms with wood cleats or other suitable means to prevent any circulation of air under the insulation and shall be in place before the concrete is placed. The blanket insulation shall be applied tightly against the forms. The edges and ends shall be attached so as to exclude air and moisture. If the blankets are provided with nailing flanges, the flanges shall be attached to the studs with cleats. Where tie rods or reinforcement bars protrude, the areas adjacent to the rods or bars shall be adequately protected in a manner satisfactory to the Engineer. Where practicable, the insulation shall overlap any previously placed concrete by at least 1 ft (300 mm). Insulation on the underside of floors on steel members shall cover the top flanges of supporting members. On horizontal surfaces, the insulating material shall be placed as soon as the concrete has set, so that the surface will not be marred and shall be covered with canvas or other waterproof covering. The insulating material shall remain in place for a period of seven days after the concrete is placed.

The Contractor may remove the forms, providing the temperature is 35 °F (2 °C) and rising and the Contractor is able to wrap the particular section within two hours from the time of the start of the form removal. The insulation shall remain in place for the remainder of the seven days curing period.

- (2) Protection Method II. The concrete shall be enclosed in adequate housing and the air surrounding the concrete kept at a temperature of not less than 50 °F (10 °C) nor more than 80 °F (27 °C) for a period of seven days after the concrete is placed. The Contractor shall provide means for checking the temperature of the surface of the concrete or air temperature within the housing during the protection period. All exposed surfaces within the housing shall be cured according to the Index Table.

The Contractor shall provide adequate fire protection where heating is in progress and such protection shall be accessible at all times. The Contractor shall maintain labor to keep the heating equipment in continuous operation.

At the close of the heating period, the temperature shall be decreased to the approximate temperature of the outside air at a rate not to exceed 15 °F (8 °C) per 12 hour period, after which the housing maybe removed. The surface of the concrete shall be permitted to dry during the cooling period.

- (3) Protection Method III. As soon as the surface is sufficiently set to prevent marring, the concrete shall be covered with 12 in. (300 mm) of loose, dry straw followed by a layer of impermeable covering. The edges of the covering shall be sealed to prevent circulation of air and prevent the cover from flapping or blowing. The protection shall remain in place until the concrete is seven days old. If construction operations require removal, the protection removed shall be replaced immediately after completion or suspension of such operations.

1020.14 Temperature Control for Placement. Temperature control for concrete placement shall be according to the following.

- (a) Concrete other than Structures. Concrete may be placed when the air temperature is above 35 °F (2 °C) and rising, and concrete placement shall stop when the falling temperature reaches 40 °F (4 °C) or below, unless otherwise approved by the Engineer.

The temperature of concrete immediately before placement shall be a minimum of 50 °F (10 °C) and a maximum of 90 °F (32 °C). If concrete is pumped, the temperature of the concrete at point of placement shall be a minimum of 50 °F (10 °C) and a maximum of 90 °F (32 °C). A maximum concrete temperature shall not apply to Class PP concrete.

- (b) Concrete in Structures. Concrete may be placed when the air temperature is above 40 °F (4 °C) and rising, and concrete placement shall stop when the falling temperature reaches 45 °F (7 °C) or below, unless otherwise approved by the Engineer.

The temperature of the concrete immediately before placement shall be a minimum of 50 °F (10 °C) and a maximum of 90 °F (32 °C). If concrete is pumped, the temperature of the concrete at point of placement shall be a minimum of 50 °F (10 °C) and a maximum of 90 °F (32 °C).

When insulated forms are used according to Article 1020.13(d)(1), the maximum temperature of the concrete mixture immediately before placement shall be 80 °F (25 °C).

When concrete is placed in contact with previously placed concrete, the temperature of the freshly mixed concrete may be increased to 80 °F (25 °C) by the Contractor to offset anticipated heat loss.

- (c) All Classes of Concrete. Aggregates and water shall be heated or cooled uniformly and as necessary to produce concrete within the specified temperature limits. No frozen aggregates shall be used in the concrete.
- (d) Temperature. The concrete temperature shall be determined according to Illinois Modified AASHTO T 309.

1020.15 Heat of Hydration Control for Concrete Structures. The Contractor shall control the heat of hydration for concrete structures when the least dimension for a drilled shaft, foundation, footing, substructure, or superstructure concrete pour exceeds 5.0 ft (1.5 m). The work shall be according to the following.

- (a) Temperature Restrictions. The maximum temperature of the concrete after placement shall not exceed 150 °F (66 °C). The maximum temperature differential between the internal concrete core and concrete 2 to 3 in. (50 to 75 mm) from the exposed surface shall not exceed 35 °F (19 °C). The Contractor shall perform temperature monitoring to ensure compliance with the temperature restrictions.
- (b) Thermal Control Plan. The Contractor shall provide a thermal control plan a minimum of 28 calendar days prior to concrete placement for review by the Engineer. Acceptance of the thermal control plan by the Engineer shall not preclude the Contractor from specification compliance, and from preventing cracks in the concrete. At a minimum, the thermal control plan shall provide detailed information on the following requested items and shall comply with the specific specifications indicated for each item.
 - (1) Concrete mix design(s) to be used. Grout mix design if post-cooling with embedded pipe.

The mix design requirements in Articles 1020.04 and 1020.05 shall be revised to include the following additional requirements to control the heat of hydration.

- a. The concrete mixture should be uniformly graded and preference for larger size aggregate should be used in the mix design. Article 1004.02(d)(2) shall apply and information in the "Portland Cement Concrete Level III Technician Course – Manual of Instructions for Design of Concrete Mixtures" may be used to develop the uniformly graded mixture.
- b. The following shall apply to all concrete except Class DS concrete or when self-consolidating concrete is desired. For central-mixed concrete, the Contractor shall have the option to develop a mixture with a minimum of 520 lbs/cu yd (309 kg/cu m) of cement and finely divided minerals summed together. For truck-mixed or shrink-mixed concrete, the Contractor shall have the option to develop a mixture with a minimum of 550 lbs/cu yd (326 kg/cu m) of cement and finely divided minerals summed together. A water-reducing or high range water-reducing admixture shall be used in the central mixed, truck-mixed or shrink-

mixed concrete mixture. For any mixture to be placed underwater, the minimum cement and finely divided minerals shall be 550 lbs/cu yd (326 kg/cu m) for central-mixed concrete, and 580 lbs/cu yd (344 kg/cu m) for truck-mixed or shrink-mixed concrete.

For Class DS concrete, CA 11 may be used. If CA 11 is used, the Contractor shall have the option to develop a mixture with a minimum cement and finely divided minerals of 605 lbs/cu yd (360 kg/cu m) summed together. If CA 11 is used and either Class DS concrete is placed underwater or a self-consolidating concrete mixture is desired, the Contractor shall have the option to develop a mixture with a minimum cement and finely divided minerals of 635 lbs/cu yd (378 kg/cu m) summed together.

- c. The minimum portland cement content in the mixture shall be 375 lbs/cu yd (222 kg/cu m). When the total of organic processing additions, inorganic processing additions, and limestone addition exceed 5.0 percent in the cement, the minimum portland cement content in the mixture shall be 400 lbs/cu yd (237 kg/cu m). For a drilled shaft, foundation, footing, or substructure, the minimum portland cement may be reduced to as low as 330 lbs/cu yd (196 kg/cu m) if the concrete has adequate freeze/thaw durability. The Contractor shall provide freeze/thaw test results according to AASHTO T 161 Procedure A or B, and the relative dynamic modulus of elasticity of the mix design shall be a minimum of 80 percent. Freeze/thaw testing will not be required for concrete that will not be exposed to freezing and thawing conditions as determined by the Engineer.
- d. The maximum cement replacement with fly ash shall be 40.0 percent. The maximum cement replacement with ground granulated blast-furnace slag shall be 65.0 percent. When cement replacement with ground granulated blast-furnace slag exceeds 35.0 percent, only Grade 100 shall be used.
- e. The mixture may contain a maximum of two finely divided minerals. The finely divided mineral in portland-pozzolan cement or portland blast-furnace slag cement shall count toward the total number of finely divided minerals allowed. The finely divided minerals shall constitute a maximum of 65.0 percent of the total cement plus finely divided minerals. The fly ash portion shall not exceed 40.0 percent. The ground granulated blast-furnace slag portion shall not exceed 65.0 percent. The microsilica or high-reactivity metakaolin portion used together or separately shall not exceed 5.0 percent.
- f. The time to obtain the specified strength may be increased to a maximum 56 days, provided the curing period specified in Article 1020.13 is increased to a minimum of 14 days.

The minimum grout strength for filling embedded pipe shall be as specified for the concrete, and testing shall be according to AASHTO T 106.

- (2) The selected mathematical method for evaluating heat of hydration thermal effects, which shall include the calculated adiabatic temperature rise, calculated maximum concrete temperature, and calculated maximum temperature differential between the internal concrete core and concrete 2 to 3 in. (50 to 75 mm) from the exposed surface. The time when the maximum concrete temperature and maximum temperature differential will occur is required.

Acceptable mathematical methods include ACI 207.2R "Report on Thermal and Volume Change Effects on Cracking of Mass Concrete" as well as other proprietary methods. The Contractor shall perform heat of hydration testing on the cement and finely divided minerals to be used in the concrete mixture. The test shall be according to ASTM C 186 or other applicable test methods, and the result for heat shall be used in the equation to calculate adiabatic temperature rise. Other required test parameters for the mathematical model may be assumed if appropriate.

The Contractor has the option to propose a higher maximum temperature differential between the internal concrete core and concrete 2 to 3 in. (50 to 75 mm) from the exposed surface, but the proposed value shall not exceed 50 °F (28 °C). In addition, based on strength gain of the concrete, multiple maximum temperature differentials at different times may be proposed. The proposed value shall be justified through a mathematical method.

- (3) Proposed maximum concrete temperature or temperature range prior to placement.

Article 1020.14 shall apply except a minimum 40 °F (4 °C) concrete temperature will be permitted.

- (4) Pre-cooling, post-cooling, and surface insulation methods that will be used to ensure the concrete will comply with the specified maximum temperature and specified or proposed temperature differential. For reinforcement that extends beyond the limits of the pour, the Contractor shall indicate if the reinforcement is required to be covered with insulation.

Refer to ACI 207.4R "Cooling and Insulating Systems for Mass Concrete" for acceptable methods that will be permitted. If embedded pipe is used for post-cooling, the material shall be polyvinyl chloride or polyethylene. The embedded pipe system shall be properly supported, and the Contractor shall subsequently inspect glued joints to ensure they are able to withstand free falling concrete. The embedded pipe system shall be leak tested after inspection of the glued joints, and prior to the concrete placement. The leak test shall be performed at maximum service pressure or higher for a minimum of 15 minutes. All leaks shall be repaired. The embedded pipe cooling water may be from natural sources such as streams and rivers, but shall be filtered to prevent system stoppages. When the embedded pipe is no longer needed, the surface connections to the pipe shall be removed to a depth of 4 in. (100 mm) below the surface of the concrete. The remaining pipe shall be

completely filled with grout. The 4 in. (100 mm) deep concrete hole shall be filled with nonshrink grout. Form and insulation removal shall be done in a manner to prevent cracking and ensure the maximum temperature differential is maintained. Insulation shall be in good condition as determined by the Engineer and properly attached.

- (5) Dimensions of each concrete pour, location of construction joints, placement operations, pour pattern, lift heights, and time delays between lifts.

Refer to ACI 207.1R "Guide to Mass Concrete" for acceptable placement operations that will be permitted.

- (6) Type of temperature monitoring system, the number of temperature sensors, and location of sensors.

A minimum of two independent temperature monitoring systems and corresponding sensors shall be used.

The temperature monitoring system shall have a minimum temperature range of 32 °F (0 °C) to 212 °F (100 °C), an accuracy of ± 2 °F (± 1 °C), and be able to automatically record temperatures without external power. Temperature monitoring shall begin once the sensor is encased in concrete, and with a maximum interval of one hour. Temperature monitoring may be discontinued after the maximum concrete temperature has been reached, post-cooling is no longer required, and the maximum temperature differential between the internal concrete core and the ambient air temperature does not exceed 35 °F (19 °C). The Contractor has the option to select a higher maximum temperature differential, but the proposed value shall not exceed 50 °F (28 °C). The proposed value shall be justified through a mathematical method.

At a minimum, a temperature sensor shall be located at the theoretical hottest portion of the concrete, normally the geometric center, and at the exterior face that will provide the maximum temperature differential. At the exterior face, the sensor shall be located 2 to 3 in. (50 to 75 mm) from the surface of the concrete. Sensors shall also be located a minimum of 1 in. (25 mm) away from reinforcement, and equidistant between cooling pipes if either applies. A sensor will also be required to measure ambient air temperature. The entrant/exit cooling water temperature for embedded pipe shall also be monitored.

Temperature monitoring results shall be provided to the Engineer a minimum of once each day and whenever requested by the Engineer. The report may be electronic or hard copy. The report shall indicate the location of each sensor, the temperature recorded, and the time recorded. The report shall be for all sensors and shall include ambient air temperature and entrant/exit cooling water temperatures. The temperature data in the report may be provided in tabular or graphical format, and the report shall indicate any corrective actions during the monitoring period. At the

completion of the monitoring period, the Contractor shall provide the Engineer a final report that includes all temperature data and corrective actions.

(7) Indicate contingency operations to be used if the maximum temperature or temperature differential of the concrete is reached after placement.

(c) Temperature Restriction Violations. If the maximum temperature of the concrete after placement exceeds 150 °F (66 °C), but is equal to or less than 158 °F (70 °C), the concrete will be accepted if no cracking or other unacceptable defects are identified. If cracking or unacceptable defects are identified, Article 105.03 shall apply. If the concrete temperature exceeds 158 °F (70 °C), Article 105.03 shall apply.

If a temperature differential between the internal concrete core and concrete 2 to 3 in. (50 to 75 mm) from the exposed surface exceeds the specified or proposed maximum value allowed, the concrete will be accepted if no cracking or other unacceptable defects are identified. If unacceptable defects are identified, Article 105.03 shall apply.

When the maximum 150 °F (66 °C) concrete temperature or the maximum allowed temperature differential is violated, the Contractor shall implement corrective action prior to the next pour. In addition, the Engineer reserves the right to request a new thermal control plan for acceptance before the Contractor is allowed to pour again.

(d) Inspection and Repair of Cracks. The Engineer will inspect the concrete for cracks after the temperature monitoring is discontinued, and the Contractor shall provide access for the Engineer to do the inspection. A crack may require repair by the Contractor as determined by the Engineer. The Contractor shall be responsible for the repair of all cracks. Protective coat or a concrete sealer shall be applied to a crack less than 0.007 in. (0.18 mm) in width. A crack that is 0.007 in. (0.18 mm) or greater shall be pressure injected with epoxy according to Section 590.

80279

398

PORTLAND CEMENT CONCRETE EQUIPMENT (BDE)

Effective: November 1, 2013

Add the following to the first paragraph of Article 1103.03(a)(5) of the Standard Specifications to read:

“As an alternative to a locking key, the start and finish time for mixing may be automatically printed on the batch ticket. The start and finish time shall be reported to the nearest second.”

80326

PROGRESS PAYMENTS (BDE)

Effective: November 2, 2013

Revise Article 109.07(a) of the Standard Specifications to read:

“(a) Progress Payments. At least once each month, the Engineer will make a written estimate of the quantity of work performed in accordance with the contract, and the value thereof at the contract unit prices. The amount of the estimate approved as due for payment will be vouchered by the Department and presented to the State Comptroller for payment. No amount less than \$1000.00 will be approved for payment other than the final payment.

Progress payments may be reduced by liens filed pursuant to Section 23(c) of the Mechanics' Lien Act, 770 ILCS 60/23(c).

If a Contractor or subcontractor has defaulted on a loan issued under the Department's Disadvantaged Business Revolving Loan Program (20 ILCS 2705/2705-610), progress payments may be reduced pursuant to the terms of that loan agreement. In such cases, the amount of the estimate related to the work performed by the Contractor or subcontractor, in default of the loan agreement, will be offset, in whole or in part, and vouchered by the Department to the Working Capital Revolving Fund or designated escrow account. Payment for the work shall be considered as issued and received by the Contractor or subcontractor on the date of the offset voucher. Further, the amount of the offset voucher shall be a credit against the Department's obligation to pay the Contractor, the Contractor's obligation to pay the subcontractor, and the Contractor's or subcontractor's total loan indebtedness to the Department. The offset shall continue until such time as the entire loan indebtedness is satisfied. The Department will notify the Contractor and Fund Control Agent in a timely manner of such offset. The Contractor or subcontractor shall not be entitled to additional payment in consideration of the offset.

The failure to perform any requirement, obligation, or term of the contract by the Contractor shall be reason for withholding any progress payments until the Department determines that compliance has been achieved.”

80328

399A

QUALITY CONTROL/QUALITY ASSURANCE OF CONCRETE MIXTURES (BDE)

Effective: January 1, 2012

Revised: November 1, 2013

Add the following to Section 1020 of the Standard Specifications:

"1020.16 Quality Control/Quality Assurance of Concrete Mixtures. This Article specifies the quality control responsibilities of the Contractor for concrete mixtures (except Class PC and PS concrete), cement aggregate mixture II, and controlled low-strength material incorporated in the project, and defines the quality assurance and acceptance responsibilities of the Engineer.

A list of quality control/quality assurance (QC/QA) documents is provided in Article 1020.16(g), Schedule D.

A Level I Portland Cement Concrete (PCC) Technician shall be defined as an individual who has successfully completed the Department's training for concrete testing.

A Level II Portland Cement Concrete (PCC) Technician shall be defined as an individual who has successfully completed the Department's training for concrete proportioning.

A Level III Portland Cement Concrete (PCC) Technician shall be defined as an individual who has successfully completed the Department's training for concrete mix design.

A Concrete Tester shall be defined as an individual who has successfully completed the Department's training to assist with concrete testing and is monitored on a daily basis.

Aggregate Technician shall be defined as an individual who has successfully completed the Department's training for gradation testing involving aggregate production and mixtures.

Mixture Aggregate Technician shall be defined as an individual who has successfully completed the Department's training for gradation testing involving mixtures.

Gradation Technician shall be defined as an individual who has successfully completed the Department's training to assist with gradation testing and is monitored on a daily basis.

- (a) Equipment/Laboratory. The Contractor shall provide a laboratory and test equipment to perform their quality control testing.

The laboratory shall be of sufficient size and be furnished with the necessary equipment, supplies, and current published test methods for adequately and safely performing all required tests. The laboratory will be approved by the Engineer according to the current Bureau of Materials and Physical Research Policy Memorandum "Minimum Private Laboratory Requirements for Construction Materials Testing or Mix Design". Production of a mixture shall not begin until the Engineer provides written approval of the laboratory.

The Contractor shall refer to the Department's "Required Sampling and Testing Equipment for Concrete" for equipment requirements.

Test equipment shall be maintained and calibrated as required by the appropriate test method, and when required by the Engineer. This information shall be documented on the Department's "Calibration of Concrete Testing Equipment" form.

Test equipment used to determine compressive or flexural strength shall be calibrated each 12 month period by an independent agency, using calibration equipment traceable to the National Institute of Standards and Technology (NIST). The Contractor shall have the calibration documentation available at the test equipment location.

The Engineer will have unrestricted access to the plant and laboratory at any time to inspect measuring and testing equipment, and will notify the Contractor of any deficiencies. Defective equipment shall be immediately repaired or replaced by the Contractor.

- (b) Quality Control Plan. The Contractor shall submit, in writing, a proposed Quality Control (QC) Plan to the Engineer. The QC Plan shall be submitted a minimum of 45 calendar days prior to the production of a mixture. The QC Plan shall address the quality control of the concrete, cement aggregate mixture II, and controlled low-strength material incorporated in the project. The Contractor shall refer to the Department's "Model Quality Control Plan for Concrete Production" to prepare a QC Plan. The Engineer will respond in writing to the Contractor's proposed QC Plan within 15 calendar days of receipt.

Production of a mixture shall not begin until the Engineer provides written approval of the QC Plan. The approved QC Plan shall become a part of the contract between the Department and the Contractor, but shall not be construed as acceptance of any mixture produced.

The QC Plan may be amended during the progress of the work, by either party, subject to mutual agreement. The Engineer will respond in writing to a Contractor's proposed QC Plan amendment within 15 calendar days of receipt. The response will indicate the approval or denial of the Contractor's proposed QC Plan amendment.

- (c) Quality Control by Contractor. The Contractor shall perform quality control inspection, sampling, testing, and documentation to meet contract requirements. Quality control includes the recognition of obvious defects and their immediate correction. Quality control also includes appropriate action when passing test results are near specification limits, or to resolve test result differences with the Engineer. Quality control may require increased testing, communication of test results to the plant or the jobsite, modification of operations, suspension of mixture production, rejection of material, or other actions as appropriate. The Engineer shall be immediately notified of any failing tests and subsequent remedial action. Passing tests shall be reported no later than the start of the next work day.

When a mixture does not comply with specifications, the Contractor shall reject the material; unless the Engineer accepts the material for incorporation in the work, according to Article 105.03.

- (1) Personnel Requirements. The Contractor shall provide a Quality Control (QC) Manager who will have overall responsibility and authority for quality control. The jobsite and plant personnel shall be able to contact the QC Manager by cellular phone, two-way radio or other methods approved by the Engineer.

The QC Manager shall visit the jobsite a minimum of once a week. A visit shall be performed the day of a bridge deck pour, the day a non-routine mixture is placed as determined by the Engineer, or the day a plant is anticipated to produce more than 1000 cu yd (765 cu m). Any of the three required visits may be used to meet the once per week minimum requirement.

The Contractor shall provide personnel to perform the required inspections, sampling, testing and documentation in a timely manner. The Contractor shall refer to the Department's "Qualifications and Duties of Concrete Quality Control Personnel" document.

A Level I PCC Technician shall be provided at the jobsite during mixture production and placement, and may supervise concurrent pours on the project. For concurrent pours, a minimum of one Concrete Tester shall be required at each pour location. If the Level I PCC Technician is at one of the pour locations, a Concrete Tester is still required at the same location. Each Concrete Tester shall be able to contact the Level I PCC Technician by cellular phone, two-way radio or other methods approved by the Engineer. A single Level I PCC Technician shall not supervise concurrent pours for multiple contracts.

A Level II PCC Technician shall be provided at the plant, or shall be available, during mixture production and placement. A Level II PCC Technician may supervise a maximum of three plants. Whenever the Level II PCC Technician is not at the plant during mixture production and placement, a Concrete Tester or Level I PCC Technician shall be present at the plant to perform any necessary concrete tests. The Concrete Tester, Level I PCC Technician, or other individual shall also be trained to perform any necessary aggregate moisture tests, if the Level II PCC Technician is not at the plant during mixture production and placement. The Concrete Tester, Level I PCC Technician, plant personnel, and jobsite personnel shall have the ability to contact the Level II PCC Technician by cellular phone, two-way radio, or other methods approved by the Engineer.

For a mixture which is produced and placed with a mobile portland cement concrete plant as defined in Article 1103.04, a Level II PCC Technician shall be provided. The Level II PCC Technician shall be present at all times during mixture production and placement. However, the Level II PCC Technician may request to be available if

operations are satisfactory. Approval shall be obtained from the Engineer, and jobsite personnel shall have the ability to contact the Level II PCC Technician by cellular phone, two-way radio, or other methods approved by the Engineer.

A Concrete Tester, Mixture Aggregate Technician, and Aggregate Technician may provide assistance with sampling and testing. A Gradation Technician may provide assistance with testing. A Concrete Tester shall be supervised by a Level I or Level II PCC Technician. A Gradation Technician shall be supervised by a Level II PCC Technician, Mixture Aggregate Technician, or Aggregate Technician.

- (2) Required Plant Tests. Sampling and testing shall be performed at the plant, or at a location approved by the Engineer, to control the production of a mixture. The required minimum Contractor plant sampling and testing is indicated in Article 1020.16(g) Schedule A.
- (3) Required Field Tests. Sampling and testing shall be performed at the jobsite to control the production of a mixture, and to comply with specifications for placement. For standard curing, after initial curing, and for strength testing; the location shall be approved by the Engineer. The required minimum Contractor jobsite sampling and testing is indicated in Article 1020.16(g), Schedule B.
- (d) Quality Assurance by Engineer. The Engineer will perform quality assurance tests on independent samples and split samples. An independent sample is a field sample obtained and tested by only one party. A split sample is one of two equal portions of a field sample, where two parties each receive one portion for testing. The Engineer may request the Contractor to obtain a split sample. Aggregate split samples and any failing strength specimen shall be retained until permission is given by the Engineer for disposal. The results of all quality assurance tests by the Engineer will be made available to the Contractor. However, Contractor split sample test results shall be provided to the Engineer before Department test results are revealed. The Engineer's quality assurance independent sample and split sample testing is indicated in Article 1020.16(g), Schedule C.
 - (1) Strength Testing. For strength testing, Article 1020.09 shall apply, except the Contractor and Engineer strength specimens may be placed in the same field curing box for initial curing and may be cured in the same water storage tank for final curing.
 - (2) Comparing Test Results. Differences between the Engineer's and the Contractor's split sample test results will be considered reasonable if within the following limits:

Test Parameter	Acceptable Limits of Precision
Slump	0.75 in. (20 mm)
Air Content	0.9%
Compressive Strength	900 psi (6200 kPa)

Flexural Strength	90 psi (620 kPa)
Slump Flow (Self-Consolidating Concrete (SCC))	1.5 in. (40 mm)
Visual Stability Index (SCC)	Not Applicable
J-Ring (SCC)	1.5 in. (40 mm)
L-Box (SCC)	10 %
Hardened Visual Stability Index (SCC)	Not Applicable
Dynamic Segregation Index (SCC)	1.0 %
Flow (Controlled Low-Strength Material (CLSM))	1.5 in. (40 mm)
Strength (Controlled Low-Strength Material (CLSM))	40 psi (275 kPa)
Aggregate Gradation	See "Guideline for Sample Comparison" in Appendix "A" of the Manual of Test Procedures for Materials.

When acceptable limits of precision have been met, but only one party is within specification limits, the failing test shall be resolved before the material may be considered for acceptance.

(3) Test Results and Specification Limits.

- a. Split Sample Testing. If either the Engineer's or the Contractor's split sample test result is not within specification limits, and the other party is within specification limits; immediate retests on a split sample shall be performed for slump, air content, slump flow, visual stability index, J-Ring, L-Box, dynamic segregation index, flow (CLSM), or aggregate gradation. A passing retest result by each party will require no further action. If either the Engineer's or Contractor's slump, air content, slump flow, visual stability index, J-Ring, L-Box, dynamic segregation index, flow (CLSM), or aggregate gradation split sample retest result is a failure; or if either the Engineer's or Contractor's strength or hardened visual stability index test result is a failure, and the other party is within specification limits; the following actions shall be initiated to investigate the test failure:

1. The Engineer and the Contractor shall investigate the sampling method, test procedure, equipment condition, equipment calibration, and other factors.
2. The Engineer or the Contractor shall replace test equipment, as determined by the Engineer.
3. The Engineer and the Contractor shall perform additional testing on split samples, as determined by the Engineer.

For aggregate gradation, jobsite slump, jobsite air content, jobsite slump flow, jobsite visual stability index, jobsite J-Ring, jobsite L-Box, jobsite dynamic segregation index, and jobsite flow (CLSM); if the failing split sample test result is not resolved according to 1., 2., or 3., and the mixture has not been placed, the Contractor shall reject the material; unless the Engineer accepts the material for

incorporation in the work according to Article 105.03. If the mixture has already been placed, or if a failing strength or hardened visual stability index test result is not resolved according to 1., 2., or 3., the material will be considered unacceptable.

If a continued trend of difference exists between the Engineer's and the Contractor's split sample test results, or if split sample test results exceed the acceptable limits of precision, the Engineer and the Contractor shall investigate according to items 1., 2., and 3.

- b. Independent Sample Testing. For aggregate gradation, jobsite slump, jobsite air content jobsite slump flow, jobsite visual stability index, jobsite J-Ring, jobsite L-Box, jobsite dynamic segregation index, jobsite flow (CLSM); if the result of a quality assurance test on a sample independently obtained by the Engineer is not within specification limits, and the mixture has not been placed, the Contractor shall reject the material, unless the Engineer accepts the material for incorporation in the work according to Article 105.03. If the mixture has already been placed or the Engineer obtains a failing strength or hardened visual stability index test result, the material will be considered unacceptable.
- (e) Acceptance by the Engineer. Final acceptance will be based on the Standard Specifications and the following:
- (1) The Contractor's compliance with all contract documents for quality control.
 - (2) Validation of Contractor quality control test results by comparison with the Engineer's quality assurance test results using split samples. Any quality control or quality assurance test determined to be flawed may be declared invalid only when reviewed and approved by the Engineer. The Engineer will declare a test result invalid only if it is proven that improper sampling or testing occurred. The test result is to be recorded and the reason for declaring the test invalid will be provided by the Engineer.
 - (3) Comparison of the Engineer's quality assurance test results with specification limits using samples independently obtained by the Engineer.

The Engineer may suspend mixture production, reject materials, or take other appropriate action if the Contractor does not control the quality of concrete, cement aggregate mixture II, or controlled low-strength material for acceptance. The decision will be determined according to (1), (2), or (3).

(f) Documentation.

- (1) Records. The Contractor shall be responsible for documenting all observations, inspections, adjustments to the mix design, test results, retest results, and corrective actions in a bound hardback field book, bound hardback diary, or appropriate

Department form, which shall become the property of the Department. The documentation shall include a method to compare the Engineer's test results with the Contractor's results. The Contractor shall be responsible for the maintenance of all permanent records whether obtained by the Contractor, the consultants, the subcontractors, or the producer of the mixture. The Contractor shall provide the Engineer full access to all documentation throughout the progress of the work.

The Department's form MI 504M, form BMPR MI654, and form BMPR MI655 shall be completed by the Contractor, and shall be submitted to the Engineer weekly or as required by the Engineer. A correctly completed form MI 504M, form BMPR MI654, and form BMPR MI655 are required to authorize payment by the Engineer, for applicable pay items.

- (2) Delivery Truck Ticket. The following information shall be recorded on each delivery ticket or in a bound hardback field book: initial revolution counter reading (final reading optional) at the jobsite, if the mixture is truck-mixed; time discharged at the jobsite; total amount of each admixture added at the jobsite; and total amount of water added at the jobsite.
- (g) Basis of Payment and Schedules. Quality Control/Quality Assurance of portland cement concrete mixtures will not be paid for separately, but shall be considered as included in the cost of the various concrete contract items.

SCHEDULE A

CONTRACTOR PLANT SAMPLING AND TESTING			
Item	Test	Frequency	IL Modified AASHTO or Department Test Method ^{1/}
Aggregates (Arriving at Plant)	Gradation ^{2/}	As needed to check source for each gradation number	2, 11, 27, and 248
Aggregates (Stored at Plant in Stockpiles or Bins)	Gradation ^{2/}	2,500 cu yd (1,900 cu m) for each gradation number ^{3/}	2, 11, 27, and 248
Aggregates (Stored at Plant in Stockpiles or Bins)	Moisture ^{4/} : Fine Aggregate	Once per week for moisture sensor, otherwise daily for each gradation number	Flask, Dunagan, Pycnometer Jar, or 255
	Moisture ^{4/} : Coarse Aggregate	As needed to control production for each gradation number	Dunagan, Pycnometer Jar, or 255
Mixture ^{5/}	Slump Air Content Unit Weight / Yield Slump Flow (SCC) Visual Stability Index (SCC) J-Ring (SCC) ^{6/} L-Box (SCC) ^{6/} Temperature	As needed to control production	T 141 and T 119 T 141 and T 152 or T 196 T 141 and T 121 SCC-1 and SCC-2 SCC-1 and SCC-2 SCC-1 and SCC-3 SCC-1 and SCC-4 T 141 and T 309
Mixture (CLSM) ^{7/}	Flow Air Content Temperature	As needed to control production	Illinois Test Procedure 307

1/ Refer to the Department's "Manual of Test Procedures for Materials".

2/ All gradation tests shall be washed. Testing shall be completed no later than 24 hours after the aggregate has been sampled.

3/ One per week (Sunday through Saturday) minimum unless the stockpile has not received additional aggregate material since the previous test.

One per day minimum for a bridge deck pour unless the stockpile has not received additional aggregate material since the previous test. The sample shall be taken and testing completed prior to the pour. The bridge deck aggregate sample may be taken the day before the pour or as approved by the Engineer.

4/ If the moisture test and moisture sensor disagree by more than 0.5 percent, retest. If the difference remains, adjust the moisture sensor to an average of two or more moisture tests. The Department's "Water/Cement Ratio Worksheet" form shall be completed when applicable.

5/ The Contractor may also perform strength testing according to Illinois Modified AASHTO T 141, T 23, and T 22 or T 177; or water content testing according to Illinois Modified AASHTO T 318.

The Contractor may also perform other available self-consolidating concrete (SCC) tests at the plant to control mixture production.

6/ The Contractor shall select the J-Ring or L-Box test for plant sampling and testing.

7/ The Contractor may also perform strength testing according to Illinois Test Procedure 307.

SCHEDULE B

CONTRACTOR JOBSITE SAMPLING & TESTING ^{1/}			
Item	Measured Property	Random Sample Testing Frequency per Mix Design and per Plant ^{2/}	IL Modified AASHTO Test Method
Pavement, Shoulder, Base Course, Base Course Widening, Driveway Pavement, Railroad Crossing, Cement Aggregate Mixture II	Slump ^{3/4/}	1 per 500 cu yd (400 cu m) or minimum 1/day	T 141 and T 119
	Air Content ^{3/5/6/}	1 per 100 cu yd (80 cu m) or minimum 1/day	T 141 and T 152 or T 196
	Compressive Strength ^{7/8/} or Flexural Strength ^{7/8/}	1 per 1250 cu yd (1000 cu m) or minimum 1/day	T 141, T 22 and T 23 or T 141, T 177 and T 23
Bridge Approach Slab ^{9/} , Bridge Deck ^{9/} , Bridge Deck Overlay ^{9/} , Superstructure ^{9/} , Substructure, Culvert, Miscellaneous Drainage Structures, Retaining Wall, Building Wall, Drilled Shaft Pile & Encasement Footing, Foundation, Pavement Patching, Structural Repairs	Slump ^{3/4/}	1 per 50 cu yd (40 cu m) or minimum 1/day	T 141 and T 119
	Air Content ^{3/5/6/}	1 per 50 cu yd (40 cu m) or minimum 1/day	T 141 and T 152 or T 196
	Compressive Strength ^{7/8/} or Flexural Strength ^{7/8/}	1 per 250 cu yd (200 cu m) or minimum 1/day	T 141, T 22 and T 23 or T 141, T 177 and T 23
Seal Coat	Slump ^{3/}	1 per 250 cu yd (200 cu m) or minimum 1/day	T 141 and T 119
	Air Content ^{3/5/6/}	1 per 250 cu yd (200 cu m) or minimum 1/day when air is entrained	T 141 and T 152 or T 196
	Compressive Strength ^{7/8/} or Flexural Strength ^{7/8/}	1 per 250 cu yd (200 cu m) or minimum 1/day	T 141, T 22 and T 23 or T 141, T 177 and T 23

CONTRACTOR JOBSITE SAMPLING & TESTING ^{1/}			
Curb, Gutter, Median, Barrier, Sidewalk, Slope Wall, Paved Ditch, Fabric Formed Concrete Revetment Mat ^{10/} , Miscellaneous Items, Incidental Items	Slump ^{3/4/}	1 per 100 cu yd (80 cu m) or minimum 1/day	T 141 and T 119
	Air Content ^{3/5/6/}	1 per 50 cu yd (40 cu m) or minimum 1/day	T 141 and T 152 or T 196
	Compressive Strength ^{7/8/} or Flexural Strength ^{7/8/}	1 per 400 cu yd (300 cu m) or minimum 1/day	T 141, T 22 and T 23 or T 141, T 177 and T 23
The Item will use a Self-Consolidating Concrete Mixture	Slump Flow ^{3/} VSI ^{3/} J-Ring ^{3/11/} L-Box ^{3/11/}	Perform at same frequency that is specified for the Item's slump	SCC-1 & SCC-2 SCC-1 & SCC-2 SCC-1 & SCC-3 SCC-1 & SCC-4
The Item will use a Self-Consolidating Concrete Mixture	HVSI ^{12/}	Minimum 1/day at start of production for that day	SCC-1 and SCC-6
The Item will use a Self-Consolidating Concrete Mixture	Dynamic Segregation Index (DSI)	Minimum 1/week at start of production for that week	SCC-1 and SCC-8 (Option C)
The Item will use a Self-Consolidating Concrete Mixture	Air Content ^{3/5/6/}	Perform at same frequency that is specified for the Item's air content	SCC-1 and T 152 or T 196
The Item will use a Self-Consolidating Concrete Mixture	Compressive Strength ^{7/8/} or Flexural Strength ^{7/8/}	Perform at same frequency that is specified for the Item's strength	SCC-1, T 22 and T 23 or SCC-1, T 177 and T 23
All	Temperature ^{3/}	As needed to control production	T 141 and T 309
Controlled Low-Strength Material (CLSM)	Flow, Air Content, Compressive Strength (28-day) ^{13/} , and Temperature	First truck load delivered and as needed to control production thereafter	Illinois Test Procedure 307

1/ Sampling and testing of small quantities of curb, gutter, median, barrier, sidewalk, slope wall, paved ditch, miscellaneous items, and incidental items may be waived by the Engineer if requested by the Contractor. However, quality control personnel are still required according to Article 1020.16(c)(1) The Contractor shall also provide recent evidence that similar material has been found to be satisfactory under normal sampling and testing procedures. The total quantity that may be waived for testing shall not exceed 100 cu yd (76 cu m) per contract.

If the Contractor's or Engineer's test result for any jobsite mixture test is not within the specification limits, all subsequent truck loads delivered shall be tested by the Contractor until the problem is corrected.

- 2/ If one mix design is being used for several construction items during a day's production, one testing frequency may be selected to include all items. The construction items shall have the same slump, air content, and water/cement ratio specifications. For self-consolidating concrete, the construction items shall have the same slump flow, visual stability index, J-Ring, L-Box, air content, and water/cement ratio specifications. The frequency selected shall equal or exceed the testing required for the construction item.

One sufficiently sized sample shall be taken to perform the required test(s). Random numbers shall be determined according to the Department's "Method for Obtaining Random Samples for Concrete". The Engineer will provide random sample locations.

- 3/ The temperature, slump, and air content tests shall be performed on the first truck load delivered, for each pour. For self consolidating concrete, the temperature, slump flow, visual stability index, J-Ring or L-Box, and air content tests shall be performed on the first truck load delivered, for each pour. Unless a random sample is required for the first truck load, testing the first truck load does not satisfy random sampling requirements.
- 4/ The slump random sample testing frequency shall be a minimum 1/day for a construction item which is slipformed.
- 5/ If a pump or conveyor is used for placement, a correction factor shall be established to allow for a loss of air content during transport. The first three truck loads delivered shall be tested, before and after transport by the pump or conveyor, to establish the correction factor. Once the correction is determined, it shall be re-checked after an additional 50 cu yd (40 cu m) is pumped, or an additional 100 cu yd (80 cu m) is conveyed. This shall continue throughout the pour. If the re-check indicates the correction factor has changed, a minimum of two truckloads is required to re-establish the correction factor. The correction factor shall also be re-established when significant changes in temperature, distance, pump or conveyor arrangement, and other factors have occurred. If the correction factor is >3.0 percent, the Contractor shall take corrective action to reduce the loss of air content during transport by the pump or conveyor. The Contractor shall record all air content test results, correction factors and corrected air contents. The corrected air content shall be reported on form Bmpr MI654.
- 6/ If the Contractor's or Engineer's air content test result is within the specification limits, and 0.2 percent or closer to either limit, the next truck load delivered shall be tested by the Contractor. For example, if the specified air content range is 5.0 to 8.0 percent and the test result is 5.0, 5.1, 5.2, 7.8, 7.9 or 8.0 percent, the next truck shall be tested by the Contractor.
- 7/ The test of record for strength shall be the day indicated in Article 1020.04. For cement aggregate mixture II, a strength requirement is not specified and testing is not required. Additional strength testing to determine early falsework and form removal, early pavement or bridge opening to traffic, or to monitor strengths is at the discretion of the Contractor. Strength shall be defined as the average of two 6 x 12 in. (150 x 300 mm) cylinder breaks, three 4 x 8 in. (100 x 200 mm) cylinder breaks, or two beam breaks for

field tests. Per Illinois Modified AASHTO T 23, cylinders shall be 6 x 12 in. (150 x 300 mm) when the nominal maximum size of the coarse aggregate exceeds 1 in. (25 mm).

- 8/ In addition to the strength test, a slump test, air content test, and temperature test shall be performed on the same sample. For self-consolidating concrete, a slump flow test, visual stability index test, J-Ring or L-Box test, air content test, and temperature test shall be performed on the same sample as the strength test. For mixtures pumped or conveyed, the Contractor shall sample according to Illinois Modified AASHTO T 141.
- 9/ The air content test will be required for each delivered truck load.
- 10/ For fabric formed concrete revetment mat, the slump test is not required and the flexural strength test is not applicable.
- 11/ The Contractor shall select the J-Ring or L-Box test for jobsite sampling and testing.
- 12/ In addition to the hardened visual stability index (HVSI) test, a slump flow test, visual stability index (VSI) test, J-Ring or L-Box test, air content test, and temperature test shall be performed on the same sample. The Contractor shall retain all hardened visual stability index cut cylinder specimens until the Engineer notifies the Contractor that the specimens may be discarded.
- 13/ The test of record for strength shall be the day indicated in Article 1019.04. In addition to the strength test, a flow test, air content test, and temperature test shall be performed on the same sample. The strength test may be waived by the Engineer if future removal of the material is not a concern.

SCHEDULE C

ENGINEER QUALITY ASSURANCE INDEPENDENT SAMPLE TESTING		
Location	Measured Property	Testing Frequency ^{1/}
Plant	Gradation of aggregates stored in stockpiles or bins, Slump and Air Content	As determined by the Engineer.
Jobsite	Slump, Air Content, Slump Flow, Visual Stability Index, J-Ring, L-Box, Hardened Visual Stability Index, Dynamic Segregation Index and Strength	As determined by the Engineer.
	Flow, Air Content, Strength (28-day), and Dynamic Cone Penetration for Controlled Low-Strength Material (CLSM)	As determined by the Engineer

ENGINEER QUALITY ASSURANCE SPLIT SAMPLE TESTING		
Location	Measured Property	Testing Frequency ^{1/}
Plant	Gradation of aggregates stored in stockpiles or bins ^{2/}	At the beginning of the project, the first test performed by the Contractor. Thereafter, a minimum of 10% of total tests required of the Contractor will be performed per aggregate gradation number and per plant.
	Slump and Air Content	As determined by the Engineer.
Jobsite	Slump ^{2/} , Air Content ^{2/3/} , Slump Flow ^{2/} , Visual Stability Index ^{2/} , J-Ring ^{2/} and L-box ^{2/}	At the beginning of the project, the first three tests performed by the Contractor. Thereafter, a minimum of 20% of total tests required of the Contractor will be performed per plant, which will include a minimum of one test per mix design.
	Hardened Visual Stability Index ^{2/}	As determined by the Engineer.
	Dynamic Segregation Index ^{2/}	As determined by the Engineer.
	Strength ^{2/}	At the beginning of the project, the first test performed by the Contractor. Thereafter, a minimum of 20% of total tests required of the Contractor will be performed per plant, which will include a minimum of one test per mix design.
	Flow, Air Content, and Strength (28-day) for Controlled Low-Strength Material (CLSM)	As determined by the Engineer.

- 1/ The Engineer will perform the testing throughout the period of quality control testing by the Contractor.
- 2/ The Engineer will witness and take immediate possession of or otherwise secure the Department's split sample obtained by the Contractor.
- 3/ Before transport by pump or conveyor, a minimum of 20 percent of total tests required of the Contractor will be performed per mix design and per plant. After transport by pump or conveyor, a minimum of 20 percent of total tests required of the Contractor will be performed per mix design and per plant.

SCHEDULE D

CONCRETE QUALITY CONTROL AND QUALITY ASSURANCE DOCUMENTS

- (a) Model Quality Control Plan for Concrete Production (*)
- (b) Qualifications and Duties of Concrete Quality Control Personnel (*)
- (c) Development of Gradation Bands on Incoming Aggregate at Mix Plants (*)
- (d) Required Sampling and Testing Equipment for Concrete (*)
- (e) Method for Obtaining Random Samples for Concrete (*)
- (f) Calibration of Concrete Testing Equipment (BMPR PCCQ01 through BMPR PCCQ09) (*)
- (g) Water/Cement Ratio Worksheet (BMPR PCCW01) (*)
- (h) Field/Lab Gradations (MI 504M) (*)
- (i) Concrete Air, Slump and Quantity (BMPR MI654) (*)
- (j) P.C. Concrete Strengths (BMPR MI655) (*)
- (k) Aggregate Technician Course or Mixture Aggregate Technician Course (*)
- (l) Portland Cement Concrete Tester Course (*)
- (m) Portland Cement Concrete Level I Technician Course - Manual of Instructions for Concrete Testing (*)
- (n) Portland Cement Concrete Level II Technician Course - Manual of Instructions for Concrete Proportioning (*)
- (o) Portland Cement Concrete Level III Technician Course - Manual of Instructions for Design of Concrete Mixtures (*)
- (p) Manual of Test Procedures for Materials

* Refer to Appendix C of the Manual of Test Procedures for Materials for more information."

80281

415

RAILROAD PROTECTIVE LIABILITY INSURANCE (5 and 10) (BDE)

Effective: January 1, 2006

Description. Railroad Protective Liability and Property Damage Liability Insurance shall be carried according to Article 107.11 of the Standard Specifications, except the limits shall be a minimum of \$5,000,000 combined single limit per occurrence for bodily injury liability and property damage liability with an aggregate limit of \$10,000,000 over the life of the policy. A separate policy is required for each railroad unless otherwise noted.

NAMED INSURED & ADDRESS	NUMBER & SPEED OF PASSENGER TRAINS	NUMBER & SPEED OF FREIGHT TRAINS
BNSF RAILWAY COMPANY 2650 Lou Menk Drive Fort Worth, TX 76131-2830		4 @ 20 MPH
DOT/AAR No.: 069 680S RR Division: Chicago	RR Mile Post: 1.35 RR Sub-Division: First	
For Freight/Passenger Information Contact: David Johnson For Insurance Information Contact: Crystal Meyers		Phone: 763-782-3495 Phone: 817-352-3439

DOT/AAR No.:
RR Division:

RR Mile Post:
RR Sub-Division:

For Freight/Passenger Information Contact:
For Insurance Information Contact:

Phone:
Phone:

Approval of Insurance. The original and one certified copy of each required policy shall be submitted to the following address for approval:

Illinois Department of Transportation
Bureau of Design and Environment
2300 South Dirksen Parkway, Room 326
Springfield, Illinois 62764

416

The Contractor will be advised when the Department has received approval of the insurance from the railroad(s). Before any work begins on railroad right-of-way, the Contractor shall submit to the Engineer evidence that the required insurance has been approved by the railroad(s). The Contractor shall also provide the Engineer with the expiration date of each required policy.

Basis of Payment. Providing Railroad Protective Liability and Property Damage Liability Insurance will be paid for at the contract unit price per Lump Sum for RAILROAD PROTECTIVE LIABILITY INSURANCE.

80157

REINFORCEMENT BARS (BDE)

Effective: November 1, 2013

Revise the first and second paragraphs of Article 508.05 of the Standard Specifications to read:

“508.05 Placing and Securing. All reinforcement bars shall be placed and tied securely at the locations and in the configuration shown on the plans prior to the placement of concrete. Manual welding of reinforcement may only be permitted on precast concrete products as indicated in the current Bureau of Materials and Physical Research Policy Memorandum “Quality Control / Quality Assurance Program for Precast Concrete Products”, and for precast prestressed concrete products as indicated in the Department’s current “Manual for Fabrication of Precast Prestressed Concrete Products”. Reinforcement bars shall not be placed by sticking or floating into place or immediately after placement of the concrete.

Bars shall be tied at all intersections, except where the center to center dimension is less than 1 ft (300 mm) in each direction, in which case alternate intersections shall be tied. Molded plastic clips may be used in lieu of wire to secure bar intersections, but shall not be permitted in horizontal bar mats subject to construction foot traffic or to secure longitudinal bar laps. Plastic clips shall adequately secure the reinforcement bars, and shall permit the concrete to flow through and fully encase the reinforcement. Plastic clips may be recycled plastic, and shall meet the approval of the Engineer. The number of ties as specified shall be doubled for lap splices at the stage construction line of concrete bridge decks when traffic is allowed on the first completed stage during the pouring of the second stage.”

Revise the fifth paragraph of Article 508.05 of the Standard Specifications to read:

“Supports for reinforcement in bridge decks shall be metal. For all other concrete construction the supports shall be metal or plastic. Metal bar supports shall be made of cold-drawn wire, or other approved material and shall be either epoxy coated, galvanized or plastic tipped. When the reinforcement bars are epoxy coated, the metal supports shall be epoxy coated. Plastic supports may be recycled plastic. Supports shall be provided in sufficient number and spaced to provide the required clearances. Supports shall adequately support the reinforcement bars, and shall permit the concrete to flow through and fully encase the reinforcement. The legs of supports shall be spaced to allow an opening that is a minimum 1.33 times the nominal maximum aggregate size used in the concrete. Nominal maximum aggregate size is defined as the largest sieve which retains any of the aggregate sample particles. All supports shall meet the approval of the Engineer.”

Revise the first sentence of the eighth paragraph of Article 508.05 of the Standard Specifications to read:

“Epoxy coated reinforcement bars shall be tied with plastic coated wire, epoxy coated wire, or molded plastic clips where allowed.”

Add the following sentence to the end of the first paragraph of Article 508.06(c) of the Standard Specifications:

“In addition, the total slip of the bars within the splice sleeve of the connector after loading in tension to 30 ksi (207 MPa) and relaxing to 3 ksi (20.7 MPa) shall not exceed 0.01 in. (254 microns).”

Revise Article 1042.03(d) of the Standard Specifications to read:

“(d) Reinforcement and Accessories: The concrete cover over all reinforcement shall be within $\pm 1/4$ in. (± 6 mm) of the specified cover.

Welded wire fabric shall be accurately bent and tied in place.

Miscellaneous accessories to be cast into the concrete or for forming holes and recesses shall be carefully located and rigidly held in place by bolts, clamps, or other effective means. If paper tubes are used for vertical dowel holes, or other vertical holes which require grouting, they shall be removed before transportation to the construction site.”

80327

REMOVAL AND DISPOSAL OF REGULATED SUBSTANCES (BDE)

Effective: January 1, 2012

Revised: November 2, 2012

Revise Article 669.01 of the Standard Specifications to read:

“669.01 Description. This work shall consist of the transportation and proper disposal of contaminated soil and water. This work shall also consist of the removal, transportation, and proper disposal of underground storage tanks (UST), their content and associated underground piping to the point where the piping is above the ground, including determining the content types and estimated quantities.”

Revise Article 669.08 of the Standard Specifications to read:

“669.08 Contaminated Soil and/or Groundwater Monitoring. The Contractor shall hire a qualified environmental firm to monitor the area containing the regulated substances. The affected area shall be monitored with a photoionization detector (PID) utilizing a lamp of 10.6eV or greater or a flame ionization detector (FID). Any field screen reading on the PID or FID in excess of background levels indicates the potential presence of contaminated material requiring handling as a non-special waste, special waste, or hazardous waste. No excavated soils can be taken to a clean construction and demolition debris (CCDD) facility or an uncontaminated soil fill operation with detectable PID or FID meter readings that are above background. The PID or FID meter shall be calibrated on-site and background level readings taken and recorded daily. All testing shall be done by a qualified engineer/technician. Such testing and monitoring shall be included in the work. The Contractor shall identify the exact limits of removal of non-special waste, special waste, or hazardous waste. All limits shall be approved by the Engineer prior to excavation. The Contractor shall take all necessary precautions.

Based upon the land use history of the subject property and/or PID or FID readings indicating contamination, a soil or groundwater sample shall be taken from the same location and submitted to an approved laboratory. Soil or groundwater samples shall be analyzed for the contaminants of concern, including pH, based on the property's land use history or the parameters listed in the maximum allowable concentration (MAC) for chemical constituents in uncontaminated soil established pursuant to Subpart F of 35 Illinois Administrative Code 1100.605. The analytical results shall serve to document the level of soil contamination. Soil and groundwater samples may be required at the discretion of the Engineer to verify the level of soil and groundwater contamination.

Samples shall be grab samples (not combined with other locations). The samples shall be taken with decontaminated or disposable instruments. The samples shall be placed in sealed containers and transported in an insulated container to the laboratory. The container shall maintain a temperature of 39 °F (4 °C). All samples shall be clearly labeled. The labels shall indicate the sample number, date sampled, location and elevation, and any other observations.

The laboratory shall use analytical methods which are able to meet the lowest appropriate practical quantitation limits (PQL) or estimated quantitation limit (EQL) specified in "Test Methods for Evaluating Solid Wastes, Physical/Chemical Methods", EPA Publication No. SW-846 and "Methods for the Determination of Organic Compounds in Drinking Water", EPA, EMSL, EPA-600/4-88/039. For parameters where the specified cleanup objective is below the acceptable detection limit (ADL), the ADL shall serve as the cleanup objective. For other parameters the ADL shall be equal to or below the specified cleanup objective."

Replace the first two paragraphs of Article 669.09 of the Standard Specifications with the following:

"669.09 Contaminated Soil and/or Groundwater Management and Disposal. The management and disposal of contaminated soil and/or groundwater shall be according to the following:

- (a) Soil Analytical Results Exceed Most Stringent MAC. When the soil analytical results indicate that detected levels exceed the most stringent maximum allowable concentration (MAC) for chemical constituents in uncontaminated soil established pursuant to Subpart F of 35 Illinois Administrative Code 1100.605, the soil shall be managed as follows:
- (1) When analytical results indicate inorganic chemical constituents exceed the most stringent MAC but they are still considered within area background levels by the Engineer, the excavated soil can be utilized within the construction limits as fill, when suitable. Such soil excavated for storm sewers can be placed back into the excavated trench as backfill, when suitable, unless trench backfill is specified. If the soils cannot be utilized within the construction limits, they shall be managed and disposed of off-site as a non-special waste, special waste, or hazardous waste as applicable.
 - (2) When analytical results indicate chemical constituents exceed the most stringent MAC but do not exceed the MAC for a Metropolitan Statistical Area (MSA) County, the excavated soil can be utilized within the construction limits as fill, when suitable, or managed and disposed of off-site as "uncontaminated soil" at a CCDD facility or an uncontaminated soil fill operation within an MSA County provided the pH of the soil is within the range of 6.25 - 9.0, inclusive.
 - (3) When analytical results indicate chemical constituents exceed the most stringent MAC but do not exceed the MAC for an MSA County excluding Chicago, or the MAC within the Chicago corporate limits, the excavated soil can be utilized within the construction limits as fill, when suitable, or managed and disposed of off-site as "uncontaminated soil" at a CCDD facility or an uncontaminated soil fill operation within an MSA County excluding Chicago or within the Chicago corporate limits provided the pH of the soil is within the range of 6.25 - 9.0, inclusive.

- (4) When analytical results indicate chemical constituents exceed the most stringent MAC but do not exceed the MAC for an MSA County excluding Chicago, the excavated soil can be utilized within the construction limits as fill, when suitable, or managed and disposed of off-site as "uncontaminated soil" at a CCDD facility or an uncontaminated soil fill operation within an MSA County excluding Chicago provided the pH of the soil is within the range of 6.25 - 9.0, inclusive.
- (5) When the Engineer determines soil cannot be managed according to Articles 669.09(a)(1) through (a)(4) above, the soil shall be managed and disposed of off-site as a non-special waste, special waste, or hazardous waste as applicable.
- (b) Soil Analytical Results Do Not Exceed Most Stringent MAC. When the soil analytical results indicate that detected levels do not exceed the most stringent MAC but the pH of the soil is less than 6.25 or greater than 9.0, the excavated soil can be utilized within the construction limits or managed and disposed of off-site as "uncontaminated soil" according to Article 202.03. However the excavated soil cannot be taken to a CCDD facility or an uncontaminated soil fill operation.
- (c) Groundwater. When groundwater analytical results indicate the detected levels are above Appendix B, Table E of 35 Illinois Administrative Code 742, the most stringent Tier 1 Groundwater Remediation Objectives for Groundwater Component of the Groundwater Ingestion Route for Class 1 groundwater, the groundwater shall be managed off-site as a special waste.

All groundwater encountered within lateral trenches may be managed within the trench and allowed to infiltrate back into the ground. If the groundwater cannot be managed within the trench it must be removed as a special or hazardous waste. The Contractor is prohibited from managing groundwater within the trench by discharging it through any existing or new storm sewer. The Contractor shall install backfill plugs within the area of groundwater contamination.

One backfill plug shall be placed down gradient to the area of groundwater contamination. Backfill plugs shall be installed at intervals not to exceed 50 ft (15 m). Backfill plugs are to be 4 ft (1.2 m) long, measured parallel to the trench, full trench width and depth. Backfill plugs shall not have any fine aggregate bedding or backfill, but shall be entirely cohesive soil or any class of concrete. The Contractor shall provide test data that the material has a permeability of less than 10^{-7} cm/sec according to ASTM D 5084, Method A or per another test method approved by the Engineer."

Revise Article 669.14 of the Standard Specifications to read:

"669.14 Final Environmental Construction Report. At the end of the project, the Contractor will prepare and submit three copies of the Environmental Construction Report on the activities conducted during the life of the project, one copy shall be submitted to the Resident Engineer, one copy shall be submitted to the District's Environmental Studies Unit, and one copy shall be submitted with an electronic copy in Adode.pdf format to the Geologic

and Waste Assessment Unit, Bureau of Design and Environment, IDOT, 2300 South Dirksen Parkway, Springfield, Illinois 62764. The technical report shall include all pertinent information regarding the project including, but not limited to:

- (a) Measures taken to identify, monitor, handle, and dispose of soil or groundwater containing regulated substances, to prevent further migration of regulated substances, and to protect workers,
- (b) Cost of identifying, monitoring, handling, and disposing of soil or groundwater containing regulated substances, the cost of preventing further migration of regulated substances, and the cost for worker protection from the regulated substances. All cost should be in the format of the contract pay items listed in the contract plans (identified by the preliminary environmental site investigation (PESA) site number),
- (c) Plan sheets showing the areas containing the regulated substances,
- (d) Field sampling and testing results used to identify the nature and extent of the regulated substances,
- (e) Waste manifests (identified by the preliminary environmental site investigation (PESA) site number) for special or hazardous waste disposal, and
- (f) Landfill tickets (identified by the preliminary environmental site investigation (PESA) site number) for non-special waste disposal."

Revise the second paragraph of Article 669.16 of the Standard Specifications to read:

"The transportation and disposal of soil and other materials from an excavation determined to be contaminated will be paid for at the contract unit price per cubic yard (cubic meter) for NON-SPECIAL WASTE DISPOSAL, SPECIAL WASTE DISPOSAL, or HAZARDOUS WASTE DISPOSAL."

80283

REMOVAL AND DISPOSAL OF SURPLUS MATERIALS (BDE)

Effective: November 2, 2012

Revise the first four paragraphs of Article 202.03 of the Standard Specifications to read:

"202.03 Removal and Disposal of Surplus, Unstable, Unsuitable, and Organic Materials. Suitable excavated materials shall not be wasted without permission of the Engineer. The Contractor shall dispose of all surplus, unstable, unsuitable, and organic materials, in such a manner that public or private property will not be damaged or endangered.

Suitable earth, stones and boulders naturally occurring within the right-of-way may be placed in fills or embankments in lifts and compacted according to Section 205. Broken concrete without protruding metal bars, bricks, rock, stone, reclaimed asphalt pavement with no expansive aggregate, or uncontaminated dirt and sand generated from construction or demolition activities may be used in embankment or in fill. If used in fills or embankments, these materials shall be placed and compacted to the satisfaction of the Engineer; shall be buried under a minimum of 2 ft (600 mm) of earth cover (except when the materials include only uncontaminated dirt); and shall not create an unsightly appearance or detract from the natural topographic features of an area. Broken concrete without protruding metal bars, bricks, rock, or stone may be used as riprap as approved by the Engineer. If the materials are used for fill in locations within the right-of-way but outside project construction limits, the Contractor must specify to the Engineer, in writing, how the landscape restoration of the fill areas will be accomplished. Placement of fill in such areas shall not commence until the Contractor's landscape restoration plan is approved by the Engineer.

Aside from the materials listed above, all other construction and demolition debris or waste shall be disposed of in a licensed landfill, recycled, reused, or otherwise disposed of as allowed by State or Federal laws and regulations. When the Contractor chooses to dispose of uncontaminated soil at a clean construction and demolition debris (CCDD) facility or at an uncontaminated soil fill operation, it shall be the Contractor's responsibility to have the pH of the material tested to ensure the value is between 6.25 and 9.0, inclusive. A copy of the pH test results shall be provided to the Engineer.

A permit shall be obtained from IEPA and made available to the Engineer prior to open burning of organic materials (i.e., plant refuse resulting from pruning or removal of trees or shrubs) or other construction or demolition debris. Organic materials originating within the right-of-way limits may be chipped or shredded and placed as mulch around landscape plantings within the right-of-way when approved by the Engineer. Chipped or shredded material to be placed as mulch shall not exceed a depth of 6 in. (150 mm)."

80319

424

STEEL COST ADJUSTMENT (BDE) (RETURN FORM WITH BID)

Effective: April 2, 2004

Revised: April 1, 2009

Description. Steel cost adjustments will be made to provide additional compensation to the Contractor, or a credit to the Department, for fluctuations in steel prices when optioned by the Contractor. The bidder shall indicate on the attached form whether or not this special provision will be part of the contract and submit the completed form with his/her bid. Failure to submit the form or failure to indicate contract number, company name, and sign and date the form shall make this contract exempt of steel cost adjustments for all items of steel. Failure to indicate "Yes" for any item of work will make that item of steel exempt from steel cost adjustment.

Types of Steel Products. An adjustment will be made for fluctuations in the cost of steel used in the manufacture of the following items:

Metal Piling (excluding temporary sheet piling)
Structural Steel
Reinforcing Steel

Other steel materials such as dowel bars, tie bars, mesh reinforcement, guardrail, steel traffic signal and light poles, towers and mast arms, metal railings (excluding wire fence), and frames and grates will be subject to a steel cost adjustment when the pay items they are used in has a contract value of \$10,000 or greater.

Documentation. Sufficient documentation shall be furnished to the Engineer to verify the following:

- (a) The dates and quantity of steel, in lb (kg), shipped from the mill to the fabricator.
- (b) The quantity of steel, in lb (kg), incorporated into the various items of work covered by this special provision. The Department reserves the right to verify submitted quantities.

Method of Adjustment. Steel cost adjustments will be computed as follows:

$$SCA = Q \times D$$

Where: SCA = steel cost adjustment, in dollars
Q = quantity of steel incorporated into the work, in lb (kg)
D = price factor, in dollars per lb (kg)

$$D = MPI_M - MPI_L$$

Where: MPI_M = The Materials Cost Index for steel as published by the Engineering News-Record for the month the steel is shipped from the mill. The indices will be converted from dollars per 100 lb to dollars per lb (kg).

$MPI_L =$ The Materials Cost Index for steel as published by the Engineering News-Record for the month prior to the letting. The indices will be converted from dollars per 100 lb to dollars per lb (kg).

The unit weights (masses) of steel that will be used to calculate the steel cost adjustment for the various items are shown in the attached table.

No steel cost adjustment will be made for any products manufactured from steel having a mill shipping date prior to the letting date.

If the Contractor fails to provide the required documentation, the method of adjustment will be calculated as described above; however, the MPI_M will be based on the date the steel arrives at the job site. In this case, an adjustment will only be made when there is a decrease in steel costs.

Basis of Payment. Steel cost adjustments may be positive or negative but will only be made when there is a difference between the MPI_L and MPI_M in excess of five percent, as calculated by:

$$\text{Percent Difference} = \{(MPI_L - MPI_M) \div MPI_L\} \times 100$$

Steel cost adjustments will be calculated by the Engineer and will be paid or deducted when all other contract requirements for the items of work are satisfied. Adjustments will only be made for fluctuations in the cost of the steel as described herein. No adjustment will be made for changes in the cost of manufacturing, fabrication, shipping, storage, etc.

The adjustments shall not apply during contract time subject to liquidated damages for completion of the entire contract.

Attachment

Item	Unit Mass (Weight)
Metal Piling (excluding temporary sheet piling) Furnishing Metal Pile Shells 12 in. (305 mm), 0.179 in. (3.80 mm) wall thickness) Furnishing Metal Pile Shells 12 in. (305 mm), 0.250 in. (6.35 mm) wall thickness) Furnishing Metal Pile Shells 14 in. (356 mm), 0.250 in. (6.35 mm) wall thickness) Other piling	23 lb/ft (34 kg/m) 32 lb/ft (48 kg/m) 37 lb/ft (55 kg/m) See plans
Structural Steel	See plans for weights (masses)
Reinforcing Steel	See plans for weights (masses)
Dowel Bars and Tie Bars	6 lb (3 kg) each
Mesh Reinforcement	63 lb/100 sq ft (310 kg/sq m)
Guardrail Steel Plate Beam Guardrail, Type A w/steel posts Steel Plate Beam Guardrail, Type B w/steel posts Steel Plate Beam Guardrail, Types A and B w/wood posts Steel Plate Beam Guardrail, Type 2 Steel Plate Beam Guardrail, Type 6 Traffic Barrier Terminal, Type 1 Special (Tangent) Traffic Barrier Terminal, Type 1 Special (Flared)	20 lb/ft (30 kg/m) 30 lb/ft (45 kg/m) 8 lb/ft (12 kg/m) 305 lb (140 kg) each 1260 lb (570 kg) each 730 lb (330 kg) each 410 lb (185 kg) each
Steel Traffic Signal and Light Poles, Towers and Mast Arms Traffic Signal Post Light Pole, Tenon Mount and Twin Mount, 30 - 40 ft (9 - 12 m) Light Pole, Tenon Mount and Twin Mount, 45 - 55 ft (13.5 - 16.5 m) Light Pole w/Mast Arm, 30 - 50 ft (9 - 15.2 m) Light Pole w/Mast Arm, 55 - 60 ft (16.5 - 18 m) Light Tower w/Luminaire Mount, 80 - 110 ft (24 - 33.5 m) Light Tower w/Luminaire Mount, 120 - 140 ft (36.5 - 42.5 m) Light Tower w/Luminaire Mount, 150 - 160 ft (45.5 - 48.5 m)	11 lb/ft (16 kg/m) 14 lb/ft (21 kg/m) 21 lb/ft (31 kg/m) 13 lb/ft (19 kg/m) 19 lb/ft (28 kg/m) 31 lb/ft (46 kg/m) 65 lb/ft (97 kg/m) 80 lb/ft (119 kg/m)
Metal Railings (excluding wire fence) Steel Railing, Type SM Steel Railing, Type S-1 Steel Railing, Type T-1 Steel Bridge Rail	64 lb/ft (95 kg/m) 39 lb/ft (58 kg/m) 53 lb/ft (79 kg/m) 52 lb/ft (77 kg/m)
Frames and Grates Frame Lids and Grates	250 lb (115 kg) 150 lb (70 kg)

Return With Bid

**ILLINOIS DEPARTMENT
OF TRANSPORTATION**

**OPTION FOR
STEEL COST ADJUSTMENT**

The bidder shall submit this completed form with his/her bid. Failure to submit the form or properly complete contract number, company name, and sign and date the form shall make this contract exempt of steel cost adjustments for all items of steel. Failure to indicate "Yes" for any item of work will make that item of steel exempt from steel cost adjustment. After award, this form, when submitted shall become part of the contract.

Contract No.: _____

Company Name: _____

Contractor's Option:

Is your company opting to include this special provision as part of the contract plans for the following items of work?

- | | | |
|--|-----|--------------------------|
| Metal Piling | Yes | <input type="checkbox"/> |
| Structural Steel | Yes | <input type="checkbox"/> |
| Reinforcing Steel | Yes | <input type="checkbox"/> |
| Dowel Bars, Tie Bars and Mesh Reinforcement | Yes | <input type="checkbox"/> |
| Guardrail | Yes | <input type="checkbox"/> |
| Steel Traffic Signal and Light Poles, Towers and Mast Arms | Yes | <input type="checkbox"/> |
| Metal Railings (excluding wire fence) | Yes | <input type="checkbox"/> |
| Frames and Grates | Yes | <input type="checkbox"/> |

Signature: _____ **Date:** _____

80127

428

SUBCONTRACTOR MOBILIZATION PAYMENTS (BDE)

Effective: April 2, 2005

Revised: April 1, 2011

To account for the preparatory work and operations necessary for the movement of subcontractor personnel, equipment, supplies, and incidentals to the project site and for all other work or operations that must be performed or costs incurred when beginning work approved for subcontracting according to Article 108.01 of the Standard Specifications, the Contractor shall make a mobilization payment to each subcontractor.

This mobilization payment shall be made at least 14 days prior to the subcontractor starting work. The amount paid shall be equal to 3 percent of the amount of the subcontract reported on form BC 260A submitted for the approval of the subcontractor's work.

The mobilization payment to the subcontractor is an advance payment of the reported amount of the subcontract and is not a payment in addition to the amount of the subcontract; therefore, the amount of the advance payment will be deducted from future progress payments.

This provision shall be incorporated directly or by reference into each subcontract approved by the Department.

80143

TEMPORARY EROSION AND SEDIMENT CONTROL (BDE)

Effective: January 1, 2012

Revise the first paragraph of Article 280.04(f) of the Standard Specifications to read:

“(f) Temporary Erosion Control Seeding. This system consists of seeding all erodible/bare areas to minimize the amount of exposed surface area. Seed bed preparation will not be required if the surface of the soil is uniformly smooth and in a loose condition. Light disking shall be done if the soil is hard packed or caked. Erosion rills greater than 1 in. (25 mm) in depth shall be filled and area blended with the surrounding soil. Fertilizer nutrients will not be required.”

Delete the last sentence of Article 280.08(e) of the Standard Specifications.

80286

TRACKING THE USE OF PESTICIDES (BDE)

Effective: August 1, 2012

Add the following paragraph after the first paragraph of Article 107.23 of the Standard Specifications:

“Within 48 hours of the application of pesticides, including but not limited to herbicides, insecticides, algaecides, and fungicides, the Contractor shall complete and return to the Engineer, Operations form “OPER 2720”.”

80301

TRAFFIC CONTROL DEFICIENCY DEDUCTION (BDE)

Effective: August 1, 2011

Revise the third sentence of the third paragraph of Article 105.03(b) of the Standard Specifications to read:

“The daily monetary deduction will be \$2,500.”

80273

432

TRAINING SPECIAL PROVISIONS (BDE) This Training Special Provision supersedes Section 7b of the Special Provision entitled "Specific Equal Employment Opportunity Responsibilities," and is in implementation of 23 U.S.C. 140(a).

As part of the contractor's equal employment opportunity affirmative action program, training shall be provided as follows:

The contractor shall provide on-the-job training aimed at developing full journeyman in the type of trade or job classification involved. The number of trainees to be trained under this contract will be 3. In the event the contractor subcontracts a portion of the contract work, he shall determine how many, if any, of the trainees are to be trained by the subcontractor, provided however, that the contractor shall retain the primary responsibility for meeting the training requirements imposed by this special provision. The contractor shall also insure that this Training Special Provision is made applicable to such subcontract. Where feasible, 25 percent of apprentices or trainees in each occupation shall be in their first year of apprenticeship or training.

The number of trainees shall be distributed among the work classifications on the basis of the contractor's needs and the availability of journeymen in the various classifications within the reasonable area of recruitment. Prior to commencing construction, the contractor shall submit to the Illinois Department of Transportation for approval the number of trainees to be trained in each selected classification and training program to be used. Furthermore, the contractor shall specify the starting time for training in each of the classifications. The contractor will be credited for each trainee employed by him on the contract work who is currently enrolled or becomes enrolled in an approved program and will be reimbursed for such trainees as provided hereinafter.

Training and upgrading of minorities and women toward journeyman status is a primary objective of this Training Special Provision. Accordingly, the contractor shall make every effort to enroll minority trainees and women (e.g. by conducting systematic and direct recruitment through public and private sources likely to yield minority and women trainees) to the extent such persons are available within a reasonable area of recruitment. The contractor will be responsible for demonstrating the steps that he has taken in pursuance thereof, prior to a determination as to whether the contractor is in compliance with this Training Special Provision. This training commitment is not intended, and shall not be used, to discriminate against any applicant for training, whether a member of a minority group or not.

No employee shall be employed as a trainee in any classification in which he has successfully completed a training course leading to journeyman status or in which he has been employed as a journeyman. The contractor should satisfy this requirement by including appropriate questions in the employee application or by other suitable means. Regardless of the method used the contractor's records should document the findings in each case.

The minimum length and type of training for each classification will be as established in the training program selected by the contractor and approved by the Illinois Department of Transportation and the Federal Highway Administration. The Illinois Department of Transportation and the Federal Highway Administration shall approve a program, if it is reasonably calculated to meet the equal employment opportunity obligations of the contractor and to qualify the average trainee for journeyman status in the classification concerned by the end of the training period. Furthermore, apprenticeship programs registered with the U.S. Department of Labor, Bureau of Apprenticeship and Training, or with a State apprenticeship agency recognized by the Bureau and training programs approved by not necessarily sponsored by the U.S. Department of Labor, Manpower Administration, Bureau of Apprenticeship and Training shall also be considered acceptable provided it is being administered in a manner consistent with the equal employment obligations of Federal-aid highway construction contracts. Approval or acceptance of a training program shall be obtained from the State prior to commencing work on the classification covered by the program. It is the intention of these provisions that training is to be provided in the construction crafts rather than clerk-typists or secretarial-type positions. Training is permissible in lower level management positions such as office engineers, estimators, timekeepers, etc., where the training is oriented toward construction applications. Training in the laborer classification may be permitted provided that significant and meaningful training is provided and approved by the Illinois Department of Transportation and the Federal Highway Administration. Some offsite training is permissible as long as the training is an integral part of an approved training program and does not comprise a significant part of the overall training.

Except as otherwise noted below, the contractor will be reimbursed 80 cents per hour of training given an employee on this contract in accordance with an approved training program. As approved by the Engineer, reimbursement will be made for training of persons in excess of the number specified herein. This reimbursement will be made even though the contractor receives additional training program funds from other sources, provided such other source does not specifically prohibit the contractor from receiving other reimbursement. Reimbursement for offsite training indicated above may only be made to the contractor where he does one or more of the following and the trainees are concurrently employed on a Federal-aid project; contributes to the cost of the training, provides the instruction to the trainee or pays the trainee's wages during the offsite training period.

No payment shall be made to the contractor if either the failure to provide the required training, or the failure to hire the trainee as a journeyman, is caused by the contractor and evidences a lack of good faith on the part of the contractor in meeting the requirement of this Training Special Provision. It is normally expected that a trainee will begin his training on the project as soon as feasible after start of work utilizing the skill involved and remain on the project as long as training opportunities exist in his work classification or until he has completed his training program.

It is not required that all trainees be on board for the entire length of the contract. A contractor will have fulfilled his responsibilities under this Training Special Provision if he has provided acceptable training to the number of trainees specified. The number trained shall be determined on the basis of the total number enrolled on the contract for a significant period.

Trainees will be paid at least 60 percent of the appropriate minimum journeyman's rate specified in the contract for the first half of the training period, 75 percent for the third quarter of the training period, and 90 percent for the last quarter of the training period, unless apprentices or trainees in an approved existing program are enrolled as trainees on this project. In that case, the appropriate rates approved by the Departments of Labor or Transportation in connection with the existing program shall apply to all trainees being trained for the same classification who are covered by this Training Special Provision.

The contractor shall furnish the trainee a copy of the program he will follow in providing the training. The contractor shall provide each trainee with a certification showing the type and length of training satisfactorily complete.

The contractor will provide for the maintenance of records and furnish periodic reports documenting his performance under this Training Special Provision.

METHOD OF MEASUREMENT The unit of measurement is in hours.

BASIS OF PAYMENT This work will be paid for at the contract unit price of 80 cents per hour for TRAINEES. The estimated total number of hours, unit price and total price have been included in the schedule of prices.

20338

435

WARM MIX ASPHALT (BDE)

Effective: January 1, 2012

Revised: November 1, 2013

Description. This work shall consist of designing, producing and constructing Warm Mix Asphalt (WMA) in lieu of Hot Mix Asphalt (HMA) at the Contractor's option. Work shall be according to Sections 406, 407, 408, 1030, and 1102 of the Standard Specifications, except as modified herein. In addition, any references to HMA in the Standard Specifications, or the special provisions shall be construed to include WMA.

WMA is an asphalt mixture which can be produced at temperatures lower than allowed for HMA utilizing approved WMA technologies. WMA technologies are defined as the use of additives or processes which allow a reduction in the temperatures at which HMA mixes are produced and placed. WMA is produced by the use of additives, a water foaming process, or combination of both. Additives include minerals, chemicals or organics incorporated into the asphalt binder stream in a dedicated delivery system. The process of foaming injects water into the asphalt binder stream, just prior to incorporation of the asphalt binder with the aggregate.

Approved WMA technologies may also be used in HMA provided all the requirements specified herein, with the exception of temperature, are met. However, asphalt mixtures produced at temperatures in excess of 275 °F (135 °C) will not be considered WMA when determining the grade reduction of the virgin asphalt binder grade.

Materials.

Add the following to Article 1030.02 of the Standard Specifications.

"(h) Warm Mix Asphalt (WMA) Technologies (Note 3)"

Add the following note to Article 1030.02 of the Standard Specifications.

"Note 3. Warm mix additives or foaming processes shall be selected from the current Bureau of Materials and Physical Research Approved List, "Warm-Mix Asphalt Technologies"."

Equipment.

Revise the first paragraph of Article 1102.01 of the Standard Specifications to read:

"1102.01 Hot-Mix Asphalt Plant. The hot-mix asphalt (HMA) plant shall be the batch-type, continuous-type, or dryer drum plant. The plants shall be evaluated for prequalification rating and approval to produce HMA according to the current Bureau of Materials and Physical Research Policy Memorandum, "Approval of Hot-Mix Asphalt Plants and Equipment". Once approved, the Contractor shall notify the Bureau of Materials and Physical Research to obtain approval of all plant modifications. The plants shall not be used to produce mixtures concurrently for more than one project or for private work unless permission is granted in writing

436

by the Engineer. The plant units shall be so designed, coordinated and operated that they will function properly and produce HMA having uniform temperatures and compositions within the tolerances specified. The plant units shall meet the following requirements.”

Add the following to Article 1102.01(a) of the Standard Specifications.

“(13) Equipment for Warm Mix Technologies.

- a. Foaming. Metering equipment for foamed asphalt shall have an accuracy of ± 2 percent of the actual water metered. The foaming control system shall be electronically interfaced with the asphalt binder meter.
- b. Additives. Additives shall be introduced into the plant according to the supplier’s recommendations and shall be approved by the Engineer. The system for introducing the WMA additive shall be interlocked with the aggregate feed or weigh system to maintain correct proportions for all rates of production and batch sizes.”

Mix Design Verification.

Add the following to Article 1030.04 of the Standard Specifications.

“(e) Warm Mix Technologies.

- (1) Foaming. WMA mix design verification will not be required when foaming technology is used alone (without WMA additives). However, the foaming technology shall only be used on HMA designs previously approved by the Department.
- (2) Additives. WMA mix designs utilizing additives shall be submitted to the Engineer for mix design verification.

Production.

Revise the second paragraph of Article 1030.06(a) of the Standard Specifications to read:

“At the start of mix production for HMA, WMA, and HMA using WMA technologies, QC/QA mixture start-up will be required for the following situations; at the beginning of production of a new mixture design, at the beginning of each production season, and at every plant utilized to produce mixtures, regardless of the mix.”

Quality Control/Quality Assurance Testing.

Revise the table in Article 1030.05(d)(2)a. of the Standard Specifications to read:

Parameter	Frequency of Tests		Test Method See Manual of Test Procedures for Materials
	High ESAL Mixture Low ESAL Mixture	All Other Mixtures	
Aggregate Gradation % passing sieves: 1/2 in. (12.5 mm), No. 4 (4.75 mm), No. 8 (2.36 mm), No. 30 (600 μm) No. 200 (75 μm) Note 1.	1 washed ignition oven test on the mix per half day of production Note 4.	1 washed ignition oven test on the mix per day of production Note 4.	Illinois Procedure
Asphalt Binder Content by Ignition Oven Note 2.	1 per half day of production	1 per day	Illinois-Modified AASHTO T 308
VMA Note 3.	Day's production ≥ 1200 tons: 1 per half day of production Day's production < 1200 tons: 1 per half day of production for first 2 days and 1 per day thereafter (first sample of the day)	N/A	Illinois-Modified AASHTO R 35
Air Voids Bulk Specific Gravity of Gyrotory Sample Note 5.	Day's production ≥ 1200 tons: 1 per half day of production Day's production < 1200 tons: 1 per half day of production for first 2 days and 1 per day thereafter (first sample of the day)	1 per day	Illinois-Modified AASHTO T 312
Maximum Specific Gravity of Mixture	Day's production ≥ 1200 tons: 1 per half day of production Day's production < 1200 tons: 1 per half day of production for first 2 days and 1 per	1 per day	Illinois-Modified AASHTO T 209

Parameter	Frequency of Tests	Frequency of Tests	Test Method See Manual of Test Procedures for Materials
	High ESAL Mixture Low ESAL Mixture	All Other Mixtures	
	day thereafter (first sample of the day)		

Note 1. The No. 8 (2.36 mm) and No. 30 (600 μ m) sieves are not required for All Other Mixtures.

Note 2. The Engineer may waive the ignition oven requirement for asphalt binder content if the aggregates to be used are known to have ignition asphalt binder content calibration factors which exceed 1.5 percent. If the ignition oven requirement is waived, other Department approved methods shall be used to determine the asphalt binder content.

Note 3. The G_{sb} used in the voids in the mineral aggregate (VMA) calculation shall be the same average G_{sb} value listed in the mix design.

Note 4. The Engineer reserves the right to require additional hot bin gradations for batch

Note 5. The WMA compaction temperature for mixture volumetric testing shall be 270 ± 5 °F (132 ± 3 °C) for quality control testing. The WMA compaction temperature for quality assurance testing will be 270 ± 5 °F (132 ± 3 °C) if the mixture is not allowed to cool to room temperature. If the mixture is allowed to cool to room temperature it shall be reheated to standard HMA compaction temperatures.”

Construction Requirements.

Revise the second paragraph of Article 406.06(b)(1) of the Standard Specifications to read:

“The HMA shall be delivered at a temperature of 250 to 350 °F (120 to 175 °C). WMA shall be delivered at a minimum temperature of 215 °F (102 °C).”

Basis of Payment.

This work will be paid at the contract unit price bid for the HMA pay items involved. Anti-strip will not be paid for separately, but shall be considered as included in the cost of the work.

80288

WEEKLY DBE TRUCKING REPORTS (BDE)

Effective: June 2, 2012

The Contractor shall provide a weekly report of Disadvantaged Business Enterprise (DBE) trucks hired by the Contractor or subcontractors (i.e. not owned by the Contractor or subcontractors) that are used on the jobsite; or used for the delivery and/or removal of equipment/material to and from the jobsite. The jobsite shall also include offsite locations, such as plant sites or storage sites, when those locations are used solely for this contract.

The report shall be submitted on the form provided by the Department within ten business days following the reporting period. The reporting period shall be Monday through Sunday for each week reportable trucking activities occur. The report shall be submitted to the Engineer and a copy shall be provided to the district EEO Officer.

Any costs associated with providing weekly DBE trucking reports shall be considered as included in the contract unit prices bid for the various items of work involved and no additional compensation will be allowed.

80302

44-0

REQUIRED CONTRACT PROVISIONS FEDERAL-AID CONSTRUCTION CONTRACTS

- I. General
- II. Nondiscrimination
- III. Nonsegregated Facilities
- IV. Davis-Bacon and Related Act Provisions
- V. Contract Work Hours and Safety Standards Act Provisions
- VI. Subletting or Assigning the Contract
- VII. Safety: Accident Prevention
- VIII. False Statements Concerning Highway Projects
- IX. Implementation of Clean Air Act and Federal Water Pollution Control Act
- X. Compliance with Governmentwide Suspension and Debarment Requirements
- XI. Certification Regarding Use of Contract Funds for Lobbying

ATTACHMENTS

A. Employment and Materials Preference for Appalachian Development Highway System or Appalachian Local Access Road Contracts (included in Appalachian contracts only)

I. GENERAL

1. Form FHWA-1273 must be physically incorporated in each construction contract funded under Title 23 (excluding emergency contracts solely intended for debris removal). The contractor (or subcontractor) must insert this form in each subcontract and further require its inclusion in all lower tier subcontracts (excluding purchase orders, rental agreements and other agreements for supplies or services).

The applicable requirements of Form FHWA-1273 are incorporated by reference for work done under any purchase order, rental agreement or agreement for other services. The prime contractor shall be responsible for compliance by any subcontractor, lower-tier subcontractor or service provider.

Form FHWA-1273 must be included in all Federal-aid design-build contracts, in all subcontracts and in lower tier subcontracts (excluding subcontracts for design services, purchase orders, rental agreements and other agreements for supplies or services). The design-builder shall be responsible for compliance by any subcontractor, lower-tier subcontractor or service provider.

Contracting agencies may reference Form FHWA-1273 in bid proposal or request for proposal documents, however, the Form FHWA-1273 must be physically incorporated (not referenced) in all contracts, subcontracts and lower-tier subcontracts (excluding purchase orders, rental agreements and other agreements for supplies or services related to a construction contract).

2. Subject to the applicability criteria noted in the following sections, these contract provisions shall apply to all work performed on the contract by the contractor's own organization and with the assistance of workers under the contractor's immediate superintendence and to all work performed on the contract by piecework, station work, or by subcontract.

3. A breach of any of the stipulations contained in these Required Contract Provisions may be sufficient grounds for withholding of progress payments, withholding of final payment, termination of the contract, suspension / debarment or any other action determined to be appropriate by the contracting agency and FHWA.

4. Selection of Labor: During the performance of this contract, the contractor shall not use convict labor for any purpose within the limits of a construction project on a Federal-aid highway unless it is labor performed by convicts who are on parole, supervised release, or probation. The term Federal-aid highway does not include roadways functionally classified as local roads or rural minor collectors.

II. NONDISCRIMINATION

The provisions of this section related to 23 CFR Part 230 are applicable to all Federal-aid construction contracts and to all related construction subcontracts of \$10,000 or more. The provisions of 23 CFR Part 230 are not applicable to material supply, engineering, or architectural service contracts.

In addition, the contractor and all subcontractors must comply with the following policies: Executive Order 11246, 41 CFR 60, 29 CFR 1625-1627, Title 23 USC Section 140, the Rehabilitation Act of 1973, as amended (29 USC 794), Title VI of the Civil Rights Act of 1964, as amended, and related regulations including 49 CFR Parts 21, 26 and 27; and 23 CFR Parts 200, 230, and 633.

The contractor and all subcontractors must comply with: the requirements of the Equal Opportunity Clause in 41 CFR 60-1.4(b) and, for all construction contracts exceeding \$10,000, the Standard Federal Equal Employment Opportunity Construction Contract Specifications in 41 CFR 60-4.3.

Note: The U.S. Department of Labor has exclusive authority to determine compliance with Executive Order 11246 and the policies of the Secretary of Labor including 41 CFR 60, and 29 CFR 1625-1627. The contracting agency and the FHWA have the authority and the responsibility to ensure compliance with Title 23 USC Section 140, the Rehabilitation Act of 1973, as amended (29 USC 794), and Title VI of the Civil Rights Act of 1964, as amended, and related regulations including 49 CFR Parts 21, 26 and 27; and 23 CFR Parts 200, 230, and 633.

The following provision is adopted from 23 CFR 230, Appendix A, with appropriate revisions to conform to the U.S. Department of Labor (US DOL) and FHWA requirements.

1. Equal Employment Opportunity: Equal employment opportunity (EEO) requirements not to discriminate and to take affirmative action to assure equal opportunity as set forth under laws, executive orders, rules, regulations (28 CFR 35, 29 CFR 1630, 29 CFR 1625-1627, 41 CFR 60 and 49 CFR 27) and orders of the Secretary of Labor as modified by the provisions prescribed herein, and imposed pursuant to 23 U.S.C. 140 shall constitute the EEO and specific affirmative action standards for the contractor's project activities under this contract. The provisions of the Americans with Disabilities Act of 1990 (42 U.S.C. 12101 et seq.) set forth under 28 CFR 35 and 29 CFR 1630 are incorporated by reference in this contract. In the execution of this contract, the contractor agrees to comply with the following minimum specific requirement activities of EEO:

a. The contractor will work with the contracting agency and the Federal Government to ensure that it has made every good faith effort to provide equal opportunity with respect to all of its terms and conditions of employment and in their review of activities under the contract.

b. The contractor will accept as its operating policy the following statement:

"It is the policy of this Company to assure that applicants are employed, and that employees are treated during employment, without regard to their race, religion, sex, color, national origin, age or disability. Such action shall include: employment, upgrading, demotion, or transfer; recruitment or recruitment advertising; layoff or termination; rates of pay or other forms of compensation; and selection for training, including apprenticeship, pre-apprenticeship, and/or on-the-job training."

2. EEO Officer: The contractor will designate and make known to the contracting officers an EEO Officer who will have the responsibility for and must be capable of effectively administering and promoting an active EEO program and who must be assigned adequate authority and responsibility to do so.

3. Dissemination of Policy: All members of the contractor's staff who are authorized to hire, supervise, promote, and discharge employees, or who recommend such action, or who are substantially involved in such action, will be made fully cognizant of, and will implement, the contractor's EEO policy and contractual responsibilities to provide EEO in each grade and classification of employment. To ensure that the above agreement will be met, the following actions will be taken as a minimum:

a. Periodic meetings of supervisory and personnel office employees will be conducted before the start of work and then not less often than once every six months, at which time the contractor's EEO policy and its implementation will be reviewed and explained. The meetings will be conducted by the EEO Officer.

b. All new supervisory or personnel office employees will be given a thorough indoctrination by the EEO Officer, covering all major aspects of the contractor's EEO obligations within thirty days following their reporting for duty with the contractor.

c. All personnel who are engaged in direct recruitment for the project will be instructed by the EEO Officer in the contractor's procedures for locating and hiring minorities and women.

d. Notices and posters setting forth the contractor's EEO policy will be placed in areas readily accessible to employees, applicants for employment and potential employees.

e. The contractor's EEO policy and the procedures to implement such policy will be brought to the attention of employees by means of meetings, employee handbooks, or other appropriate means.

4. Recruitment: When advertising for employees, the contractor will include in all advertisements for employees the notation: "An Equal Opportunity Employer." All such advertisements will be placed in publications having a large circulation among minorities and women in the area from which the project work force would normally be derived.

a. The contractor will, unless precluded by a valid bargaining agreement, conduct systematic and direct recruitment through public and private employee referral sources likely to yield qualified minorities and women. To meet this requirement, the contractor will identify sources of potential minority group employees, and establish with such identified sources procedures whereby minority and women applicants may be referred to the contractor for employment consideration.

b. In the event the contractor has a valid bargaining agreement providing for exclusive hiring hall referrals, the contractor is expected to observe the provisions of that agreement to the extent that the system meets the contractor's compliance with EEO contract provisions. Where implementation of such an agreement has the effect of discriminating against minorities or women, or obligates the contractor to do the same, such implementation violates Federal nondiscrimination provisions.

c. The contractor will encourage its present employees to refer minorities and women as applicants for employment. Information and procedures with regard to referring such applicants will be discussed with employees.

5. Personnel Actions: Wages, working conditions, and employee benefits shall be established and administered, and personnel actions of every type, including hiring, upgrading, promotion, transfer, demotion, layoff, and termination, shall be taken without regard to race, color, religion, sex, national origin, age or disability. The following procedures shall be followed:

a. The contractor will conduct periodic inspections of project sites to insure that working conditions and employee facilities do not indicate discriminatory treatment of project site personnel.

b. The contractor will periodically evaluate the spread of wages paid within each classification to determine any evidence of discriminatory wage practices.

c. The contractor will periodically review selected personnel actions in depth to determine whether there is evidence of discrimination. Where evidence is found, the contractor will promptly take corrective action. If

the review indicates that the discrimination may extend beyond the actions reviewed, such corrective action shall include all affected persons.

d. The contractor will promptly investigate all complaints of alleged discrimination made to the contractor in connection with its obligations under this contract, will attempt to resolve such complaints, and will take appropriate corrective action within a reasonable time. If the investigation indicates that the discrimination may affect persons other than the complainant, such corrective action shall include such other persons. Upon completion of each investigation, the contractor will inform every complainant of all of their avenues of appeal.

6. Training and Promotion:

a. The contractor will assist in locating, qualifying, and increasing the skills of minorities and women who are applicants for employment or current employees. Such efforts should be aimed at developing full journey level status employees in the type of trade or job classification involved.

b. Consistent with the contractor's work force requirements and as permissible under Federal and State regulations, the contractor shall make full use of training programs, i.e., apprenticeship, and on-the-job training programs for the geographical area of contract performance. In the event a special provision for training is provided under this contract, this subparagraph will be superseded as indicated in the special provision. The contracting agency may reserve training positions for persons who receive welfare assistance in accordance with 23 U.S.C. 140(a).

c. The contractor will advise employees and applicants for employment of available training programs and entrance requirements for each.

d. The contractor will periodically review the training and promotion potential of employees who are minorities and women and will encourage eligible employees to apply for such training and promotion.

7. Unions: If the contractor relies in whole or in part upon unions as a source of employees, the contractor will use good faith efforts to obtain the cooperation of such unions to increase opportunities for minorities and women. Actions by the contractor, either directly or through a contractor's association acting as agent, will include the procedures set forth below:

a. The contractor will use good faith efforts to develop, in cooperation with the unions, joint training programs aimed toward qualifying more minorities and women for membership in the unions and increasing the skills of minorities and women so that they may qualify for higher paying employment.

b. The contractor will use good faith efforts to incorporate an EEO clause into each union agreement to the end that such union will be contractually bound to refer applicants without regard to their race, color, religion, sex, national origin, age or disability.

c. The contractor is to obtain information as to the referral practices and policies of the labor union except that to the extent such information is within the exclusive possession of the labor union and such labor union refuses to furnish such information to the contractor, the contractor shall so certify to the contracting agency and shall set forth what efforts have been made to obtain such information.

d. In the event the union is unable to provide the contractor with a reasonable flow of referrals within the time limit set forth in the collective bargaining agreement, the contractor will, through independent recruitment efforts, fill the employment vacancies without regard to race, color, religion, sex, national origin, age or disability; making full efforts to obtain qualified and/or qualifiable minorities and women. The failure of a union to provide sufficient referrals (even though it is obligated to provide exclusive referrals under the terms of a collective bargaining agreement) does not relieve the contractor from the requirements of this paragraph. In the event the union referral practice prevents the contractor from meeting the obligations pursuant to Executive Order 11246, as amended, and these special provisions, such contractor shall immediately notify the contracting agency.

8. Reasonable Accommodation for Applicants / Employees with Disabilities: The contractor must be familiar with the requirements for and comply with the Americans with Disabilities Act and all rules and regulations established there under. Employers must provide reasonable accommodation in all employment activities unless to do so would cause an undue hardship.

9. Selection of Subcontractors, Procurement of Materials and Leasing of Equipment: The contractor shall not discriminate on the grounds of race, color, religion, sex, national origin, age or disability in the selection and retention of subcontractors, including procurement of materials and leases of equipment. The contractor shall take all necessary and reasonable steps to ensure nondiscrimination in the administration of this contract.

a. The contractor shall notify all potential subcontractors and suppliers and lessors of their EEO obligations under this contract.

b. The contractor will use good faith efforts to ensure subcontractor compliance with their EEO obligations.

10. Assurance Required by 49 CFR 26.13(b):

a. The requirements of 49 CFR Part 26 and the State DOT's U.S. DOT-approved DBE program are incorporated by reference.

b. The contractor or subcontractor shall not discriminate on the basis of race, color, national origin, or sex in the performance of this contract. The contractor shall carry out applicable requirements of 49 CFR Part 26 in the award and administration of DOT-assisted contracts. Failure by the contractor to carry out these requirements is a material breach of this contract, which may result in the termination of this contract or such other remedy as the contracting agency deems appropriate.

11. Records and Reports: The contractor shall keep such records as necessary to document compliance with the EEO requirements. Such records shall be retained for a period of three years following the date of the final payment to the contractor for all contract work and shall be available at reasonable times and places for inspection by authorized representatives of the contracting agency and the FHWA.

a. The records kept by the contractor shall document the following:

(1) The number and work hours of minority and non-minority group members and women employed in each work classification on the project;

(2) The progress and efforts being made in cooperation with unions, when applicable, to increase employment opportunities for minorities and women; and

(3) The progress and efforts being made in locating, hiring, training, qualifying, and upgrading minorities and women;

b. The contractors and subcontractors will submit an annual report to the contracting agency each July for the duration of the project, indicating the number of minority, women, and non-minority group employees currently engaged in each work classification required by the contract work. This information is to be reported on [Form FHWA-1391](#). The staffing data should represent the project work force on board in all or any part of the last payroll period preceding the end of July. If on-the-job training is being required by special provision, the contractor will be required to collect and report training data. The employment data should reflect the work force on board during all or any part of the last payroll period preceding the end of July.

III. NONSEGREGATED FACILITIES

This provision is applicable to all Federal-aid construction contracts and to all related construction subcontracts of \$10,000 or more.

The contractor must ensure that facilities provided for employees are provided in such a manner that segregation on the basis of race, color,

religion, sex, or national origin cannot result. The contractor may neither require such segregated use by written or oral policies nor tolerate such use by employee custom. The contractor's obligation extends further to ensure that its employees are not assigned to perform their services at any location, under the contractor's control, where the facilities are segregated. The term "facilities" includes waiting rooms, work areas, restaurants and other eating areas, time clocks, restrooms, washrooms, locker rooms, and other storage or dressing areas, parking lots, drinking fountains, recreation or entertainment areas, transportation, and housing provided for employees. The contractor shall provide separate or single-user restrooms and necessary dressing or sleeping areas to assure privacy between sexes.

IV. Davis-Bacon and Related Act Provisions

This section is applicable to all Federal-aid construction projects exceeding \$2,000 and to all related subcontracts and lower-tier subcontracts (regardless of subcontract size). The requirements apply to all projects located within the right-of-way of a roadway that is functionally classified as Federal-aid highway. This excludes roadways functionally classified as local roads or rural minor collectors, which are exempt. Contracting agencies may elect to apply these requirements to other projects.

The following provisions are from the U.S. Department of Labor regulations in 29 CFR 5.5 "Contract provisions and related matters" with minor revisions to conform to the FHWA-1273 format and FHWA program requirements.

1. Minimum wages

a. All laborers and mechanics employed or working upon the site of the work, will be paid unconditionally and not less often than once a week, and without subsequent deduction or rebate on any account (except such payroll deductions as are permitted by regulations issued by the Secretary of Labor under the Copeland Act (29 CFR part 3)), the full amount of wages and bona fide fringe benefits (or cash equivalents thereof) due at time of payment computed at rates not less than those contained in the wage determination of the Secretary of Labor which is attached hereto and made a part hereof, regardless of any contractual relationship which may be alleged to exist between the contractor and such laborers and mechanics.

Contributions made or costs reasonably anticipated for bona fide fringe benefits under section 1(b)(2) of the Davis-Bacon Act on behalf of laborers or mechanics are considered wages paid to such laborers or mechanics, subject to the provisions of paragraph 1.d. of this section; also, regular contributions made or costs incurred for more than a weekly period (but not less often than quarterly) under plans, funds, or programs which cover the particular weekly period, are deemed to be constructively made or incurred during such weekly period. Such laborers and mechanics shall be paid the appropriate wage rate and fringe benefits on the wage determination for the classification of work actually performed, without regard to skill, except as provided in 29 CFR 5.5(a)(4). Laborers or mechanics performing work in more than one classification may be compensated at the rate specified for each classification for the time actually worked therein: Provided, That the employer's payroll records accurately set forth the time spent in each classification in which work is performed. The wage determination (including any additional classification and wage rates conformed under paragraph 1.b. of this section) and the Davis-Bacon poster (WH-1321) shall be posted at all times by the contractor and its subcontractors at the site of the work in a prominent and accessible place where it can be easily seen by the workers.

b.(1) The contracting officer shall require that any class of laborers or mechanics, including helpers, which is not listed in the wage determination and which is to be employed under the contract shall be classified in conformance with the wage determination. The contracting officer shall approve an additional classification and wage rate and fringe benefits therefore only when the following criteria have been met:

(i) The work to be performed by the classification requested is not performed by a classification in the wage determination; and

(ii) The classification is utilized in the area by the construction industry; and

(iii) The proposed wage rate, including any bona fide fringe benefits, bears a reasonable relationship to the wage rates contained in the wage determination.

(2) If the contractor and the laborers and mechanics to be employed in the classification (if known), or their representatives, and the contracting officer agree on the classification and wage rate (including the amount designated for fringe benefits where appropriate), a report of the action taken shall be sent by the contracting officer to the Administrator of the Wage and Hour Division, Employment Standards Administration, U.S. Department of Labor, Washington, DC 20210. The Administrator, or an authorized representative, will approve, modify, or disapprove every additional classification action within 30 days of receipt and so advise the contracting officer or will notify the contracting officer within the 30-day period that additional time is necessary.

(3) In the event the contractor, the laborers or mechanics to be employed in the classification or their representatives, and the contracting officer do not agree on the proposed classification and wage rate (including the amount designated for fringe benefits, where appropriate), the contracting officer shall refer the questions, including the views of all interested parties and the recommendation of the contracting officer, to the Wage and Hour Administrator for determination. The Wage and Hour Administrator, or an authorized representative, will issue a determination within 30 days of receipt and so advise the contracting officer or will notify the contracting officer within the 30-day period that additional time is necessary.

(4) The wage rate (including fringe benefits where appropriate) determined pursuant to paragraphs 1.b.(2) or 1.b.(3) of this section, shall be paid to all workers performing work in the classification under this contract from the first day on which work is performed in the classification.

c. Whenever the minimum wage rate prescribed in the contract for a class of laborers or mechanics includes a fringe benefit which is not expressed as an hourly rate, the contractor shall either pay the benefit as stated in the wage determination or shall pay another bona fide fringe benefit or an hourly cash equivalent thereof.

d. If the contractor does not make payments to a trustee or other third person, the contractor may consider as part of the wages of any laborer or mechanic the amount of any costs reasonably anticipated in providing bona fide fringe benefits under a plan or program, Provided, That the Secretary of Labor has found, upon the written request of the contractor, that the applicable standards of the Davis-Bacon Act have been met. The Secretary of Labor may require the contractor to set aside in a separate account assets for the meeting of obligations under the plan or program.

2. Withholding

The contracting agency shall upon its own action or upon written request of an authorized representative of the Department of Labor, withhold or cause to be withheld from the contractor under this contract, or any other Federal contract with the same prime contractor, or any other federally-assisted contract subject to Davis-Bacon prevailing wage requirements, which is held by the same prime contractor, so much of the accrued payments or advances as may be considered necessary to pay laborers and mechanics, including apprentices, trainees, and helpers, employed by the contractor or any subcontractor the full amount of wages required by the contract. In the event of failure to pay any laborer or mechanic, including any apprentice, trainee, or helper, employed or working on the site of the work, all or part of the wages required by the contract, the contracting agency may, after written notice to the contractor, take such

action as may be necessary to cause the suspension of any further payment, advance, or guarantee of funds until such violations have ceased.

3. Payrolls and basic records

a. Payrolls and basic records relating thereto shall be maintained by the contractor during the course of the work and preserved for a period of three years thereafter for all laborers and mechanics working at the site of the work. Such records shall contain the name, address, and social security number of each such worker, his or her correct classification, hourly rates of wages paid (including rates of contributions or costs anticipated for bona fide fringe benefits or cash equivalents thereof of the types described in section 1(b)(2)(B) of the Davis-Bacon Act), daily and weekly number of hours worked, deductions made and actual wages paid. Whenever the Secretary of Labor has found under 29 CFR 5.5(a)(1)(iv) that the wages of any laborer or mechanic include the amount of any costs reasonably anticipated in providing benefits under a plan or program described in section 1(b)(2)(B) of the Davis-Bacon Act, the contractor shall maintain records which show that the commitment to provide such benefits is enforceable, that the plan or program is financially responsible, and that the plan or program has been communicated in writing to the laborers or mechanics affected, and records which show the costs anticipated or the actual cost incurred in providing such benefits. Contractors employing apprentices or trainees under approved programs shall maintain written evidence of the registration of apprenticeship programs and certification of trainee programs, the registration of the apprentices and trainees, and the ratios and wage rates prescribed in the applicable programs.

b. (1) The contractor shall submit weekly for each week in which any contract work is performed a copy of all payrolls to the contracting agency. The payrolls submitted shall set out accurately and completely all of the information required to be maintained under 29 CFR 5.5(a)(3)(i), except that full social security numbers and home addresses shall not be included on weekly transmittals. Instead the payrolls shall only need to include an individually identifying number for each employee (e.g. , the last four digits of the employee's social security number). The required weekly payroll information may be submitted in any form desired. Optional Form WH-347 is available for this purpose from the Wage and Hour Division Web site at <http://www.dol.gov/esa/whd/forms/wh347instr.htm> or its successor site. The prime contractor is responsible for the submission of copies of payrolls by all subcontractors. Contractors and subcontractors shall maintain the full social security number and current address of each covered worker, and shall provide them upon request to the contracting agency for transmission to the State DOT, the FHWA or the Wage and Hour Division of the Department of Labor for purposes of an investigation or audit of compliance with prevailing wage requirements. It is not a violation of this section for a prime contractor to require a subcontractor to provide addresses and social security numbers to the prime contractor for its own records, without weekly submission to the contracting agency..

(2) Each payroll submitted shall be accompanied by a "Statement of Compliance," signed by the contractor or subcontractor or his or her agent who pays or supervises the payment of the persons employed under the contract and shall certify the following:

(i) That the payroll for the payroll period contains the information required to be provided under §5.5 (a)(3)(ii) of Regulations, 29 CFR part 5, the appropriate information is being maintained under §5.5 (a)(3)(i) of Regulations, 29 CFR part 5, and that such information is correct and complete;

(ii) That each laborer or mechanic (including each helper, apprentice, and trainee) employed on the contract during the payroll period has been paid the full weekly wages earned, without rebate, either directly or indirectly, and that no deductions have been made either directly or indirectly from the full wages earned, other than permissible deductions as set forth in Regulations, 29 CFR part 3;

(iii) That each laborer or mechanic has been paid not less than the applicable wage rates and fringe benefits or cash equivalents for the classification of work performed, as specified in the applicable wage determination incorporated into the contract.

(3) The weekly submission of a properly executed certification set forth on the reverse side of Optional Form WH-347 shall satisfy the requirement for submission of the "Statement of Compliance" required by paragraph 3.b.(2) of this section.

(4) The falsification of any of the above certifications may subject the contractor or subcontractor to civil or criminal prosecution under section 1001 of title 18 and section 231 of title 31 of the United States Code.

c. The contractor or subcontractor shall make the records required under paragraph 3.a. of this section available for inspection, copying, or transcription by authorized representatives of the contracting agency, the State DOT, the FHWA, or the Department of Labor, and shall permit such representatives to interview employees during working hours on the job. If the contractor or subcontractor fails to submit the required records or to make them available, the FHWA may, after written notice to the contractor, the contracting agency or the State DOT, take such action as may be necessary to cause the suspension of any further payment, advance, or guarantee of funds. Furthermore, failure to submit the required records upon request or to make such records available may be grounds for debarment action pursuant to 29 CFR 5.12.

4. Apprentices and trainees

a. Apprentices (programs of the USDOL).

Apprentices will be permitted to work at less than the predetermined rate for the work they performed when they are employed pursuant to and individually registered in a bona fide apprenticeship program registered with the U.S. Department of Labor, Employment and Training Administration, Office of Apprenticeship Training, Employer and Labor Services, or with a State Apprenticeship Agency recognized by the Office, or if a person is employed in his or her first 90 days of probationary employment as an apprentice in such an apprenticeship program, who is not individually registered in the program, but who has been certified by the Office of Apprenticeship Training, Employer and Labor Services or a State Apprenticeship Agency (where appropriate) to be eligible for probationary employment as an apprentice.

The allowable ratio of apprentices to journeymen on the job site in any craft classification shall not be greater than the ratio permitted to the contractor as to the entire work force under the registered program. Any worker listed on a payroll at an apprentice wage rate, who is not registered or otherwise employed as stated above, shall be paid not less than the applicable wage rate on the wage determination for the classification of work actually performed. In addition, any apprentice performing work on the job site in excess of the ratio permitted under the registered program shall be paid not less than the applicable wage rate on the wage determination for the work actually performed. Where a contractor is performing construction on a project in a locality other than that in which its program is registered, the ratios and wage rates (expressed in percentages of the journeyman's hourly rate) specified in the contractor's or subcontractor's registered program shall be observed.

Every apprentice must be paid at not less than the rate specified in the registered program for the apprentice's level of progress, expressed as a percentage of the journeymen hourly rate specified in the applicable wage determination. Apprentices shall be paid fringe benefits in accordance with the provisions of the apprenticeship program. If the apprenticeship program does not specify fringe benefits, apprentices must be paid the full amount of fringe benefits listed on the wage determination for the applicable classification. If the Administrator determines that a different practice prevails for the applicable apprentice classification, fringes shall be paid in accordance with that determination.

In the event the Office of Apprenticeship Training, Employer and Labor Services, or a State Apprenticeship Agency recognized by the Office, withdraws approval of an apprenticeship program, the contractor will no longer be permitted to utilize apprentices at less than the applicable predetermined rate for the work performed until an acceptable program is approved.

b. Trainees (programs of the USDOL).

Except as provided in 29 CFR 5.16, trainees will not be permitted to work at less than the predetermined rate for the work performed unless they are employed pursuant to and individually registered in a program which has received prior approval, evidenced by formal certification by the U.S. Department of Labor, Employment and Training Administration.

The ratio of trainees to journeymen on the job site shall not be greater than permitted under the plan approved by the Employment and Training Administration.

Every trainee must be paid at not less than the rate specified in the approved program for the trainee's level of progress, expressed as a percentage of the journeyman hourly rate specified in the applicable wage determination. Trainees shall be paid fringe benefits in accordance with the provisions of the trainee program. If the trainee program does not mention fringe benefits, trainees shall be paid the full amount of fringe benefits listed on the wage determination unless the Administrator of the Wage and Hour Division determines that there is an apprenticeship program associated with the corresponding journeyman wage rate on the wage determination which provides for less than full fringe benefits for apprentices. Any employee listed on the payroll at a trainee rate who is not registered and participating in a training plan approved by the Employment and Training Administration shall be paid not less than the applicable wage rate on the wage determination for the classification of work actually performed. In addition, any trainee performing work on the job site in excess of the ratio permitted under the registered program shall be paid not less than the applicable wage rate on the wage determination for the work actually performed.

In the event the Employment and Training Administration withdraws approval of a training program, the contractor will no longer be permitted to utilize trainees at less than the applicable predetermined rate for the work performed until an acceptable program is approved.

c. Equal employment opportunity. The utilization of apprentices, trainees and journeymen under this part shall be in conformity with the equal employment opportunity requirements of Executive Order 11246, as amended, and 29 CFR part 30.

d. Apprentices and Trainees (programs of the U.S. DOT).

Apprentices and trainees working under apprenticeship and skill training programs which have been certified by the Secretary of Transportation as promoting EEO in connection with Federal-aid highway construction programs are not subject to the requirements of paragraph 4 of this Section IV. The straight time hourly wage rates for apprentices and trainees under such programs will be established by the particular programs. The ratio of apprentices and trainees to journeymen shall not be greater than permitted by the terms of the particular program.

5. Compliance with Copeland Act requirements. The contractor shall comply with the requirements of 29 CFR part 3, which are incorporated by reference in this contract.

6. Subcontracts. The contractor or subcontractor shall insert Form FHWA-1273 in any subcontracts and also require the subcontractors to include Form FHWA-1273 in any lower tier subcontracts. The prime contractor shall be responsible for the compliance by any subcontractor or lower tier subcontractor with all the contract clauses in 29 CFR 5.5.

7. Contract termination: debarment. A breach of the contract clauses in 29 CFR 5.5 may be grounds for termination of the contract, and for

debarment as a contractor and a subcontractor as provided in 29 CFR 5.12.

8. Compliance with Davis-Bacon and Related Act requirements. All rulings and interpretations of the Davis-Bacon and Related Acts contained in 29 CFR parts 1, 3, and 5 are herein incorporated by reference in this contract.

9. Disputes concerning labor standards. Disputes arising out of the labor standards provisions of this contract shall not be subject to the general disputes clause of this contract. Such disputes shall be resolved in accordance with the procedures of the Department of Labor set forth in 29 CFR parts 5, 6, and 7. Disputes within the meaning of this clause include disputes between the contractor (or any of its subcontractors) and the contracting agency, the U.S. Department of Labor, or the employees or their representatives.

10. Certification of eligibility.

a. By entering into this contract, the contractor certifies that neither it (nor he or she) nor any person or firm who has an interest in the contractor's firm is a person or firm ineligible to be awarded Government contracts by virtue of section 3(a) of the Davis-Bacon Act or 29 CFR 5.12(a)(1).

b. No part of this contract shall be subcontracted to any person or firm ineligible for award of a Government contract by virtue of section 3(a) of the Davis-Bacon Act or 29 CFR 5.12(a)(1).

c. The penalty for making false statements is prescribed in the U.S. Criminal Code, 18 U.S.C. 1001.

V. CONTRACT WORK HOURS AND SAFETY STANDARDS ACT

The following clauses apply to any Federal-aid construction contract in an amount in excess of \$100,000 and subject to the overtime provisions of the Contract Work Hours and Safety Standards Act. These clauses shall be inserted in addition to the clauses required by 29 CFR 5.5(a) or 29 CFR 4.6. As used in this paragraph, the terms laborers and mechanics include watchmen and guards.

1. Overtime requirements. No contractor or subcontractor contracting for any part of the contract work which may require or involve the employment of laborers or mechanics shall require or permit any such laborer or mechanic in any workweek in which he or she is employed on such work to work in excess of forty hours in such workweek unless such laborer or mechanic receives compensation at a rate not less than one and one-half times the basic rate of pay for all hours worked in excess of forty hours in such workweek.

2. Violation; liability for unpaid wages; liquidated damages. In the event of any violation of the clause set forth in paragraph (1.) of this section, the contractor and any subcontractor responsible therefor shall be liable for the unpaid wages. In addition, such contractor and subcontractor shall be liable to the United States (in the case of work done under contract for the District of Columbia or a territory, to such District or to such territory), for liquidated damages. Such liquidated damages shall be computed with respect to each individual laborer or mechanic, including watchmen and guards, employed in violation of the clause set forth in paragraph (1.) of this section, in the sum of \$10 for each calendar day on which such individual was required or permitted to work in excess of the standard workweek of forty hours without payment of the overtime wages required by the clause set forth in paragraph (1.) of this section.

3. Withholding for unpaid wages and liquidated damages. The FHWA or the contacting agency shall upon its own action or upon written request of an authorized representative of the Department of Labor withhold or cause to be withheld, from any moneys payable on account of work performed by the contractor or subcontractor under any such

contract or any other Federal contract with the same prime contractor, or any other federally-assisted contract subject to the Contract Work Hours and Safety Standards Act, which is held by the same prime contractor, such sums as may be determined to be necessary to satisfy any liabilities of such contractor or subcontractor for unpaid wages and liquidated damages as provided in the clause set forth in paragraph (2.) of this section.

4. Subcontracts. The contractor or subcontractor shall insert in any subcontracts the clauses set forth in paragraph (1.) through (4.) of this section and also a clause requiring the subcontractors to include these clauses in any lower tier subcontracts. The prime contractor shall be responsible for compliance by any subcontractor or lower tier subcontractor with the clauses set forth in paragraphs (1.) through (4.) of this section.

VI. SUBLETTING OR ASSIGNING THE CONTRACT

This provision is applicable to all Federal-aid construction contracts on the National Highway System.

1. The contractor shall perform with its own organization contract work amounting to not less than 30 percent (or a greater percentage if specified elsewhere in the contract) of the total original contract price, excluding any specialty items designated by the contracting agency. Specialty items may be performed by subcontract and the amount of any such specialty items performed may be deducted from the total original contract price before computing the amount of work required to be performed by the contractor's own organization (23 CFR 635.116).

a. The term "perform work with its own organization" refers to workers employed or leased by the prime contractor, and equipment owned or rented by the prime contractor, with or without operators. Such term does not include employees or equipment of a subcontractor or lower tier subcontractor, agents of the prime contractor, or any other assignees. The term may include payments for the costs of hiring leased employees from an employee leasing firm meeting all relevant Federal and State regulatory requirements. Leased employees may only be included in this term if the prime contractor meets all of the following conditions:

(1) the prime contractor maintains control over the supervision of the day-to-day activities of the leased employees;

(2) the prime contractor remains responsible for the quality of the work of the leased employees;

(3) the prime contractor retains all power to accept or exclude individual employees from work on the project; and

(4) the prime contractor remains ultimately responsible for the payment of predetermined minimum wages, the submission of payrolls, statements of compliance and all other Federal regulatory requirements.

b. "Specialty Items" shall be construed to be limited to work that requires highly specialized knowledge, abilities, or equipment not ordinarily available in the type of contracting organizations qualified and expected to bid or propose on the contract as a whole and in general are to be limited to minor components of the overall contract.

2. The contract amount upon which the requirements set forth in paragraph (1) of Section VI is computed includes the cost of material and manufactured products which are to be purchased or produced by the contractor under the contract provisions.

3. The contractor shall furnish (a) a competent superintendent or supervisor who is employed by the firm, has full authority to direct performance of the work in accordance with the contract requirements, and is in charge of all construction operations (regardless of who performs the work) and (b) such other of its own organizational resources (supervision, management, and engineering services) as the contracting officer determines is necessary to assure the performance of the contract.

4. No portion of the contract shall be sublet, assigned or otherwise disposed of except with the written consent of the contracting officer, or authorized representative, and such consent when given shall not be construed to relieve the contractor of any responsibility for the fulfillment of the contract. Written consent will be given only after the contracting agency has assured that each subcontract is evidenced in writing and that it contains all pertinent provisions and requirements of the prime contract.

5. The 30% self-performance requirement of paragraph (1) is not applicable to design-build contracts; however, contracting agencies may establish their own self-performance requirements.

VII. SAFETY: ACCIDENT PREVENTION

This provision is applicable to all Federal-aid construction contracts and to all related subcontracts.

1. In the performance of this contract the contractor shall comply with all applicable Federal, State, and local laws governing safety, health, and sanitation (23 CFR 635). The contractor shall provide all safeguards, safety devices and protective equipment and take any other needed actions as it determines, or as the contracting officer may determine, to be reasonably necessary to protect the life and health of employees on the job and the safety of the public and to protect property in connection with the performance of the work covered by the contract.

2. It is a condition of this contract, and shall be made a condition of each subcontract, which the contractor enters into pursuant to this contract, that the contractor and any subcontractor shall not permit any employee, in performance of the contract, to work in surroundings or under conditions which are unsanitary, hazardous or dangerous to his/her health or safety, as determined under construction safety and health standards (29 CFR 1926) promulgated by the Secretary of Labor, in accordance with Section 107 of the Contract Work Hours and Safety Standards Act (40 U.S.C. 3704).

3. Pursuant to 29 CFR 1926.3, it is a condition of this contract that the Secretary of Labor or authorized representative thereof, shall have right of entry to any site of contract performance to inspect or investigate the matter of compliance with the construction safety and health standards and to carry out the duties of the Secretary under Section 107 of the Contract Work Hours and Safety Standards Act (40 U.S.C.3704).

VIII. FALSE STATEMENTS CONCERNING HIGHWAY PROJECTS

This provision is applicable to all Federal-aid construction contracts and to all related subcontracts.

In order to assure high quality and durable construction in conformity with approved plans and specifications and a high degree of reliability on statements and representations made by engineers, contractors, suppliers, and workers on Federal-aid highway projects, it is essential that all persons concerned with the project perform their functions as carefully, thoroughly, and honestly as possible. Willful falsification, distortion, or misrepresentation with respect to any facts related to the project is a violation of Federal law. To prevent any misunderstanding regarding the seriousness of these and similar acts, Form FHWA-1022 shall be posted on each Federal-aid highway project (23 CFR 635) in one or more places where it is readily available to all persons concerned with the project:

18 U.S.C. 1020 reads as follows:

"Whoever, being an officer, agent, or employee of the United States, or of any State or Territory, or whoever, whether a person, association, firm, or corporation, knowingly makes any false statement, false representation, or false report as to the character, quality, quantity, or cost of the material used or to be used, or the quantity or quality of the work performed or to be performed, or the cost thereof in connection with the submission of plans, maps, specifications, contracts, or costs of construction on any highway or related project submitted for approval to the Secretary of Transportation; or

Whoever knowingly makes any false statement, false representation, false report or false claim with respect to the character, quality, quantity, or cost of any work performed or to be performed, or materials furnished or to be furnished, in connection with the construction of any highway or related project approved by the Secretary of Transportation; or

Whoever knowingly makes any false statement or false representation as to material fact in any statement, certificate, or report submitted pursuant to provisions of the Federal-aid Roads Act approved July 1, 1916, (39 Stat. 355), as amended and supplemented;

Shall be fined under this title or imprisoned not more than 5 years or both."

IX. IMPLEMENTATION OF CLEAN AIR ACT AND FEDERAL WATER POLLUTION CONTROL ACT

This provision is applicable to all Federal-aid construction contracts and to all related subcontracts.

By submission of this bid/proposal or the execution of this contract, or subcontract, as appropriate, the bidder, proposer, Federal-aid construction contractor, or subcontractor, as appropriate, will be deemed to have stipulated as follows:

1. That any person who is or will be utilized in the performance of this contract is not prohibited from receiving an award due to a violation of Section 508 of the Clean Water Act or Section 306 of the Clean Air Act.

2. That the contractor agrees to include or cause to be included the requirements of paragraph (1) of this Section X in every subcontract, and further agrees to take such action as the contracting agency may direct as a means of enforcing such requirements.

X. CERTIFICATION REGARDING DEBARMENT, SUSPENSION, INELIGIBILITY AND VOLUNTARY EXCLUSION

This provision is applicable to all Federal-aid construction contracts, design-build contracts, subcontracts, lower-tier subcontracts, purchase orders, lease agreements, consultant contracts or any other covered transaction requiring FHWA approval or that is estimated to cost \$25,000 or more – as defined in 2 CFR Parts 180 and 1200.

1. Instructions for Certification – First Tier Participants:

a. By signing and submitting this proposal, the prospective first tier participant is providing the certification set out below.

b. The inability of a person to provide the certification set out below will not necessarily result in denial of participation in this covered transaction. The prospective first tier participant shall submit an explanation of why it cannot provide the certification set out below. The certification or explanation will be considered in connection with the department or agency's determination whether to enter into this transaction. However, failure of the prospective first tier participant to furnish a certification or an explanation shall disqualify such a person from participation in this transaction.

c. The certification in this clause is a material representation of fact upon which reliance was placed when the contracting agency determined to enter into this transaction. If it is later determined that the prospective participant knowingly rendered an erroneous certification, in addition to other remedies available to the Federal Government, the contracting agency may terminate this transaction for cause of default.

d. The prospective first tier participant shall provide immediate written notice to the contracting agency to whom this proposal is submitted if any time the prospective first tier participant learns that its certification was erroneous when submitted or has become erroneous by reason of changed circumstances.

e. The terms "covered transaction," "debarred," "suspended," "ineligible," "participant," "person," "principal," and "voluntarily excluded,"

as used in this clause, are defined in 2 CFR Parts 180 and 1200. "First Tier Covered Transactions" refers to any covered transaction between a grantee or subgrantee of Federal funds and a participant (such as the prime or general contract). "Lower Tier Covered Transactions" refers to any covered transaction under a First Tier Covered Transaction (such as subcontracts). "First Tier Participant" refers to the participant who has entered into a covered transaction with a grantee or subgrantee of Federal funds (such as the prime or general contractor). "Lower Tier Participant" refers any participant who has entered into a covered transaction with a First Tier Participant or other Lower Tier Participants (such as subcontractors and suppliers).

f. The prospective first tier participant agrees by submitting this proposal that, should the proposed covered transaction be entered into, it shall not knowingly enter into any lower tier covered transaction with a person who is debarred, suspended, declared ineligible, or voluntarily excluded from participation in this covered transaction, unless authorized by the department or agency entering into this transaction.

g. The prospective first tier participant further agrees by submitting this proposal that it will include the clause titled "Certification Regarding Debarment, Suspension, Ineligibility and Voluntary Exclusion-Lower Tier Covered Transactions," provided by the department or contracting agency, entering into this covered transaction, without modification, in all lower tier covered transactions and in all solicitations for lower tier covered transactions exceeding the \$25,000 threshold.

h. A participant in a covered transaction may rely upon a certification of a prospective participant in a lower tier covered transaction that is not debarred, suspended, ineligible, or voluntarily excluded from the covered transaction, unless it knows that the certification is erroneous. A participant is responsible for ensuring that its principals are not suspended, debarred, or otherwise ineligible to participate in covered transactions. To verify the eligibility of its principals, as well as the eligibility of any lower tier prospective participants, each participant may, but is not required to, check the Excluded Parties List System website (<https://www.epls.gov/>), which is compiled by the General Services Administration.

i. Nothing contained in the foregoing shall be construed to require the establishment of a system of records in order to render in good faith the certification required by this clause. The knowledge and information of the prospective participant is not required to exceed that which is normally possessed by a prudent person in the ordinary course of business dealings.

j. Except for transactions authorized under paragraph (f) of these instructions, if a participant in a covered transaction knowingly enters into a lower tier covered transaction with a person who is suspended, debarred, ineligible, or voluntarily excluded from participation in this transaction, in addition to other remedies available to the Federal Government, the department or agency may terminate this transaction for cause or default.

* * * * *

2. Certification Regarding Debarment, Suspension, Ineligibility and Voluntary Exclusion – First Tier Participants:

a. The prospective first tier participant certifies to the best of its knowledge and belief, that it and its principals:

(1) Are not presently debarred, suspended, proposed for debarment, declared ineligible, or voluntarily excluded from participating in covered transactions by any Federal department or agency;

(2) Have not within a three-year period preceding this proposal been convicted of or had a civil judgment rendered against them for commission of fraud or a criminal offense in connection with obtaining, attempting to obtain, or performing a public (Federal, State or local) transaction or contract under a public transaction; violation of Federal or State antitrust statutes or commission of embezzlement, theft, forgery, bribery, falsification or destruction of records, making false statements, or receiving stolen property;

(3) Are not presently indicted for or otherwise criminally or civilly charged by a governmental entity (Federal, State or local) with

commission of any of the offenses enumerated in paragraph (a)(2) of this certification; and

(4) Have not within a three-year period preceding this application/proposal had one or more public transactions (Federal, State or local) terminated for cause or default.

b. Where the prospective participant is unable to certify to any of the statements in this certification, such prospective participant shall attach an explanation to this proposal.

2. Instructions for Certification - Lower Tier Participants:

(Applicable to all subcontracts, purchase orders and other lower tier transactions requiring prior FHWA approval or estimated to cost \$25,000 or more - 2 CFR Parts 180 and 1200)

a. By signing and submitting this proposal, the prospective lower tier is providing the certification set out below.

b. The certification in this clause is a material representation of fact upon which reliance was placed when this transaction was entered into. If it is later determined that the prospective lower tier participant knowingly rendered an erroneous certification, in addition to other remedies available to the Federal Government, the department, or agency with which this transaction originated may pursue available remedies, including suspension and/or debarment.

c. The prospective lower tier participant shall provide immediate written notice to the person to which this proposal is submitted if at any time the prospective lower tier participant learns that its certification was erroneous by reason of changed circumstances.

d. The terms "covered transaction," "debarred," "suspended," "ineligible," "participant," "person," "principal," and "voluntarily excluded," as used in this clause, are defined in 2 CFR Parts 180 and 1200. You may contact the person to which this proposal is submitted for assistance in obtaining a copy of those regulations. "First Tier Covered Transactions" refers to any covered transaction between a grantee or subgrantee of Federal funds and a participant (such as the prime or general contract). "Lower Tier Covered Transactions" refers to any covered transaction under a First Tier Covered Transaction (such as subcontracts). "First Tier Participant" refers to the participant who has entered into a covered transaction with a grantee or subgrantee of Federal funds (such as the prime or general contractor). "Lower Tier Participant" refers any participant who has entered into a covered transaction with a First Tier Participant or other Lower Tier Participants (such as subcontractors and suppliers).

e. The prospective lower tier participant agrees by submitting this proposal that, should the proposed covered transaction be entered into, it shall not knowingly enter into any lower tier covered transaction with a person who is debarred, suspended, declared ineligible, or voluntarily excluded from participation in this covered transaction, unless authorized by the department or agency with which this transaction originated.

f. The prospective lower tier participant further agrees by submitting this proposal that it will include this clause titled "Certification Regarding Debarment, Suspension, Ineligibility and Voluntary Exclusion-Lower Tier Covered Transaction," without modification, in all lower tier covered transactions and in all solicitations for lower tier covered transactions exceeding the \$25,000 threshold.

g. A participant in a covered transaction may rely upon a certification of a prospective participant in a lower tier covered transaction that is not debarred, suspended, ineligible, or voluntarily excluded from the covered transaction, unless it knows that the certification is erroneous. A participant is responsible for ensuring that its principals are not suspended, debarred, or otherwise ineligible to participate in covered transactions. To verify the eligibility of its principals, as well as the eligibility of any lower tier prospective participants, each participant may, but is not required to, check the Excluded Parties List System website (<https://www.epls.gov/>), which is compiled by the General Services Administration.

h. Nothing contained in the foregoing shall be construed to require establishment of a system of records in order to render in good faith the

certification required by this clause. The knowledge and information of participant is not required to exceed that which is normally possessed by a prudent person in the ordinary course of business dealings.

i. Except for transactions authorized under paragraph e of these instructions, if a participant in a covered transaction knowingly enters into a lower tier covered transaction with a person who is suspended, debarred, ineligible, or voluntarily excluded from participation in this transaction, in addition to other remedies available to the Federal Government, the department or agency with which this transaction originated may pursue available remedies, including suspension and/or debarment.

* * * * *

Certification Regarding Debarment, Suspension, Ineligibility and Voluntary Exclusion--Lower Tier Participants:

1. The prospective lower tier participant certifies, by submission of this proposal, that neither it nor its principals is presently debarred, suspended, proposed for debarment, declared ineligible, or voluntarily excluded from participating in covered transactions by any Federal department or agency.

2. Where the prospective lower tier participant is unable to certify to any of the statements in this certification, such prospective participant shall attach an explanation to this proposal.

* * * * *

XI. CERTIFICATION REGARDING USE OF CONTRACT FUNDS FOR LOBBYING

This provision is applicable to all Federal-aid construction contracts and to all related subcontracts which exceed \$100,000 (49 CFR 20).

1. The prospective participant certifies, by signing and submitting this bid or proposal, to the best of his or her knowledge and belief, that:

a. No Federal appropriated funds have been paid or will be paid, by or on behalf of the undersigned, to any person for influencing or attempting to influence an officer or employee of any Federal agency, a Member of Congress, an officer or employee of Congress, or an employee of a Member of Congress in connection with the awarding of any Federal contract, the making of any Federal grant, the making of any Federal loan, the entering into of any cooperative agreement, and the extension, continuation, renewal, amendment, or modification of any Federal contract, grant, loan, or cooperative agreement.

b. If any funds other than Federal appropriated funds have been paid or will be paid to any person for influencing or attempting to influence an officer or employee of any Federal agency, a Member of Congress, an officer or employee of Congress, or an employee of a Member of Congress in connection with this Federal contract, grant, loan, or cooperative agreement, the undersigned shall complete and submit Standard Form-LLL, "Disclosure Form to Report Lobbying," in accordance with its instructions.

2. This certification is a material representation of fact upon which reliance was placed when this transaction was made or entered into. Submission of this certification is a prerequisite for making or entering into this transaction imposed by 31 U.S.C. 1352. Any person who fails to file the required certification shall be subject to a civil penalty of not less than \$10,000 and not more than \$100,000 for each such failure.

3. The prospective participant also agrees by submitting its bid or proposal that the participant shall require that the language of this certification be included in all lower tier subcontracts, which exceed \$100,000 and that all such recipients shall certify and disclose accordingly.

**MINIMUM WAGES FOR FEDERAL AND FEDERALLY
ASSISTED CONSTRUCTION CONTRACTS**

This project is funded, in part, with Federal-aid funds and, as such, is subject to the provisions of the Davis-Bacon Act of March 3, 1931, as amended (46 Sta. 1494, as amended, 40 U.S.C. 276a) and of other Federal statutes referred to in a 29 CFR Part 1, Appendix A, as well as such additional statutes as may from time to time be enacted containing provisions for the payment of wages determined to be prevailing by the Secretary of Labor in accordance with the Davis-Bacon Act and pursuant to the provisions of 29 CFR Part 1. The prevailing rates and fringe benefits shown in the General Wage Determination Decisions issued by the U.S. Department of Labor shall, in accordance with the provisions of the foregoing statutes, constitute the minimum wages payable on Federal and federally assisted construction projects to laborers and mechanics of the specified classes engaged on contract work of the character and in the localities described therein.

General Wage Determination Decisions, modifications and supersedes decisions thereto are to be used in accordance with the provisions of 29 CFR Parts 1 and 5. Accordingly, the applicable decision, together with any modifications issued, must be made a part of every contract for performance of the described work within the geographic area indicated as required by an applicable DBRA Federal prevailing wage law and 29 CFR Part 5. The wage rates and fringe benefits contained in the General Wage Determination Decision shall be the minimum paid by contractors and subcontractors to laborers and mechanics.

NOTICE

The most current **General Wage Determination Decisions** (wage rates) are available on the IDOT web site. They are located on the Letting and Bidding page at <http://www.dot.state.il.us/desenv/delett.html>.

In addition, ten (10) days prior to the letting, the applicable Federal wage rates will be e-mailed to subscribers. It is recommended that all contractors subscribe to the Federal Wage Rates List or the Contractor's Packet through IDOT's subscription service.

PLEASE NOTE: if you have already subscribed to the Contractor's Packet you will automatically receive the Federal Wage Rates.

The instructions for subscribing are at <http://www.dot.state.il.us/desenv/subsc.html>.

If you have any questions concerning the wage rates, please contact IDOT's Chief Contract Official at 217-782-7806.