**ROADWAY GEOTECHNICAL REPORT
JANE BYRNE INTERCHANGE
RECONSTRUCTION
SB I-90/94 CONNECTING RAMPS
ADVANCED CONTRACT 62J31
SECTIONS 2019-054-I
COOK COUNTY, ILLINOIS**

**for
AECOM
303 East Wacker Drive
Chicago, IL 60601
(312) 938-0300**

**submitted by
Wang Engineering, Inc.
1145 North Main Street
Lombard, IL 60148
(630) 953-9928**

Original: October 9, 2019

Technical Report Documentation Page

1. Title and Subtitle Roadway Geotechnical Report, Jane Byrne Interchange Reconstruction SB I-90/94 Connecting Ramps Advanced Contract 62J31		2. Report Date October 9, 2019	
		3. Report Type <input type="checkbox"/> SGR <input checked="" type="checkbox"/> RGR <input checked="" type="checkbox"/> Draft <input type="checkbox"/> Final <input checked="" type="checkbox"/> Revised	
4. Route / Section / County FAP 90/94/290 /2019-054-I / Cook		5. Project Numbers IDOT No. D-91-277-13 Wang No. 1100-04-01	
6. PTB / Item No. 163/001	7. Existing Structure Number(s) NA	8. Proposed Structure Number(s) NA	
9. Prepared by Wang Engineering, Inc. 1145 N Main Street Lombard, IL 60148	Contributor(s) Author: Cornelia L Marin, PG QC/QA: Corina T Farez, PE, PG PIC: Corina T Farez, PE, PG	Contact Phone Number (630) 953-9928 x 1039 cmarin@wangeng.com	
10. Prepared for AECOM 303 E Wacker Drive Chicago, IL 60601	Design / Structural Engineer Jennifer M. Golemba, PE Matthew Cooper, PE	Contact Phone Number (312) 938-0300	
11. Abstract			
<p>As part of the Jane Byrne Interchange project, three of Interstate 90/94 southbound (SB) connecting ramps will be reconstructed under Contract 62J31. The new pavements will be about 16 to 32 feet wide. The roadway pavement widening will require cut into the existing slopes, existing roadways, or be supported on new fill. The ramps are flanked by existing or new retaining walls and occasionally with slopes no steeper than 1:3 (V:H).</p> <p>Based on our subsurface investigation results, the soils consist of up to 7 feet of granular and cohesive fill, up to 4 feet medium stiff to very stiff clay crust, up to 40 feet of very soft to medium stiff clay. Water-bearing layers are present in the fill, within the soft clay, and at deeper levels within the granular materials and weathered dolostone.</p> <p>The subgrade soils along the ramp alignments consist of fill, stiff to hard silty clay, or very soft clay. Since the soft clayey subgrade will not provide a stable working platform for placement and compaction of improved aggregate subgrade; we recommend 24 inches of additional undercut below the 12 inches of IDOT Aggregate Subgrade Improvement and placing geotextile fabric at the base of the excavation for separation. Alternatively, the undercut thickness could be reduced to 12 and 9 inches by using a bi-axial or tri-axial geogrid designed for the average daily traffic, axel loading, and pavement design life. The pavement sections should be designed for an average SSR value of POOR or an IBR value of 2.</p> <p>The recommendations pertaining to the proposed retaining walls required to accommodate the new embankment or retain the cut sections along the improvement, are provided in separate structure geotechnical reports.</p>			
12. Path to archived file			
S:\Netprojects\11000401\Reports\RGRs\I-90,94_62J31\RPT_Wang_CLM_11000401-62J31RGR_V03_20191009.pdf			

TABLE OF CONTENTS

1.0 INTRODUCTION	1
2.0 GEOLOGIC SETTING	2
2.1 PHYSIOGRAPHY	2
2.2 SURFICIAL COVER	2
2.3 BEDROCK.....	3
2.4 CLIMATE DATA.....	3
3.0 METHODS OF INVESTIGATION	6
3.1 SUBSURFACE INVESTIGATION	6
3.2 LABORATORY TESTING.....	7
4.0 RESULTS OF FIELD AND LABORATORY INVESTIGATIONS	7
4.1 SURFACE CONDITIONS	7
4.2 SOIL CONDITIONS	8
4.3 GROUNDWATER CONDITIONS.....	10
5.0 ENGINEERING ANALYSIS AND RECOMMENDATIONS	11
5.1 SITE PREPARATION AND EARTHWORK.....	11
5.2 SUBGRADE TREATMENT AND RECOMMENDATIONS	11
5.3 SUBGRADE SUPPORT RATING	13
5.4 ROADWAY DRAINAGE	14
5.5 EMBANKMENT CUTS.....	14
6.0 CONSTRUCTION CONSIDERATIONS	15
6.1 EXCAVATION AND DEWATERING	15
6.2 FILLING AND BACKFILLING.....	15
6.3 EARTHWORK OPERATIONS.....	15
7.0 QUALIFICATIONS	16
REFERENCES	17
EXHIBITS	
1. Site Location Map	

2. *Site and Regional Geology*

3. *Ramps Plan*

4. *Subgrade Support Rating Chart*

APPENDIX A

Boring Logs

APPENDIX B

IDOT BMPR 507A and 508A Forms

APPENDIX C

Laboratory Test Results

APPENDIX D

Proposed Pavement Structure

APPENDIX E

Soil Boring Location Plans and Soil Profiles

LIST OF TABLES

Table 1: Summary of Alignments and Reference Borings	6
Table 2: Summary of Topsoil Thickness.....	8
Table 3: Summary of Existing Pavement Thickness and Composition	8
Table 4: Summary of Existing Fill Properties	9
Table 5: Summary of Stiff Silty Clay Unit Properties.....	9
Table 6: Summary of Very Soft to Medium Stiff Clay Properties	10
Table 7: Summary of Subgrade Soil Condition and Estimated Undercut	12
Table 8: Summary of Structures	14

LIST OF FIGURES

Figure 1: Monthly Precipitation Data for 2013	4
Figure 2: Monthly Temperature Data for 2013	4
Figure 3: Monthly Precipitation Data for 2014	5
Figure 4: Monthly Temperature Data for 2014	5

**ROADWAY GEOTECHNICAL REPORT
JANE BYRNE INTERCHANGE
RECONSTRUCTION
SB I-90/94 CONNECTING RAMPS
ADVANCED CONTACT 62J31
SECTION 2019-054-I
COOK COUNTY, ILLINOIS
FOR
AECOM**

1.0 INTRODUCTION

This report presents the results of our geotechnical subsurface investigation, laboratory testing, and engineering analyses, evaluations, and recommendations for roadway pavement reconstruction along the I-90/94 SB connecting ramps (Contract 62J31). A *Site Location Map* is presented as Exhibit 1.

Roadway design drawings provided to Wang Engineering, Inc. (Wang) by AECOM indicate the improvements will include the following ramps under SB I-90/94 Advanced Contract 62J31.

- Ramp SW between Station 1315+34.11 and Station 1321+00.00;
- SB Taylor Exit between Station 6400+00.00 and Station 6404+00.00; and
- Ramp SE between Station 1400+00.00 and Station 1401+40.00.

The roadway pavements will have one to two lanes with shoulders on both sides and a total width of about 16 to 32 feet. The purpose of the investigation was to characterize the site soil, groundwater conditions, and provide geotechnical analyses and recommendations for the design and construction of the proposed pavements.

2.0 SITE AND REGIONAL GEOLOGY

The site is located within the City of Chicago at the I-90/94 and I-290 Circle Interchange. On the USGS Chicago Loop 7.5 Minute Series map, the ramps run northward through Section 16 of Tier 39 N, Range 14 E of the Third Principal Meridian.

The following review of published geologic data, with emphasis on factors that might influence the design and construction of the proposed engineering works, is meant to place the project area within a geological framework and confirm the dependability and consistency of the present subsurface investigation results. For the study of the regional geologic framework, Wang considered northeastern Illinois in general and Cook County in particular. Exhibit 2 illustrates the *Site and Regional Geology*.

2.1 Physiography

The site is situated within the northern section of the Chicago/Calumet lacustrine plain (Chrzatowsky and Thompson 1992). The area's flat, lakeward-sloping surface is a wave-scoured groundmoraine covered by thin and discontinuous lacustrine offshore silt and clay (Willman 1971).

The investigated section of I-90/94 (Dan Ryan expressway) was constructed within a 18- to 25-foot deep cut, at elevations ranging from 574 to 590 feet. The existing elevation along the proposed ramps varies from 575 to 600 feet.

2.2 Surficial Cover

Within the project area, 100-foot thick or more, Wisconsinian-age glacial drift covers the bedrock (Leetaru et al. 2004). The glacial cover is made up of discontinuous occurrences of clay and silt of the Equality Formation of the Mason Group and diamictons of the Wadsworth and Lemont Formations of the Wedron Group (Hansel and Johnson 1996). The Equality Formation is made up of bedded silt and clay, locally laminated, with lenses and/or thin beds of sand and gravel. The Wadsworth Formation consists of relatively homogenous, massive, gray till with clay to silty clay matrix, with dolostone and shale clasts and occasional lenses of sorted and stratified silt. The Wadsworth Formation is underlain by the pebbly silty clay loam to silty loam diamicton of the Yorkville Member of the Lemont Formation, known informally as the Chicago "hardpan."

From a geotechnical viewpoint, the Equality Formation is characterized by low strength, medium to high plasticity, and medium to high moisture content, whereas the Wadsworth Formation is characterized by medium plasticity, medium to low moisture content, medium to very stiff consistency, poor permeability, and low compressibility (Bauer et al. 1991; Peck and Reed 1954).

2.3 Bedrock

In the project area, the glacial deposits unconformably rest over a 350-foot thick Silurian-age dolostone (Leetaru et al. 2004) at depths more than 100 feet below ground surface (bgs).

Our subsurface investigation results fit into the local geologic context. The borings drilled in the project area revealed the native sediments consist of clay to silty clay diamictons, hardpan, and gravelly sands that overlie the bedrock.

2.4 Climate Data

The subsurface investigation included in the report was performed between May 2013 and October 2014. To assess the possible effects of temperature and precipitation on water table data and soil moisture, the climatic conditions for the investigation period and three months prior to the start of the investigation are summarized graphically in Figures 1 through 4. The precipitation and temperature data for the investigation period are compared against thirty-year monthly data (1981 to 2010) in box-and-whiskers format to show deviations from “normal” climate conditions during the current investigation. Local climate data were obtained from the O’Hare Station (NCDC 2015).

The deviations from the historical 30-year climate data show a relatively wet period with average temperatures for 2013 and a relatively wet with lower than average temperature for 2014. Record precipitation event of 8.68 inches was recorded in April 2013. In addition, colder than normal temperatures were recorded in November and December 2013 and January, February, March, July, and August 2014 during and/or before the investigation. The presents of perched groundwater within the granular fill may have been influenced by these climate factors.

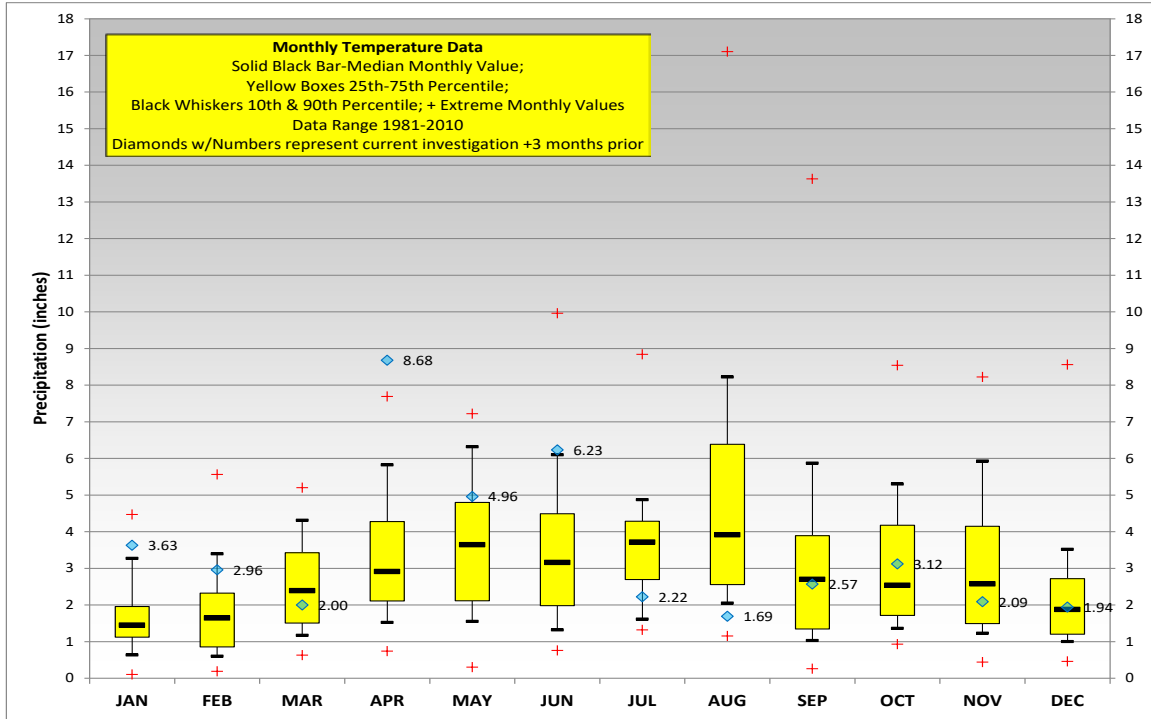

Figure 1: Monthly Precipitation Data for 2013

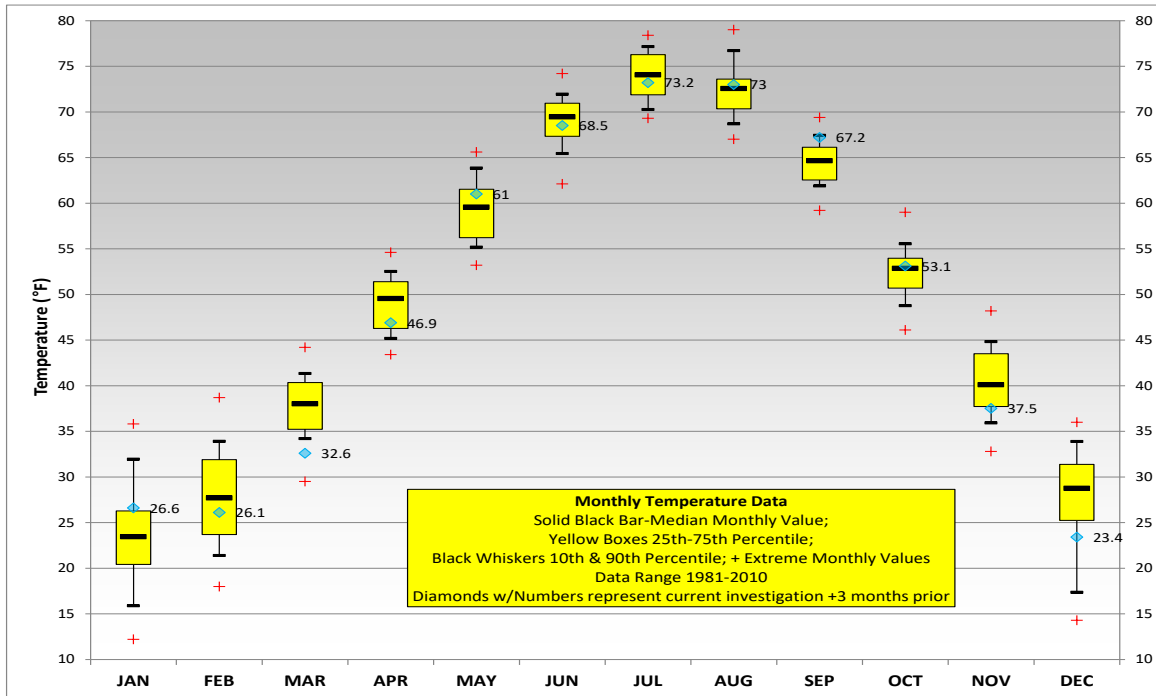

Figure 2: Monthly Temperature Data for 2013

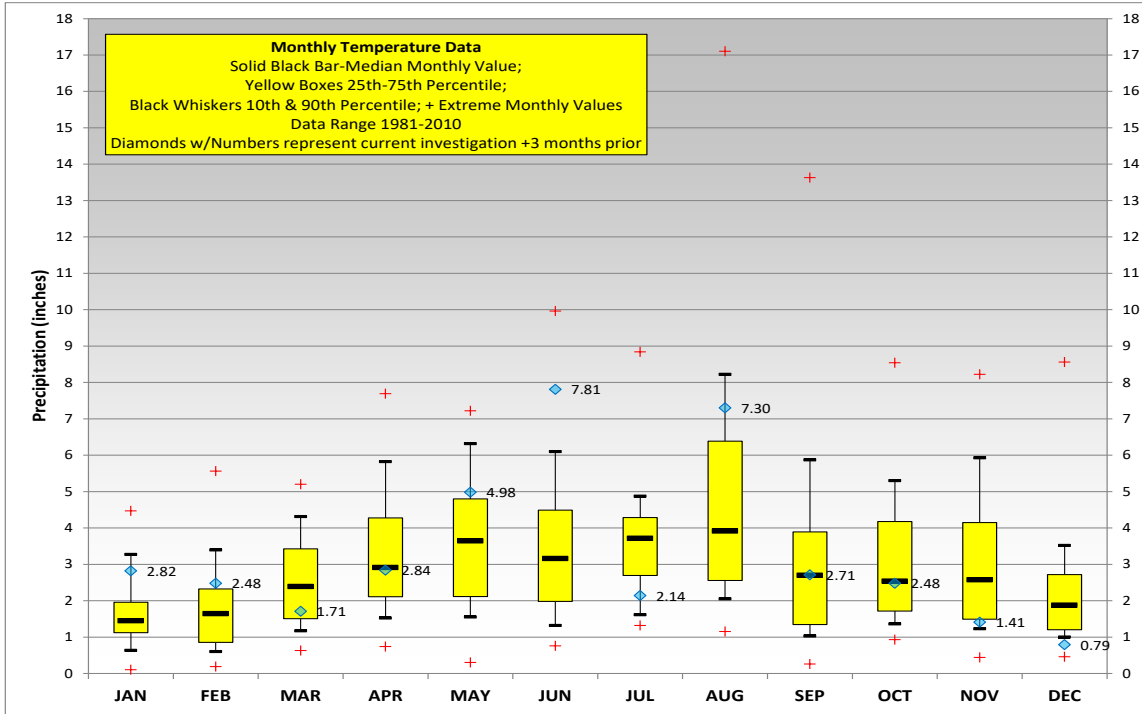

Figure 3: Monthly Precipitation Data for 2014

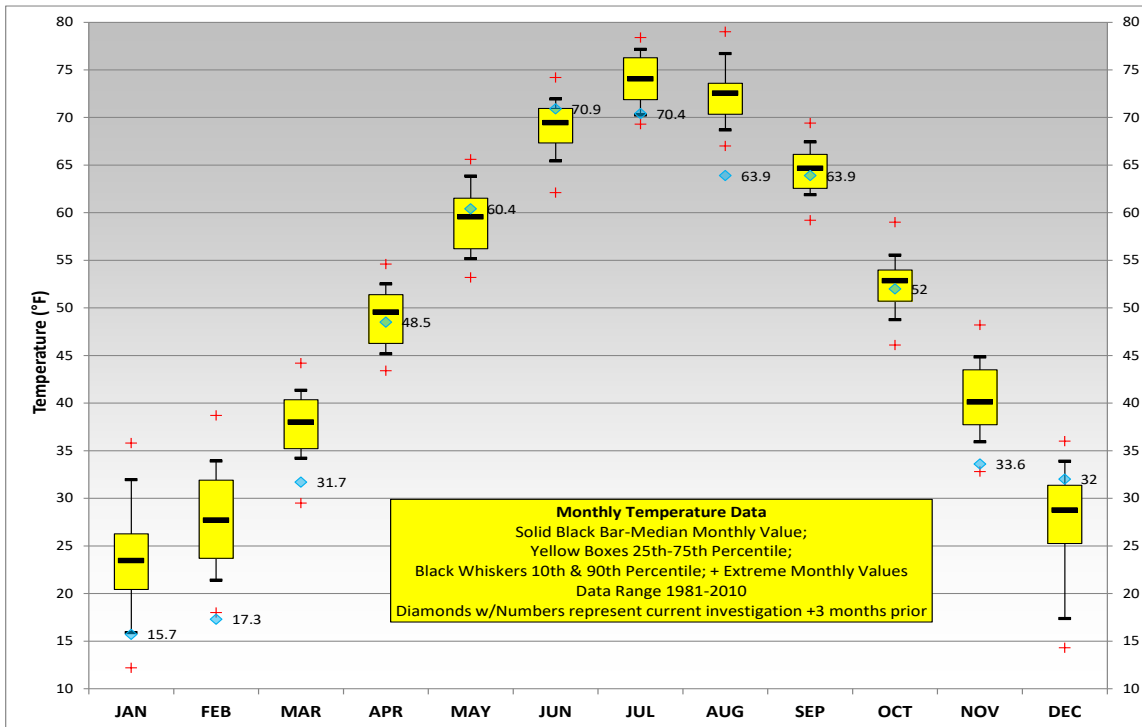

Figure 4: Monthly Temperature Data for 2014

3.0 METHODS OF INVESTIGATION

The following sections outline the methods of subsurface and laboratory investigations. All elevations in this report are based on NAVD 1988.

3.1 Subsurface Investigation

To characterize the subsurface soil and groundwater condition along each roadway alignment included in Contract 62J31, we considered data from subgrade (SGB) borings, bridge (B) borings, and retaining wall (RWB) borings. Ramp alignment limits and reference borings are summarized in Table 1.

The as-drilled boring locations and elevations were surveyed by others; stations and offsets were provided by AECOM or measured by Wang based on drawings provided by AECOM. Boring locations and elevations are shown on the *Boring Logs* (Appendix A). The as-drilled boring locations are shown in *Boring Location Plan and Soil Profiles* (Appendix E).

Truck-mounted drilling rigs equipped with hollow stem augers were used to advance and maintain open boreholes to 10 feet and mud rotary drilling technique was used below 10 feet to boring termination depths or to the bedrock. Soil sampling was performed according to AASHTO T 206, "Penetration Test and Split Barrel Sampling of Soils." Soil sampling was performed according to AASHTO T 206, "Penetration Test and Split Barrel Sampling of Soils." The soil was sampled continuously in roadway borings and at 2.5-foot intervals to 30 feet bgs and at 5-foot intervals thereafter in structure borings. A manually operated, jackhammer-driven, LB-sized Geoprobe was also used to continuously sample the soil in areas with limited access. Soil samples collected from each sampling interval were placed in sealed jars and transported to Wang Geotechnical Laboratory in Lombard, Illinois for further examination and laboratory testing.

Table 1: Summary of Alignments and Reference Borings

Alignment	Approximate Limits		Reference Boring IDs
	Start Station	End Station	
Ramp SW	1315+34.11	1321+00.00	1702-B-01, 2055-B-06, 38-RWB-01, 38-RWB-01HA, 38-RWB-02, 38-RWB-02HA, 39-RWB-01, 39-RWB-01HA, SB90-SGB-21
SB Taylor Exit Ramp	6400+00.00	6404+00.00	2055-B-03, 2055-B-06, 38-RWB-01, 38-RWB-01HA, 38-RWB-02, 38-RWB-02HA, SB90-SGB-08

Alignment	Approximate Limits		Reference Boring IDs
	Start Station	End Station	
Ramp SE	1400+00.00	1401+40.00	2055-B-03, 2055-B-06, 38-RWB-02, 38-RWB-02-HA, SB90-SGB-08

Field boring logs, prepared and maintained by Wang geologists, include lithological descriptions, visual-manual soil classifications (IDH Soil Classification System), results of Rimac and pocket penetrometer unconfined compressive strength tests, and results of Standard Penetration Tests (SPT), recorded as blows per 6 inches of penetration.

Groundwater observations were made in each boring during and at the completion of drilling operations. The borings were backfilled after completion, and the existing surface was restored to its original condition.

3.2 Laboratory Testing

The soil samples were tested in the laboratory for moisture content (AASHTO T-265). Atterberg limits (AASHTO T 89/T 90) and particle size (AASHTO T 88) analyses were performed to classify selected samples near the proposed roadway subgrade. Field visual descriptions of the soil samples were verified in the laboratory. The soils were classified according to the IDH Soil Classification System. Laboratory test results are shown on the *Boring Logs* (Appendix A) and in the *Laboratory Test Results* (Appendix C).

4.0 RESULTS OF FIELD AND LABORATORY INVESTIGATIONS

Detailed descriptions of the soil conditions encountered during the subsurface investigation are presented on the attached *Boring Logs* (Appendix A) and on the *Boring Location Plans and Soil Profiles* (Appendix E). Please note that strata contact lines represent approximate boundaries between soil types. The actual transition between soil types in the field may be gradual in horizontal and vertical directions.

4.1 Surface Conditions

The proposed alignments will be constructed through areas with various surficial cover, including topsoil, pavement, and demolished structures. Topsoil thickness measured at various locations across the site range from 6 to 18 inches with an average of 10 inches. Topsoil thickness as observed in the borings is summarized per alignments in Table 2. Alignments were borings were

not drilled in areas with topsoil, are not shown in Table 2.

Table 2: Summary of Topsoil Thickness

Alignment	Number of Measurements	Topsoil Thickness Range (inches)	Average Thickness (inches)
Ramp SW	3	6-18	12
SB Taylor Exit Ramp	2	6-18	9
Ramp SE	1	6	6

The borings were drilled mainly in the roadway lanes and shoulders. Some of the borings were drilled outside the paved areas, in spaces between the ramps or roadway slopes. The borings drilled in the existing roadway show various pavement structures consisting of asphalt or asphalt over concrete. The pavement thickness as revealed by our investigation ranges from 5 to 18 inches with an average of 10 inches. The aggregate base consists of either crushed stone or gravelly sand and its thickness ranges from 10 to 31 inches. The existing pavement thicknesses are summarized in Table 3.

Table 3: Summary of Existing Pavement Thickness and Composition

Alignment	Total Number of Measurements (No)	Pavement Structure Thickness (inches)			Pavement Average Thickness (inches)
		Asphalt No ¹ /Range	Concrete No ¹ /Range	Total Pavement No ¹ /Range	
Ramp SW	5	5/3-6	4/8-12	5/6-18	13
SB Taylor Exit Ramp	2	3/5	2/10	3/5-15	12
Ramp SE	3	3/5	3/4-10	3/9-15	13

¹No = number of measurements along the alignment.

4.2 Soil Conditions

In descending order, the general lithologic succession encountered beneath the pavement structure and topsoil includes: 1) man-made ground (fill); 2) medium stiff to hard silty clay; and 3) very soft to medium stiff clay. Soils deeper than the very soft clay layer will not impact the roadway pavement

design and are not discussed in this section but shown in the boring logs (Appendix A)

1) Man-made ground (fill)

Underneath the surface (pavement or topsoil), the borings encountered 0.9 to 7.3 feet of mainly cohesive fill consisting of stiff to hard, brown and gray silty clay to clay loam. Up to 3.5 feet of brown silty loam, loam, sand to gravelly sand is occasionally present. The cohesive fill has unconfined compressive strength (Q_u) values of 1.5 to 4.5 tsf with an average of 2.8 tsf. Moisture content (MC) tests indicate values between 3 and 19% with an average of 14%. A summary of the fill properties, along each alignment, is shown in Table 4.

Table 4: Summary of Existing Fill Properties

Alignment	Q_u	SPT N-values	Moisture Content	Liquid Limit	Plastic Limit
	Min-Max/Avg.	Min-Max/Avg.	Min-Max/Avg	Min-Max	Min-Max
	(tsf)	(blows/foot)	(%)	(%)	(%)
Ramp SW	2.0 -3.5/2.8	4-15/7	3-19/13	NA	NA
SB Taylor Exit Ramp	1.5-4.5/2.6	4-23/13	6-19/15	NA	NA
Ramp SE	1.5-4.5/2.7	4-23/13	6-17/13	NA	NA

2) Medium stiff to hard silty clay

Beneath the fill, one boring advanced through about 3.5-foot thick of stiff to very stiff silty clay unit. The unit is characterized by Q_u values of 1.4 to 2.5 tsf, with an average of 2.0 tsf and MC values of 19 to 25% with an average of 21%. This unit will be within the cut section along the alignments. A summary of the unit properties along each alignment is shown in Table 5.

Table 5: Summary of Stiff Silty Clay Unit Properties

Alignment	Q_u	SPT N-values	Moisture Content	Liquid Limit	Plastic Limit
	Min-Max/Avg.	Min-Max/Avg.	Min-Max/Avg	Min-Max	Min-Max
	(tsf)	(blows/foot)	(%)	(%)	(%)
Ramp SW	1.4-2.5/1.7	NA	19-25/21	NA	NA
SB Taylor Exit Ramp	1.4-1.5/1.4	6	21	NA	NA

Alignment	Q _u	SPT N-values	Moisture Content	Liquid Limit	Plastic Limit
	Min-Max/Avg.	Min-Max/Avg.	Min-Max/Avg	Min-Max	Min-Max
	(tsf)	(blows/foot)	(%)	(%)	(%)
Ramp SE	1.4	6	21	NA	NA

3) *Very soft to medium stiff clay*

From elevations of 571 to 583 feet, the borings encountered up to 40 feet of very soft to medium stiff and rarely stiff, gray clay to silty clay occasionally silty clay loam. This unit has Q_u values (Rimac) of 0.1 to 0.8 tsf with an average of 0.4 tsf and MC values of 16 to 28% averaging 25%. Laboratory index testing performed on samples from this unit shows liquid limit (L_L) value of 28% and plastic limit (P_L) values of 14%. According to the AASHTO soil classification, the subgrade soils belong mainly to the A-6 and A-7-6 groups. A summary of the unit properties along each alignment is shown in Table 6.

Table 6: Summary of Very Soft to Medium Stiff Clay Properties

Alignment	Q _u	SPT N-values	Moisture Content	Liquid Limit	Plastic Limit
	Min-Max/Avg.	Min-Max/Avg.	Min-Max/Avg	Min-Max	Min-Max
	(tsf)	(blows/foot)	(%)	(%)	(%)
Ramp SW	0.1-0.8/0.4	0-10/3	16-28/25	28	14
SB Taylor Exit Ramp	0.1-0.7/0.4	1-10/3	19-28/25	NA	NA
Ramp SE	0.3-0.7/0.4	1-6/3	19-28/25	NA	NA

4.3 Groundwater Conditions

Groundwater was observed in one out of eight borings along the alignments during drilling at 517.1 feet elevation (76.8 feet bgs). Since mud rotary was used below 10 feet, the water elevation in boreholes doesn't represent true groundwater elevations. Based on groundwater observations from nearby borings, the groundwater measured after 24 to 120 hours of drilling completion, show its level at elevations of 500.9 to 577.0 feet, or about 2.0 and 77.0 feet bgs. Under pressure groundwater was observed in granular layers within the diamicton and on top of the bedrock. Because the significant groundwater depth relative to the pavement structure, the groundwater will not influence the pavement design.

Wang installed a monitoring well designated as PZ-AIS at Station 6124+25 within the proposed stormwater detention area situated between I-90/94 NB and SB. The piezometer was set within Unit 3, *very soft to medium stiff clay* between depths of 5.0 and 45.5 feet bgs. The monitoring well showed an average water table elevation of 568.5 feet (about 10 feet bgs). It's known that ***within the soft clay unit, possible thin lenses of saturated silt are prone to release water into excavations.*** During periods of precipitation, we anticipate that perched groundwater may be encountered, but otherwise the static water level is deep seated and will not impact the roadway or pavement design.

5.0 ENGINEERING ANALYSIS AND RECOMMENDATIONS

Typical pavement section from the design drawings dated August 16, 2019 (Appendix D) indicate the ramp pavements will consist of 9 to 11 inches of jointed Portland Cement Concrete (PCC) pavement over 4 inches of stabilized hot-mix asphalt (HMA) base and 12 inches of improved aggregate subgrade. Temporary pavement will consist of either layered HMA over subbase granular material or PCC over subbase granular material.

Cross sections show the alignments sharing the embankment and roadway sections. Within the shared sections, the treatment will refer to the entire extent of common subgrade or foundation. When finished, the ramps will include one to two lanes and shoulders on both sides. Typical pavement sections are shown in Appendix D.

5.1 Site Preparation and Earthwork

It is recommended that the existing topsoil, pavements, and construction debris be stripped within the limits of the proposed pavements, embankment fill, and grading. For estimating purposes, the average topsoil thickness to be stripped from the surface is 10 inches. According to IDOT District One policy, a shrinkage factor of 15% should be used to measure borrowed and furnished excavation quantities.

The exposed subgrade throughout the extent of the improvement will consist of very soft to medium stiff clay, stiff to hard silty clay, and granular or cohesive fill. It should be anticipated that the very soft to medium stiff clay will fail attempts to proofrolling due to excessive deflection and rutting; therefore, ***the proofrolling of soft soil is not recommended*** and additional subgrade treatment should be provided, as discussed in Section 5.2.

5.2 Subgrade Treatment and Recommendations

Based on the result of our subsurface investigation we expect the subgrade will consist of stiff to hard

silty clay fill, stiff to hard silty clay diamicton, and very soft to medium stiff clay. Table 7 summarize the subgrade soil conditions below the proposed pavement including the 12 inches of aggregate subgrade improvement (ASI) and our recommendations for subgrade improvement.

Table 7: Summary of Subgrade Soil Condition and Estimated Undercut

Alignment	Limits of Subgrade Treatment		Subgrade Soil Type and Properties	Estimated Undercut Depth (in) <i>Note 1</i>
	Stations	Width		
Ramp SW <i>Note 2</i>	1315+00 to 1318+60	full width	Very soft to med stiff clay (Unit 3) Qu=0.1-0.4 tsf ; N=3-5bw/ft; MC=23-26%; moist to wet	24
	1318+60 to 1318+75 <i>Note 3 / Note 4</i>	8'LT to 12'RT 20'LT to 8'LT	Approach slab Very soft to med stiff clay (Unit 3)	24
	1318+75 to 1318+84 <i>Note 3 / Note 4</i>	8'LT to 12'RT 20'LT to 8'LT	Slab foundation Very soft to med stiff clay (Unit 3)	24
	1318+84 to 1318+91 <i>Note 3</i>	20'LT to 12'RT	60" RCP combined sewer siphon	0
	1318+91 to 1319+00 <i>Note 3 / Note 4</i>	8'LT to 12'RT 20'LT to 8'LT	Slab foundation Very soft to med stiff clay (Unit 3)	24
	1319+00 to 1319+15 <i>Note 3 / Note 4</i>	8'LT to 12'RT 20'LT to 8'LT	Approach slab Very soft to med stiff clay (Unit 3)	24
	1319+15 to 1319+76 <i>Note 5</i>	full width	Very soft to med stiff clay (Unit 3) Qu=0.1-0.4 tsf ; N=3-5bw/ft; MC=23-26%; moist to wet	24
	1319+76 to 1320+52 <i>Note 5</i>	20'LT to 8'LT	Very soft to med stiff clay (Unit 3) Qu=<0.5 tsf ; N=<5bw/ft; MC=23-26%; moist to wet	24
SB Taylor Exit Ramp	6400+00 to 6401+00	full width	Very soft to med stiff clay (Unit 3) Qu=0.2-0.4 tsf ; N=2-3blw/ft; MC=20-26%; moist to wet	24
	6401+00 to 6402+00	0 to 8'LT	Very soft to med stiff clay (Unit 3) Qu=0.2-0.4 tsf ; N=2-3blw/ft; MC=20-26%; moist to wet	24

Notes:

1. *Include the 12 inches ASI on the pavement design. Depth of undercut measured below the ASI;*
2. *Along Ramp SW, the median between the existing roadway pavement will be crossed by new pavement and the need for subgrade treatment should be determined in the field during construction;*
3. *No subgrade improvement at the 60" sewer siphon crossing. The improvement length covers the structural slab including the approach slab. Wang addressed the support of the structural slab on a separate Geotechnical Memorandum;*
4. *Recommended 9"/12" undercut with geogrid reinforcement as per Project Special Provisions for Geotechnical Reinforcement (8/1/2018);*
5. *Additional placement of aggregate subgrade improvement shall be installed to the maximum depth established by the adjacent, previously installed aggregate subgrade improvement.*

To reduce the 24 inches of undercut, the following geosynthetics reinforced aggregate platform could be considered.

Recommendations for the reinforced aggregate platform

1. *A geotextile fabric should be place at the base of the undercut;*
2. *The 24 inches of undercut treatment can be reduced to 12 inches of undercut below the traffic lanes and to 9 inches of undercut below shoulders near the walls by the placing of biaxial or triaxial geogrid. **The geogrid could be used within wall limits and reduce the undercut thickness to not interfere with the walls structural design.** The geogrid should be designed specifically for the proposed average daily traffic volume, designed pavement life, number of proposed axels, and axel loads. See Project Special Provisions for Geotechnical Reinforcement (08/01/2018);*

If reinforced aggregate platform is not selected, then geotextile fabric for ground separation according to Section 210 (2016) should be placed/provided at the base of undercut. The improved subgrade should be in accordance with the Bureau of Design and Environment special provision, *Aggregate Subgrade Improvement*.

5.3 Subgrade Support Rating

Laboratory testing on the subgrade soils shows a Subgrade Support Rating (SSR) of POOR. The pavement should be design based on SSR of POOR or on an IBR of 2, as per IDOT correlation to the A-7-6 soil classification encountered during the investigation (IDOT, 2015).

5.4 Roadway Drainage

The proposed subgrade and pavement should have proper surface grading to remove water accumulations and prevent the pooling of water. The clayey subgrade, encountered immediately beneath the proposed roadway pavement, have high clay and silt contents and will exhibit poor drainage characteristics. Although the soils are not frost susceptible, the installation of six-inch diameter transverse underdrains at the low points in the proposed profile and at 300-foot intervals between is recommend ensuring the long-term performance of the pavement. The underdrains should be installed at a depth immediately below the base of improved subgrade elevation and should not be wrapped in filter fabric. The underdrains should tie into the storm water drainage system and should be installed per Article 601 in the IDOT Standard Specifications and consist of Type 2 underdrains (Adopted April 1, 2016).

5.5 Embankment Cuts

Existing embankments and slopes along I-90/94 improvements will be cut as part of the widening and realignment of the roadway section. To support the proposed cuts, retaining walls will be constructed. Table 8 summarize the structures along the proposed alignments. The retaining wall design was addressed in separate structure geotechnical report.

Table 8: Summary of Structures

Alignment	Wall Number	Structure Number	Approximate Location
Ramp SW	38	016-1827	Ramp West side

5.5.1 Settlement

The ramps will be constructed within up to 20 feet cuts along their west side. The cuts will be retained by Retaining Wall 38 (SN16-1827). Based on the results of settlement analysis presented in the previously approved SGR for Wall 38, the settlement criterium was met. It should be noted that the surcharge is applied at the upper levels of the backwall where the existing ground is located, thus we do not anticipate the new fill to have any settlement effect on the adjacent roadway.

The settlement analysis performed for the Wall 38 SGR was completed using IDOT Design Guide “Cohesive Soil Settlement Estimate and spreadsheet” dated December 9, 2014. The total estimated maximum settlement was 1.5 inches for the maximum surcharge of 14 feet. This estimated settlement is considered adequate for the proposed landscaping behind the wall.

5.5.2 Global Stability

Were present, the slopes along some of the roadway sections will be graded no steeper than 1:3 (V:H). Wall 38 retain most of the cuts along the ramps. We estimate the proposed slopes meet the IDOT required minimum FOS of 1.5 where fill and 1.7 were in cut.

6.0 CONSTRUCTION CONSIDERATIONS

6.1 Excavation, Dewatering, and Utilities

Excavations should be performed in accordance with local, State, and federal regulations. The potential effect of ground movements upon nearby roadways and utilities should be considered during construction. Excavations should be sloped at no greater than 1:2 (V:H). Excavations required to reach the base elevations of the retaining walls, as well as for undercutting, may require dewatering. Groundwater is known to be present within the soft clay (**Unit 3**) and in granular lenses encountered throughout. The Contractor should ensure proper surface grading to prevent the pooling of run-off into open excavations. Any water allowed to enter excavations should immediately be removed via sump pump.

6.2 Filling and Backfilling

General fill used as embankment material should be structural fill except as noted in Section 5.2. Pre-approved, compacted, cohesive or granular soil conforming to Section 204, *Borrow and Furnished Excavation* would be acceptable as structural fill (IDOT 2016). The fill material should be free of organic matter and debris and should be placed in lifts and compacted in accordance to Section 205, *Embankment*. The Embankment construction should meet the requirements of the current District One *Embankment I* Special Provisions. The existing material excavated from the cut areas may be reused if it conforms to the following criteria: a) L_L less than 50%; b) plasticity index less than 20%; c) maximum dry density greater than 90 pcf according to AASHTO T 99; and d) organic content less than 10%.

Several sewer pipes and drainage structures are proposed along the roadway alignments. If the excavations for pipe/structure installation terminate in the very soft to soft gray clay to silty clay, we recommend 12 inches of aggregates to be paced over a stabilization geofabric at the base of the excavation to provide for a stable construction platform.

6.3 Earthwork Operations

The required earthwork can be accomplished with conventional construction equipment. Moisture and traffic will cause deterioration of exposed subgrade soils. Precautions should be taken by the contractor

to prevent water erosion of the exposed subgrade. A compacted subgrade will minimize water runoff erosion.

Earth moving operations should be scheduled to not coincide with excessive cold or wet weather (early spring, late fall or winter). Any soil allowed to freeze or soften due to the standing water should be removed. Wet weather can cause problems with subgrade compaction.

It is recommended that an experienced geotechnical engineer be retained to inspect the exposed subgrade, monitor earthwork operations, and provide material inspection services during the construction phase of this project.

7.0 QUALIFICATIONS

The analysis and recommendations submitted in this report are based upon the data obtained from the borings drilled at the locations shown on the boring logs and in Appendix E. This report does not reflect any variations that may occur between the borings or elsewhere on the site, variations whose nature and extent may not become evident until the course of construction. In the event that any changes in the design and/or location of the roadway are planned, we should be timely informed so that our recommendations can be adjusted accordingly.

It has been a pleasure to assist AECOM and the Illinois Department of Transportation on this project. Please call if there are any questions, or if we can be of further service.

Respectfully Submitted,

WANG ENGINEERING, INC.

Cornelia L. Marin, P.G.
Senior Engineering Geologist

Corina T. Farez, P.E., P.G.
Project Manager

REFERENCES

- BAUER, R.A., CURRY, B.B., GRAESE, A.M., VAIDEN, R.C., SU, W.J., and HASEK, M.J., 1991, Geotechnical Properties of Selected Pleistocene, Silurian, and Ordovician Deposits of Northeastern Illinois: Environmental Geology 139, Illinois State Geological Survey, 69 p.
- HANSEL, A.K., and JOHNSON, W.H. (1996) *Wedron and Mason Groups: Lithostratigraphic Reclassification of the Wisconsin Episode, Lake Michigan Lobe Area: ISGS Bulletin 104*. Illinois State Geological Survey, Champaign, IL. 116 p.
- ILLINOIS DEPARTMENT OF TRANSPORTATION (2015) *Geotechnical Manual*. IDOT Bureau of Materials and Physical Research, Springfield, IL.
- ILLINOIS DEPARTMENT OF TRANSPORTATION (2016) *Standard Specifications for Road and Bridge Construction*. IDOT Division of Highways, Springfield, IL.
- LEETARU, H.E., SARGENT, M.L., and KOLATA, D.R. (2004) Geologic Atlas of Cook County for Planning Purposes, Open File Series 2004-12, Illinois State Geological Survey, p. 30.
- LEIGHTON, M.M., EKBLAW, G.E., and HORBERG, L. (1948) *Physiographic Divisions of Illinois*. The Journal of Geology, v. 56, p. 16-33.
- ILLINOIS DEPARTMENT OF TRANSPORTATION (2005) *Subgrade Stability Manual*. IDOT Bureau of Bridges and Structures.
- NCDC (2019) National Climatic Data Center: Global Historical Climatological Network Data, <http://www.ncdc.noaa.gov/ghcn/ghcn.SELECT.html>.
- PECK, R.B., and REED, W.C. (1954) Engineering Properties of Chicago Subsoils: University of Illinois Engineering Experiment Station Bulletin No. 423: Urbana, University of Illinois, 62

EXHIBITS

1. Site Location Map
2. Site and Regional Geology
3. Contract 62J31 Ramps Plan
4. Subgrade Support Rating



PROJECT LOCATION
 NW 1/4 Sec. 16
 of T 39N, R 14E of 3rd PM



 Contract 62XJ31 Alignments
 (Ramp SW, SB Taylor Exit Ramp, Ramp SE)

SITE LOCATION MAP: JANE BYRNE INTERCHANGE CONTRACT 62J31, COOK COUNTY, ILLINOIS		
SCALE: GRAPHICAL	EXHIBIT 1	DRAWN BY: L. Varzaru CHECKED BY: C. Marin
		1145 N. Main Street Lombard, IL 60148 www.wangeng.com
FOR AECOM		1100-04-01

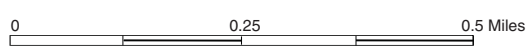

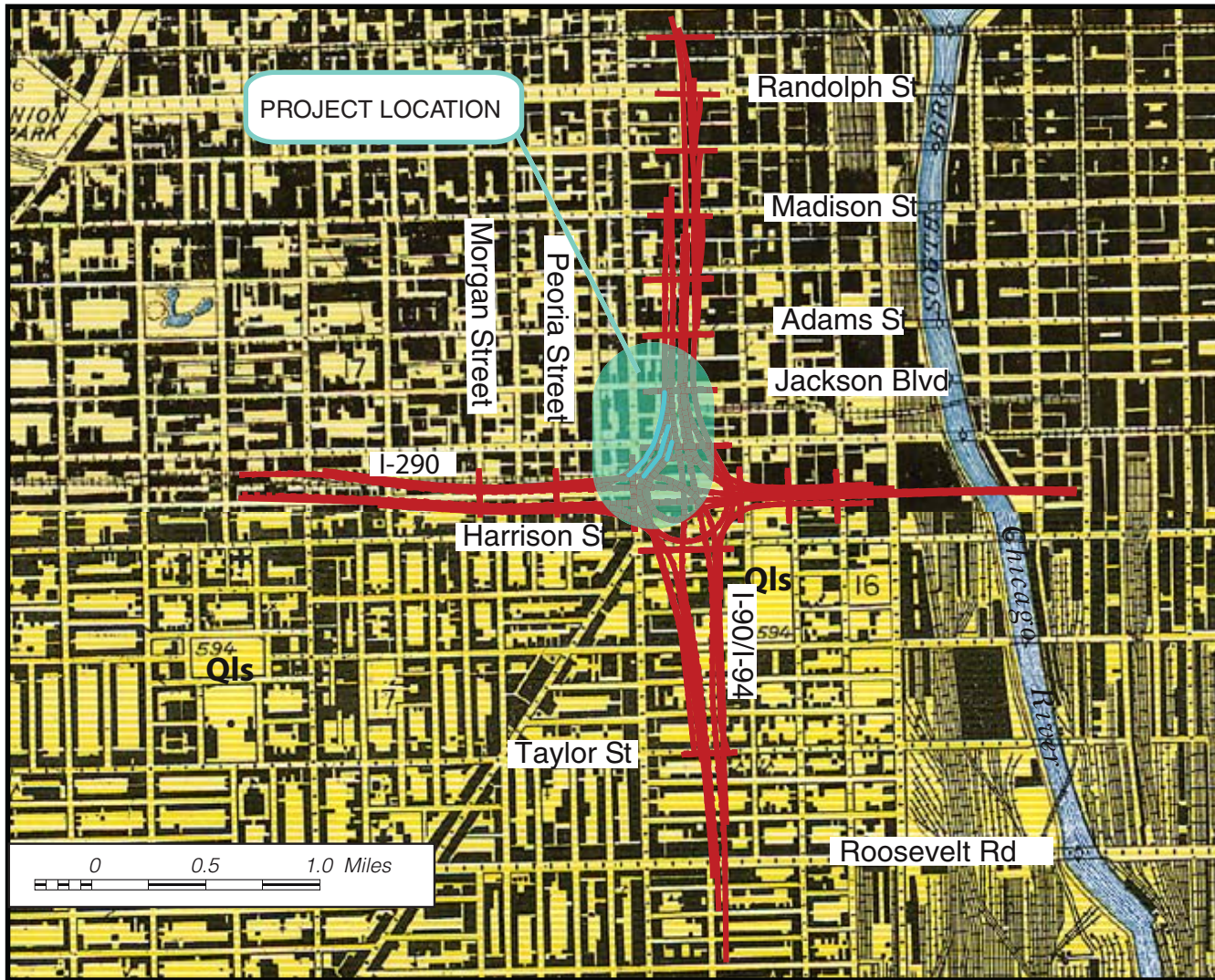

Modified after Bretz (1926)

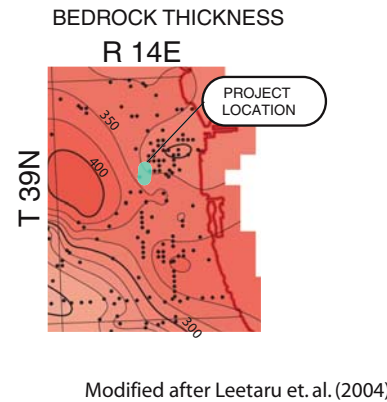
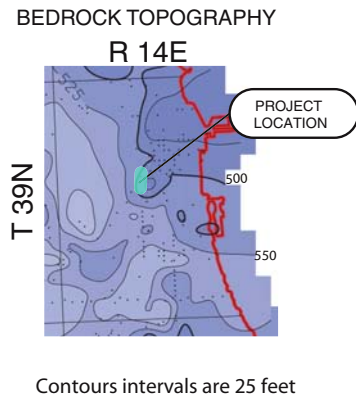
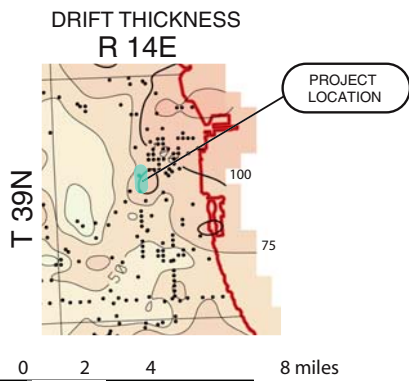
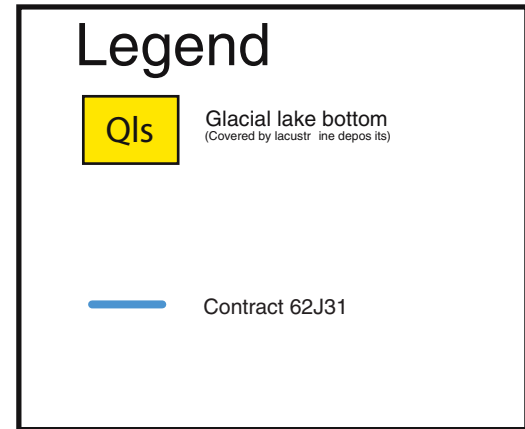
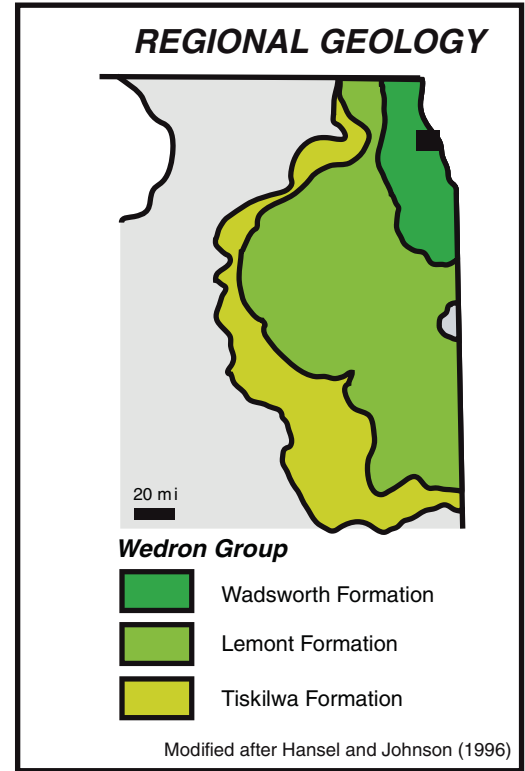

SITE AND REGIONAL GEOLOGY: JANE BYRNE INTERCHANGE, I-90/94
 CONTRACT 62J3, COOK COUNTY, ILLINOIS

SCALE: GRAPHICAL

EXHIBIT 2

DRAWN BY: J. Rowells
 CHECKED BY: C. Marin



1145 N. Main Street
 Lombard, IL 60148
 www.wangeng.com

FOR AECOM

1100-04-01

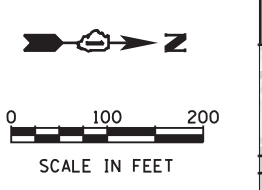
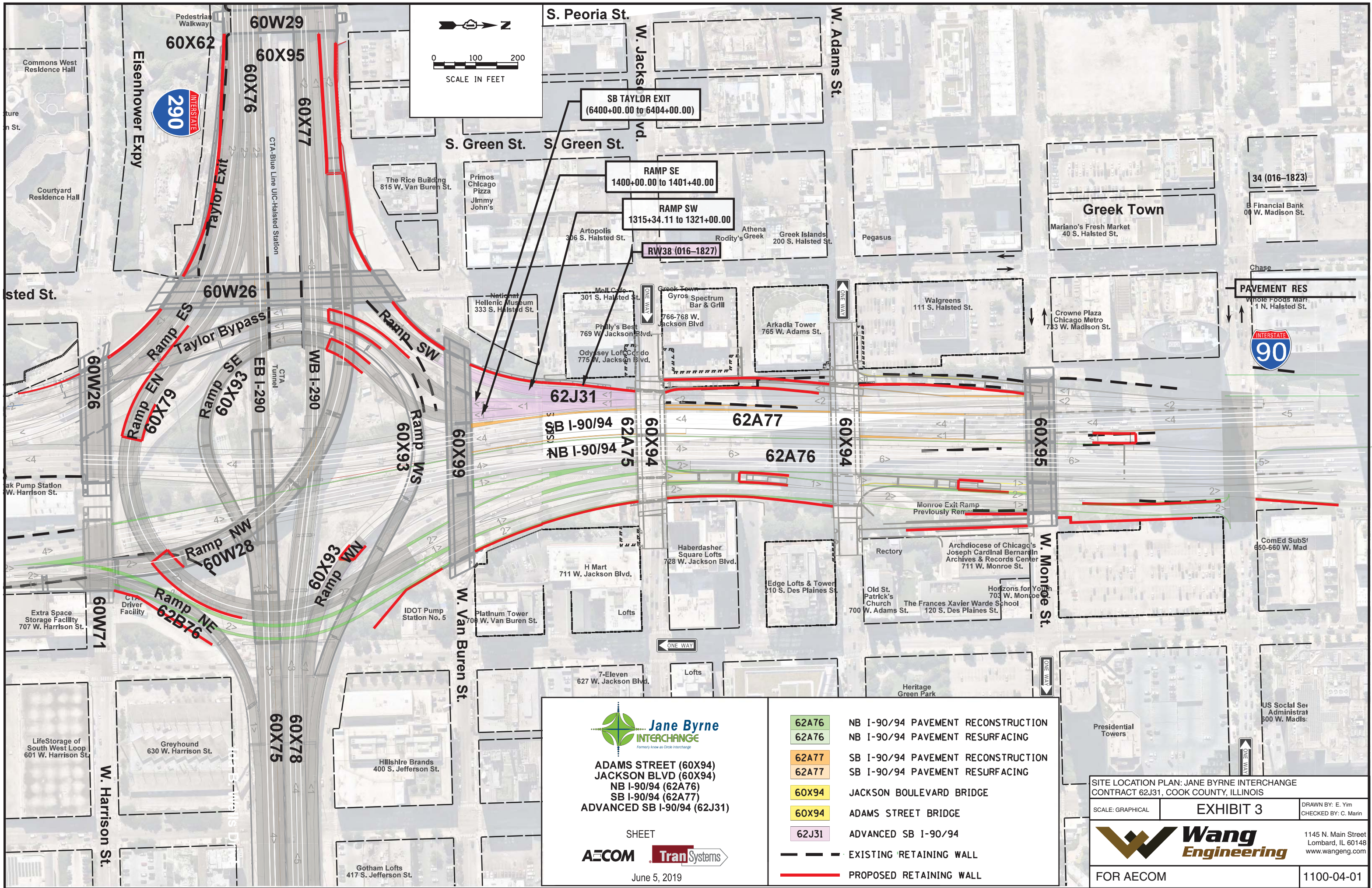

Jane Byrne INTERCHANGE
Formerly known as Circle Interchange
**ADAMS STREET (60X94)
 JACKSON BLVD (60X94)
 NB I-90/94 (62A76)
 SB I-90/94 (62A77)
 ADVANCED SB I-90/94 (62J31)**

SHEET





June 5, 2019

- 62A76 NB I-90/94 PAVEMENT RECONSTRUCTION
- 62A76 NB I-90/94 PAVEMENT RESURFACING
- 62A77 SB I-90/94 PAVEMENT RECONSTRUCTION
- 62A77 SB I-90/94 PAVEMENT RESURFACING
- 60X94 JACKSON BOULEVARD BRIDGE
- 60X94 ADAMS STREET BRIDGE
- 62J31 ADVANCED SB I-90/94
- EXISTING RETAINING WALL
- PROPOSED RETAINING WALL

SITE LOCATION PLAN: JANE BYRNE INTERCHANGE
 CONTRACT 62J31, COOK COUNTY, ILLINOIS

SCALE: GRAPHICAL **EXHIBIT 3**



FOR AECOM

DRAWN BY: E. Yin
 CHECKED BY: C. Marin
 1145 N. Main Street
 Lombard, IL 60148
 www.wangeng.com

1100-04-01

EXHIBIT 4

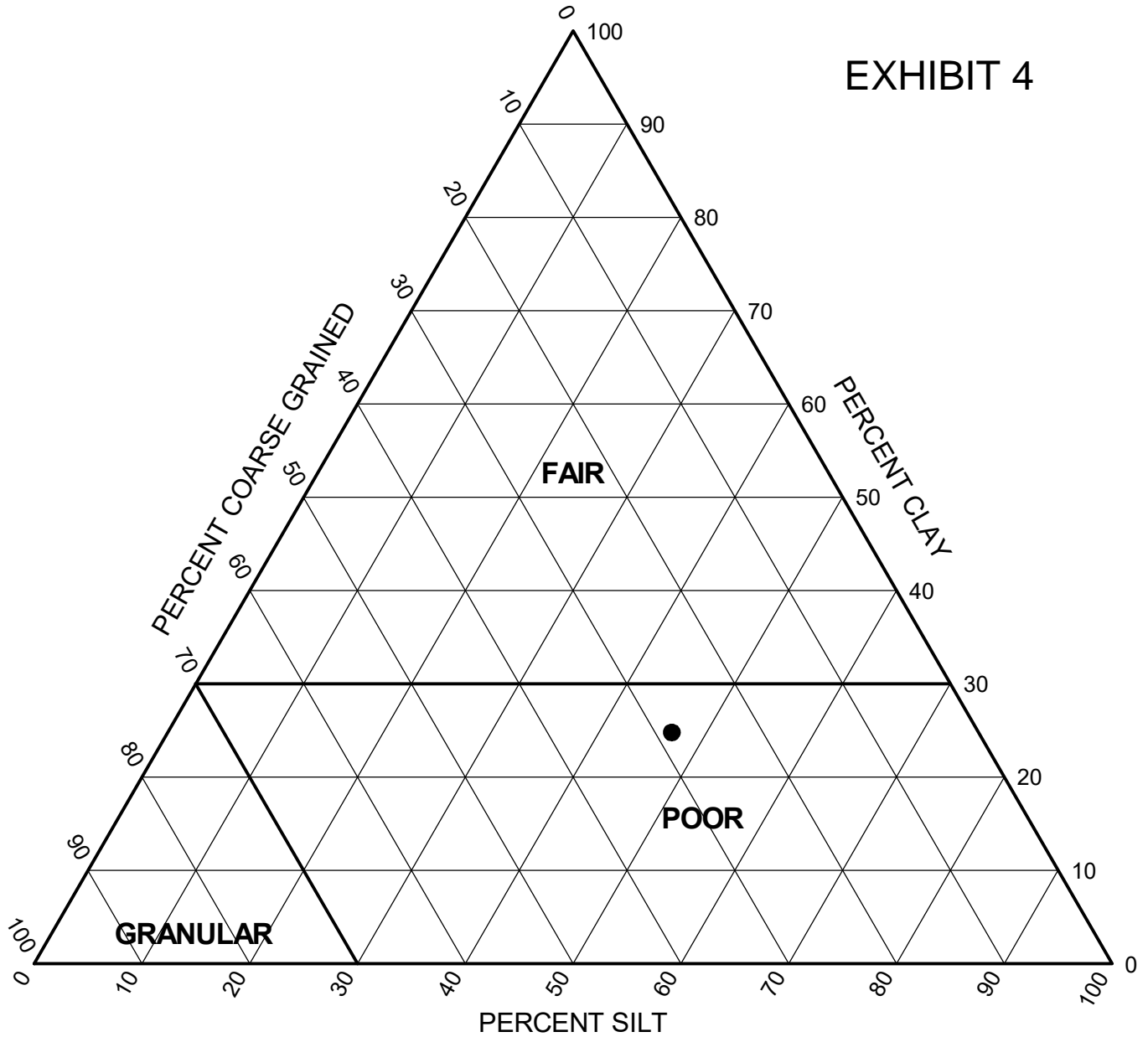

	Sample	Depth (ft)	Coarse (%)	Silt (%)	Clay (%)	Classification		
						IL DOT	AASHTO	RATING
●	1702-B-01#9	21.0	28.4	46.7	24.8	Clay Loam	A-6 (7)	POOR

WEI SSR 11000401.GPJ WANGENG.GDT 8/28/19



Wang Engineering, Inc.
 1145 N Main Street
 Lombard, IL 60148
 Telephone: (630) 953-9928
 Fax: (630) 953-9938

Subgrade Support Rating Chart
 Project: Jane Byrne Interchange
 Location: Section 17, T39N, R14E of 3rd PM
 Number: 1100-04-01

APPENDIX A
Boring Logs



BORING LOG 1702-B-01

wangeng@wangeng.com
 1145 N Main Street
 Lombard, IL 60148
 Telephone: (630) 953-9928
 Fax: (630) 953-9938

WEI Job No.: 1100-04-01

Client: **AECOM**
 Project: **Jane Byrne Interchange**
 Location: **Section 17, T39N, R14E of 3rd PM**

Datum: NAVD 88
 Elevation: 593.83 ft
 North: 1898849.46 ft
 East: 1171361.60 ft
 Station: 8211+87.78
 Offset: 18.3545 RT

Profile	Elevation (ft)	SOIL AND ROCK DESCRIPTION	Depth (ft)	Sample Type recovery	Sample No.	SPT Values (blw/6 in)	Qu (tsf)	Moisture Content (%)	Profile	Elevation (ft)	SOIL AND ROCK DESCRIPTION	Depth (ft)	Sample Type recovery	Sample No.	SPT Values (blw/6 in)	Qu (tsf)	Moisture Content (%)
	593.3	6-inch thick, ASPHALT --PAVEMENT--								573.3	Soft, gray CLAY LOAM, trace gravel						
	592.3	12-inch thick, CONCRETE --PAVEMENT--									--L _L (%)=28, P _L (%)=14-- --%Gravel=5.4-- --%Sand=23.0-- --%Silt=46.7-- --%Clay=24.8-- --A-6 (7)--			9	1 1 2	0.33 B	16
	590.6	Loose, brown and gray, fine and medium SAND, trace gravel --FILL--			1	3 3 3	NP	12			Soft to very stiff, brown and gray SILTY CLAY LOAM, trace gravel and sand layers --FILL--	5		2	3 3 3	2.50 P	17
					3	2 1 2	1.25 P	20				25		10	1 1 2	0.49 B	25
					4	2 2 4	2.05 B	23						11	0 3 2	0.57 B	24
					5	3 2 2	0.75 P	27						12	0 2 2	0.74 B	24
					6	0 0 0	0.41 B	26						13	1 2 2	0.41 B	25
					7	0 2 2	0.33 B	24						14	2 3 4	0.49 B	25
					8	0 0 2	0.41 B	20									
	583.3	Soft to medium stiff, gray CLAY to SILTY CLAY, trace gravel			5												

GENERAL NOTES

WATER LEVEL DATA

Begin Drilling **06-17-2014** Complete Drilling **06-17-2014**
 Drilling Contractor **Wang Testing Services** Drill Rig **B-57 TMR [100%]**
 Driller **N&K** Logger **A. Happel** Checked by **C. Marin**
 Drilling Method **3.25" HSA to 10', mud rotary thereafter, boring**
backfilled upon completion

While Drilling ∇ **76.75 ft**
 At Completion of Drilling ∇ **mud in the borehole**
 Time After Drilling **NA**
 Depth to Water ∇ **NA**

The stratification lines represent the approximate boundary between soil types; the actual transition may be gradual.

WANGENGINC 11000401.GPJ WANGENG.GDT 8/30/19



BORING LOG 1702-B-01

wangeng@wangeng.com
 1145 N Main Street
 Lombard, IL 60148
 Telephone: (630) 953-9928
 Fax: (630) 953-9938

WEI Job No.: 1100-04-01

Client: **AECOM**
 Project: **Jane Byrne Interchange**
 Location: **Section 17, T39N, R14E of 3rd PM**

Datum: NAVD 88
 Elevation: 593.83 ft
 North: 1898849.46 ft
 East: 1171361.60 ft
 Station: 8211+87.78
 Offset: 18.3545 RT

Profile	Elevation (ft)	SOIL AND ROCK DESCRIPTION	Depth (ft)	Sample Type recovery	Sample No.	SPT Values (blw/6 in)	Qu (tsf)	Moisture Content (%)	Profile	Elevation (ft)	SOIL AND ROCK DESCRIPTION	Depth (ft)	Sample Type recovery	Sample No.	SPT Values (blw/6 in)	Qu (tsf)	Moisture Content (%)
	552.1	Stiff, gray SILTY CLAY LOAM to SILTY LOAM, trace gravel	45	X	15	3 4 6	1.39 B	17				65	X	19	5 7 14	0.75 P	22
			50	X	16	2 4 3	1.39 B	16		527.1	Medium stiff to very stiff, gray CLAY, trace gravel	70	X	20	5 7 8	2.21 B	24
	542.1	Soft to stiff, gray SILTY CLAY, trace gravel	55	X	17	4 6 6	0.49 B	21				75	X	21	3 4 5	0.82 B	30
			60	X	18	5 9 17	1.00 P	22		517.1	Medium dense to very dense, gray, fine SAND and SILT laminations	80	X	22	10 7 11	NP	22

GENERAL NOTES

WATER LEVEL DATA

Begin Drilling **06-17-2014** Complete Drilling **06-17-2014**
 Drilling Contractor **Wang Testing Services** Drill Rig **B-57 TMR [100%]**
 Driller **N&K** Logger **A. Happel** Checked by **C. Marin**
 Drilling Method **3.25" HSA to 10', mud rotary thereafter, boring**
backfilled upon completion

While Drilling ∇ **76.75 ft**
 At Completion of Drilling ∇ **mud in the borehole**
 Time After Drilling **NA**
 Depth to Water ∇ **NA**

The stratification lines represent the approximate boundary between soil types; the actual transition may be gradual.

WANGENGINC 11000401.GPJ WANGENG.GDT 8/30/19



BORING LOG 1702-B-01

wangeng@wangeng.com
 1145 N Main Street
 Lombard, IL 60148
 Telephone: (630) 953-9928
 Fax: (630) 953-9938

WEI Job No.: 1100-04-01

Client: **AECOM**
 Project: **Jane Byrne Interchange**
 Location: **Section 17, T39N, R14E of 3rd PM**

Datum: NAVD 88
 Elevation: 593.83 ft
 North: 1898849.46 ft
 East: 1171361.60 ft
 Station: 8211+87.78
 Offset: 18.3545 RT

Profile	Elevation (ft)	SOIL AND ROCK DESCRIPTION	Depth (ft)	Sample Type recovery	Sample No.	SPT Values (blw/6 in)	Qu (tsf)	Moisture Content (%)	Profile	Elevation (ft)	SOIL AND ROCK DESCRIPTION	Depth (ft)	Sample Type recovery	Sample No.	SPT Values (blw/6 in)	Qu (tsf)	Moisture Content (%)
	502.1	Dense to very dense, gray SILTY LOAM --Moist--								487.8	--AUGER REFUSAL-- Boring terminated at 106.00 ft						
			85	○	23	50/5	NR					105	⊗	27	23 32 25	NP	24
			90	⊗	24	20 21 32	NP	20									
			95	⊗	25	22 23 23	NP	23									
			100	⊗	26	18 27 27	NP	19									

GENERAL NOTES

WATER LEVEL DATA

Begin Drilling **06-17-2014** Complete Drilling **06-17-2014**
 Drilling Contractor **Wang Testing Services** Drill Rig **B-57 TMR [100%]**
 Driller **N&K** Logger **A. Happel** Checked by **C. Marin**
 Drilling Method **3.25" HSA to 10', mud rotary thereafter, boring backfilled upon completion**

While Drilling ∇ **76.75 ft**
 At Completion of Drilling ∇ **mud in the borehole**
 Time After Drilling **NA**
 Depth to Water ∇ **NA**

The stratification lines represent the approximate boundary between soil types; the actual transition may be gradual.

WANGENGINC 11000401.GPJ WANGENG.GDT 8/30/19



BORING LOG 2055-B-03

wangeng@wangeng.com
 1145 N Main Street
 Lombard, IL 60148
 Telephone: (630) 953-9928
 Fax: (630) 953-9938

WEI Job No.: 1100-04-01

Client: **AECOM**
 Project: **Jane Byrne Interchange**
 Location: **Section 17, T39N, R14E of 3rd PM**

Datum: NAVD 88
 Elevation: 579.03 ft
 North: 1898462.94 ft
 East: 1171413.63 ft
 Station: 8149+26.26
 Offset: 58.3388 LT

Profile	Elevation (ft)	SOIL AND ROCK DESCRIPTION	Depth (ft)	Sample Type recovery	Sample No.	SPT Values (blw/6 in)	Qu (tsf)	Moisture Content (%)	Profile	Elevation (ft)	SOIL AND ROCK DESCRIPTION	Depth (ft)	Sample Type recovery	Sample No.	SPT Values (blw/6 in)	Qu (tsf)	Moisture Content (%)
	578.5	6-inch thick, black SILTY CLAY LOAM --TOPSOIL-- Very stiff to hard, brown and gray SILTY CLAY LOAM, trace gravel and brick --FILL--			1	7 9 9	4.50 P	14						9	1 1 1	0.41 B	27
			5		2	3 4 4	2.46 B	14				25		10	1 1 1	0.49 B	27
					3	4 5 5	2.50 P	16						11	0 2 1	0.49 B	27
	571.0	Soft to medium stiff, gray CLAY to SILTY CLAY, trace gravel			4	1 2 2	0.49 B	24						12	0 2 1	0.49 B	27
					5	0 2 1	0.41 B	25									
			15		6	0 2 2	0.57 B	26				35		13	1 1 2	0.49 B	26
					7	0 1 2	0.49 B	26									
					8	0 1 2	0.41 B	26		542.3	Medium stiff to very stiff, gray SILTY CLAY to CLAY, trace gravel			14	2 2 4	0.74 B	20

GENERAL NOTES

Begin Drilling **05-15-2013** Complete Drilling **05-16-2013**
 Drilling Contractor **Wang Testing Services** Drill Rig **CME-55 TMR [85%]**
 Driller **P&N** Logger **F. Bozga** Checked by **C. Marin**
 Drilling Method **2.25" HSA to 10', mud rotary thereafter, boring**
backfilled upon completion

WATER LEVEL DATA

While Drilling **groundwater not observed**
 At Completion of Drilling **▼ mud in the borehole**
 Time After Drilling **NA**
 Depth to Water **▼ NA**

The stratification lines represent the approximate boundary between soil types; the actual transition may be gradual.

WANGENGINC 11000401.GPJ WANGENG.GDT 8/30/19



BORING LOG 2055-B-03

wangeng@wangeng.com
 1145 N Main Street
 Lombard, IL 60148
 Telephone: (630) 953-9928
 Fax: (630) 953-9938

WEI Job No.: 1100-04-01

Client: **AECOM**
 Project: **Jane Byrne Interchange**
 Location: **Section 17, T39N, R14E of 3rd PM**

Datum: NAVD 88
 Elevation: 579.03 ft
 North: 1898462.94 ft
 East: 1171413.63 ft
 Station: 8149+26.26
 Offset: 58.3388 LT

Profile	Elevation (ft)	SOIL AND ROCK DESCRIPTION	Depth (ft)	Sample Type recovery	Sample No.	SPT Values (blw/6 in)	Qu (tsf)	Moisture Content (%)	Profile	Elevation (ft)	SOIL AND ROCK DESCRIPTION	Depth (ft)	Sample Type recovery	Sample No.	SPT Values (blw/6 in)	Qu (tsf)	Moisture Content (%)
	522.3	Medium dense, gray SILT								517.3	Hard, gray SILTY CLAY LOAM, trace gravel						
			45	X	15	3 7 9	2.30 B	16				65	X	19	13 18 30	4.50 P	16
			50	X	16	4 8 11	2.46 B	18				70	X	20	13 23 32	10.25 B	15
			55	X	17	3 7 8	2.30 B	24		507.3	Very dense, gray SILT to SILTY LOAM, trace gravel						
			55	X	17	3 7 8	2.30 B	24				75	X	21	32 50/5"	NP	10
			60	X	18	2 4 6	NP	23				80	X	22	40 50/2"	NP	9

GENERAL NOTES

WATER LEVEL DATA

Begin Drilling **05-15-2013** Complete Drilling **05-16-2013**
 Drilling Contractor **Wang Testing Services** Drill Rig **CME-55 TMR [85%]**
 Driller **P&N** Logger **F. Bozga** Checked by **C. Marin**
 Drilling Method **2.25" HSA to 10', mud rotary thereafter, boring**
backfilled upon completion

While Drilling **groundwater not observed**
 At Completion of Drilling **▼ mud in the borehole**
 Time After Drilling **NA**
 Depth to Water **▼ NA**

The stratification lines represent the approximate boundary between soil types; the actual transition may be gradual.

WANGENGINC 11000401.GPJ WANGENG.GDT 8/30/19



BORING LOG 2055-B-03

wangeng@wangeng.com
 1145 N Main Street
 Lombard, IL 60148
 Telephone: (630) 953-9928
 Fax: (630) 953-9938

WEI Job No.: 1100-04-01

Client **AECOM**
 Project **Jane Byrne Interchange**
 Location **Section 17, T39N, R14E of 3rd PM**

Datum: NAVD 88
 Elevation: 579.03 ft
 North: 1898462.94 ft
 East: 1171413.63 ft
 Station: 8149+26.26
 Offset: 58.3388 LT

Profile	Elevation (ft)	SOIL AND ROCK DESCRIPTION	Depth (ft)	Sample Type recovery	Sample No.	SPT Values (blw/6 in)	Qu (tsf)	Moisture Content (%)	Profile	Elevation (ft)	SOIL AND ROCK DESCRIPTION	Depth (ft)	Sample Type recovery	Sample No.	SPT Values (blw/6 in)	Qu (tsf)	Moisture Content (%)
			85		23	26 38 44	NP	19									
	492.3	Hard, gray SILTY CLAY LOAM															
			90		24	18 21 35	8.20 B	14									
	487.3	Very dense, gray SANDY GRAVEL with dolostone clasts															
	485.0	Probably weathered DOLOSTONE			25	48	NP	13									
	484.0	--AUGER REFUSAL-- Boring terminated at 95.00 ft	95			50 1"											

GENERAL NOTES

WATER LEVEL DATA

Begin Drilling **05-15-2013** Complete Drilling **05-16-2013**
 Drilling Contractor **Wang Testing Services** Drill Rig **CME-55 TMR [85%]**
 Driller **P&N** Logger **F. Bozga** Checked by **C. Marin**
 Drilling Method **2.25" HSA to 10', mud rotary thereafter, boring**
 **backfilled upon completion**

While Drilling **groundwater not observed**
 At Completion of Drilling **▼ mud in the borehole**
 Time After Drilling **NA**
 Depth to Water **▼ NA**

The stratification lines represent the approximate boundary between soil types; the actual transition may be gradual.

WANGENGINC 11000401.GPJ WANGENG.GDT 8/30/19



BORING LOG 2055-B-06

wangeng@wangeng.com
 1145 N Main Street
 Lombard, IL 60148
 Telephone: (630) 953-9928
 Fax: (630) 953-9938

WEI Job No.: 1100-04-01

Client: **AECOM**
 Project: **Jane Byrne Interchange**
 Location: **Section 17, T39N, R14E of 3rd PM**

Datum: NAVD 88
 Elevation: 575.52 ft
 North: 1898460.17 ft
 East: 1171341.21 ft
 Station: 8148+53.80
 Offset: 57.3869 LT

Profile	Elevation (ft)	SOIL AND ROCK DESCRIPTION	Depth (ft)	Sample Type recovery	Sample No.	SPT Values (blw/6 in)	Qu (tsf)	Moisture Content (%)	Profile	Elevation (ft)	SOIL AND ROCK DESCRIPTION	Depth (ft)	Sample Type recovery	Sample No.	SPT Values (blw/6 in)	Qu (tsf)	Moisture Content (%)
	575.15	15.5-inch thick ASPHALT --PAVEMENT--															
		Medium dense, gray CRUSHED STONE --BASE COURSE--			1	4 7 8	NP	8						9	0 1 2	0.25 B	27
	572.5	Very soft to medium stiff, gray CLAY to SILTY CLAY, trace gravel			2	1 1 2	0.33 B	24						10	1 1 2	< 0.25 P	28
					3	0 1 1	0.25 B	25						11	1 2 2	0.49 B	26
					4	0 0 1	0.25 B	27						12	1 2 2	0.57 B	26
					5	0 1 1	0.25 B	26		543.8	Medium stiff to very stiff, gray SILTY CLAY to CLAY, trace gravel						
					6	0 1 1	0.25 B	25						13	1 2 6	0.66 B	21
					7	1 1 1	0.25 B	26									
					8	0 1 2	0.33 B	28						14	6 8 9	2.54 B	14

GENERAL NOTES

WATER LEVEL DATA

Begin Drilling **05-13-2013** Complete Drilling **05-15-2013**
 Drilling Contractor **Wang Testing Services** Drill Rig **CME-55 TMR [85%]**
 Driller **P/N** Logger **F. Bozga** Checked by **C. Marin**
 Drilling Method **2.25" HSA to 15', mud rotary thereafter, boring**
backfilled upon completion

While Drilling **groundwater not observed**
 At Completion of Drilling **▼ mud in the borehole**
 Time After Drilling **NA**
 Depth to Water **▼ NA**

The stratification lines represent the approximate boundary between soil types; the actual transition may be gradual.

WANGENGINC 11000401.GPJ WANGENG.GDT 8/30/19



BORING LOG 2055-B-06

wangeng@wangeng.com
 1145 N Main Street
 Lombard, IL 60148
 Telephone: (630) 953-9928
 Fax: (630) 953-9938

WEI Job No.: 1100-04-01

Client: **AECOM**
 Project: **Jane Byrne Interchange**
 Location: **Section 17, T39N, R14E of 3rd PM**

Datum: NAVD 88
 Elevation: 575.52 ft
 North: 1898460.17 ft
 East: 1171341.21 ft
 Station: 8148+53.80
 Offset: 57.3869 LT

Profile	Elevation (ft)	SOIL AND ROCK DESCRIPTION	Depth (ft)	Sample Type recovery	Sample No.	SPT Values (blw/6 in)	Qu (tsf)	Moisture Content (%)	Profile	Elevation (ft)	SOIL AND ROCK DESCRIPTION	Depth (ft)	Sample Type recovery	Sample No.	SPT Values (blw/6 in)	Qu (tsf)	Moisture Content (%)
	513.8									513.8	Hard, gray SILTY CLAY LOAM, trace to little gravel						
			45		15	4 7 12	1.97 B	15				65		19	13 25 38	10.25 B	15
			50		16	5 7 10	2.95 B	22				70		20	14 23 27	8.04 B	15
		Possible cobble-rich layer									--HARD DRILLING--						
			55		17	4 6 7	1.75 P	22				75		21	47 50/5"	9.02 B	12
	518.8	Dense, gray SILTY LOAM, trace gravel								498.4	--HARD DRILLING-- Very dense, gray SILTY LOAM to SILT, trace to some gravel						
			60		18	8 16 23	NP	18				80		22	50/4"	NP	11

GENERAL NOTES

WATER LEVEL DATA

Begin Drilling **05-13-2013** Complete Drilling **05-15-2013**
 Drilling Contractor **Wang Testing Services** Drill Rig **CME-55 TMR [85%]**
 Driller **P/N** Logger **F. Bozga** Checked by **C. Marin**
 Drilling Method **2.25" HSA to 15', mud rotary thereafter, boring**
backfilled upon completion

While Drilling **groundwater not observed**
 At Completion of Drilling **▼ mud in the borehole**
 Time After Drilling **NA**
 Depth to Water **▼ NA**

The stratification lines represent the approximate boundary between soil types; the actual transition may be gradual.

WANGENGINC 11000401.GPJ WANGENG.GDT 8/30/19



BORING LOG 2055-B-06

wangeng@wangeng.com
 1145 N Main Street
 Lombard, IL 60148
 Telephone: (630) 953-9928
 Fax: (630) 953-9938

WEI Job No.: 1100-04-01

Client: **AECOM**
 Project: **Jane Byrne Interchange**
 Location: **Section 17, T39N, R14E of 3rd PM**

Datum: NAVD 88
 Elevation: 575.52 ft
 North: 1898460.17 ft
 East: 1171341.21 ft
 Station: 8148+53.80
 Offset: 57.3869 LT

Profile	Elevation (ft)	SOIL AND ROCK DESCRIPTION	Depth (ft)	Sample Type recovery	Sample No.	SPT Values (blw/6 in)	Qu (tsf)	Moisture Content (%)	Profile	Elevation (ft)	SOIL AND ROCK DESCRIPTION	Depth (ft)	Sample Type recovery	Sample No.	SPT Values (blw/6 in)	Qu (tsf)	Moisture Content (%)
											moderately vuggy porosity. Run 1 - RECOVERY = 98% RQD = 72% 97.5ft-Qu=10330 psi ---->			1			
			85		23	29 40 33	NP	22				105					
										469.5	Boring terminated at 106.00 ft						
			90		24	19 23 28	NP	17				110					
	481.5	Probably weathered DOLOSTONE	95		25	25 50/2	NP	16				115					
	479.5	--AUGER REFUSAL--															
		Strong, light gray, good rock mass quality, bedded fresh DOLOSTONE, with shale partings, up to 18-inch beds, 1- to 18-inch spaced joints, horizontal and oblique joints with less than 0.2- to 1-inch greenish gray silty infilling, hard joint wall, with stylolitic surfaces, and	100									120					

GENERAL NOTES

Begin Drilling **05-13-2013** Complete Drilling **05-15-2013**
 Drilling Contractor **Wang Testing Services** Drill Rig **CME-55 TMR [85%]**
 Driller **P/N** Logger **F. Bozga** Checked by **C. Marin**
 Drilling Method **2.25" HSA to 15', mud rotary thereafter, boring backfilled upon completion**

WATER LEVEL DATA

While Drilling **groundwater not observed**
 At Completion of Drilling **mud in the borehole**
 Time After Drilling **NA**
 Depth to Water **NA**

The stratification lines represent the approximate boundary between soil types; the actual transition may be gradual.

WANGENGINC 11000401.GPJ WANGENG.GDT 8/30/19



wangeng@wangeng.com
 1145 N Main Street
 Lombard, IL 60148
 Telephone: (630) 953-9928
 Fax: (630) 953-9938

BORING LOG 38-RWB-01

WEI Job No.: 1100-04-01

Client: **AECOM**
 Project: **Jane Byrne Interchange**
 Location: **Section 17, T39N, R14E of 3rd PM**

Datum: NAVD 88
 Elevation: 577.87 ft
 North: 1898674.22 ft
 East: 1171408.18 ft
 Station: 1316+53.06
 Offset: 42.7366 LT

Profile	Elevation (ft)	SOIL AND ROCK DESCRIPTION	Depth (ft)	Sample Type recovery	Sample No.	SPT Values (blw/6 in)	Qu (tsf)	Moisture Content (%)	Profile	Elevation (ft)	SOIL AND ROCK DESCRIPTION	Depth (ft)	Sample Type recovery	Sample No.	SPT Values (blw/6 in)	Qu (tsf)	Moisture Content (%)
	576.6	4.5-inch thick, ASPHALT over 10.5-inch thick, CONCRETE --PAVEMENT--															
	575.6	13-inch thick SANDY GRAVEL --BASE COURSE--			1	8 3 3	1.50 P	18						9	1 2 3	0.16 B	26
	574.9	Stiff, gray SILTY CLAY, trace gravel --FILL--			2	1 1 2	0.16 B	23				25		10	1 2 2	0.16 B	25
		Very soft to soft, gray CLAY to SILTY CLAY, trace gravel	5		3	1 1 2	0.16 B	24						11	1 2 2	0.67 N/6	
			10		4	0 1 2	0.16 B	23				30		12	2 3 3	0.25 B	27
					5	1 1 1	0.08 B	26									
			15		6	1 1 2	0.50 N/6					35		13	1 1 3	0.08 B	23
					7	1 1 2	0.16 B	26									
			20		8	1 1 2	0.08 B	26				40		14	2 4 6	0.25 B	26

GENERAL NOTES

Begin Drilling **08-19-2014** Complete Drilling **08-19-2014**
 Drilling Contractor **Wang Testing Services** Drill Rig **CME-55 TMR [85%]**
 Driller **R&J** Logger **S. Woods** Checked by **C. Marin**
 Drilling Method **2.25" SSA to 10', mud rotary thereafter, boring**
backfilled upon completion

WATER LEVEL DATA

While Drilling **groundwater not observed**
 At Completion of Drilling **▼ mud in the borehole**
 Time After Drilling **NA**
 Depth to Water **▼ NA**

The stratification lines represent the approximate boundary between soil types; the actual transition may be gradual.

WANGENGINC 11000401.GPJ WANGENG.GDT 8/30/19



wangeng@wangeng.com
 1145 N Main Street
 Lombard, IL 60148
 Telephone: (630) 953-9928
 Fax: (630) 953-9938

BORING LOG 38-RWB-01

WEI Job No.: 1100-04-01

Client: **AECOM**
 Project: **Jane Byrne Interchange**
 Location: **Section 17, T39N, R14E of 3rd PM**

Datum: NAVD 88
 Elevation: 577.87 ft
 North: 1898674.22 ft
 East: 1171408.18 ft
 Station: 1316+53.06
 Offset: 42.7366 LT

Profile	Elevation (ft)	SOIL AND ROCK DESCRIPTION	Depth (ft)	Sample Type recovery	Sample No.	SPT Values (blw/6 in)	Qu (tsf)	Moisture Content (%)	Profile	Elevation (ft)	SOIL AND ROCK DESCRIPTION	Depth (ft)	Sample Type recovery	Sample No.	SPT Values (blw/6 in)	Qu (tsf)	Moisture Content (%)
	536.1										gravel						
		Very stiff to hard, gray SILTY CLAY to SILTY CLAY LOAM, trace gravel	45	X	15	6 8 10	4.10 B	13		512.9		65	X	19	15 21 25	NP	19
											Boring terminated at 65.00 ft						
			50	X	16	4 6 12	2.38 B	17				70					
			55	X	17	5 9 10	2.54 B	23				75					
	521.1	Very soft (0.16B), gray CLAY															
	518.6	Dense, gray SILTY LOAM, trace	60	X	18	2 3 6	NP	20				80					

GENERAL NOTES

WATER LEVEL DATA

Begin Drilling **08-19-2014** Complete Drilling **08-19-2014**
 Drilling Contractor **Wang Testing Services** Drill Rig **CME-55 TMR [85%]**
 Driller **R&J** Logger **S. Woods** Checked by **C. Marin**
 Drilling Method **2.25" SSA to 10', mud rotary thereafter, boring backfilled upon completion**

While Drilling **groundwater not observed**
 At Completion of Drilling **▼ mud in the borehole**
 Time After Drilling **NA**
 Depth to Water **▼ NA**

The stratification lines represent the approximate boundary between soil types; the actual transition may be gradual.

WANGENGINC 11000401.GPJ WANGENG.GDT 8/30/19



wangeng@wangeng.com
 1145 N Main Street
 Lombard, IL 60148
 Telephone: (630) 953-9928
 Fax: (630) 953-9938

BORING LOG 38-RWB-01HA

WEI Job No.: 1100-04-01

Client: **AECOM**
 Project: **Jane Byrne Interchange**
 Location: **Section 17, T39N, R14E of 3rd PM**

Datum: NAVD 88
 Elevation: 589.82 ft
 North: 1898677.09 ft
 East: 1171357.96 ft
 Station: 1316+53.10
 Offset: 7.5636 RT

Profile	Elevation (ft)	SOIL AND ROCK DESCRIPTION	Depth (ft)	Sample Type recovery	Sample No.	SPT Values (blw/6 in)	Qu (tsf)	Moisture Content (%)	Profile	Elevation (ft)	SOIL AND ROCK DESCRIPTION	Depth (ft)	Sample Type recovery	Sample No.	SPT Values (blw/6 in)	Qu (tsf)	Moisture Content (%)
	588.3	Black LOAM, trace gravel, w/roots, w/wood chips --TOPSOIL--			1	P U S H	NP	21									
		Gray SILTY LOAM to SILTY CLAY LOAM, trace gravel --FILL--			2	P U S H	NP	19									
	584.8		5		3	P U S H	2.50 P	19									
		Stiff to very stiff, gray SILTY CLAY, trace gravel			4	P U S H	1.50 P	20									
	581.3				5	P U S H	0.40 P	19									
	579.8	Soft, gray CLAY to SILTY CLAY, trace gravel	10														
		Boring terminated at 10.00 ft															

GENERAL NOTES

Begin Drilling **08-28-2014** Complete Drilling **08-28-2014**
 Drilling Contractor **Wang Testing Services** Drill Rig **Geoprobe HA**
 Driller **R&J** Logger **S. Woods** Checked by **C. Marin**
 Drilling Method **1" IDA Pneumatic Geoprobe LB Sampler**

WATER LEVEL DATA

While Drilling ∇ **DRY**
 At Completion of Drilling ∇ **DRY**
 Time After Drilling **NA**
 Depth to Water ∇ **NA**

The stratification lines represent the approximate boundary between soil types; the actual transition may be gradual.



wangeng@wangeng.com
 1145 N Main Street
 Lombard, IL 60148
 Telephone: (630) 953-9928
 Fax: (630) 953-9938

BORING LOG 38-RWB-02

WEI Job No.: 1100-04-01

Client: **AECOM**
 Project: **Jane Byrne Interchange**
 Location: **Section 17, T39N, R14E of 3rd PM**

Datum: NAVD 88
 Elevation: 576.09 ft
 North: 1898515.97 ft
 East: 1171368.28 ft
 Station: 1318+10.03
 Offset: 21.6181 LT

Profile	Elevation (ft)	SOIL AND ROCK DESCRIPTION	Depth (ft)	Sample Type recovery	Sample No.	SPT Values (blw/6 in)	Qu (tsf)	Moisture Content (%)	Profile	Elevation (ft)	SOIL AND ROCK DESCRIPTION	Depth (ft)	Sample Type recovery	Sample No.	SPT Values (blw/6 in)	Qu (tsf)	Moisture Content (%)
	575.6	5-inch thick, ASPHALT --PAVEMENT--															
	574.8	10-inch thick, gray SANDY GRAVEL --FILL--			1	1 2 2	1.97 B	17						10	1 1 2	0.33 B	25
	573.3	Stiff, gray SILTY CLAY to SILTY CLAY LOAM, trace gravel --FILL--			2	1 1 1 2	0.33 B	26				25		11	1 1 1 2	0.25 B	25
		Soft, gray CLAY to SILTY CLAY, trace gravel	5		3	1 1 2 2	0.33 B	25						12	1 1 2	0.33 B	24
			10		5	2 2 2 2	0.25 B	26				30		13	1 2 3	0.49 B	25
			15		7	1 1 1	0.33 B	26				35		14	2 3 3	0.49 B	20
					8	1 1 1	0.25 B	23		539.3	Stiff to very stiff, gray SILTY CLAY to SILTY CLAY LOAM, trace gravel			15	5 6 8	2.46 B	19
			20		9	1 1 1	0.33 B	24				40					

GENERAL NOTES

WATER LEVEL DATA

Begin Drilling **08-20-2014** Complete Drilling **08-20-2014**
 Drilling Contractor **Wang Testing Services** Drill Rig **CME-55 TMR [85%]**
 Driller **R&J** Logger **S. Woods** Checked by **C. Marin**
 Drilling Method **Solid flight auger to 11', mud rotary thereafter,**
boring backfilled upon completion

While Drilling **groundwater not observed**
 At Completion of Drilling **▼ mud in the borehole**
 Time After Drilling **NA**
 Depth to Water **▼ NA**
 The stratification lines represent the approximate boundary between soil types; the actual transition may be gradual.

WANGENGINC 11000401.GPJ WANGENG.GDT 8/30/19



wangeng@wangeng.com
 1145 N Main Street
 Lombard, IL 60148
 Telephone: (630) 953-9928
 Fax: (630) 953-9938

BORING LOG 38-RWB-02HA

WEI Job No.: 1100-04-01

Client: **AECOM**
 Project: **Jane Byrne Interchange**
 Location: **Section 17, T39N, R14E of 3rd PM**

Datum: NAVD 88
 Elevation: 582.04 ft
 North: 1898532.77 ft
 East: 1171339.09 ft
 Station: 1318+00.41
 Offset: 10.6331 RT

Profile	Elevation (ft)	SOIL AND ROCK DESCRIPTION	Depth (ft)	Sample Type recovery	Sample No.	SPT Values (blw/6 in)	Qu (tsf)	Moisture Content (%)	Profile	Elevation (ft)	SOIL AND ROCK DESCRIPTION	Depth (ft)	Sample Type recovery	Sample No.	SPT Values (blw/6 in)	Qu (tsf)	Moisture Content (%)
	581.0	12-inch thick, black LOAM, trace gravel and brick fragments --TOPSOIL--			1	P U S H	NP	21									
	580.3	Brown, SANDY GRAVEL, trace brick fragments --FILL--															
		Very stiff, gray SILTY CLAY LOAM to SILTY CLAY, trace gravel --FILL--			2	P U S H	2.50 P	16									
			5		3	P U S H	2.00 P	16									
	575.0				4	P U S H	0.70 P	19									
		Soft to medium stiff, gray CLAY to SILTY CLAY, trace gravel															
					5	P U S H	0.40 P	20									
	572.0		10														
		Boring terminated at 10.00 ft															

GENERAL NOTES

Begin Drilling **08-28-2014** Complete Drilling **08-28-2014**
 Drilling Contractor **Wang Testing Services** Drill Rig **Geoprobe HA**
 Driller **R&J** Logger **S. Woods** Checked by **C. Marin**
 Drilling Method **1" IDA Pneumatic Geoprobe LB Sampler**

WATER LEVEL DATA

While Drilling ∇ **DRY**
 At Completion of Drilling ∇ **DRY**
 Time After Drilling **NA**
 Depth to Water ∇ **NA**

The stratification lines represent the approximate boundary between soil types; the actual transition may be gradual.



wangeng@wangeng.com
 1145 N Main Street
 Lombard, IL 60148
 Telephone: (630) 953-9928
 Fax: (630) 953-9938

BORING LOG 39-RWB-01

WEI Job No.: 1100-04-01

Client **AECOM**
 Project **Jane Byrne Interchange**
 Location **Section 17, T39N, R14E of 3rd PM**

Datum: NAVD 88
 Elevation: 581.87 ft
 North: 1898358.83 ft
 East: 1171247.64 ft
 Station: 1320+04.07
 Offset: 27.4619 RT

Profile	Elevation (ft)	SOIL AND ROCK DESCRIPTION	Depth (ft)	Sample Type recovery	Sample No.	SPT Values (blw/6 in)	Qu (tsf)	Moisture Content (%)	Profile	Elevation (ft)	SOIL AND ROCK DESCRIPTION	Depth (ft)	Sample Type recovery	Sample No.	SPT Values (blw/6 in)	Qu (tsf)	Moisture Content (%)
	581.63	1-inch thick, ASPHALT --PAVEMENT--															
	580.71	1-inch thick, CONCRETE --PAVEMENT--															
	578.9	Loose, gray SANDY LOAM, trace gravel and brick fragments --FILL--			1	2 4 3	NP	12						9	1 1 1	0.16 B	28
		Stiff, gray SILTY CLAY, trace gravel			2	1 3 4	1.15 B	21						10	1 1 2	< 0.25 P	29
	576.4	Very soft to medium stiff, gray CLAY to SILTY CLAY, trace gravel			3	0 0 2	0.33 B	26						11	0 1 2	0.49 B	25
					4	0 1 1	0.49 B	25						12	0 2 3	0.82 B	25
					5	0 0 1	0.08 B	28									
					6	0 0 0	0.25 B	27						13	3 3 5	0.82 B	18
					7	0 0 1	0.16 B	25									
					8	0 0 0	0.16 B	26						14	4 7 17	0.70 P	29

GENERAL NOTES

Begin Drilling **08-07-2014** Complete Drilling **08-07-2014**
 Drilling Contractor **Wang Testing Services** Drill Rig
 Driller **R&J** Logger **S. Woods** Checked by **C. Marin**
 Drilling Method **2.25" SSA to 10', mud rotary thereafter, boring**
backfilled upon completion

WATER LEVEL DATA

While Drilling **2.50 ft**
 At Completion of Drilling **mud in the borehole**
 Time After Drilling **NA**
 Depth to Water **NA**

The stratification lines represent the approximate boundary between soil types; the actual transition may be gradual.

WANGENGINC 11000401.GPJ WANGENG.GDT 10/8/19



wangeng@wangeng.com
 1145 N Main Street
 Lombard, IL 60148
 Telephone: (630) 953-9928
 Fax: (630) 953-9938

BORING LOG 39-RWB-01HA

WEI Job No.: 1100-04-01

Client: **AECOM**
 Project: **Jane Byrne Interchange**
 Location: **Section 17, T39N, R14E of 3rd PM**

Datum: NAVD 88
 Elevation: 580.50 ft
 North: 1898317.61 ft
 East: 1171210.29 ft
 Station: 1320+62.52
 Offset: 33.3936' RT

Profile	Elevation (ft)	SOIL AND ROCK DESCRIPTION	Depth (ft)	Sample Type recovery	Sample No.	SPT Values (blw/6 in)	Qu (tsf)	Moisture Content (%)	Profile	Elevation (ft)	SOIL AND ROCK DESCRIPTION	Depth (ft)	Sample Type recovery	Sample No.	SPT Values (blw/6 in)	Qu (tsf)	Moisture Content (%)
	580.0	6-inch thick, brown CLAY LOAM, trace roots															
		--TOPSOIL--															
	578.7	Very stiff, gray SILTY CLAY LOAM, trace gravel			1	PUSH	3.00	17									
		Gray, fine to coarse SAND			2	PUSH	NP	4									
			5		3	PUSH	NP	11									
					4	PUSH	NP	6									
					5	PUSH	NP	16									
	571.0	--Wet--															
		Boring terminated at 9.50 ft	10														

GENERAL NOTES

Begin Drilling **10-28-2014** Complete Drilling **10-28-2014**
 Drilling Contractor **Wang Testing Services** Drill Rig
 Driller **P&P** Logger **F. Bozga** Checked by **M. Seyhun**
 Drilling Method **1" IDA Pneumatic Geoprobe LB Sampler**

WATER LEVEL DATA

While Drilling ∇ **DRY**
 At Completion of Drilling ∇ **DRY**
 Time After Drilling **NA**
 Depth to Water ∇ **NA**

The stratification lines represent the approximate boundary between soil types; the actual transition may be gradual.



BORING LOG SB90-SGB-08

wangeng@wangeng.com
 1145 N Main Street
 Lombard, IL 60148
 Telephone: (630) 953-9928
 Fax: (630) 953-9938

WEI Job No.: 1100-04-01

Client: **AECOM**
 Project: **Jane Byrne Interchange**
 Location: **Section 17, T39N, R14E of 3rd PM**

Datum: NAVD 88
 Elevation: 577.36 ft
 North: 1898496.00 ft
 East: 1171483.87 ft
 Station: 6219+57.67
 Offset: 15.3260 LT

Profile	Elevation (ft)	SOIL AND ROCK DESCRIPTION	Depth (ft)	Sample Type recovery	Sample No.	SPT Values (blw/6 in)	Qu (tsf)	Moisture Content (%)	Profile	Elevation (ft)	SOIL AND ROCK DESCRIPTION	Depth (ft)	Sample Type recovery	Sample No.	SPT Values (blw/6 in)	Qu (tsf)	Moisture Content (%)
	576.9	5-inch thick, ASPHALT --PAVEMENT--															
	576.6	4-inch thick, CONCRETE --PAVEMENT--															
		Medium dense, gray SANDY GRAVEL, crushed stone --AGGREGATE BASE--			1	13 11 12 8	NP	6									
	574.6	Soft to stiff, gray CLAY to SILTY CLAY, trace gravel			2	5 3 3 3	1.39 B	21									
					3	1 2 2 3	0.33 B	24									
					4	0 2 2 2	0.49 B	25									
					5	0 2 2 2	0.49 B	24									
	566.4	Boring terminated at 11.00 ft															

GENERAL NOTES

WATER LEVEL DATA

Begin Drilling **10-26-2014** Complete Drilling **10-26-2014**
 Drilling Contractor **Wang Testing Services** Drill Rig **B-57 TMR [100%]**
 Driller **P&P** Logger **F. Bozga** Checked by **C. Marin**
 Drilling Method **2.25" SSA, boring backfilled upon completion**

While Drilling ∇ **DRY**
 At Completion of Drilling ∇ **DRY**
 Time After Drilling **NA**
 Depth to Water ∇ **NA**

The stratification lines represent the approximate boundary between soil types; the actual transition may be gradual.



wangeng@wangeng.com
 1145 N Main Street
 Lombard, IL 60148
 Telephone: (630) 953-9928
 Fax: (630) 953-9938

BORING LOG SB90-SGB-21

WEI Job No.: 1100-04-01

Client: **AECOM**
 Project: **Jane Byrne Interchange**
 Location: **Section 17, T39N, R14E of 3rd PM**

Datum: NAVD 88
 Elevation: 574.97 ft
 North: 1898288.91 ft
 East: 1171224.08 ft
 Station: 1320+76.26
 Offset: 4.4481 RT

Profile	Elevation (ft)	SOIL AND ROCK DESCRIPTION	Depth (ft)	Sample Type recovery	Sample No.	SPT Values (blw/6 in)	Qu (tsf)	Moisture Content (%)	Profile	Elevation (ft)	SOIL AND ROCK DESCRIPTION	Depth (ft)	Sample Type recovery	Sample No.	SPT Values (blw/6 in)	Qu (tsf)	Moisture Content (%)
	574.6	4.5-inch thick, ASPHALT --PAVEMENT--															
	574.0	7.5-inch thick, CONCRETE --PAVEMENT--															
		Loose, brown SANDY GRAVEL, crushed stone -- AGGREGATE BASE--			1	7 3 3 4		7									
	572.0	Very stiff, brown SILTY CLAY, trace gravel --FILL--			2	6 6 5 5	3.50 P	18									
	570.7	Medium stiff, gray CLAY to SILTY CLAY, trace gravel	5		3	2 2 3 3	0.95 B	25									
					4	1 2 3 3	0.90 B	24									
			10		5	2 2 3 4	0.90 B	25									
	564.0	Boring terminated at 11.00 ft															

GENERAL NOTES

Begin Drilling **10-15-2014** Complete Drilling **10-15-2014**
 Drilling Contractor **Wang Testing Services** Drill Rig **CME-55 TMR [85%]**
 Driller **R&J** Logger **F. Bozga** Checked by **C. Marin**
 Drilling Method **2.25" IDA HSA, boring backfilled upon completion**

WATER LEVEL DATA

While Drilling **DRY**
 At Completion of Drilling **DRY**
 Time After Drilling **NA**
 Depth to Water **NA**

The stratification lines represent the approximate boundary between soil types; the actual transition may be gradual.

APPENDIX B
IDOT BMPR 507A and 508A Forms



State Job Number: D-91-227-13 Project: Jane Byrne Interchange Route: I 90/94 and Ramps

Section: 2015-020B City or County: Cook Date: 07/11/2019

ADT: n.a Year: _____ Design Period: _____ Class Highway: NA

Passenger Cars Per Day: _____ Trucks S.U. Per Day: _____ Trucks M.U. Per Day: _____

Pavement Structure: _____

Type Surface Course: n.a. Thickness: n.a.

Type Base Course: n.a. Thickness: n.a.

Type Subbase Material: n.a. Thickness: n.a.

Sta. to Sta.	1315+34 to 1321+00 Ramp SW			
*Sta. of Test	1315+00			
*Drainage Class	Poor			
*Ave. Frost Penetration	42 in.			
Illinois Textural Classification	Clay Loam			
Classification and Group Index (AASHTO M 145)	A-6 (7)			
*Percent Silt (AASHTO T 88)	46.7			
*Illinois Bearing Ratio (%)				
Std. Dry Density (IL Mod. AASHTO T 99)				
Optimum Moisture (IL Mod AASHTO T 99)				

* Indicates worst condition within the above station limits.

Remarks: _____

SOIL TEST DATA

ROUTE

Jane Byrne Interchange Reconstruction

PROJECT

1100-04-01

SECTION

Ramp SW (Sta. 1315+34.11 to Sta. 1321+00.00)

COUNTY

Cook County

Lab. No.	1702-B-01 No.9
Station ft)	1315+00
Offset (ft)	14 RT
Depth (ft)	21
AASHTO M 145 Classification and Group Index	A-6 (7)
Illinois Textural Classification (Illinois Method)	Clay Loam
Gradation--Passing 1" Sieve %	
--"-- 3/4" Sieve %	
--"-- 1/2" Sieve %	
--"-- No.4 Sieve %	98.0
--"-- No.10 Sieve %	94.6
--"-- No.40 Sieve %	87.3
--"-- No.100 Sieve %	77.2
--"-- No.200 Sieve %	71.6
Sand % (AASHTO T 88)	23.0
Silt % (AASHTO T 88)	46.7
Clay % (AASHTO T 88)	24.8
Liquid limit % (AASHTO T 89)	28.0
Plasticity index % (AASHTO T 90)	15.0
IBR % (Illinois Method)	
Standard Dry Density % (AASHTO T 99)	
Optimum Moisture % (AASHTO T 99)	
Subgrade Support Rating	POOR
Insitu Moisture % (AASHTO T 99)	16

APPENDIX C

Laboratory Test Results

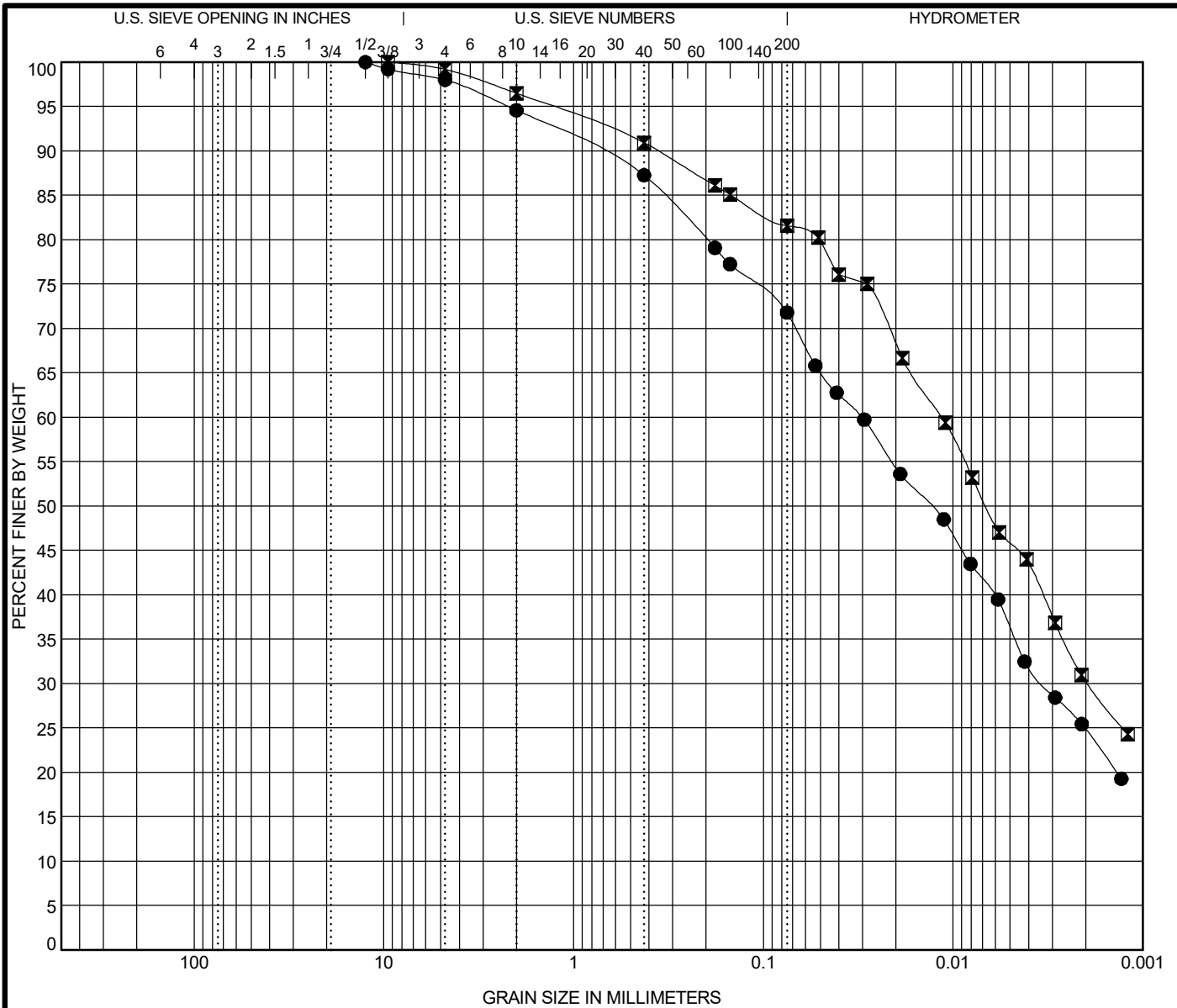

COBBLES	GRAVEL	SAND		SILT AND CLAY
		coarse	fine	

Specimen Identification	IDH Classification	LL	PL	PI	Cc	Cu
● 1702-B-01#9 21.0 ft	Clay Loam	28	14	14		
■ 28-RWB-01#15 43.5 ft	Silty Clay	30	16	14		

Specimen Identification	D100	D60	D30	D10	%Gravel	%Sand	%Silt	%Clay
● 1702-B-01#9 21.0 ft	12.5	0.03	0.003		5.4	23.0	46.7	24.8
■ 28-RWB-01#15 43.5 ft	9.5	0.011	0.002		3.5	15.0	51.2	30.4



Wang Engineering, Inc.
 1145 N Main Street
 Lombard, IL 60148
 Telephone: (630) 953-9928
 Fax: (630) 953-9938

GRAIN SIZE DISTRIBUTION
 Project: Jane Byrne Interchange
 Location: Section 17, T39N, R14E of 3rd PM
 Number: 1100-04-01

WEI GRAIN SIZE IDH 11000401.GPJ US LAB.GDT 8/28/19

Fractions normalized to 100% passing the 2mm (#10) sieve

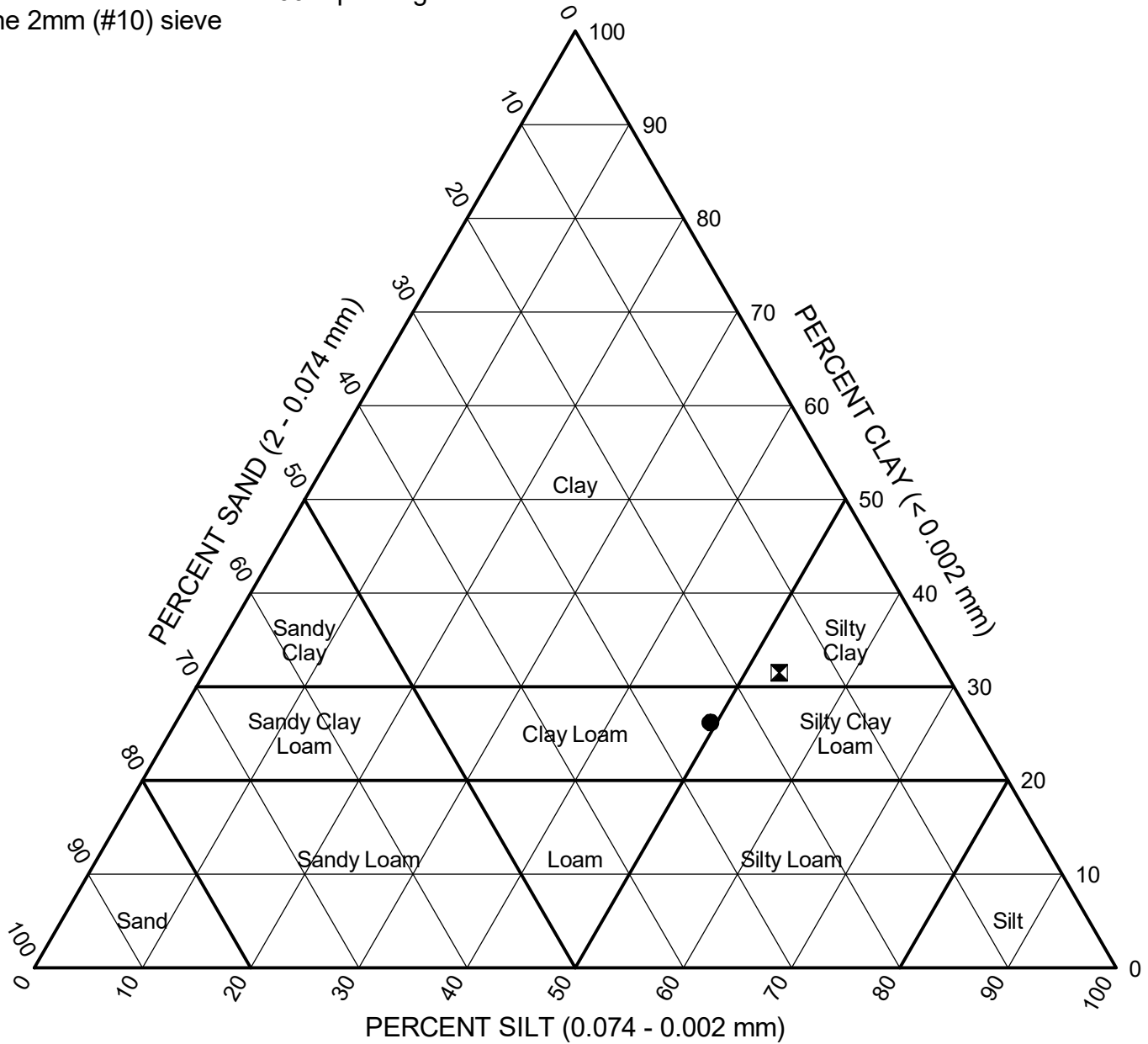

Sample	Depth (ft)	Sand (%)	Silt (%)	Clay (%)	Classification		
					IL DOT	AASHTO	ASTM
● 1702-B-01#9	21.0	24.3	49.4	26.2	Clay Loam	A-6 (7)	CL
☒ 28-RWB-01#15	43.5	15.5	53.1	31.5	Silty Clay	A-6 (10)	CL

WEI IDH 11000401.GPJ WANGENG.GDT 8/28/19



Wang Engineering, Inc.
 1145 N Main Street
 Lombard, IL 60148
 Telephone: (630) 953-9928
 Fax: (630) 953-9938

IDH Textural Classification Chart

Project: Jane Byrne Interchange
 Location: Section 17, T39N, R14E of 3rd PM
 Number: 1100-04-01

APPENDIX D
Proposed Pavement Structure

FILE PATH = p:\aecom\ms-ansi\encom\line\local\i\ecom\0502\NA\Documents\01\America\Transportation\60269938\Circle\Phase\I\000_CAD\006_Roadway\Sheets\62J31_Contract\0162J31-SHT-Typical-01.dgn

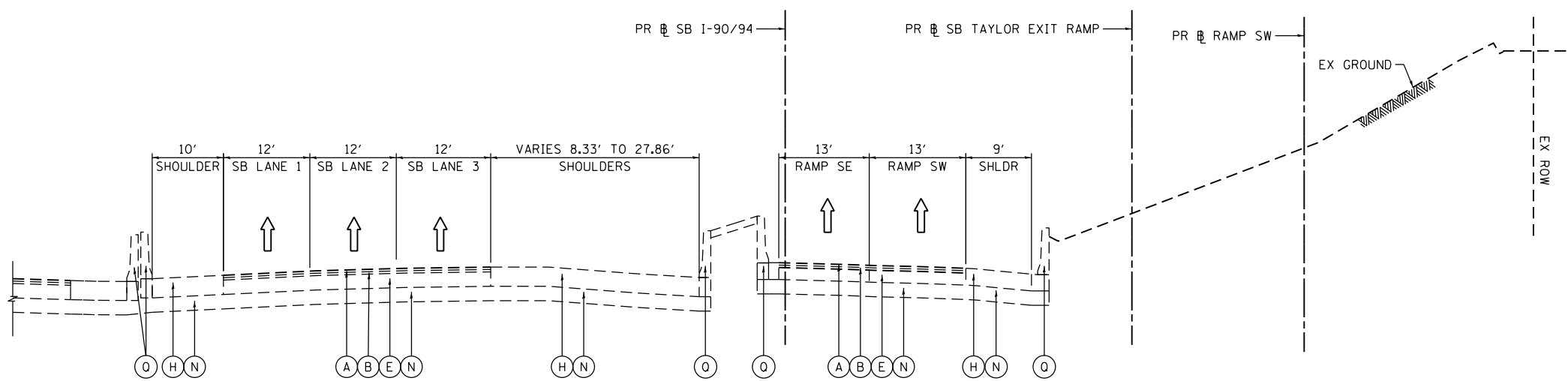

**EXISTING TYPICAL SECTION
RAMP SW
(LOOKING SOUTH)**

STA 1314+86.93 TO STA 1316+39.53 (PR SB RAMP SW)
STA 6400+00.00 TO STA 6401+14.43 (PR SB TAYLOR EXIT RAMP)

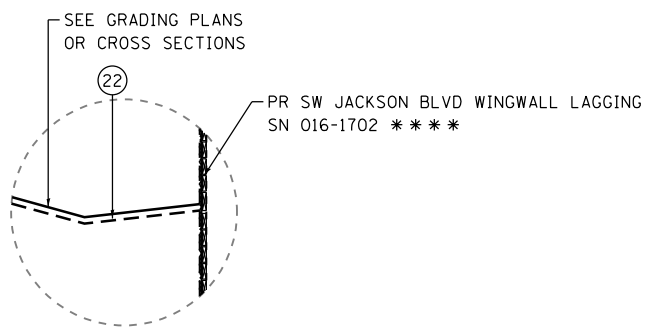

DETAIL "2"
SCALE: NONE
STA 1315+34.11 TO 1315+57.01

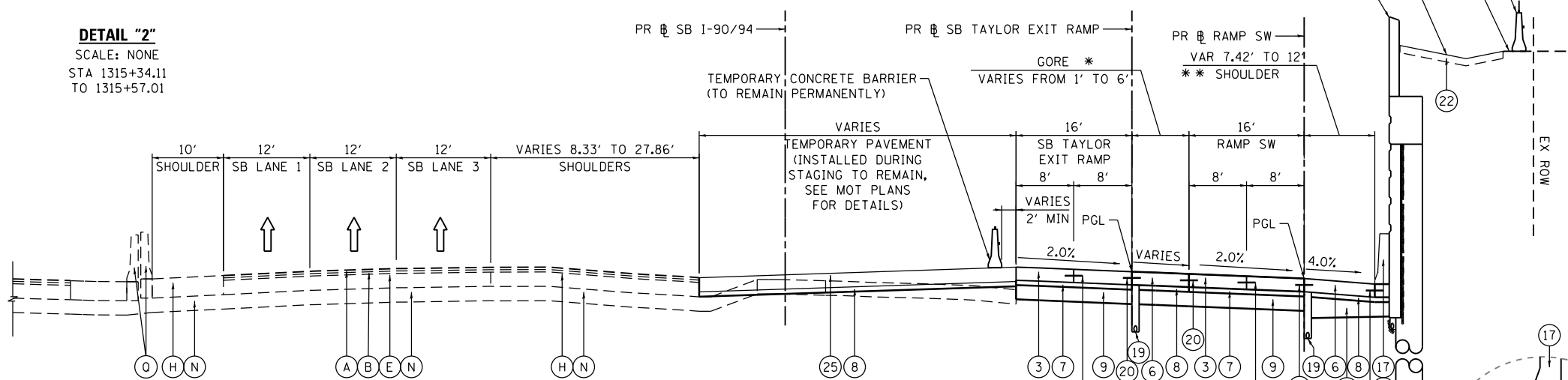

**PROPOSED TYPICAL SECTION
RAMP SW
(LOOKING SOUTH)**

STA 1315+34.11 TO STA 1316+39.53 (PR RAMP SW)
STA 6400+09.57 TO STA 6401+14.43 (PR SB TAYLOR EXIT RAMP)

- * GORE VARIES FROM 1' TO 6' STA 1315+34.11 TO STA 1315+81.95 (PR RAMP SW)
- ** SHOULDER VARIES FROM 7.4' TO 12' STA 1315+7.12 TO STA 1316+39.53 (PR RAMP SW)
- *** PR RET WALL 38 (SN 016-1827) BEGINS AT STA 1315+57.01 (PR RAMP SW)
- **** PR JACKSON BLVD BRIDGE SW WINGWALL, STA 1314+97.11 TO STA 1315+57.01 (PR RAMP SW)

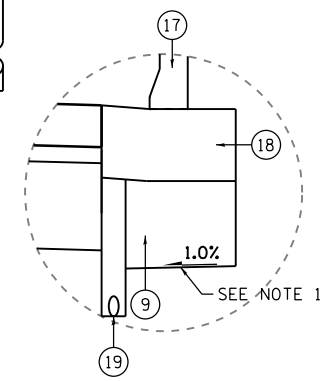

DETAIL "1"
SCALE: NONE
ALL TYPICAL SECTIONS

EXISTING

- (A) HOT MIX ASPHALT SURFACE COURSE, 1.5"
- (B) HOT MIX ASPHALT BINDER COURSE, 2.5"
- (C) HOT MIX ASPHALT PAVEMENT, 5" TO 11"
- (D) CONTINUOUSLY REINFORCED PCC PAVEMENT, 13"
- (E) PORTLAND CEMENT CONCRETE BASE COURSE, 10"
- (F) PORTLAND CEMENT CONCRETE PAVEMENT 9" (JOINTED)
- (G) PORTLAND CEMENT CONCRETE SHOULDERS 9"
- (H) BITUMINOUS SHOULDER, 13"
- (I) TEMPORARY PAVEMENT (PCC/HMA)
- (J) STABILIZED SUBBASE - HOT-MIX ASPHALT, 4"
- (K) SUBBASE GRANULAR MATERIAL, TYPE B 4"
- (L) SUBBASE GRANULAR MATERIAL, TYPE B 8"
- (M) SUBBASE GRANULAR MATERIAL, 12"
- (N) AGGREGATE SUBGRADE IMPROVEMENT 12"
- (O) POROUS GRANULAR EMBANKMENT, SPECIAL, 0" TO 30"
- (P) COMBINATION CONCRETE CURB AND GUTTER
- (Q) CONCRETE BARRIER
- (R) TEMPORARY CONCRETE BARRIER (STATE OWNED)
- (S) GUARDRAIL
- (T) PIPE UNDERDRAINS
- (U) TOPSOIL
- (V) HOT-MIX ASPHALT SURFACE COURSE, MIX "D" N50-2" (ASSUMED)
- (W) PORTLAND CEMENT CONCRETE BASE COURSE 8" (ASSUMED)
- (X) SUBBASE GRANULAR MATERIAL, TYPE B, 6" (ASSUMED)
- (Y) PORTLAND CEMENT CONCRETE PAVEMENT, 11" JOINTED

PROPOSED

- (1) PORTLAND CEMENT CONCRETE PAVEMENT 9" (JOINTED)
- (2) OMITTED
- (3) PORTLAND CEMENT CONCRETE PAVEMENT 11" (JOINTED)
- (4) PORTLAND CEMENT CONCRETE SHOULDERS 9"
- (5) OMITTED
- (6) PORTLAND CEMENT CONCRETE SHOULDERS 11"
- (7) STABILIZED SUBBASE - HOT-MIX ASPHALT, 4"
- (8) SUBBASE GRANULAR MATERIAL, TYPE B 4"
- (9) AGGREGATE SUBGRADE IMPROVEMENT 12"
(SEE SHEET 26 FOR ADDITIONAL INFORMATION)
- (10) HOT-MIX ASPHALT SURFACE COURSE, MIX "D", IL-9.5, N50: 2"
- (11) PORTLAND CEMENT CONCRETE BASE COURSE 8"
- (12) POROUS GRANULAR EMBANKMENT
- (13) CONCRETE MEDIAN SURFACE, 4"
- (14) SUBBASE GRANULAR MATERIAL, TYPE B, 6"
- (15) CONCRETE CURB, TYPE B (SPECIAL), (CDOT)
- (16) CONCRETE GUTTER, TYPE B
- (17) CONCRETE BARRIER WALL (OF VARIOUS TYPES, SEE ROADWAY DETAILS)
- (18) CONCRETE BARRIER BASE (OF VARIOUS TYPES, SEE ROADWAY DETAILS)
- (19) PIPE UNDERDRAINS 4" OR 6" (SEE DRAINAGE PLANS)
- (20) *6 TIE BARS, 24" LONG AT 36" C-C
(INCLUDED IN PRICE FOR BID FOR PCC SHOULDER OR CURB AND GUTTER)
- (21) *6 TIE BARS, 30" LONG AT 36" C-C
(INCLUDED IN PRICE FOR BID FOR PCC PAVEMENT)
- (22) TOPSOIL FURNISH AND PLACE, 4" AND SEEDING OR SODDING
(SEE EROSION CONTROL PLANS)
- (23) TOPSOIL FURNISH AND PLACE, 24" AND SEEDING
- (24) OMITTED
- (25) TEMPORARY PAVEMENT (PCC/HMA), SEE SHEET 26 FOR DETAILS

NOTES:

1. THE ADDITIONAL THICKNESS OF AGGREGATE SUBGRADE IMPROVEMENT UNDER THE SHOULDER TO DRAIN TO UNDERDRAINS SHALL BE INCLUDED IN THE COST PER SQ. YD. OF AGGREGATE SUBGRADE IMPROVEMENT 24".
2. THE MAXIMUM ROLLOVER BETWEEN THE PAVEMENT AND THE SHOULDER ON THE HIGH SIDE OF THE SUPERELEVATION IS 8.0%.
3. FOR TIE BAR WITH BARRIER BASE, SEE CONCRETE BARRIER DETAILS.



D162J31-SHT-Typical-01.dgn	DESIGNED - OPS	REVISED -
USER NAME = andrew.aceron	DRAWN - OPS	REVISED -
PLOT SCALE = 20.0000' / in.	CHECKED - MJE	REVISED -
PLOT DATE = 8/15/2019	DATE - 8/16/2019	REVISED -

**STATE OF ILLINOIS
DEPARTMENT OF TRANSPORTATION**

**TYPICAL SECTIONS
RAMP SW, RAMP SE AND SB TAYLOR EXIT RAMP**

SCALE: NONE SHEET 1 OF 6 SHEETS STA. TO STA.

F.A.I. RTE.	SECTION	COUNTY	TOTAL SHEETS	SHEET NO.
90/94/290	2019-054-I	COOK	400	21
CONTRACT NO. 62J31				
ILLINOIS FED. AID PROJECT				

FILE PATH = p:\a\ecdm-na-ansi\ecdm\local\ecdm\0502-na\Documents\01-Americas\Transportation\60269938-Circle Phase II\000-CAD\006-Roadway\Sheets\62J31-Contract\0162J31-SHT-Typical-02.dgn

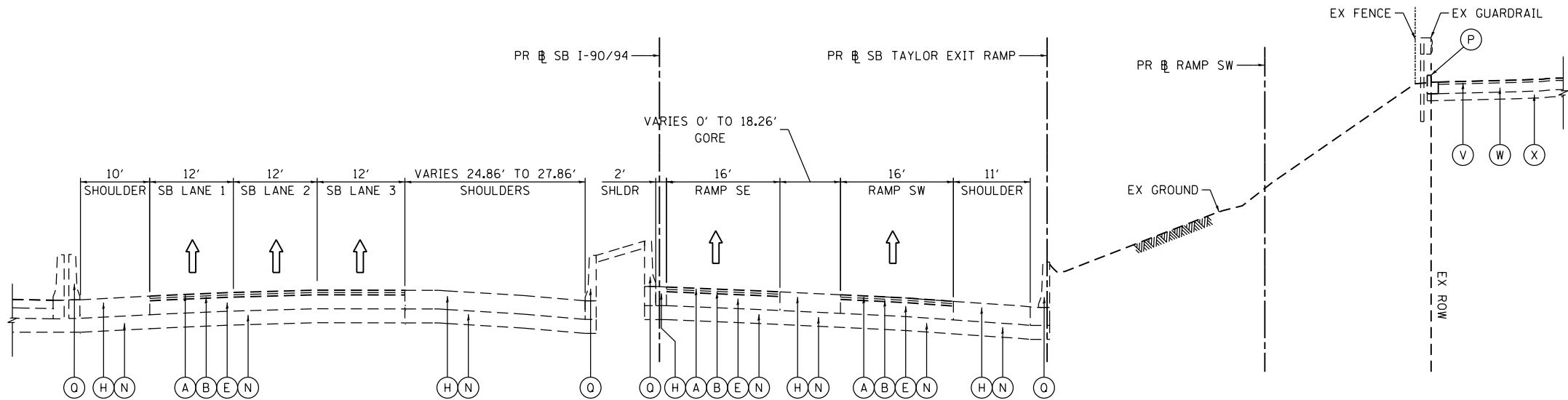

EXISTING TYPICAL SECTION
RAMP SW
(LOOKING SOUTH)

STA 1316+39.53 TO STA 1317+21.11 (PR SB RAMP SW)
 STA 6401+14.43 TO STA 6401+97.27 (PR SB TAYLOR EXIT RAMP)

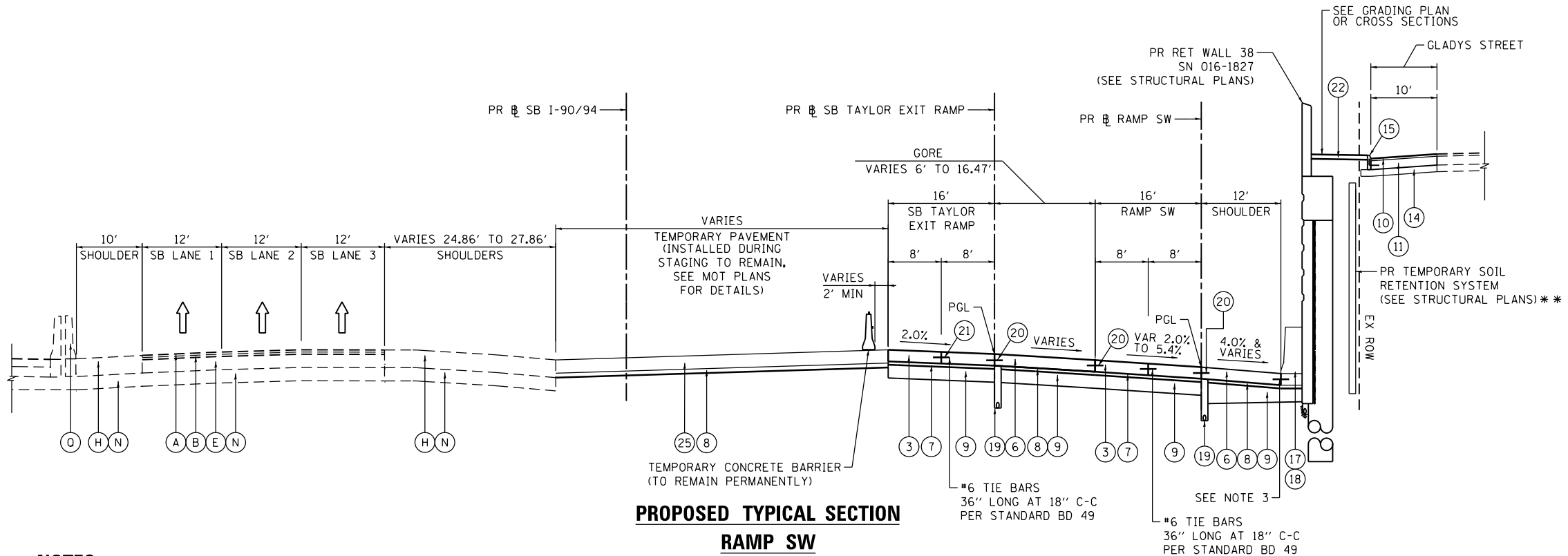

PROPOSED TYPICAL SECTION
RAMP SW
(LOOKING SOUTH)

STA 1316+39.53 TO STA 1317+21.11 (PR SB RAMP SW)
 STA 6401+14.43 TO STA 6401+97.27 (PR SB TAYLOR EXIT RAMP)

** TEMPORARY SOIL RETENTION SYSTEM - STA 1315+75.00 TO STA 1316+68.41 (PR SB RAMP SW) - SEE STRUCTURAL PLANS

NOTES:

1. THE ADDITIONAL THICKNESS OF AGGREGATE SUBGRADE IMPROVEMENT UNDER THE SHOULDER TO DRAIN TO UNDERDRAINS SHALL BE INCLUDED IN THE COST PER SQ. YD. OF AGGREGATE SUBGRADE IMPROVEMENT 24".
2. THE MAXIMUM ROLLOVER BETWEEN THE PAVEMENT AND THE SHOULDER ON THE HIGH SIDE OF THE SUPERELEVATION IS 8.0%.
3. FOR TIE BAR WITH BARRIER BASE, SEE CONCRETE BARRIER DETAILS.

EXISTING

- (A) HOT MIX ASPHALT SURFACE COURSE, 1.5"
- (B) HOT MIX ASPHALT BINDER COURSE, 2.5"
- (C) HOT MIX ASPHALT PAVEMENT, 5" TO 11"
- (D) CONTINUOUSLY REINFORCED PCC PAVEMENT, 13"
- (E) PORTLAND CEMENT CONCRETE BASE COURSE, 10"
- (F) PORTLAND CEMENT CONCRETE PAVEMENT 9" (JOINTED)
- (G) PORTLAND CEMENT CONCRETE SHOULDERS 9"
- (H) BITUMINOUS SHOULDER, 13"
- (I) TEMPORARY PAVEMENT (PCC/HMA)
- (J) STABILIZED SUBBASE - HOT-MIX ASPHALT, 4"
- (K) SUBBASE GRANULAR MATERIAL, TYPE B 4"
- (L) SUBBASE GRANULAR MATERIAL, TYPE B 8"
- (M) SUBBASE GRANULAR MATERIAL, 12"
- (N) AGGREGATE SUBGRADE IMPROVEMENT 12"
- (O) POROUS GRANULAR EMBANKMENT, SPECIAL, 0" TO 30"
- (P) COMBINATION CONCRETE CURB AND GUTTER
- (Q) CONCRETE BARRIER
- (R) TEMPORARY CONCRETE BARRIER (STATE OWNED)
- (S) GUARDRAIL
- (T) PIPE UNDERDRAINS
- (U) TOPSOIL
- (V) HOT-MIX ASPHALT SURFACE COURSE, MIX "D" N50-2" (ASSUMED)
- (W) PORTLAND CEMENT CONCRETE BASE COURSE 8" (ASSUMED)
- (X) SUBBASE GRANULAR MATERIAL, TYPE B, 6" (ASSUMED)
- (Y) PORTLAND CEMENT CONCRETE PAVEMENT, 11" JOINTED

PROPOSED

- (1) PORTLAND CEMENT CONCRETE PAVEMENT 9" (JOINTED)
- (2) OMITTED
- (3) PORTLAND CEMENT CONCRETE PAVEMENT 11" (JOINTED)
- (4) PORTLAND CEMENT CONCRETE SHOULDERS 9"
- (5) OMITTED
- (6) PORTLAND CEMENT CONCRETE SHOULDERS 11"
- (7) STABILIZED SUBBASE - HOT-MIX ASPHALT, 4"
- (8) SUBBASE GRANULAR MATERIAL, TYPE B 4"
- (9) AGGREGATE SUBGRADE IMPROVEMENT 12" (SEE SHEET 26 FOR ADDITIONAL INFORMATION)
- (10) HOT-MIX ASPHALT SURFACE COURSE, MIX "D", IL-9.5, N50: 2"
- (11) PORTLAND CEMENT CONCRETE BASE COURSE 8"
- (12) POROUS GRANULAR EMBANKMENT
- (13) CONCRETE MEDIAN SURFACE, 4"
- (14) SUBBASE GRANULAR MATERIAL, TYPE B, 6"
- (15) CONCRETE CURB, TYPE B (SPECIAL), (CDOT)
- (16) CONCRETE GUTTER, TYPE B
- (17) CONCRETE BARRIER WALL (OF VARIOUS TYPES, SEE ROADWAY DETAILS)
- (18) CONCRETE BARRIER BASE (OF VARIOUS TYPES, SEE ROADWAY DETAILS)
- (19) PIPE UNDERDRAINS 4" OR 6" (SEE DRAINAGE PLANS)
- (20) #6 TIE BARS, 24" LONG AT 36" C-C (INCLUDED IN PRICE FOR BID FOR PCC SHOULDER OR CURB AND GUTTER)
- (21) #6 TIE BARS, 30" LONG AT 36" C-C (INCLUDED IN PRICE FOR BID FOR PCC PAVEMENT)
- (22) TOPSOIL FURNISH AND PLACE, 4" AND SEEDING OR SODDING (SEE EROSION CONTROL PLANS)
- (23) TOPSOIL FURNISH AND PLACE, 24" AND SEEDING
- (24) OMITTED
- (25) TEMPORARY PAVEMENT (PCC/HMA), SEE SHEET 26 FOR DETAILS



D162J31-SHT-Typical-02.dgn
 USER NAME = andrew.aceron
 PLOT SCALE = 20.0000' / in.
 PLOT DATE = 8/15/2019

DESIGNED - OPS
 DRAWN - OPS
 CHECKED - MJE
 DATE - 8/16/2019

STATE OF ILLINOIS
DEPARTMENT OF TRANSPORTATION

TYPICAL SECTIONS
RAMP SW, RAMP SE AND SB TAYLOR EXIT RAMP

F.A.I. RTE.	SECTION	COUNTY	TOTAL SHEETS	SHEET NO.
90/94/290	2019-054-I	COOK	400	22
CONTRACT NO. 62J31				
ILLINOIS FED. AID PROJECT				

SCALE: NONE SHEET 2 OF 6 SHEETS STA. TO STA.

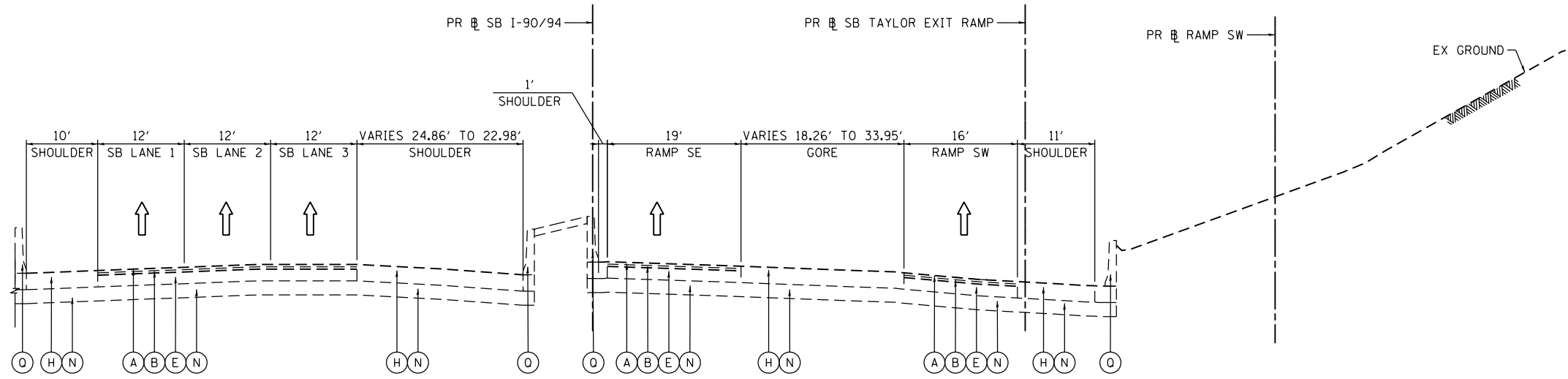

**EXISTING TYPICAL SECTION
RAMP SW
(LOOKING SOUTH)**

STA 1317+21.11 TO STA 1317+90.92 (PR SB RAMP SW)
STA 6401+97.27 TO STA 6402+76.39 (PR SB TAYLOR EXIT RAMP)

EXISTING

- (A) HOT MIX ASPHALT SURFACE COURSE, 1.5"
- (B) HOT MIX ASPHALT BINDER COURSE, 2.5"
- (C) HOT MIX ASPHALT PAVEMENT, 5" TO 11"
- (D) CONTINUOUSLY REINFORCED PCC PAVEMENT, 13"
- (E) PORTLAND CEMENT CONCRETE BASE COURSE, 10"
- (F) PORTLAND CEMENT CONCRETE PAVEMENT 9" (JOINTED)
- (G) PORTLAND CEMENT CONCRETE SHOULDERS 9"
- (H) BITUMINOUS SHOULDER, 13"
- (I) TEMPORARY PAVEMENT (PCC/HMA)
- (J) STABILIZED SUBBASE - HOT-MIX ASPHALT, 4"
- (K) SUBBASE GRANULAR MATERIAL, TYPE B 4"
- (L) SUBBASE GRANULAR MATERIAL, TYPE B 8"
- (M) SUBBASE GRANULAR MATERIAL, 12"
- (N) AGGREGATE SUBGRADE IMPROVEMENT 12"
- (O) POROUS GRANULAR EMBANKMENT, SPECIAL, 0" TO 30"
- (P) COMBINATION CONCRETE CURB AND GUTTER
- (Q) CONCRETE BARRIER
- (R) TEMPORARY CONCRETE BARRIER (STATE OWNED)
- (S) GUARDRAIL
- (T) PIPE UNDERDRAINS
- (U) TOPSOIL
- (V) HOT-MIX ASPHALT SURFACE COURSE, MIX "D" N50-2" (ASSUMED)
- (W) PORTLAND CEMENT CONCRETE BASE COURSE 8" (ASSUMED)
- (X) SUBBASE GRANULAR MATERIAL, TYPE B, 6" (ASSUMED)
- (Y) PORTLAND CEMENT CONCRETE PAVEMENT, 11" JOINTED

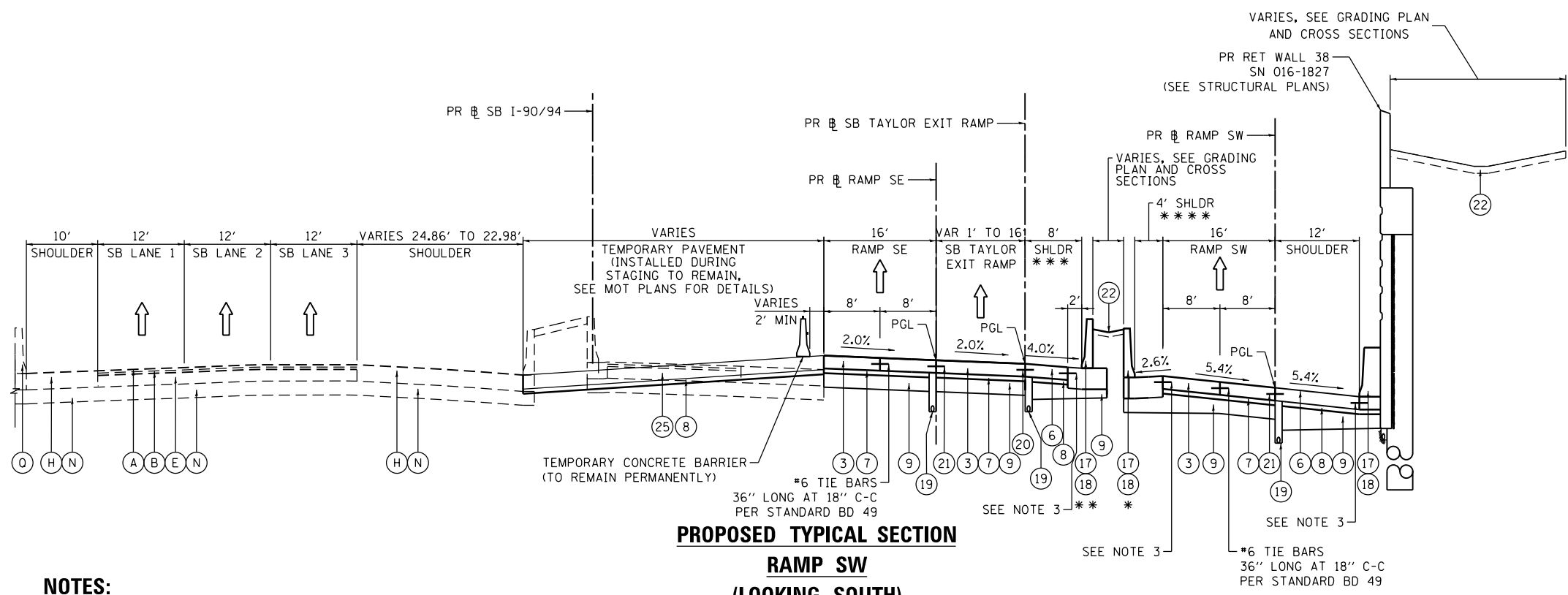

**PROPOSED TYPICAL SECTION
RAMP SW
(LOOKING SOUTH)**

STA 1317+21.11 TO STA 1317+90.92 (PR SB RAMP SW)
STA 6401+97.27 TO STA 6402+76.39 (PR SB TAYLOR EXIT RAMP)

PROPOSED

- (1) PORTLAND CEMENT CONCRETE PAVEMENT 9" (JOINTED)
- (2) OMITTED
- (3) PORTLAND CEMENT CONCRETE PAVEMENT 11" (JOINTED)
- (4) PORTLAND CEMENT CONCRETE SHOULDERS 9"
- (5) OMITTED
- (6) PORTLAND CEMENT CONCRETE SHOULDERS 11"
- (7) STABILIZED SUBBASE - HOT-MIX ASPHALT, 4"
- (8) SUBBASE GRANULAR MATERIAL, TYPE B 4"
- (9) AGGREGATE SUBGRADE IMPROVEMENT 12"
- (SEE SHEET 26 FOR ADDITIONAL INFORMATION)
- (10) HOT-MIX ASPHALT SURFACE COURSE, MIX "D", IL-9.5, N50: 2"
- (11) PORTLAND CEMENT CONCRETE BASE COURSE 8"
- (12) POROUS GRANULAR EMBANKMENT
- (13) CONCRETE MEDIAN SURFACE, 4"
- (14) SUBBASE GRANULAR MATERIAL, TYPE B, 6"
- (15) CONCRETE CURB, TYPE B (SPECIAL), (CDOT)
- (16) CONCRETE GUTTER, TYPE B
- (17) CONCRETE BARRIER WALL (OF VARIOUS TYPES, SEE ROADWAY DETAILS)
- (18) CONCRETE BARRIER BASE (OF VARIOUS TYPES, SEE ROADWAY DETAILS)
- (19) PIPE UNDERDRAINS 4" OR 6" (SEE DRAINAGE PLANS)
- (20) *6 TIE BARS, 24" LONG AT 36" C-C (INCLUDED IN PRICE FOR BID FOR PCC SHOULDER OR CURB AND GUTTER)
- (21) *6 TIE BARS, 30" LONG AT 36" C-C (INCLUDED IN PRICE FOR BID FOR PCC PAVEMENT)
- (22) TOPSOIL FURNISH AND PLACE, 4" AND SEEDING OR SODDING (SEE EROSION CONTROL PLANS)
- (23) TOPSOIL FURNISH AND PLACE, 24" AND SEEDING
- (24) OMITTED
- (25) TEMPORARY PAVEMENT (PCC/HMA), SEE SHEET 26 FOR DETAILS

NOTES:

1. THE THICKNESS OF AGGREGATE SUBGRADE IMPROVEMENT UNDER THE SHOULDER TO DRAIN TO UNDERDRAINS SHALL BE INCLUDED IN THE COST PER SQ. YD. OF AGGREGATE SUBGRADE IMPROVEMENT 24".
2. THE MAXIMUM ROLLOVER BETWEEN THE PAVEMENT AND THE SHOULDER ON THE HIGH SIDE OF THE SUPERELEVATION IS 8.0%.
3. FOR TIE BAR WITH BARRIER BASE, SEE CONCRETE BARRIER DETAILS.

- * CONCRETE BARRIER, SINGLE FACE, 42 INCH HEIGHT (SPECIAL) BEGINS AT STA 1317+21.11 (PR SB RAMP SW)
- ** CONCRETE BARRIER, SINGLE FACE, 42 INCH HEIGHT (SPECIAL) BEGINS AT STA 6401+97.27 (PR SB TAYLOR EXIT RAMP)
- *** RT PORTLAND CEMENT CONCRETE SHOULDER VARIES FROM 8.65' TO 8' STA 6401+97.27 TO STA 6402+09.04 (PR SB TAYLOR EXIT RAMP)
- *** LT PORTLAND CEMENT CONCRETE SHOULDER VARIES FROM 4.82' TO 4' STA 1317+21.11 TO STA 1317+35.47 (PR SB RAMP SW)

FILE PATH = p:\V\AECOM\NA\MSI\encom\line\local\AECOM_D502_NA\Documents\01_Americas\Transportation\60269938_Circle Phase II\000_CAD\006_Roadway\Sheets\62J31_Contract\0162J31-SHT-Typical-03.dgn



D162J31-SHT-Typical-03.dgn
USER NAME = ashok.kc
PLOT SCALE = 20.0000' / in.
PLOT DATE = 8/15/2019

DESIGNED - OPS
DRAWN - OPS
CHECKED - MJE
DATE - 8/16/2019

REVISED -
REVISED -
REVISED -
REVISED -

**STATE OF ILLINOIS
DEPARTMENT OF TRANSPORTATION**

**TYPICAL SECTIONS
RAMP SW, RAMP SE AND SB TAYLOR EXIT RAMP**

F.A.I. RTE.	SECTION	COUNTY	TOTAL SHEETS	SHEET NO.
90/94/290	2019-054-I	COOK	400	23
CONTRACT NO. 62J31				
ILLINOIS FED. AID PROJECT				

SCALE: NONE SHEET 3 OF 6 SHEETS STA. TO STA.

FILE PATH = p:\V\AECOM\NA\MSI\enr\enr\local\AECOM_D502_NA\Documents\01_Americas\Transportation\60269938_Circle Phase II\000 CAD\006_Roadway\Sheets\62J31_Contract\162J31-SHT-Typical-04.dgn

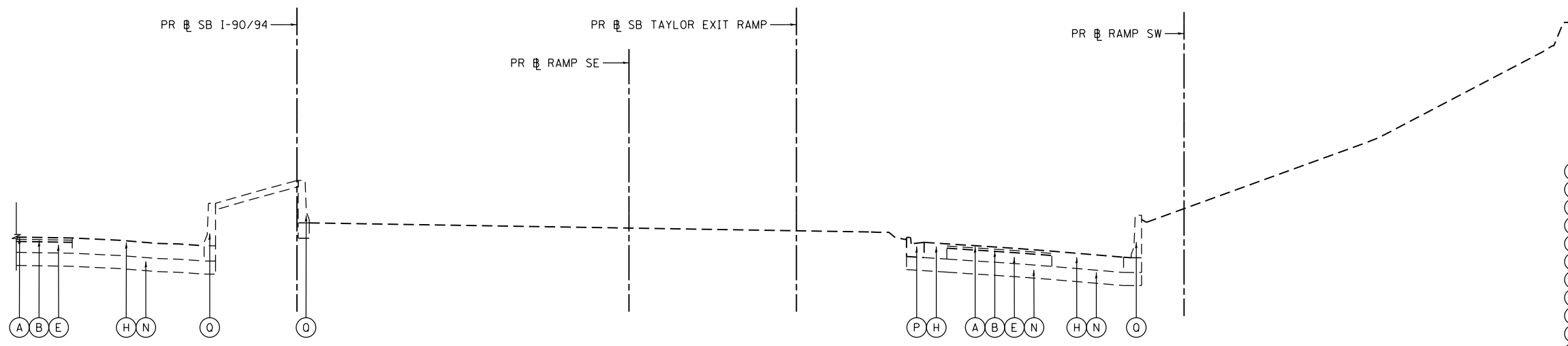

EXISTING TYPICAL SECTION
RAMP SW
(LOOKING SOUTH)

STA 1317+90.92 TO STA 1319+75.65 (PR SB RAMP SW)
 STA 6402+76.39 TO STA 6404+00.00 (PR SB TAYLOR EXIT RAMP)
 STA 1400+00.00 TO STA 1401+40.00 (PR RAMP SE)

EXISTING

- (A) HOT MIX ASPHALT SURFACE COURSE, 1.5"
- (B) HOT MIX ASPHALT BINDER COURSE, 2.5"
- (C) HOT MIX ASPHALT PAVEMENT, 5" TO 11"
- (D) CONTINUOUSLY REINFORCED PCC PAVEMENT, 13"
- (E) PORTLAND CEMENT CONCRETE BASE COURSE, 10"
- (F) PORTLAND CEMENT CONCRETE PAVEMENT 9" (JOINTED)
- (G) PORTLAND CEMENT CONCRETE SHOULDERS 9"
- (H) BITUMINOUS SHOULDER, 13"
- (I) TEMPORARY PAVEMENT (PCC/HMA)
- (J) STABILIZED SUBBASE - HOT-MIX ASPHALT, 4"
- (K) SUBBASE GRANULAR MATERIAL, TYPE B 4"
- (L) SUBBASE GRANULAR MATERIAL, TYPE B 8"
- (M) SUBBASE GRANULAR MATERIAL, 12"
- (N) AGGREGATE SUBGRADE IMPROVEMENT 12"
- (O) POROUS GRANULAR EMBANKMENT, SPECIAL, 0" TO 30"
- (P) COMBINATION CONCRETE CURB AND GUTTER
- (Q) CONCRETE BARRIER
- (R) TEMPORARY CONCRETE BARRIER (STATE OWNED)
- (S) GUARDRAIL
- (T) PIPE UNDERDRAINS
- (U) TOPSOIL
- (V) HOT-MIX ASPHALT SURFACE COURSE, MIX "D" N50-2" (ASSUMED)
- (W) PORTLAND CEMENT CONCRETE BASE COURSE 8" (ASSUMED)
- (X) SUBBASE GRANULAR MATERIAL, TYPE B, 6" (ASSUMED)
- (Y) PORTLAND CEMENT CONCRETE PAVEMENT, 11" JOINTED

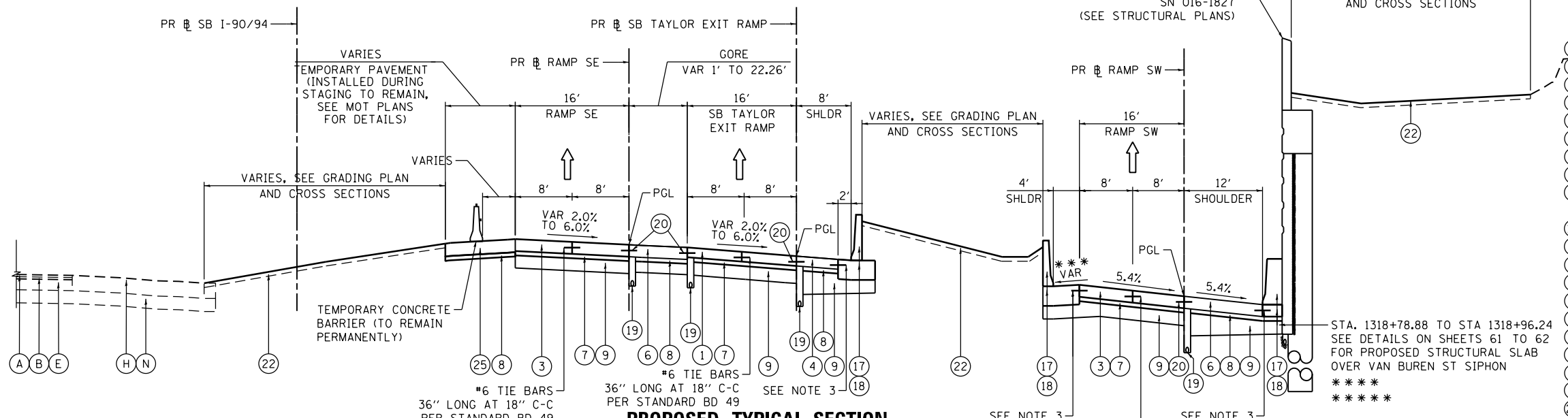

PROPOSED TYPICAL SECTION
RAMP SW
(LOOKING SOUTH)

STA 1317+90.92 TO STA 1319+75.65 (PR SB RAMP SW)
 STA 6402+76.39 TO STA 6404+00.00 (PR SB TAYLOR EXIT RAMP)
 STA 1400+00.00 TO STA 1401+40.00 (PR RAMP SE)

PROPOSED

- (1) PORTLAND CEMENT CONCRETE PAVEMENT 9" (JOINTED)
- (2) OMITTED
- (3) PORTLAND CEMENT CONCRETE PAVEMENT 11" (JOINTED)
- (4) PORTLAND CEMENT CONCRETE SHOULDERS 9"
- (5) OMITTED
- (6) PORTLAND CEMENT CONCRETE SHOULDERS 11"
- (7) STABILIZED SUBBASE - HOT-MIX ASPHALT, 4"
- (8) SUBBASE GRANULAR MATERIAL, TYPE B 4"
- (9) AGGREGATE SUBGRADE IMPROVEMENT 12"
- (10) HOT-MIX ASPHALT SURFACE COURSE, MIX "D", IL-9.5, N50: 2"
- (11) PORTLAND CEMENT CONCRETE BASE COURSE 8"
- (12) POROUS GRANULAR EMBANKMENT
- (13) CONCRETE MEDIAN SURFACE, 4"
- (14) SUBBASE GRANULAR MATERIAL, TYPE B, 6"
- (15) CONCRETE CURB, TYPE B (SPECIAL), (CDOT)
- (16) CONCRETE GUTTER, TYPE B
- (17) CONCRETE BARRIER WALL (OF VARIOUS TYPES, SEE ROADWAY DETAILS)
- (18) CONCRETE BARRIER BASE (OF VARIOUS TYPES, SEE ROADWAY DETAILS)
- (19) PIPE UNDERDRAINS 4" OR 6" (SEE DRAINAGE PLANS)
- (20) #6 TIE BARS, 24" LONG AT 36" C-C (INCLUDED IN PRICE FOR BID FOR PCC SHOULDER OR CURB AND GUTTER)
- (21) #6 TIE BARS, 30" LONG AT 36" C-C (INCLUDED IN PRICE FOR BID FOR PCC PAVEMENT)
- (22) TOPSOIL FURNISH AND PLACE, 4" AND SEEDING OR SODDING (SEE EROSION CONTROL PLANS)
- (23) TOPSOIL FURNISH AND PLACE, 24" AND SEEDING
- (24) OMITTED
- (25) TEMPORARY PAVEMENT (PCC/HMA), SEE SHEET 26 FOR DETAILS

NOTES:

1. THE ADDITIONAL THICKNESS OF AGGREGATE SUBGRADE IMPROVEMENT UNDER THE SHOULDER TO DRAIN TO UNDERDRAINS SHALL BE INCLUDED IN THE COST PER SQ. YD. OF AGGREGATE SUBGRADE IMPROVEMENT 24".
2. THE MAXIMUM ROLLOVER BETWEEN THE PAVEMENT AND THE SHOULDER ON THE HIGH SIDE OF THE SUPERELEVATION IS 8.0%.
3. FOR TIE BAR WITH BARRIER BASE, SEE CONCRETE BARRIER DETAILS.

** PR RET WALL 38 (SN 016-1827) ENDS AT STA 1318+74.91 (PR SB RAMP SW)
 *** FOR SHOULDER TRANSITION, SEE PAVEMENT ELEVATION AND SUPERELEVATION DETAILS ON SHEET 47
 **** PR PVT CON PCC BR APP SL, STA 1318+60.93 TO STA 1318+78.88 (PR SB RAMP SW)
 ***** PR PVT CON PCC BR APP SL, STA 1318+96.24 TO STA 1319+16.94 (PR SB RAMP SW)



D162J31-SHT-Typical-04.dgn
 USER NAME = andrew.aceron
 PLOT SCALE = 20.0000' / in.
 PLOT DATE = 8/15/2019

DESIGNED - OPS	REVISED -
DRAWN - OPS	REVISED -
CHECKED - MJE	REVISED -
DATE - 8/16/2019	REVISED -

STATE OF ILLINOIS
DEPARTMENT OF TRANSPORTATION

TYPICAL SECTIONS
RAMP SW, RAMP SE AND SB TAYLOR EXIT RAMP

SCALE: NONE SHEET 4 OF 6 SHEETS STA. TO STA.

F.A.I. RTE.	SECTION	COUNTY	TOTAL SHEETS	SHEET NO.
90/94/290	2019-054-I	COOK	400	24
CONTRACT NO. 62J31				
ILLINOIS FED. AID PROJECT				

FILE PATH = p:\aecom\na-ansi\encom\local\ecom_0502_na_documents\01_america\transportation\60269938_Circle Phase II\000 CAD\006_Roadway\Sheets\62J31_Contract\0162J31-SHT-Typical-05.dgn

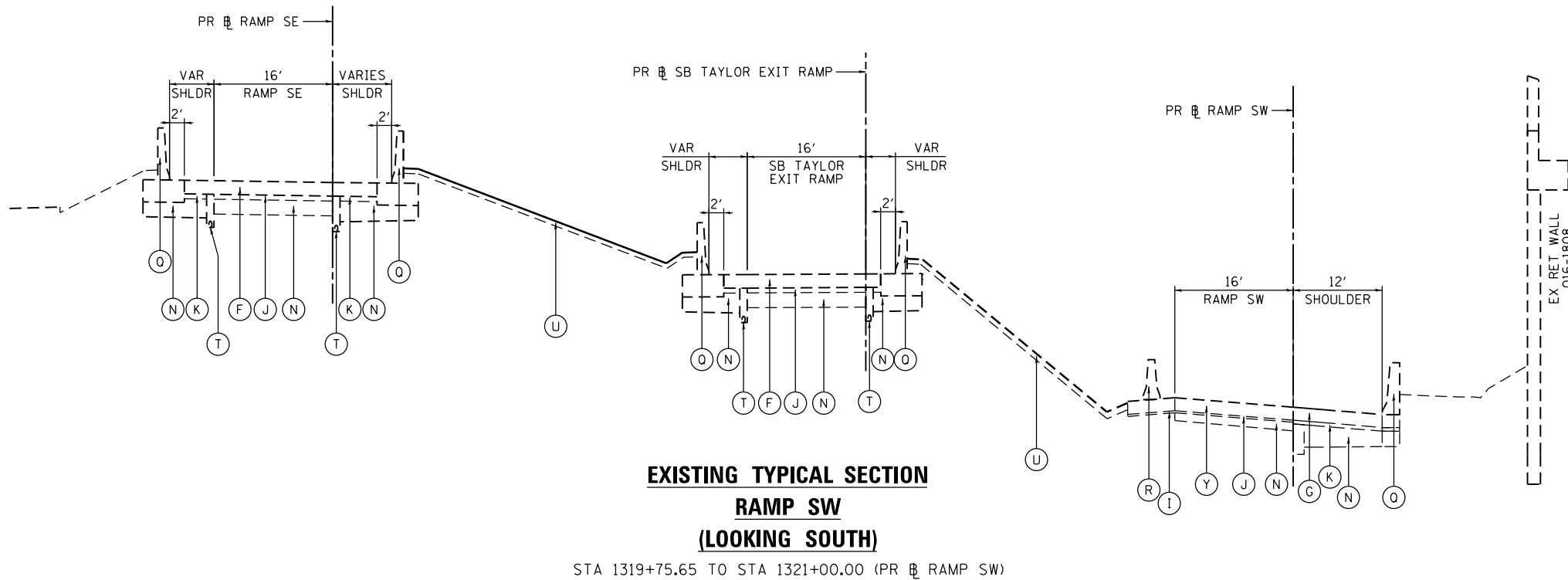

**EXISTING TYPICAL SECTION
RAMP SW
(LOOKING SOUTH)**

STA 1319+75.65 TO STA 1321+00.00 (PR RAMP SW)

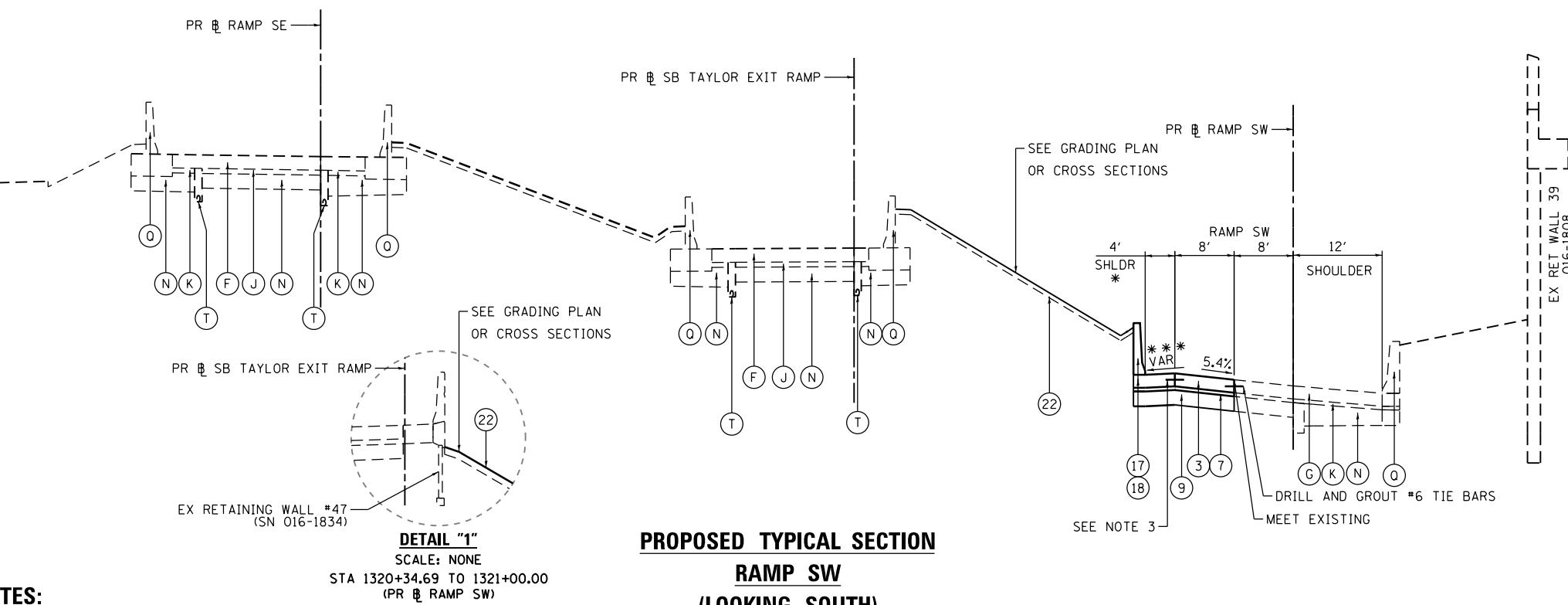

**PROPOSED TYPICAL SECTION
RAMP SW
(LOOKING SOUTH)**

STA 1319+75.65 TO STA 1321+00.00 (PR RAMP SW)

NOTES:

1. THE ADDITIONAL THICKNESS OF AGGREGATE SUBGRADE IMPROVEMENT UNDER THE SHOULDER TO DRAIN TO UNDERDRAINS SHALL BE INCLUDED IN THE COST PER SQ. YD. OF AGGREGATE SUBGRADE IMPROVEMENT 24".
2. THE MAXIMUM ROLLOVER BETWEEN THE PAVEMENT AND THE SHOULDER ON THE HIGH SIDE OF THE SUPERELEVATION IS 8.0%.
3. FOR TIE BAR WITH BARRIER BASE, SEE CONCRETE BARRIER DETAILS.

- * LT PORTLAND CEMENT CONCRETE SHOULDER AND CONCRETE BARRIER, SINGLE FACE, 42 INCH HEIGHT (SPECIAL) ENDS AT STA 1321+00.00 (PR RAMP SW)
- ** 8' RAMP SW PAVEMENT FROM STA 1319+75.95 TO STA 1320+51.90 (PR RAMP SW)
- *** FOR SHOULDER TRANSITION, SEE PAVEMENT ELEVATION AND SUPERELEVATION DETAILS ON SHEET 47

EXISTING

- (A) HOT MIX ASPHALT SURFACE COURSE, 1.5"
- (B) HOT MIX ASPHALT BINDER COURSE, 2.5"
- (C) HOT MIX ASPHALT PAVEMENT, 5" TO 11"
- (D) CONTINUOUSLY REINFORCED PCC PAVEMENT, 13"
- (E) PORTLAND CEMENT CONCRETE BASE COURSE, 10"
- (F) PORTLAND CEMENT CONCRETE PAVEMENT 9" (JOINTED)
- (G) PORTLAND CEMENT CONCRETE SHOULDERS 9"
- (H) BITUMINOUS SHOULDER, 13"
- (I) TEMPORARY PAVEMENT (PCC/HMA)
- (J) STABILIZED SUBBASE - HOT-MIX ASPHALT, 4"
- (K) SUBBASE GRANULAR MATERIAL, TYPE B 4"
- (L) SUBBASE GRANULAR MATERIAL, TYPE B 8"
- (M) SUBBASE GRANULAR MATERIAL, 12"
- (N) AGGREGATE SUBGRADE IMPROVEMENT 12"
- (O) POROUS GRANULAR EMBANKMENT, SPECIAL, 0" TO 30"
- (P) COMBINATION CONCRETE CURB AND GUTTER
- (Q) CONCRETE BARRIER
- (R) TEMPORARY CONCRETE BARRIER (STATE OWNED)
- (S) GUARDRAIL
- (T) PIPE UNDERDRAINS
- (U) TOPSOIL
- (V) HOT-MIX ASPHALT SURFACE COURSE, MIX "D" N50-2" (ASSUMED)
- (W) PORTLAND CEMENT CONCRETE BASE COURSE 8" (ASSUMED)
- (X) SUBBASE GRANULAR MATERIAL, TYPE B, 6" (ASSUMED)
- (Y) PORTLAND CEMENT CONCRETE PAVEMENT, 11" JOINTED

PROPOSED

- (1) PORTLAND CEMENT CONCRETE PAVEMENT 9" (JOINTED)
- (2) OMITTED
- (3) PORTLAND CEMENT CONCRETE PAVEMENT 11" (JOINTED)
- (4) PORTLAND CEMENT CONCRETE SHOULDERS 9"
- (5) OMITTED
- (6) PORTLAND CEMENT CONCRETE SHOULDERS 11"
- (7) STABILIZED SUBBASE - HOT-MIX ASPHALT, 4"
- (8) SUBBASE GRANULAR MATERIAL, TYPE B 4"
- (9) AGGREGATE SUBGRADE IMPROVEMENT 12"
(SEE SHEET 26 FOR ADDITIONAL INFORMATION)
- (10) HOT-MIX ASPHALT SURFACE COURSE, MIX "D", IL-9.5, N50: 2"
- (11) PORTLAND CEMENT CONCRETE BASE COURSE 8"
- (12) POROUS GRANULAR EMBANKMENT
- (13) CONCRETE MEDIAN SURFACE, 4"
- (14) SUBBASE GRANULAR MATERIAL, TYPE B, 6"
- (15) CONCRETE CURB, TYPE B (SPECIAL), (CDOT)
- (16) CONCRETE GUTTER, TYPE B
- (17) CONCRETE BARRIER WALL (OF VARIOUS TYPES, SEE ROADWAY DETAILS)
- (18) CONCRETE BARRIER BASE (OF VARIOUS TYPES, SEE ROADWAY DETAILS)
- (19) PIPE UNDERDRAINS 4" OR 6" (SEE DRAINAGE PLANS)
- (20) #6 TIE BARS, 24" LONG AT 36" C-C
(INCLUDED IN PRICE FOR BID FOR PCC SHOULDER OR CURB AND GUTTER)
- (21) #6 TIE BARS, 30" LONG AT 36" C-C
(INCLUDED IN PRICE FOR BID FOR PCC PAVEMENT)
- (22) TOPSOIL FURNISH AND PLACE, 4" AND SEEDING OR SODDING
(SEE EROSION CONTROL PLANS)
- (23) TOPSOIL FURNISH AND PLACE, 24" AND SEEDING
- (24) OMITTED
- (25) TEMPORARY PAVEMENT (PCC/HMA), SEE SHEET 26 FOR DETAILS



D162J31-SHT-Typical-05.dgn
USER NAME = ashok.kc
PLOT SCALE = 20.0000' / in.
PLOT DATE = 8/15/2019

DESIGNED - OPS	REVISED -
DRAWN - OPS	REVISED -
CHECKED - MJE	REVISED -
DATE - 8/16/2019	REVISED -

STATE OF ILLINOIS
DEPARTMENT OF TRANSPORTATION

TYPICAL SECTIONS
RAMP SW, RAMP SE AND SB TAYLOR EXIT RAMP

SCALE: NONE SHEET 5 OF 6 SHEETS STA. TO STA.

F.A.I. RTE.	SECTION	COUNTY	TOTAL SHEETS	SHEET NO.
90/94/290	2019-054-I	COOK	400	25
CONTRACT NO. 62J31				
ILLINOIS FED. AID PROJECT				

• **APPENDIX E**
Soil Boring Location Plans and Profiles

APPENDIX E
BORING LOCATION PLANS AND SOIL PROFILES

ROADWAY GEOTECHNICAL REPORT

JANE BYRNE INTERCHANGE RECONSTRUCTION
I-90/94 AND CONNECTING RAMPS
CONTRACT 62J31
COOK COUNTY, ILLINOIS

FOR
FOR AECOM
303 EAST WACKER DRIVE
CHICAGO, IL 60601
(312) 938-0300

PREPARED BY
WANG ENGINEERING
1145 NORTH MAIN STREET
LOMBARD, IL 60148

OCTOBER 9, 2019
WANG PROJECT 1100-04-01

LEGEND:



Borehole Data

02-RWB-01 Borehole Number
577.1 ft. Elevation
1814+72.61, 2.24 LT Station, offset

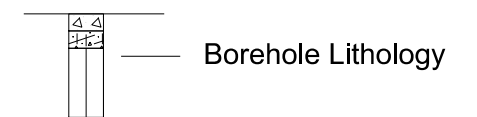

N—N-value, (blw/12 in)
Qu—UC Strength, (tsf)
MC—Moisture Content, (%)

- ▽ Water Level Reading at Time of Drilling.
- ▽ Water Level Reading 24-hr after Drilling or at End of Drilling

Lithology Graphics

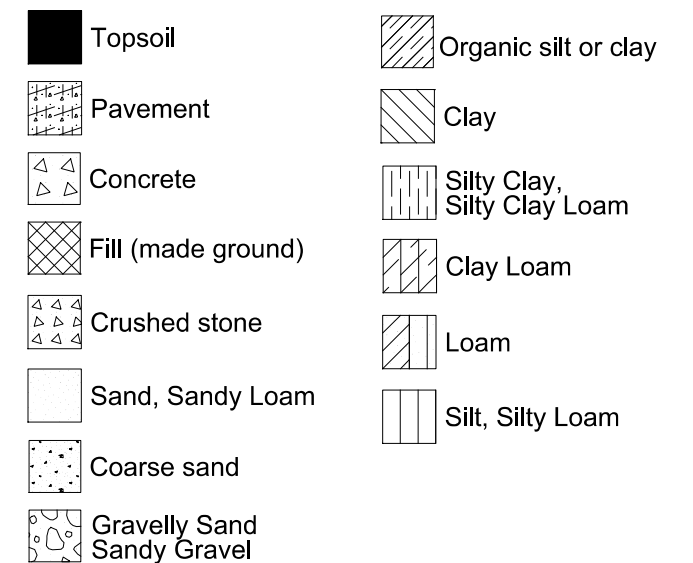

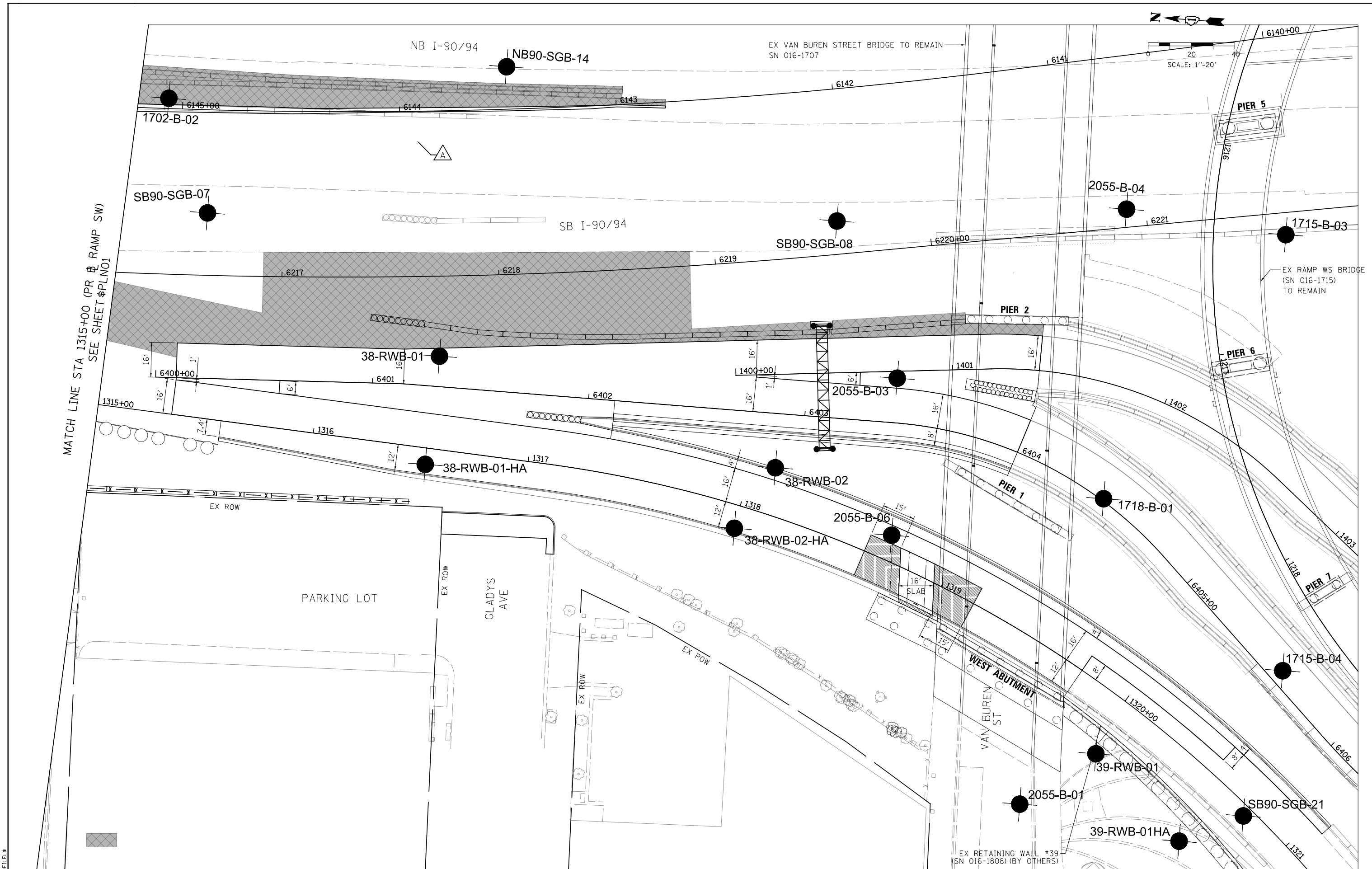
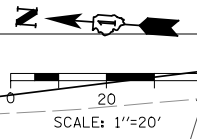

MATCH LINE STA 1315+00 (PR B RAMP SW)
SEE SHEET \$PLN01

FILE PATH = \$FILEL\$



#FILES*	DESIGNED - OPS	REVISED - \$ADD-A
USER NAME = \$USER*	DRAWN - ZND	REVISED -
PLOT SCALE = \$SCALE*	CHECKED - MJE	REVISED -
PLOT DATE = \$DATE*	DATE - \$DATE	REVISED -

**STATE OF ILLINOIS
DEPARTMENT OF TRANSPORTATION**

ROADWAY PLAN
RAMP SW, RAMP SE AND SB TAYLOR EXIT RAMP

SCALE: 1"=20' SHEET 2 OF 2 SHEETS STA. 1315+00.00 TO STA. 1321+00.00

F.A.I. RTE.	SECTION	COUNTY	TOTAL SHEETS	SHEET NO.
90/94/290	2019-054-I	COOK	\$TOTAL	\$PLN02
			CONTRACT NO. 62J31	
ILLINOIS FED. AID PROJECT				

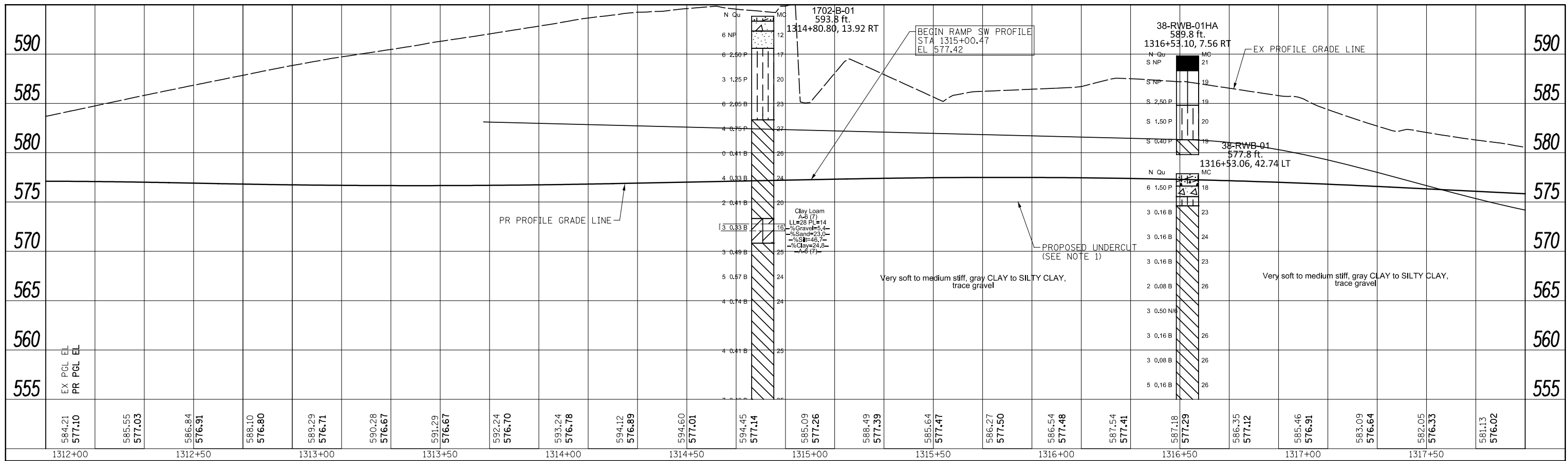

NOTE:
 1. AGGREGATE SUBGRADE IMPROVEMENT SHOWN ON THESE SHEETS IS SCHEMATIC AND THE DEPTHS SHOWN MAY REQUIRE REDUCTION DUE TO PROXIMITY TO RETAINING WALLS 38 (SN 016-1827) AND 39 (SN 016-1808) AND VAN BUREN STREET NW WINGWALL (SN 016-1707). SEE SHEET NO. #TY FOR MORE INFORMATION.

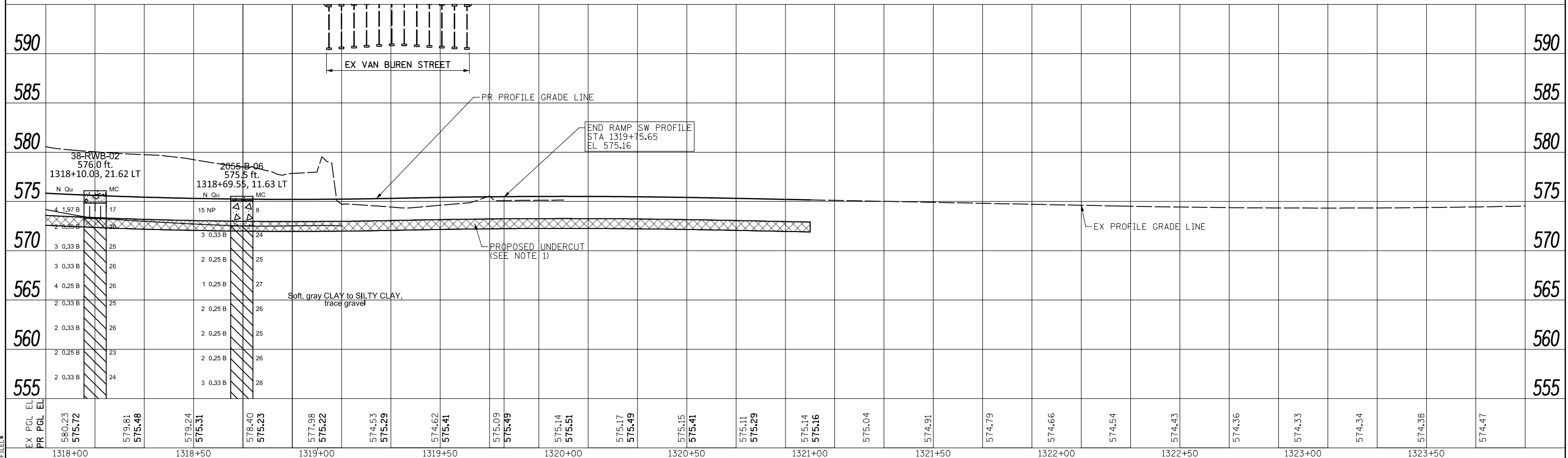

FILE PATH = #FILE#



#FILES#
 USER NAME = #USER#
 PLOT SCALE = #SCALE#
 PLOT DATE = #DATE#

DESIGNED - SDH	REVISED -
DRAWN - OPS	REVISED -
CHECKED - MJE	REVISED -
DATE - #DATE	REVISED -

**STATE OF ILLINOIS
 DEPARTMENT OF TRANSPORTATION**

**ROADWAY PROFILE
 RAMP SW**

SCALE: 1"=20' SHEET 1 OF 3 SHEETS STA. 1311+90.00 TO STA. 1323+90.00

F.A.I. RTE.	SECTION	COUNTY	TOTAL SHEETS	SHEET NO.
90/94/290	2019-054-I	COOK	#TOTAL#	#PRF01
			CONTRACT NO. 62J31	
ILLINOIS FED. AID PROJECT				

