

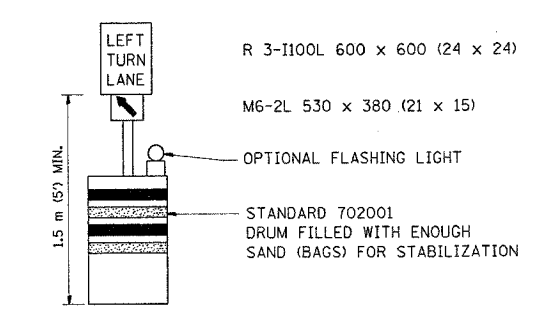

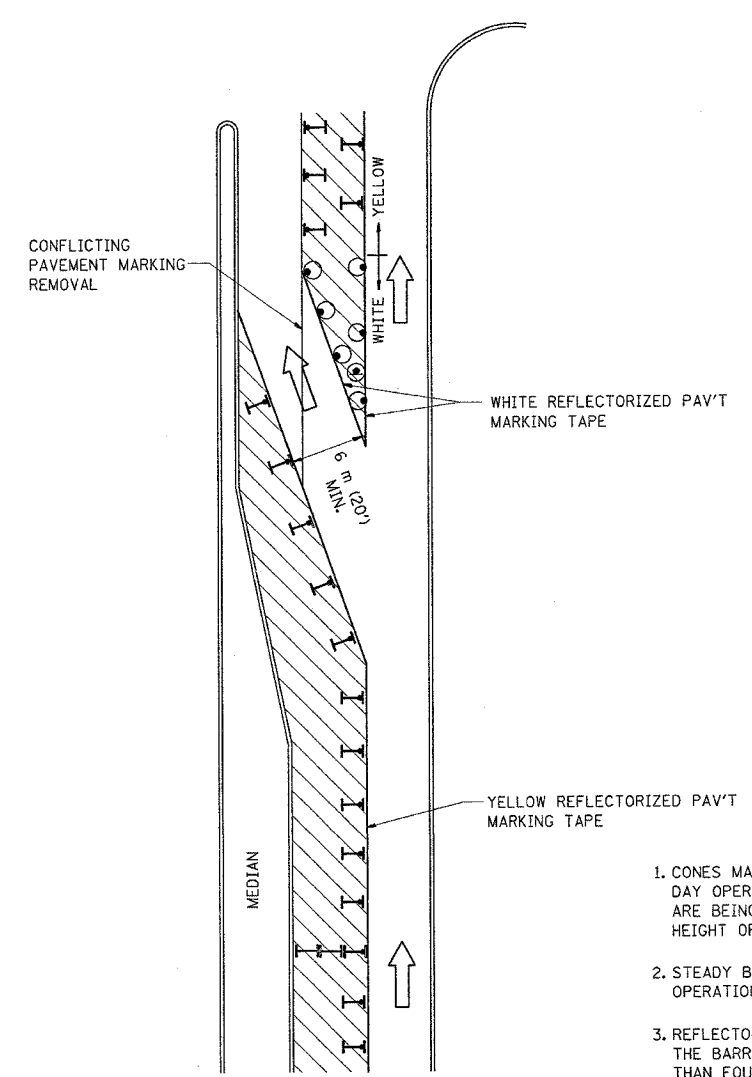



CONTRACT NO.				
F.A.W. RTE.	SECTION	COUNTY	TOTAL SHEETS	SHEET NO.
3730	3248-2.0-1.85	Cook	19	16
STA.		TO STA.		
FED. ROAD DIST. NO.	ILLINOIS	FED. AID PROJECT		

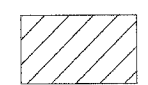

GENERAL NOTES

1. CONES MAY BE SUBSTITUTED FOR BARRICADES OR DRUMS AT HALF THE SPACING DURING DAY OPERATIONS. CONES SHALL BE A MINIMUM OF 710 (28) IN HEIGHT. WHEN CONES ARE BEING USED, THE "LEFT TURN LANE" SIGN MAY BE SKID MOUNTED AT A MINIMUM HEIGHT OF 1.5 m (5').
2. STEADY BURNING LIGHTS WILL NOT BE REQUIRED ON BARRICADES OR DRUMS FOR DAY OPERATIONS. ALL LIGHTS SHALL BE MONODIRECTIONAL.
3. REFLECTORIZED TEMPORARY PAVEMENT MARKING TAPE SHALL BE PLACED THROUGHOUT THE BARRICADED AREA OF EACH TURN BAY WHERE THE CLOSURE TIME IS GREATER THAN FOURTEEN DAYS.
4. THIS APPLICATION ALSO APPLIES WHEN WORK IS BEING PERFORMED IN THE RIGHT LANE(S) AND THE RIGHT TURN BAY IS TO REMAIN OPEN. UNDER THIS CONDITION, "RIGHT TURN LANE" R3-100 600 x 600 (24 x 24) AND M6-2R 530 x 380 (21 x 15) SHALL BE USED.
5. THESE CONTROLS SHALL SUPPLEMENT MAINLINE TRAFFIC CONTROL FOR LANE CLOSURES.
6. LONGITUDINAL DIMENSIONS MAY BE ADJUSTED TO FIT FIELD CONDITIONS.
7. FORM BT 725 IS REQUIRED.
8. TRAFFIC CONTROL AND PROTECTION AT TURN BAYS (TO REMAIN OPEN TO TRAFFIC) SHALL BE INCLUDED IN THE COST SPECIFIED TRAFFIC CONTROL STANDARDS OR ITEMS.

LEGEND

-  WORK AREA
-  LANE OPEN TO TRAFFIC
-  TYPE I OR II BARRICADE WITH STEADY BURN LIGHT
-  DRUM WITH STEADY BURN LIGHT
-  DRUM WITH SIGN (WITH OPTIONAL FLASHING LIGHT) SEE DETAIL
-  TYPE I OR II CHECK BARRICADE WITH FLASHING LIGHT

All dimensions are in millimeters (inches) unless otherwise shown.

REVISIONS	
NAME	DATE
T. RAMMACHER	09/08/94
A. HOUSEH	11/07/95
A. HOUSEH	10/12/96
T. RAMMACHER	01/06/00

ILLINOIS DEPARTMENT OF TRANSPORTATION
**TRAFFIC CONTROL AND PROTECTION
 AT TURN BAYS
 (TO REMAIN OPEN TO TRAFFIC)**

SCALE: NONE
 DATE: 9/8/2006
 DRAWN BY
 CHECKED BY LHA
 TC-14
 REVISION DATE: 01/06/00

PLOT DATE = 9/8/2006
 FILE NAME = \\sawtooth\vol4\dgn
 PLOT SCALE = 49.9999 / IN.
 USER NAME = hannah