

STATE OF ILLINOIS
DEPARTMENT OF TRANSPORTATION

ROUTE NO.	SECTION	COUNTY	TOTAL SHEETS	SHEET NO.	SHEET NO. 82
F. A. I. 80/94	*	COOK	870	596	91 SHEETS
FED. ROAD DIST. NO. 1		ILLINOIS FEEL. AID PROJECT-			
(0203.1 & 0312-708W) R-3		CONTRACT NO. 62108			

NOTES

Bar splicer assemblies shall be of an approved type and shall develop in tension at least 125 percent of the yield strength of the lapped reinforcement bars.
Splicer rods shall be of minimum 400 Mpa yield strength, threaded or coiled full length.
All reinforcement bars shall be lapped and tied to the splicer rods or dowel bars.
Bar splicer assemblies shall be epoxy coated according to the requirements for reinforcement bars.
Other systems of similar design may be submitted to the Engineer for approval. Approval shall be based on certified test results from an approved testing laboratory that the proposed bar splicer assembly satisfies the following requirements:

- ① Minimum Capacity (Tension in kN) = $1.25 \times 10^{-3} \times f_y \times A_t$
- ② Minimum *Pull-out Strength (Tension in kN) = $1.25 \times 10^{-3} \times f_{s,allow} \times A_t$

Where f_y = Yield strength of lapped reinforcement bars in MPa.
 $f_{s,allow}$ = Allowable tensile stress in lapped reinforcement bars in MPa (Service Load)
 A_t = Tensile stress area of lapped reinforcement bars (mm²)
* = 28 day concrete

BAR SPLICER ASSEMBLIES			
Bar Size to be Spliced	Splicer Rod or Dowel Bar Length	Strength Requirements	
		Min. Capacity kN - tension	Min. Pull-Out Strength kN - tension
#15	610 mm	100	40
#20	790 mm	150	60
#25	1.04 m	250	100
#30	1.37 m	350	140

Bar splicer assemblies shall be according to Section 508 of the Standard Specifications, except as noted. The furnishing and installation of bar splicer assemblies will be measured and paid for at the contract unit price each for "BAR SPLICERS."

All dimensions are in millimeters (mm) except as noted.

The diameter of this part is the same as the diameter of the bar spliced.

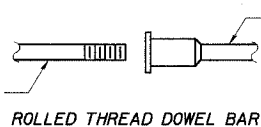

ROLLED THREAD DOWEL BAR



** ONE PIECE

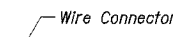

Wire Connector

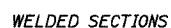

WELDED SECTIONS

BAR SPLICER ASSEMBLY ALTERNATIVES

** Heavy Hex Nuts conforming to ASTM A 563M, Grade C, D or DH may be used.

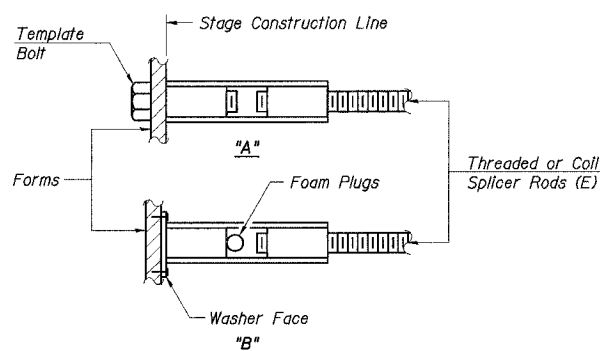

INSTALLATION AND SETTING METHODS

"A" : Set bar splicer assembly by means of a template bolt.
"B" : Set bar splicer assembly by nailing to wood forms or cementing to steel forms.
(E) : Indicates epoxy coating.

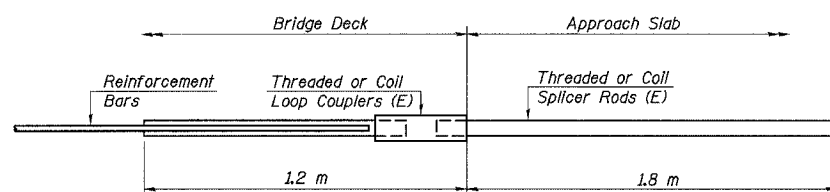

FOR INTEGRAL OR SEMI-INTEGRAL ABUTMENTS

Bar Splicer for #15 bar	
Min. Capacity =	100 kN - tension
Min. Pull-out Strength =	40 kN - tension
No. Required =	

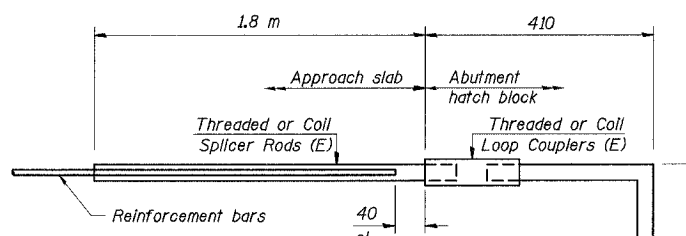

FOR PILE BENT ABUTMENTS

Bar Splicer for #15 bar	
Min. Capacity =	100 kN - tension
Min. Pull-out Strength =	40 kN - tension
No. Required =	51 (S. Abut) 69 (N. Abut)

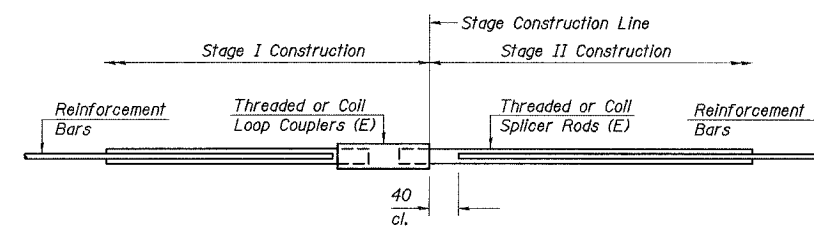

STANDARD

Bar Size	No. Assemblies Required	Location

L:\k\116 J:\34562\CADD\B\1\SN_2800\cadd\CTR_19_2800\m190014s_2800.dgn 18-005-2005 12:46

DESIGNED	MEA
CHECKED	PCA
DRAWN	LK
CHECKED	MEA

BSD-1(M) 9-01-03

ILLINOIS DEPARTMENT OF TRANSPORTATION
I-94 EAST BOUND / IL 394 SOUTH BOUND
BAR SPLICER ASSEMBLY DETAILS
SB IL ROUTE 394 / RAMP F OVER THORN CREEK
F.A.P. 332 SECTION (0203.1 & 0312-708W) R-3
COOK COUNTY
STA. 440+704.350 STRUCTURE NO. 016-2800/2845
DATE JUL 18, 2005
SCALE ---
HNTB