

SECTION THRU WEST WALL
 (Section Sta. 18+675 to Sta. 18+696)
 (Section Sta. 18+727 to Sta. 18+765)

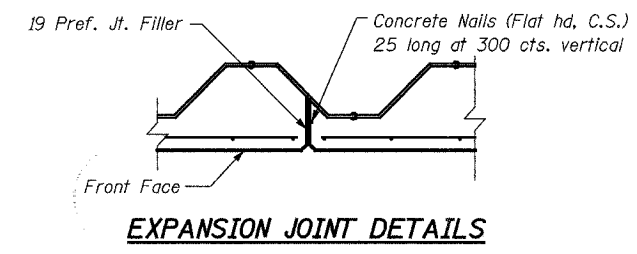

EXPANSION JOINT DETAILS

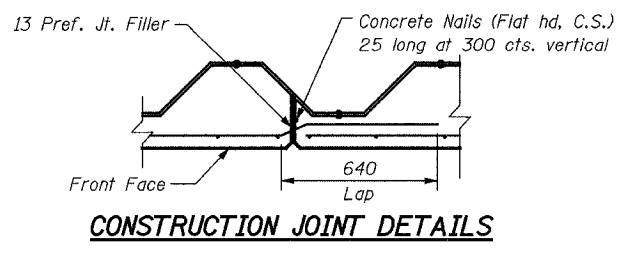

CONSTRUCTION JOINT DETAILS

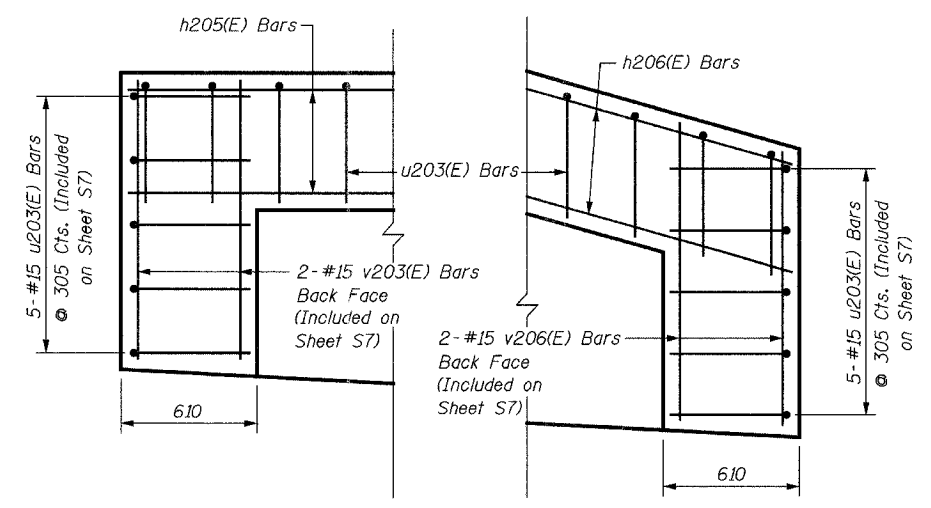

NORTH END SOUTH END

END CAP WALL DETAILS
 (Sta. 18+675 to 18+696)

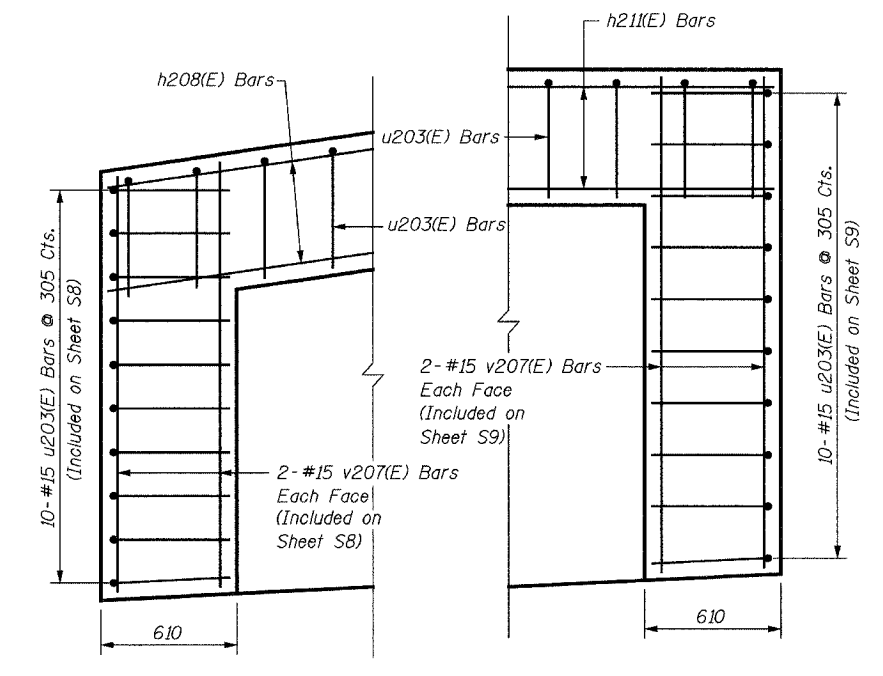

NORTH END SOUTH END

END CAP WALL DETAILS
 (Sta. 18+727 to 18+765)

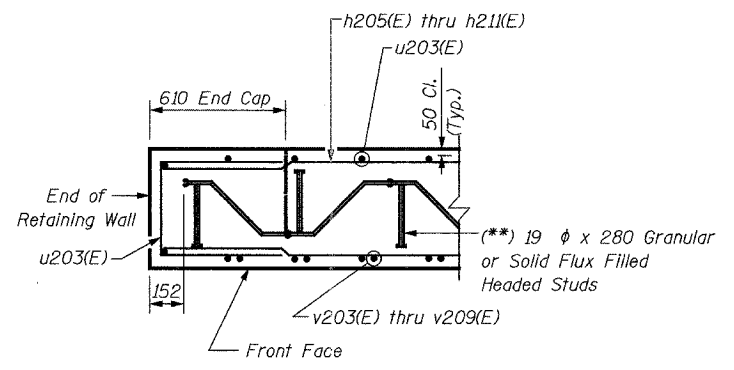

TYPICAL SECTION THRU CAP

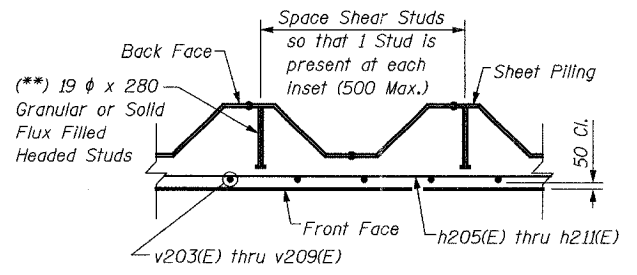

SECTION THRU WALL

() NOTE:**

Shear Studs shall be 19 dia. x 208 Granular or Solid Flux Filled Headed Studs conforming to 505.08 (m) of the Standard Specifications automatically end welded in the field to Sheet Piling. The cost of the studs is included in the cost of PERMANENT STEEL SHEET PILING.

NOTES:

See Sheet S7 for notes.

SHEET S10 of S33

REVISIONS		 1701 GOLF ROAD, SUITE 1000 ROLLING MEADOWS, IL 60008 TEL (847) 228-0707 FAX (847) 228-1115
NAME	DATE	
		VILLAGE OF OAKBROOK SALT CREEK GREENWAY TRAIL RET. WALL STA. 18+665 & 18+727 DETAILS
DATE: 06/30/05 DESIGNED BY: MDS		DRAWN BY: MDS CHECKED BY: GAT