

SIDE WALL SECTION

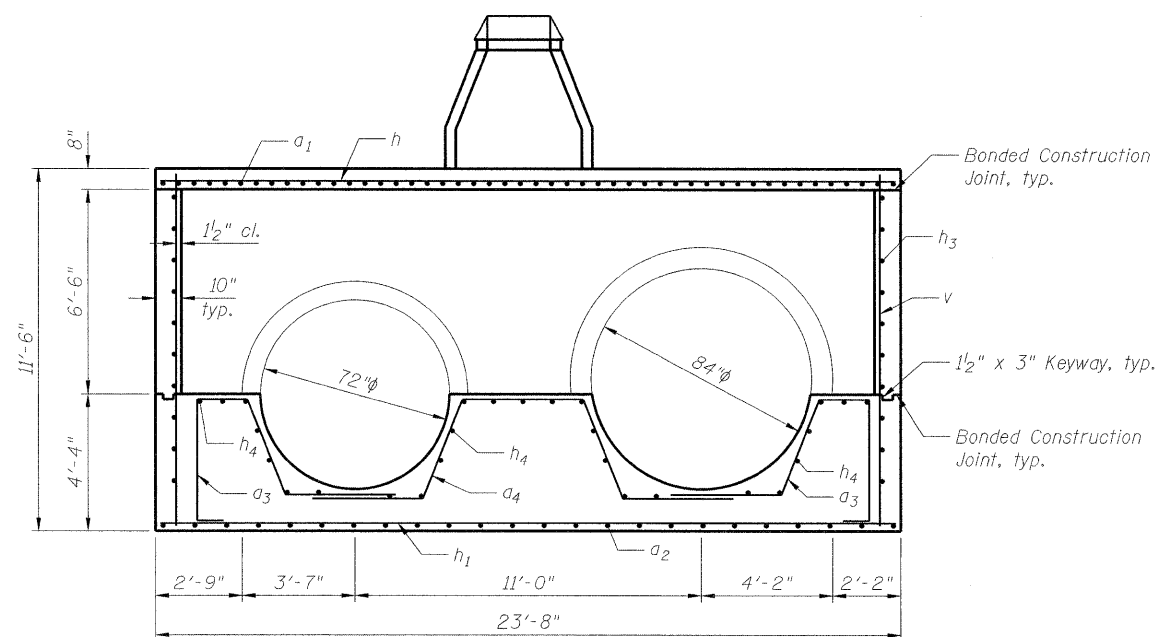

SECTION E-E

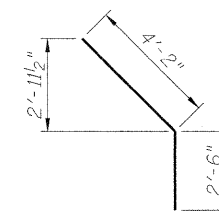

BAR h5

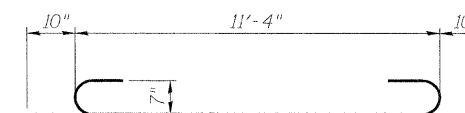

BAR a1

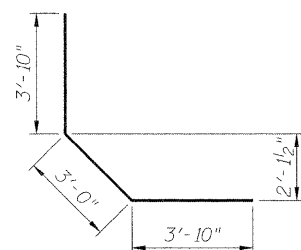

BAR h6

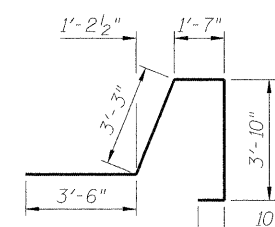

BAR a3

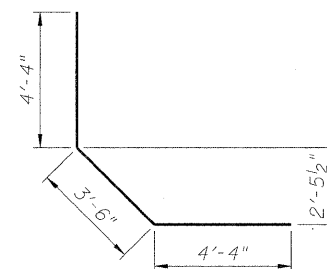

BAR h7

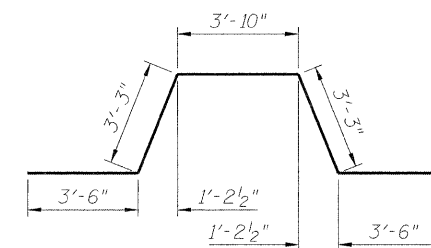

BAR a4

*Cut bars to fit as required

BILL OF MATERIAL

| Bar | No. | Size | Length | Shape |
|-----|-----|------|--------|-------|
| a1 | 48 | #7 | 13'-0" | U |
| a2 | 24 | #6 | 11'-4" | — |
| a3 | 22 | #5 | 13'-0" | Z |
| a4 | 11 | #5 | 17'-4" | Z |
| h | 13 | #6 | 23'-4" | — |
| h1 | 9 | #5 | 23'-4" | — |
| h2 | 22 | #6 | 23'-4" | — |
| h3 | 22 | #6 | 11'-4" | — |
| h4 | 27 | #5 | 9'-8" | — |
| h5 | 4 | #5 | 6'-8" | L |
| h6 | 4 | #5 | 10'-8" | L |
| h7 | 4 | #5 | 12'-2" | L |
| v | 90 | #5 | 11'-2" | — |

FILE NAME = g:\project\2102155_011\cadd\structure\003\Box1\Reinforcement2.dgn



USER NAME = 2bookd
 PLOT SCALE = N/A
 PLOT DATE = 9/7/2011

DESIGNED - TWO
 CHECKED - BHS
 DRAWN - TWO
 CHECKED - GSP

REVISED -
 REVISED -
 REVISED -
 REVISED -

STATE OF ILLINOIS
 DEPARTMENT OF TRANSPORTATION

JUNCTION CHAMBER #1
 REINFORCEMENT DETAILS (2 OF 2)

SHEET NO. OF SHEETS

| | | | | |
|---|------------------|-------------|-----------------|--------------|
| F.A.I. RTE. 190 | SECTION 0102.5-T | COUNTY COOK | TOTAL SHEETS 41 | SHEET NO. 28 |
| CONTRACT NO. 60F90 | | | | |
| FED. ROAD DIST. NO. 1 ILLINOIS FED. AID PROJECT | | | | |