

CENTERLINE INTERSTATE OR MULTI-LANE TWO WAY DIVIDED HIGHWAY

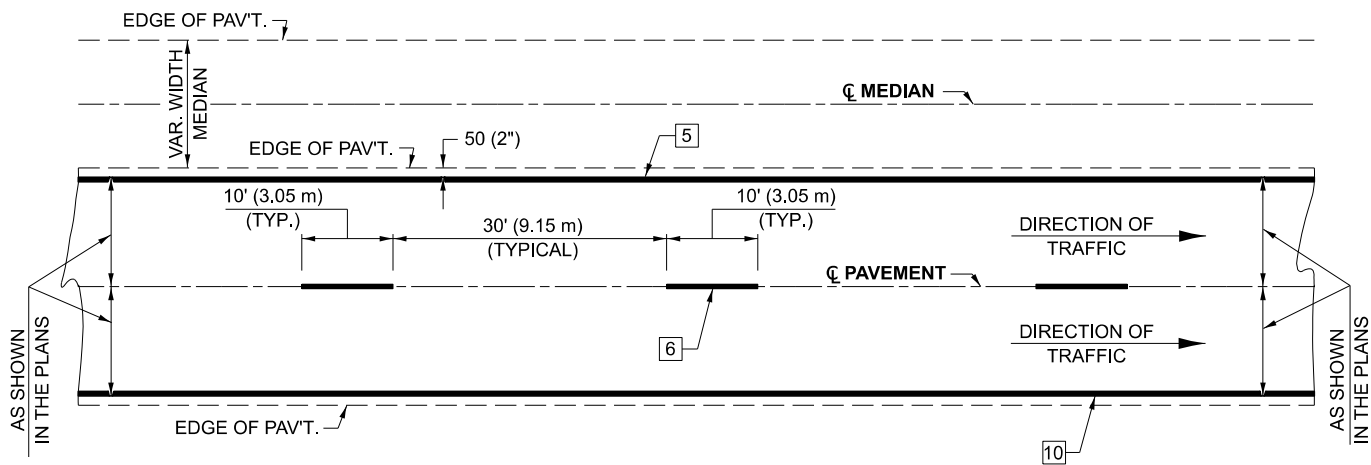

NOTE: PAVEMENT MARKINGS ARE TO BE EXTENDED THROUGH OMISSIONS WHEN APPLICABLE.

NOTE: SEE ARTICLES 780.04 & 781.03 FOR LOCATION OF STRIPES AND MARKERS RELATIVE TO EDGES OR JOINTS.
FOR RAISED REFLECTIVE PAVEMENT MARKERS, REFER TO STANDARD 781001.

TYPICAL EXIT RAMP TERMINAL

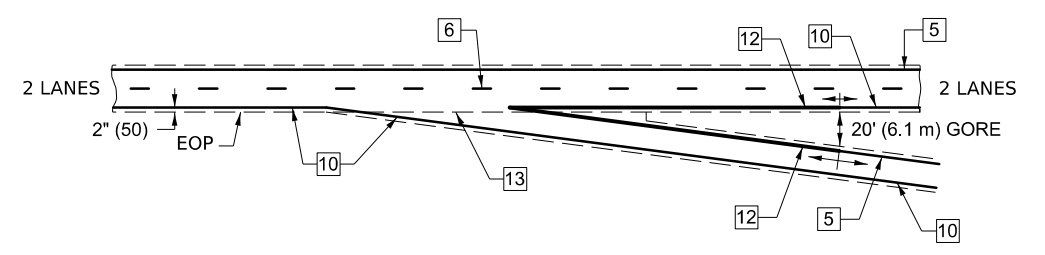

EXIT RAMP TERMINAL with EXCLUSIVE (auxiliary) LANE

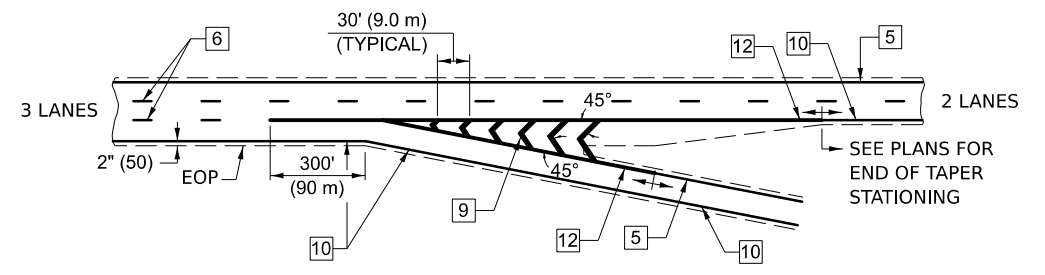

TYPICAL PAVEMENT MARKING LEGEND

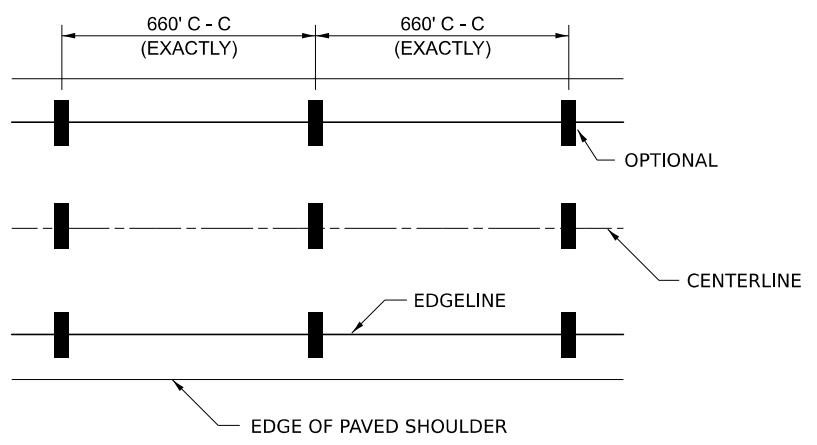

- 1 4" (100) SKIP-DASH (YELLOW)
- 2 4" (100) SOLID (YELLOW)
- 3 12" (300) DIAGONAL (YELLOW)
- 4 4" (100) DOUBLE YELLOW (NARROW)
- 5 6" (150) SOLID (YELLOW)
- 6 6" (150) SKIP-DASH (WHITE)
- 7 4" (100) SKIP-DASH (WHITE)
- 8 4" (100) SOLID (WHITE)
- 9 12" (300) DIAGONAL (WHITE)
- 10 6" (150) SOLID (WHITE)
- 11 24" (600) STOP BAR (WHITE)
- 12 8" (200) SOLID (WHITE)
- 13 6" (150) LANE LINE EXTENSIONS (WHITE)

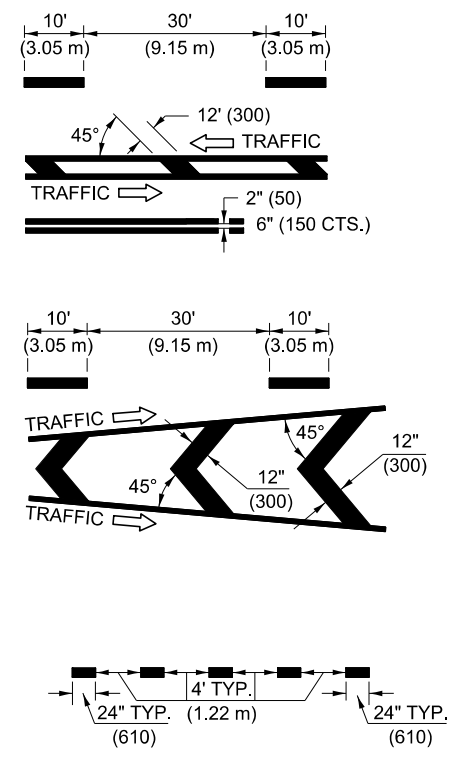

TYPICAL ENTRANCE RAMP TERMINAL

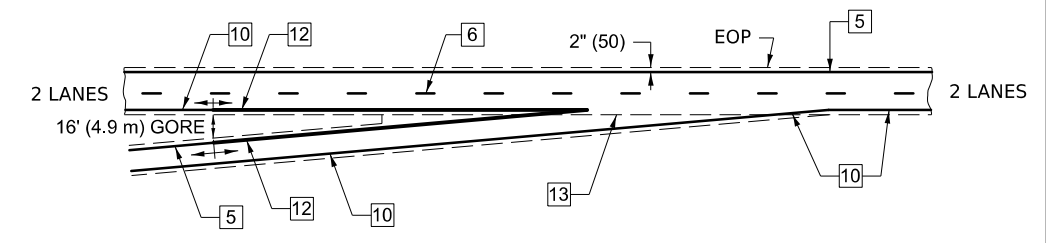

ENTRANCE RAMP TERMINAL with EXCLUSIVE LANE

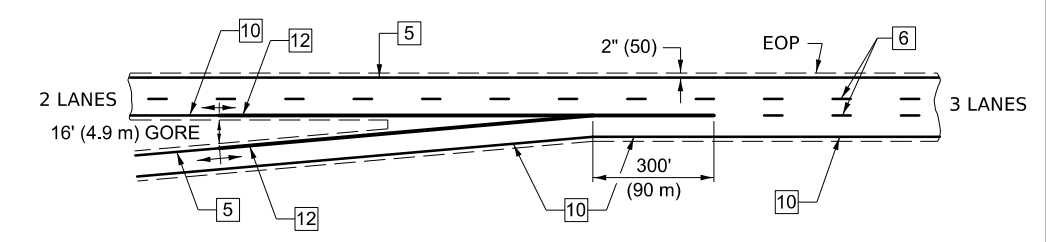

IT WILL BE NECESSARY TO HAVE A REPRESENTATIVE OF THE STATE POLICE PRESENT SO THAT THE ACCURACY OF MEASUREMENT CAN BE ATTESTED TO IN COURT.

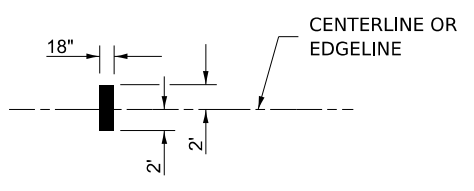

AERIAL SPEED CHECK ZONES

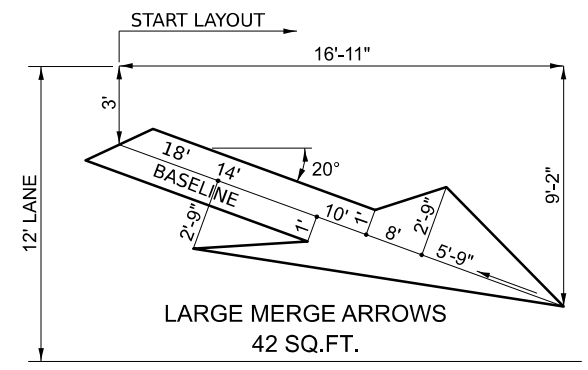

Note: All dimensions are in INCHES (millimeters) unless otherwise shown.

DISTRICT 5 DETAIL NO. 7800BBBB

| | | |
|--------------------------|------------|-----------------|
| USER NAME = Eric.Thomas | DESIGNED - | REVISED - 11/06 |
| PLOT SCALE = \$\$SCALE\$ | DRAWN - | REVISED - 12/20 |
| PLOT DATE = 12/7/2022 | CHECKED - | REVISED - |
| | DATE - | REVISED - |

STATE OF ILLINOIS
DEPARTMENT OF TRANSPORTATION

PAVEMENT MARKING (INTERSTATE & MULTI-LANE APPLICATIONS)

SCALE: SHEET 1 OF 1 SHEETS STA. TO STA.

| F.A. RTE. | SECTION | COUNTY | TOTAL SHEETS | SHEET NO. |
|---------------------------|---------|--------|--------------|-----------|
| | | | | |
| CONTRACT NO. | | | | |
| ILLINOIS FED. AID PROJECT | | | | |

MODEL: SHT_PLAN
FILE NAME: C:\Bentley\CONNECT1011\Organization\ChilIDOT_Standards\CallIDOT_Sheets.cad