

STATE OF ILLINOIS  
DEPARTMENT OF TRANSPORTATION

\* **CULVERT**  
**BILL OF MATERIAL**

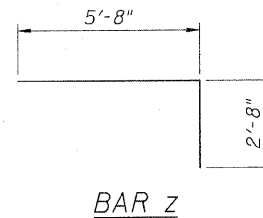
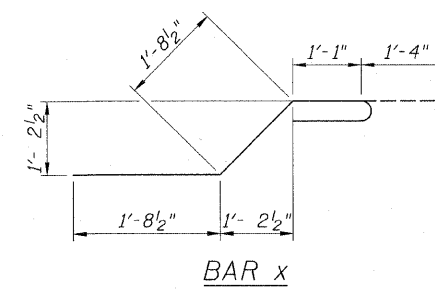
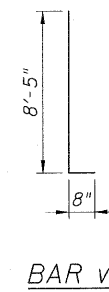
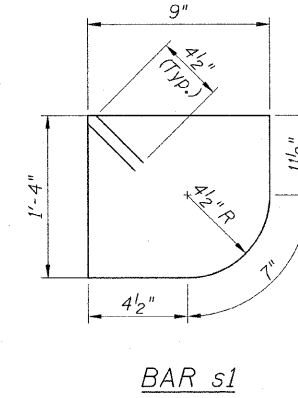
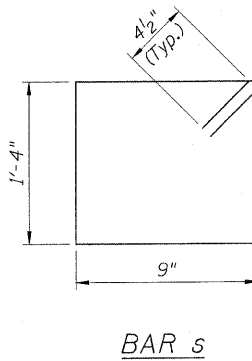
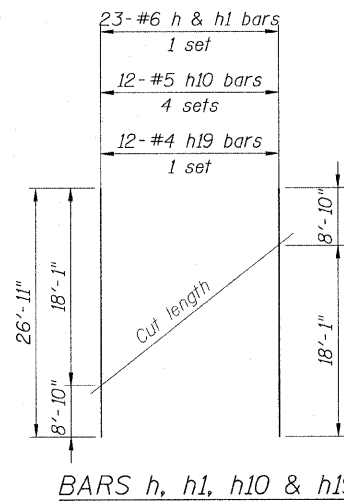
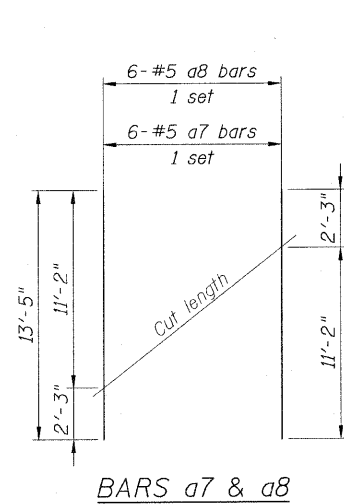
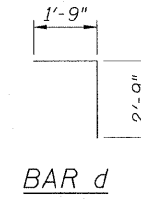
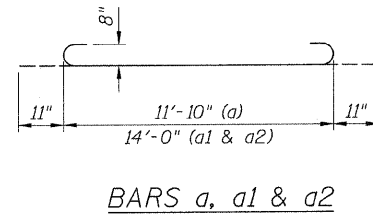
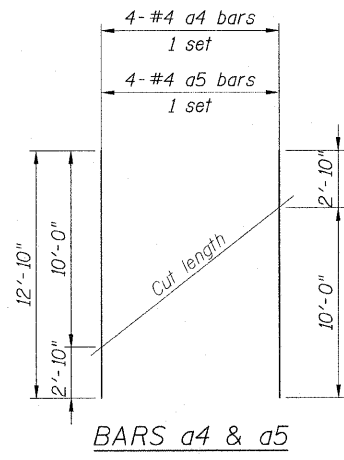
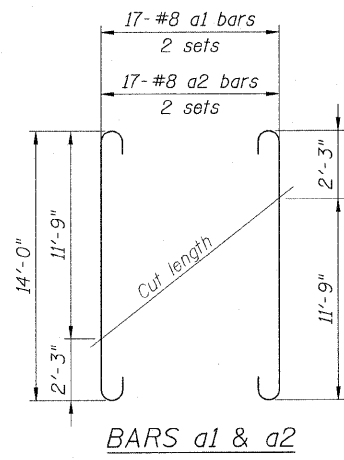

**FIELD CUTTING DIAGRAMS**

Order bars full length. Cut as shown and use remainder of bars in opposite side.

**BAR BENDING DIAGRAMS**

**REINFORCEMENT DETAILS**  
**STRUCTURE NO. 101-1084**

Bar	No.	Size	Length	Shape
a	136	8	13'-8"	
a1	34	8	15'-10"	
a2	34	8	15'-10"	
a3	20	4	11'-10"	
a4	4	4	12'-10"	
a5	4	4	12'-10"	
a6	24	5	11'-10"	
a7	6	5	13'-5"	
a8	6	5	13'-5"	
d	64	4	4'-6"	
h	23	6	26'-11"	
h1	23	6	26'-11"	
h2	6	6	32'-3"	
h6	14	6	9'-2"	
h7	14	6	18'-5"	
h8	14	6	8'-11"	
h9	14	6	18'-7"	
h10	48	5	26'-11"	
h11	4	6	15'-8"	
h12	4	8	16'-3"	
h13	4	6	16'-4"	
h14	4	8	16'-4"	
h15	24	4	8'-2"	
h16	2	4	9'-0"	
h17	24	4	17'-11"	
h18	2	4	18'-3"	
h19	24	4	26'-11"	
s	33	4	4'-11"	
s1	33	4	4'-9"	
v	144	4	9'-1"	
v1(E)	84	4	6'-6"	
v2	14	4	4'-8"	
v3	14	4	6'-6"	
v4	28	4	4'-8"	
v5	28	4	6'-6"	
v6(E)	8	4	4'-8"	
v7	8	4	8'-5"	
w	16	5	11'-2"	
w1	16	5	20'-8"	
x	152	4	5'-10"	
x1	12	4	9'-10"	
x2	12	4	13'-5"	
x3	12	4	13'-2"	
z	76	7	8'-4"	
			Cu. Yd.	97.0
Concrete Box Culverts			Pound	19,440
Reinforcement Bars			Pound	390
Reinforcement Bars, Epoxy Coated				

\* Bill of material is the total for both end sections.

DESIGNED	BJM
CHECKED	MAS
DRAWN	TMF / JNH
CHECKED	BRT



Wight & Company  
2500 North Frontage Road . Darien . IL 60561  
630.969.7000 630.969.7979 fax  
Design Firm Registration 184-000451

SHEET NO. 9 9 SHEETS	F.A.P. RTE.	SECTION	COUNTY	TOTAL SHEETS	SHEET NO.
	505	115RS-2	WINNEBAGO	120	51
STA. 791+50 TO STA. 796+00		CONTRACT NO. 64E89			
FED. ROAD DIST. NO.		ILLINOIS FED. AID PROJECT			