

| F.A.P. RTE. | SECTION | COUNTY | TOTAL SHEETS | SHEET NO. |
|---------------------|---------|---------------------------|--------------|-----------|
| 685 | 37BR-1 | MCDONOUGH | 138 | 78 |
| STA. 557+20.00 | | TO STA. 589+00.00 | | |
| FED. ROAD DIST. NO. | | ILLINOIS FED. AID PROJECT | | |

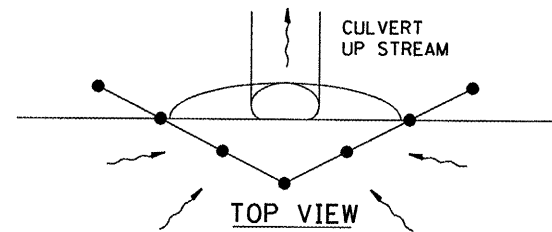

UPSTREAM PIPE CULVERT EROSION CONTROL

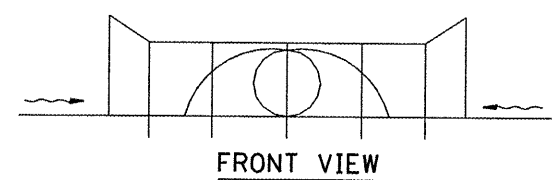
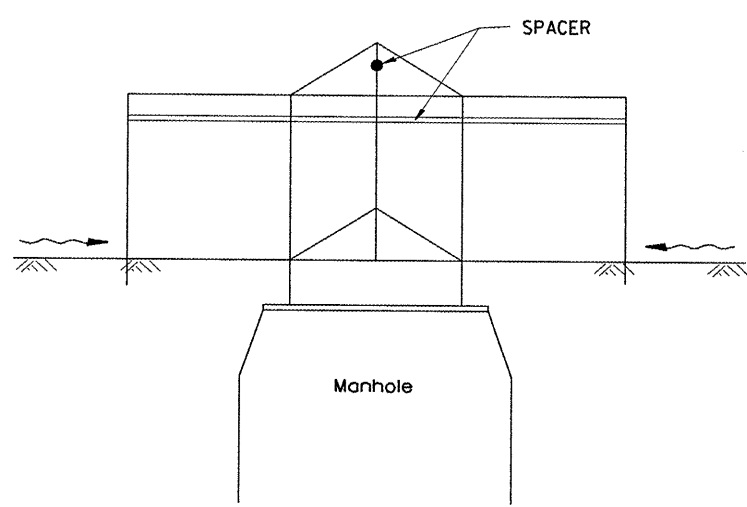

SIDE VIEW
A-A

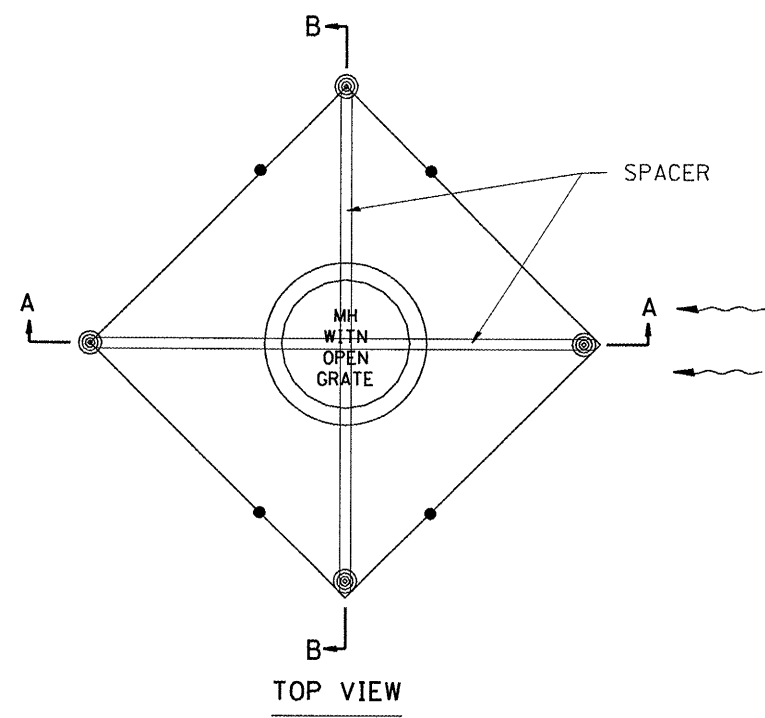

TOP VIEW

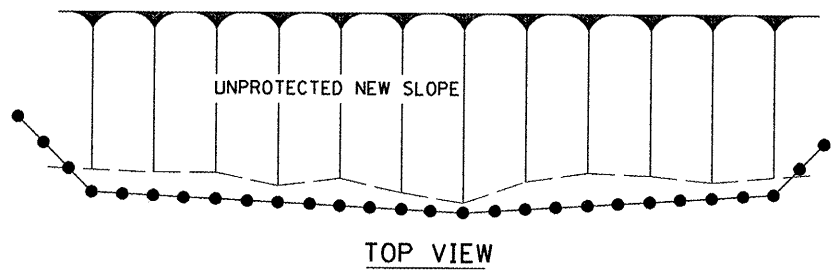

TOP VIEW

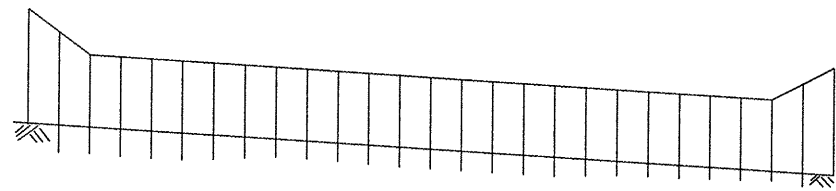

FRONT VIEW

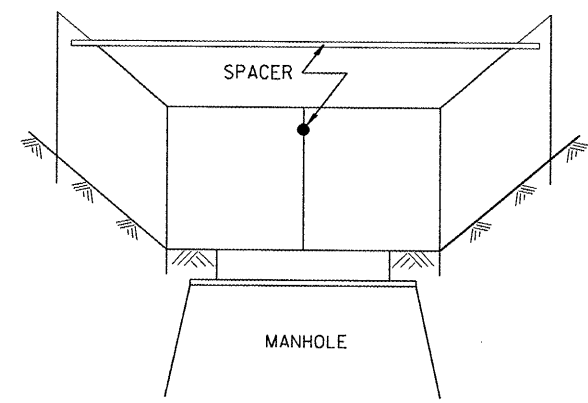

FRONT VIEW
B-B

EROSION CONTROL
AT
OPEN GRATE MAN HOLE

GENERAL NOTES:

1. This work shall be performed in accordance with Sections 280 & 1081, of the Standard Specifications.
2. Additional Timber or Metal Post shall be installed, as needed.

All dimensions are in inches (millimeters) unless otherwise noted.

| | |
|--|---------------|
| ILLINOIS DEPARTMENT OF TRANSPORTATION | |
| SPECIAL DETAIL SHEET | |
| TYPICAL APPLICATION OF SILT FILTER FENCE | |
| CADD DETAIL 280001-D4 | DRAWN BY CADD |
| SCALE: NOT DRAWN TO SCALE | CHECKED BY |

| DATE | REVISIONS | BY |
|---------|-----------------------------------|--------|
| 1-1-97 | RENUM. A-12.05, NEW REVISION BOX | T.P. |
| 3-11-03 | ELIMINATED SILT FENCE DITCH CHECK | M.M.A. |
| | | |
| | | |
| | | |
| | | |

Designer NOTES:
 1. Designer to modify this Special Detail sheet, as needed, for inclusion in plans.
 2. Include Highway Standard 280001 "TEMPORARY EROSION CONTROL SYSTEM."