

F.A.S. SECTION COUNTY TOTAL SHEETS SHEET NO.
748 06-00053-00 RS JERSEY 110 39
STA. NA TO STA. NA
CONTRACT #97375 PROJECT NO. RS-0748(109)

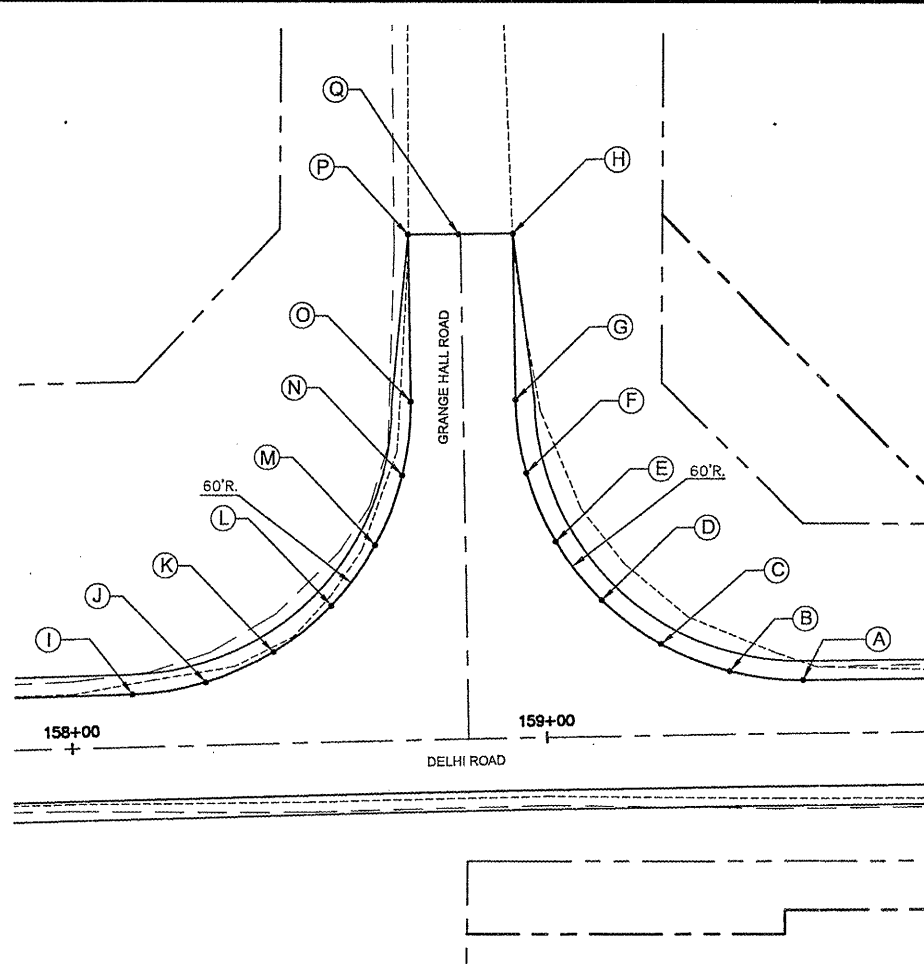

POINT	STATION	OFFSET	ELEVATION
A	159+53.91	11.00' LT	606.39
B	159+38.48	13.04' LT	605.72
C	159+24.12	19.01' LT	605.06
D	159+11.80	28.50' LT	604.40
E	159+02.36	40.87' LT	604.71
F	158+96.43	55.27' LT	605.03
G	158+94.40	70.71' LT	605.34
H	158+94.35	105.38' LT	606.04
I	158+12.92	11.00' LT	601.96
J	158+28.35	13.04' LT	602.17
K	158+42.71	19.01' LT	602.37
L	158+55.03	28.51' LT	602.95
M	158+64.47	40.87' LT	603.48
N	158+70.40	55.27' LT	603.98
O	158+72.43	70.72' LT	604.48
P	158+72.47	105.60' LT	605.60
Q	159+82.99	105.48' LT	606.02

**DELHI ROAD
&
GRANGE HALL ROAD**

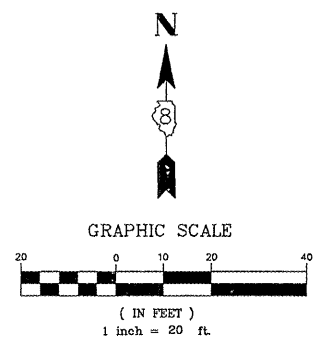

POINT	STATION	OFFSET	ELEVATION
A	167+99.43	11.00' RT	626.14
B	167+85.07	13.67' RT	625.66
C	167+72.62	21.32' RT	625.18
D	166+83.89	11.00' RT	625.70
E	166+98.99	13.98' RT	625.50
F	167+11.86	22.40' RT	625.30

**DELHI ROAD
&
STONE CIRCLE DRIVE**

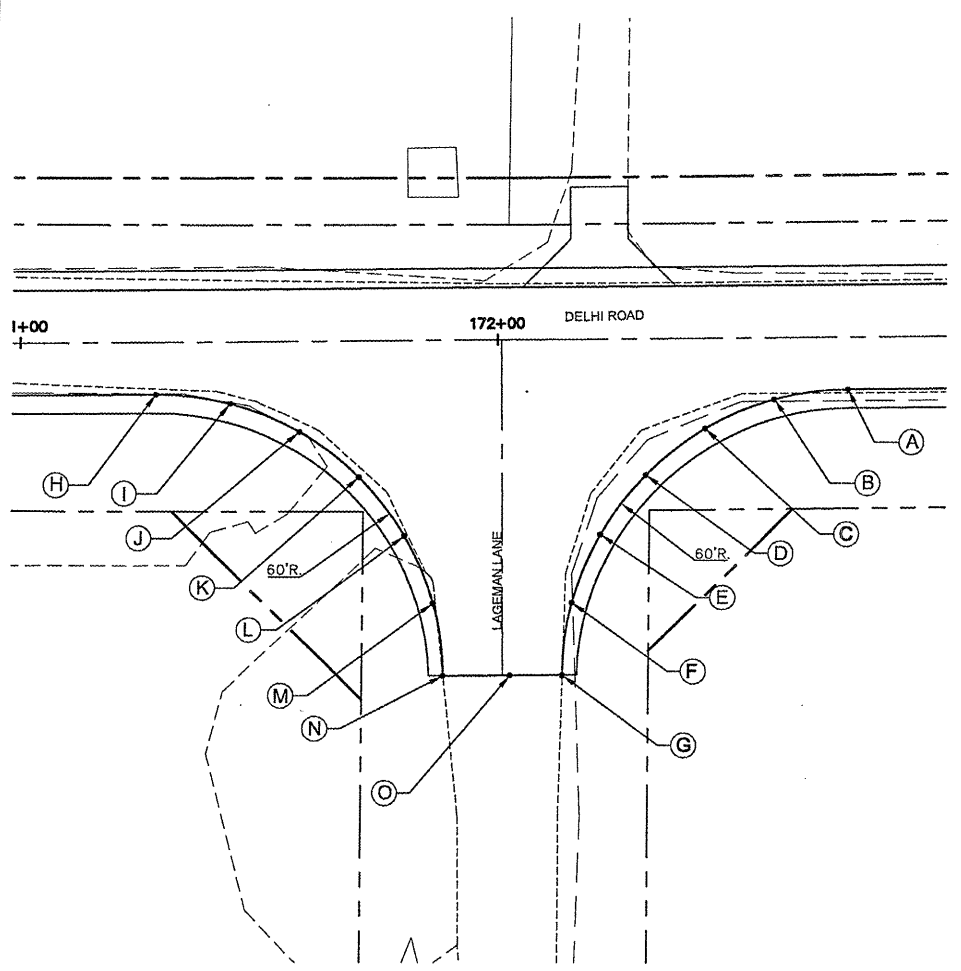
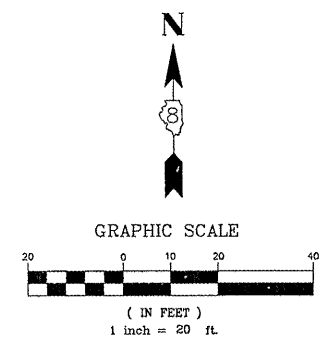
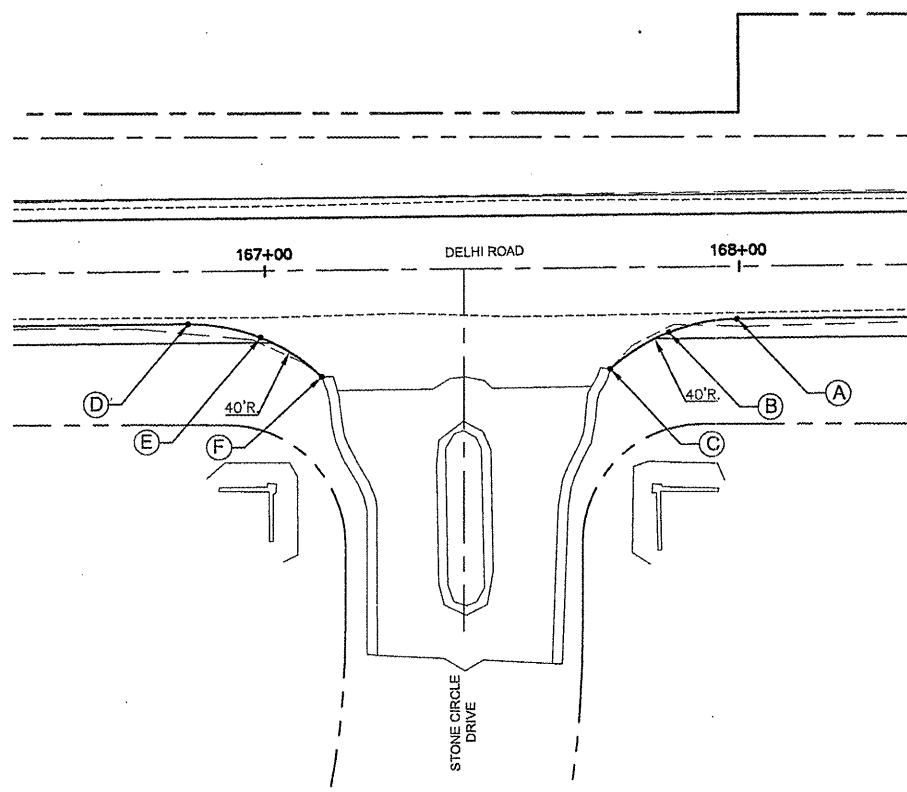

POINT	STATION	OFFSET	ELEVATION
A	172+73.36	11.00' RT	626.75
B	172+57.81	13.05' RT	626.56
C	172+43.34	19.04' RT	626.37
D	172+30.91	28.68' RT	626.18
E	172+21.38	41.01' RT	625.74
F	172+15.39	55.49' RT	625.31
G	172+13.35	71.02' RT	624.87
H	171+28.32	11.00' RT	626.24
I	171+43.85	13.04' RT	626.15
J	171+58.32	19.04' RT	626.05
K	171+70.75	28.57' RT	625.98
L	171+80.28	41.00' RT	625.48
M	171+86.28	55.47' RT	625.01
N	171+86.32	71.00' RT	624.53
O	172+13.35	71.02' RT	625.20

**DELHI ROAD
&
LAGEMAN LANE**

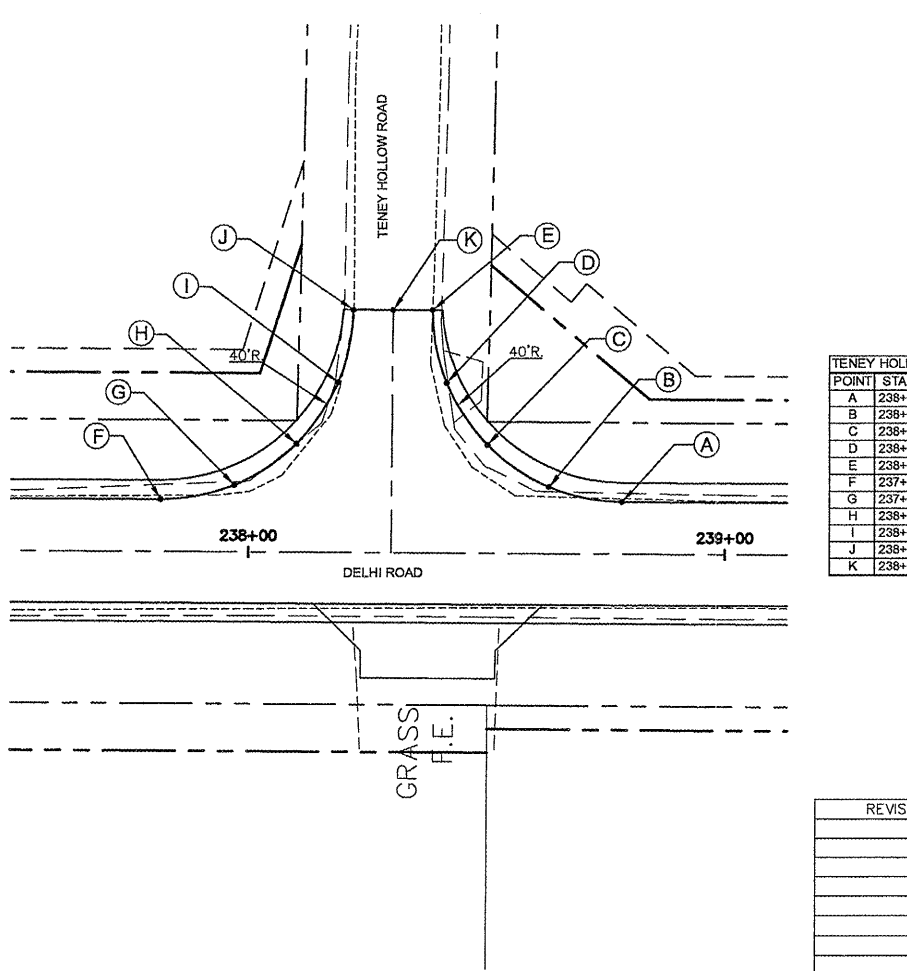
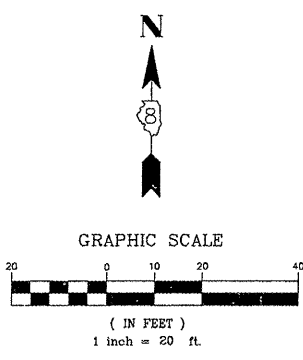

POINT	STATION	OFFSET	ELEVATION
A	238+78.34	11.00' LT	626.82
B	238+63.04	14.05' LT	626.89
C	238+50.08	22.72' LT	626.45
D	238+41.39	35.69' LT	625.10
E	238+38.34	51.00' LT	623.78
F	237+81.64	11.00' LT	627.35
G	237+96.05	14.05' LT	626.98
H	238+08.92	22.72' LT	626.62
I	238+18.59	35.69' LT	625.31
J	238+21.64	51.00' LT	623.99
K	238+30.06	51.00' LT	624.20

**DELHI ROAD
&
TENNEY HOLLOW ROAD**

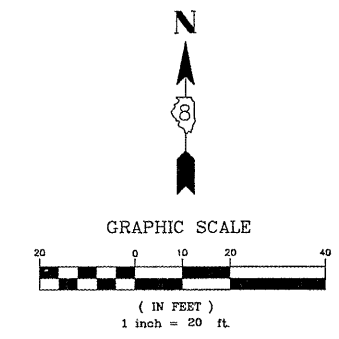

REVISIONS	DATE

ILLINOIS DEPARTMENT OF TRANSPORTATION
INTERSECTION DETAILS
DELHI ROAD
F.A.U. ROUTE 748
SECTION 06-00053-00-RS
JERSEY COUNTY