

POSITION OF HANDHOLE AND POLE NUMBER FOR SINGLE MAST ARM POLES MOUNTED ON BRIDGE PARAPET OR BARRIER WALL

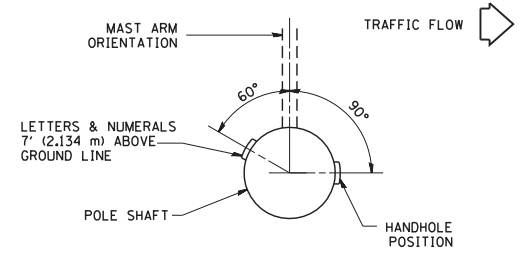

POSITION OF HANDHOLE AND POLE NUMBER FOR SINGLE MAST ARM POLES

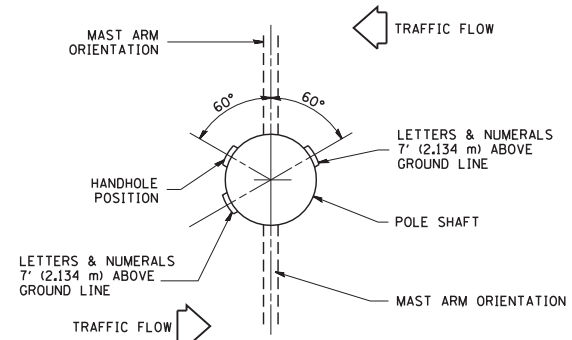

POSITION OF HANDHOLE AND POLE NUMBER FOR TWIN MAST ARM POLES

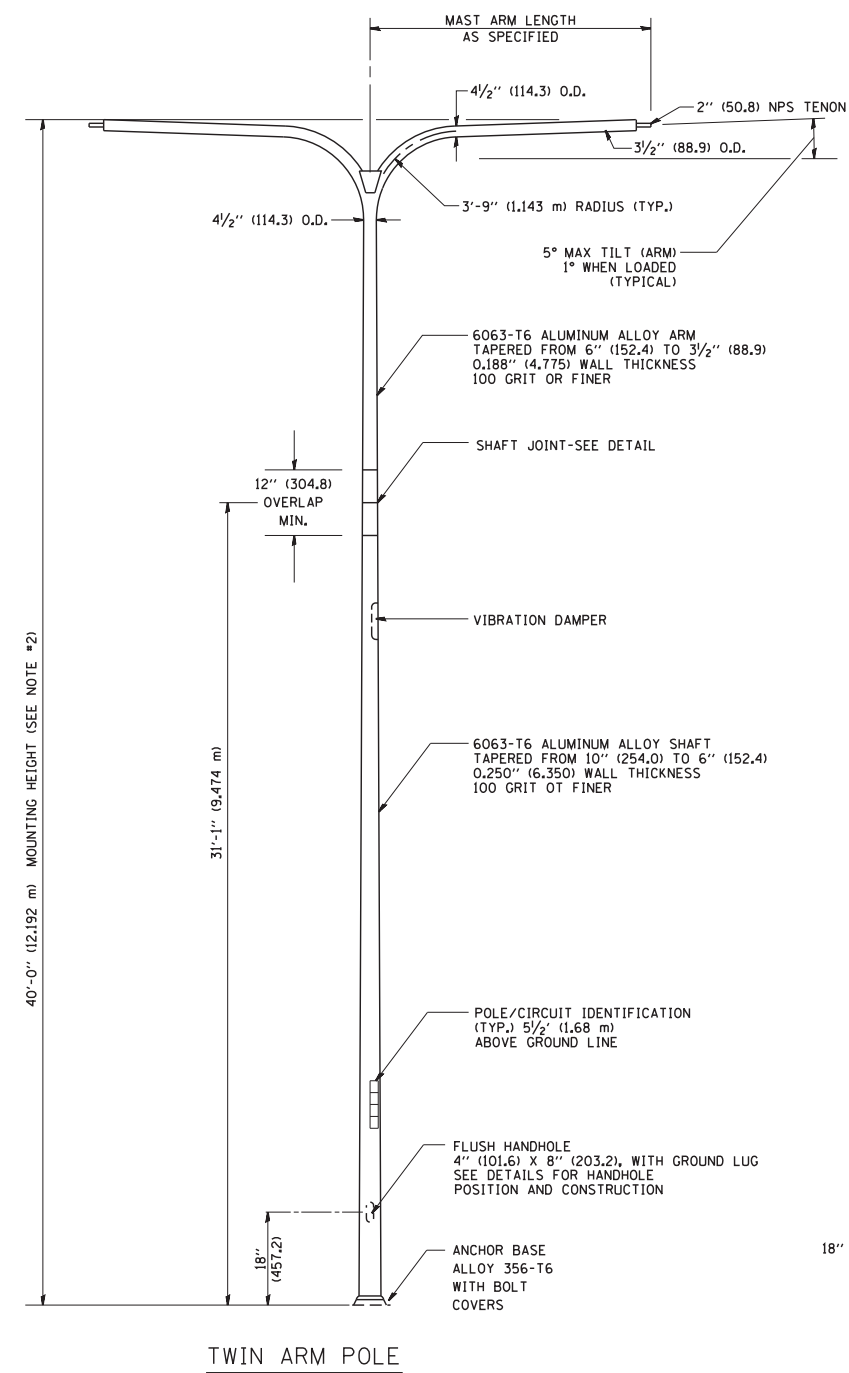

TWIN ARM POLE

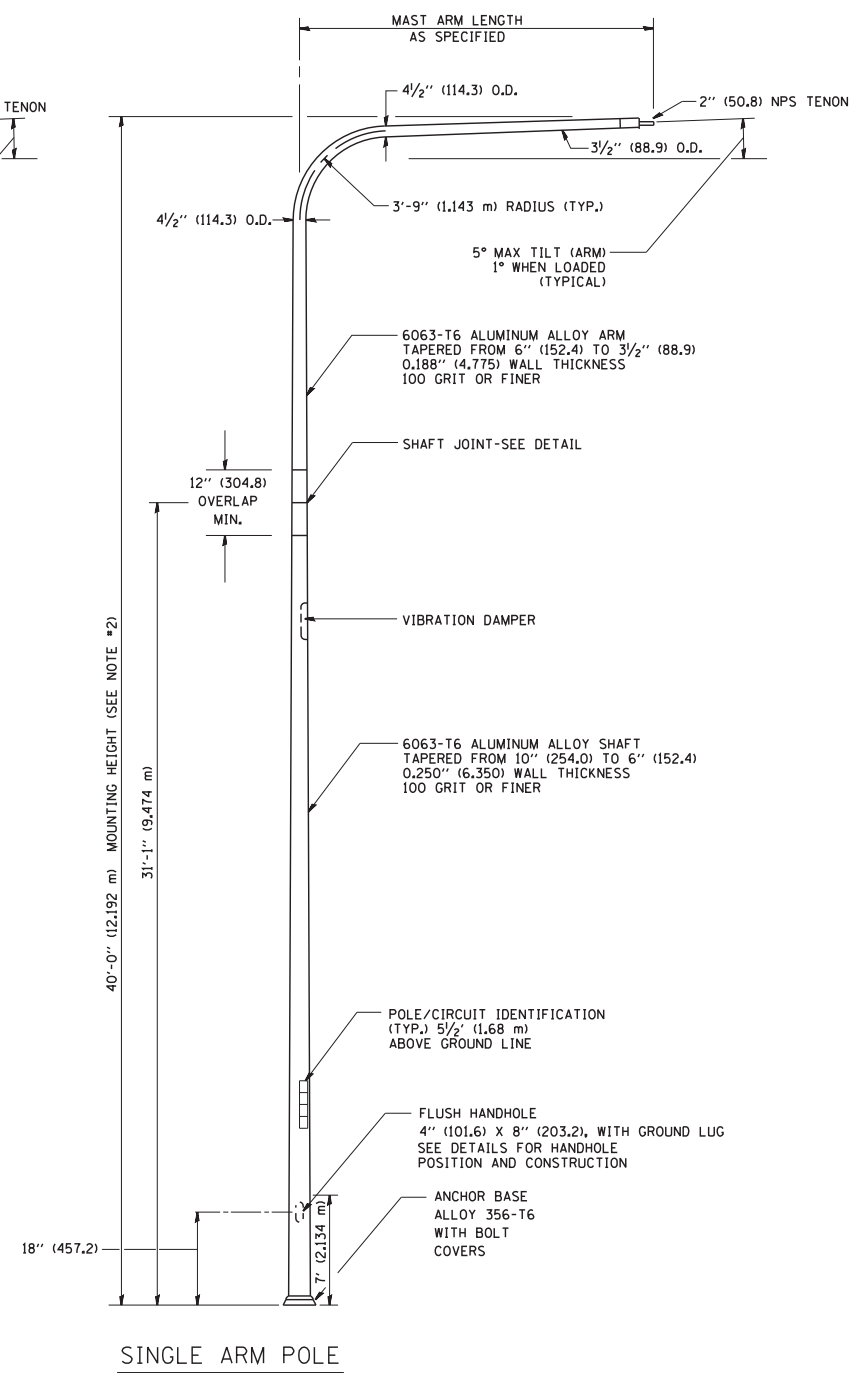

SINGLE ARM POLE

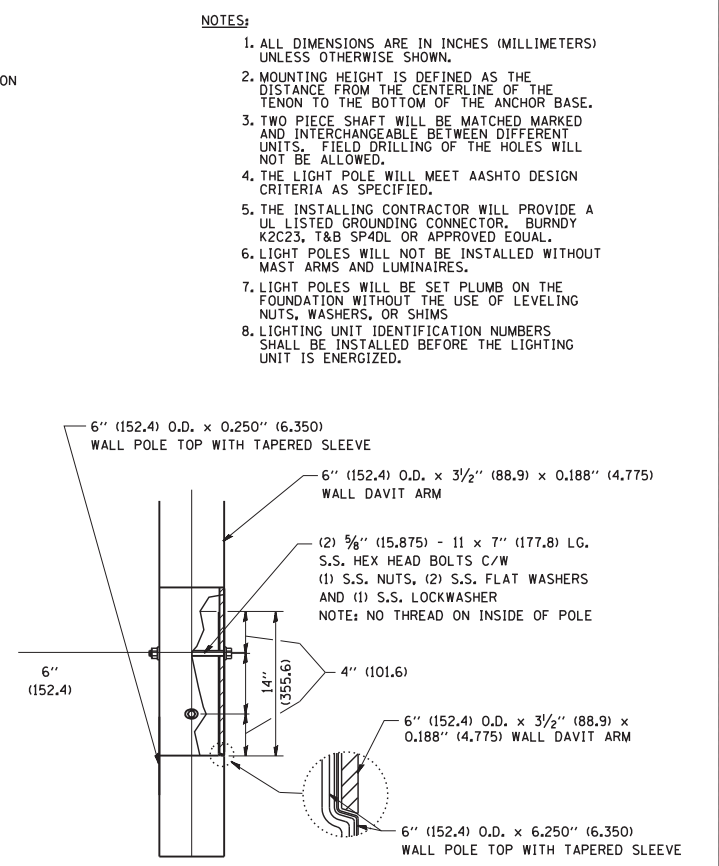

DAVIT ARM CONNECTION [14\"/>

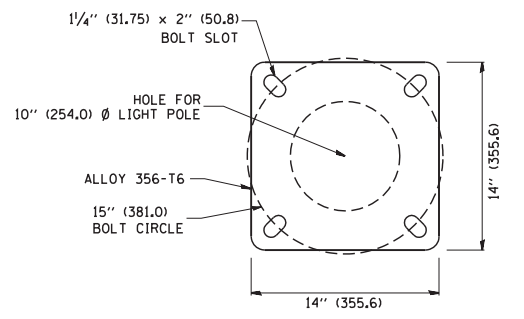

LIGHT POLE BASE PLATE DETAIL (FOR POLE MOUNTED ON 15 INCH (381.0) BOLT CIRCLE FOUNDATION)

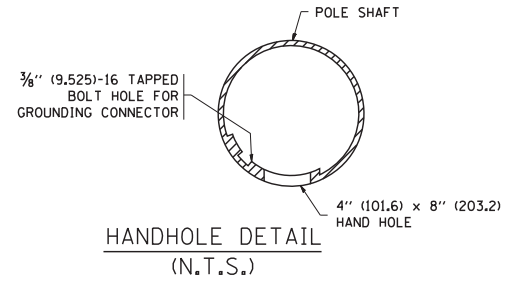

HANDHOLE DETAIL (N.T.S.)

- NOTES:**
1. ALL DIMENSIONS ARE IN INCHES (MILLIMETERS) UNLESS OTHERWISE SHOWN.
 2. MOUNTING HEIGHT IS DEFINED AS THE DISTANCE FROM THE CENTERLINE OF THE TENON TO THE BOTTOM OF THE ANCHOR BASE.
 3. TWO PIECE SHAFT WILL BE MATCHED MARKED AND INTERCHANGEABLE BETWEEN DIFFERENT UNITS. FIELD DRILLING OF THE HOLES WILL NOT BE ALLOWED.
 4. THE LIGHT POLE WILL MEET AASHTO DESIGN CRITERIA AS SPECIFIED.
 5. THE INSTALLING CONTRACTOR WILL PROVIDE A UL LISTED GROUNDING CONNECTOR, BURNDY K2C23, T&B SP4DL OR APPROVED EQUAL.
 6. LIGHT POLES WILL NOT BE INSTALLED WITHOUT MAST ARMS AND LUMINAIRES.
 7. LIGHT POLES WILL BE SET PLUMB ON THE FOUNDATION WITHOUT THE USE OF LEVELING NUTS, WASHERS, OR SHIMS.
 8. LIGHTING UNIT IDENTIFICATION NUMBERS SHALL BE INSTALLED BEFORE THE LIGHTING UNIT IS ENERGIZED.

FILE NAME = W:\diststd\22x34\be411.dgn	USER NAME = gaglionobt	DESIGNED -	REVISED - D. DREW 04-02-92
		DRAWN - LEY	REVISED - D. DREW 05-07-92
	PLOT SCALE = 50.0000' / IN.	CHECKED -	REVISED - R. TOMSONS 09-06-00
	PLOT DATE = 1/4/2008	DATE -	REVISED - R. TOMSONS 09-02-03

STATE OF ILLINOIS
DEPARTMENT OF TRANSPORTATION

DAVIT LIGHT POLE
40'-0" (12.192 m) MOUNTING HEIGHT

SCALE: NONE SHEET NO. 1 OF 1 SHEETS STA. TO STA.

F.A. RTE.	SECTION	COUNTY	TOTAL SHEETS	SHEET NO.
	BE-411		537	391
FED. ROAD DIST. NO. 1 ILLINOIS		FED. AID PROJECT		