

LETTING ITEM NO. 1A
LETTING DATE: 03/03/2017

TOTAL SHEETS: 18
CE035

CONSTRUCTION PLANS FOR **CENTRALIA MUNICIPAL AIRPORT**

CITY OF CENTRALIA, ILLINOIS
CENTRALIA, ILLINOIS

IL. PROJ. NO. ENL-4498
SBG PROJ. NO. 3-17-SBGP-120/133

AIRFIELD PAVEMENT MARKING - PHASE 1

Summary of Quantities			
ITEM NO.	ITEM DESCRIPTION	UNIT	QUANTITY
BASE BID			
AR620520	PAVEMENT MARKING - WATERBORNE	SF	41,920
AR620525	PAVEMENT MARKING - BLACK BORDER	SF	11,715
AR620900	PAVEMENT MARKING REMOVAL	SF	24,175
ADDITIVE ALTERNATE #1			
AS620520	PAVEMENT MARKING - WATERBORNE	SF	4,625
AS620525	PAVEMENT MARKING - BLACK BORDER	SF	3,725
AS620900	PAVEMENT MARKING REMOVAL	SF	165
ADDITIVE ALTERNATE #2			
AT620520	PAVEMENT MARKING - WATERBORNE	SF	4,005
AT620525	PAVEMENT MARKING - BLACK BORDER	SF	8,010
ADDITIVE ALTERNATE #3			
AU620520	PAVEMENT MARKING - WATERBORNE	SF	2,000
AU620525	PAVEMENT MARKING - BLACK BORDER	SF	3,375
AU620900	PAVEMENT MARKING REMOVAL	SF	155

Sheet List Table	
Sheet No.	Sheet Title
1	COVER SHEET
2	AIRPORT SITE PLAN
3	CONSTRUCTION ACTIVITY PLAN 1
4	CONSTRUCTION ACTIVITY PLAN 2
5	CONSTRUCTION ACTIVITY PLAN 3
6	CONSTRUCTION ACTIVITY PLAN 4
7	CONSTRUCTION ACTIVITY PLAN NOTES & DETAILS 1
8	CONSTRUCTION ACTIVITY PLAN NOTES & DETAILS 2
9	PAVEMENT MARKING PLAN 1
10	PAVEMENT MARKING PLAN 2
11	PAVEMENT MARKING PLAN 3
12	PAVEMENT MARKING PLAN 4
13	PAVEMENT MARKING PLAN 5
14	PAVEMENT MARKING PLAN 6
15	PAVEMENT MARKING PLAN 7
16	PAVEMENT MARKING PLAN 8
17	PAVEMENT MARKING DETAILS 1
18	PAVEMENT MARKING DETAILS 2

MAX EQUIPMENT HEIGHT IS 25'
 CENTRALIA UNICOM FREQUENCY
 IS 122.8 MHz

DESIGN INFORMATION

RUNWAY 18/36
 AIRPLANE DESIGN GROUP II
 AIRPLANE APPROACH CATEGORY B
 RUNWAY SAFETY AREA (RSA) WIDTH = 150'
 RUNWAY OBJECT FREE ZONE (ROFZ) WIDTH = 400'
 RUNWAY OBJECT FREE AREA (ROFA) WIDTH = 500'

RUNWAY 9/27
 AIRPLANE DESIGN GROUP I
 AIRPLANE APPROACH CATEGORY A
 RUNWAY SAFETY AREA (RSA) WIDTH = 120'
 RUNWAY OBJECT FREE ZONE (ROFZ) WIDTH = 250'
 RUNWAY OBJECT FREE AREA (ROFA) WIDTH = 400'

TAXIWAY A
 AIRPLANE DESIGN GROUP II
 TAXIWAY SAFETY AREA (TSA) WIDTH = 79'
 TAXIWAY OBJECT FREE AREA (TOFA) WIDTH = 131'

811 Know what's below. Call before you dig. **COMMON GROUND ALLIANCE**
 www.call811.com or Phone: 811

THE LOCATION, SIZE AND TYPE OF MATERIAL OF EXISTING UNDERGROUND UTILITIES INDICATED ON THE PLANS IS NOT REPRESENTED AS BEING ACCURATE, SUFFICIENT OR COMPLETE. IT SHALL BE THE CONTRACTOR'S RESPONSIBILITY TO DETERMINE THE ACTUAL LOCATION OF ALL SUCH FACILITIES, INCLUDING SERVICE CONNECTIONS TO UNDERGROUND UTILITIES. PRIOR TO CONSTRUCTION, THE CONTRACTOR SHALL NOTIFY THE UTILITY COMPANIES OF HIS OPERATIONAL PLANS AND SHALL OBTAIN FROM THE RESPECTIVE UTILITY COMPANIES DETAILED INFORMATION AND ASSISTANCE RELATIVE TO THE LOCATION OF THEIR FACILITIES AND THE WORKING SCHEDULE OF THE COMPANIES FOR REMOVAL OR ADJUSTMENT WHERE REQUIRED. IN THE EVENT AN UNEXPECTED UTILITY INTERFERENCE IS ENCOUNTERED DURING CONSTRUCTION, THE CONTRACTOR SHALL IMMEDIATELY NOTIFY THE UTILITY COMPANY OF JURISDICTION. THE ENGINEER SHALL ALSO BE IMMEDIATELY NOTIFIED. ANY SUCH MAINS AND SERVICES SHALL BE RESTORED TO SERVICE AT ONCE AND PAID FOR BY THE CONTRACTOR AT NO ADDITIONAL COST TO THE CONTRACT.

CALL 911 IN THE EVENT IN WHICH DAMAGE RESULTS IN THE RELEASE OF NATURAL GAS.

CALL J.U.L.I.E.
 BEFORE EXCAVATING
 1-800-892-0123

TOWNSHIP: T. 1 N.
 RANGE: R. 1 E.
 SECTION: 16 & 21
 COUNTY: MARION
 CIVIL TOWNSHIP: CENTRALIA

JANUARY 13, 2017

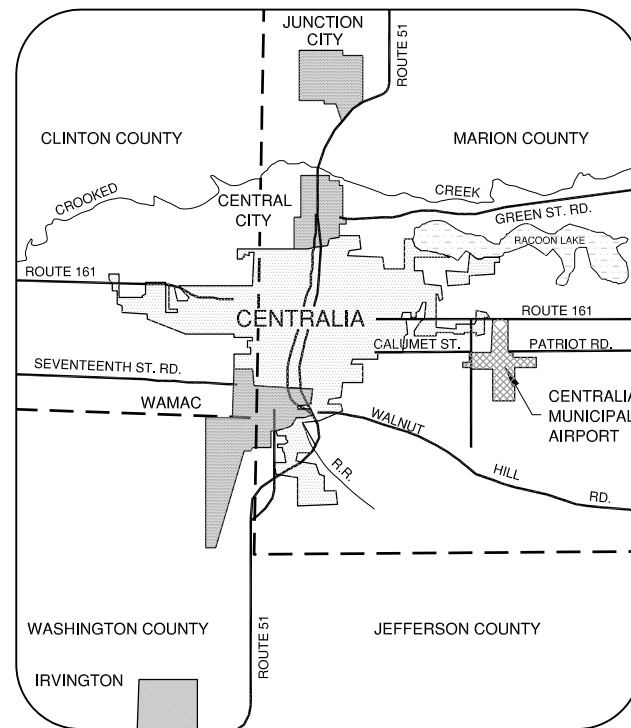

LOCATION MAP

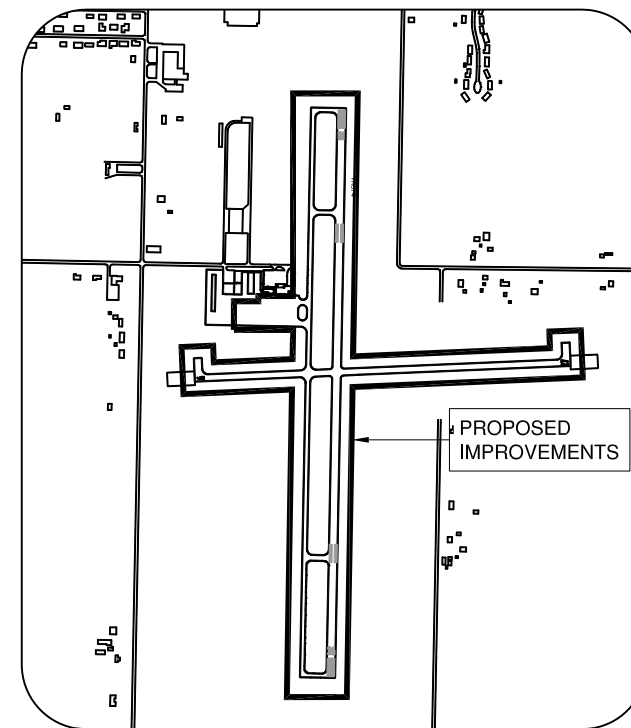

SITE PLAN

6/24/16

 RANDALL L. VOGEL
 82-048048
 REGISTERED PROFESSIONAL ENGINEER OF ILLINOIS
 EXP. 11/30/17

CENTRALIA MUNICIPAL AIRPORT
 CENTRALIA, ILLINOIS
 APPROVED: *Dan Barry*
 DATE: 6-24-2016

CMT
 License No. 184-000613 © Copyright CMT, Inc.
 SUBMITTED BY: *Alan Ward*
 DATE: 6/24/16
 CMT JOB NUMBER: 16072-01-00

K:\Centralia\16072-01\Draw\Sheets\1607201 Re-Bid Package
 FILE: 1607201-G1001.dwg
 UPDATE BY: Dave Allen
 PLOT DATE: 12/29/2016 4:19 PM



License No. 184-000613

CONSULTANTS

CE035

JANUARY 13, 2017

AIRFIELD PAVEMENT MARKING - PHASE 1

OWNER

CITY OF CENTRALIA, ILLINOIS
CENTRALIA MUNICIPAL AIRPORT
CENTRALIA, ILLINOIS

MARK DATE DESCRIPTION

SBG PROJ. NO. 3-17-SBGP-120/133

IL PROJ. NO. ENL-4498

CMT PROJECT NO: 16072-01-00

CAD DWG FILE: 1607201-GH100.DWG

DESIGNED BY: CBG

DRAWN BY: DPA

CHECKED BY: CHK

APPROVED BY: APR

COPYRIGHT: CRAWFORD, MURPHY & TILLY, INC. 2015

SHEET TITLE

AIRPORT SITE PLAN

SHEET 2 OF 18

GENERAL NOTES

- 1. ALL RUNWAYS, TAXIWAYS, AND APRON AREAS SHALL BE KEPT OPEN TO AIRCRAFT TRAFFIC EXCEPT AS NOTED IN THE CONSTRUCTION PHASING PLAN OR AS DIRECTED BY THE AIRPORT MANAGER.
2. ALL CONSTRUCTION TRAFFIC OPERATING ON, OR CROSSING, ACTIVE AIRFIELD PAVEMENTS SHALL BE UNDER RADIO CONTROL AT ALL TIMES. THE CONTRACTOR SHALL PROVIDE HIS OWN RADIOS.
3. WHEN CONFLICTS ARISE BETWEEN CONSTRUCTION ACTIVITIES AND AIRCRAFT OPERATIONS AND SAFETY, AIRCRAFT OPERATIONS AND SAFETY SHALL TAKE PRECEDENCE AND SHALL GOVERN. FINAL AUTHORITY IN THE APPROVAL OF CONSTRUCTION SEQUENCING LIES WITH THE AIRPORT MANAGER.
4. IT WILL BE NECESSARY FOR THE CONTRACTOR TO MAKE HIS OWN FIELD INVESTIGATION TO DETERMINE THE EXACT LOCATION OF THE UTILITIES, INCLUDING UNDERGROUND UTILITIES, AT CRITICAL POINTS SO AS TO AVOID ANY DAMAGE. ANY UTILITY DAMAGED BY THE CONTRACTOR SHALL BE REPAIRED BY HIM AT HIS EXPENSE IN A MANNER WHICH IS SATISFACTORY TO THE ENGINEER AND OWNER OF THE UTILITY. ANY REPAIRS THAT MUST BE MADE BY THE OWNER OF THE UTILITY SHALL HAVE THE COST REIMBURSED TO THE UTILITY BY THE CONTRACTOR.
5. THE CONTRACTOR SHALL PROVIDE LIGHTS AND FLAGGING ON ALL EQUIPMENT IN CONFORMANCE WITH FEDERAL AVIATION REGULATIONS, PART 77, OBJECTS MEETING NAVIGABLE AIRSPACE AND FAA ADVISORY CIRCULAR 5370-2 (LATEST EDITION).
6. WHEN ANY VEHICLE IS REQUIRED TO OPERATE WITHIN THE PERIMETER FENCE OR TO TRAVEL OVER ANY PORTION OF THE AIRCRAFT MOVEMENT AREA AND RUNWAY APPROACH AREA, THE VEHICLE SHALL BE PROPERLY IDENTIFIED TO OPERATE IN THE AREA:
A. DURING DAYLIGHT HOURS, MARK VEHICLES WITH A FLAG ON A STAFF ATTACHED TO THE VEHICLE SO THAT THE FLAG WILL BE READILY VISIBLE. THE FLAG SHOULD BE NOT LESS THAN 3-FOOT SQUARE CONSISTING OF A CHECKERED PATTERN OF INTERNATIONAL ORANGE AND WHITE SQUARES OF NOT LESS THAN ONE FOOT ON EACH SIDE AND DISPLAYED IN FULL VIEW ABOVE THE VEHICLE.
B. DURING NIGHTTIME OR LOW-VISIBILITY OPERATIONS, MARK VEHICLES WITH FLASHING YELLOW BEACONS.
C. MARK AND IDENTIFY VEHICLES IN ACCORDANCE WITH AC 150/5210-5, PAINTING, MARKING AND LIGHTING OF VEHICLES USED ON AN AIRPORT.
D. HAUL VEHICLES WILL NOT BE REQUIRED TO HAVE THE VEHICLE SIGNAL FLAG.
7. VEHICLES AND EQUIPMENT SHALL NOT BE ALLOWED WITHIN AREAS 65.5' FROM THE CENTERLINE OF ACTIVE TAXIWAY A, 125' FROM THE CENTERLINE OF ACTIVE RUNWAY 9/27, OR 200' FROM THE CENTERLINE OF ACTIVE RUNWAY 18/36.
8. CONTRACTOR SHALL PROVIDE HIS OWN RADIOS CAPABLE OF MONITORING UNICOM FREQUENCY 122.80 WHEN REQUIRED.
9. ALL PAVEMENTS, DRIVES OR ANY OTHER AREAS UTILIZED BY THE CONTRACTOR FOR HAUL ROADS OR STORAGE AREAS SHALL BE MAINTAINED AND REPAIRED IN KIND BY THE CONTRACTOR TO THE SATISFACTION OF THE ENGINEER AND AIRPORT MANAGER. NO ADDITIONAL COMPENSATION SHALL BE MADE TO THE CONTRACTOR FOR THIS WORK.
10. THE CONTRACTOR SHALL CONTINUOUSLY CLEAN ALL RUNWAY, TAXIWAY, APRON PAVEMENTS OR ACCESS DRIVES USED BY HIS VEHICLES AND EQUIPMENT.
11. EXISTING TURF AREAS DISTURBED BY THE CONTRACTOR'S OPERATIONS SHALL BE RESTORED BY HIM AT HIS EXPENSE TO THE SATISFACTION OF THE ENGINEER AND THE AIRPORT MANAGER.
12. CONTRACTOR'S ACCESS SHALL BE AS SHOWN IN THE PLANS.
13. THE CONTRACTOR SHALL STORE EQUIPMENT AND MATERIALS AT THE LOCATIONS SHOWN ON THE CONSTRUCTION ACTIVITY PLAN. THE MAXIMUM HEIGHT OF EQUIPMENT, MATERIALS AND STOCKPILES SHALL BE 25'. THE CONTRACTOR SHALL STORE EQUIPMENT AND MATERIALS IN SUCH A MANNER AS NOT TO VIOLATE AIRPORT PART 77 SURFACES.
14. THE CONTRACTOR SHALL PROVIDE BARRICADES AT THE LOCATIONS SHOWN IN THE PLANS. BARRICADES SHALL BE AT A 5-FOOT SPACING, WITH ONE BARRICADE ON THE CENTERLINE. BARRICADES SHALL HAVE FLAGS AND LIGHTS. THE BARRICADES SHALL BE LIGHTED WITH A FLASHING RED LIGHT AND BE MARKED WITH A 20"x20" ORANGE FLAG.
15. BROKEN OR WASTE CONCRETE AND BITUMINOUS MATERIALS SHALL BE DISPOSED OF BY THE CONTRACTOR OFF AIRPORT PROPERTY.
16. IF, DURING CONSTRUCTION, AN EMERGENCY IS DECLARED BY THE AIRPORT, THE CONTRACTOR SHALL IMMEDIATELY CLEAR THE PAVEMENT OF ALL VEHICLES, MEN AND EQUIPMENT.
17. EMERGENCY FIRE/CRASH/RESCUE VEHICLES SHALL HAVE COMPLETE ACCESS TO THE ENTIRE AIRFIELD INCLUDING THE CLOSURE AREAS.
18. ALL WORK SHALL BE IN ACCORDANCE WITH FAA ADVISORY CIRCULAR AC 150/5370-2, LATEST EDITION OPERATIONAL SAFETY ON AIRPORTS DURING CONSTRUCTION.
19. CONTRACTOR SHALL COORDINATE ALL DELIVERY VEHICLE OPERATIONS INSIDE THE AOA WITH THE AIRPORT MANAGER THROUGH THE RESIDENT ENGINEER.

LEGEND

WORK AREAS

BENCHMARK DATA

USGS BM P154 ELEV. 519.31 BRASS DISC BETWEEN TAXIWAY AND FUEL FARM

CONTRACTOR'S RESPONSIBILITY FOR UTILITY SERVICE

THE LOCATION OF UNDERGROUND UTILITIES AS INDICATED ON THE PLANS HAS BEEN OBTAINED FROM EXISTING RECORDS. NEITHER THE OWNER NOR THE ENGINEER ASSUMES ANY RESPONSIBILITY WHATEVER IN RESPECT TO THE ACCURACY, COMPLETENESS, OR SUFFICIENCY OF THE INFORMATION. THERE IS NO GUARANTEE, EITHER EXPRESSED OR IMPLIED, THAT THE LOCATIONS, SIZE AND TYPE OF MATERIAL OF EXISTING UNDERGROUND UTILITIES INDICATED ARE REPRESENTATIVE OF THOSE TO BE ENCOUNTERED IN THE CONSTRUCTION.

IT SHALL BE THE CONTRACTOR'S RESPONSIBILITY TO DETERMINE THE ACTUAL LOCATION OF ALL SUCH FACILITIES, INCLUDING SERVICE CONNECTIONS TO UNDERGROUND UTILITIES. PRIOR TO CONSTRUCTION, THE CONTRACTOR SHALL NOTIFY THE UTILITY COMPANY OF HIS OPERATIONAL PLANS. THE CONTRACTOR SHALL MAKE ARRANGEMENTS FOR DETAILED INFORMATION AND ASSISTANCE IN LOCATING UTILITIES. IN THE EVENT AN UNEXPECTED UTILITY INTERFERENCE IS ENCOUNTERED DURING CONSTRUCTION, THE CONTRACTOR SHALL IMMEDIATELY NOTIFY THE UTILITY COMPANY, THE OWNER AND THE ENGINEER. ANY SUCH MAINS AND/OR SERVICES DISTURBED BY THE CONTRACTOR'S OPERATIONS SHALL BE RESTORED IMMEDIATELY AT HIS EXPENSE TO THE SATISFACTION OF THE OWNER AND THE ENGINEER.

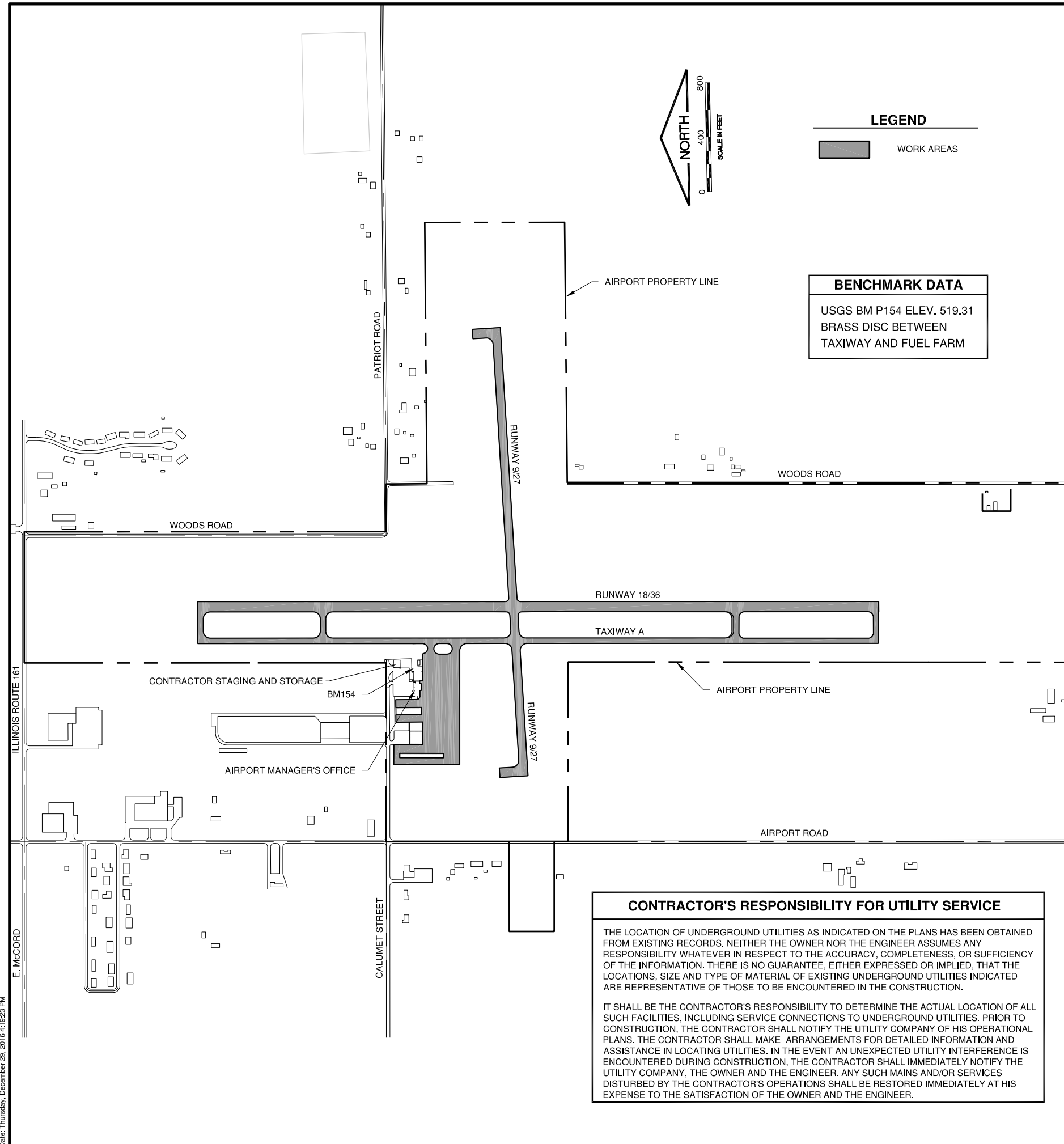

Path: K:\Centralia\16072-01\Draws\Sheets\1607201 Re-Bld Package\1607201-GH100.dwg Date: Thursday, December 29, 2016 4:19:23 PM

MARK	DATE	DESCRIPTION

SBG PROJ. NO. 3-17-SBGP-120/133
IL PROJ. NO. ENL-4498
CMT PROJECT NO: 16072-01-00
CAD DWG FILE: 1607201-GC101A.DWG
DESIGNED BY: CBG
DRAWN BY: DPA
CHECKED BY: CHK
APPROVED BY: APR
COPYRIGHT: CRAWFORD, MURPHY & TILLY, INC. 2015

SHEET TITLE
**CONSTRUCTION
ACTIVITY PLAN 1**

POINT	LATITUDE	LONGITUDE	ELEVATION	AGL	DESCRIPTION
1	N38° 31' 03.83"	W89° 05' 34.90"	521.00'	25'	STAGING AND STORAGE
2	N38° 31' 18.30"	W89° 05' 32.91"	518.00'	25'	WORK LIMITS
3	N38° 31' 18.27"	W89° 05' 29.75"	520.00'	25'	WORK LIMITS
4	N38° 31' 00.22"	W89° 05' 33.17"	522.00'	25'	WORK LIMITS
5	N38° 30' 56.58"	W89° 05' 30.07"	523.00'	25'	WORK LIMITS
6	N38° 30' 54.11"	W89° 05' 30.10"	525.00'	25'	WORK LIMITS
7	N38° 30' 53.98"	W89° 05' 33.25"	526.00'	25'	WORK LIMITS
8	N38° 30' 28.81"	W89° 05' 30.47"	534.00'	25'	WORK LIMITS
9	N38° 30' 28.87"	W89° 05' 33.61"	532.00'	25'	WORK LIMITS

	BARRICADES IDOT TYPE 1 WITH RED LIGHTS AND 20"x 20" ORANGE FLAGS AT 5' SPACING
	RUNWAY OBJECT FREE ZONE
	TAXIWAY OBJECT FREE AREA
	PHASE 1A WORK AREA
	PHASE 1B WORK AREA
	CONTRACTOR ACCESS
	RUNWAY CLOSURE MARKER

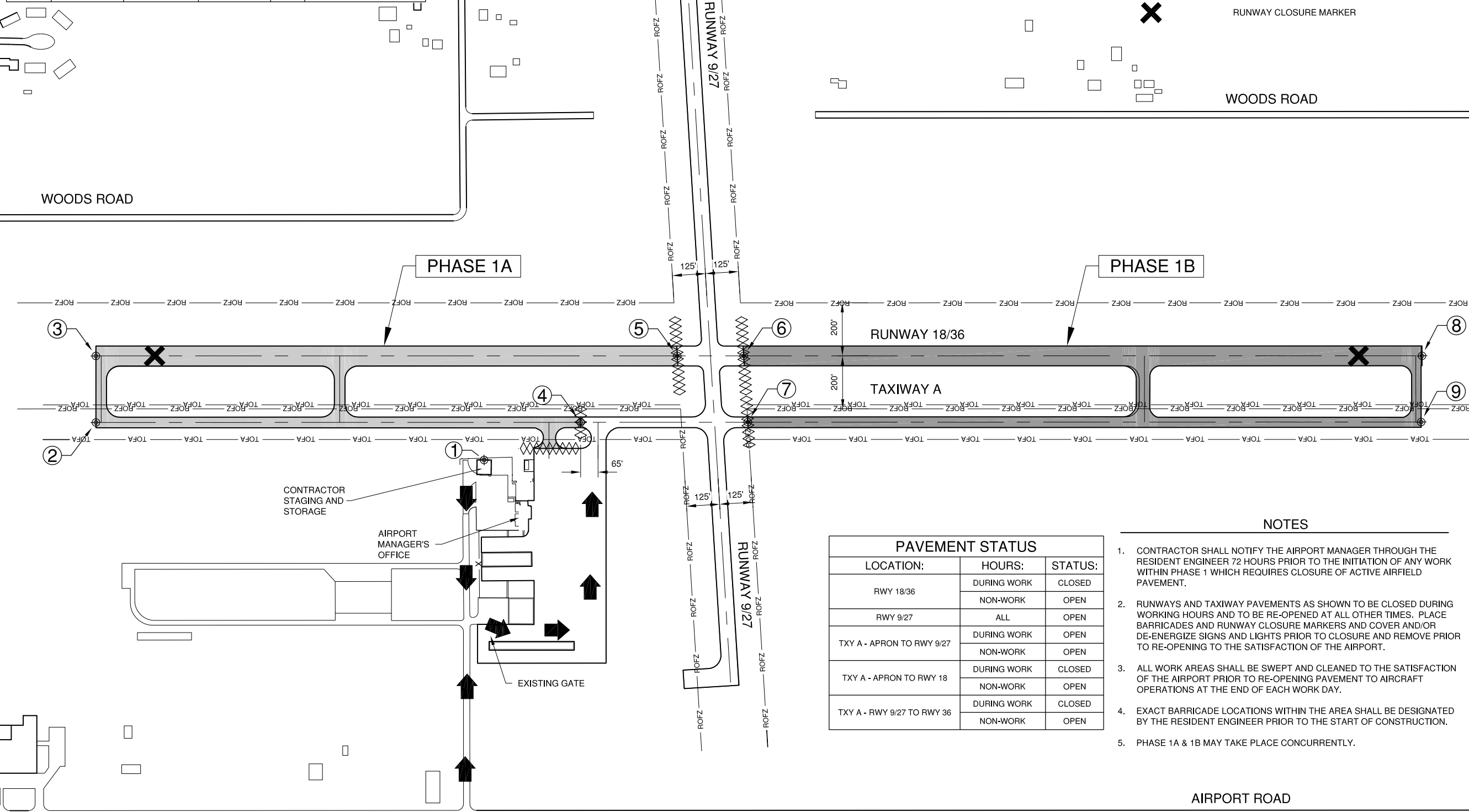
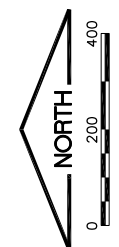

LOCATION:	HOURS:	STATUS:
RWY 18/36	DURING WORK	CLOSED
	NON-WORK	OPEN
RWY 9/27	ALL	OPEN
TXY A - APRON TO RWY 9/27	DURING WORK	OPEN
	NON-WORK	OPEN
TXY A - APRON TO RWY 18	DURING WORK	CLOSED
	NON-WORK	OPEN
TXY A - RWY 9/27 TO RWY 36	DURING WORK	CLOSED
	NON-WORK	OPEN

- NOTES**
- CONTRACTOR SHALL NOTIFY THE AIRPORT MANAGER THROUGH THE RESIDENT ENGINEER 72 HOURS PRIOR TO THE INITIATION OF ANY WORK WITHIN PHASE 1 WHICH REQUIRES CLOSURE OF ACTIVE AIRFIELD PAVEMENT.
 - RUNWAYS AND TAXIWAY PAVEMENTS AS SHOWN TO BE CLOSED DURING WORKING HOURS AND TO BE RE-OPENED AT ALL OTHER TIMES. PLACE BARRICADES AND RUNWAY CLOSURE MARKERS AND COVER AND/OR DE-ENERGIZE SIGNS AND LIGHTS PRIOR TO CLOSURE AND REMOVE PRIOR TO RE-OPENING TO THE SATISFACTION OF THE AIRPORT.
 - ALL WORK AREAS SHALL BE SWEEPED AND CLEANED TO THE SATISFACTION OF THE AIRPORT PRIOR TO RE-OPENING PAVEMENT TO AIRCRAFT OPERATIONS AT THE END OF EACH WORK DAY.
 - EXACT BARRICADE LOCATIONS WITHIN THE AREA SHALL BE DESIGNATED BY THE RESIDENT ENGINEER PRIOR TO THE START OF CONSTRUCTION.
 - PHASE 1A & 1B MAY TAKE PLACE CONCURRENTLY.

Path: K:\Centralia\16072-01\Drawings\1607201 Re-Bld Package\1607201-GC101A.dwg
Date: Thursday, December 29, 2016 4:19:52 PM

CRITICAL POINT TABLE					
POINT	LATITUDE	LONGITUDE	ELEVATION	AGL	DESCRIPTION
1	N38° 31' 00.22"	W89° 05' 33.17"	522.00'	25'	WORK LIMITS
2	N38° 30' 55.18"	W89° 05' 34.31"	524.00'	25'	WORK LIMITS
3	N38° 30' 53.98"	W89° 05' 33.26"	526.00'	25'	WORK LIMITS
4	N38° 30' 53.91"	W89° 05' 30.11"	525.00'	25'	WORK LIMITS
5	N38° 30' 56.78"	W89° 05' 30.06"	523.00'	25'	WORK LIMITS
6	N38° 30' 55.45"	W89° 05' 27.57"	523.00'	25'	WORK LIMITS
7	N38° 30' 55.25"	W89° 05' 32.60"	523.00'	25'	WORK LIMITS
8	N38° 30' 39.83"	W89° 05' 33.46"	527.00'	25'	WORK LIMITS

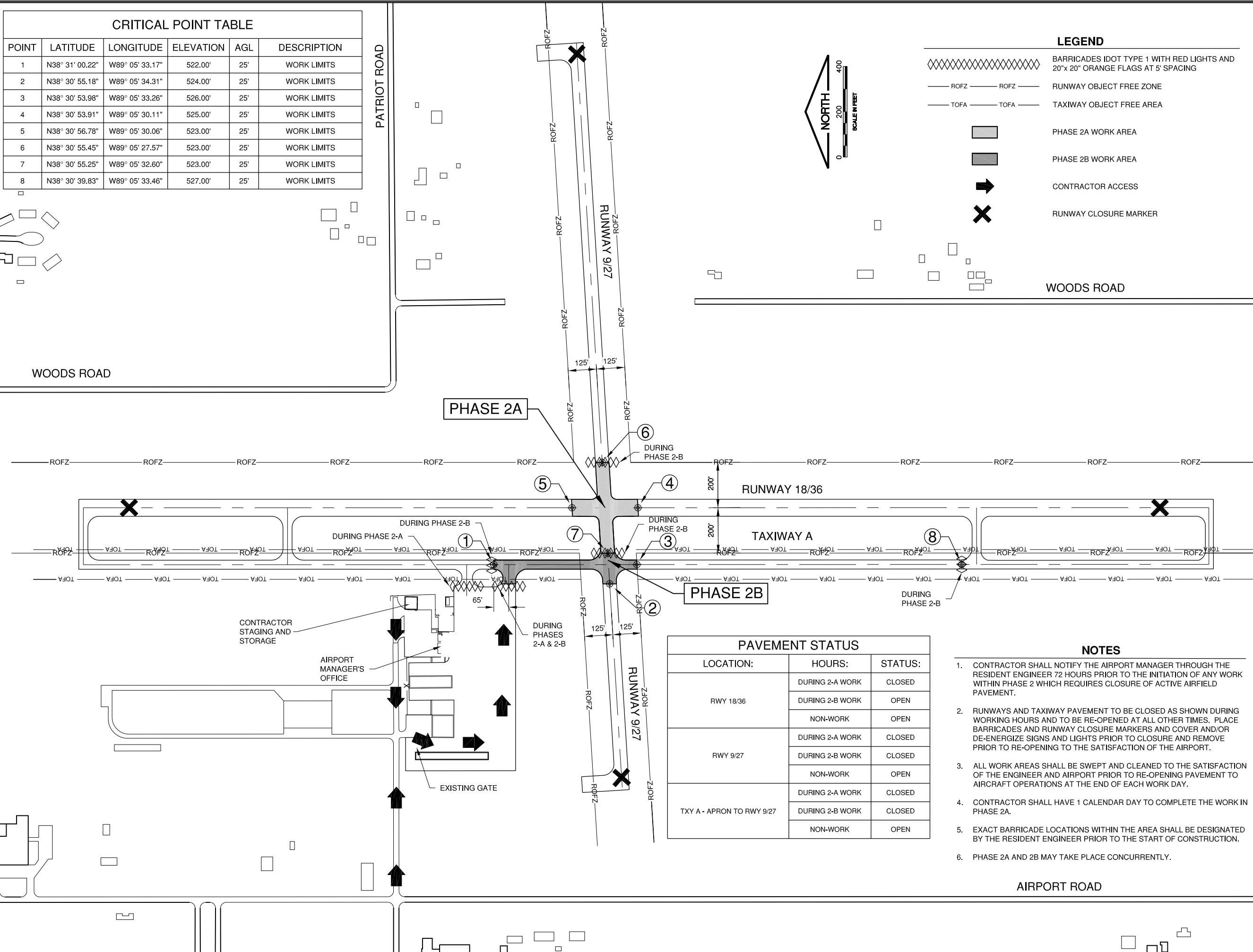

LEGEND	
	BARRICADES IDOT TYPE 1 WITH RED LIGHTS AND 20"x 20" ORANGE FLAGS AT 5' SPACING
	RUNWAY OBJECT FREE ZONE
	TAXIWAY OBJECT FREE AREA
	PHASE 2A WORK AREA
	PHASE 2B WORK AREA
	CONTRACTOR ACCESS
	RUNWAY CLOSURE MARKER

PAVEMENT STATUS		
LOCATION:	HOURS:	STATUS:
RWY 18/36	DURING 2-A WORK	CLOSED
	DURING 2-B WORK	OPEN
	NON-WORK	OPEN
RWY 9/27	DURING 2-A WORK	CLOSED
	DURING 2-B WORK	CLOSED
	NON-WORK	OPEN
TXY A - APRON TO RWY 9/27	DURING 2-A WORK	CLOSED
	DURING 2-B WORK	CLOSED
	NON-WORK	OPEN





- NOTES**
- CONTRACTOR SHALL NOTIFY THE AIRPORT MANAGER THROUGH THE RESIDENT ENGINEER 72 HOURS PRIOR TO THE INITIATION OF ANY WORK WITHIN PHASE 2 WHICH REQUIRES CLOSURE OF ACTIVE AIRFIELD PAVEMENT.
 - RUNWAYS AND TAXIWAY PAVEMENT TO BE CLOSED AS SHOWN DURING WORKING HOURS AND TO BE RE-OPENED AT ALL OTHER TIMES. PLACE BARRICADES AND RUNWAY CLOSURE MARKERS AND COVER AND/OR DE-ENERGIZE SIGNS AND LIGHTS PRIOR TO CLOSURE AND REMOVE PRIOR TO RE-OPENING TO THE SATISFACTION OF THE AIRPORT.
 - ALL WORK AREAS SHALL BE SWEEPED AND CLEANED TO THE SATISFACTION OF THE ENGINEER AND AIRPORT PRIOR TO RE-OPENING PAVEMENT TO AIRCRAFT OPERATIONS AT THE END OF EACH WORK DAY.
 - CONTRACTOR SHALL HAVE 1 CALENDAR DAY TO COMPLETE THE WORK IN PHASE 2A.
 - EXACT BARRICADE LOCATIONS WITHIN THE AREA SHALL BE DESIGNATED BY THE RESIDENT ENGINEER PRIOR TO THE START OF CONSTRUCTION.
 - PHASE 2A AND 2B MAY TAKE PLACE CONCURRENTLY.

 Path: K:\Centralia\16072-01\Drawings\1607201 Re-Bld Package\1607201-GC102A.dwg
 Date: Thursday, December 29, 2016 4:20:20 PM

CRITICAL POINT TABLE

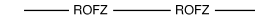
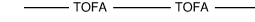
POINT	LATITUDE	LONGITUDE	ELEVATION	AGL	DESCRIPTION
1	N38° 30' 56.48"	W89° 05' 45.43"	523.00'	25'	WORK LIMITS
2	N38° 30' 54.73"	W89° 05' 45.76"	523.00'	25'	WORK LIMITS
3	N38° 30' 55.18"	W89° 05' 34.31"	524.00'	25'	WORK LIMITS
4	N38° 30' 55.46"	W89° 05' 27.31"	523.00'	25'	WORK LIMITS
5	N38° 30' 56.36"	W89° 05' 04.29"	522.00'	25'	WORK LIMITS
6	N38° 30' 58.08"	W89° 05' 04.87"	521.00'	25'	WORK LIMITS

LEGEND

-  BARRICADES IDOT TYPE 1 WITH RED LIGHTS AND 20"x 20" ORANGE FLAGS AT 5' SPACING
-  RUNWAY OBJECT FREE ZONE
-  TAXIWAY OBJECT FREE AREA
-  PHASE 3A WORK AREA
-  PHASE 3B WORK AREA
-  CONTRACTOR ACCESS
-  RUNWAY CLOSURE MARKER

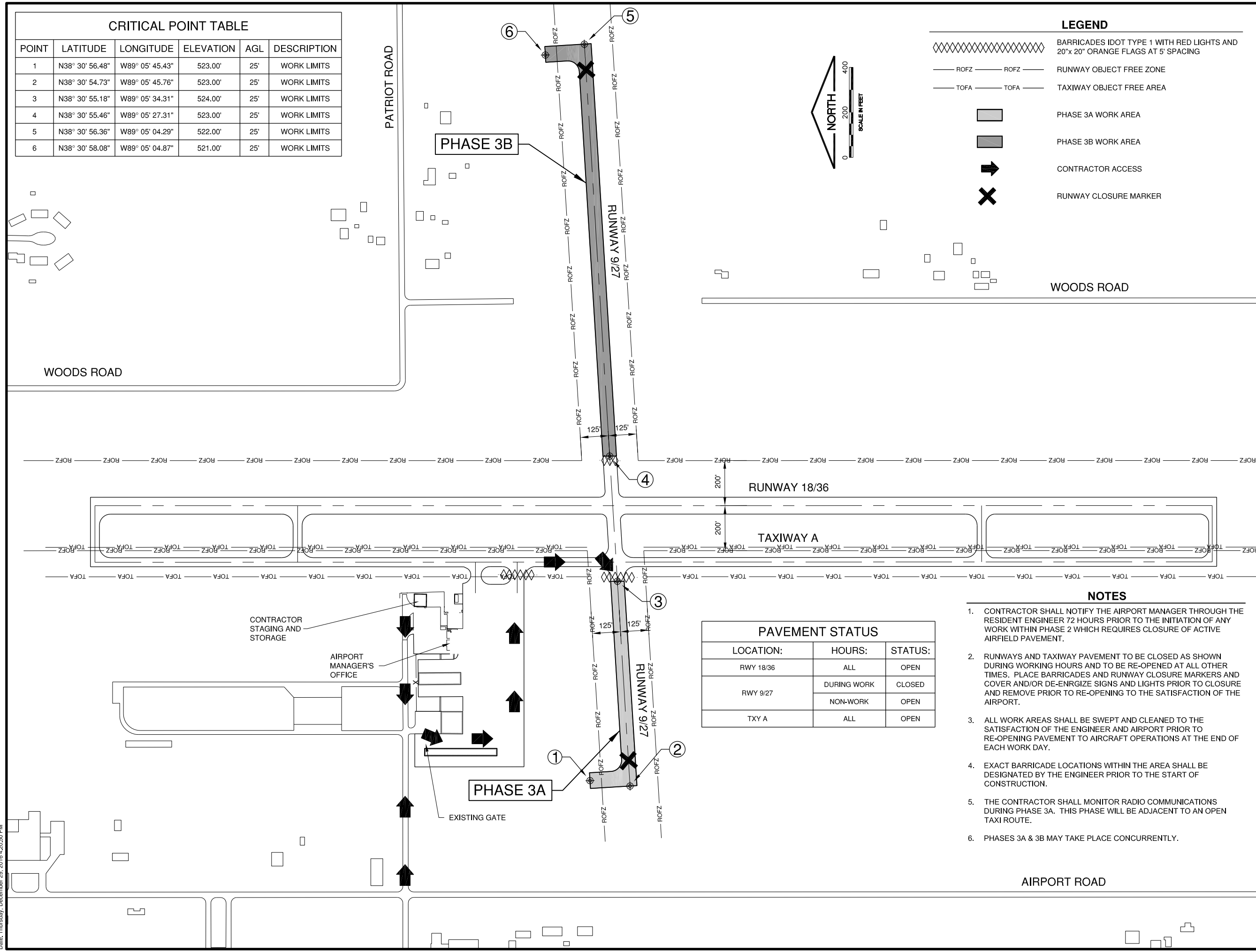
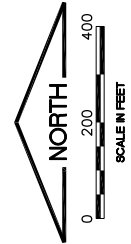

PAVEMENT STATUS

LOCATION:	HOURS:	STATUS:
RWY 18/36	ALL	OPEN
RWY 9/27	DURING WORK	CLOSED
	NON-WORK	OPEN
TXY A	ALL	OPEN

NOTES

- CONTRACTOR SHALL NOTIFY THE AIRPORT MANAGER THROUGH THE RESIDENT ENGINEER 72 HOURS PRIOR TO THE INITIATION OF ANY WORK WITHIN PHASE 2 WHICH REQUIRES CLOSURE OF ACTIVE AIRFIELD PAVEMENT.
- RUNWAYS AND TAXIWAY PAVEMENT TO BE CLOSED AS SHOWN DURING WORKING HOURS AND TO BE RE-OPENED AT ALL OTHER TIMES. PLACE BARRICADES AND RUNWAY CLOSURE MARKERS AND COVER AND/OR DE-ENRGIZE SIGNS AND LIGHTS PRIOR TO CLOSURE AND REMOVE PRIOR TO RE-OPENING TO THE SATISFACTION OF THE AIRPORT.
- ALL WORK AREAS SHALL BE SWEEPED AND CLEANED TO THE SATISFACTION OF THE ENGINEER AND AIRPORT PRIOR TO RE-OPENING PAVEMENT TO AIRCRAFT OPERATIONS AT THE END OF EACH WORK DAY.
- EXACT BARRICADE LOCATIONS WITHIN THE AREA SHALL BE DESIGNATED BY THE ENGINEER PRIOR TO THE START OF CONSTRUCTION.
- THE CONTRACTOR SHALL MONITOR RADIO COMMUNICATIONS DURING PHASE 3A. THIS PHASE WILL BE ADJACENT TO AN OPEN TAXI ROUTE.
- PHASES 3A & 3B MAY TAKE PLACE CONCURRENTLY.



License No. 184-000613
CONSULTANTS

CE035

JANUARY 13, 2017

AIRFIELD PAVEMENT MARKING - PHASE 1

OWNER

CITY OF CENTRALIA, ILLINOIS
CENTRALIA MUNICIPAL AIRPORT
CENTRALIA, ILLINOIS

MARK	DATE	DESCRIPTION

SBG PROJ. NO. 3-17-SBGP-120/133
IL PROJ. NO. ENL-4498
CMT PROJECT NO: 16072-01-00
CAD DWG FILE: 1607201-GC103A.DWG
DESIGNED BY: CBG
DRAWN BY: DPA
CHECKED BY: CHK
APPROVED BY: APR
COPYRIGHT: CRAWFORD, MURPHY & TILLY, INC. 2015

CONSTRUCTION ACTIVITY PLAN 3

Path: K:\Centralia\16072-01\Drawings\1607201 Re-Bld Package\1607201-GC103A.dwg
Date: Thursday, December 29, 2016 4:20:50 PM

CRITICAL POINT TABLE

POINT	LATITUDE	LONGITUDE	ELEVATION	AGL	DESCRIPTION
1	N38° 31' 01.74"	W89° 05' 34.21"	522.00'	25'	WORK LIMITS
2	N38° 30' 59.28"	W89° 05' 34.25"	524.00'	25'	WORK LIMITS
3	N38° 30' 59.37"	W89° 05' 44.62"	521.00'	25'	WORK LIMITS



License No. 184-000613
CONSULTANTS

CE035

JANUARY 13, 2017

AIRFIELD PAVEMENT MARKING - PHASE 1

OWNER

CITY OF CENTRALIA, ILLINOIS
CENTRALIA MUNICIPAL AIRPORT
CENTRALIA, ILLINOIS

MARK	DATE	DESCRIPTION

SBG PROJ. NO. 3-17-SBGP-120/133
IL PROJ. NO. ENL-4498
CMT PROJECT NO: 16072-01-00
CAD DWG FILE: 1607201-GC104A.DWG
DESIGNED BY: CBG
DRAWN BY: DPA
CHECKED BY: CHK
APPROVED BY: APR
COPYRIGHT: CRAWFORD, MURPHY & TILLY, INC. 2015

CONSTRUCTION ACTIVITY PLAN 4

LEGEND

- BARRICADES IDOT TYPE 1 WITH RED LIGHTS AND 20'x 20' ORANGE FLAGS AT 5' SPACING
- ROFZ — ROFZ — RUNWAY OBJECT FREE ZONE
- TOFA — TOFA — TAXIWAY OBJECT FREE AREA
- PHASE 4A WORK AREA
- PHASE 4B WORK AREA
- CONTRACTOR ACCESS
- RUNWAY CLOSURE MARKER

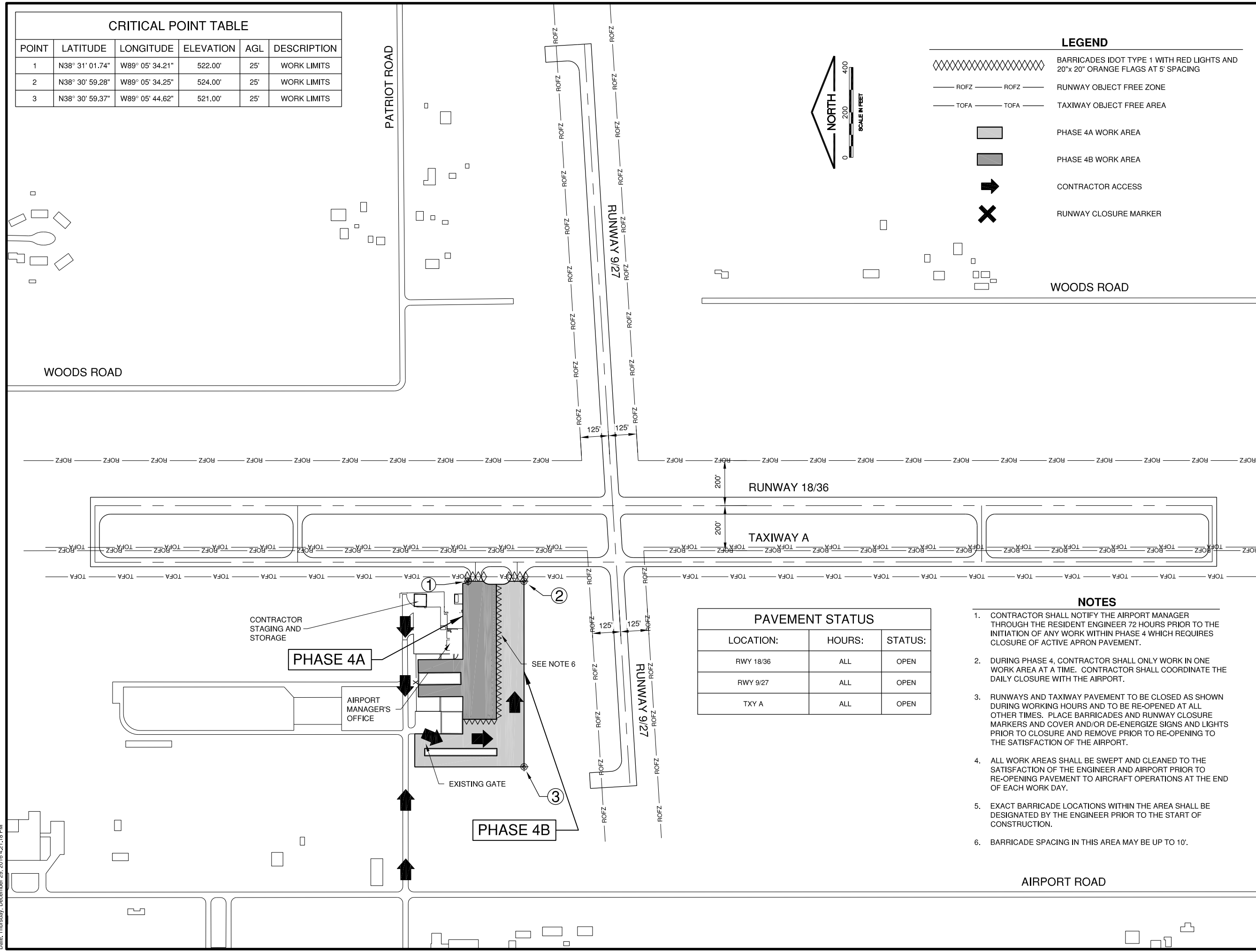
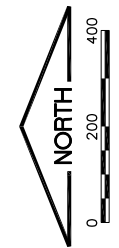

PAVEMENT STATUS

LOCATION:	HOURS:	STATUS:
RWY 18/36	ALL	OPEN
RWY 9/27	ALL	OPEN
TXY A	ALL	OPEN

NOTES

- CONTRACTOR SHALL NOTIFY THE AIRPORT MANAGER THROUGH THE RESIDENT ENGINEER 72 HOURS PRIOR TO THE INITIATION OF ANY WORK WITHIN PHASE 4 WHICH REQUIRES CLOSURE OF ACTIVE APRON PAVEMENT.
- DURING PHASE 4, CONTRACTOR SHALL ONLY WORK IN ONE WORK AREA AT A TIME. CONTRACTOR SHALL COORDINATE THE DAILY CLOSURE WITH THE AIRPORT.
- RUNWAYS AND TAXIWAY PAVEMENT TO BE CLOSED AS SHOWN DURING WORKING HOURS AND TO BE RE-OPENED AT ALL OTHER TIMES. PLACE BARRICADES AND RUNWAY CLOSURE MARKERS AND COVER AND/OR DE-ENERGIZE SIGNS AND LIGHTS PRIOR TO CLOSURE AND REMOVE PRIOR TO RE-OPENING TO THE SATISFACTION OF THE AIRPORT.
- ALL WORK AREAS SHALL BE SWEEPED AND CLEANED TO THE SATISFACTION OF THE ENGINEER AND AIRPORT PRIOR TO RE-OPENING PAVEMENT TO AIRCRAFT OPERATIONS AT THE END OF EACH WORK DAY.
- EXACT BARRICADE LOCATIONS WITHIN THE AREA SHALL BE DESIGNATED BY THE ENGINEER PRIOR TO THE START OF CONSTRUCTION.
- BARRICADE SPACING IN THIS AREA MAY BE UP TO 10'.

Path: K:\Centralia\16072-01\Draws\Sheets\1607201 Re-Bld Package\1607201-GC104A.dwg
Date: Thursday, December 29, 2016 4:21:18 PM

GENERAL

- 1. THE CONTRACTOR AND ALL SUBCONTRACTORS SHALL FOLLOW THE REQUIREMENTS OF THE AIRPORT'S APPROVED CONSTRUCTION SAFETY AND PHASING PLAN (CSPP), FAA AC 150/5370-2 (LATEST EDITION) AND ALL AIRPORT SAFETY AND SECURITY REQUIREMENTS.
- 2. PRIOR TO THE ISSUANCE OF THE NOTICE TO PROCEED (NTP) AND THE START OF CONSTRUCTION, THE CONTRACTOR SHALL SUBMIT TO THE AIRPORT (THROUGH THE ENGINEER) FOR APPROVAL A SAFETY PLAN COMPLIANCE DOCUMENT (SPCD) IN ACCORDANCE WITH FAA AC 150/5370-2F. AIRPORT APPROVAL OF THE SPCD SHALL BE REQUIRED PRIOR TO ISSUANCE OF THE NOTICE TO PROCEED AND THE START OF CONSTRUCTION ACTIVITY.
- 3.
- 4. THE CSPP COVERS OPERATIONAL SAFETY. THE CONTRACTOR SHALL BE RESPONSIBLE FOR THE INDIVIDUAL SAFETY OF HIS/HER PERSONNEL.
- 5. A MINIMUM OF 10 DAYS PRIOR TO THE NOTICE TO PROCEED, THE CONTRACTOR SHALL PROVIDE A LIST OF SUBCONTRACTORS AND MATERIAL SUPPLIERS.
- 6. PRIOR TO THE START OF CONSTRUCTION THE CONTRACTOR SHALL SIGN THE SWPPP CERTIFICATION STATEMENT, IF APPLICABLE.
- 7. ALL CONTRACTOR COSTS ASSOCIATED WITH THE REQUIREMENTS LISTED ON THIS SHEET SHALL BE CONSIDERED INCIDENTAL TO THE CONTRACT UNLESS A SPECIFIC PAY ITEM IS PROVIDED.

A. COORDINATION

- 1. PRIOR TO THE START OF CONSTRUCTION THE CONTRACTOR SHALL ATTEND A PRECONSTRUCTION CONFERENCE WITH THE AIRPORT, RESIDENT ENGINEER, AND ILLINOIS DIVISION OF AERONAUTICS (IDA). THE COST OF PREPARING FOR AND ATTENDING THE PRECONSTRUCTION CONFERENCE SHALL BE INCIDENTAL TO THE CONTRACT.
- 2. DURING OR BEFORE THE PRECONSTRUCTION CONFERENCE, THE CONTRACTOR SHALL SUBMIT A PROPOSED SCHEDULE FOR THE PROJECT. THE SCHEDULE SHALL INCLUDE A START AND COMPLETION DATE FOR EACH ITEM OF WORK. THE SCHEDULE SHALL BE UPDATED ON A WEEKLY BASIS. ALL COSTS ASSOCIATED WITH THE SCHEDULE SHALL BE INCIDENTAL TO THE CONTRACT.
- 3. DURING CONSTRUCTION THE CONTRACTOR SHALL ATTEND A WEEKLY COORDINATION MEETING WITH THE AIRPORT STAFF AND RESIDENT ENGINEER. ALL COSTS ASSOCIATED WITH ATTENDING THE WEEKLY MEETING SHALL BE INCIDENTAL TO THE CONTRACT.

B. PHASING

- 1. PHASING SHALL BE AS NOTED BELOW AND AS SHOWN ON THE CONSTRUCTION ACTIVITY PLAN (CAP) SHEETS.

C. AREAS AND OPERATIONS AFFECTED BY THE CONSTRUCTION ACTIVITY

- 1. ALL RUNWAYS, TAXIWAYS AND APRONS SHALL BE KEPT OPEN TO AIRCRAFT TRAFFIC DURING CONSTRUCTION EXCEPT AS NOTED ON THE PHASING PLAN.
- 2. WHEN CONFLICTS ARISE BETWEEN CONSTRUCTION ACTIVITIES AND AIRCRAFT OPERATIONS AND SAFETY, AIRCRAFT OPERATIONS AND SAFETY SHALL TAKE PRECEDENCE AND SHALL GOVERN. FINAL AUTHORITY IN THE APPROVAL OF CONSTRUCTION SEQUENCING LIES WITH THE AIRPORT.
- 3. ALL CONSTRUCTION TRAFFIC SHALL IMMEDIATELY YIELD TO ONCOMING AIRCRAFT AT ALL TIMES.

D. CONTRACTOR ACCESS

- 1. CONTRACTOR ACCESS SHALL BE AS NOTED BELOW AND AS SHOWN ON THE SITE PLAN AND CONSTRUCTION ACTIVITY PLAN SHEETS.
- 2. THE CONTRACTOR IS TO ACCESS THE SITE USING THE GATES SHOWN.
- 3. CONTRACTOR EMPLOYEES MAY BE REQUIRED TO OBTAIN AN AIRPORT IDENTIFICATION BADGE. THIS CONSISTS OF FILLING OUT ALL NECESSARY PAPERWORK, FINGERPRINTING, ATTENDING AND PASSING A TRAINING CLASS CONCERNING SAFETY AND SECURITY AT THE AIRPORT. CONTRACTOR EMPLOYEES MUST MEET CERTAIN BACKGROUND CHECK CRITERIA AND THE CONTRACTOR MUST MAKE CERTAIN CERTIFICATIONS ABOUT EACH EMPLOYEE. ALL COSTS ASSOCIATED WITH OBTAINING THE IDENTIFICATION BADGE SHALL BE BORNE BY THE CONTRACTOR.
- 4. DRIVERS OF TRUCKS CONTAINING MATERIAL DELIVERIES (AGGREGATE, ASPHALT, ETC.) NEED NOT OBTAIN AN AIRPORT ID BADGE BUT SHALL BE REQUIRED TO SUBMIT THEIR NAME, DRIVER'S LICENSE NUMBER, TRUCK LICENSE PLATE NUMBER AND NAME OF TRUCKING COMPANY TO THE PRIME CONTRACTOR PRIOR TO ENTERING THE JOBSITE.
- 5. CONTRACTOR WORK CREWS MUST MONITOR THE UNICOM FREQUENCY AT ALL TIMES. THE CONTRACTOR SHALL SUPPLY ALL APPROPRIATE RADIOS NEEDED FOR COMMUNICATIONS. BE AWARE OF TENANT AIRCRAFT MOVEMENT NEAR THE WORK AREAS.
- 6. THE CONTRACTOR SHALL KEEP A RECORD OF THE NAMES OF ALL EMPLOYEES ENTERING THE JOB SITE ON A DAILY BASIS. A RECORD OF EACH SUBCONTRACTOR ENTERING THE JOB SITE SHALL ALSO BE KEPT BY THE CONTRACTOR.
- 7. WHEN THE CONTRACTOR IS NOT WORKING, EQUIPMENT SHALL BE STORED AT THE STAGING AREA.
- 8. THE CONTRACTOR WILL BE PERMITTED TO STORE EQUIPMENT AND MATERIALS ONLY AT THE LOCATIONS SHOWN IN THE CONSTRUCTION ACTIVITY PLAN. PARKED EQUIPMENT AND MATERIAL STOCKPILES SHALL NOT PENETRATE SURFACES DEFINED BY F.A.R. TITLE 14 PART 77 - OBJECTS AFFECTING NAVIGABLE AIRSPACE.
- 9. THE CONTRACTOR SHALL THOROUGHLY CLEAN ALL CONSTRUCTION AREAS AND HAUL ROUTES WHICH WILL BE OPENED TO AIR TRAFFIC TO THE SATISFACTION OF THE AIRPORT. A POWER BROOM AND OPERATOR SHALL BE ON SITE AT ALL TIMES WHEN ACTIVE PAVEMENTS ARE UTILIZED FOR CONSTRUCTION TRAFFIC.
- 10. ALL PAVEMENTS, DRIVES OR ANY OTHER AREAS UTILIZED BY THE CONTRACTOR FOR HAUL ROADS OR STORAGE AREAS SHALL BE MAINTAINED AND REPAIRED TO THE SAME CONDITION OR BETTER THAN THEY WERE PRIOR TO BEGINNING CONSTRUCTION. NO ADDITIONAL COMPENSATION WILL BE MADE TO THE CONTRACTOR FOR THIS WORK.
- 11. ALL VEHICLE AND EQUIPMENT OPERATORS USED BY THE CONTRACTOR SHALL BE PROPERLY TRAINED BY THE CONTRACTOR.

E. WILDLIFE MANAGEMENT

- 1. THE CONTRACTOR SHALL NOTIFY AIRPORT OR THE RESIDENT ENGINEER IF ANY WILDLIFE IS SEEN ENTERING THE AIRPORT.
- 2. CONTRACTOR ACCESS GATES SHALL REMAIN CLOSED WHEN THE CONTRACTOR IS NOT WORKING.
- 3. THE CONTRACTOR SHALL DISPOSE OF ALL TRASH INCLUDING FOOD SCRAPS IN APPROVED CONTRACTOR PROVIDED CONTAINERS.

F. FOREIGN OBJECT DEBRIS (FOD) MANAGEMENT

- 1. THE CONTRACTOR SHALL PICK UP ANY FOREIGN OBJECT DEBRIS (FOD) SEEN ON THE AIRFIELD PAVEMENTS.
- 2. THE CONTRACTOR SHALL SECURE ALL LOOSE ITEMS FROM VEHICLES PRIOR TO DRIVING ON AIRFIELD PAVEMENTS.

G. HAZARDOUS MATERIALS (HAZMAT) MANAGEMENT

- 1. THE CONTRACTOR SHALL DEVELOP A HAZMAT MANAGEMENT PLAN AND KEEP COPIES ON THE JOBSITE OF MATERIAL SAFETY DATA SHEETS (MSDS) FOR ALL MATERIALS HANDLED ON THE JOBSITE.

H. NOTIFICATION OF CONSTRUCTION ACTIVITIES

- 1. THE CONTRACTOR SHALL PROVIDE A 24 HOUR EMERGENCY CONTACT PERSON AND PHONE NUMBER.
- 2. THE CONTRACTOR SHALL GIVE A MINIMUM OF 72 HOURS NOTICE TO AIRPORT OPERATIONS PRIOR TO CLOSING ANY PAVEMENTS SO THAT PROPER NOTAMS MAY BE ISSUED BY THE AIRPORT.
- 3. THE CONTRACTOR SHALL NOTIFY THE AIRPORT 7 DAYS BEFORE STARTING WORK IN EACH PHASE. THIS WILL ENSURE THAT THE AIRPORT CAN CONTACT TENANTS ABOUT MOVING AIRCRAFT DURING THE TIME OF CONSTRUCTION.
- 4. FOR ANY EQUIPMENT USED BY THE CONTRACTOR WITH A HEIGHT GREATER THAN 25', THE CONTRACTOR SHALL PROVIDE TO THE AIRPORT THE TYPE OF EQUIPMENT, TOTAL HEIGHT, AND LOCATION WHERE THE EQUIPMENT WILL BE USED. THE AIRPORT WILL SUBMIT FAA FORM 7460-1 TO THE FAA FOR AN AIRSPACE STUDY. NO EQUIPMENT WITH A HEIGHT GREATER THAN 25' SHALL BE USED UNTIL A DETERMINATION FROM FAA IS RECEIVED.
- 5. IN THE EVENT OF AN EMERGENCY, THE CONTRACTOR SHALL CALL 911.
- 6. CONTACTS FOR THIS PROJECT WILL BE DISCUSSED AT THE PRE-CONSTRUCTION MEETING.

I. INSPECTION REQUIREMENTS

- 1. THE CONTRACTOR SHALL INSPECT THE JOBSITE DAILY TO ENSURE COMPLIANCE WITH THE CSPP. THE CHECKLIST FOUND IN APPENDIX 3 OF FAA AC 150/5370-2F MAY BE USED TO AID IN THE INSPECTIONS.
- 2. THE CONTRACTOR AND AIRPORT SHALL ATTEND AN INSPECTION OF EACH PHASE WORK AREA PRIOR TO OPENING THE AREA TO AIRPORT OPERATIONS.

J. UNDERGROUND UTILITIES

- 1. IT WILL BE NECESSARY FOR THE CONTRACTOR TO MAKE HIS OWN FIELD INVESTIGATION TO DETERMINE THE EXACT LOCATION OF THE UNDERGROUND UTILITIES AT CRITICAL POINTS. THE LOCATION OF UNDERGROUND UTILITIES AS INDICATED ON THE PLANS HAS BEEN OBTAINED FROM EXISTING RECORDS. NEITHER THE OWNER NOR THE ENGINEER ASSUMES ANY RESPONSIBILITY IN RESPECT TO THE ACCURACY, COMPLETENESS OR SUFFICIENCY OF THE INFORMATION.
- 2. BEFORE INITIATING ANY DIGGING, DRILLING OR EXCAVATING ON THE AIRPORT PROPERTY, THE CONTRACTOR SHALL CALL J.U.L.I.E. AND CONTACT THE LOCAL FAA OFFICE TO ARRANGE FOR UTILITY LOCATES. SEE SECTION 70-17 OF THE SPECIAL PROVISIONS FOR UTILITY CONTACT INFORMATION.

K. PENALTIES

- 1. NONCOMPLIANCE BY THE CONTRACTOR WITH AIRPORT RULES AND REGULATIONS OR FAILURE TO COMPLY WITH THE AIRPORT'S APPROVED CSPP AND THE CONTRACTOR'S APPROVED SPCD MAY RESULT IN FINES AS ALLOWED BY LAW.

L. SPECIAL CONDITIONS

- 1. ADJACENT CONSTRUCTION MAY IMPACT THE OPERATIONS OF THE CONTRACTOR. SEE THE COORDINATION NOTES FOR ADDITIONAL INFORMATION.

M. HAZARD MARKING AND LIGHTING

- 1. THE CONTRACTOR SHALL FURNISH, ERECT, AND MAINTAIN MARKINGS AND ASSOCIATED LIGHTING OF OPEN TRENCHES, EXCAVATIONS, TEMPORARY STOCKPILES, AND HIS/HER CONSTRUCTION EQUIPMENT.
- 2. ALL CONSTRUCTION EQUIPMENT SHALL BE FLAGGED AND/OR LIGHTED IN ACCORDANCE WITH FAA ADVISORY CIRCULAR 150/5370-2F AND 150/5210-5C AT ALL TIMES WHILE OPERATING ON AIRPORT PROPERTY. THE MAXIMUM EQUIPMENT HEIGHT IS 25'.
- 3. BARRICADES SHALL BE PLACED AT THE LOCATIONS SHOWN ON THE CONSTRUCTION ACTIVITY PLAN SHEET OR AS DIRECTED BY THE RESIDENT ENGINEER.
- 4. THE CONTRACTOR SHALL INSPECT THE BARRICADES ONCE DURING EACH WORK DAY TO INSURE PROPER PLACEMENT AND PROPER OPERATION OF THE RED LIGHTS AND FLAG PLACEMENT.

N. PROTECTION

- 1. ALL WORK REQUIRED ON AN ACTIVE RUNWAY OR INSIDE OF AN ACTIVE RUNWAY OBJECT FREE ZONE (ROFZ), WHICH EXTENDS 125' FROM THE RUNWAY 9/27 CENTERLINE, OR 200' FROM THE RUNWAY 18/36 CENTERLINE WILL REQUIRE THE RUNWAY TO BE CLOSED.
- 2. ALL WORK REQUIRED ON AN ACTIVE TAXIWAY OR INSIDE OF AN ACTIVE TAXIWAY OBJECT FREE AREA (TOFA), WHICH EXTENDS 65.5' FROM THE TAXIWAY CENTERLINE, WILL REQUIRE THE TAXIWAY TO BE CLOSED.
- 3. THE CONTRACTOR SHALL COORDINATE WITH THE AIRPORT A MINIMUM OF 72 HOURS PRIOR TO THE REQUESTED CLOSURE TIME.

O. OTHER LIMITATIONS ON CONSTRUCTION

- 1. IF DURING CONSTRUCTION, AN EMERGENCY IS DECLARED BY THE AIRPORT, THE CONTRACTOR SHALL IMMEDIATELY CLEAR THE PAVEMENT OF ALL VEHICLES, PERSONNEL AND EQUIPMENT.
- 2. BROKEN CONCRETE, BROKEN ASPHALT, AND OTHER MISCELLANEOUS DEBRIS SHALL BE DISPOSED OF OFF AIRPORT PROPERTY, UNLESS OTHERWISE SPECIFIED.



License No. 184-000613
CONSULTANTS

CE035

JANUARY 13, 2017

AIRFIELD PAVEMENT MARKING -
PHASE 1

OWNER

CITY OF CENTRALIA, ILLINOIS
CENTRALIA MUNICIPAL AIRPORT
CENTRALIA, ILLINOIS

MARK | DATE | DESCRIPTION

SBG PROJ. NO. 3-17-SBGP-120/133
IL PROJ. NO. ENL-4498
CMT PROJECT NO: 16072-01-00
CAD DWG FILE: 1607201-GC501.DWG
DESIGNED BY: CBG
DRAWN BY: DPA
CHECKED BY: CHK
APPROVED BY: APR
COPYRIGHT: CRAWFORD, MURPHY & TILLY, INC. 2015

SHEET TITLE
**CONSTRUCTION
ACTIVITY PLAN
NOTES & DETAILS 1**

MARK	DATE	DESCRIPTION

SBG PROJ. NO. 3-17-SBGP-120/133
IL PROJ. NO. ENL-4498
CMT PROJECT NO: 16072-01-00
CAD DWG FILE: 1607201-GC502.DWG
DESIGNED BY: CBG
DRAWN BY: DPA
CHECKED BY: CHK
APPROVED BY: APR
COPYRIGHT: CRAWFORD, MURPHY & TILLY, INC. 2015

SHEET TITLE
**CONSTRUCTION
ACTIVITY PLAN
NOTES & DETAILS 2**

SECURITY NOTES

1. MAINTAINING THE SECURITY REQUIREMENTS OF THE AIRPORT SHALL BE A PRIMARY CONCERN FOR THE CONTRACTOR.
2. THE CONTRACTOR WILL BE RESPONSIBLE FOR MAINTAINING AIRPORT SECURITY BY SUPERVISING OPENINGS OR MAINTAINING THE AIRPORT PERIMETER FENCE LINE AT ALL TIMES DURING THE COURSE OF THE WORK.
3. FINES CAN BE LEVIED AGAINST THE CONTRACTOR BY THE TRANSPORTATION SECURITY ADMINISTRATION (TSA) FOR NEGLIGENCE IF THE AIRPORT SECURITY IS COMPROMISED AND THE AIRPORT PERIMETER FENCE LINE IS NOT MAINTAINED AS SPECIFIED ABOVE. FINES CAN ALSO BE LEVIED AGAINST THE CONTRACTOR FOR FAILURE TO COOPERATE WITH THE AIRPORT MANAGEMENT AS REQUIRED TO MAINTAIN AIRPORT SECURITY.

CONSTRUCTION ACTIVITY GENERAL NOTES

1. CONSTRUCTION PHASING IS OF CRITICAL IMPORTANCE TO THE AIRPORT FOR THIS PROJECT.
2. THE CONTRACTOR SHALL PLAN AND CONDUCT HIS WORK SO AS TO NOT INTERFERE WITH OR HINDER THE PROGRESS OR WORK BEING PERFORMED BY OTHER CONTRACTORS.
3. THE TIMELY PROSECUTION OF THE OVERALL PROJECT IS DEPENDENT UPON THE PROPER COORDINATION BETWEEN CONTRACTORS.
4. IT SHALL BE FULLY UNDERSTOOD BY THE CONTRACTOR THAT THE PROSECUTION OF THE OVERALL PROJECT ARE THE GOVERNING CRITERIA FOR RESOLVING CONFLICTS WHICH MAY ARISE BETWEEN HIS SCHEDULE AND THE SCHEDULE OF OTHER CONTRACTORS.
5. WHEN CONFLICTS ARISE, RESOLUTION OF SUCH CONFLICTS WILL BE MADE BY THE AIRPORT THROUGH THE RESIDENT ENGINEER IN THE BEST INTEREST OF THE AIRPORT.
6. DELAYS, CHANGES IN SCHEDULING, OR THE EXPEDITION OF WORK UNDER THIS CONTRACT TO PROVIDE FOR THE TIMELY PROSECUTION OF THE PROJECT WILL BE CONSIDERED INCIDENTAL TO THE CONTRACT AND NO ADDITIONAL COMPENSATION WILL BE ALLOWED.
7. CONTRACTOR'S STAGING, STORAGE, AND PARKING WILL BE AS SHOWN ON THE CONSTRUCTION ACTIVITY PLANS.
8. THE CONTRACTOR SHALL PLACE ALL BARRICADE ITEMS AS SHOWN IN THE PLANS PRIOR TO INITIATING WORK IN EACH PHASE. ALL COSTS TO FURNISH, INSTALL, AND MAINTAIN THESE ITEMS SHALL BE CONSIDERED INCIDENTAL TO THE PROJECT.
9. CONSTRUCTION RELATED ITEMS REQUIRING THE CLOSURE OF RUNWAYS AND TAXIWAYS SHALL REQUIRE CLOSE COORDINATION WITH THE AIRPORT. NO EXTENSION TO CONTRACT TIME WILL BE GIVEN FOR DELAYS CAUSED BY LACK OF ADEQUATE COORDINATION. THE AIRPORT SHALL REQUIRE 72 HOURS NOTIFICATION PRIOR TO THE CLOSURE OF RUNWAYS.
10. CONSTRUCTION BARRICADES SHALL BE SET AT THE LIMITS OF THE WORK AREA OF EACH PHASE. OFFSETTING BARRICADES TO ANY LOCATION DIFFERENT THAN SHOWN IN THE PLANS WILL COORDINATED WITH THE AIRPORT IN ADVANCE. IN THE EVENT OF A CONFLICT BETWEEN CONSTRUCTION OPERATIONS AND TAXIING AIRCRAFT, THE CONTRACTOR SHALL CEASE OPERATIONS AND RETURN THE BARRICADES TO THE EDGE OF THE WORKING LIMITS. ALL BARRICADES SHALL BE REMOVED AT THE END OF EACH CONSTRUCTION PHASE.

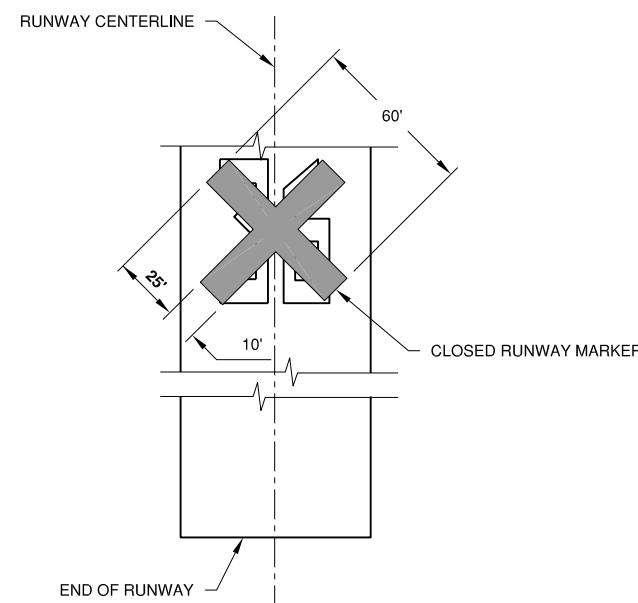

CLOSED RUNWAY MARKER DETAIL

N.T.S.

NOTES

1. MARKERS SHALL BE SOLID YELLOW.
2. MARKERS SHALL BE PAINTED BURLAP, PLYWOOD OR OTHER APPROVED SOLID MATERIALS.
3. CONTRACTOR SHALL PROVIDE AND MAINTAIN MARKERS.
4. COST OF FURNISHING, INSTALLING, MAINTAINING, RELOCATING AND REMOVING MARKERS SHALL BE INCIDENTAL TO THE CONTRACT.
5. MARKERS SHALL BE PLACED OVER EXISTING RUNWAY NUMERALS.
6. CONTRACTOR SHALL PROVIDE SUFFICIENT WEIGHTS (SANDBAGS OR WATER BALLAST) ON MARKERS TO PREVENT MOVEMENT BY WIND, JET BLAST OR PROP WASH.

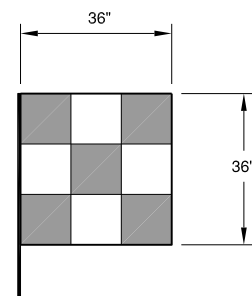

**CONSTRUCTION EQUIPMENT
AND VEHICLE SIGNAL FLAG
(ORANGE / WHITE)**

N.T.S.

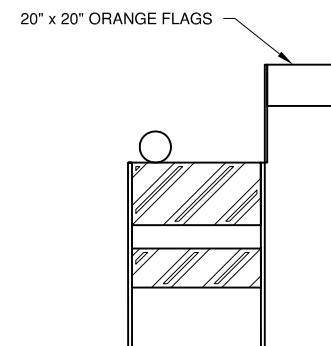

**FLASHER BARRICADE DETAIL
IDOT TYPE 1**

N.T.S.

NOTES

1. FLASHERS TO BE BATTERY OPERATED. LENS TO BE RED AND BE ABLE TO ROTATE 90 DEGREES.
2. SANDBAGS TO BE PLACED ON EACH SUPPORT BRACE AS REQUIRED TO PREVENT DISPLACEMENT BY WIND, JET OR PROP BLAST.
3. NO SEPARATE PAYMENT WILL BE MADE FOR THIS ITEM. COSTS SHALL BE CONSIDERED INCIDENTAL TO THE PROJECT.
4. PLACE AT 5' INTERVALS.

NORTH

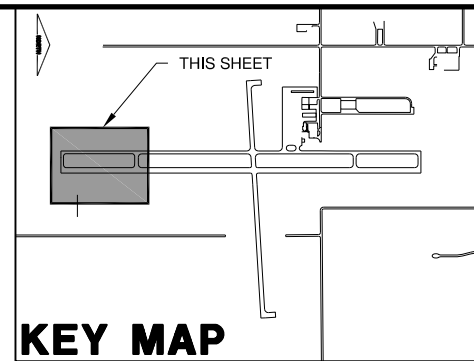
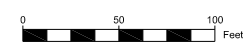

License No. 184-000613
CONSULTANTS

CE035

JANUARY 13, 2017

AIRFIELD PAVEMENT MARKING - PHASE 1

OWNER

CITY OF CENTRALIA, ILLINOIS
CENTRALIA MUNICIPAL AIRPORT
CENTRALIA, ILLINOIS

MARK	DATE	DESCRIPTION

SBG PROJ. NO. 3-17-SBGP-120/133
IL PROJ. NO. ENL-4498
CMT PROJECT NO: 16072-01-00
CAD DWG FILE: 1607201-CM101.DWG
DESIGNED BY: CBG
DRAWN BY: DPA
CHECKED BY: CHK
APPROVED BY: APR
COPYRIGHT: CRAWFORD, MURPHY & TILLY, INC. 2015

SHEET TITLE
PAVEMENT MARKING PLAN 1

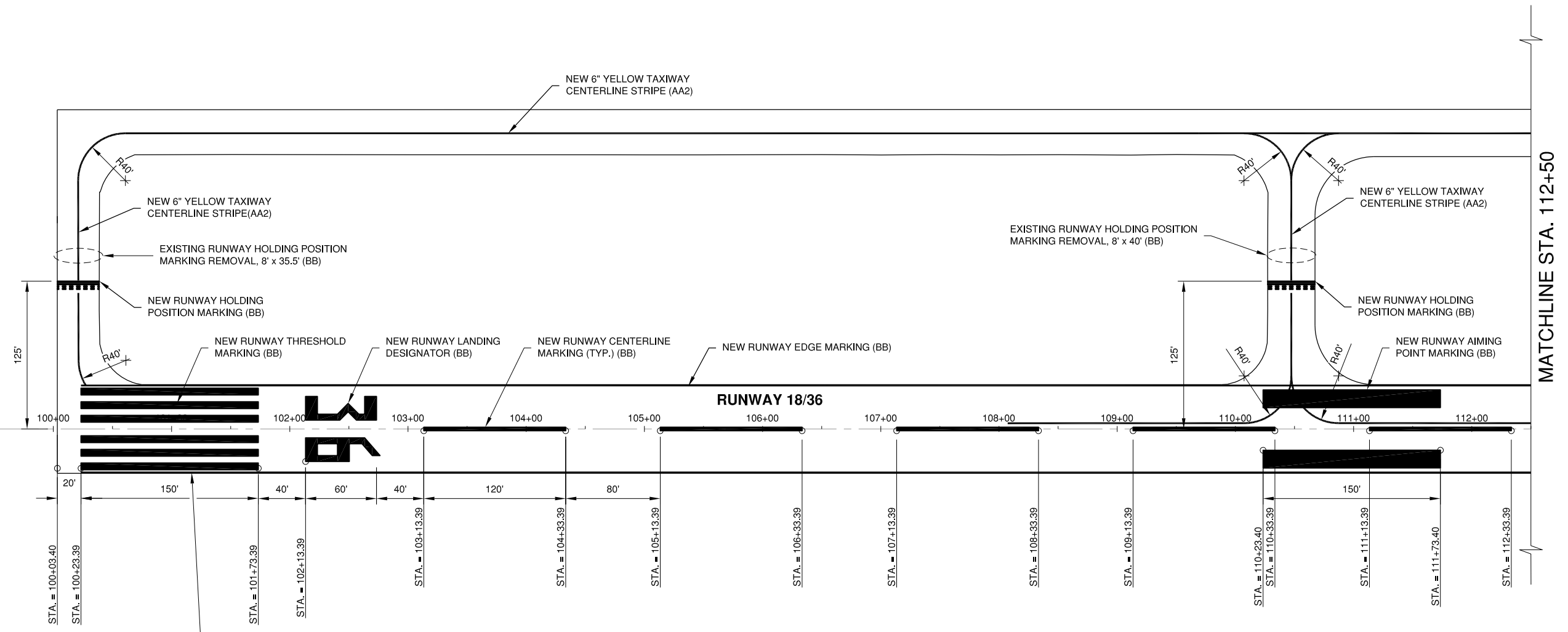

- LEGEND**
- (BB) MARKING INCLUDED IN BASE BID
 - (AA1) MARKING INCLUDED IN ADDITIVE ALTERNATE #1
 - (AA2) MARKING INCLUDED IN ADDITIVE ALTERNATE #2
 - (AA3) MARKING INCLUDED IN ADDITIVE ALTERNATE #3
 - PROPOSED PAVEMENT MARKING
 - EXISTING PAVEMENT

Path: K:\Centralia\16072-01\Drawings\1607201 Re-Bid Package\1607201-CM101.dwg
 Date: Thursday, December 29, 2016 4:21:50 PM

JANUARY 13, 2017

AIRFIELD PAVEMENT MARKING - PHASE 1

OWNER

CITY OF CENTRALIA, ILLINOIS
CENTRALIA MUNICIPAL AIRPORT
CENTRALIA, ILLINOIS

MARK	DATE	DESCRIPTION

SBG PROJ. NO. 3-17-SBGP-120/133

IL PROJ. NO. ENL-4498

CMT PROJECT NO: 16072-01-00

CAD DWG FILE: 1607201-CM101.DWG

DESIGNED BY: CBG

DRAWN BY: DPA

CHECKED BY: CHK

APPROVED BY: APR

COPYRIGHT: CRAWFORD, MURPHY & TILLY, INC. 2015

SHEET TITLE
PAVEMENT MARKING PLAN 2

NORTH

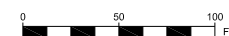

KEY MAP

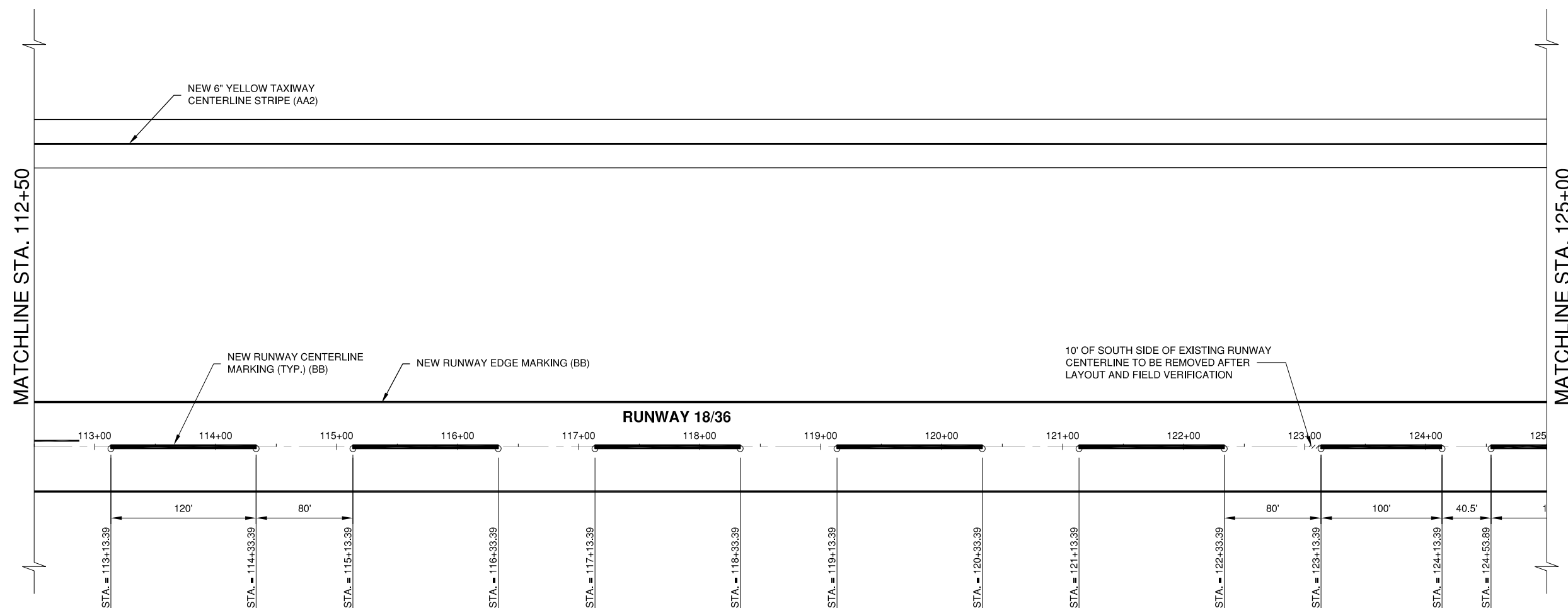
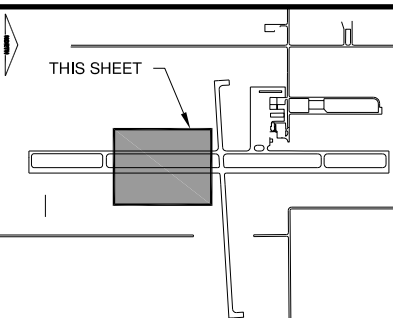

- LEGEND**
- (BB) MARKING INCLUDED IN BASE BID
 - (AA1) MARKING INCLUDED IN ADDITIVE ALTERNATE #1
 - (AA2) MARKING INCLUDED IN ADDITIVE ALTERNATE #2
 - (AA3) MARKING INCLUDED IN ADDITIVE ALTERNATE #3
 - PROPOSED PAVEMENT MARKING
 - EXISTING PAVEMENT

Path: K:\Centralia\16072-01\Drawings\1607201 Re-Bid Package\1607201-CM101.dwg
Date: Thursday, December 29, 2016 4:21:52 PM

JANUARY 13, 2017

AIRFIELD PAVEMENT MARKING - PHASE 1

OWNER

CITY OF CENTRALIA, ILLINOIS
CENTRALIA MUNICIPAL AIRPORT
CENTRALIA, ILLINOIS

MARK	DATE	DESCRIPTION

SBG PROJ. NO. 3-17-SBGP-120/133

IL PROJ. NO. ENL-4498

CMT PROJECT NO: 16072-01-00

CAD DWG FILE: 1607201-CM101.DWG

DESIGNED BY: CBG

DRAWN BY: DPA

CHECKED BY: CHK

APPROVED BY: APR

COPYRIGHT: CRAWFORD, MURPHY & TILLY, INC. 2015

SHEET TITLE

PAVEMENT MARKING PLAN 3

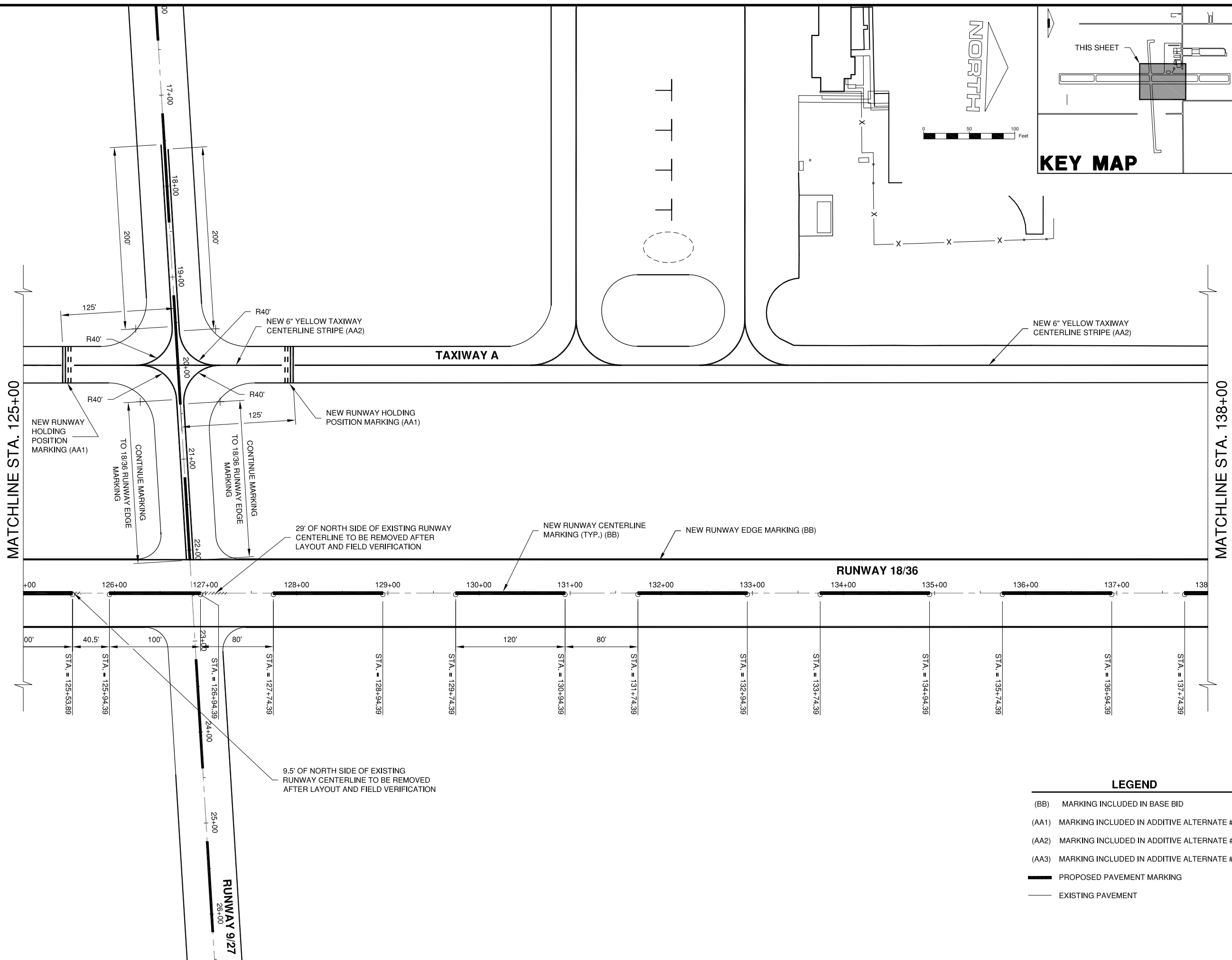

LEGEND

- (BB) MARKING INCLUDED IN BASE BID
- (AA1) MARKING INCLUDED IN ADDITIVE ALTERNATE #1
- (AA2) MARKING INCLUDED IN ADDITIVE ALTERNATE #2
- (AA3) MARKING INCLUDED IN ADDITIVE ALTERNATE #3
- PROPOSED PAVEMENT MARKING
- EXISTING PAVEMENT

KEY MAP

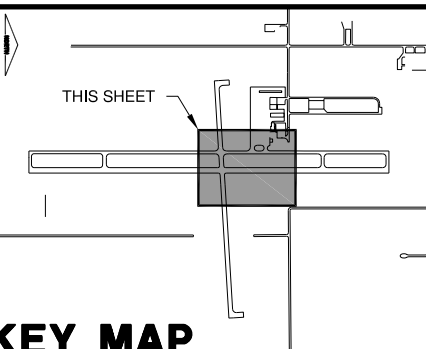
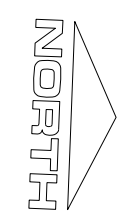
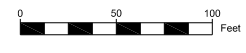

Path: K:\Centralia\16072-01\Drawings\1607201-1607201-1607201-1607201-1607201-1607201-CM101.dwg
Date: Thursday, December 29, 2016 4:21:53 PM

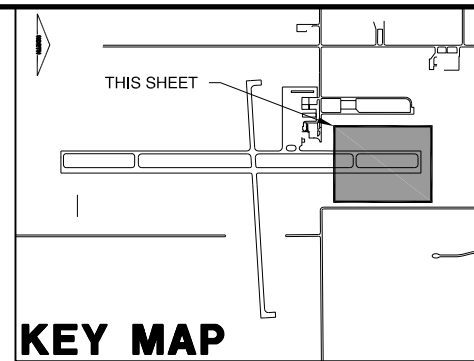
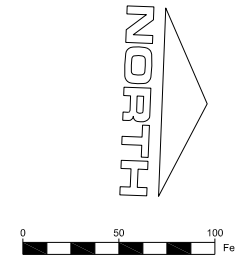

JANUARY 13, 2017

AIRFIELD PAVEMENT MARKING - PHASE 1

OWNER

CITY OF CENTRALIA, ILLINOIS
CENTRALIA MUNICIPAL AIRPORT
CENTRALIA, ILLINOIS

MARK	DATE	DESCRIPTION

SBG PROJ. NO. 3-17-SBG-120/133
IL PROJ. NO. ENL-4498
CMT PROJECT NO: 16072-01-00
CAD DWG FILE: 1607201-CM101.DWG
DESIGNED BY: CBG
DRAWN BY: DPA
CHECKED BY: CHK
APPROVED BY: APR
COPYRIGHT: CRAWFORD, MURPHY & TILLY, INC. 2015

SHEET TITLE
PAVEMENT MARKING PLAN 4

MATCHLINE STA. 138+50

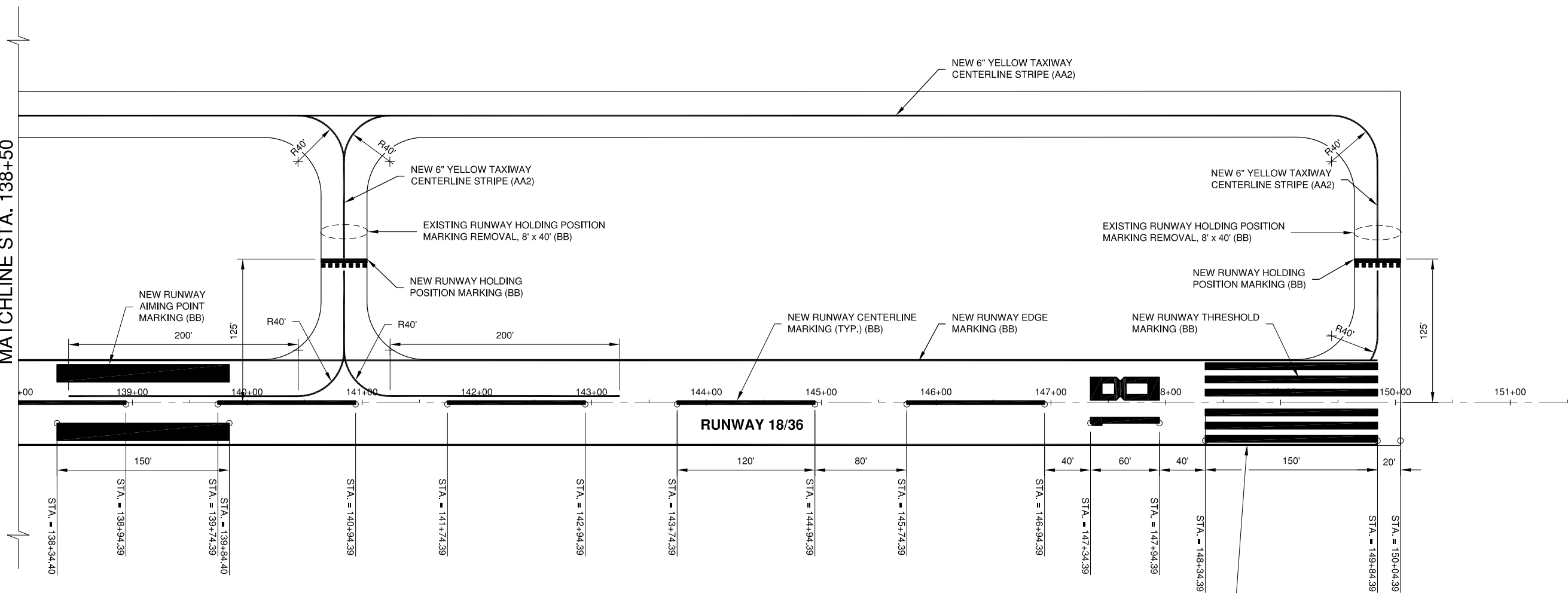

- LEGEND**
- (BB) MARKING INCLUDED IN BASE BID
 - (AA1) MARKING INCLUDED IN ADDITIVE ALTERNATE #1
 - (AA2) MARKING INCLUDED IN ADDITIVE ALTERNATE #2
 - (AA3) MARKING INCLUDED IN ADDITIVE ALTERNATE #3
 - PROPOSED PAVEMENT MARKING
 - EXISTING PAVEMENT

Path: K:\Centralia\16072-01\Drawings\1607201-1607201-1607201-1607201-CM101.dwg
Date: Thursday, December 29, 2016 4:21:56 PM

JANUARY 13, 2017

AIRFIELD PAVEMENT MARKING -
PHASE 1

OWNER

CITY OF CENTRALIA, ILLINOIS
CENTRALIA MUNICIPAL AIRPORT
CENTRALIA, ILLINOIS

MARK	DATE	DESCRIPTION
------	------	-------------

SBG PROJ. NO.	3-17-SBGP-120/133
IL PROJ. NO.	ENL-4498
CMT PROJECT NO.	16072-01-00
CAD DWG FILE:	1607201-CM101.DWG
DESIGNED BY:	CBG
DRAWN BY:	DPA
CHECKED BY:	CHK
APPROVED BY:	APR
COPYRIGHT:	CRAWFORD, MURPHY & TILLY, INC. 2015

SHEET TITLE
**PAVEMENT MARKING
PLAN 5**

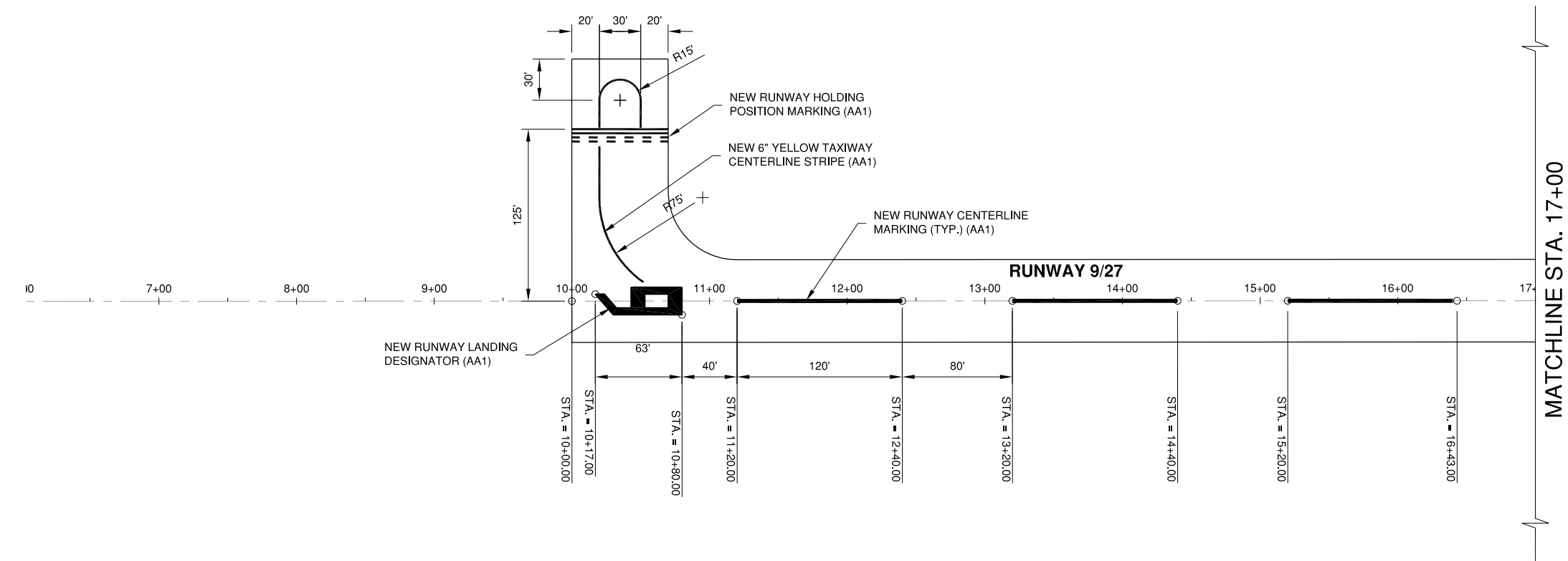
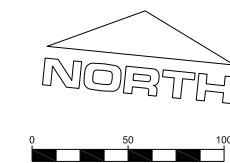
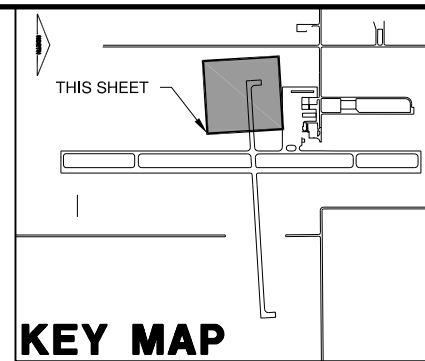

MATCHLINE STA. 17+00

LEGEND

- (BB) MARKING INCLUDED IN BASE BID
- (AA1) MARKING INCLUDED IN ADDITIVE ALTERNATE #1
- (AA2) MARKING INCLUDED IN ADDITIVE ALTERNATE #2
- (AA3) MARKING INCLUDED IN ADDITIVE ALTERNATE #3
- PROPOSED PAVEMENT MARKING
- EXISTING PAVEMENT

MARK	DATE	DESCRIPTION

SBG PROJ. NO. 3-17-SBGP-120/133
IL PROJ. NO. ENL-4498
CMT PROJECT NO: 16072-01-00
CAD DWG FILE: 1607201-CM101.DWG
DESIGNED BY: CBG
DRAWN BY: DPA
CHECKED BY: CHK
APPROVED BY: APR
COPYRIGHT: CRAWFORD, MURPHY & TILLY, INC. 2015

SHEET TITLE
**PAVEMENT MARKING
PLAN 6**

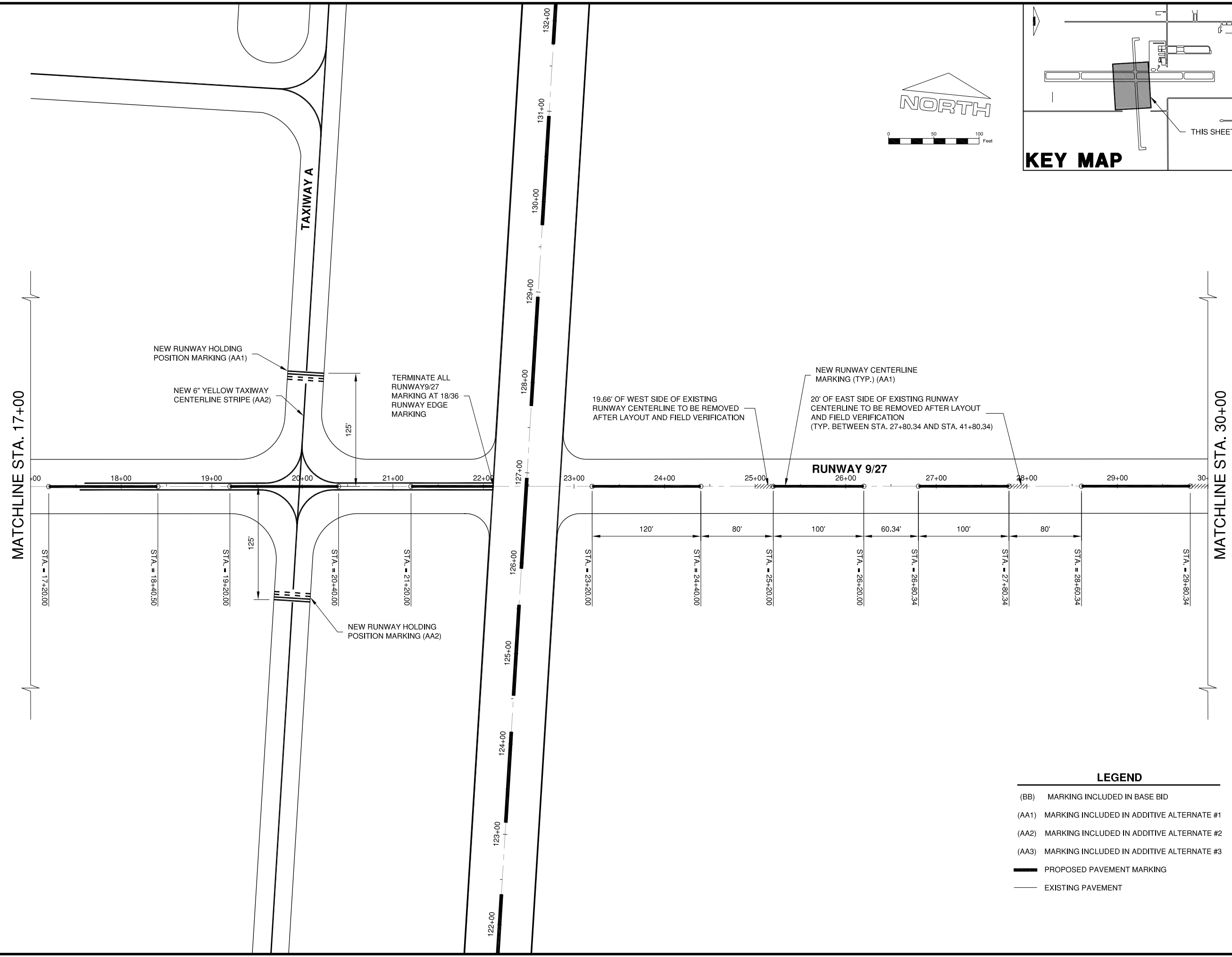
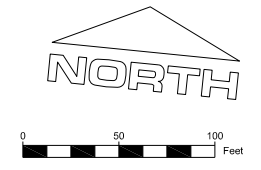
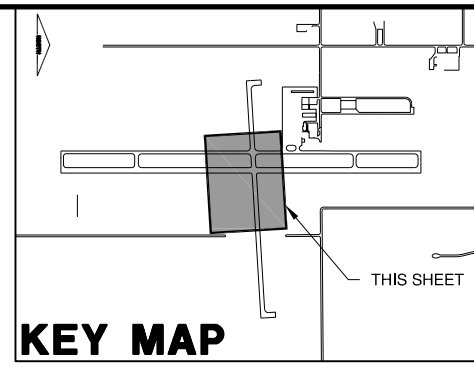

Path: K:\Centralia\16072-01\Drawings\1607201-Plan\1607201-CM101.dwg
Date: Thursday, December 29, 2016 4:21:59 PM

JANUARY 13, 2017

AIRFIELD PAVEMENT MARKING - PHASE 1

OWNER

CITY OF CENTRALIA, ILLINOIS
CENTRALIA MUNICIPAL AIRPORT
CENTRALIA, ILLINOIS

MARK	DATE	DESCRIPTION

SBG PROJ. NO. 3-17-SBGP-120/133

IL PROJ. NO. ENL-4498

CMT PROJECT NO: 16072-01-00

CAD DWG FILE: 1607201-CM101.DWG

DESIGNED BY: CBG

DRAWN BY: DPA

CHECKED BY: CHK

APPROVED BY: APR

COPYRIGHT: CRAWFORD, MURPHY & TILLY, INC. 2015

SHEET TITLE

PAVEMENT MARKING PLAN 7

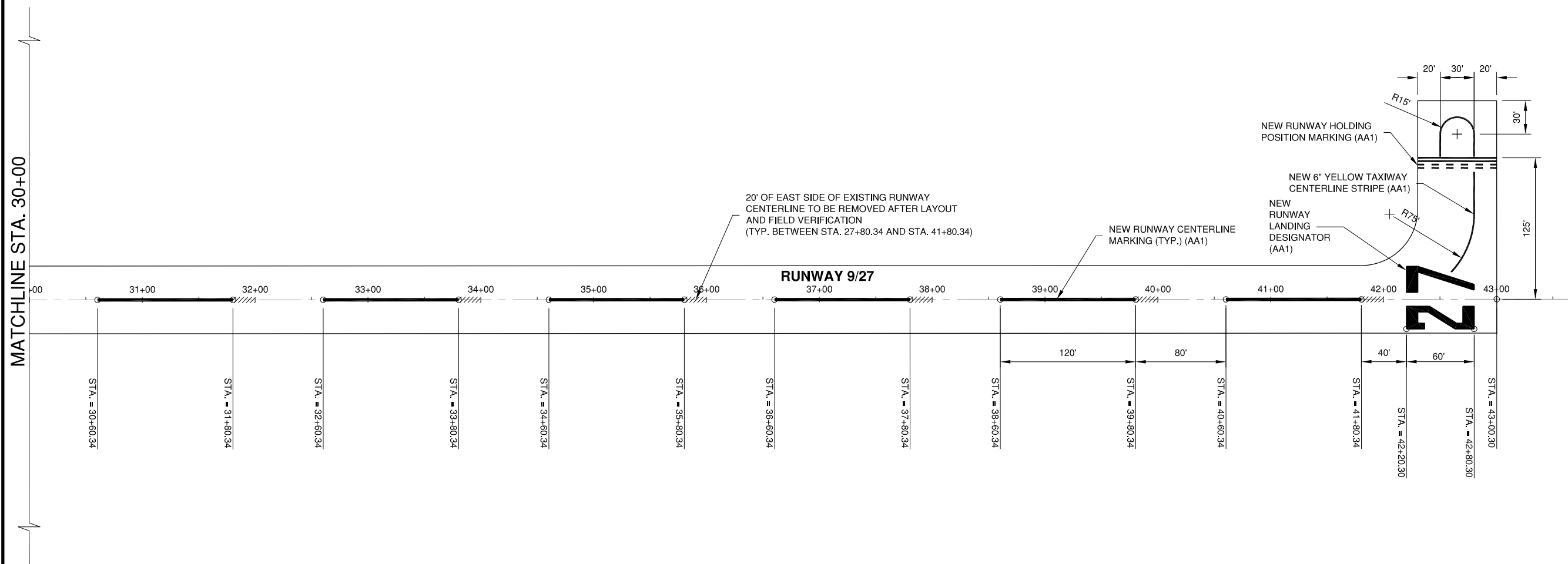
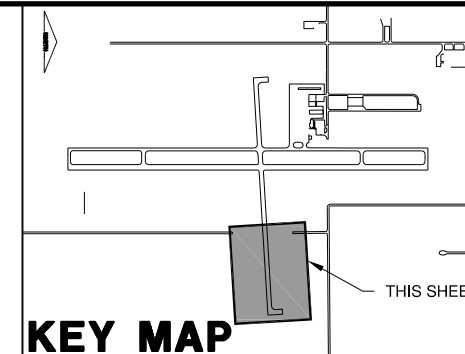

- LEGEND**
- (BB) MARKING INCLUDED IN BASE BID
 - (AA1) MARKING INCLUDED IN ADDITIVE ALTERNATE #1
 - (AA2) MARKING INCLUDED IN ADDITIVE ALTERNATE #2
 - (AA3) MARKING INCLUDED IN ADDITIVE ALTERNATE #3
 - PROPOSED PAVEMENT MARKING
 - EXISTING PAVEMENT

Path: K:\Centralia\16072-01\Drawings\1607201 Re-Bid Package\1607201-CM101.dwg
Date: Thursday, December 29, 2016 4:22:31 PM

JANUARY 13, 2017

AIRFIELD PAVEMENT MARKING - PHASE 1

OWNER

CITY OF CENTRALIA, ILLINOIS
CENTRALIA MUNICIPAL AIRPORT
CENTRALIA, ILLINOIS

MARK	DATE	DESCRIPTION

SBG PROJ. NO. 3-17-SBGP-120/133

IL PROJ. NO. ENL-4498

CMT PROJECT NO: 16072-01-00

CAD DWG FILE: 1607201-CM101.DWG

DESIGNED BY: CBG

DRAWN BY: DPA

CHECKED BY: CHK

APPROVED BY: APR

COPYRIGHT: CRAWFORD, MURPHY & TILLY, INC. 2015

SHEET TITLE

PAVEMENT MARKING PLAN 8

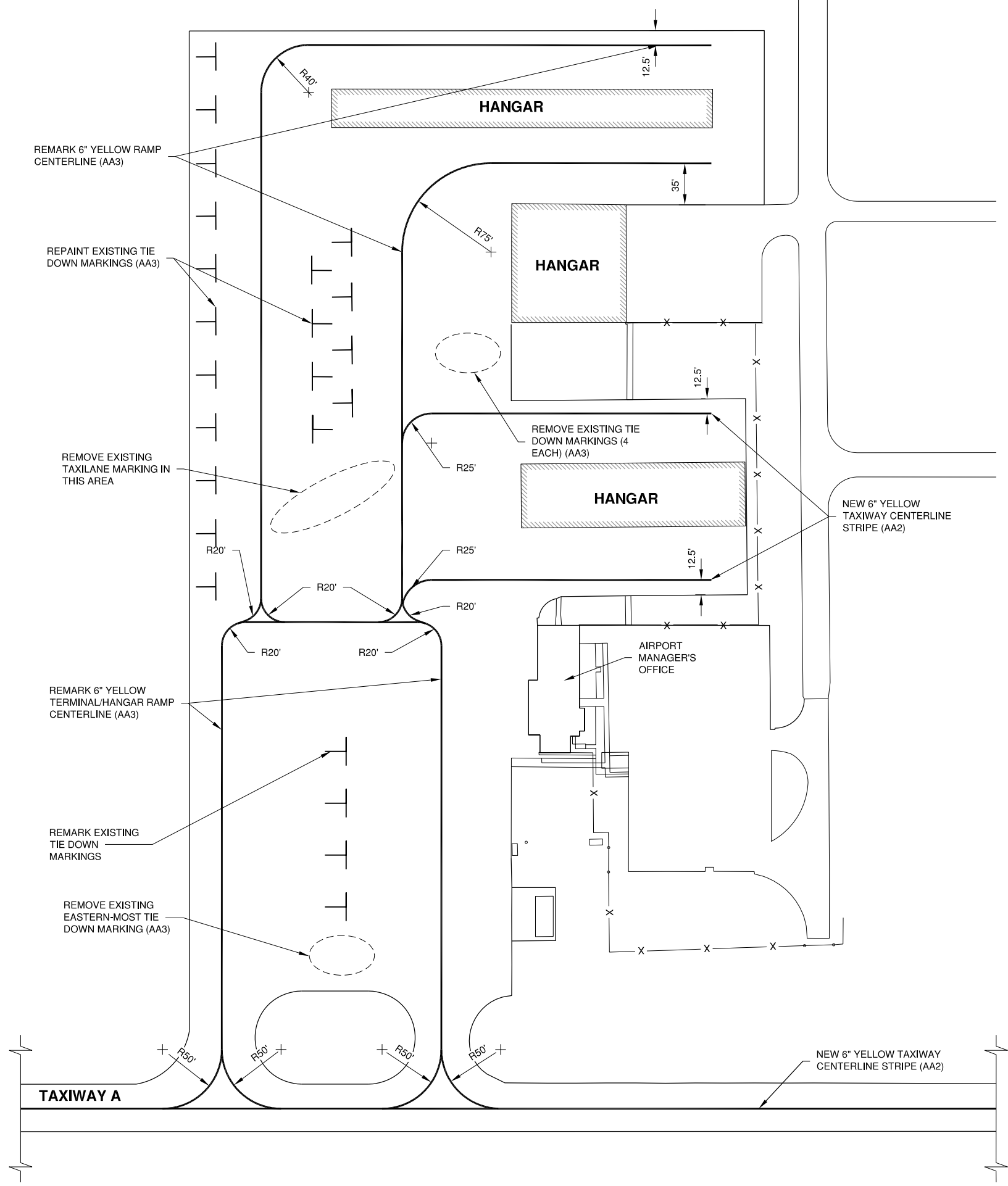
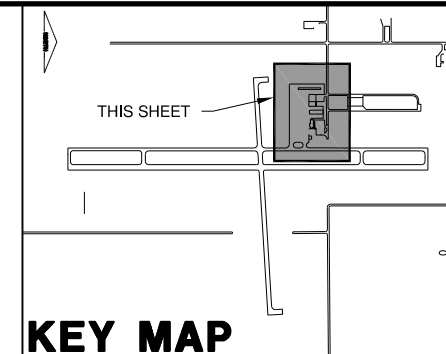

NOTE:

MATCH EXISTING CENTERLINE RADIUS UNLESS NOTED OTHERWISE

LEGEND

- (BB) MARKING INCLUDED IN BASE BID
- (AA1) MARKING INCLUDED IN ADDITIVE ALTERNATE #1
- (AA2) MARKING INCLUDED IN ADDITIVE ALTERNATE #2
- (AA3) MARKING INCLUDED IN ADDITIVE ALTERNATE #3
- PROPOSED PAVEMENT MARKING
- EXISTING PAVEMENT

JANUARY 13, 2017

AIRFIELD PAVEMENT MARKING -
PHASE 1

OWNER

CITY OF CENTRALIA, ILLINOIS
CENTRALIA MUNICIPAL AIRPORT
CENTRALIA, ILLINOIS

MARK	DATE	DESCRIPTION

SBG PROJ. NO. 3-17-SBGP-120/133

IL PROJ. NO. ENL-4498

CMT PROJECT NO: 16072-01-00

CAD DWG FILE: 1607201-CM501.DWG

DESIGNED BY: CBG

DRAWN BY: DPA

CHECKED BY: CHK

APPROVED BY: APR

COPYRIGHT: CRAWFORD, MURPHY & TILLY, INC. 2015

SHEET TITLE

PAVEMENT MARKING
DETAILS 1

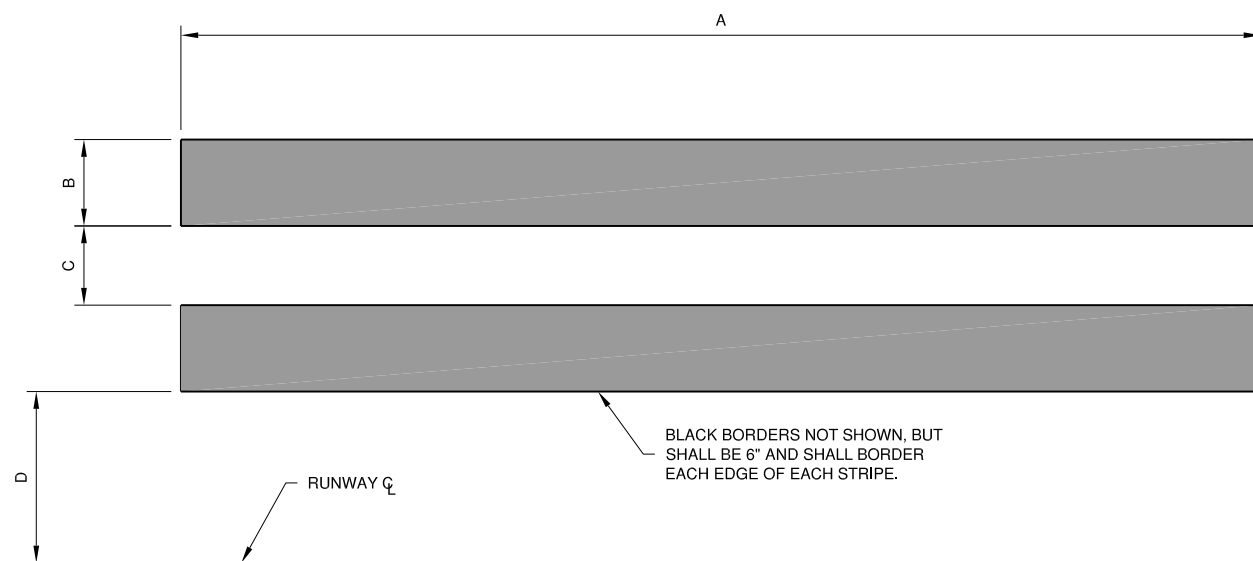

MARKING (PER RUNWAY END)	DIMENSION *			
	A	B	C	D
THRESHOLD MARKER (6 STRIPE)	150'	5.75'	5.75'	5.75'
AIMING POINT MARKING	150'	15'	---	18'

1 AIMING POINT AND THRESHOLD MARKING DETAIL
N.T.S.

2 TAXIWAY CENTERLINE CONTINUOUS
N.T.S.

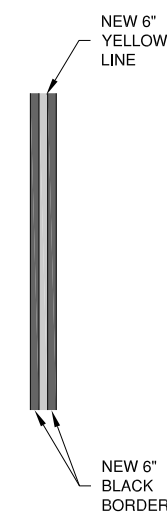

3 RUNWAY 18/36 EDGE STRIPE CONTINUOUS
N.T.S.

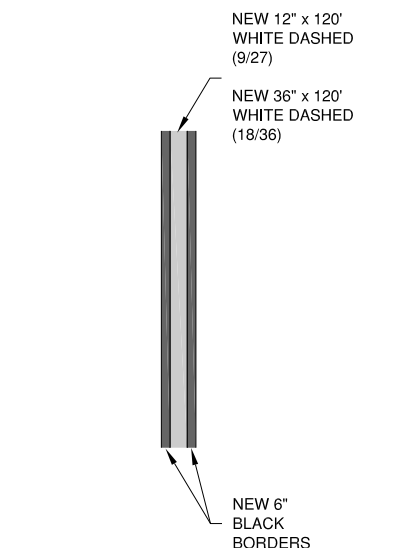
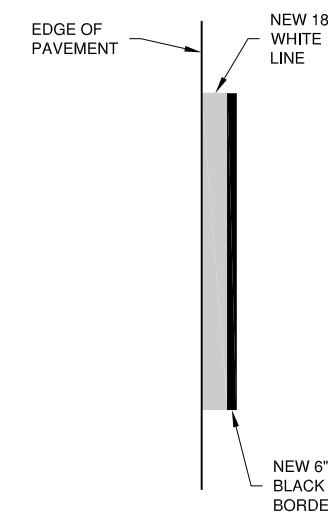

4 RUNWAY 18/36 AND 9/27 CENTERLINE DASHED
N.T.S.

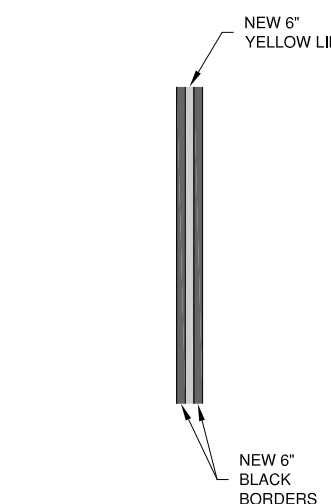

5 TERMINAL/HANGAR RAMP CENTERLINE CONTINUOUS
N.T.S.

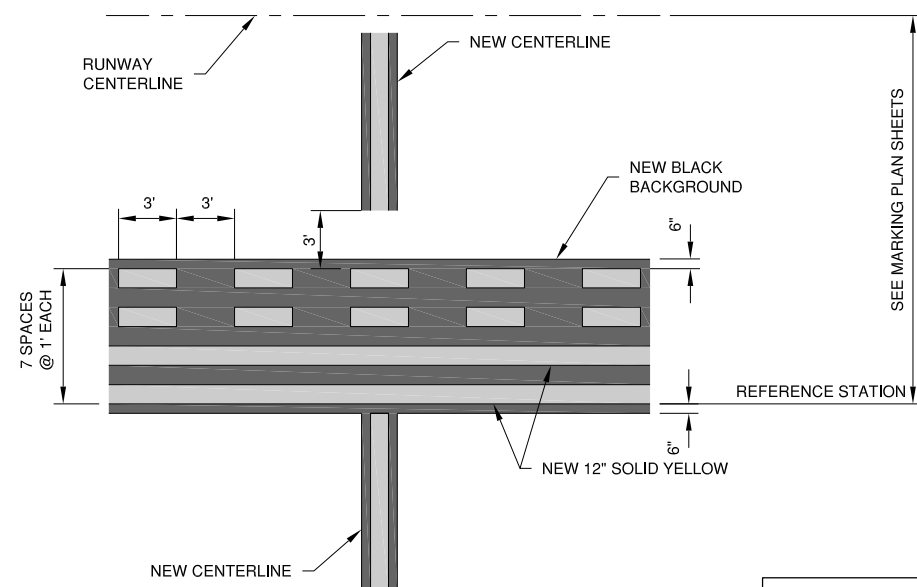

2 RUNWAY HOLDING POSITION MARKING
N.T.S.

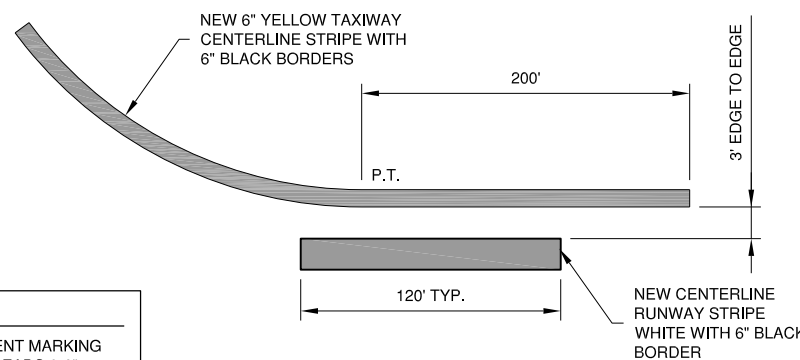

6 NEW TAXIWAY EXIT MARKING DETAIL
N.T.S.

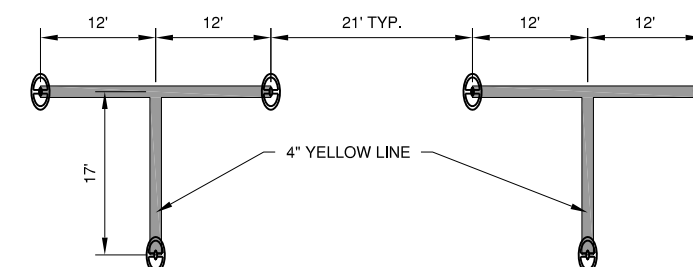

7 TIEDOWN MARKING DETAIL
N.T.S.

- MARKING NOTE**
- ALL NEW AIRFIELD PAVEMENT MARKING SHALL HAVE REFLECTIVE BEADS & 6" BLACK BORDER.
 - BLACK BORDER DOES NOT RECEIVE REFLECTIVE BEADS.
 - TIE DOWN MARKINGS SHALL NOT RECEIVE BLACK BORDER.

JANUARY 13, 2017

AIRFIELD PAVEMENT MARKING - PHASE 1

OWNER

CITY OF CENTRALIA, ILLINOIS
CENTRALIA MUNICIPAL AIRPORT
CENTRALIA, ILLINOIS

MARK	DATE	DESCRIPTION

SBG PROJ. NO. 3-17-SBGP-120/133
IL PROJ. NO. ENL-4498
CMT PROJECT NO: 16072-01-00
CAD DWG FILE: 1607201-CM502.DWG
DESIGNED BY: CBG
DRAWN BY: DPA
CHECKED BY: CHK
APPROVED BY: APR
COPYRIGHT: CRAWFORD, MURPHY & TILLY, INC. 2015

SHEET TITLE
**PAVEMENT MARKING
DETAILS 2**

CENTER OF OUTER EDGES OF NUMERALS IS
CENTERED ON THE PAVEMENT CENTERLINE.
TYPICAL OF ALL DOUBLE RUNWAY DESIGNATIONS.

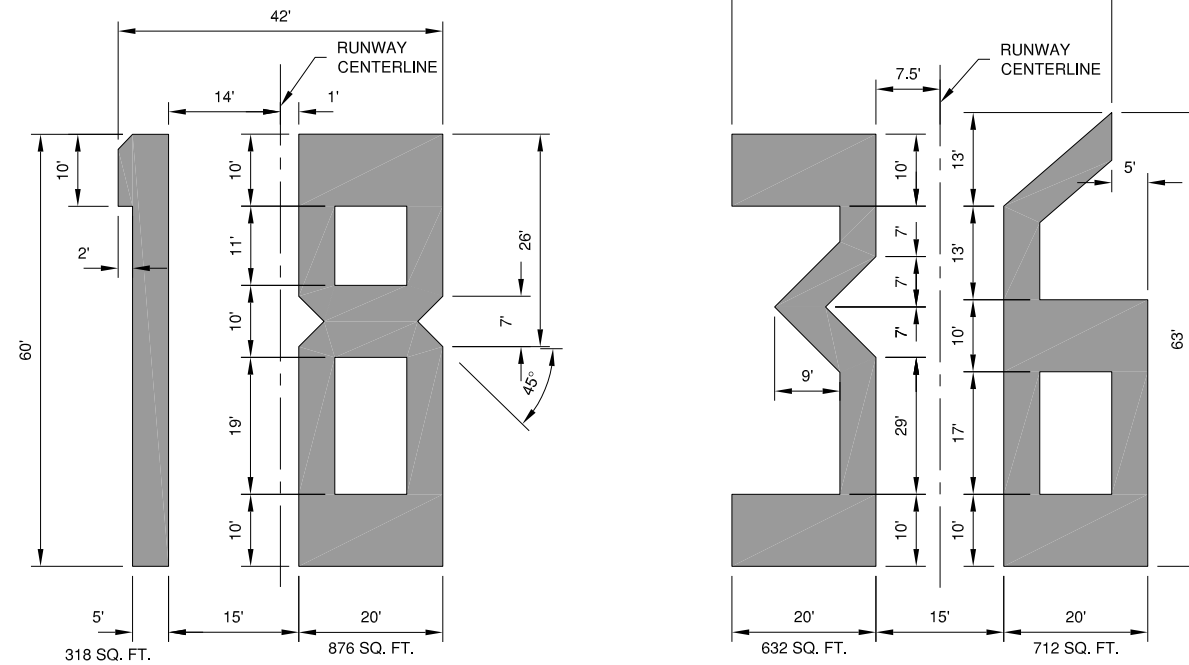

1 RUNWAY 18/36 LANDING DESIGNATORS
N.T.S.

CENTER OF OUTER EDGES OF NUMERALS IS
CENTERED ON THE PAVEMENT CENTERLINE.
TYPICAL OF ALL DOUBLE RUNWAY DESIGNATIONS.

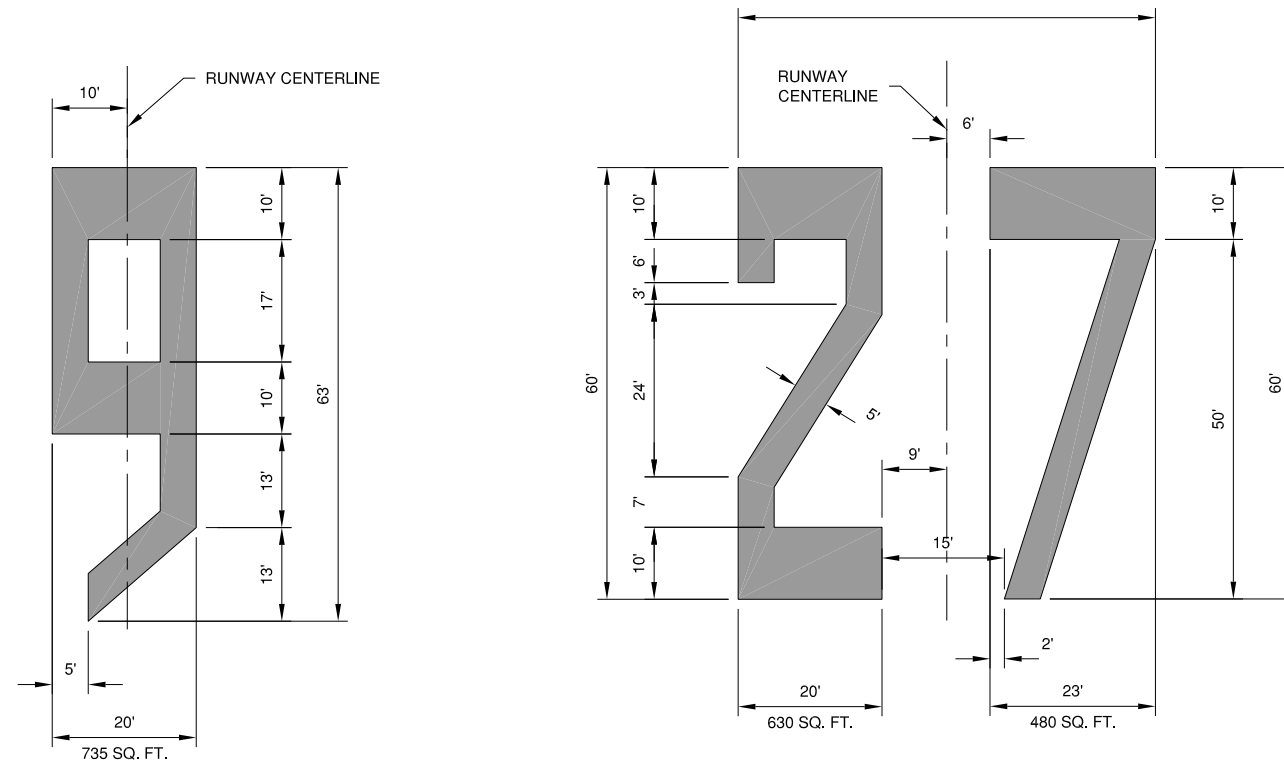

2 RUNWAY 9/27 LANDING DESIGNATORS
N.T.S.