

Contract # 66607

BILL OF MATERIAL

Bar	No.	Size	Length	Shape
n40(E)	12	#6	37'-8"	
n4(E)	2	#6	32'-8"	
n42(E)	50	#6	15'-8"	
n43(E)	68	#6	16'-0"	
n44(E)	2	#6	27'-4"	
n45(E)	9	#5	19'-5"	
n40(E)	66	#14	14'-3"	
n4(E)	64	#14	17'-3"	
p40(E)	20	#14	37'-8"	
p4(E)	6	#9	37'-10"	
s40(E)	64	#6	27'-0"	
s4(E)	100	#6	14'-6"	
s42(E)	50	#6	12'-4"	
s43(E)	68	#6	17'-8"	
s44(E)	19	#4	12'-8"	
s45(E)	175	#5	7'-10"	
s46(E)	238	#5	10'-11"	
s47(E)	36	#6	16'-0"	
sp40	5	#5	1201'-0"	
t40(E)	84	#10	27'-8"	
t4(E)	42	#5	27'-8"	
u40(E)	12	#6	13'-4"	
v40(E)	66	#14	30'-6"	
v4(E)	64	#14	27'-6"	
v42(E)	32	#14	37'-0"	
v43(E)	30	#14	40'-0"	
v44(E)	32	#14	28'-8"	
v45(E)	30	#14	25'-8"	
v46	100	#11	40'-3"	
w40(E)	84	#10	37'-8"	
w4(E)	42	#5	37'-8"	
Cofferdam Excavation	Cu. Yd.		647	
Concrete Structures	Cu. Yd.		913	
Reinforcement Bars, Epoxy Coated	Pound		125,570	
Reinforcement Bars	Pound		27,660	
Drilled Shaft in Rock	Cu. Yd.		122	
Mechanical Splice	E.g.		192	

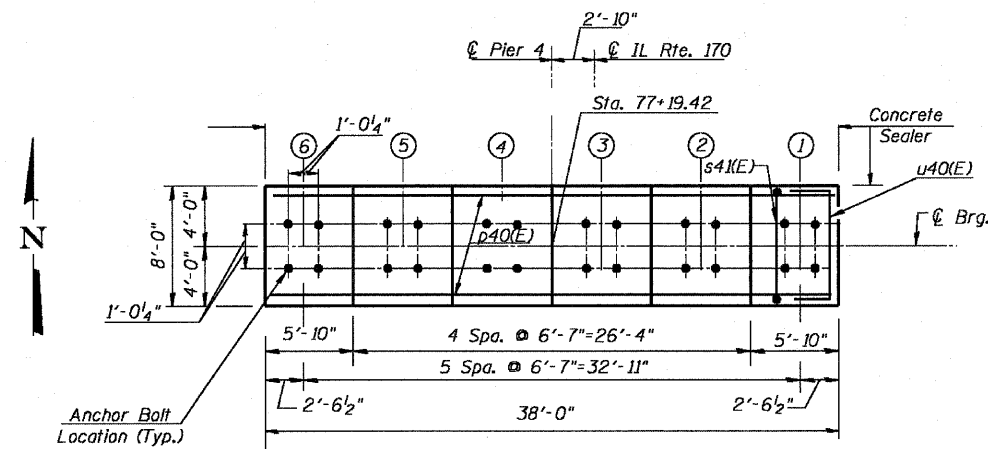

TOP PLAN

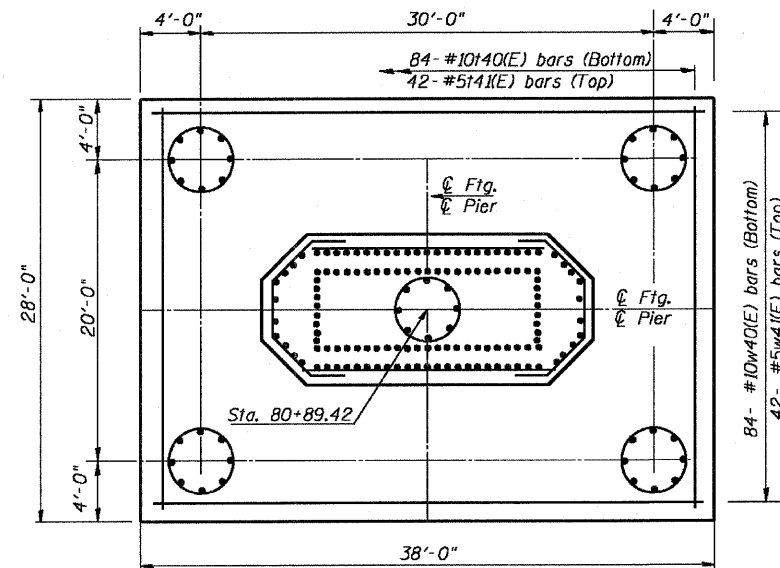

FOOTING PLAN

N.T.S.

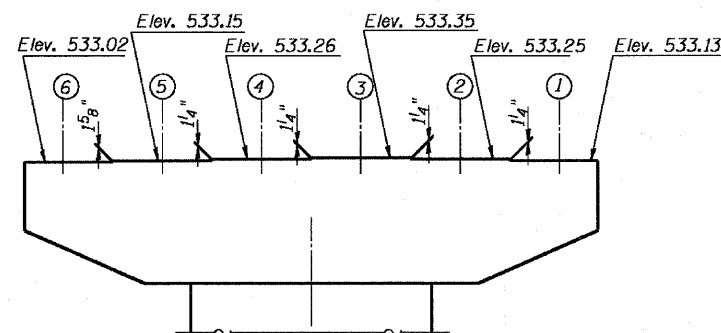

TOP OF PIER

(Showing Steps Elevations)

VESSEL COLLISION FORCES

Load Case 1
Static Load = 2800K
Elevation = 500.13 ft (Barge Bow Rake 6' above MHW)
Direction = Parallel to Pier & Navigational Channel

Load Case 2
Static Load = 1400K
Elevation = 500.13 ft (Barge Bow Rake 6' above MHW)
Direction = Perpendicular to Pier & Navigational Channel

Note: Load Cases are considered independently
Load Combination 1.0(1.0D)+1.0P+1.0B+1.0SF+1.0E)

DESIGNED - RJC
CHECKED - DEV
DRAWN - JHR
CHECKED - DEV

C & D DIMENSIONS

Bar	C	D
n40(E)	2'-3"	12'-0"
n4(E)	2'-3"	15'-0"

BARS nxx(E)

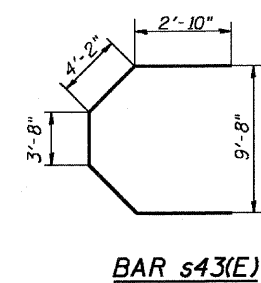

BAR s43(E)

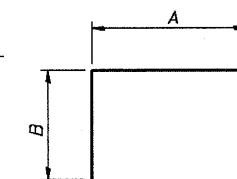

BARS sxx(E)

A & B DIMENSIONS

Bar	A	B
s4(E)	5'-2"	4'-8"
s42(E)	6'-8"	2'-10"
s44(E)	7'-8"	2'-6"
s47(E)	5'-2"	5'-5"

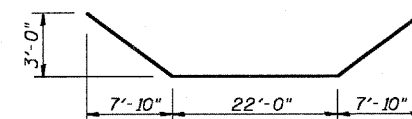

BAR p4(E)

BARS sxx(E)

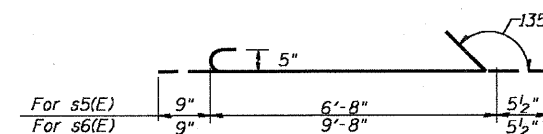

BAR s45(E) and s46(E)

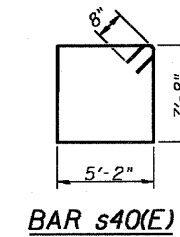

BAR s40(E)

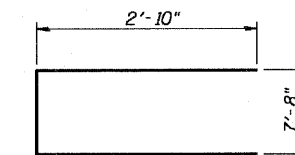

BAR u40(E)

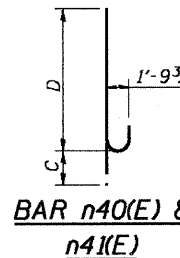

BAR n40(E) & n4(E)

Notes:

1. Work this Sheet with Sheet 74.
2. Space reinforcement in cap to miss anchor bolts. Pour steps monolithically with cap.
3. Cofferdam struts are not allowed to pass through Foundation.
4. Final Design & Dimensions of Cofferdams are the Responsibility of the Contractor.

PIER 4 DETAILS
IL. 170 F.A.P. 786 OVER
ILLINOIS RIVER AT SENECA
PUBLIC WATERS
LA SALLE COUNTY, SECTION 109 BR
STATION 79+04.42
STRUCTURE NO. 050-0246