











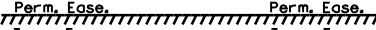

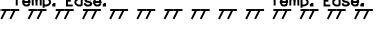
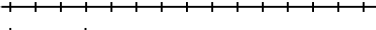





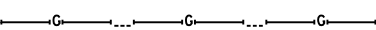
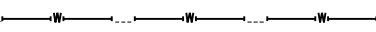
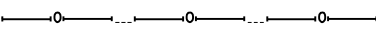
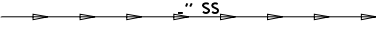
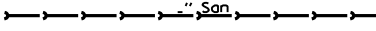
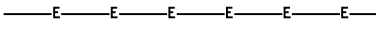
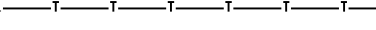
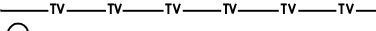





STANDARD SYMBOLS

Center Line.....	-----	Deciduous Tree.....	
Property Line.....	-----	Boring Location.....	
Existing Right of Way.....	-----	Median Water Surface Elevation (W.S.E.).....	
Proposed Right of Way.....	-----	Median Water Surface.....	-----
Permanent Easement.....		Light Pole.....	
Temporary Easement.....			
Railroad Tracks.....			
Existing Culvert.....			
Culvert to be Constructed.....			
Guy Wire...or...Anchor.....			
Guy Pole.....			
Powerline Pole.....			
Telephone...or...Telegraph Pole.....			
Pipelines.....	-----		
Gas.....			
Water.....			
Oil.....			
Storm Sewer.....			
Sanitary Sewer.....			
Electric Cable, U (Underground), A (Aerial).....			
Telephone Cable, U (Underground), A (Aerial).....			
Cable Television...U (Underground)...A (Aerial).....			
Catch Basin.....			
Manhole.....			
Inlet.....			
Waterline Valve.....			
Fire Hydrant.....			
Vents.....			
Meter Boxes.....			
Traps, Grease etc.....			
Cistern or Well.....			
Cesspool or Septic Tank.....			
Fountain.....			
Fenceline.....			
Direction of Flow.....			
Bridge.....			

O:\Dwr\Proj\Imp\Projects\Yorkville Dam Phase 3\Plans DGN\Standard Sheet.dgn

5:13:21 PM

2/14/2011

Designed By JUF Checked By TMM
Drawn By JUF Checked By TMM

GENERAL NOTES

Signs shall be made of 3/4" plywood or oxboard, or of metal (18 ga.). The Contractor shall furnish all material and labor for constructing and erecting the signs. The signs shall be placed prior to the starting of actual construction operations at each end of the construction section or as directed by the Engineer. Before any sign is erected, it shall be approved by the Engineer as to its appearance and quality of construction. The signs shall remain in place and shall be maintained in satisfactory condition until the project is accepted by the department. The Contractor shall then remove the signs and the material will become his property.

The letters on the sign shall be black mechanical style on a white background and appropriate border lines.

Paid for as Wood Information Signs.

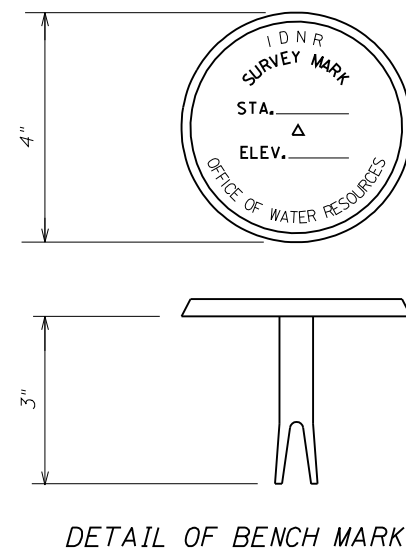
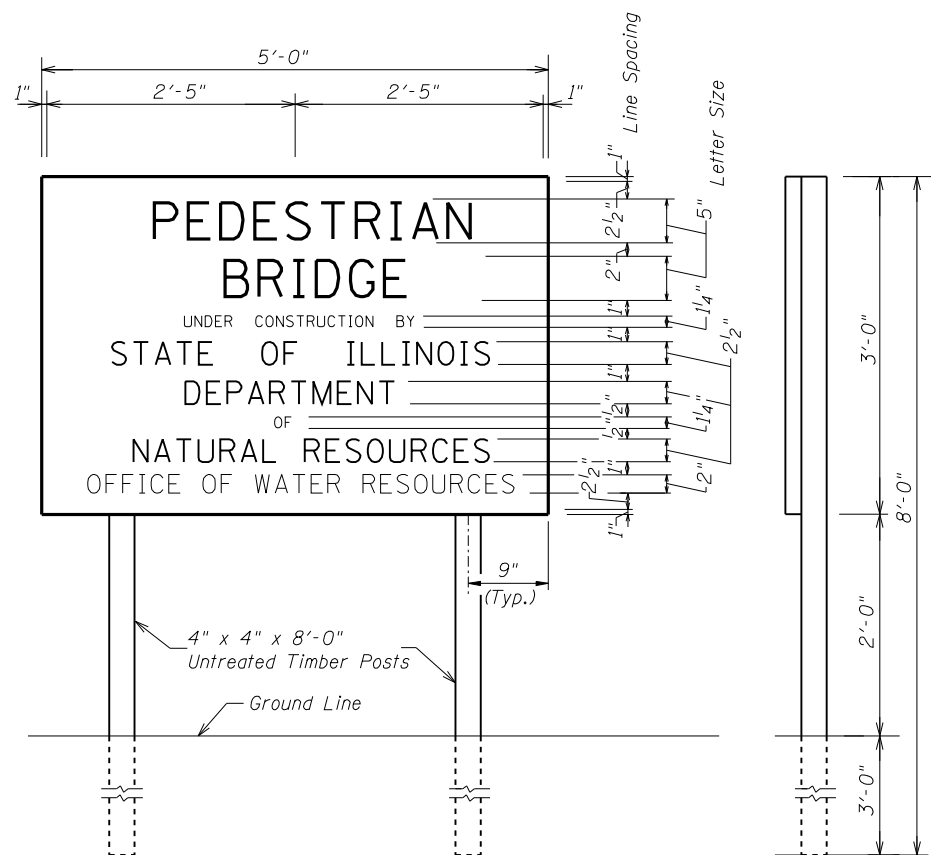

Bench Mark to be furnished by the Office of Water Resources.

See Design Plans for location.

Cost of placing shall be considered included with Concrete Structures.