

WEST ELEVATION
(Looking East)

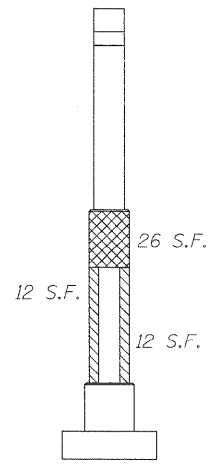

VIEW A

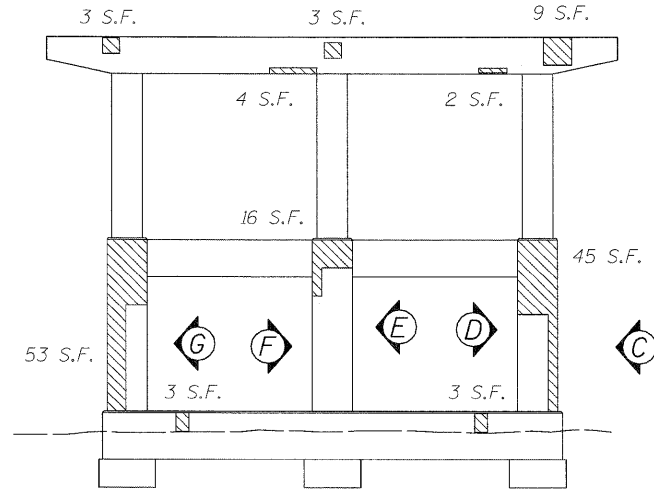

EAST ELEVATION
(Looking West)

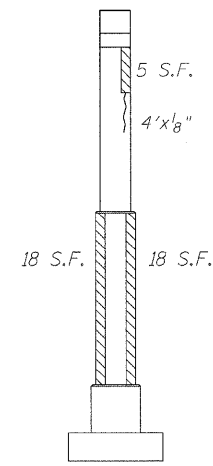

VIEW C

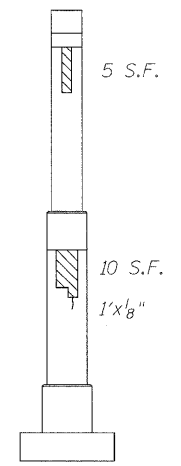

VIEW D

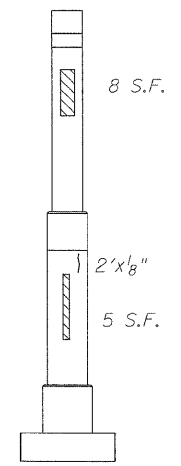

VIEW E

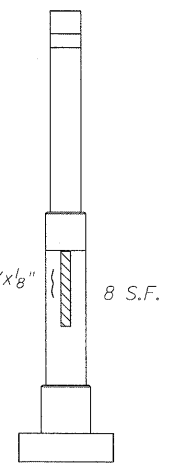

VIEW F

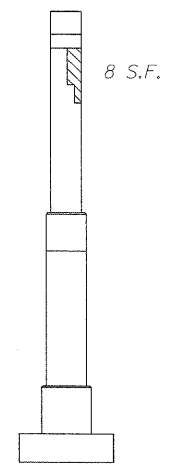

VIEW G

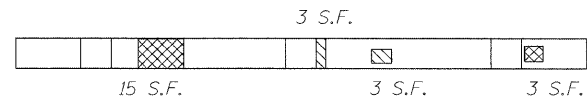

VIEW B

- Structural Repair of Concrete (Depth < 5") = 408 Sq. Ft.
- Structural Repair of Concrete (Depth > 5") = 58 Sq. Ft.
- Epoxy Crack Injection

PIER 3

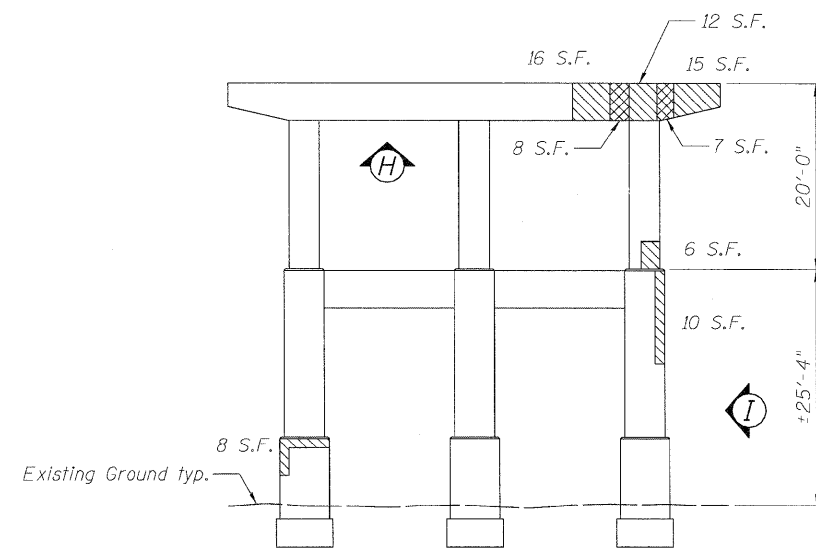

WEST ELEVATION
(Looking East)

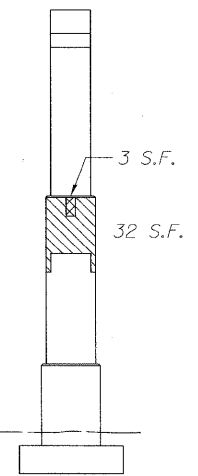

VIEW I

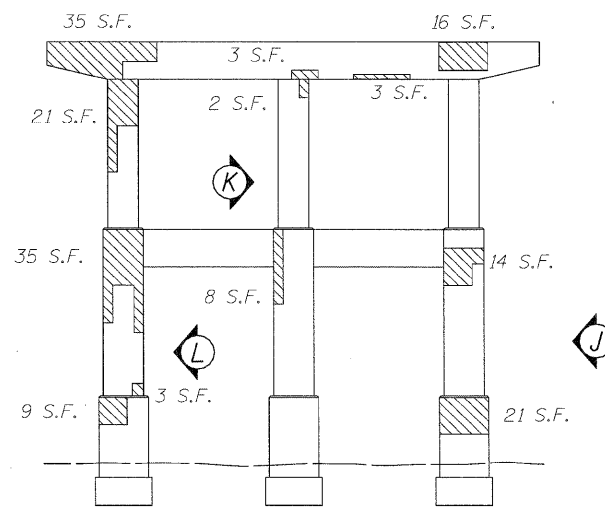

EAST ELEVATION
(Looking West)

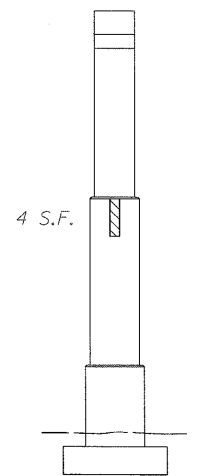

VIEW J

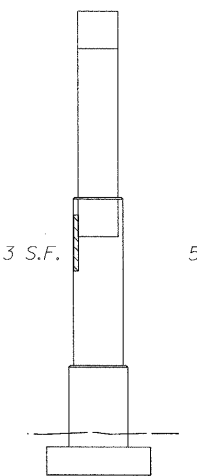

VIEW K

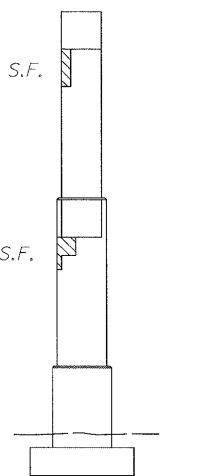

VIEW L



VIEW H

- Structural Repair of Concrete (Depth < 5") = 302 Sq. Ft.
- Structural Repair of Concrete (Depth > 5") = 18 Sq. Ft.

PIER 4

NOTES: See Sheet S-18 for Temporary Shoring and Cribbing, Special locations.

DESIGNED - JC	REVISED -		STATE OF ILLINOIS DEPARTMENT OF TRANSPORTATION		PIER REPAIR DETAILS EASTBOUND FAI-80 OVER DES PLAINES RIVER STRUCTURE NO. 099-0056		F-A.J. RTE.	SECTION	COUNTY	TOTAL SHEETS	SHEET NO.
USER NAME = truelle	DRAWN - JC						80	99(2&3)RS-3	WILL	200	131
PLOT SCALE = NTS	CHECKED - DF						CONTRACT NO. 60M64				
PLOT DATE = 1/20/2011 12:56:05 PM	DATE - 01/21/2011						FED. ROAD DIST. NO. [ILLINOIS] FED. AID PROJECT				

s:\056\05.cadd\cadd sheets\0990056-60M64-024-PR3-4.dgn