

STATE OF ILLINOIS
DEPARTMENT OF TRANSPORTATION

ROUTE NO.	SECTION	COUNTY	TOTAL SHEETS	SHEET NO.	SHEET NO. 5 10 SHEETS
FAI 74	*	ROCK ISLAND	246	152	
FED. ROAD DIST. NO. 7		ILLINOIS	FED. AID PROJECT-		

* 81 (1-2, 1, 2-2) RS-1 & M

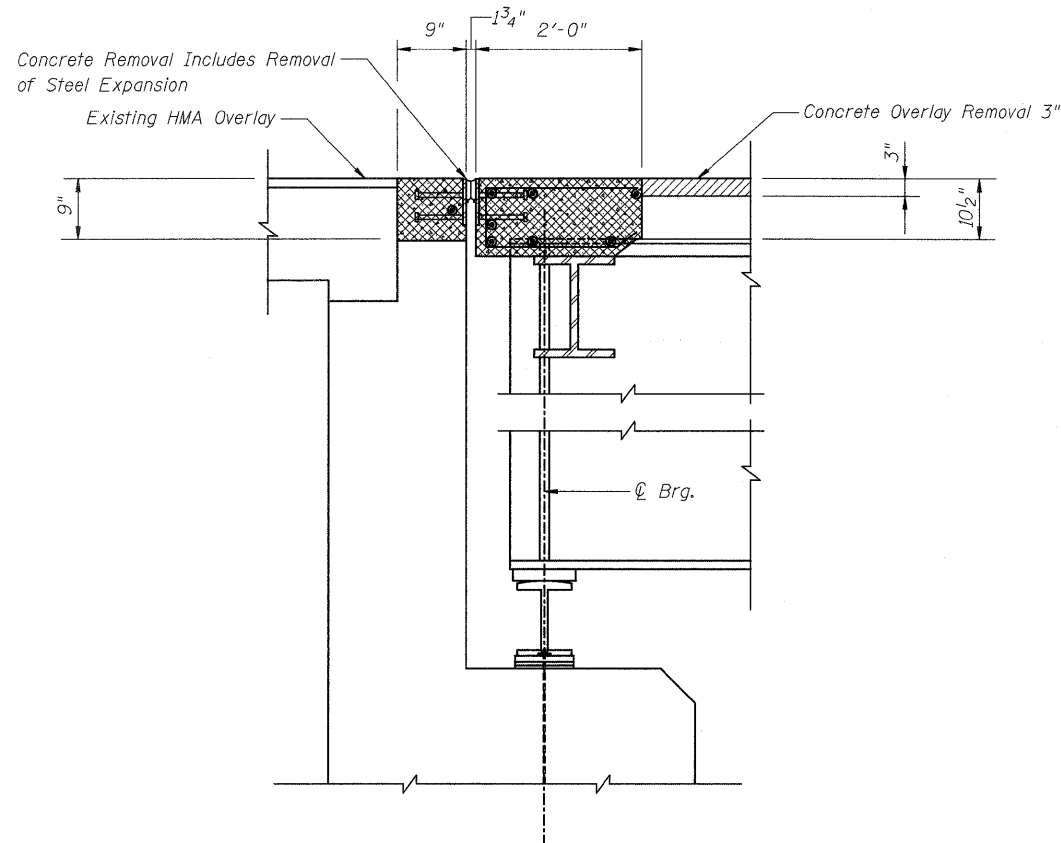

EXISTING SECTION C-C THRU NORTH ABUTMENT

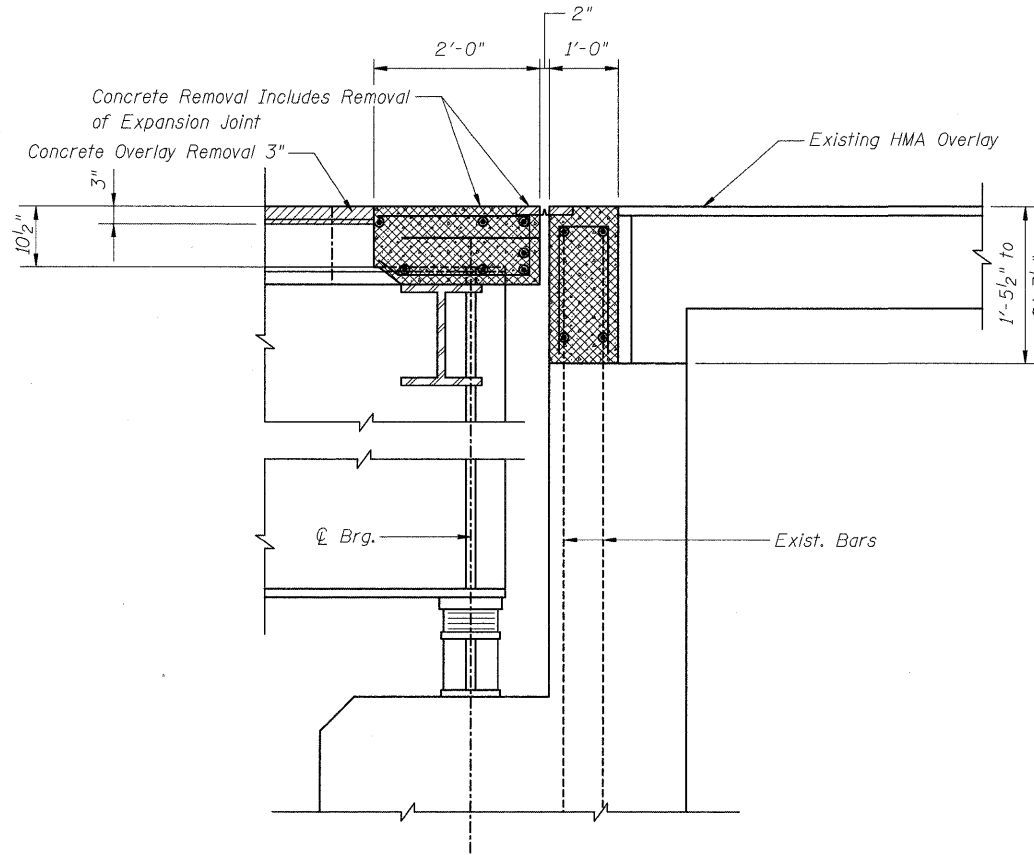

EXISTING SECTION D-D THRU SOUTH ABUTMENT

LEGEND

- Concrete Removal
- Bridge Deck Scarification

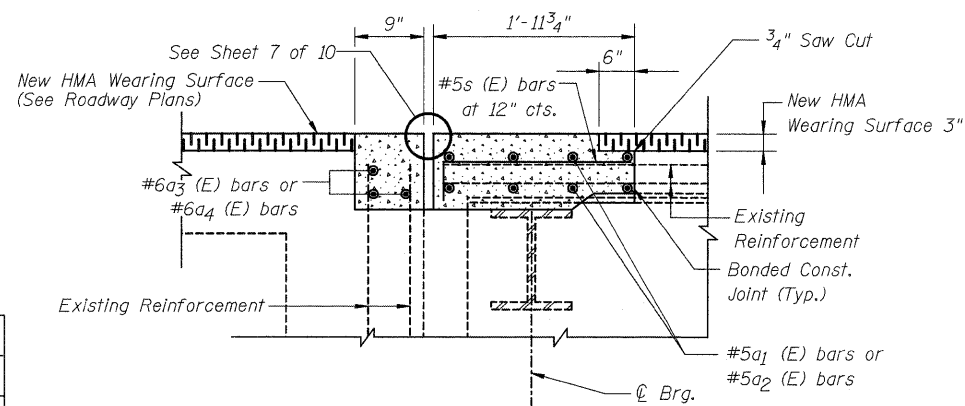

PROPOSED SECTION C-C THRU NORTH ABUTMENT

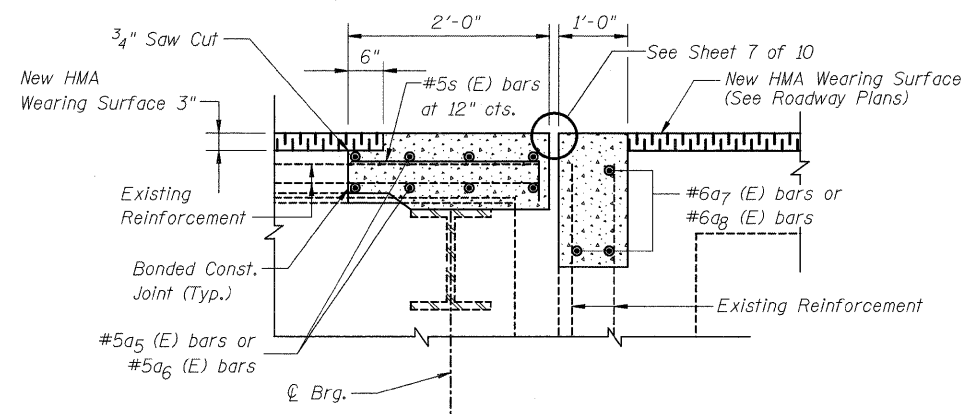

PROPOSED SECTION D-D THRU SOUTH ABUTMENT

DESIGNED	DFM
CHECKED	DSG
DRAWN	EBS
CHECKED	DFM

JOINT RECONSTRUCTION DETAILS
F.A.I. 74 (OVER 12TH AVE.)
ROCK ISLAND COUNTY
STRUCTURE NO. 081-0101