

STATE OF ILLINOIS
DEPARTMENT OF TRANSPORTATION

F.A.I. RTE.	SECTION	COUNTY	TOTAL SHEETS	SHEET NO.
74	CM21-5009	MCLEAN	7	1
		ILLINOIS	CONTRACT NO. 70F06	

FOR INDEX OF SHEETS, SEE SHEET NO. 2
FOR SUMMARY OF QUANTITIES, SEE SHEET NO. 3

PROPOSED HIGHWAY PLANS

F.A.I. ROUTE 74 (I-74)
SECTION CM21-5009
PROJECT
PARTIAL WIDTH RESURFACING
MCLEAN COUNTY

C-95-025-21

CURRENT TRAFFIC DATA

FAL-74 UNDER FAL-55 BUS. IN MCLEAN CO.

2020 ADT: 22,300
2030 ADT: 23,400
P.U. & P.C.%: 63.1
SU% = 3.3
MU% = 33.6

**DESIGN DESIGNATION
INTERSTATE**

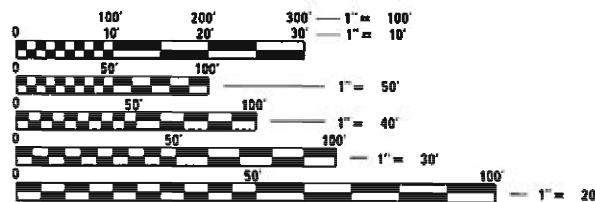

FULL SIZE PLANS HAVE BEEN PREPARED USING STANDARD ENGINEERING SCALES. REDUCED SIZED PLANS WILL NOT CONFORM TO STANDARD SCALES. IN MAKING MEASUREMENTS ON REDUCED PLANS, THE ABOVE SCALES MAY BE USED.

J.U.L.I.E.
JOINT UTILITY LOCATION INFORMATION FOR EXCAVATORS
1-800-892-0123
OR 811

TOWNSHIP: BLOOMINGTON
PROJECT ENGINEER: JASON STULTS
SQUAD LEADER: CLARE DIETZ
PHONE NUMBER: (217)-465-4181
CONTRACT NO. 70F06

START PROJECT:
STA. 627 + 50

END PROJECT:
STA. 640 + 45

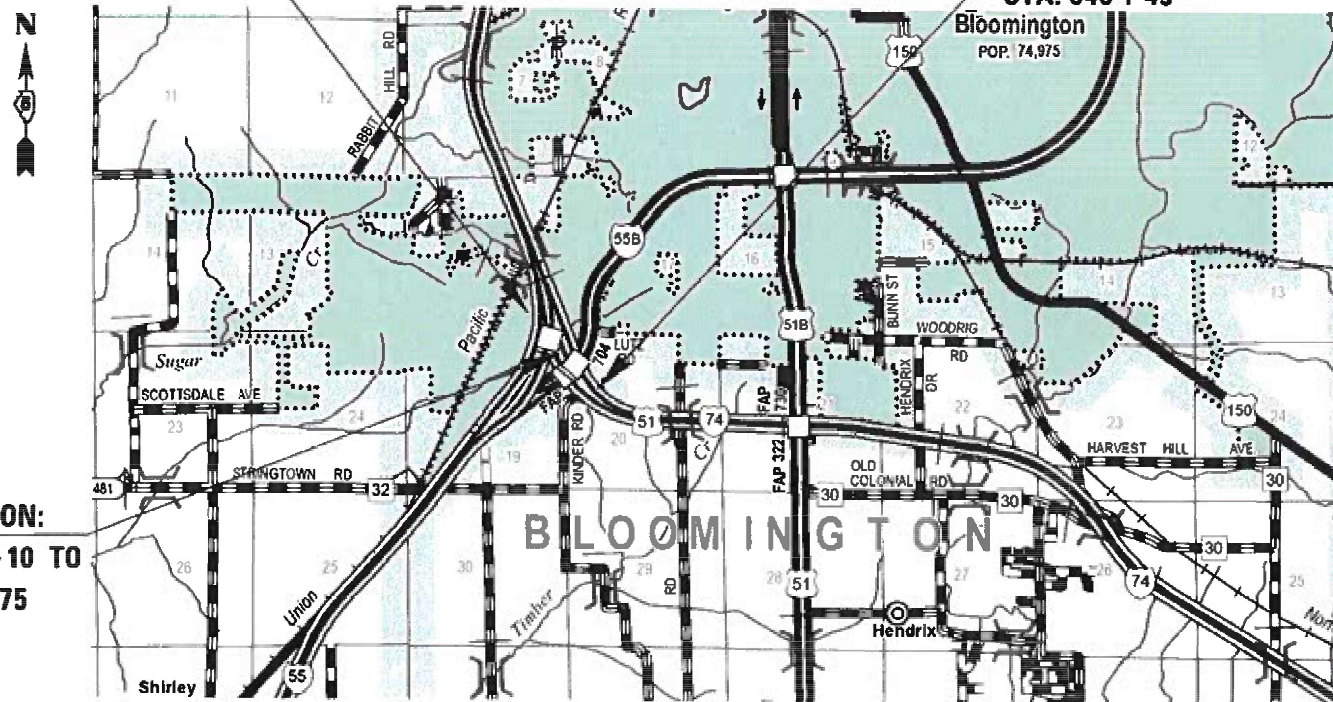

OMISSION:
STA. 631 + 10 TO
637 + 75

SCALE FOR MAIN MAP

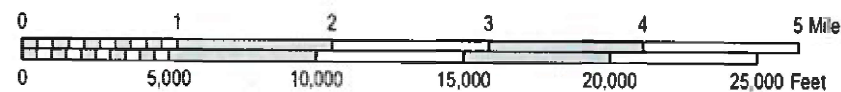

GROSS LENGTH = 1,295 FT. = 0.245 MILE
NET LENGTH = 630 FT. = 0.119 MILE

D-95-009-21

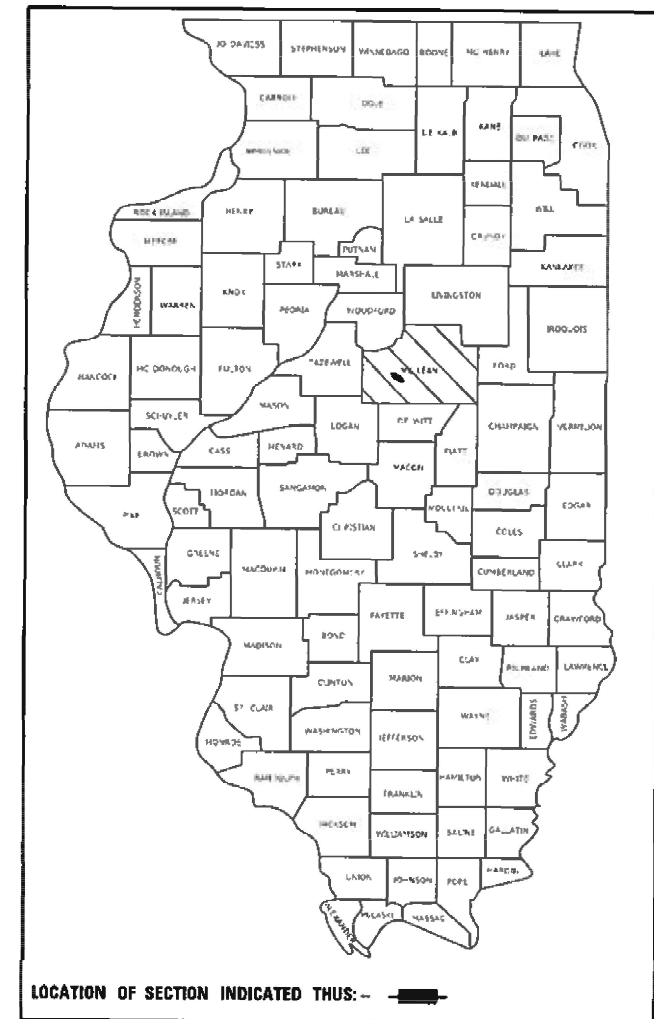

LOCATION OF SECTION INDICATED THUS: --

STATE OF ILLINOIS
DEPARTMENT OF TRANSPORTATION

SUBMITTED 1/14 2021
Kensil A. Garnett REGIONAL ENGINEER
March 19, 2021
Jason Stults ENGINEER OF DESIGN AND ENVIRONMENT
March 19, 2021
Jason Stults DIRECTOR OF HIGHWAYS PROJECT IMPLEMENTATION 13

PRINTED BY THE AUTHORITY
OF THE STATE OF ILLINOIS

INDEX OF SHEETS

SHEET NO.	DESCRIPTION
1	COVER SHEET
2	INDEX OF SHEET
2	LIST OF HIGHWAY STANDARDS
2	GENERAL NOTES
3	SUMMARY OF QUANTITIES
4	TYPICAL CROSS SECTION
5	SCHEDULE OF QUANTITIES
6	TEMPORARY RUMBLE STRIP (SPECIAL)
7	DISTRICT 5 DETAIL - PAVEMENT MARKING (INTERSTATE & MULTI-LANE APPLICATIONS)

HIGHWAY STANDARDS

STANDARD NO.	DESCRIPTION
000001-08	STANDARD SYMBOLS, ABBREVIATIONS AND PATTERNS
001006	DECIMAL OF AN INCH AND OF A FOOT
701400-10	APPROACH TO LANE CLOSURE, FREEWAY/EXPRESSWAY
701401-12	LANE CLOSURE, FREEWAY/EXPRESSWAY
701411-09	LANE CLOSURE, MULTILANE, AT ENTRANCE OR EXIT RAMP, FOR SPEEDS \geq 45 MPH
701426-09	LANE CLOSURE, MULTILANE, INTERMITTENT OR MOVING OPER., FOR SPEEDS \geq 45 MPH
701901-08	TRAFFIC CONTROL DEVICES

GENERAL NOTES

G.N.- 406H

Location	I-74
Mixture Use	Surface
AC/PG	SBS PG 70-22
Design Air Voids	4.0% @ Ndes=90
Mix Comp(Gradation)	IL 9.5
Friction Aggregate	Mix E
Mixture Weight	112
Quality Management Program	QC/QA
Sublot Size	N.A.

G.N.- 781

THE FINAL PAVEMENT MARKINGS SHALL BE IN PLACE PRIOR TO PLACING THE RAISED REFLECTIVE PAVEMENT MARKERS.

NO COMMITMENTS

MODEL: I:\MODEL\NAME: FILE NAME: P:\pub\mcom.mxd;dot:illinois.gov;PWIDOT\Documents\DOT_Offices\District 5\Projects\DS70F06\CAD\Drawings\CAD\Faces\DS70F06-ht-Cen\hloc.dwg

USER NAME = DietzCB	DESIGNED -	REVISED -	STATE OF ILLINOIS DEPARTMENT OF TRANSPORTATION	GENERAL NOTES, HIGHWAY STANDARDS, AND INDEX OF SHEETS	F.A.J RTE.	SECTION	COUNTY	TOTAL SHEETS	SHEET NO.
DRAWN -	REVISED -	74			CM21-5009	MCLEAN	7	2	
PLOT SCALE = 40,0000 */ in.	CHECKED -	REVISED -			CONTRACT NO. 70F06				
PLOT DATE = 1/14/2021	DATE -	REVISED -			ILLINOIS FED. AID PROJECT				
				SCALE:	SHEET 1	OF 1	SHEETS	STA.	TO STA.

SUMMARY OF QUANTITIES

LOCATION OF WORK: FAI 74 (I-74)

URBAN

INTERSTATE

STA. 627+50 TO STA. 637+50

MCLEAN COUNTY

FUNDING BREAKOUT: 100% STATE

CONSTRUCTION TYPE CODE: 0005

CODE NO.	ITEM	UNIT	TOTAL QUANTITY	
40600290	BITUMINOUS MATERIALS (TACK COAT)	POUND	770.00	770.00
40604174	POLYMERIZED HOT-MIX ASPHALT SURFACE COURSE, IL-9.5, MIX "E", N90	TON	144.00	144.00
44000155	HOT-MIX ASPHALT SURFACE REMOVAL, 1 1/2"	SQ YD	1,710.0	1,710.0
67100100	MOBILIZATION	L SUM	1.0	1.0
70100420	TRAFFIC CONTROL AND PROTECTION, STANDARD 701411	EACH	2.0	2.0
70100800	TRAFFIC CONTROL AND PROTECTION, STANDARD 701401	L SUM	1.00	1.00
70107025	CHANGEABLE MESSAGE SIGN	CAL DAY	10.0	10.0
70300100	SHORT TERM PAVEMENT MARKING	FOOT	63.0	63.0
70300150	SHORT TERM PAVEMENT MARKING REMOVAL	SQ FT	21.0	21.0
* 78000200	THERMOPLASTIC PAVEMENT MARKING - LINE 4"	FOOT	1,148.0	1,148.0
* 78100100	RAISED REFLECTIVE PAVEMENT MARKER	EACH	16.0	16.0
78300200	RAISED REFLECTIVE PAVEMENT MARKER REMOVAL	EACH	16.0	16.0
X2700001	TEMPORARY RUMBLE STRIPS (SPECIAL)	EACH	12.0	12.0
* X7830070	GROOVING FOR RECESSED PAVEMENT MARKING 5"	FOOT	1,148.0	1,148.0
* DENOTES SPECIALTY ITEM				

MODEL: I:\MODEL\MHFE
 FILE NAME: P:\pub\mcom\mca\dot\illinc\gov\pww\dot\Documents\DOT_Offices\District_5\Projects\0570\06\CADD\03\01\CAD\Faces\0570\06-ph-500.dgn

USER NAME = DietzCB	DESIGNED -	REVISED -
	DRAWN -	REVISED -
PLOT SCALE = 40,0000 */ in.	CHECKED -	REVISED -
PLOT DATE = 1/14/2021	DATE -	REVISED -

**STATE OF ILLINOIS
DEPARTMENT OF TRANSPORTATION**

SUMMARY OF QUANTITIES

SCALE: SHEET 1 OF 1 SHEETS STA. TO STA.

F.A.J. RTE.	SECTION	COUNTY	TOTAL SHEETS	SHEET NO.
74	CM21-5009	MCLEAN	7	3
CONTRACT NO. 70F06				
ILLINOIS FED. AID PROJECT				

SCHEDULE OF QUANTITIES

HOT-MIX ASPHALT INLAY

LOCATION	LANE	STATION	TO	STATION	LENGTH (FOOT)	WIDTH (FOOT)	AREA (SQ YD)	40600290 BITUMINOUS MATERIALS (TACK COAT) (POUND)	40604174 POLYMERIZED HMA SURFACE COURSE IL-9.5 MIX "E" N90** (TON)	44000155 HMA SURFACE REMOVAL 1 1/2" (SQ YD)
UNDER I-55 NB, SN 057-0250	EBDL	627+50		631+10	360	12	480	216.0	40.3	480
UNDER I-55B SB, SN 057-0251	EBDL	637+75		640+45	270	13	390	175.5	32.8	390
UNDER I-55 NB, SN 057-0250	EBPL	627+50		631+10	360	12	480	216.0	40.3	480
UNDER I-55B SB, SN 057-0251	EBPL	637+75		640+45	270	12	360	162.0	30.2	360
							TOTALS	769.5	143.6	1710.0
							ROUND	770.0	144.0	1710.0

*RATE FOR BITUMINOUS MATERIAL TACK COAT: 0.45 LBS/SQ YD
 **RATE FOR POLYMERIZED HMA SURFACE COURSE: 168 LBS/SQ YD

PAVEMENT MARKINGS

LOCATION	DESCRIPTION	STATION	TO	STATION	LENGTH (FOOT)	70300100 SHORT TERM PAVEMENT (FOOT)	70300150 SHORT TERM PAVEMENT (SQ FT)	78000200 THERMOPLASTIC PAVEMENT MARKING - LINE 4"			78100100 RAISED REFLECTIVE (EACH)	78300200 RAISED REFLECTIVE (EACH)	X7830070 GROOVING FOR RECESSED PVT (FOOT)
								YELLOW EDGE LINE (FOOT)	WHITE EDGE LINE (FOOT)	WHITE SKIP DASH (FOOT)			
UNDER I-55 NB, SN 057-0250	EBDL EDGE LINE	627+50		631+10	360				360.0				360.0
UNDER I-55 NB, SN 057-0250	EB CENTER SKIP DASH	627+50		631+10	360	36.0	12.0			90.0	10.0	10.0	90.0
UNDER I-55B SB, SN 057-0251	EB CENTER SKIP DASH	637+75		640+45	270	27.0	9.0			67.5	6.0	6.0	67.5
UNDER I-55 NB, SN 057-0250	EBPL EDGE LINE	627+50		631+10	360			360.0					360.0
UNDER I-55B SB, SN 057-0251	EBPL EDGE LINE	637+75		640+45	270			270.0					270.0
TOTALS						63.0	21.0	630.0	360.0	157.5	16.0	16.0	1147.5
ROUND						63.0	21.0	630.0	360.0	158.0	16.0	16.0	1148.0

TEMPORARY RUMBLE STRIPS

APPROX. LOCATION	LANE	X2700001 TEMPORARY RUMBLE STRIPS (SPECIAL) (EACH)
± 1.5 MI BEFORE TAPER	EB LEFT LANE	2.0
± 1.5 MI BEFORE TAPER	EB CENTER LANE	2.0
± 1.5 MI BEFORE TAPER	EB RIGHT LANE	2.0
± 3 MI BEFORE TAPER	EB LEFT LANE	2.0
± 3 MI BEFORE TAPER	EB CENTER LANE	2.0
± 3 MI BEFORE TAPER	EB RIGHT LANE	2.0
TOTAL		12.0

CHANGEABLE MESSAGE SIGN

DESCRIPTION	70107025 CHANGEABLE MESSAGE SIGN (EACH)
ADVANCE NOTICE	3.0
DURING CONSTRUCTION, ± 1.5 MI BEFORE TAPER	7.0
TOTAL	10.0

MODEL: \\MODEL\MNMFs
 FILE NAME: \\p14m\com\m.d\illinois.gov\PIWDOT\Documents\DOT_Offices\District 5\Projects\057006\CADD\057006_e-ht-Schedule.dgn

USER NAME = DietzCB	DESIGNED -	REVISED -
	DRAWN -	REVISED -
PLOT SCALE = 40,0000 * / in.	CHECKED -	REVISED -
PLOT DATE = 1/14/2021	DATE -	REVISED -

**STATE OF ILLINOIS
DEPARTMENT OF TRANSPORTATION**

SCHEDULE OF QUANTITIES

SCALE: SHEET 1 OF 1 SHEETS STA. TO STA.

F.A.J. RTE.	SECTION	COUNTY	TOTAL SHEETS	SHEET NO.
74	CM21-5009	MCLEAN	7	5
CONTRACT NO. 70F06				
ILLINOIS FED. AID PROJECT				

CENTERLINE INTERSTATE OR MULTI-LANE TWO WAY DIVIDED HIGHWAY

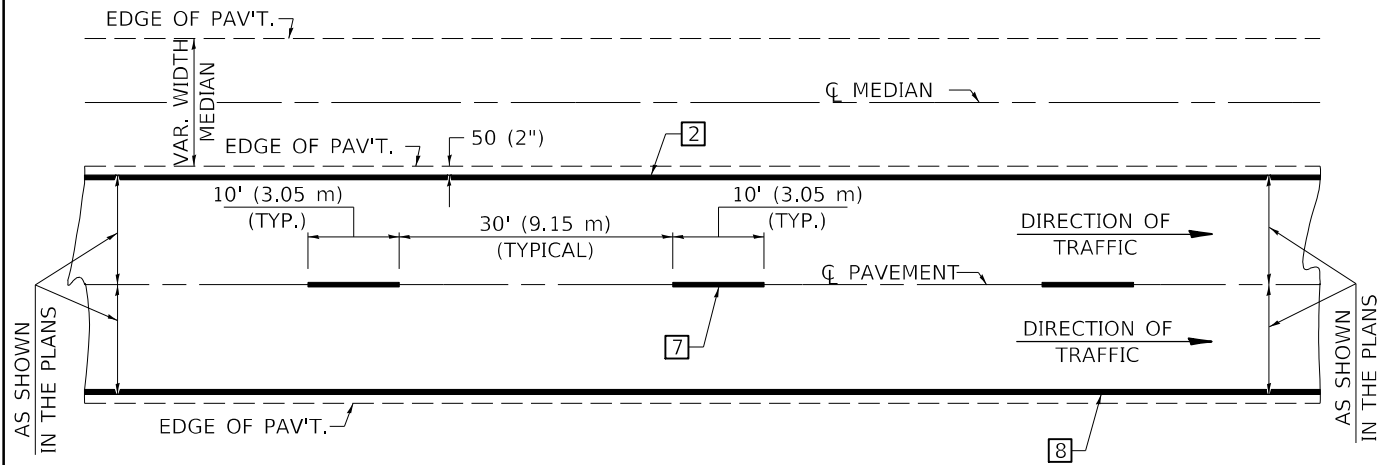

NOTE: PAVEMENT MARKINGS ARE TO BE EXTENDED THROUGH OMISSIONS WHEN APPLICABLE.

NOTE: SEE ARTICLES 780.04 & 781.03 FOR LOCATION OF STRIPES AND MARKERS RELATIVE TO EDGES OR JOINTS.

FOR RAISED REFLECTIVE PAVEMENT MARKERS, REFER TO STANDARD 781001.

TYPICAL PAVEMENT MARKING LEGEND

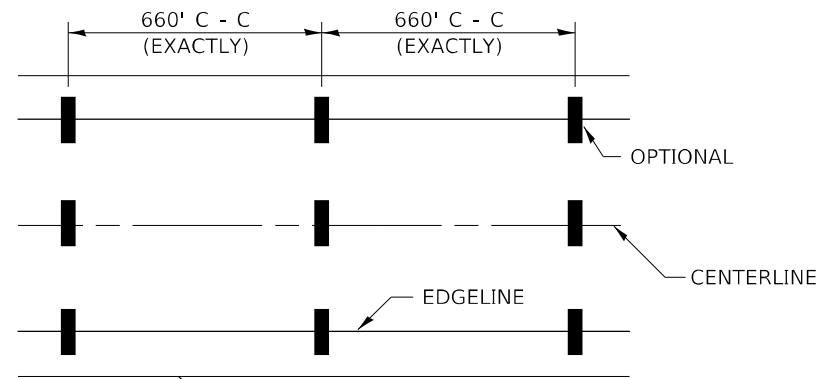

- 1 4" (100) SKIP-DASH (YELLOW)
- 2 4" (100) SOLID (YELLOW)
- 3 12" (300) DIAGONAL (YELLOW)
- 4 4" (100) DOUBLE YELLOW (NARROW)
- 5 RESERVED
- 6 RESERVED
- 7 4" (100) SKIP-DASH (WHITE)
- 8 4" (100) SOLID (WHITE)
- 9 12" (300) DIAGONAL (WHITE)
- 10 6" (150) SOLID (WHITE)
- 11 24" (600) STOP BAR (WHITE)
- 12 8" (200) SOLID (WHITE)
- 13 4" (100) LANE LINE EXTENSIONS (WHITE)

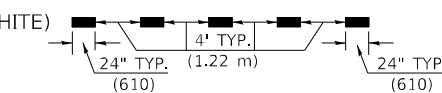
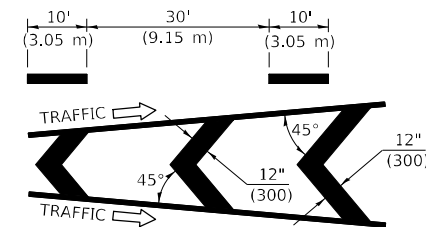
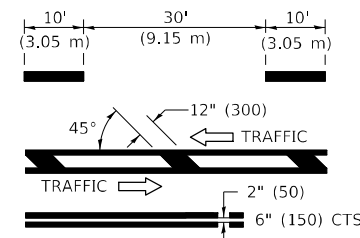

TYPICAL EXIT RAMP TERMINAL

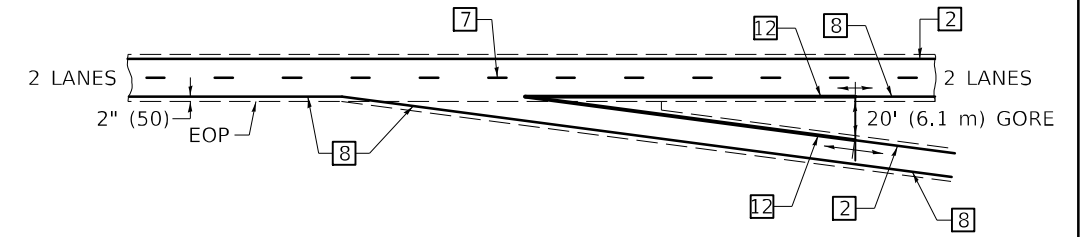

EXIT RAMP TERMINAL with EXCLUSIVE (auxiliary) LANE

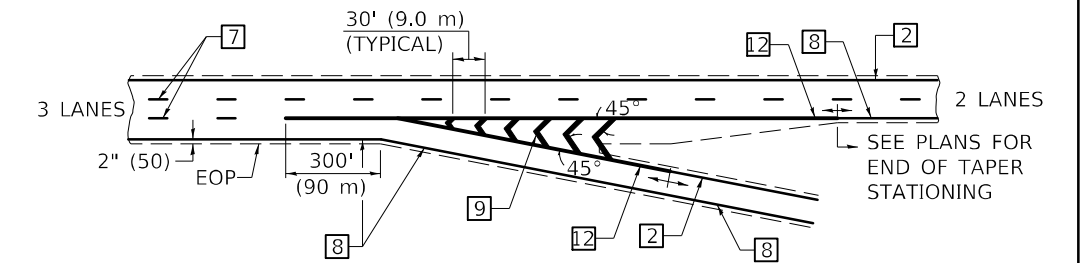

TYPICAL ENTRANCE RAMP TERMINAL

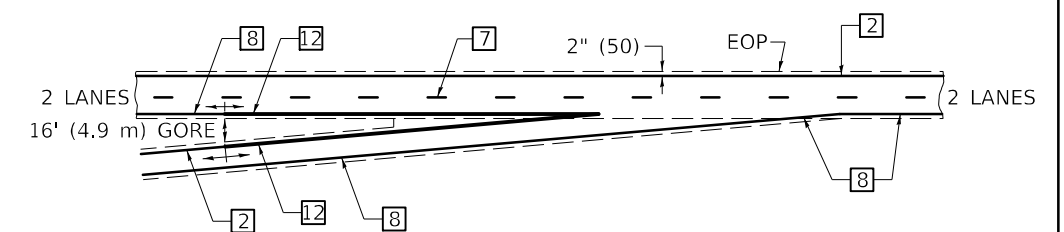

ENTRANCE RAMP TERMINAL with EXCLUSIVE LANE

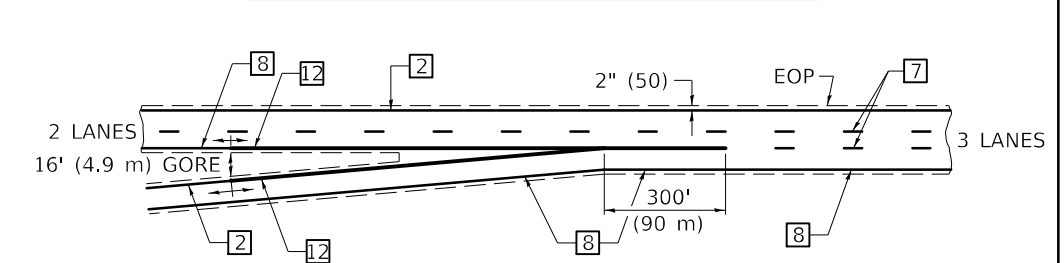

IT WILL BE NECESSARY TO HAVE A REPRESENTATIVE OF THE STATE POLICE PRESENT SO THAT THE ACCURACY OF MEASUREMENT CAN BE ATTESTED TO IN COURT.

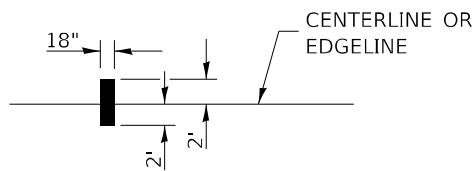

AERIAL SPEED CHECK ZONES

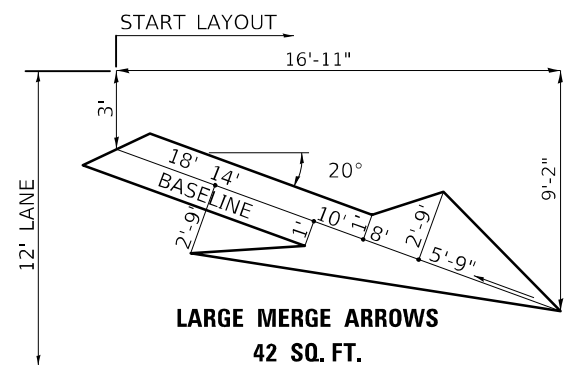

Note: All dimensions are in INCHES (millimeters) unless otherwise shown.

DISTRICT 5 DETAIL NO. 7800BBBB

USER NAME = DietzCB	DESIGNED -	REVISED - 11/06
	DRAWN -	REVISED -
PLOT SCALE = 40,0000 * / in.	CHECKED -	REVISED -
PLOT DATE = 1/14/2021	DATE -	REVISED -

**STATE OF ILLINOIS
DEPARTMENT OF TRANSPORTATION**

PAVEMENT MARKING (INTERSTATE & MULTI-LANE APPLICATIONS)

SCALE: SHEET 1 OF 1 SHEETS STA. TO STA.

F.A.I. RTE.	SECTION	COUNTY	TOTAL SHEETS	SHEET NO.
74	CM21-5009	MCLEAN	7	7
CONTRACT NO. 70F06				
ILLINOIS FED. AID PROJECT				

MODEL: I:\MODEL\MARKS FILE NAME: P:\pub\mcom\m.dot\illinc\gov\pww\DOT\Documents\DOT_Offices\Dist5\5\Projects\DS70F06\CAD\Process\DS70F06-PL-Drawn.dwg