

FOR INFORMATION ONLY

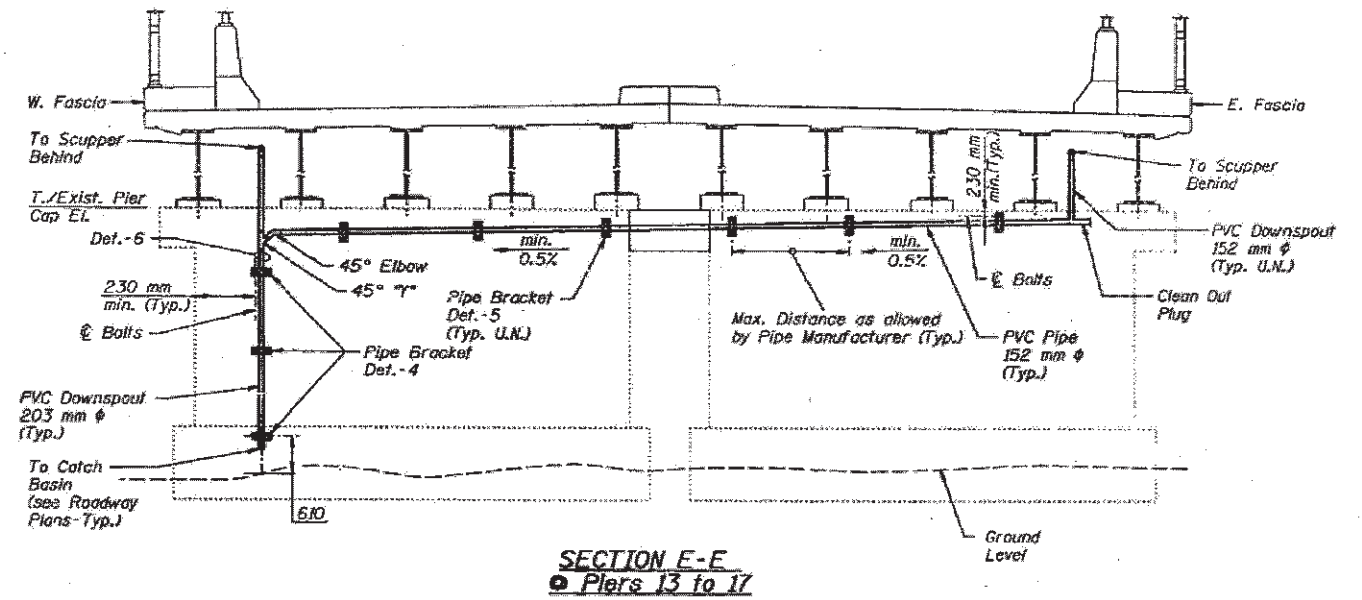
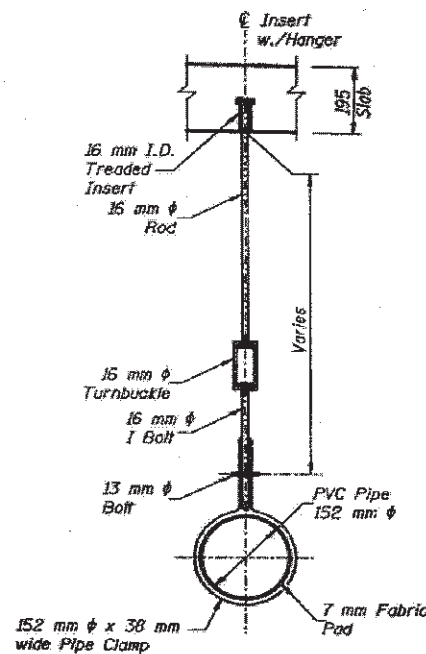
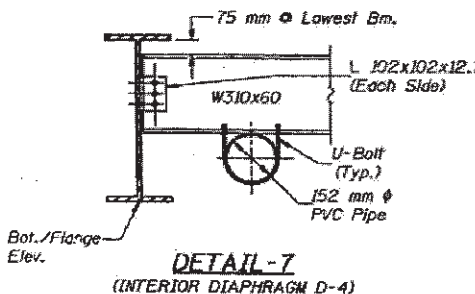
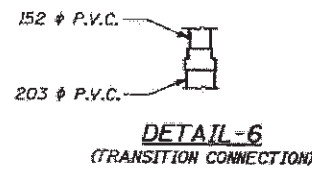
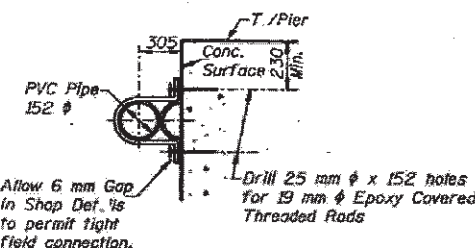
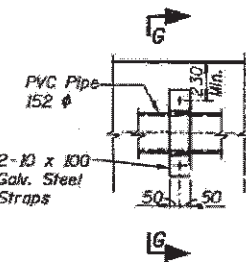
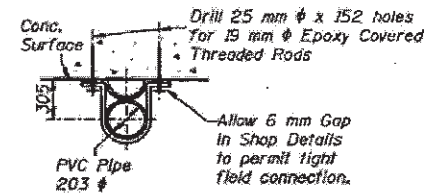
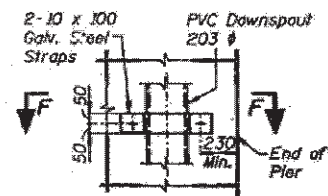
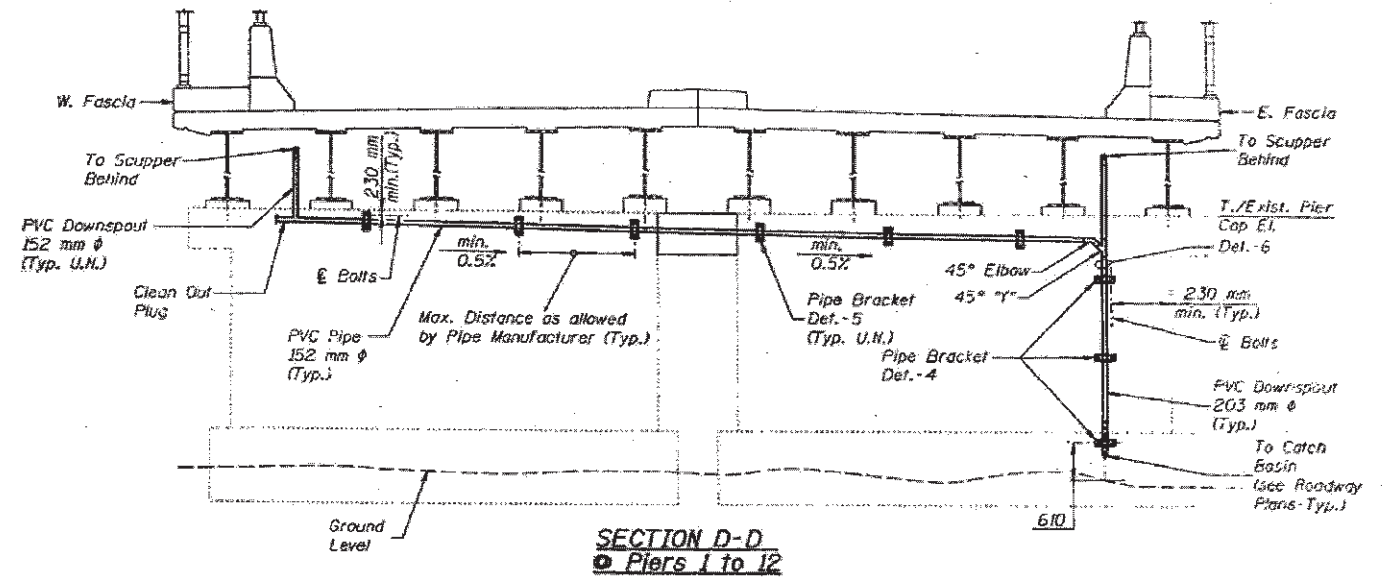
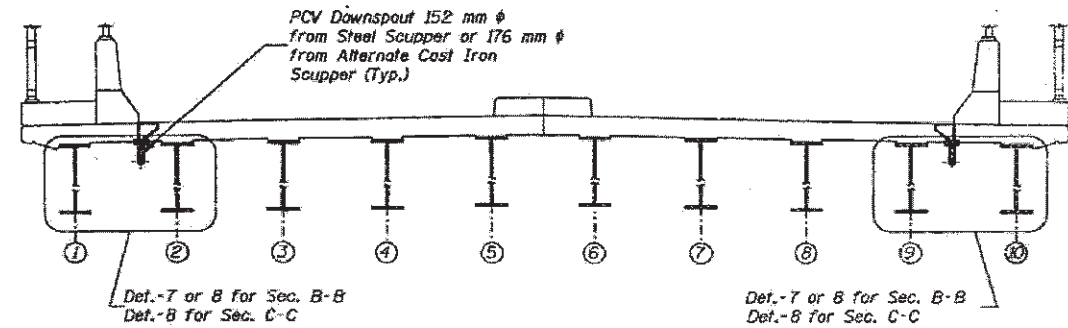

Note:
All Dimensions are in millimeters (mm), except as noted.

TYPICAL DRAINAGE SECTIONS & DETAILS

FILE NAME =	USER NAME = curryaw	DESIGNED -	REVISED -
c:\pwork\k\pvidot\curryaw\229691\013232-Design.dgn		DRAWN -	REVISED -
	PLOT SCALE = 100:0000	CHECKED -	REVISED -
	PLOT DATE = 3/2/2012	DATE -	REVISED -

STATE OF ILLINOIS
DEPARTMENT OF TRANSPORTATION

DRAINAGE REPAIRS
(SN 016-0337)

SCALE: SHEET 8 OF 8 SHEETS STA. TO STA.

*1) FAU 2612 2) FAP 330	F.A. RTE.	SECTION	COUNTY	TOTAL SHEETS	SHEET NO.
	*	2012-001-1	COOK	27	26
					CONTRACT NO. 60T31
ILLINOIS FED. AID PROJECT					