

**CENTERLINE INTERSTATE OR MULTI-LANE TWO WAY DIVIDED HIGHWAY**

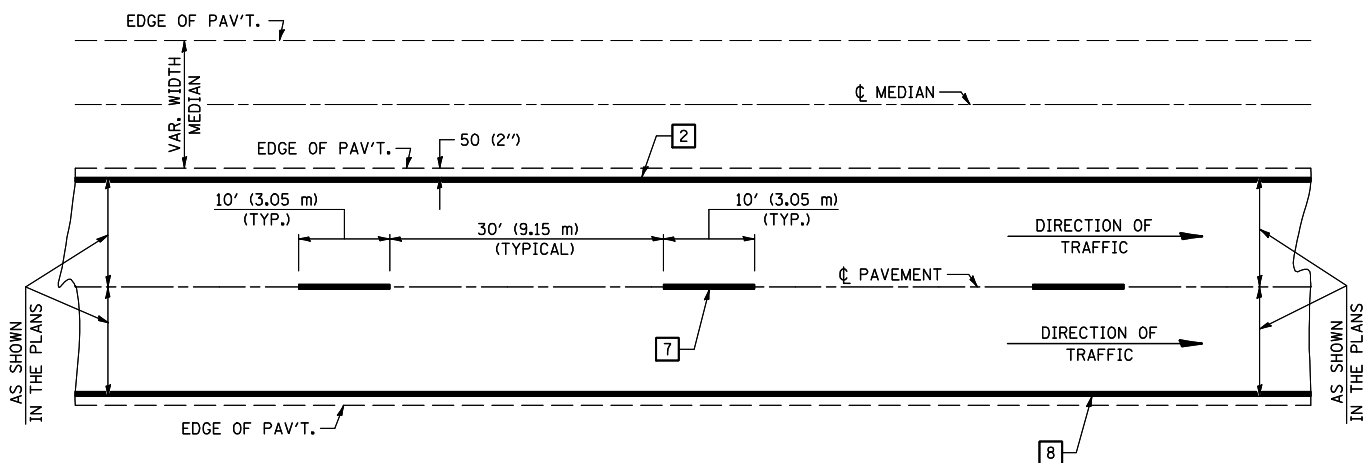

NOTE: PAVEMENT MARKINGS ARE TO BE EXTENDED THROUGH OMISSIONS WHEN APPLICABLE.

NOTE: SEE ARTICLES 780.04 & 781.03 FOR LOCATION OF STRIPES AND MARKERS RELATIVE TO EDGES OR JOINTS.

FOR RAISED REFLECTIVE PAVEMENT MARKERS, REFER TO STANDARD 781001.

**TYPICAL EXIT RAMP TERMINAL**

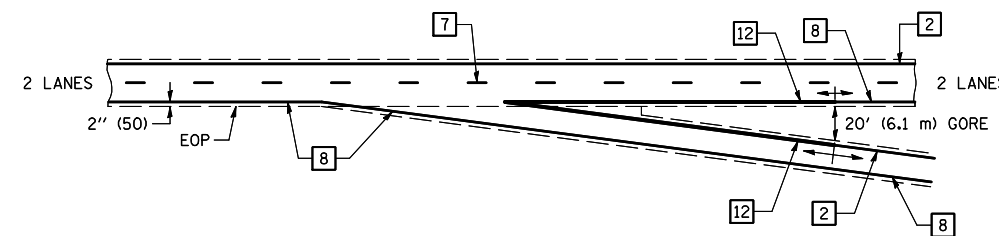

**EXIT RAMP TERMINAL with EXCLUSIVE (auxiliary) LANE**

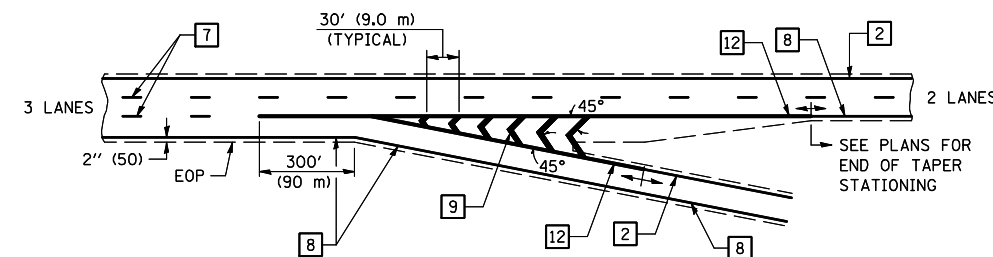

**TYPICAL ENTRANCE RAMP TERMINAL**

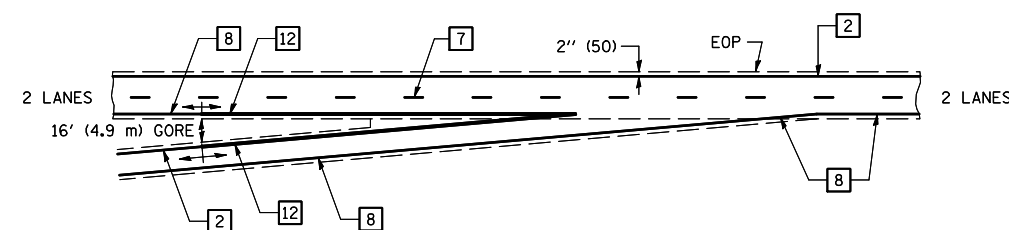

**ENTRANCE RAMP TERMINAL with EXCLUSIVE LANE**

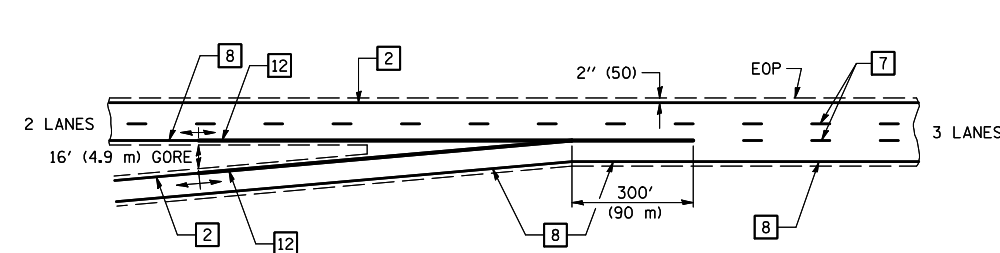

**TYPICAL PAVEMENT MARKING LEGEND**

- 1 4" (100) SKIP-DASH (YELLOW)
- 2 4" (100) SOLID (YELLOW)
- 3 12" (300) DIAGONAL (YELLOW)
- 4 4" (100) DOUBLE YELLOW (NARROW)
- 5 RESERVED
- 6 RESERVED
- 7 4" (100) SKIP-DASH (WHITE)
- 8 4" (100) SOLID (WHITE)
- 9 12" (300) DIAGONAL (WHITE)
- 10 6" (150) SOLID (WHITE)
- 11 24" (600) STOP BAR (WHITE)
- 12 8" (200) SOLID (WHITE)
- 13 4" (100) LANE LINE EXTENSIONS (WHITE)

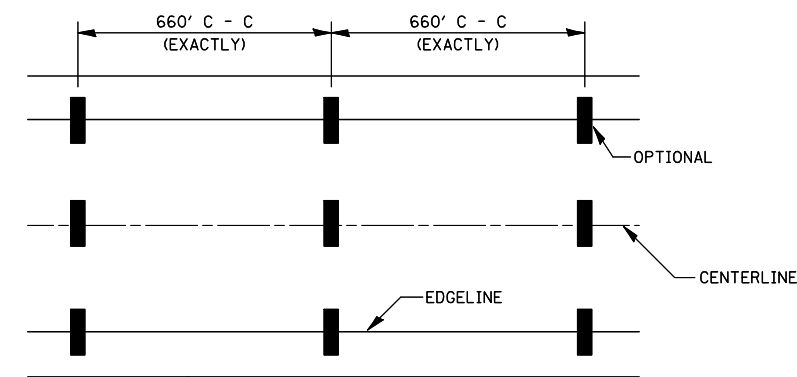
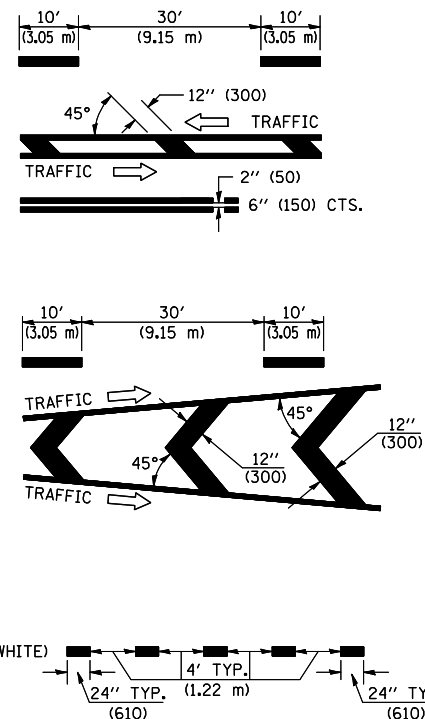

IT WILL BE NECESSARY TO HAVE A REPRESENTATIVE OF THE STATE POLICE PRESENT SO THAT THE ACCURACY OF MEASUREMENT CAN BE ATTESTED TO IN COURT.

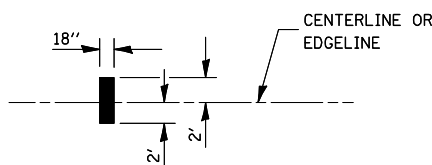

**AERIAL SPEED CHECK ZONES**

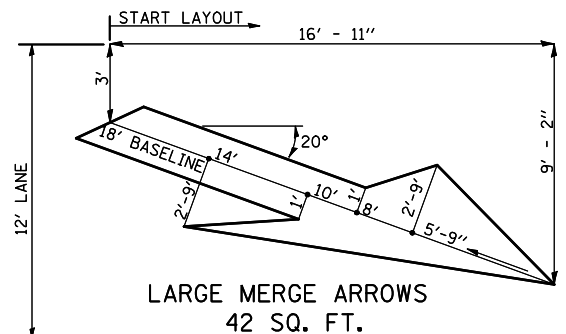

Note: All dimensions are in INCHES (millimeters) unless otherwise shown.

FILE NAME =	USER NAME = buckleeJJ	DESIGNED -	REVISED - 11/06
ct:\pw_work\pwork\backleeJJ\0253732\0570916-sht-details.dgn		DRAWN -	REVISED -
PLOT SCALE = 40.0000' / IN.		CHECKED -	REVISED -
PLOT DATE = 1/26/2011		DATE -	REVISED -

**STATE OF ILLINOIS  
DEPARTMENT OF TRANSPORTATION**

**PAVEMENT MARKING (INTERSTATE & MULTI-LANE APPLICATIONS)**

SCALE: SHEET NO. OF SHEETS STA. TO STA.

**DISTRICT 5 DETAIL NO. 7800BBBB**

F.A.I. RTE.	SECTION	COUNTY	TOTAL SHEETS	SHEET NO.
74	10(5-1-RS-1, 14-1,6)I	CHAMPAIGN	15	15
FED. ROAD DIST. NO. ILLINOIS FED. AID PROJECT			CONTRACT NO. 70619	