

DEAD LOAD DEFLECTIONS

Notes:
24% of dead load deflection in span (13-14) and 29% of dead load deflection in span (14-15) is due to the weight of structural steel.
Dead load deflection includes weight of structural steel, concrete slab, and barrier curbs.
Negative values indicate upward deflection.

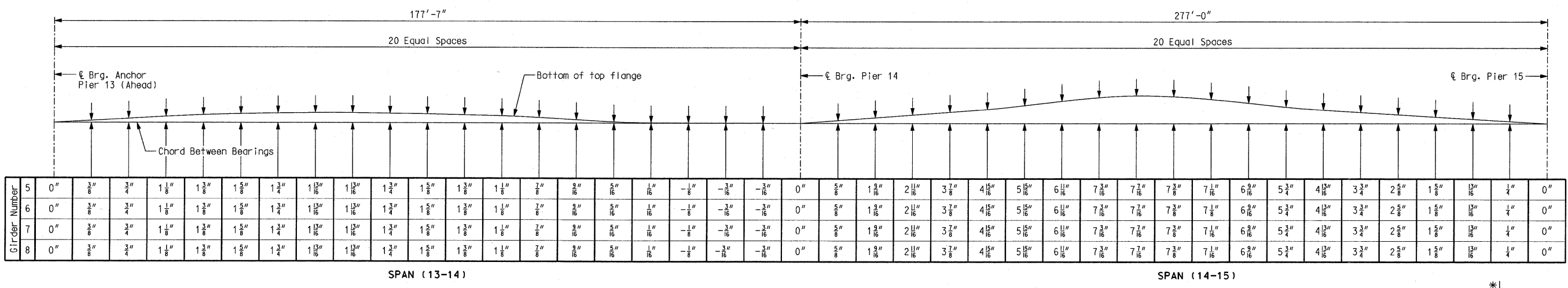

CAMBER DIAGRAM

Notes:
Camber includes allowance for dead load deflection due to concrete slab, curbs, and structural steel.
Positive values are above the chord between bents and negative values are below the chord between bents.

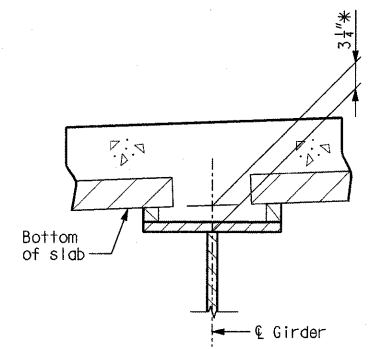

* Dimensions may vary if the girder camber after erection differs from plan camber by more or less than the % of Dead Load Deflection due to weight of structural steel. No payment will be made for any adjustment in forming or additional concrete required for variation in haunching.

THEORETICAL SLAB HAUNCH

DEAD LOAD DEFLECTIONS AND CAMBER DIAGRAM EB - UNIT 1 (1 OF 2)