

F.A.U. RTE.	SECTION	COUNTY	TOTAL SHEETS	SHEET NO.
3578	3178 RS-2	COOK	27	1
FED. ROAD DIST. NO.		ILLINOIS	CONTRACT NO. 60G82	

D-91-538-09

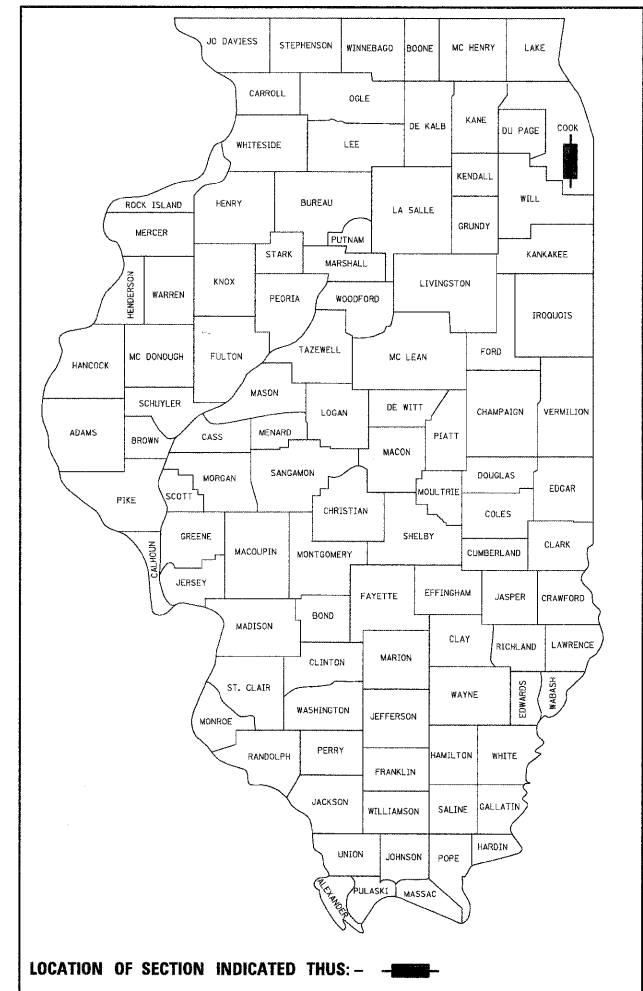

STATE OF ILLINOIS  
DEPARTMENT OF TRANSPORTATION  
DIVISION OF HIGHWAYS

SUBMITTED APRIL 21 2009

*Diane M. O'Keefe*  
DEPUTY DIRECTOR OF HIGHWAYS, REGION ENGINEER

May 1, 2009  
*Charles J. Ingersoll*  
ENGINEER OF DESIGN AND ENVIRONMENT

May 1, 2009  
*Christine M. Reed*  
DIRECTOR OF HIGHWAYS, CHIEF ENGINEER

PRINTED BY THE AUTHORITY  
OF THE STATE OF ILLINOIS

LOWCO, INC.  
CONSULTING ENGINEERS  
1560 WALL ST., SUITE 222  
NAPERVILLE, ILLINOIS 60563 PH: (630) 577-9100

WILLIAM H. BEPko  
062-047827  
REGISTERED  
PROFESSIONAL  
ENGINEER  
*W. H. Beppo*  
Expires 11-30-09

STATE OF ILLINOIS  
DEPARTMENT OF TRANSPORTATION  
DIVISION OF HIGHWAYS

PROPOSED  
HIGHWAY PLANS

FAU ROUTE 3578 (COLUMBUS DRIVE)  
WESTERN AVENUE TO 87TH STREET

SECTION: 3178 RS-2

RESURFACING (3P)

COOK COUNTY  
C-91-538-09

PROJECT LOCATED IN  
THE CITY OF CHICAGO

FOR INDEX OF SHEETS, SEE SHEET NO. 2

ADT 15100 (2006)  
SPEED LIMIT 30 MPH

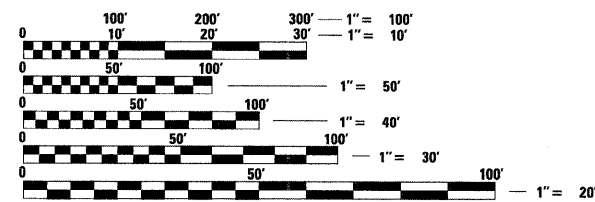

FULL SIZE PLANS HAVE BEEN PREPARED USING STANDARD ENGINEERING SCALES. REDUCED SIZED PLANS WILL NOT CONFORM TO STANDARD SCALES. IN MAKING MEASUREMENTS ON REDUCED PLANS, THE ABOVE SCALES MAY BE USED.

C.U.A.N.  
CHICAGO UTILITY ALERT NETWORK  
1-312-744-7000

PROJECT MANAGER: RAJENDRA C. SHAH (847) 705-4555  
PROJECT ENGINEER: ERSKINE W. KLYCE (847) 705-4594

CONTRACT NO. 60G82



PROJECT ENDS  
STA. 149 + 42

PROJECT BEGINS  
STA. 10 + 00

LOCATION SKETCH

NET AND GROSS LENGTH OF PROJECT = 13,942' = 2.641 MI

INDEX OF SHEETS

STATE STANDARDS

PLAN NOTES

<u>SHEET NO.</u>	<u>DESCRIPTION</u>
1	TITLE SHEET
2	INDEX OF SHEETS, STATE STANDARDS, GENERAL NOTES AND MIX SCHEDULE
3	SUMMARY OF QUANTITIES
4	EXISTING AND PROPOSED TYPICAL SECTIONS
5-9	ROADWAY AND PAVEMENT MARKING PLANS
10	DRIVEWAY DETAILS - DISTANCE BETWEEN R.O.W. AND CURB OR EDGE GREATER THAN OR EQUAL TO 15' (4.5m)
11	DRIVEWAY DETAILS - DISTANCE BETWEEN R.O.W. AND FACE OF CURB IS LESS THAN 15' (4.5m)
12	DETAILS FOR FRAMES AND LIDS ADJUSTMENT WITH MILLING
13	CITY OF CHICAGO PC CONC DRIVEWAY, ALLEY RETURN AND SIDEWALK
14	PAVEMENT PATCHING FOR HMA SURFACED PAVEMENT
15	CURB OR CURB AND GUTTER REMOVAL AND REPLACEMENT
16	BUTT JOINT AND HMA TAPER DETAILS
17	TRAFFIC CONTROL AND PROTECTION FOR SIDE ROADS, INTERSECTIONS, AND DRIVEWAYS
18	TYPICAL APPLICATIONS RAISED REFLECTIVE PAVEMENT MARKERS (SNOW-PLOW RESISTANT)
19	DISTRICT ONE TYPICAL PAVEMENT MARKINGS
20	TRAFFIC CONTROL AND PROTECTION AT TURN BAYS (TO REMAIN OPEN TO TRAFFIC)
21	PAVEMENT MARKING LETTERS AND SYMBOLS FOR TRAFFIC STAGING
22	TRAFFIC CONTROL FOR SHOULDER CLOSURES AND PARTIAL RAMP CLOSURES
23	SIGNING FOR FLAGGING OPERATIONS AT WORK ZONE OPENINGS
24	ARTERIAL ROAD INFORMATION SIGN
25	SIGNING AND PAVEMENT MARKINGS TREATMENT FOR RAILROAD CROSSINGS
26	DRIVEWAY ENTRANCE SIGNING
27	DETECTOR LOOP INSTALLATION DETAIL FOR ROADWAY RESURFACING

<u>STANDARD NO.</u>	<u>DESCRIPTION</u>
000001-06	STANDARD SYMBOLS, ABBREVIATIONS AND PATTERNS
424001-05	CURB RAMPS FOR SIDEWALKS
442201-03	CLASS C AND D PATCHES
606001-04	CONCRETE CURB TYPE B AND COMBINATION CONCRETE CURB AND GUTTER
606301-04	PC CONCRETE ISLANDS AND MEDIANS
606306-03	CORRUGATED PC CONCRETE MEDIANS
642001-01	SHOULDER RUMBLE STRIPS
701006-03	OFF-RD OPERATIONS, 2L, 2W, MORE THAN 15' (4.5 M) TO 24" (600MM) FROM PAVEMENT EDGE
701011-02	OFF-RD MOVING OPERATIONS, 2L, 2W, DAY ONLY
701101-02	OFF-RD OPERATIONS, MULTILANE, 15' (4.5 M) TO 24" (600MM) FROM PAVEMENT EDGE
701301-03	LANE CLOSURE, 2L, 2W, SHORT TIME OPERATIONS
701311-03	LANE CLOSURE, 2L, 2W, MOVING OPERATIONS-DAY ONLY
701426-03	LANE CLOSURE, MULTILANE, INTERMITTENT OR MOVING OPERATIONS FOR SPEEDS LESS THAN 45 MPH
701501-05	URBAN LANE CLOSURE, 2L, 2W, UNDIVIDED
701601-06	URBAN LANE CLOSURE, MULTILANE, 1W OR 2W WITH NONTRAVERSABLE MEDIAN
701606-06	URBAN LANE CLOSURE, MULTILANE, 2W WITH MOUNTABLE MEDIAN
701701-06	URBAN LANE CLOSURE, MULTILANE INTERSECTION
701801-04	LANE CLOSURE MULTILANE 1W OR 2W CROSSWALK OR SIDEWALK CLOSURE
701901-01	TRAFFIC CONTROL DEVICES
886001-01	DETECTOR LOOP INSTALLATIONS

BEFORE STARTING ANY EXCAVATION, THE CONTRACTOR SHALL CALL "C.U.A.N." AT 1-312-744-7000 FOR FIELD LOCATIONS OF BURIED ELECTRIC, TELEPHONE AND GAS FACILITIES. (48 HOUR NOTIFICATION IS REQUIRED)

THE CONTRACTOR SHALL COORDINATE CONSTRUCTION ACTIVITIES WITH UTILITY COMPANIES WITHIN THE CITY OF CHICAGO.

THE CONTRACTOR WILL NOT BE ALLOWED TO SET UP A YARD OF FIELD OFFICE ON STATE PROPERTY WITHOUT WRITTEN PERMISSION FROM THE DEPARTMENT.

BUTT JOINTS WILL BE INSTALLED AT THE ENDS OF ALL RESURFACING (WHERE RESURFACING MEETS EXISTING PAVEMENT). IN ACCORDANCE WITH THE "BUTT JOINT AND HOT-MIX ASPHALT TAPER DETAILS" SHEETS INCLUDED ON THE PLANS. UNLESS OTHERWISE SPECIFIED.

THE RESIDENT ENGINEER SHALL CONTACT MS. PATRICE HARRIS AREA TRAFFIC FIELD ENGINEER AT (708) 597-9800 A MINIMUM OF 2 WEEKS PRIOR TO PLACEMENT OF PERMANENT PAVEMENT MARKING.

10 FEET (3 METERS) TRANSITION SHALL BE USED TO MATCH PROPOSED CURB AND GUTTER TO EXISTING CURB AND GUTTERS IN THE FIELD, UNLESS OTHERWISE SHOWN. THE TRANSITION SHALL BE PAID FOR AT THE CONTRACT UNIT PRICE FOR THE PROPOSED ITEMS OR WORK SPECIFIED.

WHEN MILLED PAVEMENT IS OPEN TO TRAFFIC THE MAXIMUM GRADE DIFFERENTIAL BETWEEN PASSES OF THE MILLING MACHINE SHALL NOT EXCEED 1/2 INCHES (40MM) WHERE THE SPEED LIMIT IS 45 MPH (80 KM/H) OR LESS AND 1 INCH (25MM) WHERE THE SPEED LIMIT IS GREATER THAN 45 MPH (80 KM/H). WITH WRITTEN APPROVAL FROM THE ENGINEER, A MAXIMUM GRADE DIFFERENTIAL OF 3 INCHES (75MM) MAY BE ALLOWED IF THE EDGE OF THE MILLING IS SLOPED A MINIMUM 1:3 (V:H).

STATE STANDARDS

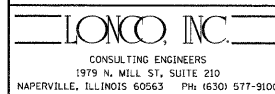

USER NAME = #USER#	DESIGNED - MJY	REVISED -
PLOT SCALE = #SCALE#	DRAWN - ZDA	REVISED -
PLOT DATE = #DATE#	CHECKED - MJY	REVISED -
	DATE - 04/22/2009	REVISED -

STATE OF ILLINOIS  
DEPARTMENT OF TRANSPORTATION

INDEX OF SHEETS, STATE STANDARDS, AND GENERAL NOTES  
COLUMBUS DRIVE

SCALE: NONE SHEET NO. 2 OF 27 SHEETS STA. 10+00 TO STA. 149+42

F.A.U. RTE.	SECTION	COUNTY	TOTAL SHEETS	SHEET NO.
3578	3178 RS-2	COOK	27	2
C-91-538-09			CONTRACT NO. 60682	
FED. ROAD DIST. NO.		ILLINOIS FED. AID PROJECT		

SUMMARY OF QUANTITIES			URBAN	CONSTRUCTION TYPE CODE		SUMMARY OF QUANTITIES			URBAN	CONSTRUCTION TYPE CODE	
CODE NO.	ITEM	UNIT	TOTAL QUANTITIES	1000 100% STATE		CODE NO.	ITEM	UNIT	TOTAL QUANTITIES	1000 100% STATE	
40600200	BITUMINOUS MATERIALS (PRIME COAT)	TON	68.4	68.4		70300100	SHORT-TERM PAVEMENT MARKING	FOOT	4100	4100	
40600400	MIXTURE FOR CRACKS, JOINTS, AND FLANGWAYS	TON	56	56		70300210	TEMPORARY PAVEMENT MARKING - LETTERS AND SYMBOLS	SQ FT	968.4	968.4	
40600895	CONSTRUCTING TEST STRIP	EACH	2	2		70300220	TEMPORARY PAVEMENT MARKING - LINE 4"	FOOT	39204	39204	
40600982	HOT-MIX ASPHALT SURFACE REMOVAL - BUTT JOINT	SQ YD	5866	5866		70300240	TEMPORARY PAVEMENT MARKING - LINE 6"	FOOT	1248	1248	
40601005	HOT-MIX ASPHALT REPLACEMENT OVER PATCHES	TON	2284	2284		70300250	TEMPORARY PAVEMENT MARKING - LINE 8"	FOOT	92	92	
40603340	HOT-MIX ASPHALT SURFACE COURSE, MIX "D", N70	TON	7554	7554		70300260	TEMPORARY PAVEMENT MARKING - LINE 12"	FOOT	106	106	
42001300	PROTECTIVE COAT	SQ YD	558	558		70300280	TEMPORARY PAVEMENT MARKING - LINE 24"	FOOT	1816	1816	
44000158	HOT-MIX ASPHALT SURFACE REMOVAL, 2 1/4"	SQ YD	96056	96056		70301000	WORK ZONE PAVEMENT MARKING REMOVAL	SQ FT	18460	18460	
44001700	COMBINATION CONCRETE CURB AND GUTTER REMOVAL AND REPLACEMENT	FOOT	300	300		* 78000100	THERMOPLASTIC PAVEMENT MARKING - LETTERS AND SYMBOLS	SQ FT	968.4	968.4	
44002216	HOT-MIX ASPHALT REMOVAL OVER PATCHES, 4"	SQ YD	2913	2913		* 78000200	THERMOPLASTIC PAVEMENT MARKING - LINE 4"	FOOT	39204	39204	
44201765	CLASS D PATCHES, TYPE II, 10 INCH	SQ YD	1267	1267		* 78000400	THERMOPLASTIC PAVEMENT MARKING - LINE 6"	FOOT	1248	1248	
44201769	CLASS D PATCHES, TYPE III, 10 INCH	SQ YD	1320	1320		* 78000500	THERMOPLASTIC PAVEMENT MARKING - LINE 8"	FOOT	92	92	
44201771	CLASS D PATCHES, TYPE IV, 10 INCH	SQ YD	326	326		* 78000600	THERMOPLASTIC PAVEMENT MARKING - LINE 12"	FOOT	106	106	
55039700	STORM SEWERS TO BE CLEANED	FOOT	1280	1280		* 78000650	THERMOPLASTIC PAVEMENT MARKING - LINE 24"	FOOT	1816	1816	
60250200	CATCH BASINS TO BE ADJUSTED	EACH	8	8		* 78100100	RAISED REFLECTIVE PAVEMENT MARKER	EACH	1611	1611	
60255500	MANHOLES TO BE ADJUSTED	EACH	12	12		X0322256	TEMPORARY INFORMATION SIGNING	SQ FT	528	528	
60260100	INLETS TO BE ADJUSTED	EACH	10	10		X4067107	POLYMERIZED LEVELING BINDER (MACHINE METHOD), IL-4.75, N50	TON	3778	3778	
60300105	FRAMES AND GRATES TO BE ADJUSTED	EACH	27	27		Z0018500	DRAINAGE STRUCTURES TO BE CLEANED	EACH	8	8	
60300310	FRAMES AND LIDS TO BE ADJUSTED (SPECIAL)	EACH	96	96		Z0048665	RAILROAD PROTECTIVE LIABILITY INSURANCE	L SUM	1	1	
67000400	ENGINEER'S FIELD OFFICE, TYPE A	CAL MO	5	5							
67100100	MOBILIZATION	L SUM	1	1							
70102625	TRAFFIC CONTROL AND PROTECTION, STANDARD 701606	L SUM	1	1							
70102630	TRAFFIC CONTROL AND PROTECTION, STANDARD 701601	L SUM	1	1							
70102635	TRAFFIC CONTROL AND PROTECTION, STANDARD 701701	L SUM	1	1							
70102640	TRAFFIC CONTROL AND PROTECTION, STANDARD 701801	L SUM	1	1							
70106800	CHANGEABLE MESSAGE SIGN	CAL MO	4	4							

\*Specialty Items



USER NAME = #USER#	DESIGNED - MJY	REVISIONS
PLOT SCALE = #SCALE#	DRAWN - RJG	REVISIONS
PLOT DATE = #DATE#	CHECKED - MJY	REVISIONS
	DATE - 04/22/2009	REVISIONS

STATE OF ILLINOIS  
DEPARTMENT OF TRANSPORTATION

SUMMARY OF QUANTITIES  
COLUMBUS DRIVE

SCALE: NONE	SHEET NO. 3 OF 17 SHEETS	STA. 37+24 TO STA. 37+60	F.A.U. RTE. 3578	SECTION 3178 RS-2	COUNTY COOK	TOTAL SHEETS 27	SHEET NO. 3
			C-91-538-09		CONTRACT NO. 60682		
			FED. ROAD DIST. NO. ILLINOIS FED. AID PROJECT				

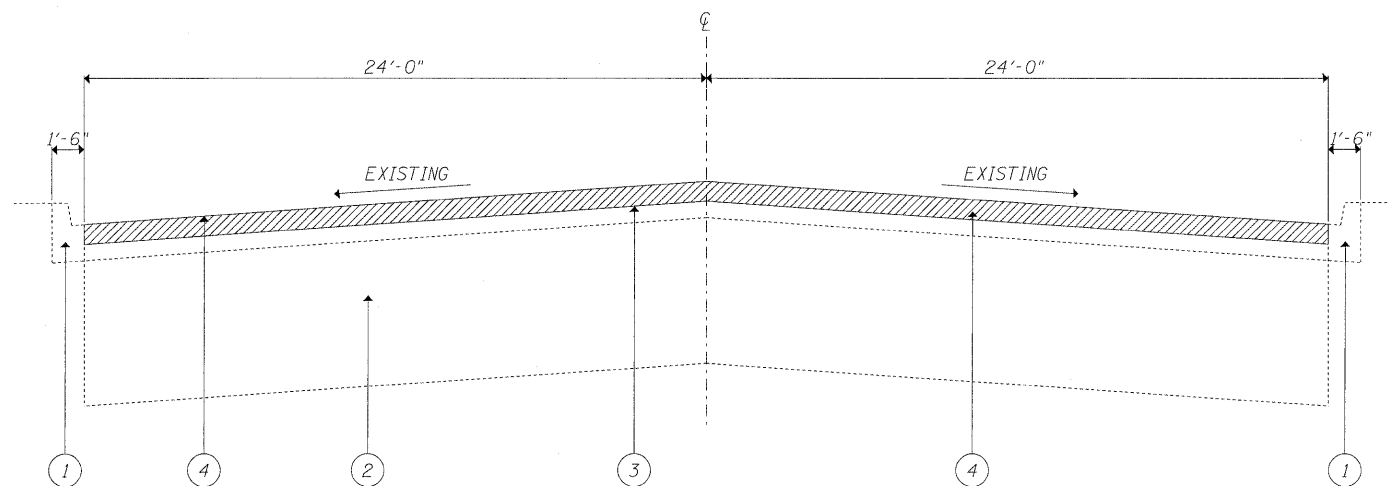

EXISTING TYPICAL SECTION

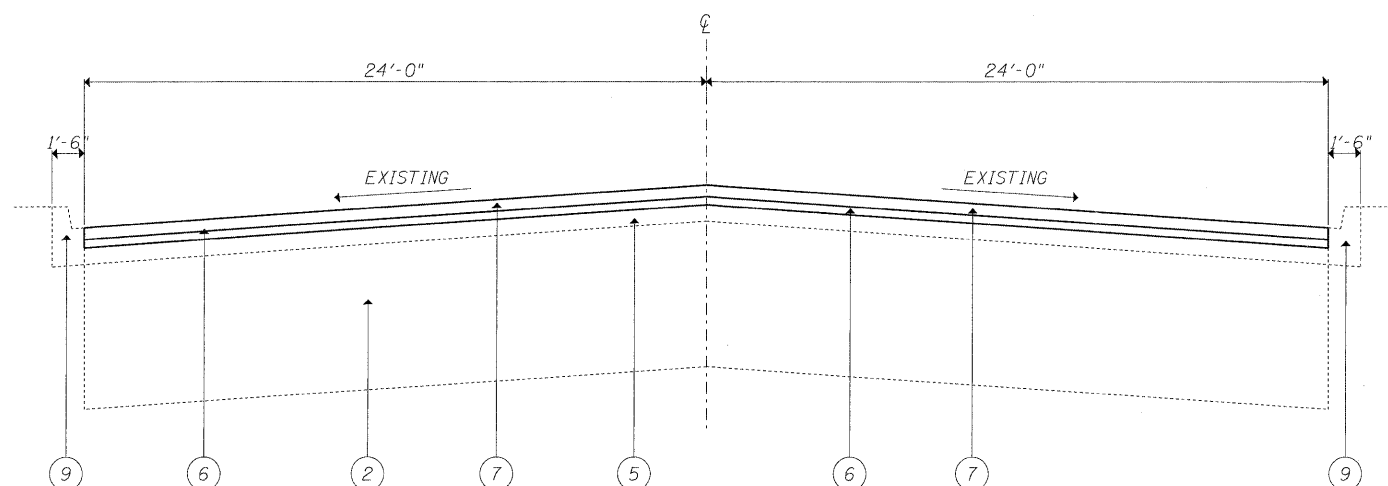

PROPOSED TYPICAL SECTION

**LEGEND**

- ① EXISTING CONCRETE CURB AND GUTTER
- ② EXISTING P.C. CONCRETE PAVEMENT +/- 9"
- ③ EXISTING HMA SURFACE COURSE +/- 4 1/2"
- ④ PROPOSED HMA SURFACE REMOVAL (2 1/4")
- ⑤ EXISTING HMA SURFACE OVERLAY AFTER MILLING, +/- 2"
- ⑥ PROPOSED POLYMERIZED LEVELING BINDER (MACHINE METHOD) IL-4.75, N50 (3/4")
- ⑦ PROPOSED HMA SURFACE COURSE, MIX "D", N70 (1 1/2")
- ⑧ PROPOSED HMA SURFACE REMOVAL (1 1/2")
- ⑨ PROPOSED CONCRETE CURB AND GUTTER IN LOCATIONS DIRECTED BY THE ENGINEER

HOT-MIX ASPHALT MIXTURE REQUIREMENTS		
MIXTURE TYPE	AC/PG	DESIGN AIR VOIDS
HMA SURFACE COURSE, MIX D, N70. (IL-9.5 mm)	PG 64-22	4% @ 70 GYR
POLYMERIZED LEVELING BINDER (MACHINE METHOD), IL-4.75, N50	SBS-SBR PG 76-28/22	4% @ 50 GYR
CLASS D PATCHES (HMA BINDER IL 19 mm)	PG 64-22*	4% @ 70 GYR
HMA REPLACEMENT OVER PATCHES (HMA BINDER IL 19 mm)	PG 64-22*	4% @ 70 GYR

**NOTE:**

- 1: THE UNIT WEIGHT USED TO CALCULATE ALL HMA SURFACE COURSE MIXTURES IS 112 LBS/SOYD/IN. \*WHEN RAP EXCEEDS 20%. THE NEW ASPHALT BINDER IN THE MIX SHALL BE PG 58-22
- 2: THE CONTRACTOR SHALL PATCH FIRST BEFORE MILLING
- 3: SHOULDER WIDENING GREATER THAN 4' AT VARIOUS LOCATIONS WITHIN THE LIMITS OF IMPROVEMENT

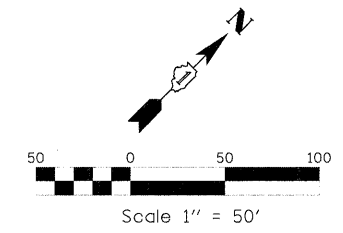
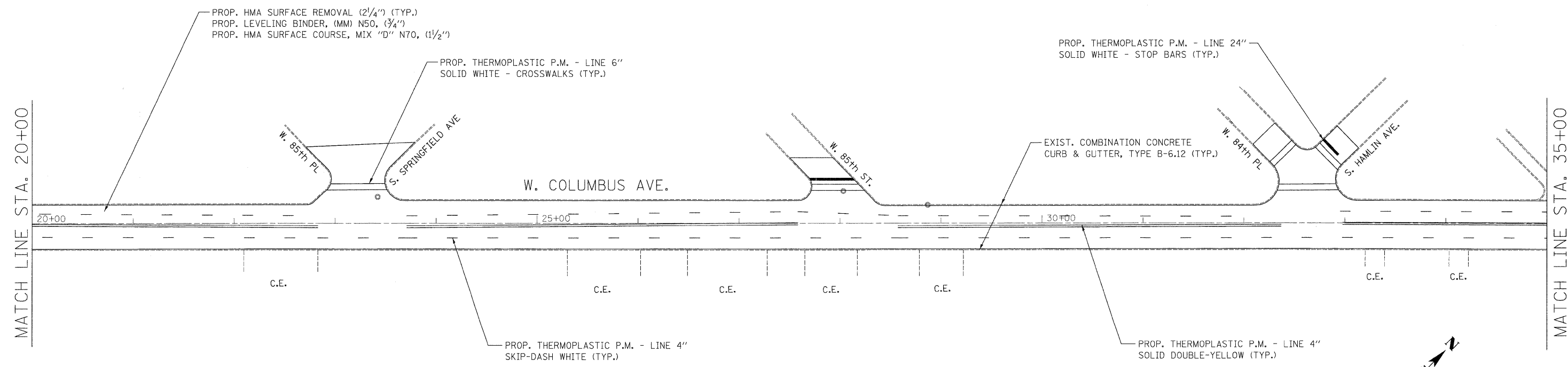
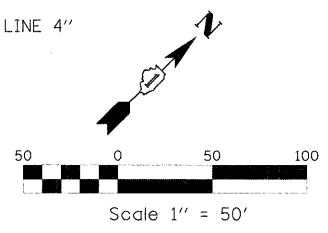
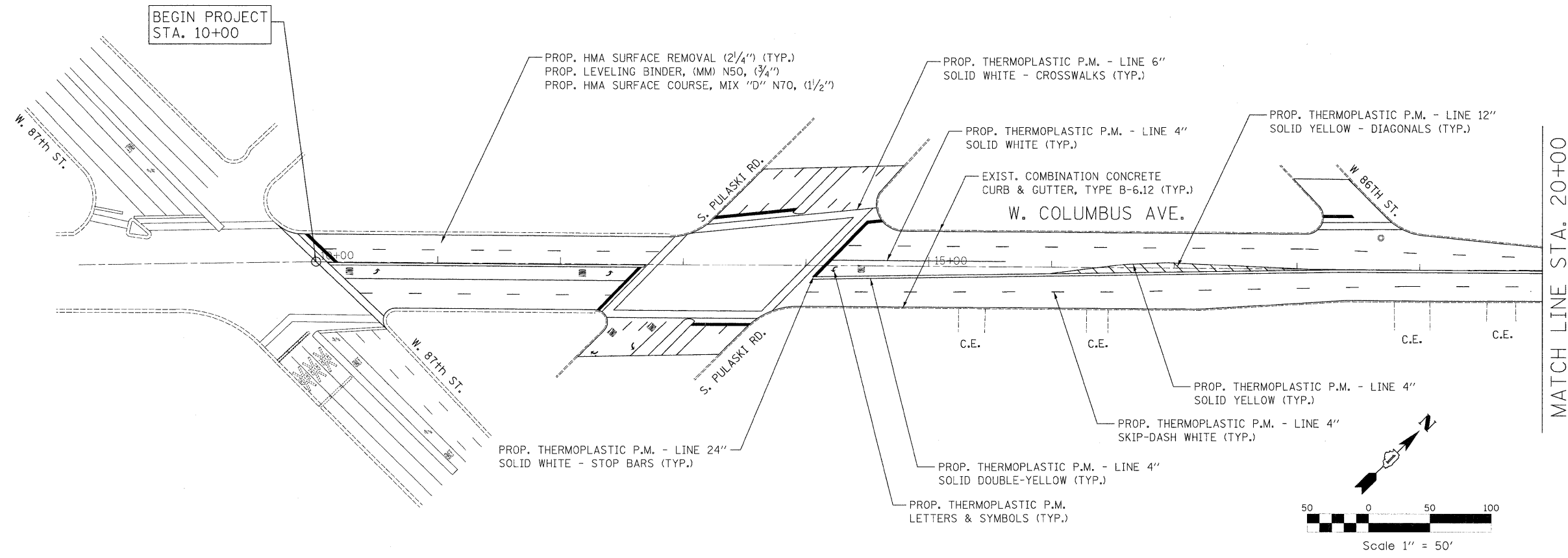

**GENERAL NOTES:**

- HOT-MIX ASPHALT SURFACE REMOVAL - BUTT JOINT SHALL BE PLACED AT THE FINAL 30' OF RESURFACING LIMITS OF MAINLINE AND SIDEROADS, UNLESS OTHERWISE SPECIFIED OR DIRECTED BY THE ENGINEER.

FILE NAME = ...\\2803\w018\Chicago\sheet21.dgn	USER NAME = Plotted by Administrator	DESIGNED - TP	REVISED -	<b>STATE OF ILLINOIS DEPARTMENT OF TRANSPORTATION</b>	<b>ROADWAY AND PAVEMENT MARKING PLAN COLUMBUS DRIVE FROM 87TH STREET TO WESTERN AVENUE</b>			F.A.U. RTE. 3578	SECTION 3178 RS-2	COUNTY COOK	TOTAL SHEETS 27	SHEET NO. 5
	PLOT SCALE = 50:0000' / IN.	CHECKED - FML	REVISED -					CONTRACT NO. 60G82				
	PLOT DATE = 4/22/2009	DATE - 04/2009	REVISED -		SCALE: 1"=50'	SHEET NO. 1 OF 5 SHEETS	STA. 10+00 TO STA. 35+00	FED. ROAD DIST. NO. - ILLINOIS FED. AID PROJECT				

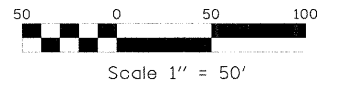
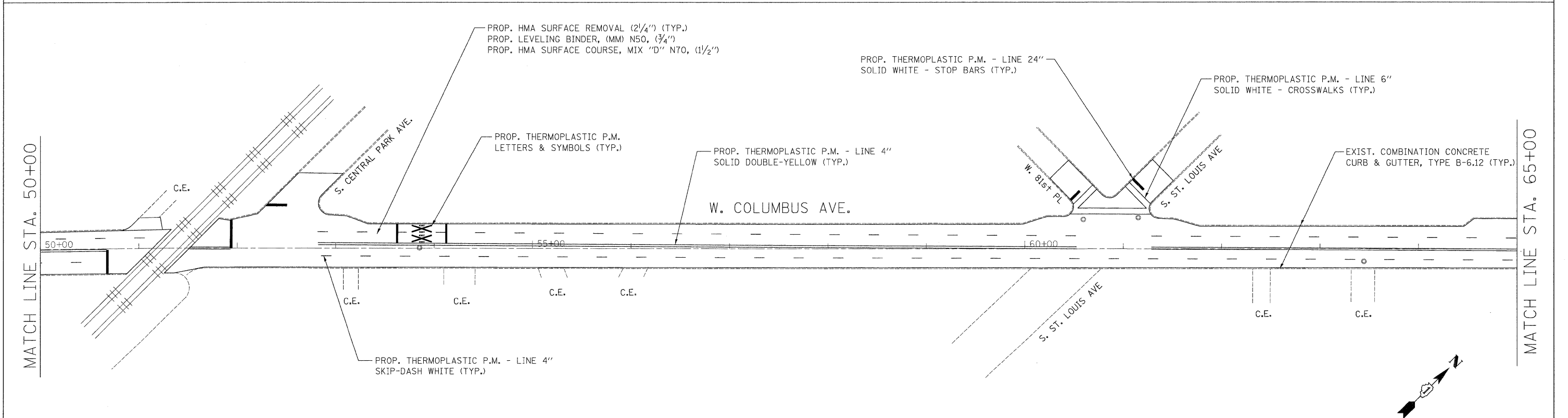
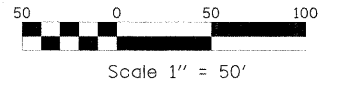
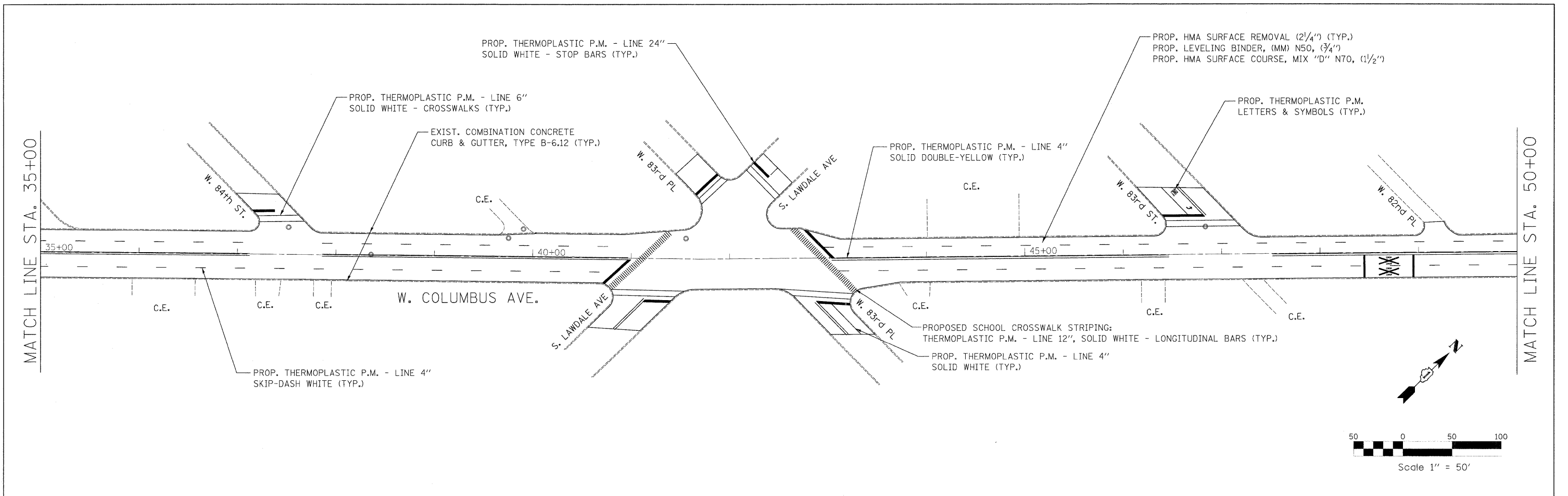

**GENERAL NOTES:**

- HOT-MIX ASPHALT SURFACE REMOVAL - BUTT JOINT SHALL BE PLACED AT THE FINAL 30' OF RESURFACING LIMITS OF MAINLINE AND SIDEROADS, UNLESS OTHERWISE SPECIFIED OR DIRECTED BY THE ENGINEER.

FILE NAME = ...0003\W018\Chicago\sheet21.dgn	USER NAME = Plotted by Administrator	DESIGNED - IP	REVISED -	<b>STATE OF ILLINOIS DEPARTMENT OF TRANSPORTATION</b>	<b>ROADWAY AND PAVEMENT MARKING PLAN COLUMBUS DRIVE FROM 87TH STREET TO WESTERN AVENUE</b>			F.A.U. RTE. 3578	SECTION 3178 RS-2	COUNTY COOK	TOTAL SHEETS 27	SHEET NO. 6				
	PLOT SCALE = 50.0000' / IN.	CHECKED - EML	REVISED -					SCALE: 1"=50'	SHEET NO. 2 OF 5 SHEETS	STA. 35+00 TO STA. 65+00	FED. ROAD DIST. NO. - [ILLINOIS] FED. AID PROJECT					
	PLOT DATE = 4/22/2009	DATE - 04/2009	REVISED -													
CONTRACT NO. 60G82																

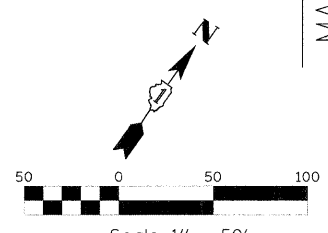
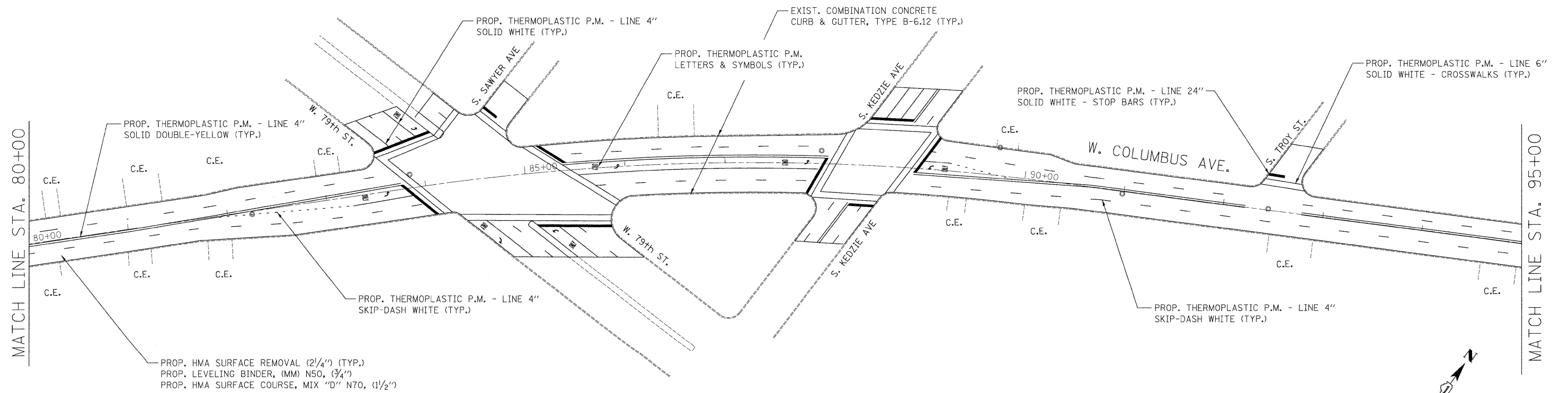
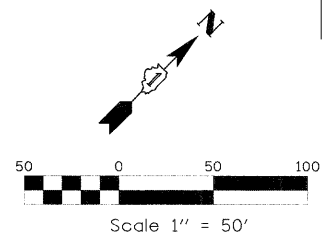
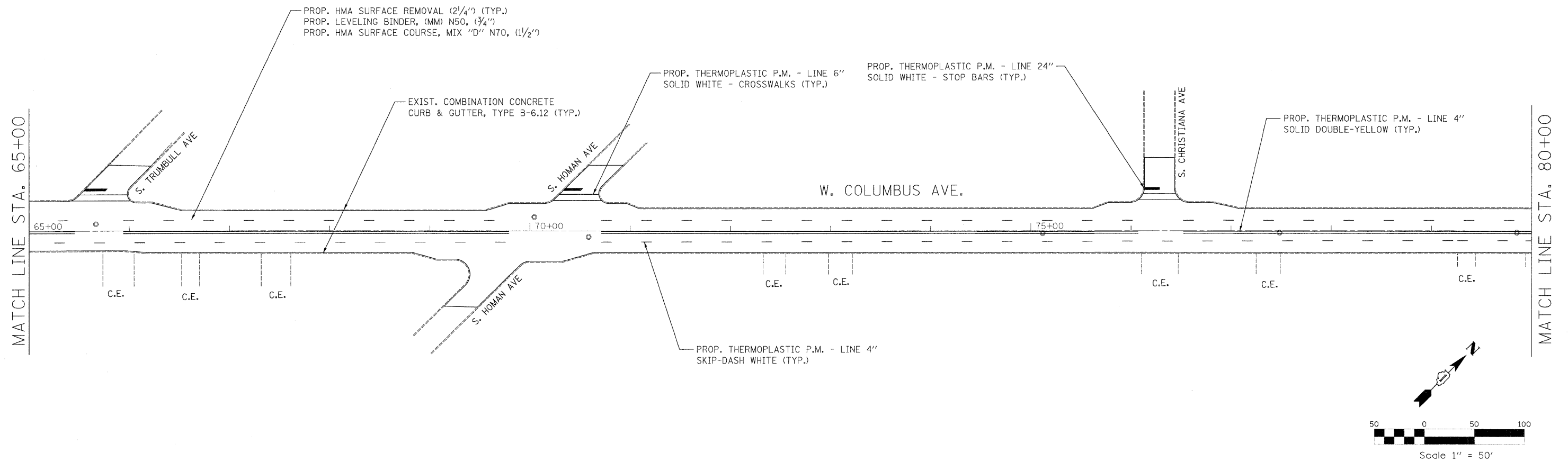

**GENERAL NOTES:**

- HOT-MIX ASPHALT SURFACE REMOVAL - BUTT JOINT SHALL BE PLACED AT THE FINAL 30' OF RESURFACING LIMITS OF MAINLINE AND SIDEROADS, UNLESS OTHERWISE SPECIFIED OR DIRECTED BY THE ENGINEER.

FILE NAME =  
...\\08031\W018\Chicago\sheet21.dgn

USER NAME = Plotted by Administrator

DESIGNED - IP

REVISED -

DRAWN - IP

REVISED -

CHECKED - EML

REVISED -

DATE - 04/22/2009

REVISED -

**STATE OF ILLINOIS  
DEPARTMENT OF TRANSPORTATION**

**ROADWAY AND PAVEMENT MARKING PLAN  
COLUMBUS DRIVE FROM 87TH STREET TO WESTERN AVENUE**

SCALE: 1"=50' SHEET NO. 3 OF 5 SHEETS STA. 65+00 TO STA. 95+00

F.A.U. RTE.	SECTION	COUNTY	TOTAL SHEETS	SHEET NO.
3578	3178 RS-2	COOK	27	7
CONTRACT NO. 60G82				
FED. ROAD DIST. NO. - [ILLINOIS] FED. AID PROJECT				

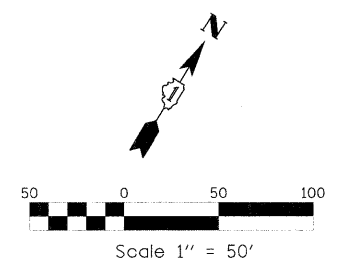
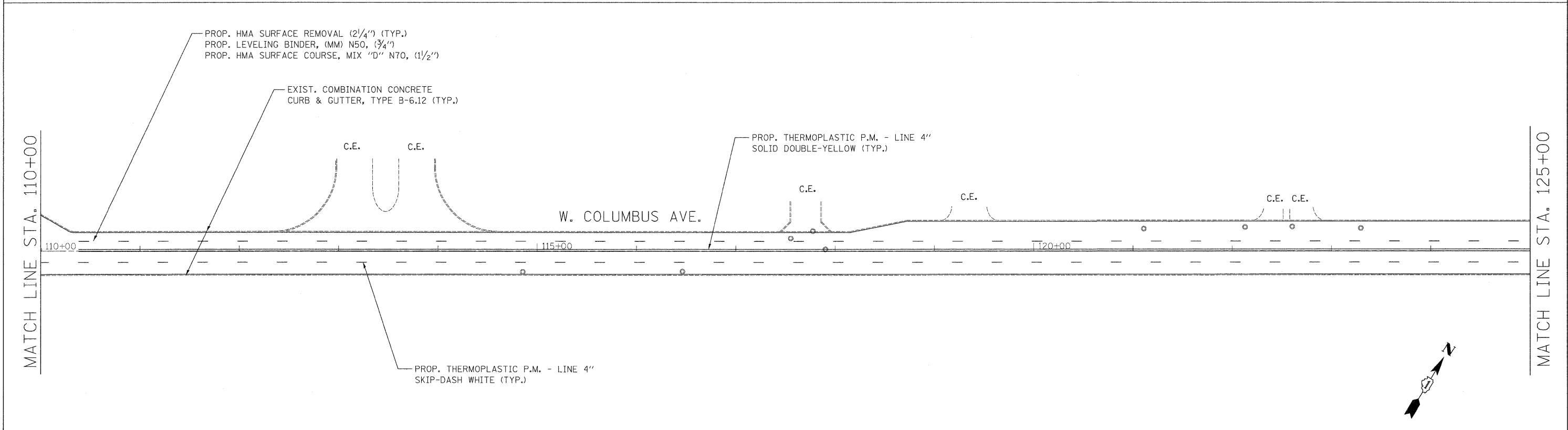
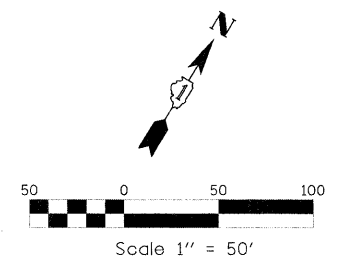
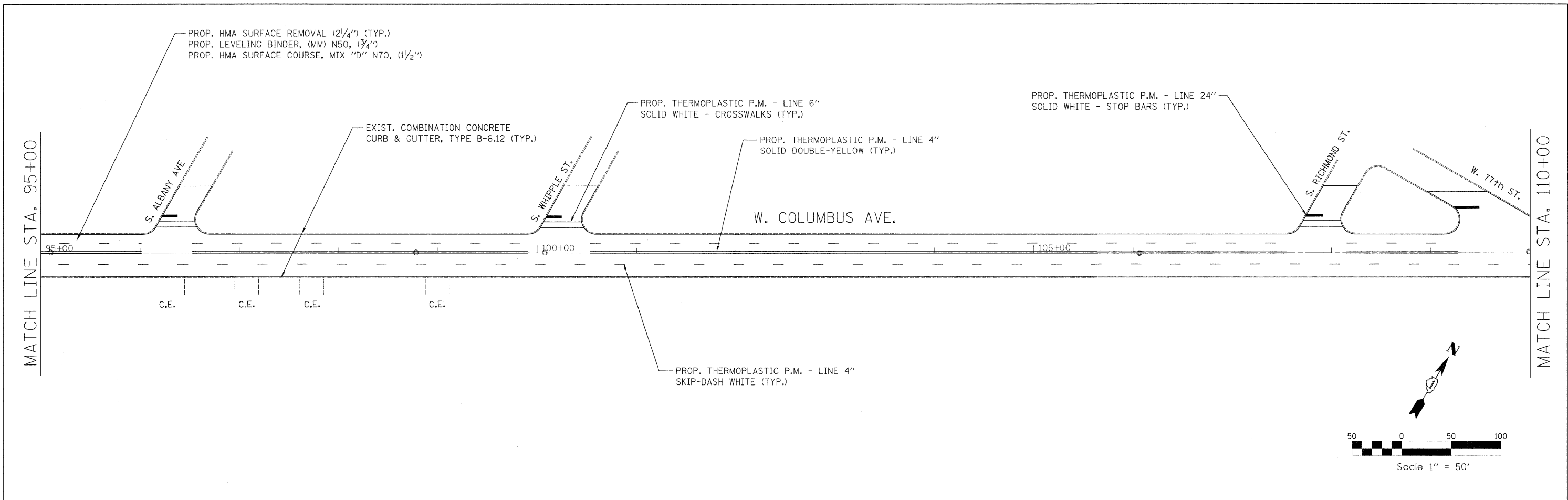

**GENERAL NOTES:**

- HOT-MIX ASPHALT SURFACE REMOVAL - BUTT JOINT SHALL BE PLACED AT THE FINAL 30' OF RESURFACING LIMITS OF MAINLINE AND SIDEROADS, UNLESS OTHERWISE SPECIFIED OR DIRECTED BY THE ENGINEER.

FILE NAME = ...\\0803\W019\Chicago\sheet21.dgn	USER NAME = Plotted by Administrator	DESIGNED - IP_	REVISED - _____	<b>STATE OF ILLINOIS DEPARTMENT OF TRANSPORTATION</b>	<b>ROADWAY AND PAVEMENT MARKING PLAN COLUMBUS DRIVE FROM 87TH STREET TO WESTERN AVENUE</b>			F.A.U. RTE: 3578	SECTION 3178 RS-2	COUNTY COOK	TOTAL SHEETS 27	SHEET NO. 8	
	PLOT SCALE = 50.0000' / IN.	CHECKED - EML	REVISED - _____		SCALE: 1"=50'	SHEET NO. 4 OF 5 SHEETS	STA. 95+00 TO STA. 125+00	FED. ROAD DIST. NO. _ ILLINOIS FED. AID PROJECT					
	PLOT DATE = 4/22/2009	DATE - 04/2009	REVISED - _____										
	CONTRACT NO. 60G82												







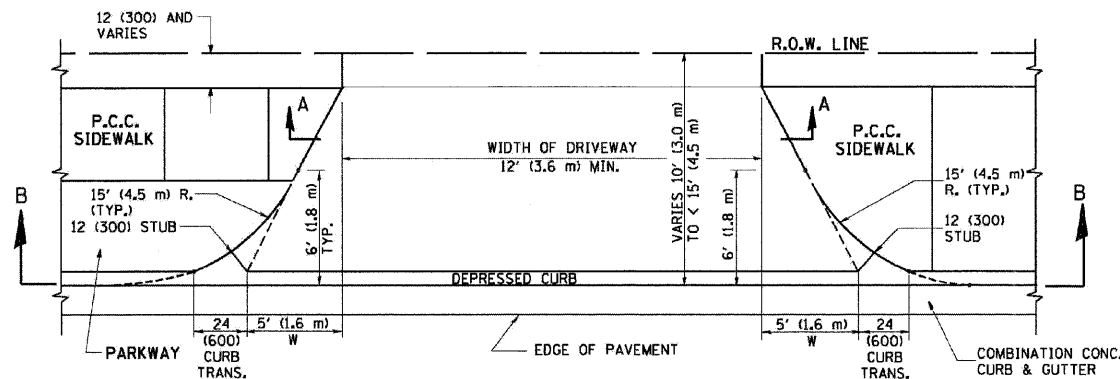

PLAN  
10' (3.0 m) TO < 15' (4.5 m)

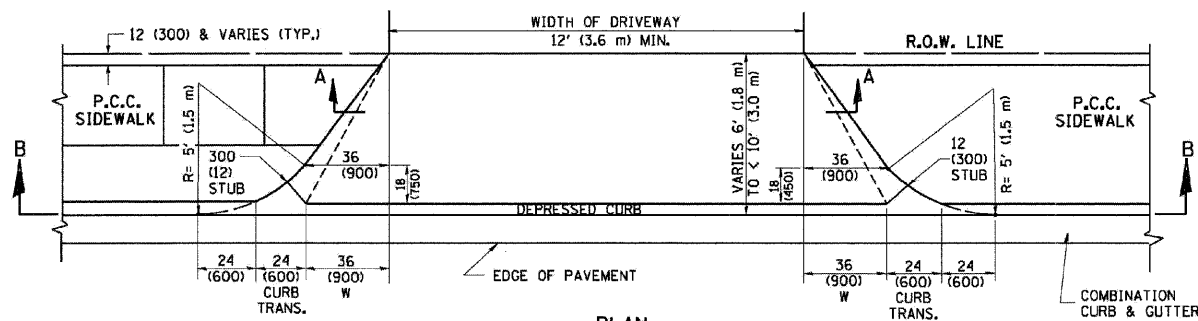

PLAN  
6' (1.8 m) TO < 10' (3.0 m)

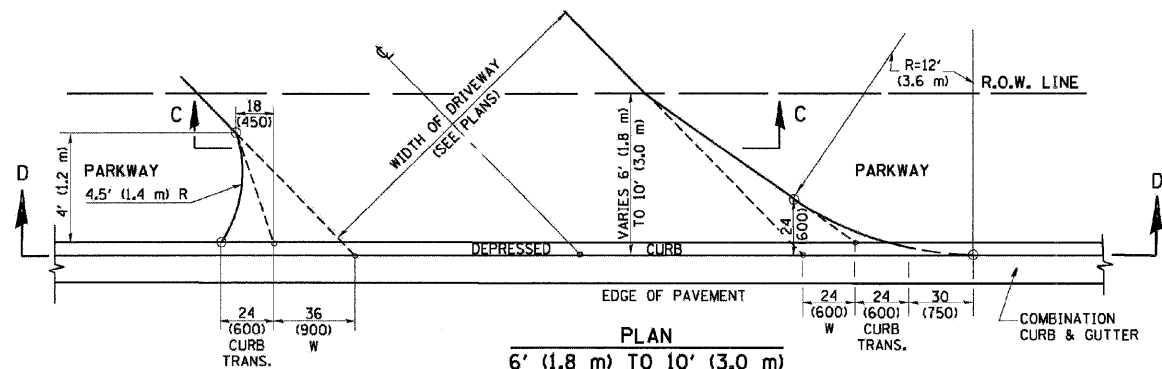

PLAN  
6' (1.8 m) TO 10' (3.0 m)

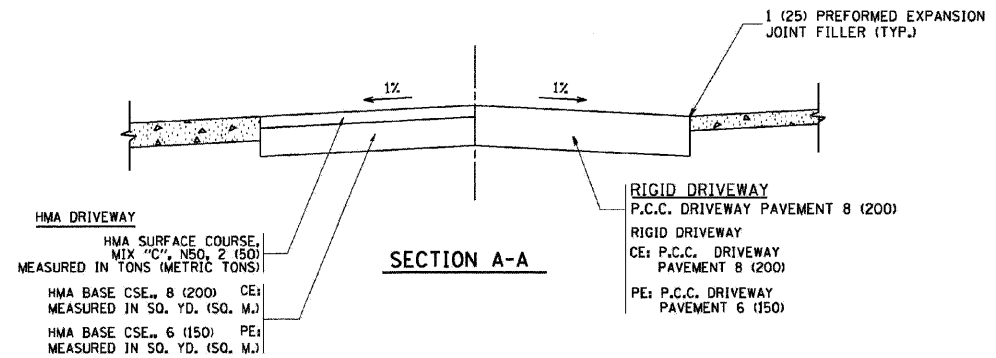

SECTION A-A

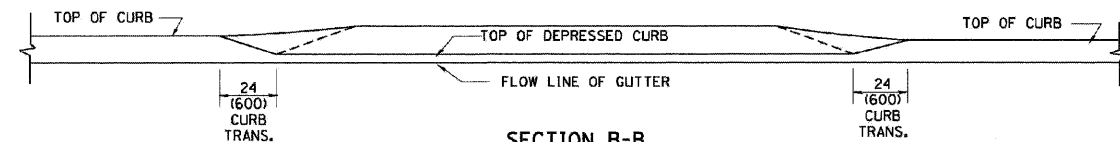

SECTION B-B

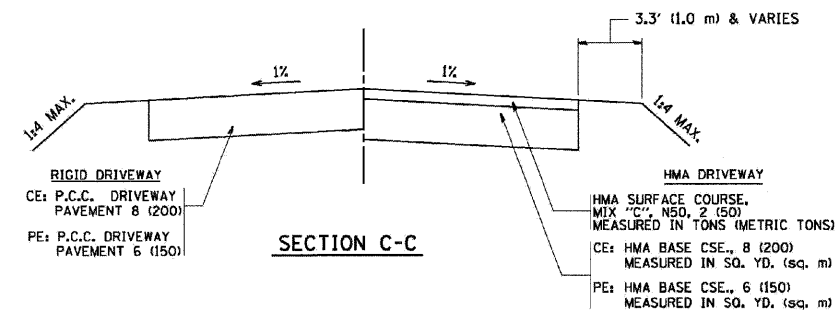

SECTION C-C

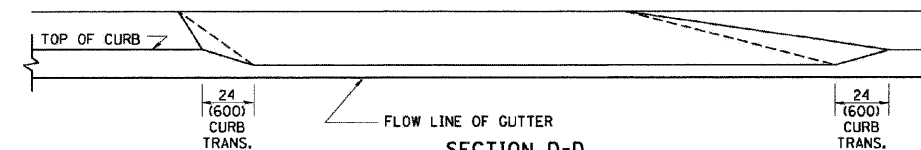

SECTION D-D

GENERAL NOTES

DRIVEWAY SLOPES, LOCATIONS, & GEOMETRIC LAYOUT SHALL BE IN ACCORDANCE WITH THE LATEST EDITION OF THE "HANDBOOK FOR POLICY ON PERMITS FOR ACCESS DRIVEWAYS TO STATE HIGHWAYS". FOR FURTHER LAYOUT REQUIREMENTS, REFER TO ILLUSTRATION 10 IN THE PERMIT HANDBOOK. WHERE SIDEWALKS EXIST, DRIVEWAYS SHALL BE REPLACED WITH RIGID PAVEMENT. WHERE NO SIDEWALKS EXIST, DRIVEWAYS SHALL BE REPLACED IN KIND. SIDEWALK CROSS SLOPE THRU DRIVEWAY AREA TO BE A MAXIMUM OF 1:50.

WHEN THE DISTANCE BETWEEN R.O.W. AND THE BACK OF CURB IS EQUAL TO OR LESS THAN 8' (2.4 m), THE P.C.C. SIDEWALK SHALL EXTEND TO THE BACK OF CURB.

THE RESIDENT ENGINEER SHALL CONTACT THE TRAFFIC PERMIT OFFICE AT 847/705-4131 FOR ANY QUESTIONS ON DRIVEWAYS SHOWN IN THE PLANS; SPECIFICALLY IN REFERENCE TO ADDITIONAL AND/OR RELOCATION/REMOVAL OF A DRIVEWAY.

COMBINATION CONCRETE CURB & GUTTER SHALL BE MEASURED STRAIGHT ACROSS THE DRIVEWAY. NO ADDITIONAL COMPENSATION WILL BE ALLOWED FOR THE CURB & GUTTER TRANSITION.

THE 1 (25) PREFORMED EXPANSION JOINT FILLER WILL NOT BE PAID SEPARATELY, BUT SHALL BE CONSIDERED INCLUDED IN THE COST OF THE P.C.C. DRIVEWAY PAVEMENT OR P.C.C. SIDEWALK.

"W" VARIES FROM 36 (900) TO 5' (1.5 m) PROPORTIONAL TO THE LENGTH (L), FROM 6' (1.8 m) TO 10' (3 m).

ALL DIMENSIONS ARE IN INCHES (MILLIMETERS) UNLESS OTHERWISE NOTED.

**DRIVEWAY DETAILS – DISTANCE BETWEEN R.O.W. AND FACE OF CURB IS LESS THAN 15'**

FILE NAME = ...\\0803\N018\Chicago\Details.dgn	USER NAME = Plotted by Administrator	DESIGNED - ---	REVISED - ---	<b>STATE OF ILLINOIS DEPARTMENT OF TRANSPORTATION</b>	<b>DISTRICT ONE DETAIL SHEETS COLUMBUS DRIVE FROM 87TH STREET TO WESTERN AVENUE</b>			F.A.U. RTE. 3578	SECTION 3178 RS-2	COUNTY COOK	TOTAL SHEETS 27	SHEET NO. 11
PLOT SCALE = 25.0000" / IN.	CHECKED - ---	REVISED - ---	REVISED - ---		SCALE: NONE	SHEET NO. 2 OF 18 SHEETS	STA. _____ TO STA. _____	CONTRACT NO. 60G82				
PLOT DATE = 4/21/2009	DATE = 4/2009	REVISED - ---	REVISED - ---		FED. ROAD DIST. NO. _____ ILLINOIS FED. AID PROJECT							

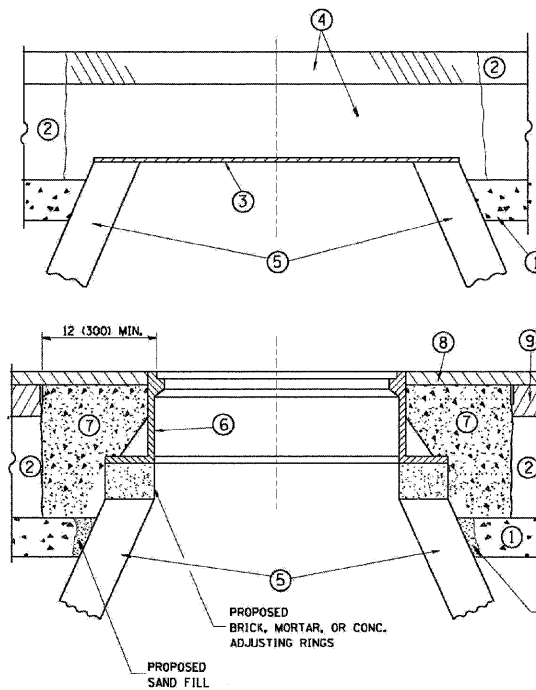

**CONSTRUCTION PROCEDURES**

**STAGE 1 (BEFORE PAVEMENT MILLING)**

- A) REMOVE A MINIMUM OF 12 (300) OF THE PAVEMENT FROM AROUND THE STRUCTURE.
- B) REMOVE THE EXISTING FRAME AND LID FROM THE STRUCTURE.
- C) COVER THE STRUCTURE OPENING WITH A 36 (900) DIAMETER METAL PLATE.
- D) BACKFILL WITH CRUSHED STONE AND A MINIMUM 1/2 (40) THICK HMA SURFACE MIX APPROVED BY THE ENGINEER.

**STAGE 2 (AFTER PAVEMENT MILLING)**

- A) REMOVE THE HMA SURFACE MIX AND CRUSHED STONE.
- B) INSTALL THE FRAME AND LID; ADJUST THE FRAME TO ITS FINAL SURFACE ELEVATION.
- C) THE SURROUNDING SPACE SHALL BE FILLED WITH CLASS S1 CONCRETE, OR HMA SURFACE COURSE OR HMA BINDER COURSE TO THE ELEVATION OF THE SURFACE OF THE EXISTING BASE COURSE OR THE BINDER COURSE.

THE PROCEDURE EXPLAINED ABOVE SHALL CONFORM TO THE APPLICABLE PORTIONS OF SECTIONS 353, 406, 602, AND 603 OF THE STANDARD SPECIFICATIONS.

**NOTES:**

EXISTING BROKEN FRAMES AND LIDS SHALL BE REMOVED AND DISPOSED OF BY THE CONTRACTOR AND SHALL BE REPLACED AS DIRECTED BY THE ENGINEER. REPLACEMENT FRAMES AND LIDS WILL BE PAID FOR IN ACCORDANCE WITH ARTICLE 109.04 OF THE STANDARD SPECIFICATIONS UNLESS A SEPARATE PAY ITEM HAS BEEN PROVIDED.

IF THE EXISTING LIDS ARE OPEN, THE FRAME WILL BE ADJUSTED TO THE ELEVATION OF THE MILLED PAVEMENT SURFACE PRIOR TO THE MILLING OPERATION. THE FRAME WILL NOT BE REMOVED AND COVERED BY THE METAL PLATE.

CITY OF CHICAGO CASTINGS ARE THE PROPERTY OF THE CITY AND THE CONTRACTOR SHALL NOTIFY THE CITY FOR REMOVAL AND DISPOSITION OF THE CASTINGS.

THE METAL PLATE USED TO COVER THE STRUCTURE SHALL REMAIN THE PROPERTY OF THE CONTRACTOR.

WHEN STRUCTURES ARE TO BE ADJUSTED OR RECONSTRUCTED, THE LOWERING AND RAISING OF THE FRAMES AND LIDS WILL NOT BE PAID FOR SEPARATELY BUT WILL BE INCLUDED IN THE COST OF THE CORRESPONDING PAY ITEM.

**LEGEND**

- ① SUB-BASE GRANULAR MATERIAL
- ② EXISTING PAVEMENT
- ③ 36 (900) DIAMETER METAL PLATE
- ④ PROPOSED CRUSHED STONE AND HMA SURFACE MIX
- ⑤ EXISTING STRUCTURE
- ⑥ FRAME AND LID (SEE NOTES)
- ⑦ CLASS S1 CONCRETE, HMA SURFACE COURSE OR HMA BINDER COURSE
- ⑧ PROPOSED HMA SURFACE COURSE
- ⑨ PROPOSED HMA BINDER COURSE

**LOCATION OF STRUCTURES:**

THE CONTRACTOR WILL BE REQUIRED TO KEEP A RECORD OF THE LOCATIONS OF THE BURIED STRUCTURES ACCORDING TO THE STATION AND DISTANCE LEFT OR RIGHT OF THE CENTERLINE OF PAVEMENT. UPON COMPLETION OF THE WORK, THE CONTRACTOR WILL DELIVER THE RECORD TO THE ENGINEER.

**BASIS OF PAYMENT:** THIS WORK WILL BE PAID FOR AT THE CONTRACT UNIT PRICE PER EACH FOR "FRAMES AND LIDS TO BE ADJUSTED, SPECIAL" NEW FRAMES AND LIDS, WHEN SPECIFIED, WILL BE PAID FOR SEPARATELY.

**DETAILS FOR FRAMES AND LIDS ADJUSTMENT WITH MILLING**

ALL DIMENSIONS ARE IN INCHES (MILLIMETERS) UNLESS OTHERWISE SHOWN

**FRAMS AND LIDS ADJUSTMENT WITH MILLING; AND FRAMES AND LIDS ADJUSTMENT WITHOUT MILLING**

FILE NAME = ...0803\W018\Chicago\Details.dgn	USER NAME = Plotted by Administrator	DESIGNED - ---	REVISED - ---	<b>STATE OF ILLINOIS DEPARTMENT OF TRANSPORTATION</b>	<b>DISTRICT ONE DETAIL SHEETS COLUMBUS DRIVE FROM 87TH STREET TO WESTERN AVENUE</b>			F.A.U. RTE. 3578	SECTION 3178 RS-2	COUNTY COOK	TOTAL SHEETS 27	SHEET NO. 12
PLOT SCALE = 25.0000' / IN.		CHECKED - ---	REVISED - ---		SCALE: NONE	SHEET NO. 3 OF 18 SHEETS	STA. _____ TO STA. _____	CONTRACT NO. 60G82				
PLOT DATE = 4/21/2009		DATE - 4/2009	REVISED - ---		FED. ROAD DIST. NO. - [ILLINOIS] FED. AID PROJECT							

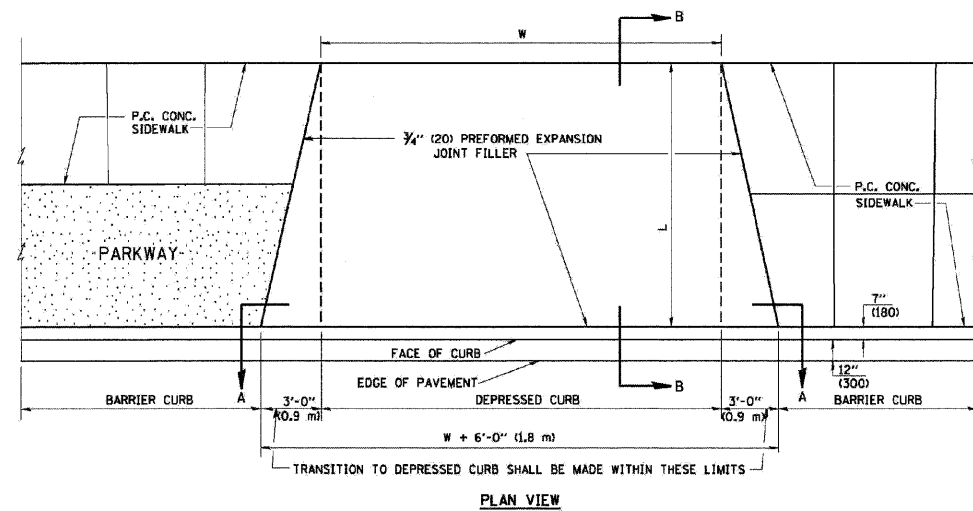

NOTES:

1. EXPANSION JOINTS SHALL BE CONSTRUCTED AS SHOWN ON THE DETAILS FOR P.C.C. SIDEWALK.
2. THE CURB BETWEEN ADJACENT DRIVEWAYS SHALL BE FULL HEIGHT FOR A DISTANCE OF AT LEAST FOUR FEET (1.2 METERS).
3. P.C. CONCRETE DRIVEWAYS SHALL BE CONSTRUCTED AT LOCATIONS SHOWN ON THE PLANS OR AS DIRECTED BY THE ENGINEER.
4. 3/4" (20) PREFORMED EXPANSION JOINTS WILL NOT BE PAID FOR SEPARATELY BUT SHALL BE CONSIDERED INCIDENTAL TO P.C.C. DRIVEWAY PAVEMENT 8" (200).
5. COMBINATION CONC. CURB AND GUTTER SHALL BE MEASURED STRAIGHT ACROSS THE DRIVEWAY. NO ADDITIONAL COMPENSATION WILL BE ALLOWED FOR THE TRANSITION CURB AND GUTTER.

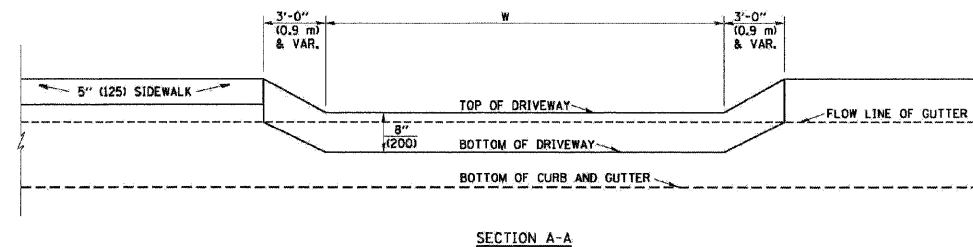
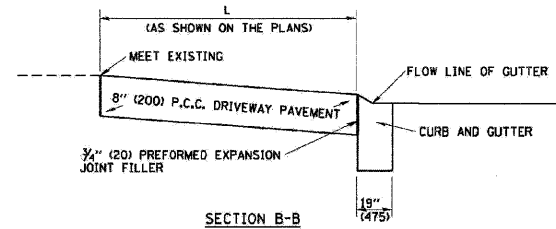

P.C.C. DRIVEWAY PAVEMENT DETAIL

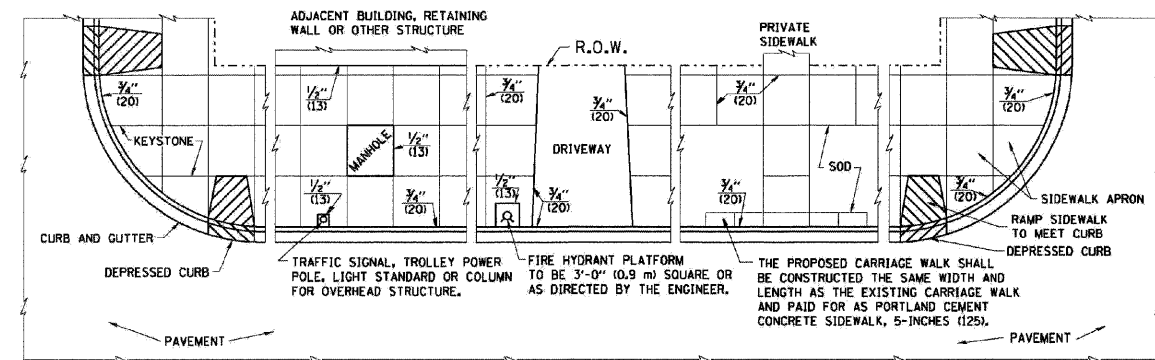

NOTES:

1. ONE-HALF INCH THICK EXPANSION JOINTS SHALL BE PLACED BETWEEN THE SIDEWALK AND ALL STRUCTURES SUCH AS LIGHT STANDARDS, TRAFFIC LIGHT STANDARDS, MANHOLES, WHICH EXTEND THROUGH THE SIDEWALK.
2. 3/4" (20) THICK EXPANSION JOINTS SHALL BE PLACED AT INTERVALS OF NOT MORE THAN 100 FEET (30 METERS) IN THE SIDEWALK, WHERE THE SIDEWALK IS CONSTRUCTED ADJACENT TO PAVEMENT OR CURB HAVING EXPANSION JOINTS, THE EXPANSION JOINTS IN THE SIDEWALK SHALL BE PLACED OPPOSITE THE EXISTING EXPANSION JOINTS AS NEARLY AS PRACTICABLE. EXPANSION JOINTS SHALL ALSO BE PLACED WHERE THE SIDEWALK ABUTS EXISTING SIDEWALKS, BETWEEN DRIVEWAY PAVEMENT AND SIDEWALK, AND BETWEEN SIDEWALK AND CURBS WHERE THE SIDEWALK ABUTS A CURB.

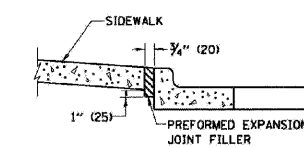

SLOPE FOR SIDEWALK  
1" (25) IN 3'-0" (0.9 m) IN CHICAGO

PORTLAND CEMENT CONCRETE SIDEWALK DETAILS

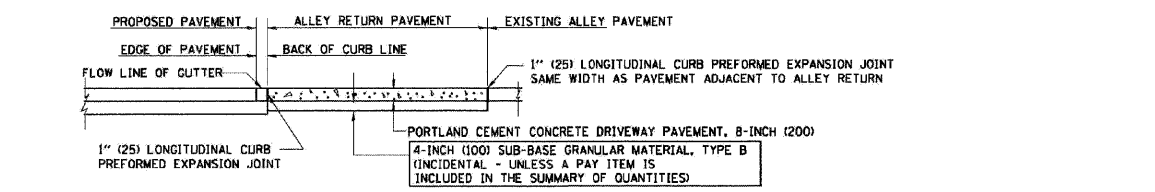
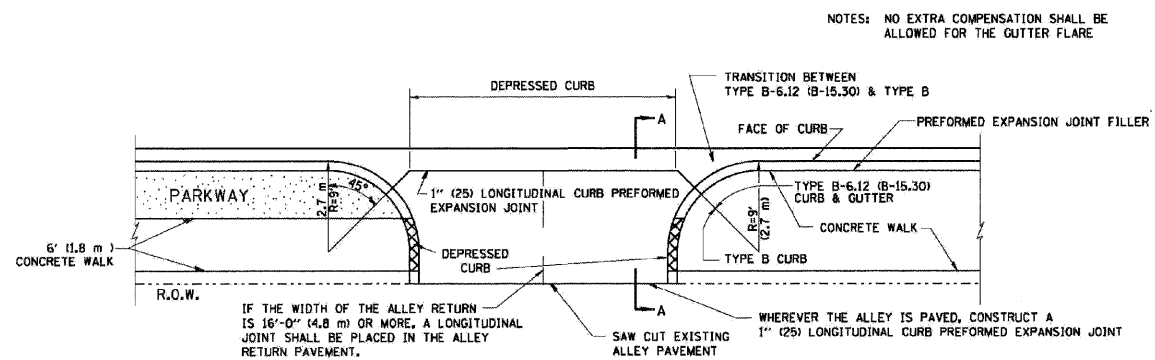

ALLEY RETURN DETAIL

ALL DIMENSIONS ARE IN INCHES (MILLIMETERS) UNLESS OTHERWISE SHOWN

CITY OF CHICAGO DETAILS FOR  
P.C. CONCRETE DRIVEWAY, ALLEY RETURN AND SIDEWALK

FILE NAME = ...\\0803\W018\Chicago\Details.dgn	USER NAME = Plotted by Administrator	DESIGNED - ---	REVISED - ---	STATE OF ILLINOIS DEPARTMENT OF TRANSPORTATION	DISTRICT ONE DETAIL SHEETS COLUMBUS DRIVE FROM 87TH STREET TO WESTERN AVENUE		F.A.U. RTE. 3578	SECTION 3178 RS-2	COUNTY COOK	TOTAL SHEETS 27	SHEET NO. 13	
PLOT SCALE = 25.0000' / IN.	CHECKED - ---	REVISED - ---	REVISED - ---		SCALE: NONE	SHEET NO. 4 OF 18 SHEETS	STA. _____ TO STA. _____	CONTRACT NO. 60G82				
PLOT DATE = 4/21/2009	DATE - 4/2009	REVISED - ---	REVISED - ---		FED. ROAD DIST. NO. _____ (ILLINOIS) FED. AID PROJECT							

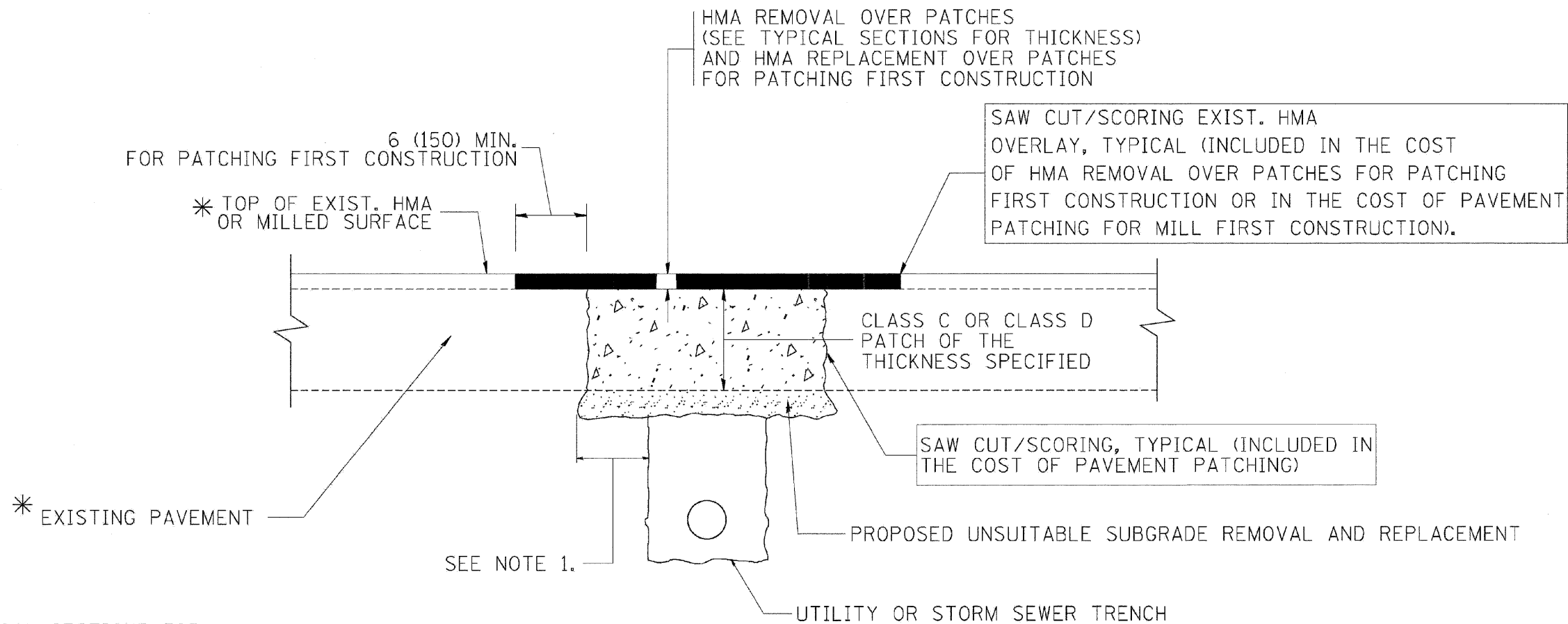

\* SEE TYPICAL SECTIONS FOR THICKNESS AND MATERIALS

**NOTES:**

1. THE WIDTH OF THE FULL DEPTH PATCH OVER A TRENCH SHALL BE 12 (300) WIDER ON EACH SIDE OF THE TRENCH.
2. FOR METHOD OF MEASUREMENT AND BASIS OF PAYMENT, SEE RECURRING SPECIAL PROVISION "PATCHING WITH HOT-MIX ASPHALT OVERLAY REMOVAL".

**SEQUENCE OF CONSTRUCTION (PATCHING FIRST)**

1. REMOVE THE EXISTING HMA MATERIAL OVER THE AREA TO BE PATCHED.
2. REMOVE AND REPLACE WITH CLASS C OR D PATCH.
3. REPLACE HMA MATERIAL OVER THE AREA TO BE PATCHED.

**SEQUENCE OF CONSTRUCTION (MILLING FIRST)**

1. MILL HMA FIRST IF THERE IS AT LEAST 4 1/2 INCHES OR MORE OF HMA MATERIAL ON TOP OF THE EXISTING PAVEMENT OR IF THE PAVEMENT IS FULL DEPTH HMA. A MINIMUM OF 2 INCHES OF HMA MATERIAL SHALL BE IN PLACE AFTER MILLING.
2. REMOVE AND REPLACE WITH FULL DEPTH CLASS D PATCHES TO TOP OF MILLED SURFACE.

ALL DIMENSIONS ARE IN INCHES (MILLIMETERS) UNLESS OTHERWISE SHOWN.

**PAVEMENT PATCHING FOR HMA SURFACED PAVEMENT**

FILE NAME = ...\\B803\W018\Chicago\Details.dgn	USER NAME = Plotted by Administrator	DESIGNED - ---	REVISED - ---	<b>STATE OF ILLINOIS DEPARTMENT OF TRANSPORTATION</b>	<b>DISTRICT ONE DETAIL SHEETS COLUMBUS DRIVE FROM 87TH STREET TO WESTERN AVENUE</b>		F.A.U. RTE. 3578	SECTION 3178 RS-2	COUNTY COOK	TOTAL SHEETS 27	SHEET NO. 14	
PLOT SCALE = 25.0000' / IN.	CHECKED - ---	REVISED - ---	REVISED - ---		SCALE: NONE	SHEET NO. 5 OF 18 SHEETS	STA. _____ TO STA. _____	FED. ROAD DIST. NO. _ [ILLINOIS] FED. AID PROJECT				
PLOT DATE = 4/21/2009	DATE = 4/2009	REVISED - ---	REVISED - ---		CONTRACT NO. 60G82							



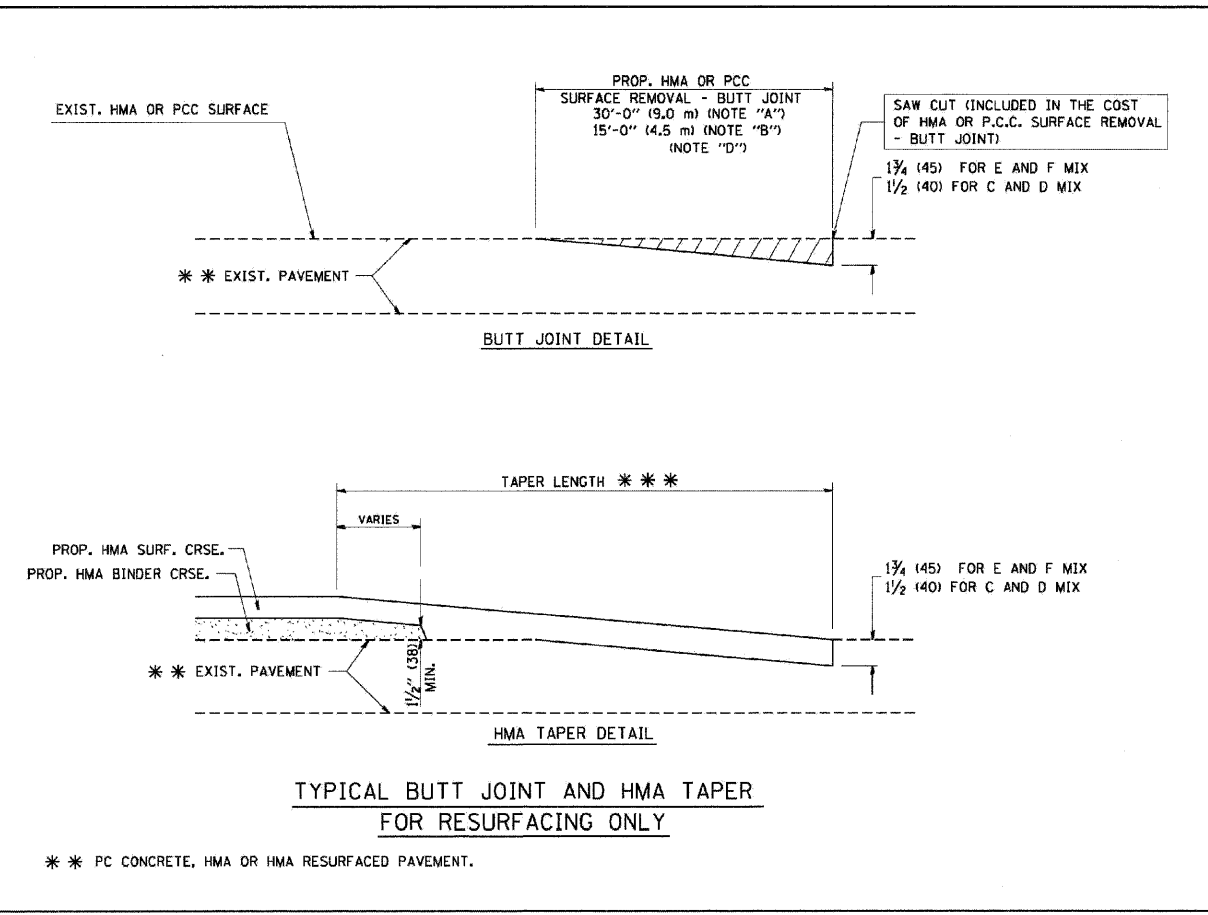
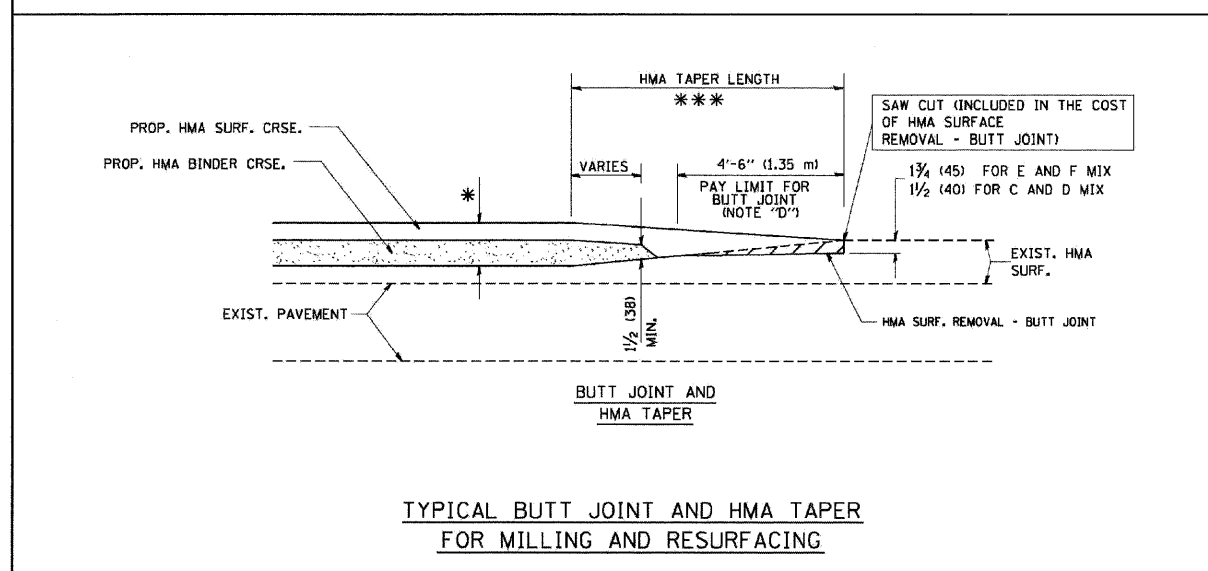
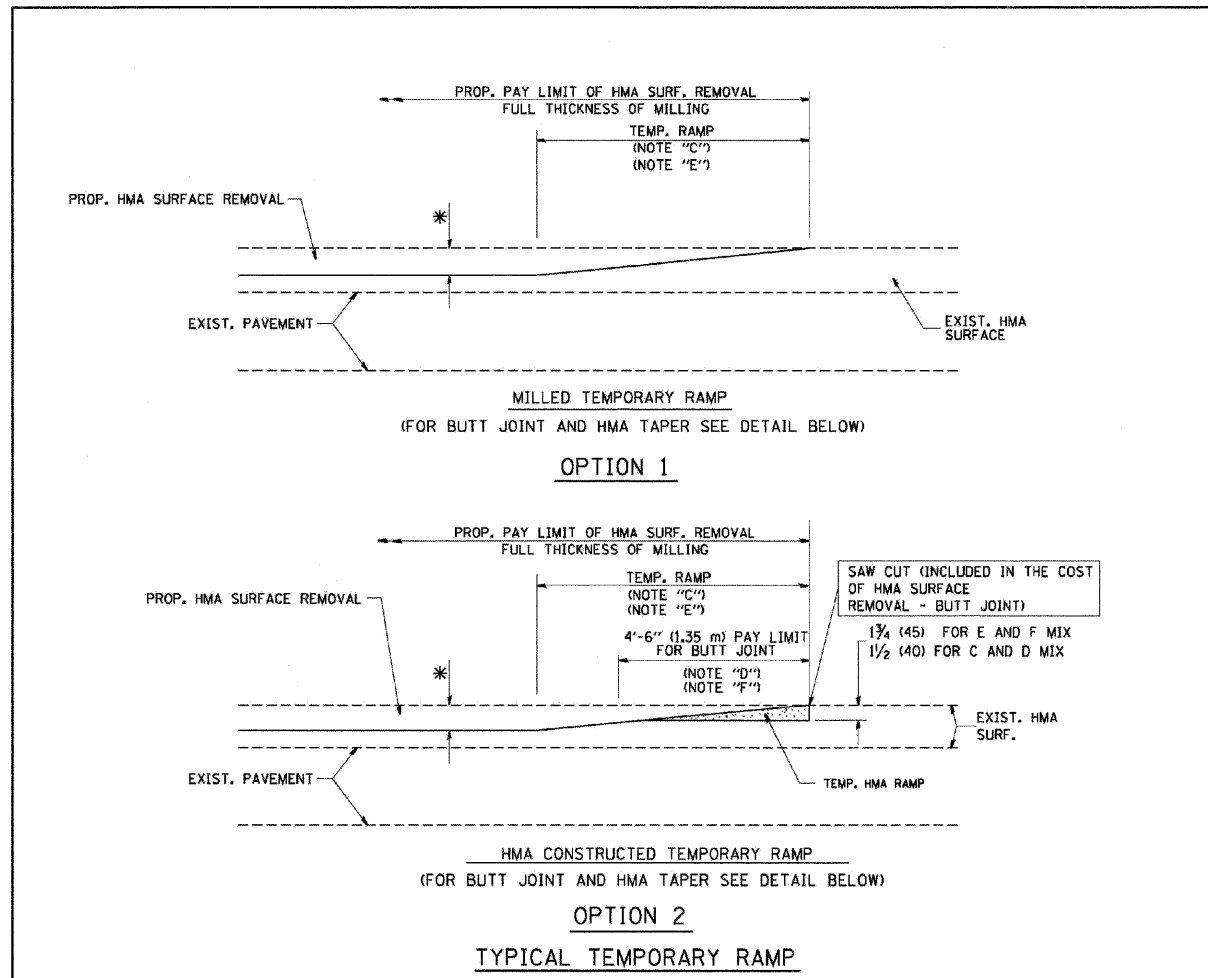

**NOTES**

A: MAINLINE ROADWAYS AND MAJOR SIDE ROADS.

B: MINOR SIDE ROADS.

C: THE TEMP. RAMP SHALL BE CONSTRUCTED IMMEDIATELY UPON REMOVAL OF THE EXISTING HMA SURFACE.

D: THE BUTT JOINT SHALL BE CONSTRUCTED IMMEDIATELY PRIOR TO PLACING THE PROPOSED HMA COURSES.

E: TAPER THE TEMP. RAMP AT A RATE OF 3'-0" (900 mm) PER 1 INCH (25 mm) OF MILLING THICKNESS.

F: INSTALLATION AND REMOVAL OF THE 4'-6" (1.35 m) TEMP. RAMP IS INCLUDED IN COST OF HMA SURFACE REMOVAL - BUTT JOINT

G: SEE ARTICLE 406.08 AND 406.14 OF THE STANDARD SPECIFICATIONS FOR 'HMA AND/OR PCC SURFACE REMOVAL, BUTT JOINT'.

\* SEE TYPICAL SECTIONS FOR MILLING THICKNESS.

\*\*\* 20'-0" (6.1 m) PER 1 (25) RESURFACING (NOTE "A")  
 10'-0" (3.0 m) PER 1 (25) RESURFACING (NOTE "B")

**BASIS OF PAYMENT:**  
 THE BUTT JOINT WILL BE PAID FOR AT THE CONTRACT UNIT PRICE PER SQUARE YARD (SQUARE METER) FOR "HOT-MIX ASPHALT SURFACE REMOVAL - BUTT JOINT" OR FOR "PORTLAND CEMENT CONCRETE SURFACE REMOVAL - BUTT JOINT".

ALL DIMENSIONS ARE IN INCHES (MILLIMETERS) UNLESS OTHERWISE SHOWN.

**BUTT JOINTS AND HMA TAPER**



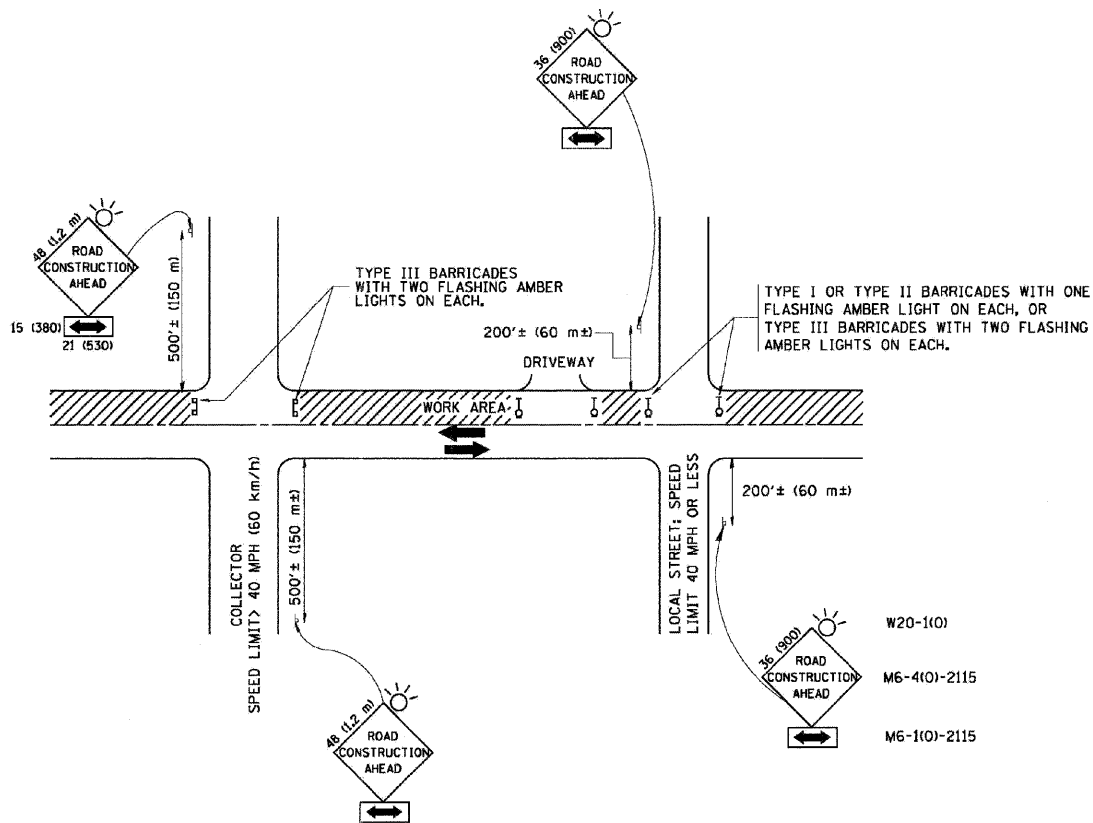

TRAFFIC CONTROL AND PROTECTION FOR SIDE ROADS, INTERSECTIONS, AND DRIVEWAYS

NOTES:

A. FOR NO LANE RESTRICTION ON THE SIDE ROAD OR DRIVEWAYS

1. SIDE ROAD WITH A SPEED LIMIT OF 40 MPH (60 km/h) OR LESS AS SHOWN ON THE DRAWING AND AS DIRECTED BY THE ENGINEER:
  - a) ONE ROAD CONSTRUCTION AHEAD SIGN 36 x 36 (900x900) WITH A FLASHER AND FLAG MOUNTED ON IT APPROXIMATELY 200' (60 m) IN ADVANCE OF THE MAIN ROUTE.
  - b) THE CLOSED PORTION OF THE MAIN ROUTE SHALL BE PROTECTED BY BLOCKING WITH TYPE I, TYPE II OR TYPE III BARRICADES, 1/3 OF THE CROSS SECTION OF THE CLOSED PORTION.
2. SIDE ROAD WITH A SPEED LIMIT GREATER THAN 40 MPH (60 km/h) AS SHOWN ON THE DRAWING AND AS DIRECTED BY THE ENGINEER:
  - a) ONE ROAD CONSTRUCTION AHEAD SIGN 48 x 48 (1.2 m x 1.2 m) WITH A FLASHER MOUNTED ON IT APPROXIMATELY 500' (150 m) IN ADVANCE OF THE MAIN ROUTE.
  - b) THE CLOSED PORTION OF THE MAIN ROUTE SHALL BE PROTECTED BY BLOCKING WITH TYPE III BARRICADES, 1/2 OF THE CROSS SECTION OF THE CLOSED PORTION.
3. WHEN THE SIDE ROAD LIES BETWEEN THE BEGINNING OF THE MAINLINE SIGNING AND THE WORK ZONE, A SINGLE HEADED ARROW (M6-1) SHALL BE USED IN LIEU OF THE DOUBLE HEADED ARROW (M6-4).

B. FOR A LANE CLOSURE ON A SIDE ROAD OR DRIVEWAY:

- USE APPLICABLE PORTIONS OF THE TYPICAL APPLICATION OF TRAFFIC CONTROL DEVICES (STD. 701501, STD. 701606 OR THE APPROPRIATE STANDARD). THE SPACING OF SIGNS AND BARRICADES SHALL BE ADJUSTED FOR FIELD CONDITIONS AS DIRECTED BY THE ENGINEER. THE DIRECTIONAL ARROW SHALL BE COVERED OR REMOVED WHEN NO LONGER CONSISTENT WITH THE SIDE ROAD LANE CLOSURE.
- C. ADVANCE WARNING SIGNS ARE TO BE OMITTED ON DRIVEWAY UNLESS OTHERWISE NOTED.
- D. THE TRAFFIC CONTROL AND PROTECTION FOR SIDE ROADS, INTERSECTIONS, AND DRIVEWAYS SHALL BE INCIDENTAL TO THE COST OF SPECIFIED TRAFFIC CONTROL STANDARDS OR ITEMS.

All dimensions are in millimeters (inches) unless otherwise shown.

TRAFFIC CONTROL AND PROTECTION FOR SIDE ROADS, INTERSECTIONS AND DRIVEWAYS

FILE NAME =	USER NAME = Plotted by Administrator	DESIGNED -	REVISED -	<b>STATE OF ILLINOIS DEPARTMENT OF TRANSPORTATION</b>	<b>DISTRICT ONE DETAIL SHEETS</b>			F.A.U. RTE.	SECTION	COUNTY	TOTAL SHEETS	SHEET NO.
...\\0923\W018\Chicago\Details.dgn		DRAWN -	REVISED -		<b>COLUMBUS DRIVE FROM 87TH STREET TO WESTERN AVENUE</b>			3578	3178 RS-2	COOK	27	17
PLOT SCALE = 25.0000' / IN.		CHECKED -	REVISED -		SCALE: NONE	SHEET NO. 8 OF 18 SHEETS	STA. _____ TO STA. _____	CONTRACT NO. 60G82				
PLOT DATE = 4/21/2009		DATE - 4/2009	REVISED -		FED. ROAD DIST. NO. _ ILLINOIS FED. AID PROJECT							

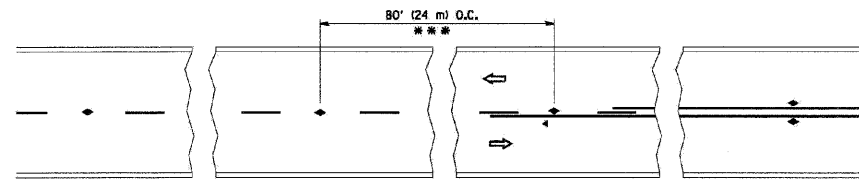

\*\*\* REDUCE TO 40' (12 m) O.C. ON CURVES WITH POSTED OR ADVISORY SPEED 45 M.P.H. (70 km/h) OR LESS.

TWO-LANE/TWO-WAY

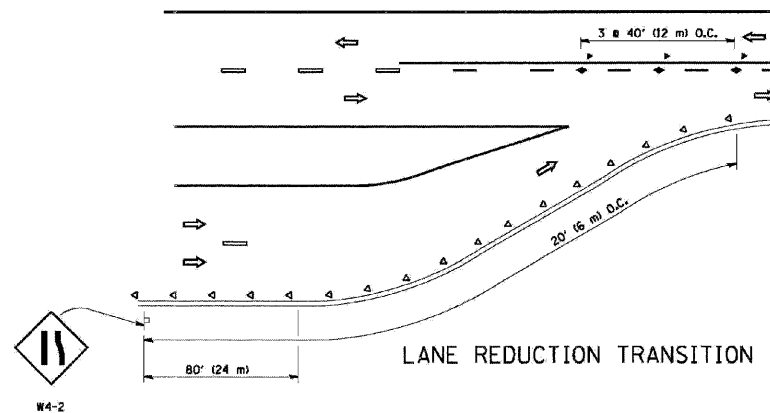

LANE REDUCTION TRANSITION

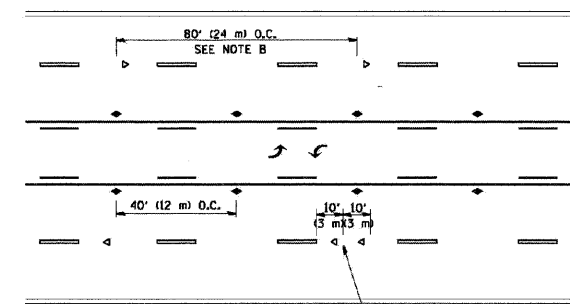

SEE NOTE A

TWO-WAY LEFT TURN

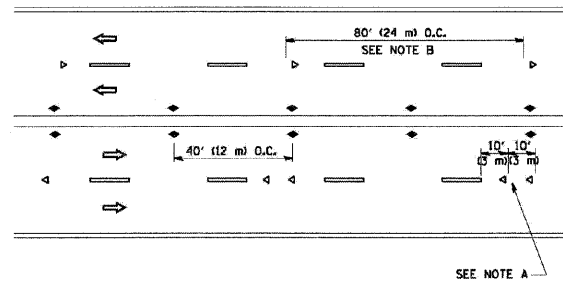

MULTI-LANE/UNDIVIDED

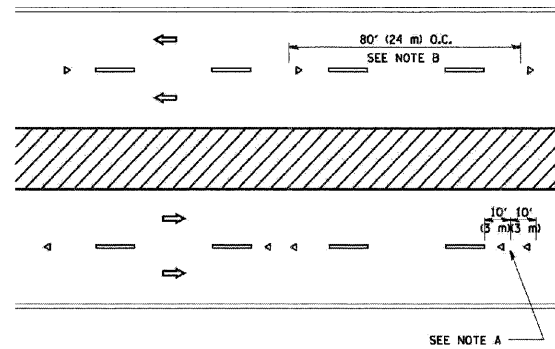

MULTI-LANE/DIVIDED

GENERAL NOTES

1. MARKERS USED WITH DASHED LINES SHALL BE CENTERED IN THE GAP BETWEEN SEGMENTS.
2. MARKERS USED ADJACENT TO SOLID LINES SHALL BE OFFSET 2 TO 3 (50 TO 75) TOWARD TRAFFIC AS SHOWN.
3. MARKERS THROUGH TANGENTS LESS THAN 500' (150 m) IN LENGTH BETWEEN CURVES SHALL BE INSTALLED AT THE LESSER OF THE TWO CURVE SPACINGS.

SYMBOLS

- YELLOW STRIPE
- WHITE STRIPE
- ◁ ONE-WAY AMBER MARKER
- ◁ ONE-WAY CRYSTAL MARKER (W/O)
- ◆ TWO-WAY AMBER MARKER

LANE MARKER NOTES

- A. USE DOUBLE LANE LINE MARKERS SPACED AS SHOWN.
- B. REDUCE TO 40' (12 m) O.C. ON CURVES WHERE ADVISORY SPEEDS ARE 10 M.P.H. (20 km/h) LOWER THAN POSTED SPEEDS.

DESIGN NOTES

1. DOUBLE LANE LINE MARKERS SHALL BE USED UNLESS SPECIFIED OTHERWISE.
2. EXCEPT AS SHOWN ON THE LANE REDUCTION TRANSITION AND FREEWAY EXIT RAMP DETAIL, MARKERS ARE NOT TO BE SPECIFIED ON RIGHT EDGE LINES.
3. THE EXACT MARKER LIMITS, SPACING, AND COLOR SHOULD BE INCLUDED IN THE PLANS.
4. MARKERS SHOULD NOT BE USED ALONGSIDE CURBS EXCEPT FOR EXTREMELY SHORT SECTIONS OF CURBS WHERE NOT MORE THAN TWO MARKERS WOULD BE INVOLVED.

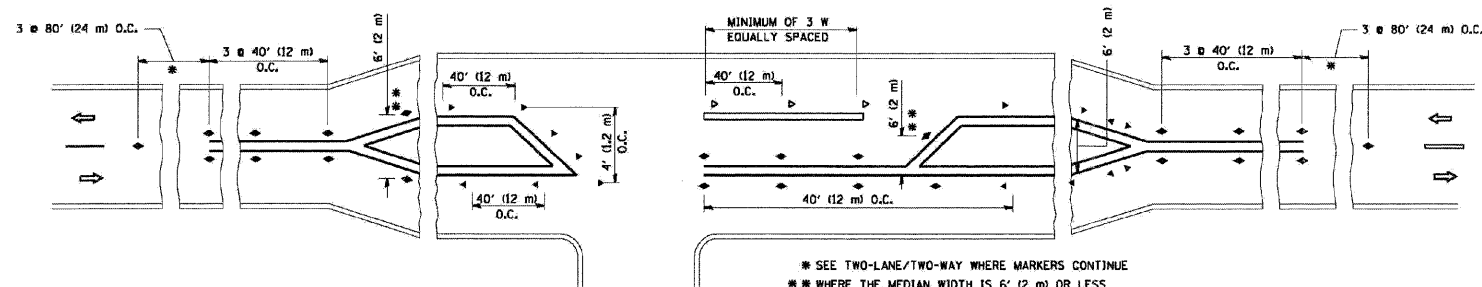

LEFT TURN

All dimensions are in inches (millimeters) unless otherwise shown.

**RAISED REFLECTIVE PAVEMENT MARKERS (SNOW PLOW RESISTANT)**



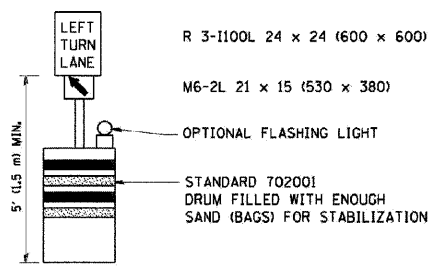
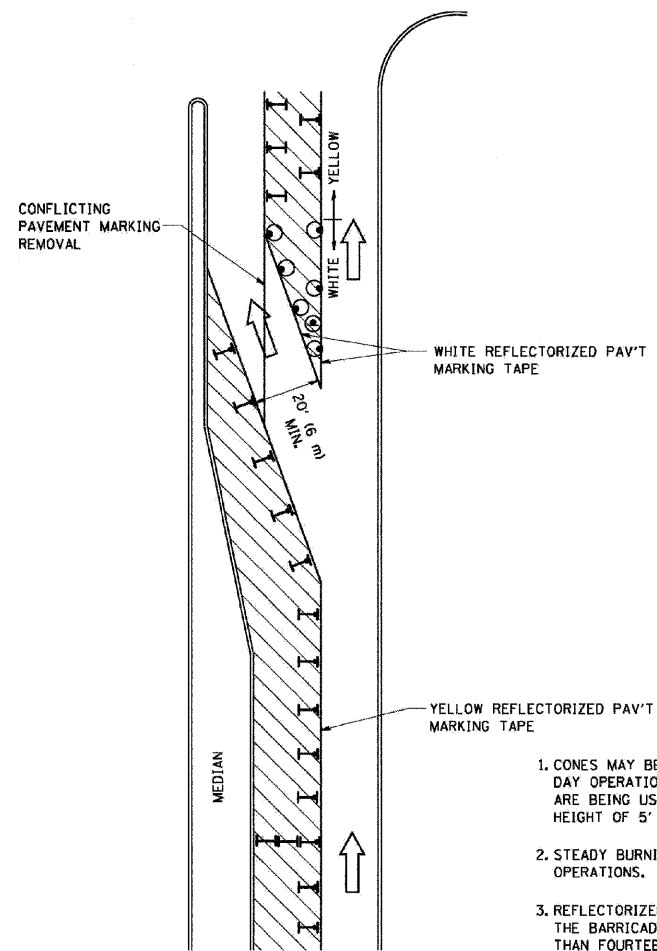



FILE NAME = ...0803\W018\Chicago\Details.dgn	USER NAME = Plotted by Administrator	DESIGNED - ---	REVISED - ---	<b>STATE OF ILLINOIS DEPARTMENT OF TRANSPORTATION</b>	<b>DISTRICT ONE DETAIL SHEETS COLUMBUS DRIVE FROM 87TH STREET TO WESTERN AVENUE</b>		F.A.U. RTE. 3578	SECTION 3178 RS-2	COUNTY COOK	TOTAL SHEETS 27	SHEET NO. 18	
PLOT SCALE = 25.0000' / IN.	CHECKED - ---	REVISED - ---	REVISED - ---		SCALE: NONE	SHEET NO. 9 OF 18 SHEETS	STA. _____ TO STA. _____	FED. ROAD DIST. NO. [ILLINOIS] FED. AID PROJECT				
PLOT DATE = 4/21/2009	DATE = 4/2009	REVISED - ---	REVISED - ---		CONTRACT NO. 60G82							

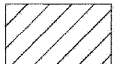

**GENERAL NOTES**

1. CONES MAY BE SUBSTITUTED FOR BARRICADES OR DRUMS AT HALF THE SPACING DURING DAY OPERATIONS. CONES SHALL BE A MINIMUM OF 28 (710) IN HEIGHT. WHEN CONES ARE BEING USED, THE "LEFT TURN LANE" SIGN MAY BE SKID MOUNTED AT A MINIMUM HEIGHT OF 5' (1.5 m).
2. STEADY BURNING LIGHTS WILL NOT BE REQUIRED ON BARRICADES OR DRUMS FOR DAY OPERATIONS. ALL LIGHTS SHALL BE MONODIRECTIONAL.
3. REFLECTORIZED TEMPORARY PAVEMENT MARKING TAPE SHALL BE PLACED THROUGHOUT THE BARRICADED AREA OF EACH TURN BAY WHERE THE CLOSURE TIME IS GREATER THAN FOURTEEN DAYS.
4. THIS APPLICATION ALSO APPLIES WHEN WORK IS BEING PERFORMED IN THE RIGHT LANE(S) AND THE RIGHT TURN BAY IS TO REMAIN OPEN. UNDER THIS CONDITION, "RIGHT TURN LANE" R3-100 24 x 24 (600 x 600) AND M6-2R 21 x 15 (530 x 380) SHALL BE USED.
5. THESE CONTROLS SHALL SUPPLEMENT MAINLINE TRAFFIC CONTROL FOR LANE CLOSURES.
6. LONGITUDINAL DIMENSIONS MAY BE ADJUSTED TO FIT FIELD CONDITIONS.
7. FORM BT 725 IS REQUIRED.
8. TRAFFIC CONTROL AND PROTECTION AT TURN BAYS (TO REMAIN OPEN TO TRAFFIC) SHALL BE INCLUDED IN THE COST SPECIFIED TRAFFIC CONTROL STANDARDS OR ITEMS.

**LEGEND**

-  WORK AREA
-  LANE OPEN TO TRAFFIC
-  TYPE I OR II BARRICADE WITH STEADY BURN LIGHT
-  DRUM WITH STEADY BURN LIGHT
-  DRUM WITH SIGN (WITH OPTIONAL FLASHING LIGHT) SEE DETAIL
-  TYPE I OR II CHECK BARRICADE WITH FLASHING LIGHT

All dimensions are in inches (millimeters) unless otherwise shown.

**TRAFFIC CONTROL AND PROTECTION AT TURN BAYS (TO REMAIN OPEN TO TRAFFIC)**

FILE NAME = ...\\0803\W018\Chicago\Details.dgn	USER NAME = Plotted by Administrator	DESIGNED - ---	REVISED - ---	<b>STATE OF ILLINOIS DEPARTMENT OF TRANSPORTATION</b>	<b>DISTRICT ONE DETAIL SHEETS COLUMBUS DRIVE FROM 87TH STREET TO WESTERN AVENUE</b>			F.A.U. RTE. 3578	SECTION 3178 RS-2	COUNTY COOK	TOTAL SHEETS 27	SHEET NO. 19
	PLOT SCALE = 25.0000' / IN.	CHECKED - ---	REVISED - ---					CONTRACT NO. 60G82				
	PLOT DATE = 4/21/2009	DATE = 4/2009	REVISED - ---		SCALE: NONE	SHEET NO. 10 OF 18 SHEETS	STA. _____ TO STA. _____	FED. ROAD DIST. NO. _____ [ILLINOIS] FED. AID PROJECT				



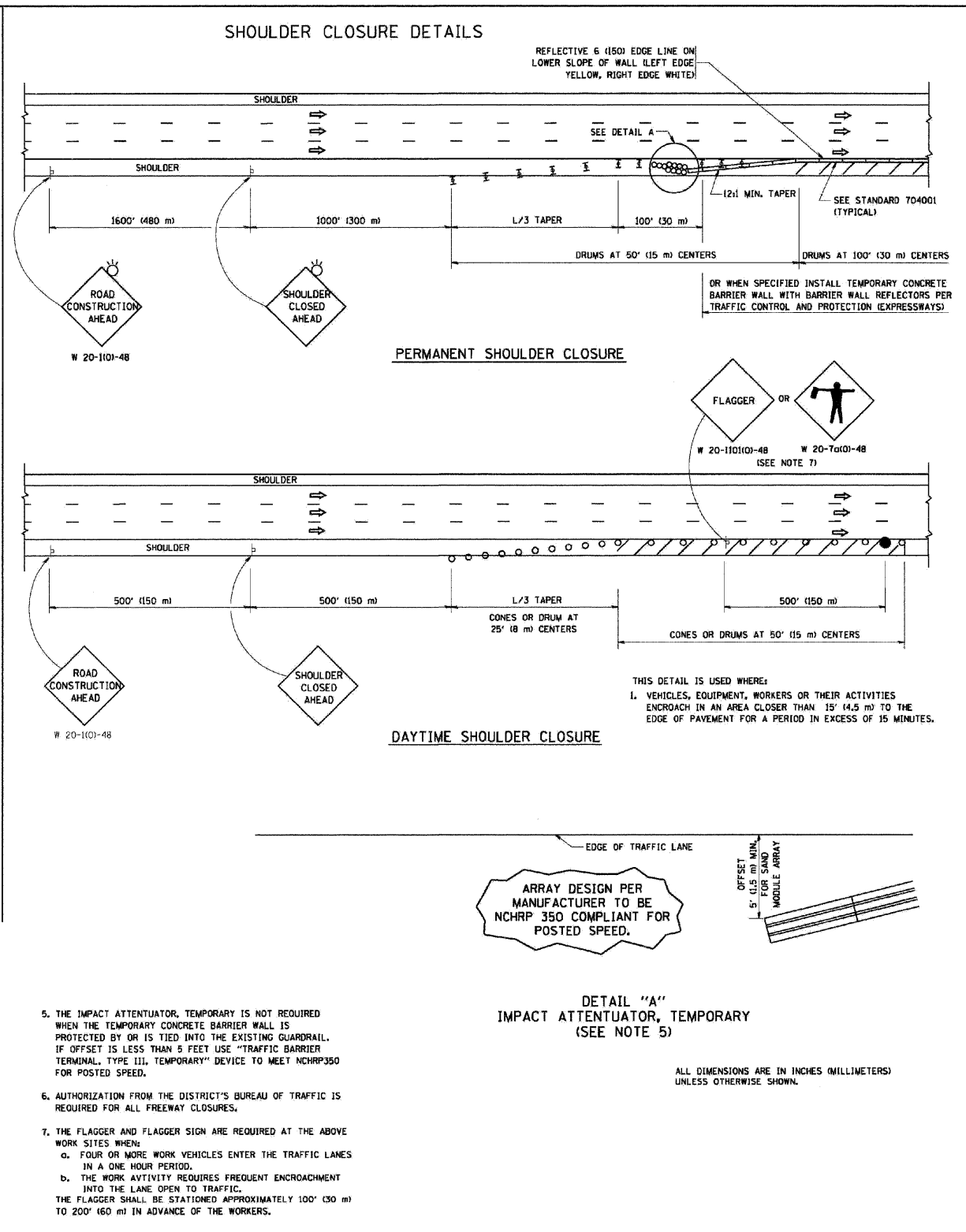
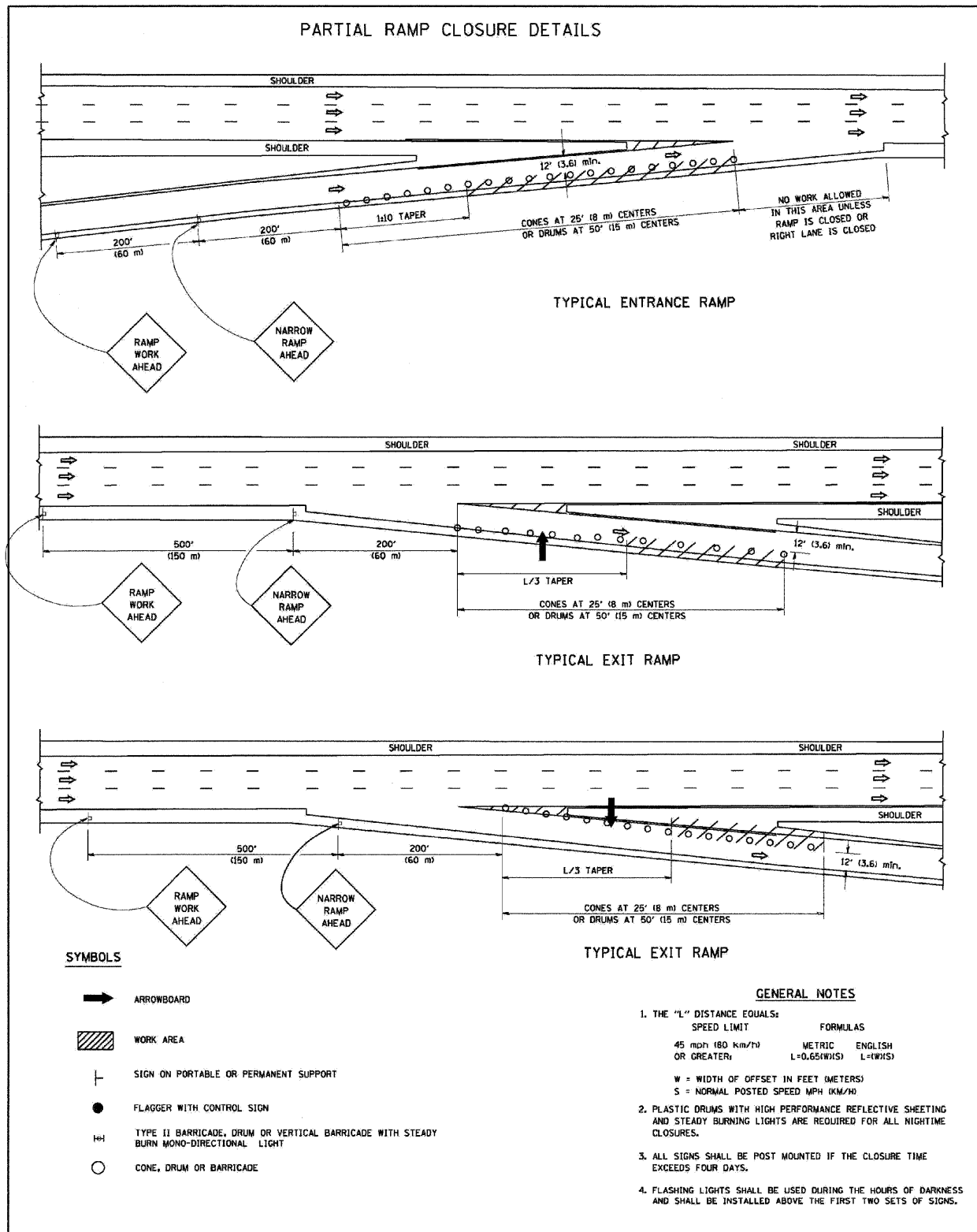

## TRAFFIC CONTROL FOR SHOULDER CLOSURES AND PARTIAL RAMP CLOSURES

FILE NAME = ...\\0803\W018\Chicago\Details.dgn	USER NAME = Plotted by Administrator	DESIGNED - ---	REVISED - ---	<b>STATE OF ILLINOIS DEPARTMENT OF TRANSPORTATION</b>	<b>DISTRICT ONE DETAIL SHEETS COLUMBUS DRIVE FROM 87TH STREET TO WESTERN AVENUE</b>			F.A.U. RTE. 3578	SECTION 3178 RS-2	COUNTY COOK	TOTAL SHEETS 27	SHEET NO. 21
PLOT SCALE = 25.0000' / IN.					CONTRACT NO. 60G82							
PLOT DATE = 4/21/2009					SCALE: NONE    SHEET NO. 12 OF 18 SHEETS    STA. _____ TO STA. _____							
DATE = 4/2009					FED. ROAD DIST. NO. _____ ILLINOIS FED. AID PROJECT							

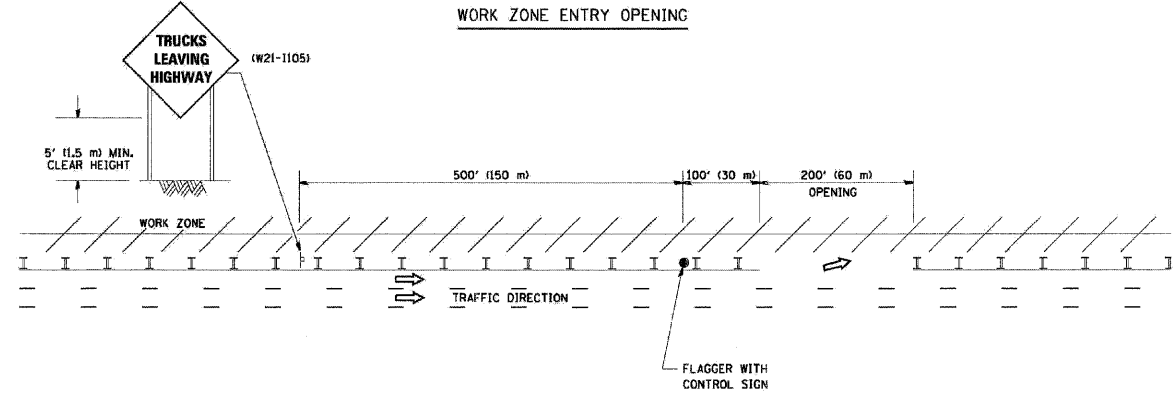
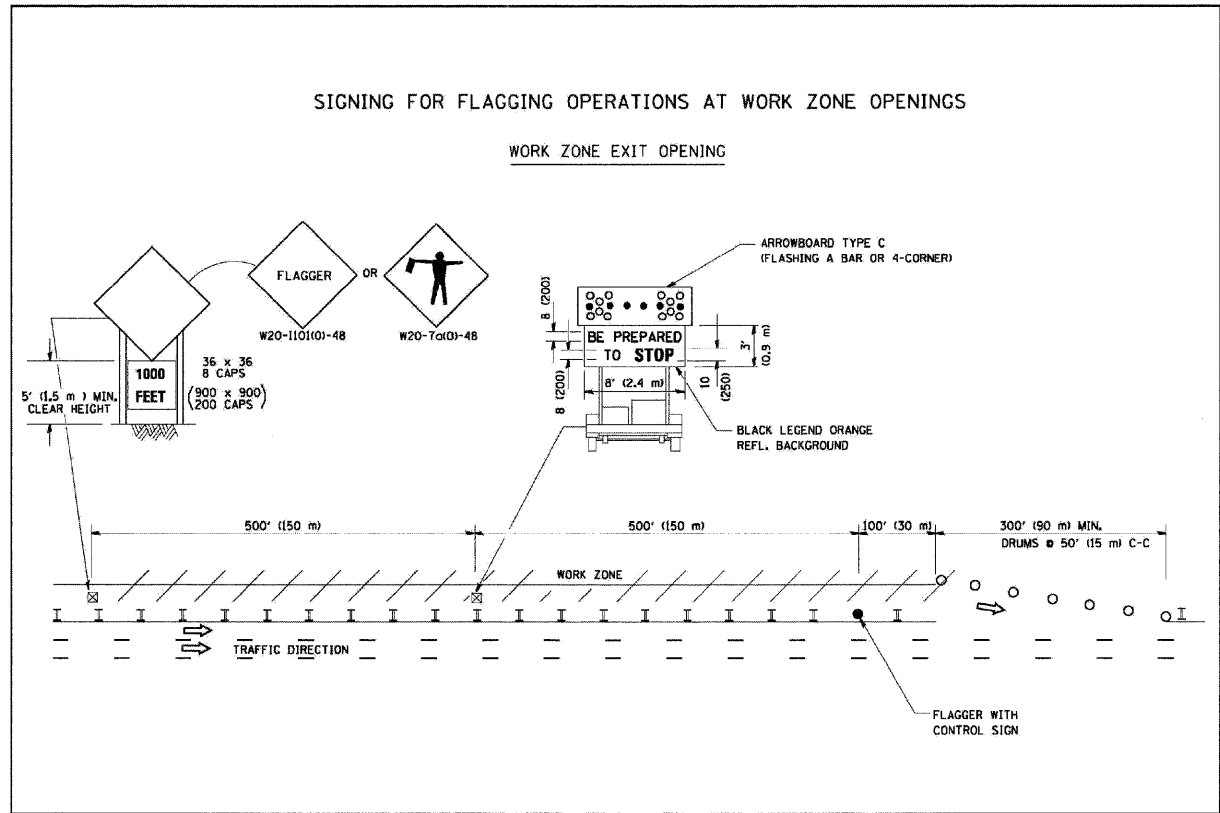

- NOTES:**
1. The Arrowboard, the Flagger Ahead trailer mounted sign, and the Trucks Leaving Highway sign shall be removed or turned away from traffic and the exit and entry openings shall be closed when the flagging operation ceases.
  2. Work Zone Exit Openings should be a minimum of one half mile apart.
  3. Exiting the work zone at any place other than at a Work Zone Exit Opening will be prohibited.
  4. All vehicles shall enter the work zone at entry openings, using their turn signals to warn motorists

ALL DIMENSIONS ARE IN INCHES (MILLIMETERS) UNLESS OTHERWISE SHOWN

**SIGNING FOR FLAGGING OPERATIONS AT WORK ZONE OPENINGS**

FILE NAME = ...2803\W018\Chicago\Details.dgn	USER NAME = Plotted by Administrator	DESIGNED - ---	REVISED - ---	<b>STATE OF ILLINOIS DEPARTMENT OF TRANSPORTATION</b>	<b>DISTRICT ONE DETAIL SHEETS COLUMBUS DRIVE FROM 87TH STREET TO WESTERN AVENUE</b>	F.A.U. RTE. 3578	SECTION 3178 RS-2	COUNTY COOK	TOTAL SHEETS 27	SHEET NO. 22
PLOT SCALE = 25.0000' / IN.		CHECKED - ---	REVISED - ---	SCALE: NONE    SHEET NO. 13 OF 18 SHEETS    STA. _____ TO STA. _____		CONTRACT NO. 60G82				
PLOT DATE = 4/21/2009		DATE = 4/2009	REVISED - ---	FED. ROAD DIST. NO. - [ILLINOIS] FED. AID PROJECT						

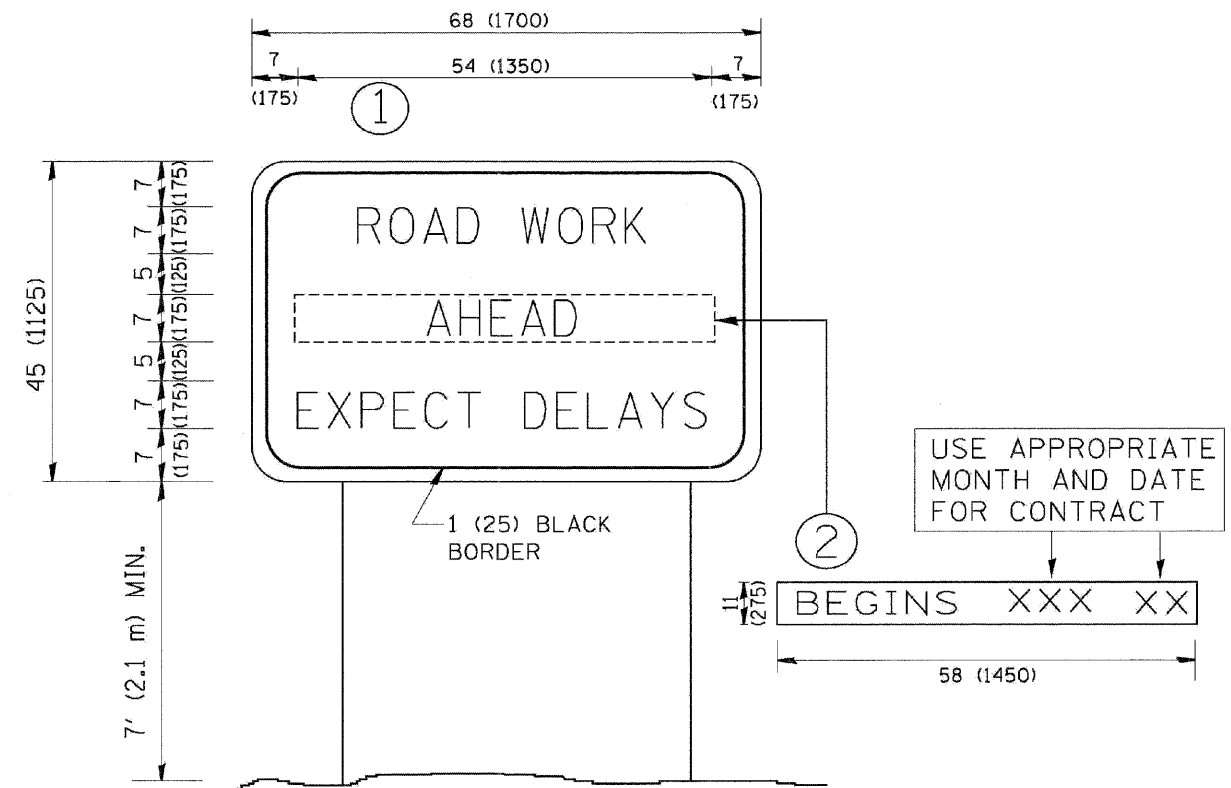

**NOTES:**

1. USE BLACK LETTERING ON ORANGE BACKGROUND.
2. ERECT SIGNS IN ADVANCE OF THE LOCATION FOR THE "ROAD CONSTRUCTION AHEAD" SIGN AT LOCATIONS AS DIRECTED BY THE ENGINEER.
3. ERECT SIGN ① WITH INSTALLED PANEL ② ONE WEEK PRIOR TO THE START OF CONSTRUCTION.
4. REMOVE PANEL ② SOON AFTER THE START OF CONSTRUCTION.
5. SEE SPECIAL PROVISION FOR "TEMPORARY INFORMATION SIGNING" FOR ADDITIONAL INFORMATION.
6. ONE SIGN ASSEMBLY EQUALS 25.70 SQ. FT. (2.3 SQ. M.)
7. SHALL BE PAID FOR AS TEMPORARY INFORMATION SIGNING.

ALL DIMENSIONS ARE IN INCHES (MILLIMETERS) UNLESS OTHERWISE SHOWN.

**ARTERIAL ROAD SIGN INFORMATION**

FILE NAME = ...\\0803\W019\Chicago\Details.dgn	USER NAME = Plotted by Administrator	DESIGNED - ---	REVISED - ---	<b>STATE OF ILLINOIS DEPARTMENT OF TRANSPORTATION</b>	<b>DISTRICT ONE DETAIL SHEETS COLUMBUS DRIVE FROM 87TH STREET TO WESTERN AVENUE</b>			F.A.U. RTE. 3578	SECTION 3178 RS-2	COUNTY COOK	TOTAL SHEETS 27	SHEET NO. 23
	PLOT SCALE = 25.0000 ' / IN.	CHECKED - ---	REVISED - ---		SCALE: NONE	SHEET NO. 14 OF 18 SHEETS	STA. _____ TO STA. _____	FED. ROAD DIST. NO. _ ILLINOIS FED. AID PROJECT				
	PLOT DATE = 4/21/2009	DATE = 4/2009	REVISED - ---		CONTRACT NO. 60G82							

WITH INTERSECTION TRAFFIC SIGNALS

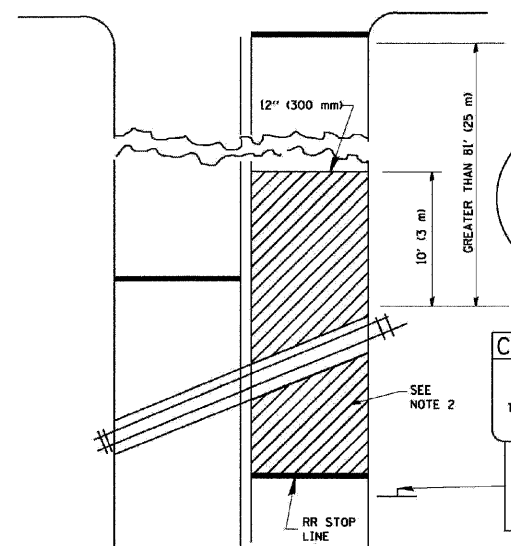

WITH NEAR-SIDE TRAFFIC SIGNALS

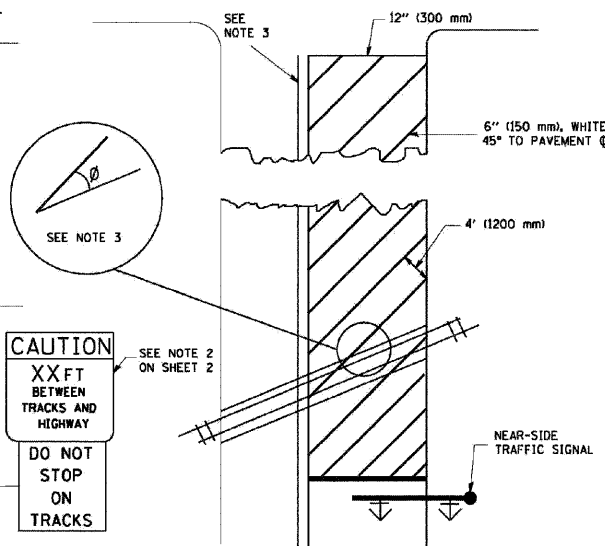

WITH NONSIGNALIZED INTERSECTION  
81' (25 m) OR LESS TO CLOSEST RAIL

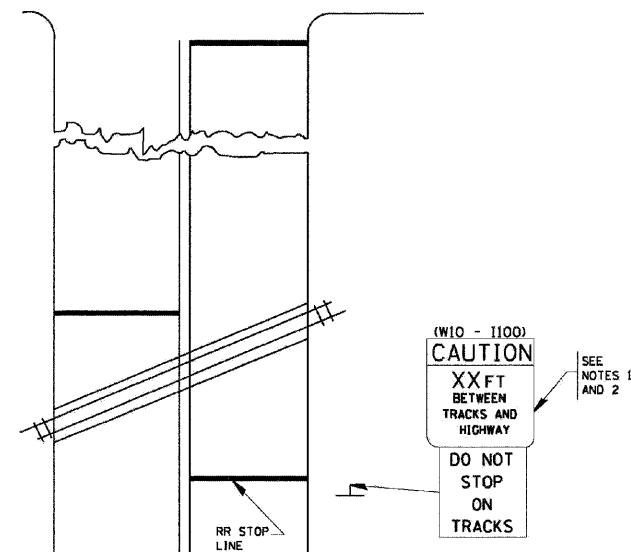

- NOTES:
1. PAVEMENT MARKINGS TO BE INSTALLED ONLY ON APPROACHES TO INTERSECTIONS CONTROLLED BY TRAFFIC SIGNALS WHICH ARE INTERCONNECTED WITH THE RAILROAD WARNING SIGNALS.
  2. WHERE NEAR-SIDE TRAFFIC SIGNALS ARE USED, THE PAVEMENT MARKINGS EXTENDS TO THE INTERSECTION.
  3. WHERE THE ANGLE BETWEEN THE DIAGONAL STRIPES AND THE TRACK (Ø) WOULD BE LESS THAN APPROXIMATELY 20°, THE STRIPES SHOULD BE SLOPED IN THE OPPOSITE DIRECTION FROM THAT SHOWN.

- NOTE :
1. DISTANCE TO BE SHOWN ON SIGN MEASURED FROM A POINT 6 FEET (1.8 m) FROM THE RAIL CLOSEST TO THE INTERSECTION TO THE STOP LINE OR CROSSWALK, WHICHEVER IS CLOSEST, ROUNDED DOWN TO THE NEAREST 5 FEET (1.5 m). WHERE THERE IS NO STOP LINE, MEASURE TO POINT WHERE THE DRIVER HAS A VIEW OF APPROACHING TRAFFIC.
  2. THE CLEARANCE SIGN IS ALSO TO BE USED AS AN INTERIM MEASURE AT LOCATIONS WITH INTERCONNECTED INTERSECTION TRAFFIC SIGNALS WHERE IT IS PLANNED TO CHANGE THEM TO NEAR-SIDE SIGNALS AT A FUTURE TIME. IN THIS CASE, THE DISTANCE TO BE SHOWN ON THE SIGN IS MEASURED FROM THE EDGE OF THE STRIPED-OUT AREA INSTEAD OF 6- FEET FROM THE RAIL. THE SIGN IS TO BE REMOVED WHEN THE NEAR-SIDE SIGNALS ARE INSTALLED AND THE PAVEMENT MARKINGS EXTEND TO THE INTERSECTION.

ALL DIMENSIONS ARE IN INCHES (MILLIMETERS) UNLESS OTHERWISE SHOWN.

**SIGNING AND PAVEMENT MARKINGS TREATMENT FOR RAILROAD CROSSINGS**

FILE NAME = ...0803\w018\Chicago\Details.dgn	USER NAME = Plotted by Administrator	DESIGNED - ---	REVISED - ---	<b>STATE OF ILLINOIS DEPARTMENT OF TRANSPORTATION</b>	<b>DISTRICT ONE DETAIL SHEETS COLUMBUS DRIVE FROM 87TH STREET TO WESTERN AVENUE</b>			F.A.U. RTE. 3578	SECTION 3178 RS-2	COUNTY COOK	TOTAL SHEETS 27	SHEET NO. 24
PLOT SCALE = 25.0000' / IN.	CHECKED - ---	REVISED - ---	REVISED - ---		SCALE: NONE	SHEET NO. 15 OF 18 SHEETS	STA. _____ TO STA. _____	CONTRACT NO. 60G82				
PLOT DATE = 4/21/2009	DATE - 4/2009	REVISED - ---	REVISED - ---		FED. ROAD DIST. NO. _____ ILLINOIS FED. AID PROJECT							



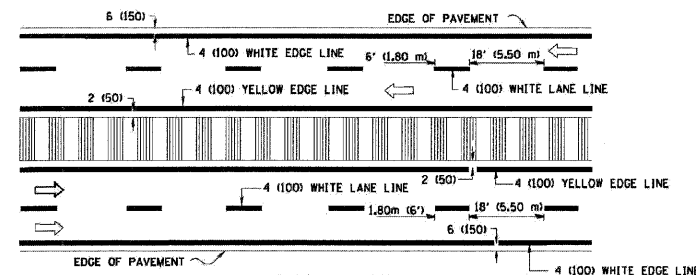
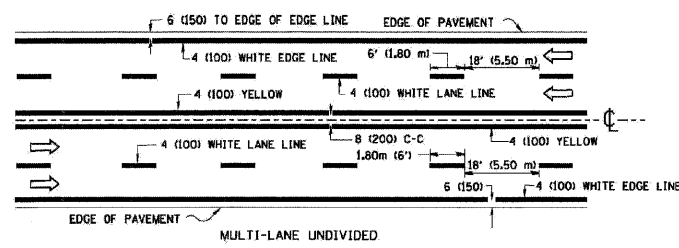
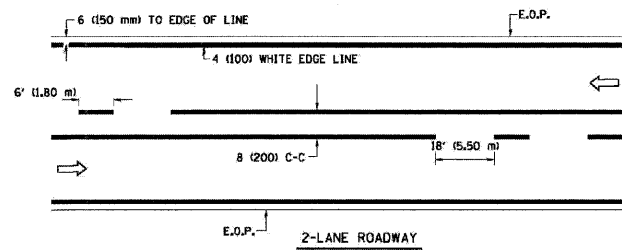

NOTE: MEDIANS WITH BARRIER CURB DO NOT REQUIRE AN EDGE LINE

TYPICAL LANE AND EDGE LINE MARKING

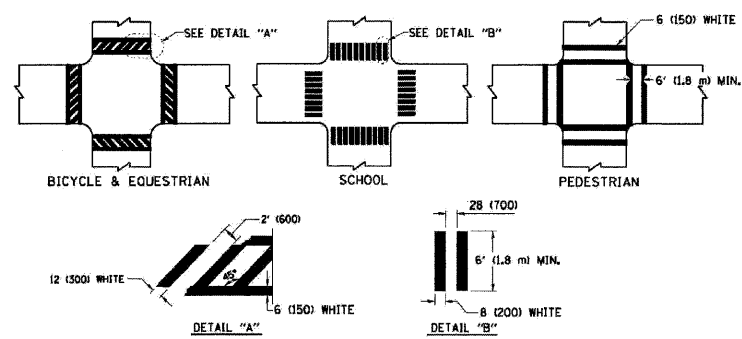

TYPICAL CROSSWALK MARKING

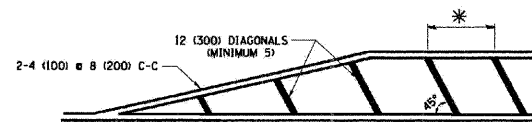

\* FOR MEDIAN LENGTHS WHERE DIAGONAL SPACING CANNOT BE ATTAINED, USE 5 (FIVE) EQUALLY SPACED DIAGONAL LINES.  
\* DIAGONAL LINE SPACING: 20' (6.1 m) C-C

PAINTED MEDIANS

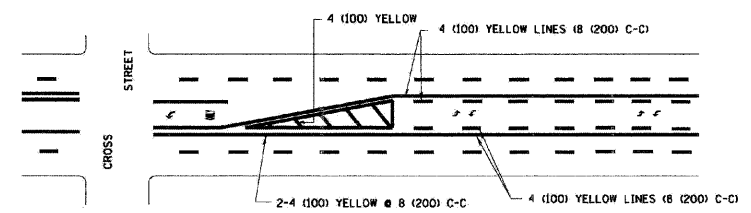

A MINIMUM OF TWO PAIRS OF TURN ARROWS SHALL BE USED, WHITE IN COLOR. ADDITIONAL PAIRS SHALL BE PLACED AT 200' (60 m) TO 300' (90 m) INTERVALS.

TYPICAL PAINTED MEDIAN MARKING

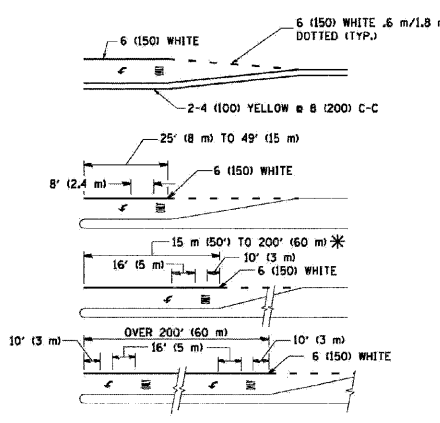

FULL SIZE LETTERS 8' (2.4 m) AND ARROWS SHALL BE USED. AREA = 15.8 SQ. FT. (1.47 m<sup>2</sup>) AREA = 22.9 SQ. FT. (2.13 m<sup>2</sup>)  
\* TURN LANES IN EXCESS OF 400' (120 m) IN LENGTH MAY HAVE AN ADDITIONAL SET OF ARROW - "ONLY" INSTALLED MIDWAY BETWEEN THE OTHER TWO SETS OF ARROW - "ONLY".

TYPICAL LEFT (OR RIGHT) TURN LANE

TYPICAL TURN LANE MARKING

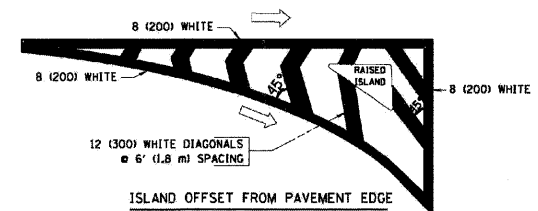

ISLAND OFFSET FROM PAVEMENT EDGE

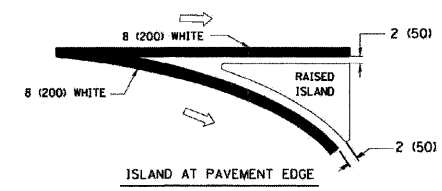

ISLAND AT PAVEMENT EDGE

TYPICAL ISLAND MARKING

TYPE OF MARKING	WIDTH OF LINE	PATTERN	COLOR	SPACING / REMARKS
CENTERLINE ON 2 LANE PAVEMENT	4 (100)	SKIP-DASH	YELLOW	6' (1.80 m) LINE WITH 18' (5.50 m) SPACE
CENTERLINE ON MULTI-LANE UNDIVIDED PAVEMENT	2 @ 4 (100)	SOLID	YELLOW	8 (200) C-C
NO PASSING ZONE LINES FOR ONE DIRECTION FOR BOTH DIRECTIONS	4 (100) 2 @ 4 (100)	SOLID SOLID	YELLOW YELLOW	8 (200) C-C
LANE LINES	4 (100) 8 (125) ON FREEWAYS	SKIP-DASH SKIP-DASH	WHITE WHITE	6' (1.80 m) LINE WITH 18' (5.50 m) SPACE
DOTTED LINES (EXTENSIONS OF CENTER, LANE OR TURN LANE MARKINGS)	SAME AS LINE BEING EXTENDED	SKIP-DASH	SAME AS LINE BEING EXTENDED	2' (600) LINE WITH 6' (1.8) SPACE
EDGE LINES	4 (100)	SOLID	YELLOW-LEFT WHITE-RIGHT	OUTLINE MOUNTABLE MEDIANS IN YELLOW; EDGE LINES ARE NOT USED NEXT TO BARRIER CURB
TURN LANE MARKINGS	6 (150) LINE; FULL SIZE LETTERS & SYMBOLS (8' (2.4 m))	SOLID	WHITE	SEE TYPICAL TURN LANE MARKING DETAIL
TWO WAY LEFT TURN MARKING	2 @ 4 (100) EACH DIRECTION 8' (2.4 m) LEFT ARROW	SKIP-DASH AND SOLID IN PAIRS	YELLOW WHITE	6' (1.8 m) LINE WITH 18' (5.50 m) SPACE FOR SKIP-DASH; 8 (200) C-C BETWEEN SOLID LINE AND SKIP-DASH LINE SEE TYPICAL TWO-WAY LEFT TURN MARKING DETAIL
CROSSWALK LINES (PEDESTRIAN) A. DIAGONALS (BIKE & EQUESTRIAN) B. LONGITUDINAL BARS (SCHOOL)	2 @ 6 (150) 12 (300) @ 45° 8 (200) @ 90°	SOLID SOLID SOLID	WHITE WHITE WHITE	NOT LESS THAN 6' (1.8 m) APART 2'-4" (600) APART SEE TYPICAL CROSSWALK MARKING DETAILS.
STOP LINES	24 (600)	SOLID	WHITE	PLACE 4' (1.2 m) IN ADVANCE OF AND PARALLEL TO CROSSWALK, IF PRESENT. OTHERWISE, PLACE AT DESIRED STOPPING POINT. PARALLEL TO CROSSROAD CENTERLINE, WHERE POSSIBLE
PAINTED MEDIANS	2 @ 4 (100) WITH 12 (300) DIAGONALS @ 45°	SOLID	YELLOW; TWO WAY TRAFFIC WHITE; ONE WAY TRAFFIC	8 (200) C-C FOR THE DOUBLE LINE SEE TYPICAL PAINTED MEDIAN MARKING.
GORE MARKING AND CHANNELIZING LINES	8 (200) WITH 12 (300) DIAGONALS @ 45°	SOLID	WHITE	DIAGONALS; 20' (6.1 m) (LESS THAN 30 MPH (50 km/hr))
RAILROAD CROSSING	24 (600) TRANSVERSE LINES; "RR" 15' @ (1.8 m) LETTERS; 16 (400) LINE FOR "X"	SOLID	WHITE	SEE STATE STANDARD 780001 AREA OF: "R"=3.6 SQ. FT. (0.33m <sup>2</sup> ) EACH "X"=54.0 SQ. FT. (5.0 m <sup>2</sup> )

FOR FURTHER DETAILS ON PAVEMENT MARKING REFER TO STREET MARKING STANDARDS, PRINTED BY CITY OF CHICAGO, DEPARTMENT OF TRANSPORTATION, BUREAU OF TRAFFIC.

ALL DIMENSIONS ARE IN INCHES (MILLIMETERS) UNLESS OTHERWISE SHOWN.

CITY OF CHICAGO  
TYPICAL PAVEMENT MARKINGS



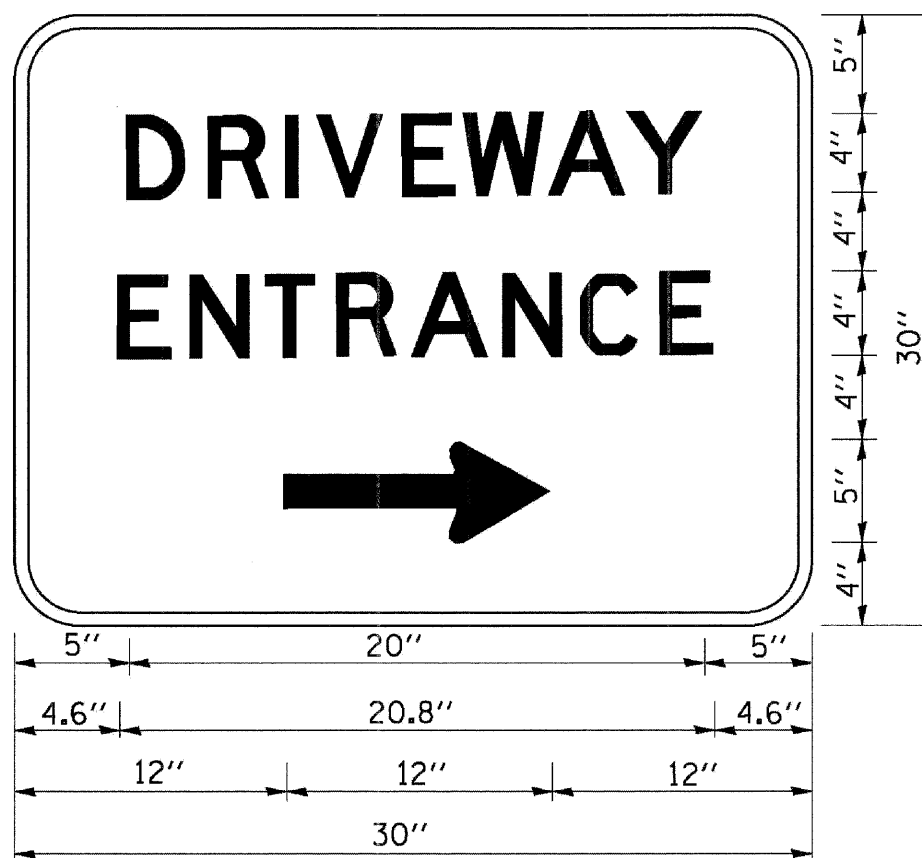

3.0" RADIUS, 0.5" BORDER, WHITE ON GREEN; REFLECTORIZED  
 "DRIVEWAY" D; "ENTRANCE" D; STANDARD ARROW CUSTOM 12.0" x 5.0"

**NOTES:**

1. HALF OF THE SIGNS WILL REQUIRE A LEFT HAND FACING ARROW.
2. TWO SIGNS SHALL BE USED AT EACH COMMERCIAL ENTRANCE PLACED BACK-TO-BACK: ONE WITH A RIGHT HAND ARROW (SHOWN) SHALL BE PLACED ON THE NEAR RIGHT SIDE THE DRIVEWAY AND ONE WITH A LEFT HAND ARROW SHALL BE PLACED ON THE FAR LEFT SIDE OF THE DRIVEWAY.
3. SIGNS TO BE PAID FOR AS ITEM "TEMPORARY INFORMATION SIGNING".

**DRIVEWAY ENTRANCE SIGNING**

FILE NAME = ...\\2803\W018\Chicago\Details\dgn	USER NAME = Plotted by Administrator	DESIGNED - ---	REVISED - -----	<b>STATE OF ILLINOIS DEPARTMENT OF TRANSPORTATION</b>	<b>DISTRICT ONE DETAIL SHEETS COLUMBUS DRIVE FROM 87TH STREET TO WESTERN AVENUE</b>			F.A.U. RTE. 3578	SECTION 3178 RS-2	COUNTY COOK	TOTAL SHEETS 27	SHEET NO. 27
	PLOT SCALE = 25.0000 ' / IN.	CHECKED - ---	REVISED - -----		SCALE: NONE	SHEET NO. 18 OF 18 SHEETS	STA. _____ TO STA. _____	FED. ROAD DIST. NO. _ [ILLINOIS] FED. AID PROJECT				
	PLOT DATE = 4/21/2009	DATE - 4/2009	REVISED - -----		CONTRACT NO. 60G82							